

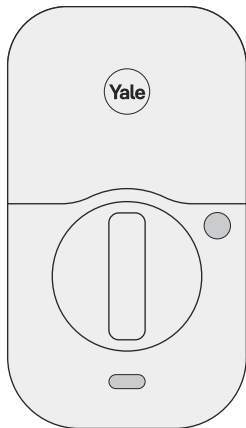

# Yale Pro<sup>®</sup> 2

## Keyed YRD614 / YRD624



### Install Your Lock

Follow the step-by-step Installation Guide in this manual (pages 8-19), or refer to the app for installation instructions with helpful videos.

Note: If you use the app, please tear off the Door Checker and the Marking Template (pages 4-7) to use when prompted.

### Set Up, Program, and Use Your Lock

Follow the instructions in this manual (page 21) or in the Quick Start Guide to set up and program your lock. Create permanent entry codes, issue entry codes for guests, operate your lock with your phone, and more (pages 20-27).



# Contents

<b>In the Box</b>	<b>4</b>	<b>Using Your Lock</b>	<b>20</b>
<b>Door Checker</b>	<b>4</b>	Configuring Your Lock	21
<b>Marking Templates</b>	<b>6</b>	LED Alerts	22
<b>Installation Guide</b>	<b>8</b>	Resetting Your Lock to Factory Defaults	23
Remove Existing Deadbolt	9	Features	24
Check Door Measurements	10	Lock Operations Troubleshooting	25
Make or Adjust Holes	11	Hardware Troubleshooting	27
Install Deadbolt Latch	12		
Install Exterior Keypad	13		
Install Mounting Plate	14		
Attach Wire Cable to Interior Lock	15		
Install Interior Lock	16		
Test Thumbturn and Key	17		
Install Yale Smart Module	18		
Install Batteries and Replace Cover	19		

# In the Box

## Lock

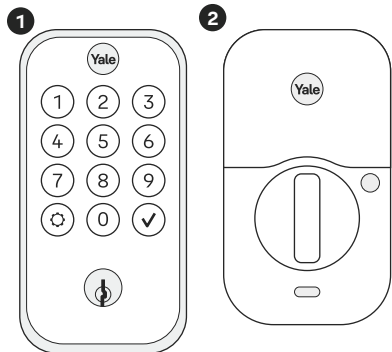

## Add-Ons

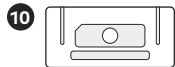

## Hardware

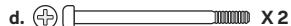
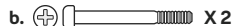
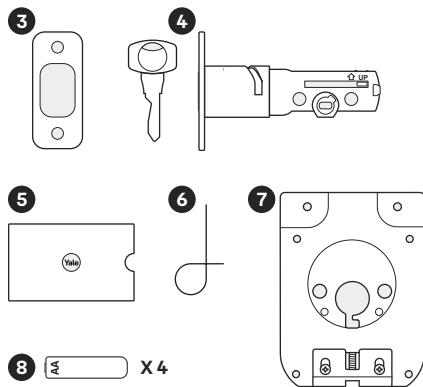

P/N YRD604-KD-ZW-0045 Rev A

1. Exterior Keypad
2. Interior Lock
3. Strike Plate
4. Adjustable Deadbolt & Key
5. Manual
6. Reset Pin
7. Mounting Plate
8. AA Batteries
9. Screws
  - a. Strike Plate and Deadbolt Screws
  - b. Teal Screw Set B
  - c. Black Screw Set C
  - d. Silver Screw Set D
  - e. Optional Security Strike Plate Screws
10. Smart Module

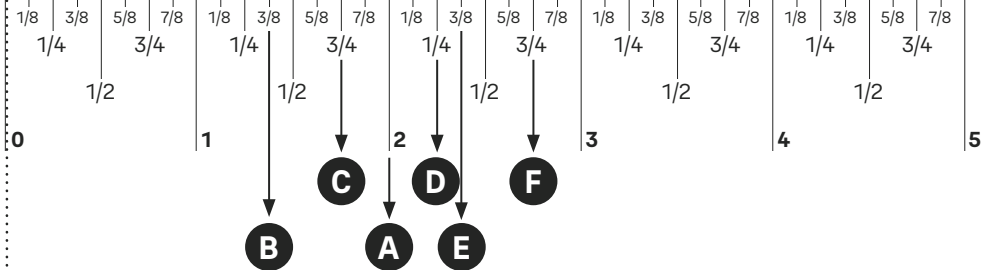

## Door Checker Part 1

See Reverse for Part 2 →

### Measure Clearance

- ✓ Greater than A
- ✗ Less than A  
(Your door is not a match)

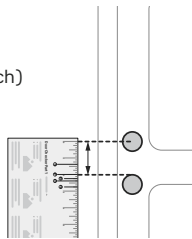

**A.** 2" minimum clearance between top of the door knob and center of deadbolt hole.

### Measure Door Thickness

- ✓ B, C or D
- ✗ Less than B or greater than D  
(Your door is not a match)

**B.** 1-3/8" door thickness; use **teal** (shortest) **screws**.

**C.** 1-3/8" - 1-3/4" door thickness; use black (medium) **screws**.

**D.** 1-3/4" - 2-1/4" door thickness; use **silver** (longest) **screws**.

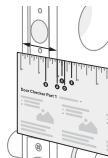

### Measure Backset

- ✓ Equals E or F
- ✗ Doesn't equal E or F  
(Your door is not a match)

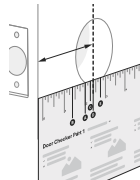

**E.** 2-3/8" backset, use out of box latch setting.

**F.** 2-3/4" backset, adjust latch setting (Step 2, point 1 of this manual).

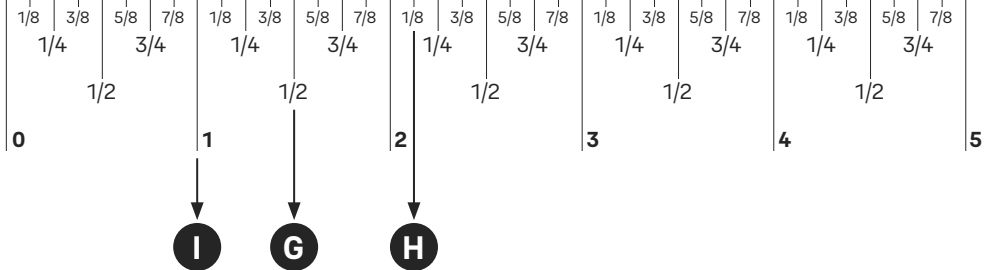

## Door Checker Part 2

See Reverse for Part 1 →

### Measure Face Bore

- ✓ Equals G or H
- ✎ Less than G  
(Adjust diameter to G or H)
- ✗ Greater than H  
(Your door is not a match)

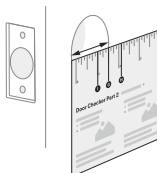

### Measure Edge Bore and Strike Pocket

- ✓ Equals I
- ✎ Less than I  
(Adjust diameter to I)
- ✗ Greater than I  
(Your door is not a match)

#### Door (Edge Bore)

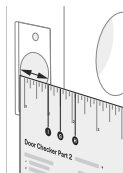

#### Frame (Strike Pocket)

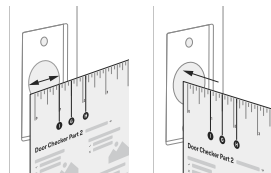

Diameter

Depth

- G.** 1-1/2" face bore diameter.
- H.** 2-1/8" face bore diameter.

- I.** 1" edge bore diameter;  
1" strike pocket diameter and depth.



Minimum strike pocket depth is 1".

Tear Along the Dotted Line

# Marking Template for 2-1/8" (54mm) Face Bore

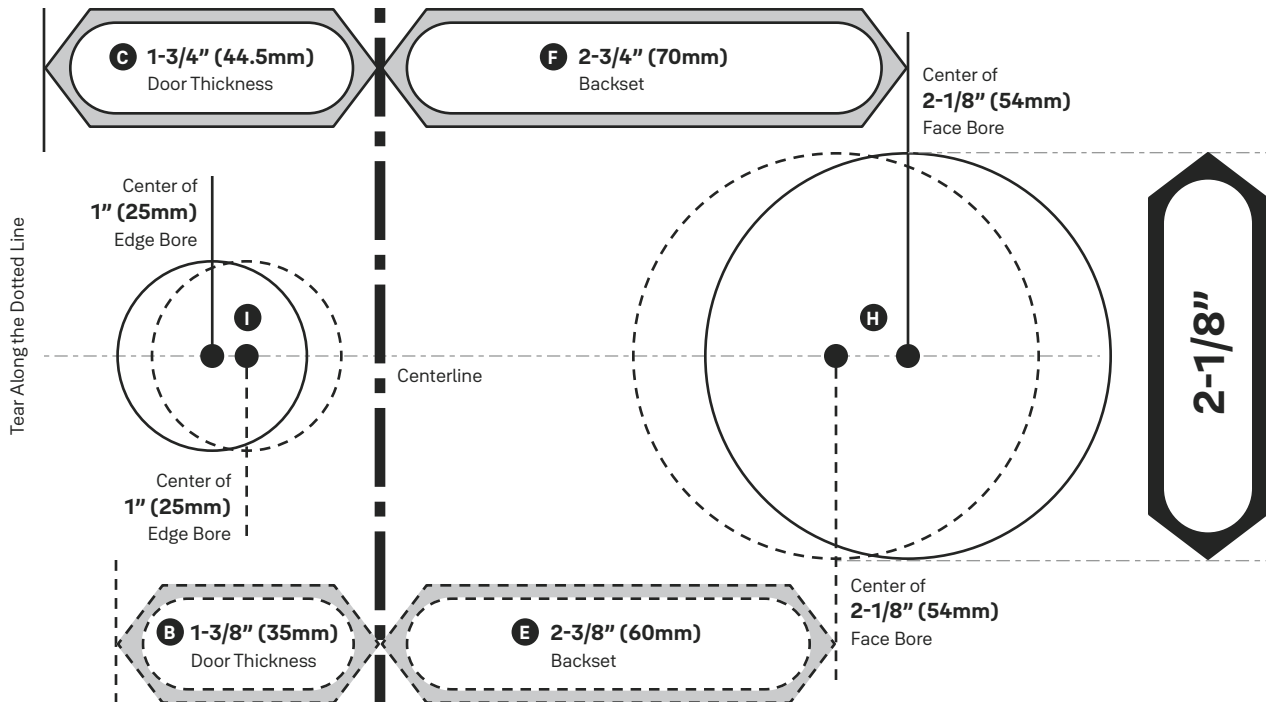

# Marking Template for 1-1/2" (38mm) Face Bore

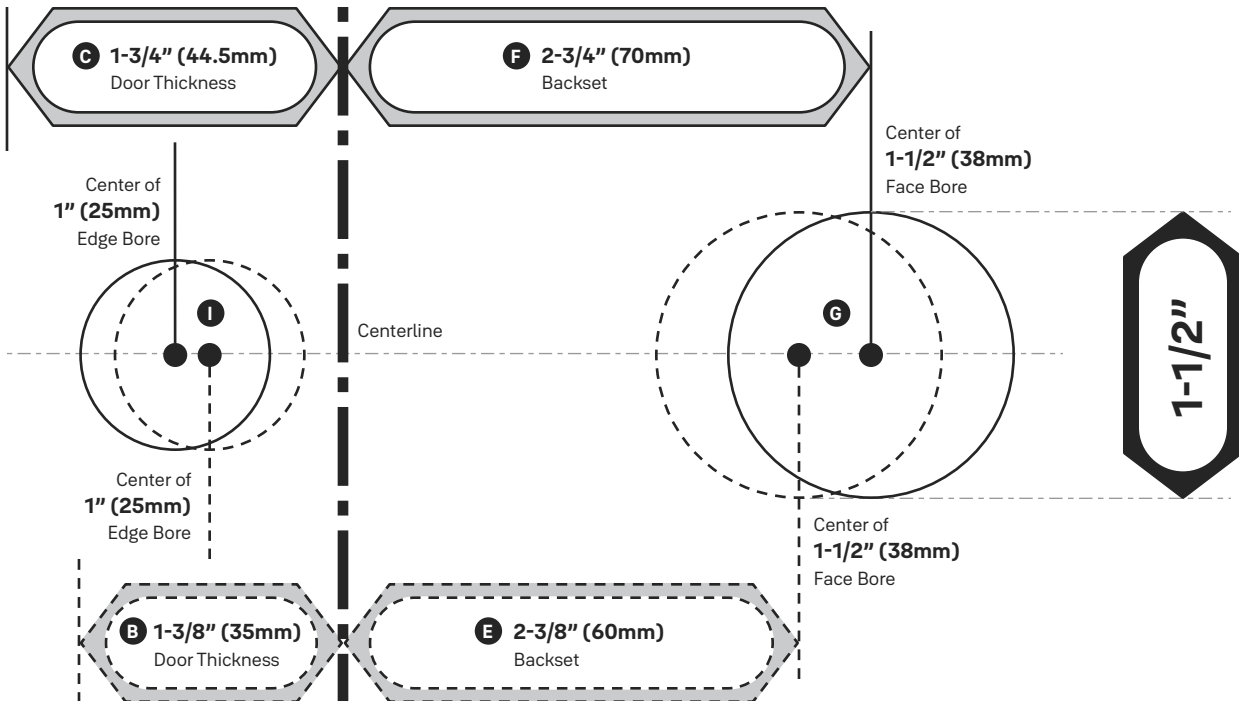



# Installation Guide

## Required Tools

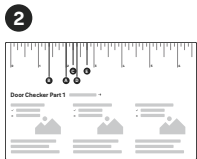
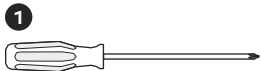

## You Might Also Need

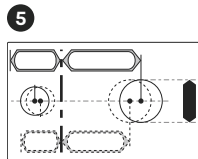
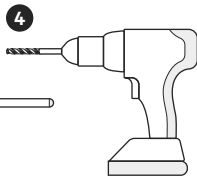
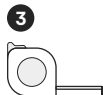

1. **Phillips Head Screwdriver**
2. **Door Checker**  
(tear off pages 5-6 of this manual)
3. **Tape Measure**
4. **Drill**
5. **Marking Template**  
(tear off pages 7-8 of this manual)
6. **Pencil**
7. **Wood Mortise Chisel**
8. **Utility Knife**
9. **Level**



Failure to follow the Installation Guide precisely could result in damage to the product, voiding the factory warranty, and could lead to failure of the product to provide access.

# 1a Remove Existing Deadbolt

If you have a new door, please proceed to step 1b. →

If you have a deadbolt on your door, use the diagram to help you remove it.

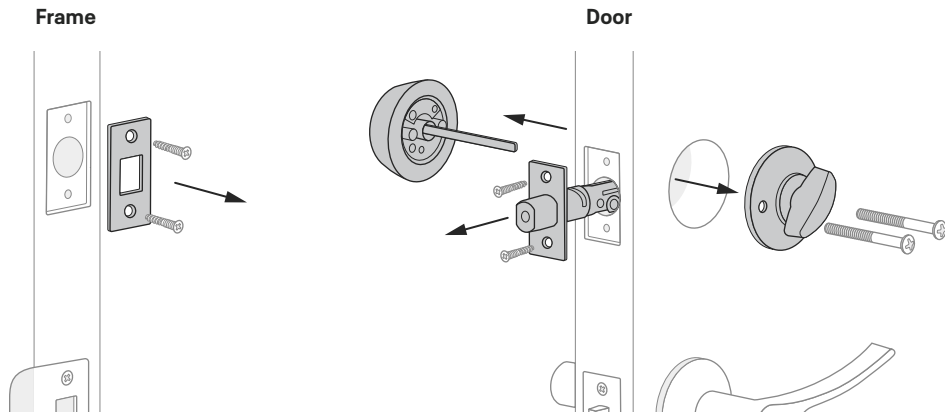

Keep your old deadbolt until your new lock has been successfully installed.

# 1b Check Door Measurements

If your door doesn't have holes, please proceed to step 1c. →

Tear off the **Door Checker** (pages 5-6) and follow the guidelines on **both sides** to measure each aspect of your door and frame. There are some cases when existing holes cannot be adjusted to be compatible.

✎ If you need to make adjustments, go to **step 1c** and find the closest match to each aspect of your door on the **Marking Template**.

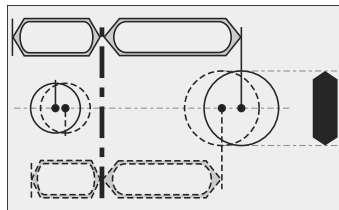
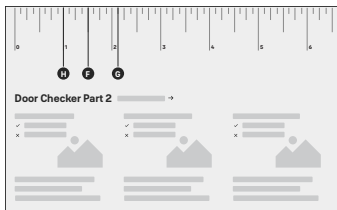
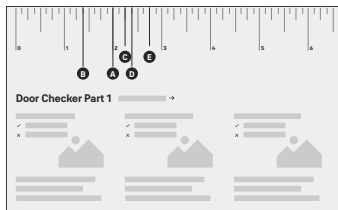

**⚠** Please do not drill any holes until you confirm that your door is compatible.

If you have confirmed that the existing holes are compatible with your new lock, please proceed to step 2 (skip step 1c).

# 1c Make or Adjust Holes

Skip this step if you have confirmed that the existing holes are compatible (step 1b).

1. Tear off the **Marking Template** (pages 7-8), and choose the preferred face bore diameter (**2- 1/8"** or **1-1/2"**) on either side of the template.
2. Tape the Marking Template onto the door as shown.
3. Check the door thickness. It should match either the shape with **solid** outlines (**1-3/4"**), or the one with **dashed** outlines (**1-3/8"**).
  - 3a. Use **solid** lines as a template for **1-3/4"** door thickness.
  - 3b. Use **dashed** lines for **1-3/8"** door thickness.
4. Choose your preferred backset. It should match either the shape with **solid** outlines (**2-3/4"**), or the one with **dashed** outlines (**2-3/8"**).
  - 4a. Use **solid** lines as a template for **2-3/4"** backset.
  - 4b. Use **dashed** lines for **2-3/8"** backset.
5. Drill holes in your door where marked.

6. On the door frame, align the center of the strike plate with the center of the edge bore. Trace the strike plate, then chisel to the depth of the strike plate so it sits flush with your door frame. Drill the **1"** diameter strike pocket with a minimum depth of **1"**.

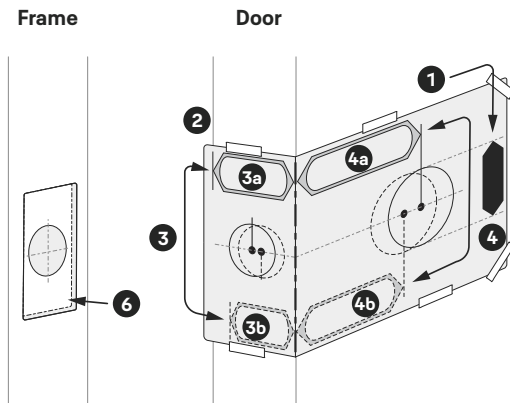

## 2 Install Deadbolt Latch

1. Correct deadbolt length is based on the backset. Refer to measurements **E** and **F** on the **Door Checker** (page 5) to verify backset.

### **E** 2-3/8" Backset (Out of box)

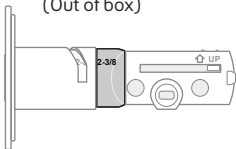

### **F** 2-3/4" Backset (To adjust, twist neck by holding the body stable)

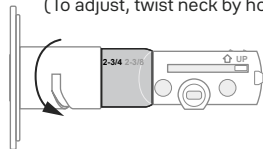

**!** Minimum strike pocket depth is 1".

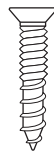

**x 2 for Deadbolt Latch**  
**x 2 for Strike Plate**  
(Actual size)

2. Align strike plate with deadbolt latch.
  - 2a. (Optional) Security screws can be used in place of the small strike plate screws.
3. Make sure UP arrow on the deadbolt is facing upwards.
4. Deadbolt latch must be in an unlocked position.

Note: If the deadbolt latch is extended, use a small flathead screwdriver to rotate slot until deadbolt latch is retracted.

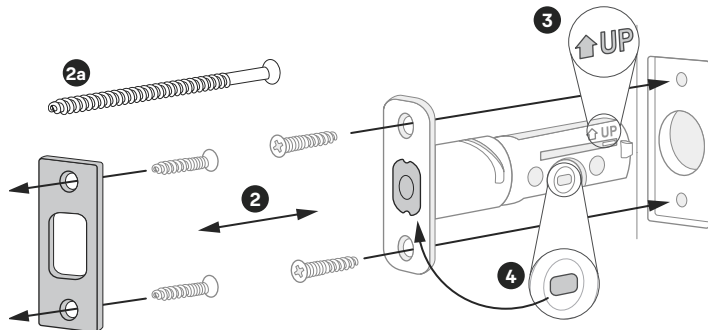

# 3 Install Exterior Keypad

1. Refer to measurements **G** and **H** on the **Door Checker** (page 6) to measure face bore hole. If the hole is **1-1/2"** (**G**), unscrew the two small screws and remove the adapter.

**⚠** **Install your lock with the door open.**  
Do not close your door until all the steps are completed.

2. Make sure your deadbolt latch is in an unlocked position. Refer to **step 2, point 4** (page 13) for guidance on how to retract it, if needed.
3. Slide the tailpiece through the deadbolt latch slot, making sure the keypad is on the exterior part of your door.
4. Guide the wire cable under the deadbolt.
5. Slide the keypad in place. Hold or secure in place until the mounting plate is installed in the next step.

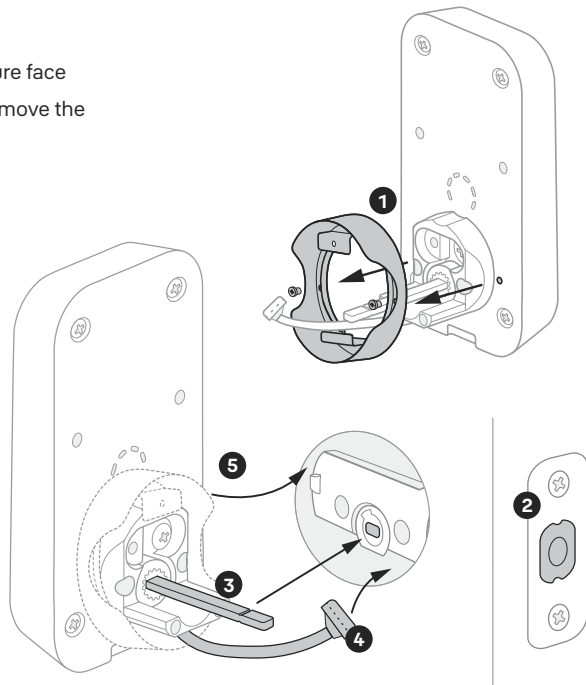

## 4 Install Mounting Plate

1. Refer to measurements **B**, **C**, and **D** on the **Door Checker** (page 5) to select screws.

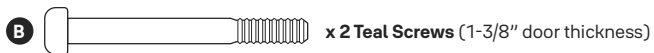

2. Route the wire cable into the designated slot in the mounting plate.
3. Guide posts of the mounting plate into the holes on the exterior keypad.
4. Slide tailpiece through the designated slot in the mounting plate.
5. Tighten screws with a screwdriver to secure the mounting plate. As you tighten the screws, make sure the mounting plate and the keypad are straight.



Ensure that the wire cable is not pinched to prevent it from reducing your lock's battery life.

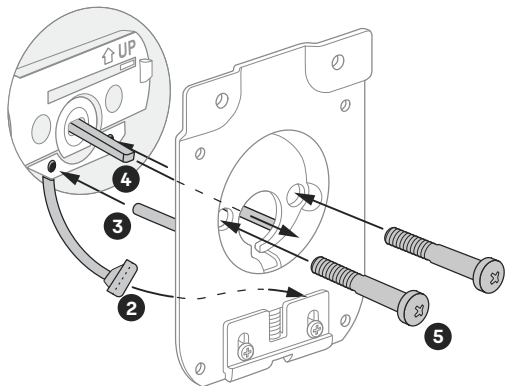

# 5 Attach Wire Cable to Interior Lock

1. Remove battery cover by pulling it upwards off the body of the interior lock.

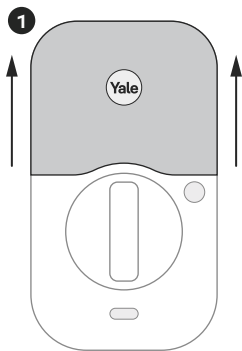

2. Make sure the side of the cable end with the ridges and the marked line faces outward.
3. Push cable into the designated slot until you hear a click.

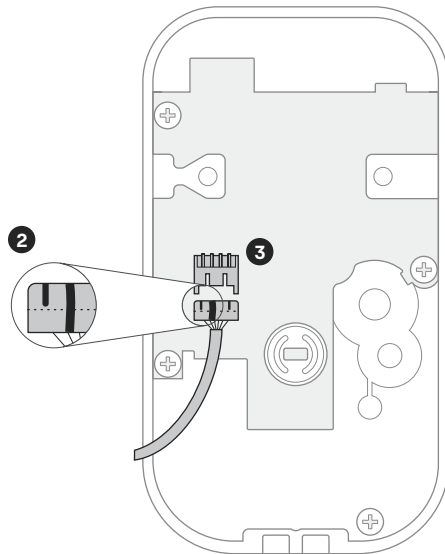



# 6 Install Interior Lock

1. Make sure the tailpiece slot is in horizontal position. Use the thumbturn to adjust if needed.
2. Slide the tailpiece through the designated slot on the back of the thumbturn.
3. Press the lock against the mounting plate, adjusting its position until it clicks into place and the bottom of the lock is held in place.
4. Tighten the two pre-installed screws.

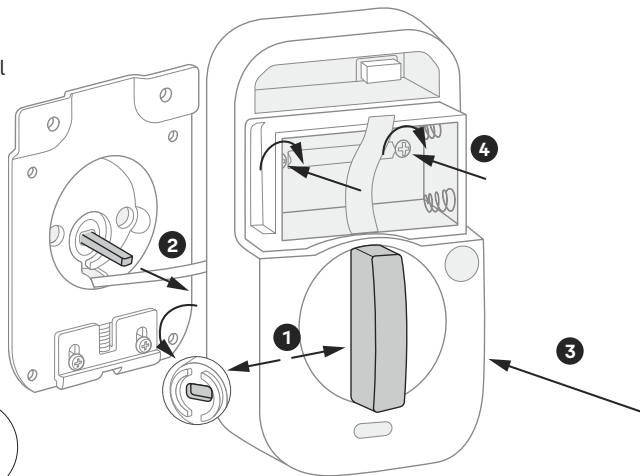

**⚠** When fully tightened, lock should be flush to door.

# 7 Test Thumbturn and Key

If deadbolt latch does not lock or unlock with the **key** (from the outside) or the **thumbturn** (from the inside):

- Ensure that the deadbolt latch is centered in the face bore hole;
- Ensure that the tailpiece is positioned horizontally and inserted through deadbolt latch slot (**step 3, point 3**) into the thumbturn slot (**step 6, point 2**).



**⚠** Smooth deadbolt latch operation will enhance your battery life.

# 8 Install Yale Smart Module

Insert Yale Smart Module into the designated slot at the top of the body of the lock.

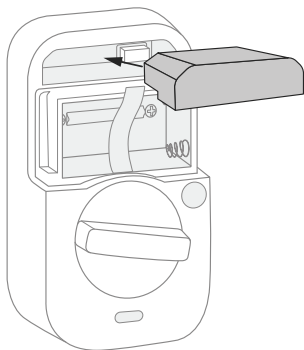

Batteries must **not** be installed when inserting or removing Yale Smart Module.

# 9 Install Batteries and Replace Cover

1. Before installing batteries, make sure the deadbolt latch is unlocked.
2. Place ribbon behind batteries for easy battery removal.
3. Install 4 batteries.
4. Replace cover.

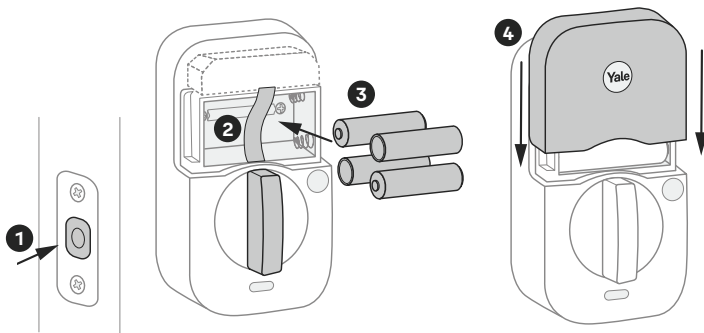

# Using Your Lock

## Exterior Keypad

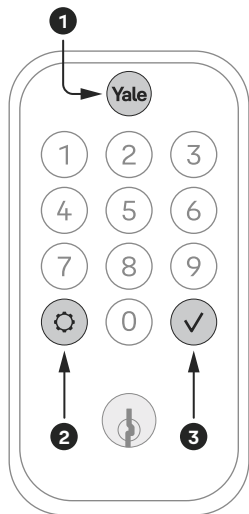

To **lock** your door

Press 

To **unlock** your door

Press  →

Enter entry code →



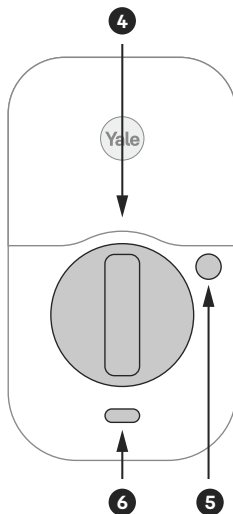

Press 































## Interior Lock



1. **Wake / One-Touch Locking**
2. **Warnings / Menu**
3. **Submit Entry Code**
4. **Thumbturn**
5. **Passage Button**
6. **Interior LED Indicator**

# Configuring Your Lock

1. Press the small black button on the interior of the lock until the 1 and  are illuminated on the keypad.
2. Press the 1 followed by the . Enter the settings menu. Enter a 4-8 digit programming code, followed by the . Enter the settings menu. Enter a 4-8 digit programming code. Press .
3. Choose the setting to change. Enter the digit corresponding to the function to be performed.

1	Programming Code Setting		1	Change the programming code		1	Enter a 4 – 8 digit user code	
2	User Codes		1	Create User codes		1	Enter a 4 – 8 digit user code	
			3	Remove User codes		3	Enter a 4 - 8 digit user code	
							Enter 00 to remove all codes	 
3	Advanced Settings		1	Auto Relock		1	Enter a number between 1 – 180 seconds	
						3	Turn off	
			2	Inside LED		1	Turn on	
						3	Turn off	
			3	One Touch Locking		1	Turn on	
						3	Turn off	
			5	Handing the lock				
4	Sound Settings		1	Turn on				
			3	Turn off				
6	All code lock out		1	Turn on				
			3	Turn off				
7	Z-Wave		1	Enroll				
			3	Unenroll				
8	Turn on Bluetooth Advertising							

## Exterior Keypad Alerts

<b>Gear flashes amber</b>	Low battery level 1
<b>Gear flashes red</b>	Low battery level 2
<b>Gear flashes red, then stays red</b>	Low battery level 3
<b>Checkmark flashes</b>	Pairing success
<b>Any key, then gear flash red</b>	Jammed lock
<b>Gear flashes white</b>	Pairing
<b>Gear flashes red during pairing</b>	Pairing failure



## Interior Lock Alerts

<b>LED indicator flashes blue</b>	Low battery levels 1, 2, and 3
<b>LED indicator flashes red</b>	Locked state
<b>LED indicator flashes green</b>	Unlocked state
<b>LED indicator turns green for 3 seconds</b>	Pairing success
<b>LED indicator turns red for 3 seconds</b>	Pairing failure
<b>LED indicator intermittently flashes yellow</b>	Passage Mode is on (see page 30)

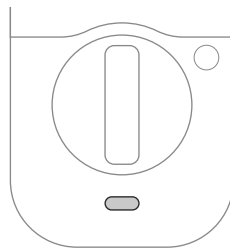

# Resetting Your Lock to Factory Defaults

1. Remove one battery.
2. Insert reset pin into the designated reset hole.
3. Press and hold the reset pin.
4. While holding the reset pin, reinsert battery.
5. Keep holding the reset pin for 5 more seconds.
6. Take out the reset pin.

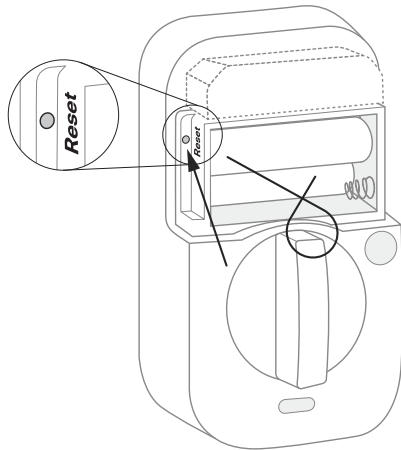



<b>Entry Codes</b>	<ul style="list-style-type: none"><li>• Entry codes are used to unlock your door.</li><li>• 500 entry codes can be created or deleted from the Yale lock or your Z-Wave third party app.</li></ul>
<b>Auto-Lock</b>	<ul style="list-style-type: none"><li>• Auto-Lock automatically locks the door for you.</li><li>• It can be set to lock on a timer for as short as 30 seconds, or as long as 30 minutes.</li></ul>
<b>Passage Mode</b>	<ul style="list-style-type: none"><li>• Use passage mode when you want to disable Auto-Lock for an extended period of time.</li><li>• Simply press and hold the Passage button on the inside of the lock until you hear a chime to turn it on.</li><li>• To turn passage mode off, lock your door or press and hold the Passage button until you hear a chime.</li></ul>

# Lock Operations Troubleshooting

<b>Lock does not respond.</b>	<ul style="list-style-type: none"><li>• Press the Yale logo to activate the keypad.</li><li>• Verify contact with the logo.</li><li>• If keypad numbers are visible, check if they respond when pressed.</li><li>• Check batteries are installed and oriented correctly in battery case. Replace batteries* if needed.</li><li>• Check that the keypad wire is fully connected and not pinched.</li></ul>
<b>Lock does not respond – door is locked and inaccessible.</b>	<ul style="list-style-type: none"><li>• Batteries may not have enough power. Replace batteries*.</li><li>• Use mechanical key to unlock the door.</li></ul>
<b>Lock is on for a while then shows no reaction. Lights dim.</b>	<ul style="list-style-type: none"><li>• Batteries do not have enough power. Replace batteries*.</li></ul>
<b>Lock chimes indicating code acceptance but door will not open.</b>	<ul style="list-style-type: none"><li>• Check for any foreign objects between door and frame.</li><li>• Check that the wire is firmly connected to the interior lock.</li></ul>
<b>Lock operates to allow access but will not automatically unlock.</b>	<ul style="list-style-type: none"><li>• Check to see if Auto-Lock is enabled.</li><li>• Disable Auto-Lock to lock the door manually.</li></ul>
<b>Lock responds “Low Battery”.</b>	<ul style="list-style-type: none"><li>• Replace all four (4) batteries* with new AA alkaline batteries.</li></ul>

# Lock Operations Troubleshooting

<b>Entry code will not register.</b>	<ul style="list-style-type: none"><li>• If low battery indicator is lit, replace batteries*.</li><li>• Verify that your entry code consists of 4 to 8 digits.</li><li>• Make sure you are using different entry codes for different users.</li><li>• Entry code must be entered while the keypad is active (tap on the Yale logo to wake it up and enter the entry code within 5 seconds).</li></ul>
<b>Upon entering an entry code and pressing the Check key, the lock displays "Invalid Code" error or lock times out without responding.</b>	<ul style="list-style-type: none"><li>• Verify entered code is a valid, previously programmed, 4 to 8 digit code.</li><li>• Turn off vacation mode from the lock's programming menu. This can only be done using the programming code (page 22).</li></ul>
<b>Upon entering an entry code and pressing the Check key, lock responds "Wrong Number of Digits".</b>	<ul style="list-style-type: none"><li>• The digits entered were incorrect or incomplete. Re-enter the correct code followed by the Check key.</li></ul>
<b>Deadbolt does not extend when locking the door with the keypad.</b>	<ul style="list-style-type: none"><li>• Lock was not handed properly. Find the setting called "Lock Handing" to fix this issue.</li></ul>
<b>Lock operates but makes no sound.</b>	<ul style="list-style-type: none"><li>• Turn on the volume from the lock's programming menu. This can only be done using the programming code (page 22).</li></ul>

<b>Deadbolt grinds and will not extend to lock when using an entry code but thumbturn locks and unlocks smoothly.</b>	<ul style="list-style-type: none"><li>• Lock was not handed properly. Find the setting called "Lock Handing" to fix this issue.</li></ul>
<b>Deadbolt is hitting the strike plate.</b>	<ul style="list-style-type: none"><li>• Reposition the strike plate to align with deadbolt.</li></ul>
<b>Deadbolt is not fully extending.</b>	<ul style="list-style-type: none"><li>• Increase depth of the deadbolt strike pocket in the frame.</li></ul>
<b>Resistance when locking deadbolt that requires pushing or pulling on the door to align deadbolt and latch.</b>	<p>Adjust your existing knob, lever, or handleset strike plate. Latch engagement into the strike is the main component used for door alignment.</p> <p>To adjust knob / lever / handleset strike plate:</p> <ol style="list-style-type: none"><li>1. Remove plate from door frame with a hand screwdriver. Note: Using an electric driver may strip screw heads or enlarge screw holes.</li><li>2. Locate tab on strike plate. Bend the tab towards surface of strike. Note: A small change may be all that is required.</li><li>3. Reinstall strike plate using a screwdriver and test again.</li><li>4. If door cannot be adjusted sufficiently with strike tab, both knob/lever/handleset latch and deadbolt could require adjustment – we suggest you contact a local locksmith for assistance.</li></ol> <p>For help with misalignments, watch our door alignment video: <a href="https://US.YaleHome.com/Support">US.YaleHome.com/Support</a></p>

**FCC:**

FCC ID: 2ABFG-YRD420BLEV1

IC ID: 11626A-YRD420BLEV1

## Class B Equipment

This equipment has been tested and found to comply with the limits for a Class B digital device, pursuant to Part 15 of the FCC Rules. These limits are designed to provide reasonable protection against harmful interference in a residential installation. This equipment generates, uses, and can radiate radio frequency energy and, if not installed and used in accordance with the instructions, may cause harmful interference to radio communications. However, there is no guarantee that interference will not occur in a particular installation. If this equipment does cause harmful interference to radio or television reception, which can be determined by turning the equipment off and on, the user is encouraged to try to correct the interference by one or more of the following measures:

- Reorient or relocate the receiving antenna.
- Increase the separation between the equipment and receiver.
- Connect the equipment into an outlet on a circuit different from that to which the receiver is connected.
- Consult the dealer or an experienced radio/TV technician for help.

**Warning:**

Changes or modifications to this device, not expressly approved by **Yale Home** could void the user's authority to operate the equipment.

**Innovation, Science and Economic Development Canada:**

FCC ID: 2ABFG-YRD420BLEV1

IC ID: 11626A-YRD420BLEV1

This Class A digital apparatus meets all requirements of the Canadian Interference Causing Equipment Regulations.

**Yale Home**24/7 Support: 1-855-213-5841 • [Support.ShopYaleHome.com](https://www.Support.ShopYaleHome.com)

Yale® and Yale Pro® 2 are registered trademarks of Masterlock LLC and its affiliates. Other products' brand names may be trademarks or registered trademarks of their respective owners and are mentioned for reference purposes only. ©Copyright 2023.

All rights reserved. Reproduction in whole or in part without the express written permission of Yale Home is prohibited.