

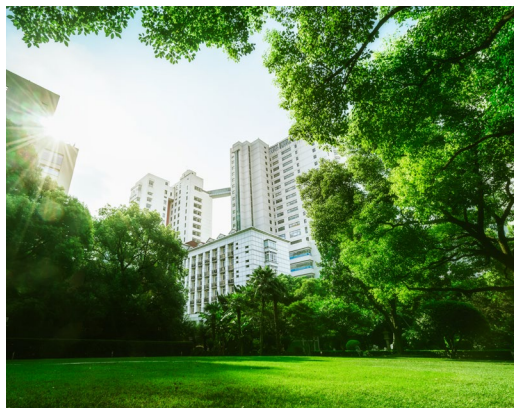

COMMUNICATIONS

# CATALOG

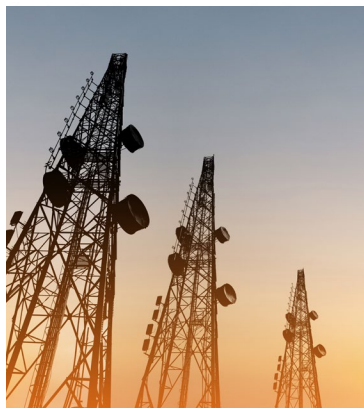

[www.SuperiorEssexCommunications.com](http://www.SuperiorEssexCommunications.com)



## About Superior Essex

Superior Essex International LP is a global leader in the design, manufacture, and supply of communications and energy cable products for indoor and outdoor applications. We offer a broad communications portfolio including premises optical fiber and copper cables, Outside Plant (OSP) cables, Fire Alarm and Security (FAS) cables, and Wireless cables and accessories. With over eighty years serving the communications and energy markets, we have cultivated a solid reputation as the preferred supplier of high-performance cabling for major communications service providers, leading enterprises, universities, hospitals, military facilities and businesses that rely on our innovative solutions to meet the demands of their evolving networks.



### OUR COMMITMENTS TO TRANSPARENCY AND SUSTAINABILITY

Superior Essex is firmly committed to environmental responsibility and transparency, and we constantly strive to lead innovation and design toward sustainable product solutions.



We are the first wire and telecommunications cable manufacturer to conduct an independent full Life Cycle Assessment examining the environmental impact of our high performance copper and optical fiber data cabling products, including our raw materials, manufacturing, transportation, installation, and end of life practices.



We are also the first in our industry to contribute toward LEED certification by offering Environmental Product Declarations (EPD) and Health Product Declarations™ (HPD™) for our premises copper and optical fiber cable products. Additionally, we offer Multi-Attribute Certifications for our premises copper products, which provide transparency into our manufacturing processes and help government procurement agents meet their sustainability goals by simplifying the sustainable supplier selection process.



As the first and only sustainable and transparent cable manufacturer, we are the preferred choice for all enterprises relying on sustainable cabling solutions.

UL and the related logo are registered trademarks of UL LLC. Health Product Declaration, HPD and the related logo are trademarks of Health Product Declaration Collaborative. GreenCircle Certified logo is a registered trademark of GreenCircle Certified, LLC. USGBC and the related logo are registered trademarks of U.S. Green Building Council.



### PROVIDING QUALITY, EXPERIENCE AND EXPERTISE

Superior Essex has TL 9000 and ISO 9001:2001 certification in every communications production facility, assuring a level of quality and consistency in both products and customer service. We also manufacture custom products with special requirements, so our Product Management team can quote and deliver unique designs that are tailored for your applications. Beyond our quality assurance, value, and flexibility, we guarantee on-time delivery of the products you request.



### PREMISES CABLE

Superior Essex Premises cables offer better performance, higher quality, and the best overall value, saving you both time and money. From our 10Gain® XP CAT 6A to our CAT 3 voice and data cables, to our Coaxial cables and our multimode and single mode optical fiber cables, we offer a broad portfolio of products that are essential for high-bandwidth applications.

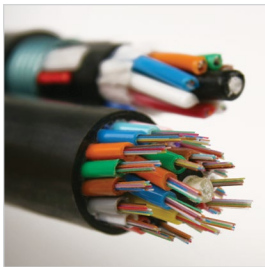

### OUTSIDE PLANT WIRE AND CABLE

Superior Essex is one of the world's leading producers of OSP copper wire and optical fiber communications cables. With more than 4,000 different designs available, including Broadband, Composite, Fiber, and Copper Wire. This extensive line of products serves virtually every application for direct burial, aerial, and high risk installations.

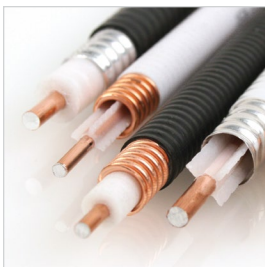

### WIRELESS

Wireless technology is becoming the primary communication method, so it is crucial to choose products that have exceptional quality and performance, allowing for better coverage and capacity. All of our Radio Frequency (RF) transmission and Distributed Antenna Systems (DAS) products provide an all-encompassing selection for the growing demands of wireless expansion for commercial wireless cell tower and in-building infrastructures.

# Table of Contents

## PREMISES FIBER CABLE

Simplex, Duplex and Quad Interconnect OFNR/OFNP	A-2
MicroLite® Data Center Interconnect & Distribution OFNP	A-4
Microarray Data Center Interconnect OFNR/OFNP	A-6
2 mm Microarray Breakout OFNP	A-8
Interlock Armored, 2 mm Microarray Breakout OFCP	A-10
3 mm Microarray Breakout OFNR/OFNP	A-12
Interlock Armored, 3 mm Microarray Breakout OFCR/OFCP	A-14
EnduraLite® Indoor/Outdoor, Loose Tube OFNR/OFNP	A-16
EnduraLite® Indoor/Outdoor, Loose Tube, Interlock Armored OFCR/OFCP	A-18
Breakout OFNR	A-20
Single Unit Distribution OFNR/OFNP	A-22
Multi-Unit Distribution OFNR/OFNP	A-24
Interlock Armored, Tight Buffer OFCR/OFCP	A-26
Ribbon Distribution OFNR/OFNP	A-28
Compact and Rugged Indoor MDU OFNR	A-30
Rugged Indoor/Outdoor MDU OFNR	A-31
Dry Block, Sunlight Resistant, Indoor/Outdoor, Tight Buffer OFNR	A-32
Dry Block, Sunlight Resistant, Indoor/Outdoor OFNP	A-34
Indoor/Outdoor, Interlock Armored, Tight Buffer OFCR/OFCP	A-36
Composite (formerly Hybrid) OFNR/OFNP	A-38
PowerWise® Fiber	
CL3R-OF/CL3P-OF, CMR-OF/CMP-OF and FPLR-OF/FPLP-OF	A-40
PowerWise® CLT Fiber CL3P-OF, CMP-OF	A-42
PowerWise® Indoor/Outdoor 2x2 Hybrid	
CL3R-OF/FPLR-OF Wet Location and CMR-OF	A-44
PowerWise® Indoor/Outdoor Tight Buffer Fiber	
CL3R-OF, CMR-OF and FPLR-OF	A-46

## PREMISES COMPOSITE CABLE

Bundled Composite Category 6 CMR	A-48
Bundled Composite Category 5e CMR	A-49
Residential Broadband Riser	
Coax RG-6 Quad Shield, Category 6 and Optical Fiber	A-50
Residential Broadband Riser	
Coax RG-6 Quad Shield, Category 5e and Optical Fiber	A-51

## PREMISES COPPER CABLE

<b>10Gain® XP</b> Category 6A CMR-LP/CMP-LP	A-52
<b>10Gain® +</b> Category 6A CMR/CMP	A-54
PowerWise® 10G 4PPoE CMP-LP	A-56
<b>10Gain®</b> Category 6A CMR/CMP	A-58
Category 6A U/FTP (STP) CMR/CMP	A-60
Category 6A U/FTP (STP) with FEP Jacket CMP	A-62
Category 6A F/UTP (ScTP) CMR/CMP	A-64
NextGain® Category 6eX CMR/CMP	A-66
DataGain® Category 6+ CMR/CMP	A-68
Category 6+ LSHF CMR-LSHF	A-70
Category 6+ F/UTP (ScTP) CMR/CMP	A-72
Category 6 CMR/CMP	A-74
Category 6 CM	A-76
Category 6 with FEP Jacket CMP	A-78
Category 6 CMR/CMX Outdoor Sunlight Resistant	A-80
Category 6 CMR/CMX Outdoor	A-82
Category 6 Patch Cable CMR	A-84
Category 6 Patch Cable CM	A-85
Cobra Category 5e+ CMR/CMP	A-86
Category 5e+ F/UTP (ScTP) CMR/CMP	A-88
PowerWise® 1G 4PPoE CMR-LP/CMP-LP	A-90
PowerWise® 1G 4PPoE Indoor/Outdoor	
CMR/CMX Sunlight Resistant	A-92
PowerWise® 1G 4PPoE Indoor/Outdoor CMR/CMX	A-94
Marathon LAN® Category 5e CMR/CMP	A-96
Marathon LAN® Category 5e with FEP Jacket CMP	A-94
Category 5e CM	A-101

## PREMISES COPPER CABLE CONTINUED...

Category 5e CMR/CMX Outdoor Sunlight Resistant	A-102
Category 5e CMR/CMX Outdoor	A-104
Category 5e F/UTP (ScTP) CMR/CMX Outdoor Sunlight Resistant	A-106
Category 5e F/UTP (ScTP) CMR/CMX Outdoor	A-108
6-Pair Category 5e CMR	A-110
25-Pair Power Sum Category 5e CMR/CMP	A-111
25-Pair Category 5e Indoor/Outdoor	A-112
Interlock Armored Premises Copper CMR	A-113
Bundled Category 6	A-114
Bundled Category 5e	A-115
EnduraGain® OSP Unshielded Formerly BBD	A-116
EnduraGain® OSP Shielded Formerly BBDN	A-117
EnduraGain® OSP Armored Formerly BBDG	A-118
EnduraGain® OSP Shielded Indoor/Outdoor Halogen-Free	
CM   Formerly BBDN I/O	A-120
EnduraGain® OSP Armored Indoor/Outdoor Halogen-Free	
CM   Formerly BBDG I/O	A-121
EnduraGain® OSP Duplex Formerly OSP Broadband Duplex	A-122
MEGAPIC® OSP Broadband Backbone Category 5	A-123
Category 3 CMR/CMP 2-Pair - 400-Pair	A-124
Category 3 Station Wire CMR/CMX Outdoor	A-126
ARMM Series CMR	A-128
Coax RG-11, Quad Shield CMR, CMP	A-130
Coax RG-11, 95% Shield CMR, CMP	A-132
Coax RG-6, Quad Shield CM, CMR, CMP	A-134
Coax RG-6, 95% Shield CMR, CMP	A-136
Coax RG-6, Tri-Shield 70% CM, CMR	A-137
Coax RG-6, 60% Shield CM, CMG, CMP	A-138
Coax RG-59, 95% Shield CMR, CMP	A-140
Coax RG-59, 95% Shield + 18/2 CMR, CMP	A-142
Fire Alarm, Non-Shielded Power Limited, Riser/Plenum	A-144
Fire Alarm, Shielded Power Limited, Riser/Plenum	A-146
Interlock Armored Fire Alarm Riser	A-148
Security Control, Non-Shielded Power Limited, Riser/Plenum	A-150
Security Control, Shielded Power Limited, Riser/Plenum	A-152
Access Control Composite Riser/Plenum	A-154

## CENTRAL OFFICE COPPER CABLE

ABAM (600B) and ABMM Series	A-156
1249C Series	A-157
1161A Series Category 3	A-158
600C Series	A-159
25-Pair Category 5e Shielded CMR	A-160
Switchboard 100 Ohm	A-162
Switchboard 100 Ohm 200A/800A Series (Canadian Color Code)	A-164
T100 Series	A-165
Switchboard 85 and Shielded Switchboard 85	A-166
Distribution Frame Wire DFW	A-167
Heavy Duty Distribution Frame Wire HD-DFW	A-168
Tight Twist Distribution Frame Wire DFW	A-169

**OSP FIBER CABLE**

Dri-Lite® Loose Tube Single Jacket All Dielectric Series 11D	B-2
Dri-Lite® Loose Tube Double Jacket Non-Armor Series 1GD	B-3
Dri-Lite® Loose Tube Single Jacket Single Armor Series 12D	B-4
Dri-Lite® Loose Tube Double Jacket Single Armor Series 1AD	B-5
Dri-Lite® Loose Tube Double Jacket Double Armor Series 1DD	B-6
Dri-Lite® Loose Tube Triple Jacket Double Armor Series 1CD	B-7
Loose Tube Single Jacket All Dielectric Series 11	B-8
Loose Tube Double Jacket Non-Armor Series 1G	B-9
Loose Tube Single Jacket Single Armor Series 12	B-10
Loose Tube Double Jacket Single Armor Series 1A	B-11
Loose Tube Double Jacket Double Armor Series 1D	B-12
Loose Tube Triple Jacket Double Armor Series 1C	B-13
Dri-Lite® Loose Tube Single Jacket Self Support Series 11DM	B-14
Dri-Lite® Loose Tube Double Jacket Self Support Series 1GDM	B-15
Dri-Lite® Loose Tube Single Jacket Single Armor Self Support Series 12DM	B-16
Dri-Lite® Loose Tube Double Jacket Single Armor Self Support Series 1ADM	B-17
Loose Tube Single Jacket Self Support Series 11M	B-18
Loose Tube Double Jacket Self Support Series 1GM	B-19
Loose Tube Single Jacket Single Armor Self Support Series 12M	B-20
Loose Tube Double Jacket Single Armor Self Support Series 1AM	B-21
Dri-Lite® Loose Tube Single Jacket Long-Span Self Support Series 11MLS	B-22
EnduraSpan™ ADSS	B-23
Single Loose Tube All Dielectric Series 51	B-32
Single Loose Tube Single Armor Series 52	B-33
Single Flex Tube All Dielectric Series F1	B-34
Single Flex Tube Single Armor Series F2	B-35
Flex Tube Locate Series FM	B-36
Ribbon Locate Series RM	B-37
Loose Tube Single Jacket All Dielectric Nylon Series 1NY	B-38
Dri-Lite® Loose Tube Indoor/Outdoor OFNR Series 13D	B-39
Loose Tube Indoor/Outdoor OFNR Series 13	B-40
Interlock Armored OSP Fiber OFCR Series 13I	B-41
Dri-Lite® Loose Tube Single Jacket All Dielectric I/O LSZH Series HZD	B-42
Dri-Lite® Loose Tube Single Jacket Single Armor I/O LSZH Series HZA	B-43
Single Loose Tube Indoor/Outdoor OFNR Series 53	B-46
Heavy Duty Loose Tube OFNR Series 1H	B-47
Telco Hybrid Loose Tube, Single 12 AWG Stranded Conductor Series 1N	B-48
UG FTTP Series 513	B-49
Buried FTTP, Steel Armor Series 52S	B-50
Buried FTTP, Steel Armor Series 52U	B-51
Figure 8 FTTP Series 573Q	B-52
Buried FTTP, Aluminum Armor Series 523	B-53
Telco Hybrid Buried Drop, Aluminum Armor Series 72	B-54
Telco Hybrid Buried Drop, Steel Armor Series 72S	B-55
Universal Drop FTTP Series 6U	B-56
Toneable Drop FTTP Series 6T	B-57
Universal FTTP Tight Buffered Indoor/Outdoor Drop Series W7U	B-58
Toneable FTTP Tight Buffered Indoor/Outdoor Drop Series W7T	B-59
W7 Fiber Drop Assemblies Series ADWSA	B-60
FTTP Tight Buffered Indoor/Outdoor Round Drop Series WR	B-61
Dri-Lite® Ribbon Series R1D	B-62
Dri-Lite® Ribbon Single Armor Series R2D	B-63
Stranded Loose Tube Ribbon Single Jacket All Dielectric Series S1	B-64
Stranded Loose Tube Ribbon Single Armor Series S2	B-66
Single Tube Ribbon Series R1	B-67
Single Tube Ribbon Single Armor Series R2	B-68
MicroLite™ OSP Air Blown LT Series	B-69

**OSP HYBRID CABLE**

Telco Hybrid Right of Way Series MR	B-70
Telco Hybrid Line Powering Series MR	B-71
Telco Hybrid Web Drop, Category 5e & OSP Fiber Series 5F	B-72
Telco Hybrid Web Drop, OSP Copper & Fiber Series 5W	B-73
Telco Hybrid Overjacket Drop, OSP Copper & Fiber Series 71 OJ	B-74
Telco Hybrid Web OSP Series 5V	B-75
Telco Hybrid Overjacket OSP Series 70 OJ	B-76
Telco Hybrid Loose Tube, Stranded 24AWG Copper Pairs Series L	B-77
PowerWise® Hybrid Series DE	B-78

**RDUP/RUS OSP COPPER CABLE**

POWERPIC™ OSP Copper Cable for Line Powering	B-79
SEALPIC®	B-80
SEALPIC®-84	B-82
SEALPIC®-FSF-84	B-84
SEALPIC®-FSF RDUP PE-89	B-86
CASPIC®-FSF RDUP PE-89	B-88
SEALPIC®-F RDUP PE-39	B-90
CUPIC-F® RDUP PE-39	B-92
GOPIC®-F RDUP PE-39	B-94

**BELL OSP COPPER CABLE**

ALPETH BHBA, BHAA, BKMA and BKTA	B-96
PASP BHBH, BHAH, BKMH and BKTH	B-98
Self-Support BHAS and BKMS	B-100
Reinforced Self-Support BHAP, BKMP and BKTP	B-101
Bonded STALPETH DCAZ, DCMZ and DCTZ	B-102
STEAMPETH DKTN	B-104
Power Station High Potential Filled ASP CMAW	B-105
Filled ALPETH ANBA, ANAA, ANMA and ANTA	B-106
Filled ASP ANBW, ANAW, ANMW and ANTW	B-108
T-SCREEN® Filled ASP KNAW and KHAH	B-111

**CANADIAN OSP COPPER CABLE**

CELLFIB BJBB, BJAB, BJMB and BJTB	B-112
Canadian ALPETH BHBB, BHAB, BKMB and BKTB	B-114
SEALPAP BHBFB, BHAF, BKMF and BKTF	B-116
Canadian Bonded STALPETH DCAZ, DCMZ and DCTZ	B-118
Canadian Integrated Messenger Wire IM/F, IM/H and IM/G	B-120
Canadian ADP NMS with QuickCount® in Meters	B-121
Aerial Drop Wire ADW	B-122
Buried Distribution Wire BCBD	B-123

**OSP COPPER WIRE**

C-Rural Wire	B-124
IMRDW	B-125
IMRDWS	B-126
ADP NMS	B-127
ADP NMS Compact Design 6 x 24	B-128
ADP S	B-129
Integrated Messenger Wire IM/F, IM/H and IM/G	B-130
BDW A	B-131
BDW G	B-132
BW GDJ	B-133
BW AF	B-135
Non-Jacketed Tight Twist Cable Core	B-136
Air Pipe	B-136
Bridle Wire	B-137
Temporary Drop Wire TDW	B-137
E-Block Wire	B-138
Ground Wire Bare or Jacketed	B-139
Cross-Connect Category 5 Wire XCW	B-140
Indoor/Outdoor Cross-Connect Wire XCW	B-141

## Table of Contents

### RF FEEDER CABLE AND JUMPERS

LHF Series Low Loss High Flexible Foam Dielectric Feeder	D-2
LHF Series (Ultimate High Performance)	
Ultimate Low Loss High Flexible Foam Dielectric Feeder	D-4
HFSC Series Super Flexible Foam Dielectric Feeder	D-5
Fiber-to-the-Antenna (FTTA)	D-6
RF Jumper Cable	D-7

### RF CONNECTORS

DIN Series for LHF	D-8
DIN Series for HFSC	D-9
N Series for LHF	D-10
N Series for HFSC	D-11

### IN-BUILDING WIRELESS CABLE AND JUMPERS

DAS Hybrid Fiber + Copper	D-12
DAS Hybrid, Interlock Armored Fiber + Copper	D-13
LHF Riser Low Loss High Flexible Foam Dielectric Feeder	D-14
LHF Plenum Low Loss High Flexible Air Dielectric Feeder	D-15
HFSC Riser Super Flexible Foam Dielectric Feeder	D-16
HFSC Plenum Super Flexible Air Dielectric Feeder	D-17
HFAC Riser Low Loss High Flexible Foam Dielectric Feeder	D-18
HFAC Plenum Low Loss High Flexible Air Dielectric Feeder	D-19
DAS Riser Jumper Cable	D-20
DAS Plenum Jumper Cable	D-21

### IN-BUILDING WIRELESS CONNECTORS

DIN Series for LHF	D-22
DIN Series for HFSC	D-23
DIN Series for HFAC	D-24
N Series for LHF	D-25
N Series for HFSC	D-26
N Series for HFAC	D-27

### WIRELESS ACCESSORIES

Cable Preparation Tools	D-28
Cushion and Boot Assembly Kit	D-29
Universal Weatherproofing Kit	D-30
Hoisting Grip Lace-Up and Pre-Laced	D-31
Clip-On Grounding Kit	D-32
Universal Snap-in Hanger Kit	D-33
Stackable Snap-in Hanger Kit	D-34
Standard Hanger Kit	D-35
$\lambda/4$ Wave Surge Arrestor	D-36
Gas Tube Surge Arrestor	D-37
Round Adapter Kit	D-38
Stand-Off Adapter Kit	D-39
Three-Way Stand-Off Adapter Kit	D-40
Angle Adapter Kit	D-40
Ground Bus Bar Kit	D-41
Weather Proofing Shell	D-42
Anti-Theft Hardware Kit	D-43

### TECHNICAL INFORMATION

Metric Conversions	X-2
American Wire Gauge Sizes	X-2
Optical Fiber Types	X-3
Optical Fiber Specifications	X-4
Optical Fiber Cable	X-6
Canadian Central Office Cable	X-6
OSP Copper Cable	X-7
Mechanical Protection (+M) for Extreme Risk Environments	X-8
Copper Wire and Cable	X-9
Fire Alarm/Security Control Cable	X-10
Premises Cable Conduit Fill Quick Reference	X-11
Packaging	X-12
Terms and Conditions of Sale	X-18
Part Number Index	X-19



# SUSTAINABILITY FAST FACTS

Superior Essex is firmly committed to sustainable practices and transparency, and we strive to lead innovation and design toward sustainable product solutions. As the first and only telecommunications wire and cable manufacturer to offer Environmental Product Declarations (EPD), Health Product Declarations™ (HPD™), and Multi-Attribute Certifications, we are the preferred choice for all enterprises relying on sustainable, high-performance cabling solutions.

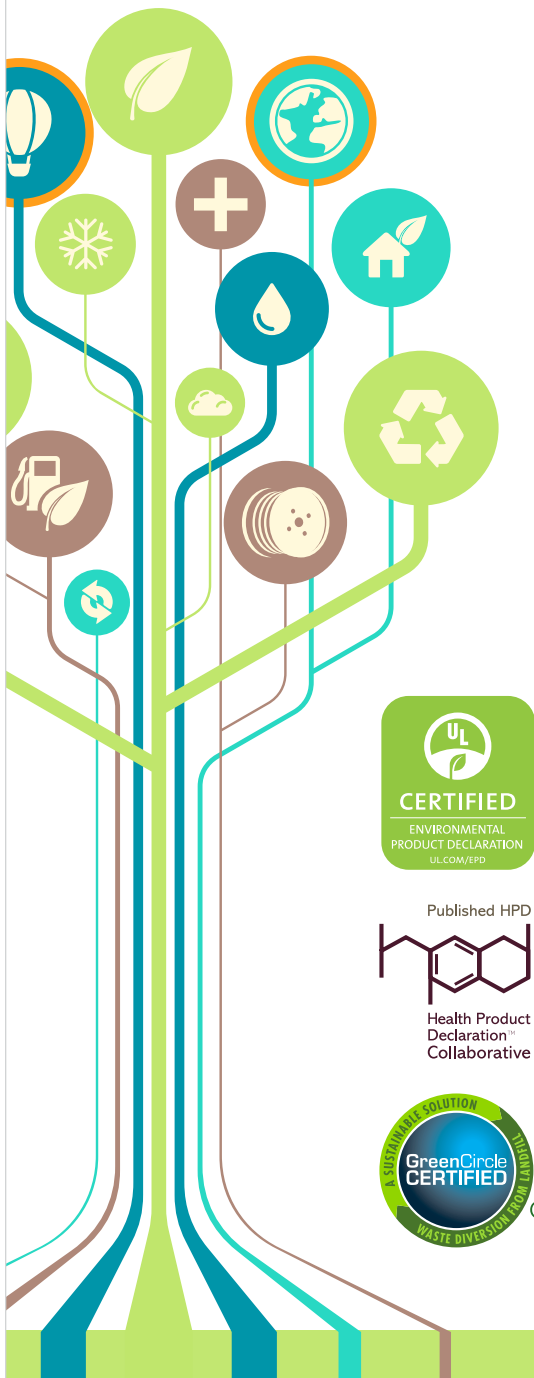

## What is an Environmental Product Declaration (EPD)?

- An Environmental Product Declaration is a source of transparent, scientifically-based information that discloses the potential environmental impact of a product or product family.
- Superior Essex Environmental Product Declarations are verified by UL® Environment, a division of the safety science company Underwriters Laboratories.
  - » Superior Essex provides premises copper and optical fiber cabling products with EPDs.

## What is a Health Product Declaration (HPD)?

- A Health Product Declaration is a report that describes product contents and each ingredient's relationship to human and ecological health.
- Superior Essex Health Product Declarations are published according to the Health Product Declaration Collaborative Standard.
  - » Superior Essex provides premises copper and optical fiber cabling products with HPDs.

## What is a Multi-Attribute Certification?

- A Multi-Attribute Certification provides a complete overview of the sustainability of a product, its packaging and manufacturing operations.
- Superior Essex Multi-Attribute Certifications are published through GreenCircle Certified LLC, in accordance with internationally recognized standards and the Federal Trade Commission's Green Guides.
  - » Superior Essex provides premises copper cabling products with Multi-Attribute Labels.

## Superior Essex Contributing to LEED certification

- Superior Essex cable products with EPDs can contribute toward one (1) building product disclosure and optimization LEED credit in the Materials and Resources credit category.
- Similarly, Superior Essex cable products with HPDs can contribute toward one (1) building product disclosure and optimization LEED credit in the Materials and Resources credit category.
- Products that have both EPDs and HPDs can contribute toward two (2) separate credits in the Materials and Resources credit category.

## The Importance of Transparency and Sustainable Solutions

- As the demand for green buildings continues to grow, many architects, contractors and engineers are seeking out products that are manufactured sustainably from organizations that are transparent about their products and operations.
- The International Green Construction Code (IgCC) 2015 states that EPDs are one of several Materials and Resources Compliance pathways, and this code has been adopted in whole or in part by several municipalities and states as mandatory or voluntary.

## Where can I find Superior Essex sustainability information?

- » [ce.SuperiorEssex.com/enviro](http://ce.SuperiorEssex.com/enviro)
- » [GreenWizard.com](http://GreenWizard.com)



Published HPD



UL and the related logo are registered trademarks of UL LLC. Health Product Declaration, HPD and the related logo are trademarks of Health Product Declaration Collaborative. GreenCircle Certified logo is a registered trademark of GreenCircle Certified, LLC.



800.551.8948

[SuperiorEssexCommunications.com](http://SuperiorEssexCommunications.com)

All information, content, data, specifications, packaging and part numbers detailed herein are subject to change. For the most up-to-date information, please visit [SuperiorEssexCommunications.com](http://SuperiorEssexCommunications.com). Purchase of this product is subject exclusively to the then current **Superior Essex International LP Terms and Conditions of Sale for Communications Cable, Wire and Connectivity Products**, which can be found on our website, [SuperiorEssexCommunications.com](http://SuperiorEssexCommunications.com), or provided to you upon request.



**PREMISES FIBER CABLE**

Simplex, Duplex and Quad Interconnect OFNR/OFNP	A-2
MicroLite® Data Center Interconnect & Distribution OFNP	A-4
Microarray Data Center Interconnect OFNR/OFNP	A-6
2 mm Microarray Breakout OFNP	A-8
Interlock Armored, 2 mm Microarray Breakout OFCP	A-10
3 mm Microarray Breakout OFNR/OFNP	A-12
Interlock Armored, 3 mm Microarray Breakout OFCR/OFCP	A-14
EnduraLite® Indoor/Outdoor, Loose Tube OFNR/OFNP	A-16
EnduraLite® Indoor/Outdoor, Loose Tube, Interlock Armored OFCR/OFCP	A-18
Breakout OFNR	A-20
Single Unit Distribution OFNR/OFNP	A-22
Multi-Unit Distribution OFNR/OFNP	A-24
Interlock Armored, Tight Buffer OFCR/OFCP	A-26
Ribbon Distribution OFNR/OFNP	A-28
Compact and Rugged Indoor MDU OFNR	A-30
Rugged Indoor/Outdoor MDU OFNR	A-31
Dry Block, Sunlight Resistant, Indoor/Outdoor, Tight Buffer OFNR	A-32
Dry Block, Sunlight Resistant, Indoor/Outdoor OFNP	A-34
Indoor/Outdoor, Interlock Armored, Tight Buffer OFCR/OFCP	A-36
Composite (formerly Hybrid) OFNR/OFNP	A-38
PowerWise® Fiber	
CL3R-OF/CL3P-OF, CMR-OF/CMP-OF and FPLR-OF/FPLP-OF	A-40
PowerWise® CLT Fiber CL3P-OF, CMP-OF	A-42
PowerWise® Indoor/Outdoor 2x2 Hybrid	
CL3R-OF/FPLR-OF Wet Location and CMR-OF	A-44
PowerWise® Indoor/Outdoor Tight Buffer Fiber	
CL3R-OF, CMR-OF and FPLR-OF	A-46

**PREMISES COMPOSITE CABLE**

Bundled Composite Category 6 CMR	A-48
Bundled Composite Category 5e CMR	A-49
Residential Broadband Riser	
Coax RG-6 Quad Shield, Category 6 and Optical Fiber	A-50
Residential Broadband Riser	
Coax RG-6 Quad Shield, Category 5e and Optical Fiber	A-51

**PREMISES COPPER CABLE**

10Gain® XP Category 6A CMR-LP/CMP-LP	A-52
10Gain® + Category 6A CMR/CMP	A-54
PowerWise® 10G 4PPoE CMP-LP	A-56
10Gain® Category 6A CMR/CMP	A-58
Category 6A U/FTP (STP) CMR/CMP	A-60
Category 6A U/FTP (STP) with FEP Jacket CMP	A-62
Category 6A F/UTP (ScTP) CMR/CMP	A-64
NextGain® Category 6eX CMR/CMP	A-66
DataGain® Category 6+ CMR/CMP	A-68
Category 6+ LSHF CMR-LSHF	A-70
Category 6+ F/UTP (ScTP) CMR/CMP	A-72
Category 6 CMR/CMP	A-74
Category 6 CM	A-76
Category 6 with FEP Jacket CMP	A-78
Category 6 CMR/CMX Outdoor Sunlight Resistant	A-80
Category 6 CMR/CMX Outdoor	A-82
Category 6 Patch Cable CMR	A-84
Category 6 Patch Cable CM	A-85
Cobra Category 5e+ CMR/CMP	A-86
Category 5e+ F/UTP (ScTP) CMR/CMP	A-88
PowerWise® 1G 4PPoE CMR-LP/CMP-LP	A-90
PowerWise® 1G 4PPoE Indoor/Outdoor	
CMR/CMX Sunlight Resistant	A-92
PowerWise® 1G 4PPoE Indoor/Outdoor CMR/CMX	A-94
Marathon LAN® Category 5e CMR/CMP	A-96
Marathon LAN® Category 5e with FEP Jacket CMP	A-94
Category 5e CM	A-101

**PREMISES COPPER CABLE CONTINUED...**

Category 5e CMR/CMX Outdoor Sunlight Resistant	A-102
Category 5e CMR/CMX Outdoor	A-104
Category 5e F/UTP (ScTP) CMR/CMX Outdoor Sunlight Resistant	A-106
Category 5e F/UTP (ScTP) CMR/CMX Outdoor	A-108
6-Pair Category 5e CMR	A-110
25-Pair Power Sum Category 5e CMR/CMP	A-111
25-Pair Category 5e Indoor/Outdoor	A-112
Interlock Armored Premises Copper CMR	A-113
Bundled Category 6	A-114
Bundled Category 5e	A-115
EnduraGain® OSP Unshielded Formerly BBD	A-116
EnduraGain® OSP Shielded Formerly BBDN	A-117
EnduraGain® OSP Armored Formerly BBDG	A-118
EnduraGain® OSP Shielded Indoor/Outdoor Halogen-Free	
CM   Formerly BBDN I/O	A-120
EnduraGain® OSP Armored Indoor/Outdoor Halogen-Free	
CM   Formerly BBDG I/O	A-121
EnduraGain® OSP Duplex Formerly OSP Broadband Duplex	A-122
MEGAPIC® OSP Broadband Backbone Category 5	A-123
Category 3 CMR/CMP 2-Pair - 400-Pair	A-124
Category 3 Station Wire CMR/CMX Outdoor	A-126
ARMM Series CMR	A-128
Coax RG-11, Quad Shield CMR, CMP	A-130
Coax RG-11, 95% Shield CMR, CMP	A-132
Coax RG-6, Quad Shield CM, CMR, CMP	A-134
Coax RG-6, 95% Shield CMR, CMP	A-136
Coax RG-6, Tri-Shield 70% CM, CMR	A-137
Coax RG-6, 60% Shield CM, CMG, CMP	A-138
Coax RG-59, 95% Shield CMR, CMP	A-140
Coax RG-59, 95% Shield + 18/2 CMR, CMP	A-142
Fire Alarm, Non-Shielded Power Limited, Riser/Plenum	A-144
Fire Alarm, Shielded Power Limited, Riser/Plenum	A-146
Interlock Armored Fire Alarm Riser	A-148
Security Control, Non-Shielded Power Limited, Riser/Plenum	A-150
Security Control, Shielded Power Limited, Riser/Plenum	A-152
Access Control Composite Riser/Plenum	A-154

**CENTRAL OFFICE COPPER CABLE**

ABAM (600B) and ABMM Series	A-156
1249C Series	A-157
1161A Series Category 3	A-158
600C Series	A-159
25-Pair Category 5e Shielded CMR	A-160
Switchboard 100 Ohm	A-162
Switchboard 100 Ohm 200A/800A Series (Canadian Color Code)	A-164
T100 Series	A-165
Switchboard 85 and Shielded Switchboard 85	A-166
Distribution Frame Wire DFW	A-167
Heavy Duty Distribution Frame Wire HD-DFW	A-168
Tight Twist Distribution Frame Wire DFW	A-169

# Simplex, Duplex and Quad Interconnect

OFNR/OFNP

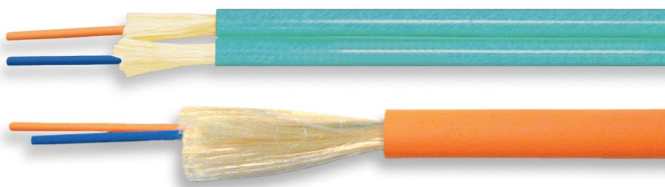

Zip Cord Configuration

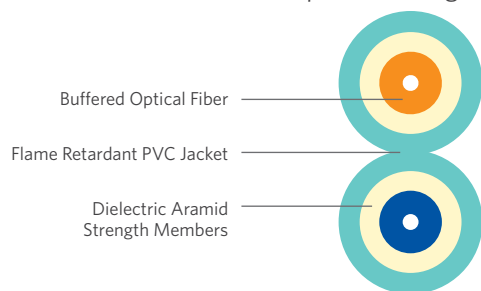

Buffered Optical Fiber

Flame Retardant PVC Jacket

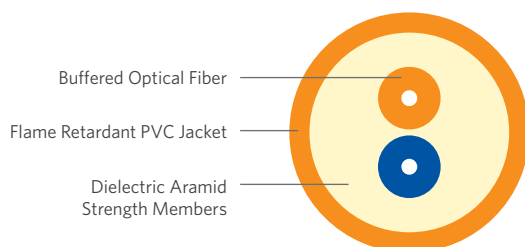
Dielectric Aramid  
Strength Members

Buffered Optical Fiber

Flame Retardant PVC Jacket

Dielectric Aramid  
Strength Members

Round Configuration

## SPECIFICATIONS

Configuration	Flexible tight buffered optical fibers surrounded by aramid yarns and covered by a flame retardant jacket
Strength Elements	Dielectric aramid yarns
Jacket	OFNR: Flame retardant (FR) PVC OFNP: FR, low smoke PVC
Performance Compliance	UL 1651 CSA C22.2 No. 232 UL 1666 NFPA 262 Telcordia® GR-409-CORE, Issue 2 ANSI/ICEA S-83-596 ANSI/TIA-568.3-D
NRTL Programs	UL, c(UL) Listed OFNR UL, c(UL) Listed OFNP
Sustainability	UL Certified EPD HPD USGBC® Member RoHS-compliant/RoHS 2-compliant REACH-compliant

## ENVIRONMENTAL SPECIFICATIONS

	Riser	Plenum
Operation	-40°C to +75°C	0°C to +75°C
Storage/Shipping	-40°C to +75°C	-40°C to +75°C
Installation	-20°C to +65°C	0°C to +65°C

## PRODUCT DESCRIPTION



**FIRST MANUFACTURER IN THE INDUSTRY**  
to offer products that contribute toward LEED!

Simplex, Duplex and Quad Optical Fiber Interconnect Cables are typically used for patch cords and intrabuilding installations. Superior Essex designed these cables for environments where small size, flexible construction and flame resistance are required. These cables are available in both riser and plenum versions. Higher performance optical fibers are offered, including bend insensitive G.657.A1 single mode and 10G/300 OM3 and 10G/550 OM4 laser optimized 50 μm multimode.

The design consists of flexible tight buffer material extruded over the fiber to a diameter of 900 μm for use with standard connectors. Dielectric yarns are applied for additional strength and a flame retardant PVC jacket covers the strength members. Appropriate materials are used to achieve an OFNR (riser) or OFNP (plenum) rating. Standard 2.9 mm and small form factor 2 mm diameters are available for simplex and duplex designs.

## APPLICATIONS

- Cross-connects and patch applications
- Communication closets to wall outlets
- Drop ceiling and plenum air space applications

## FEATURES

- UL® Certified Environmental Product Declaration (EPD)
- Health Product Declaration™ (HPD™)
- Simplex and duplex zip cord designs in 2 mm and 2.9 mm diameters
- Round, duplex and quad designs
- Marked in feet and meters
- BrakeBox® payout control system

## BENEFITS

- Contributes toward 1 LEED point under the Material and Resources credit (MRc)
- Contributes toward 1 LEED point under the MRC
- Meets all the requirements for both standard and small form factor connectors for “in-front-of-the-shelf” applications
- Perfect for in-wall and “behind-the-shelf” applications
- Meets commercial, government and international requirements for length markings
- Adjustable tension control on reel prevents over spin and entangling of cable

## SUSTAINABILITY LEADERSHIP



UL and the related logo are registered trademarks of UL LLC. Health Product Declaration, HPD and the related logo are trademarks of Health Product Declaration Collaborative. Telcordia is a registered trademark of Ericsson Inc. USGBC and the related logo are registered trademarks of U.S. Green Building Council.

**PART NUMBERS AND PHYSICAL CHARACTERISTICS**

Listing	Part Number <sup>1</sup>	Configuration	Fiber Type	Fiber Count	Nominal Diameter in (mm)	Nominal Weight lbs/kft (kg/km)	Maximum Tensile Loading		Minimum Bend Radius		Package
							Install lbs (N)	Long Term lbs (N)	Install in (mm)	Long Term in (mm)	
OFNR	33001x101	Round	Single Mode	1	0.11 (2.9)	6 (8)	50 (220)	15 (70)	1.7 (44)	1.1 (29)	Plywood reel
OFNR	A3001x101	Round	Single Mode	1	0.08 (2.0)	3 (4)	50 (220)	15 (70)	1.2 (30)	0.8 (20)	Plywood reel
OFNR	B3002x101	Zip	Single Mode	2	0.11 x 0.24 (2.9 x 6.2)	8 (12)	100 (440)	30 (130)	1.7 (44)	1.1 (29)	Plywood reel
OFNR	C3002x101	Zip	Single Mode	2	0.08 x 0.17 (2.0 x 4.2)	6 (9)	50 (220)	15 (70)	1.2 (30)	0.8 (20)	Plywood reel
OFNR	33002x1zz	Round	Single Mode	2	0.20 (5.0)	14 (21)	100 (440)	30 (130)	3.0 (75)	2.0 (50)	use key
OFNR	33004x1zz	Round	Single Mode	4	0.20 (5.0)	15 (23)	100 (440)	30 (130)	3.0 (75)	2.0 (50)	use key
OFNP	34001x101	Round	Single Mode	1	0.11 (2.9)	6 (9)	50 (220)	15 (70)	1.7 (44)	1.1 (29)	Plywood reel
OFNP	A4001x101	Round	Single Mode	1	0.08 (2.0)	3 (4)	50 (220)	15 (70)	1.2 (30)	0.8 (20)	Plywood reel
OFNP	B4002x101	Zip	Single Mode	2	0.11 x 0.24 (2.9 x 6.2)	8 (11)	100 (440)	30 (130)	1.7 (44)	1.1 (29)	Plywood reel
OFNP	C4002x101	Zip	Single Mode	2	0.08 x 0.17 (2.0 x 4.2)	6 (9)	50 (220)	15 (70)	1.2 (30)	0.8 (20)	Plywood reel
OFNP	34002x1zz	Round	Single Mode	2	0.17 (4.2)	12 (18)	100 (440)	30 (130)	2.5 (63)	1.7 (42)	use key
OFNP	34004x1zz	Round	Single Mode	4	0.17 (4.2)	13 (20)	100 (440)	30 (130)	2.5 (63)	1.7 (42)	use key
OFNR	33001yG01	Round	Multimode	1	0.11 (2.9)	6 (8)	50 (220)	15 (70)	1.7 (44)	1.1 (29)	Plywood reel
OFNR	A3001yG01	Round	Multimode	1	0.08 (2.0)	3 (4)	50 (220)	15 (70)	1.2 (30)	0.8 (20)	Plywood reel
OFNR	B3002yG01	Zip	Multimode	2	0.11 x 0.24 (2.9 x 6.2)	8 (12)	100 (440)	30 (130)	1.7 (44)	1.1 (29)	Plywood reel
OFNR	C3002yG01	Zip	Multimode	2	0.08 x 0.17 (2.0 x 4.2)	6 (9)	50 (220)	15 (70)	1.2 (30)	0.8 (20)	Plywood reel
OFNR	33002yGzz	Round	Multimode	2	0.20 (5.0)	14 (21)	100 (440)	30 (130)	3.0 (75)	2.0 (50)	use key
OFNR	33004yGzz	Round	Multimode	4	0.20 (5.0)	15 (23)	100 (440)	30 (130)	3.0 (75)	2.0 (50)	use key
OFNP	34001yG01	Round	Multimode	1	0.11 (2.9)	6 (9)	50 (220)	15 (70)	1.7 (44)	1.1 (29)	Plywood reel
OFNP	A4001yG01	Round	Multimode	1	0.08 (2.0)	3 (4)	50 (220)	15 (70)	1.2 (30)	0.8 (20)	Plywood reel
OFNP	B4002yG01	Zip	Multimode	2	0.11 x 0.24 (2.9 x 6.2)	8 (11)	100 (440)	30 (130)	1.7 (44)	1.1 (29)	Plywood reel
OFNP	C4002yG01	Zip	Multimode	2	0.08 x 0.17 (2.0 x 4.2)	6 (9)	50 (220)	15 (70)	1.2 (30)	0.8 (20)	Plywood reel
OFNP	34002yGzz	Round	Multimode	2	0.17 (4.2)	12 (18)	100 (440)	30 (130)	2.5 (63)	1.7 (42)	use key
OFNP	34004yGzz	Round	Multimode	4	0.17 (4.2)	13 (20)	100 (440)	30 (130)	2.5 (63)	1.7 (42)	use key

**SINGLE MODE OPTICAL FIBER TYPES**

	TeraFlex® Bend Resistant		
	G.657.A1	G.657.A2	G.657.B3
<sup>1</sup> Replace "x" with:	K	J	L
Standard Jacket Colors*	Yellow		

\*Other jacket colors available upon request.  
See "Optical Fiber Specifications" in the "Technical Info" section for detailed fiber type specifications.

**MULTIMODE OPTICAL FIBER TYPES**

	TeraGain®	TeraFlex Bend Resistant Laser Optimized 50/125	
	62.5/125	10G/300	10G/550
<sup>1</sup> Replace "y" with:	6	N	P
Standard Jacket Colors*	Orange	Aqua	

**PACKAGING**

	Cut to Length Plywood Reel	1,000 ft BrakeBox®	1,500 ft BrakeBox®	2,000 ft BrakeBox®
<sup>1</sup> Replace "zz" with:	01	BB	BD	BC

# MicroLite® Data Center Interconnect & Distribution

OFNP

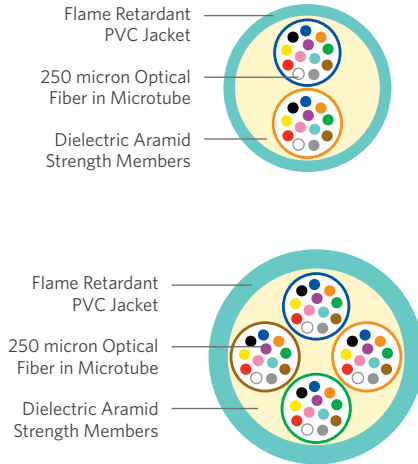
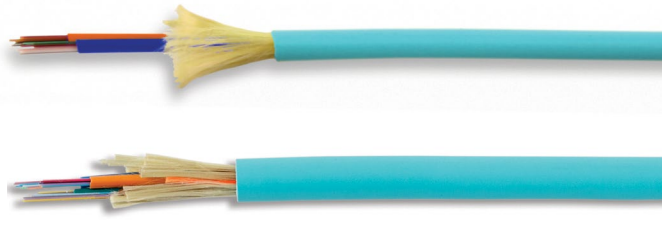

## SPECIFICATIONS

<b>24-Fiber Interconnect Configuration</b>	Two (2) microtubes containing twelve 250 micron optical fibers; the microtubes are surrounded by dielectric aramid yarns and enclosed in a single 3.8 mm plenum loose tube
<b>48-Fiber Distribution Configuration</b>	Four (4) microtubes containing twelve 250 micron optical fibers; the microtubes are surrounded by dielectric aramid yarns and enclosed in a single 6.4 mm plenum loose tube
<b>Jacket</b>	Flame retardant, low smoke plenum grade PVC
<b>Performance Compliance</b>	UL 1651 CSA C22.2 No. 232 NFPA 262 Telcordia® GR-409-CORE, Issue 2 ANSI/ICEA S-83-596 ANSI/TIA-568.3-D
<b>NRTL Programs</b>	UL, c(UL) Listed OFNP
<b>Sustainability</b>	UL Certified EPD HPD USGBC® Member RoHS-compliant/RoHS 2-compliant

## PRODUCT DESCRIPTION

**FIRST MANUFACTURER IN THE INDUSTRY**  
to offer products that contribute toward LEED!

MicroLite® Data Center interconnect and distribution cables from Superior Essex are designed for high performance coupled with easily accessible fibers in a small package. The fibers in these cables are encased in a soft, easily removable material securely identifies the fiber groups and makes connectorization quicker and easier than dealing with a binder thread. The interconnect cable consists of two (2) 12-fiber tubes yielding a 24-fiber interconnect which can be directly connected to a 24-fiber MTP® or MPO. The distribution-grade 48-fiber MicroLite cable contains four (4) 12-fiber microtube bundles which can be fusion spliced, connectorized to high density MTP/MPOs or attached to standard single ferrule mechanical connectors (LC, SC, ST, etc.) via a furcation kit. The loose fibers are surrounded by aramid yarns and a low smoke PVC (LSPVC) plenum-rated jacket. Its small size allows for denser fiber routing than traditional tight buffered cables; its loose-tube construction gives it superior performance and installation ease compared to ribbon interconnect cable.

## APPLICATIONS

- 10, 40, 50, 100, 200 and 400 Gb Ethernet and legacy speeds
- Data centers
- High density installations
- MTP/MPO array connectors

## FEATURES

- UL® Certified Environmental Product Declaration (EPD)
- Health Product Declaration™ (HPD™)
- Meets or exceeds ANSI/ICEA S-83-596 and GR-409-CORE requirements for interconnect cable
- Plenum (OFNP)
- Available with TeraFlex® G.657. A1 - B3 single mode and TeraFlex OM3/OM4 50 micron multimode fiber types
- Marked in feet and meters
- Designed for MTP/MPO connectors

## BENEFITS

- Contributes toward 1 LEED point under the Material and Resources credit (MRc)
- Contributes toward 1 LEED point under the MRc
- Worry-free installation and performance
- Fire-listed cables allow placement in plenum and riser spaces
- Build your network with the fiber type that you need now or for the future
- Meets commercial and government requirements for length markings
- Economical plug and play solution

## ENVIRONMENTAL SPECIFICATIONS

<b>Operation</b>	0°C to +70°C
<b>Storage/Shipping</b>	-40°C to +75°C
<b>Installation</b>	10°C to +60°C

**PART NUMBER KEY**

<b>F</b>	<b>4</b>	<b>5</b>	<b>7</b>	<b>-</b>	<b>-</b>	<b>-</b>	<b>-</b>	<b>U</b>	<b>x</b>	<b>x</b>	<b>-</b>	<b>z</b>	<b>9</b>	<b>9</b>	<b>1</b>
1	2	3	4	5	6	7	8	9	10	11	12	13	14	15	16
Fiber cable	Listing	Cable type		-	Fiber count (012, 048)			Fiber type			-	Jacket color	Package		Jacket print

Contact Customer Service for availability of non-standard offerings.

**PART NUMBERS AND PHYSICAL CHARACTERISTICS**

Part Number*	Fiber Count	Configuration	Nominal Diameter in (mm)	Nominal Weight lbs/kft (kg/km)	Maximum Compression lbf/in (N/cm)	Maximum Tensile Loading		Minimum Bend Radius		Package
						Install lbs (N)	Long Term lbs (N)	Install in (mm)	Long Term in (mm)	
P4024xxC1	24	2 x 12F Microtubes	0.15 (3.8)	8 (12)	17 (35)	80 (370)	25 (110)	3.0 (76)	1.5 (38)	Reel
F457-048Uyy-z991	48	4 x 12F Microtubes	0.25 (6.4)	24 (36)	57 (100)	300 (1,334)	90 (400)	5.0 (127)	2.5 (64)	Reel

**SINGLE MODE OPTICAL FIBER TYPES**

	TeraFlex® Bend Resistant		
	G.657.A1	G.657.A2	G.657.B3
Replace "xx" with:	K1	J1	L1
Replace "yy" with:	13	14	15
Typical Attenuation (dB/km)	0.32/0.18 (1310nm/1550nm)		
Max Attenuation (dB/km)	0.7/0.7 (1310nm/1550nm)		
Replace "z" with:	6		
Standard Jacket Colors*	Yellow		

\*Other jacket colors available upon request. See "Optical Fiber Specifications" in the "Technical Info" section for detailed fiber type specifications.

**MULTIMODE OPTICAL FIBER TYPES**

	TeraGain® 62.5/125	TeraFlex Bend Resistant Laser Optimized 50/125	
		OM3	OM4
Replace "xx" with:	6G	NG	PG
Replace "yy" with:	23	30	32
Minimum Bandwidth OFL (MHz-km)	220/500 (850/1300nm)	—	—
Minimum Bandwidth EMB (MHz-km)	—	2000 (850nm)	4700 (850nm)
Typical Attenuation (dB/km)	2.13/0.49 (850nm/1300nm)		
Max Attenuation (dB/km)	3.5/1.5 (850nm/1300nm)		
Replace "z" with:	K		
Standard Jacket Colors*	Aqua		

\*Other jacket colors available upon request. See "Optical Fiber Specifications" in the "Technical Info" section for detailed fiber type specifications.

**SUSTAINABILITY LEADERSHIP**



UL and the related logo are registered trademarks of UL LLC. Health Product Declaration, HPDC and the related logo are trademarks of Health Product Declaration Collaborative. Telcordia is a registered trademark of Ericsson Inc. USGBC and the related logo are registered trademarks of U.S. Green Building Council.

# Microarray Data Center Interconnect

OFNR/OFNP

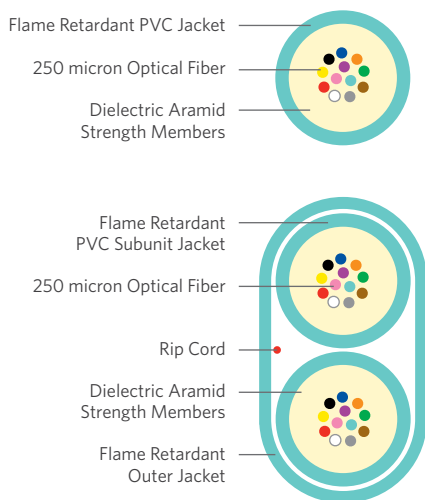
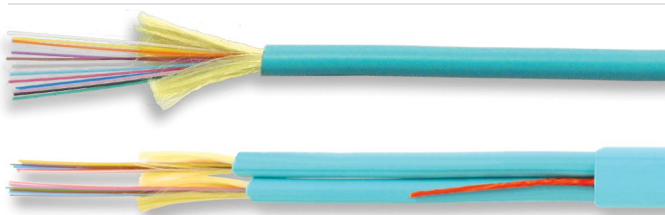

## SPECIFICATIONS

### ≤ 12-Fiber Configuration

250 micron optical fibers surrounded by dielectric aramid yarns in a 2 mm or a 3 mm loose tube

### 24-Fiber Duplex Configuration

Two 3 mm loose tubes containing twelve 250 micron optical fibers and dielectric aramid yarns; both tubes are enclosed in an overjacket

### Jacket

OFNR: Flame retardant (FR) PVC  
OFNP: FR, low smoke PVC

### Performance Compliance

UL 1651  
CSA C22.2 No. 232  
UL 1666  
NFPA 262  
Telcordia® GR-409-CORE, Issue 2  
ANSI/ICEA S-83-596  
ANSI/TIA-568.3-D

### NRTL Programs

UL, c(UL) Listed OFNR  
UL, c(UL) Listed OFNP

### Sustainability

UL Certified EPD  
HPD  
USGBC® Member  
RoHS-compliant/RoHS 2-compliant  
REACH-compliant

## PRODUCT DESCRIPTION



**FIRST MANUFACTURER IN THE INDUSTRY**  
to offer products that contribute toward LEED!

The Microarray Data Center Interconnect Cables from Superior Essex are designed for high performance in a small package. The 2-fiber through 12-fiber premises loose tube interconnect has an outside diameter of only 2 mm or 3 mm. The 24-fiber duplex contains two, 12-fiber 3 mm interconnect cables with an overjacket. The fibers can be fusion spliced, connectorized to high density MTP/MPO mechanical array connectors or attached to standard single ferrule mechanical connectors (LC, SC, ST, etc.) via a furcation kit. The loose fibers are surrounded by aramid yarns and a low smoke PVC (LSPVC) plenum or riser-rated jacket. Its small size allows for denser fiber routing than traditional tight buffered cables; its loose-tube construction gives it superior performance and installation ease compared to ribbon interconnect cable.

## APPLICATIONS

- 10, 40, 100, 200 and 400 Gb Ethernet and legacy speeds
- Data centers
- High density installations
- MTP/MPO array connectors

## FEATURES

- UL® Certified Environmental Product Declaration (EPD)
- Health Product Declaration™ (HPD™)
- 2 mm loose tube or 3 mm loose tube interconnect with two through twelve 250 micron fibers
- Meets or exceeds ANSI/ICEA S-83-596 and GR-409-CORE requirements for interconnect cable
- Plenum (OFNP) and riser (OFNR) rated designs
- Available with TeraFlex single mode, and laser-optimized 50/125 micron multimode fiber types
- Marked in feet and meters
- Designed for MTP/MPO connectors

## BENEFITS

- Contributes toward 1 LEED point under the Material and Resources credit (MRC)
- Contributes toward 1 LEED point under the MRC
- Allows for direct connection to MTP/MPO array connectors
- Worry-free installation and performance
- Fire-listed cables allow placement in plenum and riser spaces
- Build your network with the fiber type that you need now or for the future
- Meets commercial and government requirements for length markings
- Economical plug and play solution

## ENVIRONMENTAL SPECIFICATIONS

	Riser	Plenum
Operation	-20°C to +70°C	0°C to +70°C
Storage/Shipping	-40°C to +75°C	-40°C to +75°C
Installation	10°C to +60°C	10°C to +60°C

**PART NUMBERS AND PHYSICAL CHARACTERISTICS**

Listing	Part Number <sup>1</sup>	Fiber Count	Nominal Diameter in (mm)	Nominal Weight lbs/kft (kg/km)	Maximum Tensile Loading		Minimum Bend Radius		Package
					Install lbs (N)	Long Term lbs (N)	Install in (mm)	Long Term in (mm)	
OFNR	P3002xx01	2	0.12 (3.0)	5 (8)	80 (370)	25 (110)	1.8 (47)	1.2 (30)	Plywood reel
OFNR	P3004xx01	4	0.12 (3.0)	5 (8)	80 (370)	25 (110)	1.8 (47)	1.2 (30)	Plywood reel
OFNR	P3006xx01	6	0.12 (3.0)	5 (8)	80 (370)	25 (110)	1.8 (47)	1.2 (30)	Plywood reel
OFNR	P3008xx01	8	0.12 (3.0)	5 (8)	80 (370)	25 (110)	1.8 (47)	1.2 (30)	Plywood reel
OFNR	P3012xx01	12	0.12 (3.0)	5 (8)	80 (370)	25 (110)	1.8 (47)	1.2 (30)	Plywood reel
OFNR	P3024xxA1	24	0.17 x 0.29 (4.4 x 7.5)	22 (33)	150 (668)	25 (110)	6.0 (152)	3.0 (76)	Plywood reel
OFNP	V4002xx01	2	0.08 (2.0)	2.3 (3.4)	50 (220)	15 (70)	1.2 (30)	0.8 (20)	Plywood reel
OFNP	P4002xx01	2	0.12 (3.0)	6 (9)	80 (370)	25 (110)	1.8 (47)	1.2 (30)	Plywood reel
OFNP	V4004xx01	4	0.08 (2.0)	2.4 (3.6)	50 (220)	15 (70)	1.2 (30)	0.8 (20)	Plywood reel
OFNP	P4004xx01	4	0.12 (3.0)	6 (9)	80 (370)	25 (110)	1.8 (47)	1.2 (30)	Plywood reel
OFNP	V4006xx01	6	0.08 (2.0)	2.5 (3.8)	50 (220)	15 (70)	1.2 (30)	0.8 (20)	Plywood reel
OFNP	P4006xx01	6	0.12 (3.0)	6 (9)	80 (370)	25 (110)	1.8 (47)	1.2 (30)	Plywood reel
OFNP	V4008xx01	8	0.08 (2.0)	2.6 (3.9)	50 (220)	15 (70)	1.2 (30)	0.8 (20)	Plywood reel
OFNP	P4008xx01	8	0.12 (3.0)	6 (9)	80 (370)	25 (110)	1.8 (47)	1.2 (30)	Plywood reel
OFNP	V4012xx01	12	0.08 (2.0)	2.8 (4.1)	50 (220)	15 (70)	1.2 (30)	0.8 (20)	Plywood reel
OFNP	P4012xx01	12	0.12 (3.0)	6 (9)	80 (370)	25 (110)	1.8 (47)	1.2 (30)	Plywood reel
OFNP	P4024xxA1	24	0.17 x 0.29 (4.4 x 7.5)	25 (37)	150 (668)	25 (110)	6.0 (152)	3.0 (76)	Plywood reel

**SINGLE MODE OPTICAL FIBER TYPES**

	TeraFlex® Bend Resistant		
	G.657.A1	G.657.A2	G.657.B3
<sup>1</sup> Replace "xx" with:	K1	J1	L1
Standard Jacket Colors*	Yellow		

**MULTIMODE OPTICAL FIBER TYPES**

	TeraFlex Bend Resistant Laser Optimized 50/125	
	10G/300	10G/550
<sup>1</sup> Replace "xx" with:	NG	PG
Standard Jacket Colors*	Aqua	

\*Other jacket colors available upon request. See "Optical Fiber Specifications" in the "Technical Info" section for detailed fiber type specifications.

**SUSTAINABILITY LEADERSHIP**



UL and the related logo are registered trademarks of UL LLC. Health Product Declaration, HPD and the related logo are trademarks of Health Product Declaration Collaborative. Telcordia is a registered trademark of Ericsson Inc. USGBC and the related logo are registered trademarks of U.S. Green Building Council.

# 2 mm Microarray Breakout

OFNP

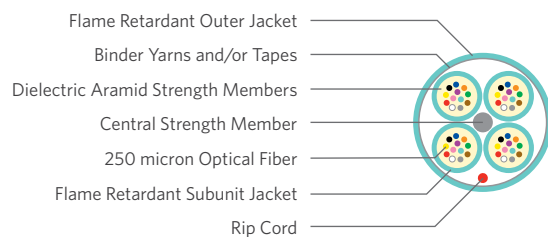

## SPECIFICATIONS

Subunit Configuration	2 mm Simplex loose tube cable with eight or twelve 250 micron optical fibers surrounded by dielectric aramid strength members
Cable Configuration	2 mm loose tube subunits around a central strength member and surrounded by polyester yarns and an outer jacket
Subunit Marking	Unit 1, Unit 2, Unit 3, Unit 4...
Central Strength Element	Glass Reinforced Plastic (GRP)
Subunit/Outer Jacket	Flame retardant, thermoplastic
Performance Compliance	UL 1651 CSA C22.2 No. 232 NFPA 262 ANSI/ICEA S-83-596 ANSI/TIA-568.3-D
NRTL Programs	UL, c(UL) Listed OFNP
Sustainability	UL Certified EPD HPD USGBC® Member RoHS-compliant/RoHS 2-compliant REACH-compliant

## ENVIRONMENTAL SPECIFICATIONS

Operation	0°C to +70°C
Storage/Shipping	-40°C to +75°C
Installation	10°C to +60°C

## PRODUCT DESCRIPTION



**FIRST MANUFACTURER IN THE INDUSTRY**  
to offer products that contribute toward LEED!

The 2 mm Microarray Breakout cable from Superior Essex is designed for high performance in a small package. The premises loose tube design consists of 8 or 12-fiber 2 mm microarray interconnect cable subunits, each of which contain twelve 250 micron fibers. The aramid yarns inside the subunit allow the subunit to be crimped directly onto an MTP®/MPO connector. The 2 mm subunits are stranded around a central strength element that is both flexible and robust enough to pass backbone installation requirements. The stranded subunits are held to the strength element core by binder yarns and/or tapes ensuring excellent temperature performance. Finally, a RoHS-compliant flexible jacket protects the core from the rigors of installation while providing plenum fire protection. The cable is available with TeraFlex® single mode, and TeraFlex laser-optimized 50/125 micron 10G/150 (OM2+), 10G/300 (OM3) and 10G/550 (OM4) multimode fiber types.

## APPLICATIONS

- 10 Gb, 40 Gb, 100 Gb Ethernet and legacy speeds
- Data centers
- Trunk applications
- High density installations
- MTP/MPO array connectors
- Outside plant (OSP) to premises transitions

## FEATURES

- UL® Certified Environmental Product Declaration (EPD)
- Health Product Declaration™ (HPD™)
- 8 or 12-fiber 2 mm loose tube interconnect subunits
- Meets or exceeds ICEA 83-596-2001 and GR-409-CORE requirements for interconnect subunits and trunk cable
- Plenum (OFNP) rated design
- Available with TeraFlex single mode, and TeraFlex laser-optimized 50/125 micron multimode fiber types

## BENEFITS

- Contributes toward 1 LEED point under the Material and Resources credit (MRc)
- Contributes toward 1 LEED point under the MRC
- Connects directly to MTP/MPO 12-fiber array connectors
- Worry-free installation and performance
- Meets NEC requirements
- Build your network with the fiber type that you need now or for the future



**PART NUMBER KEY**

<b>F</b>	<b>4</b>	<b>4</b>	<b>7</b>	<b>-</b>	<b>-</b>	<b>-</b>	<b>-</b>	<b>U</b>	<b>x</b>	<b>x</b>	<b>-</b>	<b>K</b>	<b>9</b>	<b>9</b>	<b>1</b>
1	2	3	4	5	6	7	8	9	10	11	12	13	14	15	16
Fiber cable	Listing	Cable type		-	Fiber count (024-096)			Fiber type			-	Jacket color	Package		Jacket print

Contact Customer Service for availability of non-standard offerings.

**PART NUMBERS AND PHYSICAL CHARACTERISTICS**

Listing	Part Number <sup>1</sup>	Fiber Count	Cable Configuration	Nominal Diameter in (mm)	Nominal Weight lbs/kft (kg/km)	Maximum Tensile Loading		Minimum Bend Radius		Package
						Install lbs (N)	Long Term lbs (N)	Install in (mm)	Long Term in (mm)	
<b>BASE-8</b>										
OFNP	F447-024Uxx-t991	24	4-around-1	0.26 (6.5)	29 (43)	150 (710)	45 (198)	3.8 (98)	2.6 (65)	Plywood Reel
OFNP	F447-032Uxx-t991	32	4-around-1	0.26 (6.5)	29 (43)	150 (710)	45 (198)	3.8 (98)	2.6 (65)	Plywood Reel
OFNP	F447-048Uxx-t991	48	6-around-1	0.31 (7.9)	29 (43)	300 (1,420)	90 (396)	3.8 (98)	2.6 (65)	Plywood Reel
OFNP	F447-064Uxx-t991	64	8-around-1	0.36 (9.2)	44 (66)	300 (1,420)	90 (396)	5.4 (138)	3.6 (92)	Plywood Reel
OFNP	F447-096Uxx-t991	96	12-around-1	0.47 (12.0)	101 (152)	300 (1,420)	90 (396)	7.0 (180)	4.7 (120)	Plywood Reel
<b>BASE-12</b>										
OFNP	V4024zzB1	24	4-around-1	0.26 (6.5)	29 (43)	150 (660)	45 (200)	3.8 (98)	2.6 (65)	Plywood reel
OFNP	V4036zzB1	36	4-around-1	0.26 (6.5)	29 (43)	150 (660)	45 (200)	3.8 (98)	2.6 (65)	Plywood reel
OFNP	V4048zz01	48	4-around-1	0.26 (6.5)	29 (43)	150 (660)	45 (200)	3.8 (98)	2.6 (65)	Plywood reel
OFNP	V4072zz01	72	6-around-1	0.31 (7.9)	32 (47)	300 (1,334)	90 (400)	4.7 (119)	3.1 (79)	Plywood reel
OFNP	V4096zz01	96	8-around-1	0.36 (9.2)	44 (66)	300 (1,334)	90 (400)	5.4 (138)	3.6 (92)	Plywood reel
OFNP	V4144zz01	144	12-around-1	0.47 (12.0)	101 (152)	300 (1,334)	90 (400)	7.0 (180)	4.7 (120)	Plywood reel

**SINGLE MODE OPTICAL FIBER TYPES**

	TeraFlex® Bend Resistant		
	G.657.A1	G.657.A2	G.657.B3
<sup>1</sup> Replace "xx" with:	13	14	15
<sup>1</sup> Replace "zz" with:	K1	J1	L1
Standard Jacket Colors*	Yellow (t = 6)		

**MULTIMODE OPTICAL FIBER TYPES**

	TeraFlex Bend Resistant Laser Optimized 50/125	
	OM3	OM4
<sup>1</sup> Replace "xx" with:	30	32
<sup>1</sup> Replace "zz" with:	NG	PG
Standard Jacket Colors*	Aqua (t = K)	

\*Other jacket colors available upon request. See "Optical Fiber Specifications" in the "Technical Info" section for detailed fiber type specifications.

MTP is a registered trademark of US Conec Ltd. UL is a registered trademark of UL LLC. Health Product Declaration and HPD are trademarks of Health Product Declaration Collaborative. Telcordia is a registered trademark of Ericsson Inc. USGBC is a registered trademark of U.S. Green Building Council.

# Interlock Armored, 2 mm Microarray Breakout

OFCP

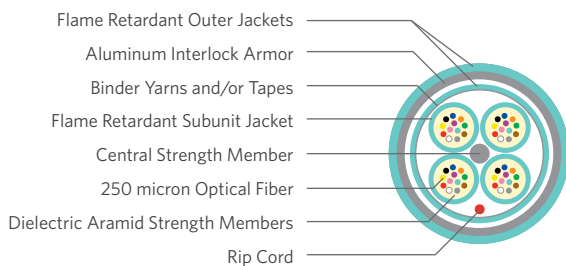

## PRODUCT DESCRIPTION



**FIRST MANUFACTURER IN THE INDUSTRY**  
to offer products that contribute toward LEED!

The Interlock Armored Microarray Breakout cable from Superior Essex is designed for high performance with robust mechanical protection. The premises loose tube design consists of 12-fiber 2 mm microarray interconnect cable subunits, each of which contain twelve 250 micron fibers. The aramid yarns inside the subunit allow the subunit to be crimped directly onto an MTP®/MPO connector. The 2 mm subunits are stranded around a central strength element that is both flexible and robust enough to pass backbone installation requirements. The stranded subunits are held to the strength element core by binder yarns and/or tapes ensuring excellent temperature performance. A RoHS-compliant flexible jacket protects the core while providing fire protection. Finally, the cable is interlock armored with aluminum and jacketed.

## SPECIFICATIONS

<b>Subunit Configuration</b>	2 mm simplex loose tube cable with twelve 250 micron optical fibers surrounded by dielectric aramid strength members
<b>Cable Configuration</b>	2 mm loose tube subunits around a central strength member and surrounded by polyester yarns and an outer jacket
<b>Subunit Marking</b>	Unit 1, Unit 2, Unit 3, Unit 4
<b>Central Strength Element</b>	Glass Reinforced Plastic (GRP) covered with a PVC jacket
<b>Subunit/Cable/Outer Jacket</b>	Flame retardant (FR), LSPVC
<b>Armor</b>	Flexible, heavy duty interlocking aluminum tape helically applied over the inner cable core; further protection is provided by a FR outer jacket
<b>Performance Compliance</b>	UL 1651 CSA C22.2 No. 232 UL 910 NFPA 262 Telcordia® GR-409-CORE, Issue 2 ANSI/ICEA S-83-596 ANSI/TIA-568.3-D
<b>NRTL Programs</b>	UL, c(UL) Listed OFCP
<b>Sustainability</b>	UL Certified EPD HPD USGBC® Member RoHS-compliant/RoHS 2-compliant REACH-compliant

## ENVIRONMENTAL SPECIFICATIONS

<b>Operation</b>	0°C to +70°C
<b>Storage/Shipping</b>	-40°C to +70°C
<b>Installation</b>	10°C to +60°C

## PART NUMBERS AND PHYSICAL CHARACTERISTICS

Part Number <sup>1</sup>	Fiber Count	Nominal Diameter in (mm)	Nominal Weight lbs/kft (kg/km)	Maximum Tensile Loading		Minimum Bend Radius		Package
				Install lbs (N)	Long Term lbs (N)	Install in (mm)	Long Term in (mm)	
L4024xVB1	24	0.56 (14.2)	117 (174)	150 (660)	45 (200)	8.4 (212)	5.6 (142)	Reel
L4036xVB1	36	0.56 (14.2)	117 (174)	150 (660)	45 (200)	8.4 (212)	5.6 (142)	Reel
L4048xV01	48	0.56 (14.2)	117 (174)	150 (660)	45 (200)	8.4 (212)	5.6 (142)	Reel
L4072xV01	72	0.60 (15.3)	147 (220)	300 (1,320)	90 (400)	9.0 (230)	6.0 (153)	Reel
L4096xV01	96	0.69 (17.4)	178 (266)	300 (1,320)	90 (400)	10.3 (261)	6.9 (174)	Reel
L4144xV01	144	0.78 (19.7)	245 (365)	300 (1,320)	90 (400)	11.6 (294)	7.8 (197)	Reel

## SINGLE MODE OPTICAL FIBER TYPES

	TeraFlex® Bend Resistant		
	G.657.A1	G.657.A2	G.657.B3
<sup>1</sup> Replace "x" with:	K	J	L
Standard Jacket Colors*		Yellow	

## MULTIMODE OPTICAL FIBER TYPES

	TeraFlex Bend Resistant Laser Optimized 50/125	
	10G/300	10G/550
<sup>1</sup> Replace "x" with:	N	P
Standard Jacket Colors*		Aqua

\*Other jacket colors available upon request. See "Optical Fiber Specifications" in the "Technical Info" section for detailed fiber type specifications. MTP is a registered trademark of US Conec Ltd. UL is a registered trademark of UL LLC. Health Product Declaration and HPD are trademarks of Health Product Declaration Collaborative. Telcordia is a registered trademark of Ericsson Inc. USGBC is a registered trademark of U.S. Green Building Council.



All information, content, data, specifications, packaging and part numbers detailed herein are subject to change. For the most up-to-date information, please visit [SuperiorEssexCommunications.com](http://SuperiorEssexCommunications.com). Purchase of this product is subject exclusively to the then current **Superior Essex International LP Terms and Conditions of Sale for Communications Cable, Wire and Connectivity Products**, which can be found on our website, [SuperiorEssexCommunications.com](http://SuperiorEssexCommunications.com), or provided to you upon request.

800.551.8948  
[SuperiorEssexCommunications.com](http://SuperiorEssexCommunications.com)



# 3 mm Microarray Breakout

OFNR/OFNP

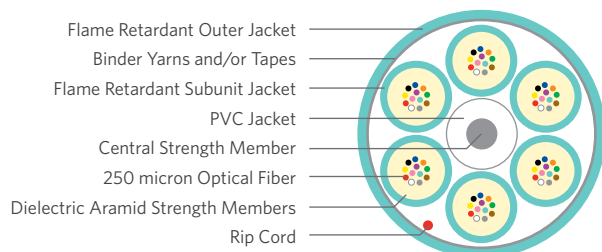
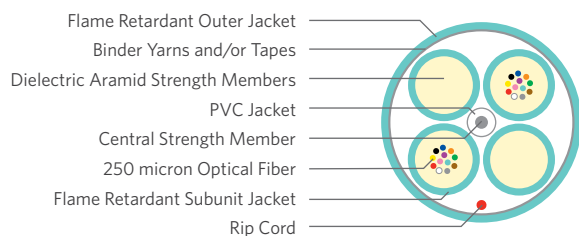
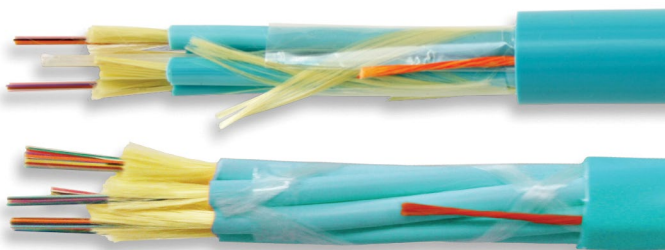

## SPECIFICATIONS

Subunit Configuration	3 mm Simplex loose tube cable with eight or twelve 250 micron optical fibers surrounded by dielectric aramid strength members
Cable Configuration	3 mm loose tube subunits around a central strength member and surrounded by polyester yarns and an outer jacket
Subunit Marking	Unit 1, Unit 2, Unit 3, Unit 4...
Central Strength Element	Glass Reinforced Plastic (GRP) covered with a PVC jacket
Subunit/Outer Jacket	OFNR: Flame retardant (FR) PVC OFNP: FR, low smoke PVC
Performance Compliance	UL 1651 CSA C22.2 No. 232 UL 1666 NFPA 262 Telcordia® GR-409-CORE, Issue 2 ANSI/ICEA S-83-596 ANSI/TIA-568.3-D
NRTL Programs	UL, c(UL) Listed OFNR UL, c(UL) Listed OFNP
Sustainability	UL Certified EPD HPD USGBC® Member RoHS-compliant/RoHS 2-compliant REACH-compliant

## ENVIRONMENTAL SPECIFICATIONS

	Riser	Plenum
Operation	-20°C to +70°C	0°C to +70°C
Storage/Shipping	-40°C to +75°C	-40°C to +75°C
Installation	10°C to +60°C	10°C to +60°C

## PRODUCT DESCRIPTION



**FIRST MANUFACTURER IN THE INDUSTRY**  
to offer products that contribute toward LEED!

The 3 mm Microarray Breakout cable from Superior Essex is designed for high performance in a small package. The premises loose tube design consists of 3 mm microarray interconnect cable subunits, each of which contain either eight or twelve 250 micron fibers. The aramid yarns inside the subunit allow the subunit to be crimped directly onto an MTP®/MPO connector. The 3 mm subunits are stranded around a central strength element that is both flexible and robust enough to pass backbone installation requirements. The stranded subunits are held to the strength element core by binder yarns and/or tapes ensuring excellent temperature performance. Finally, a RoHS-compliant flexible jacket protects the core from the rigors of installation while providing riser or plenum fire protection. The cable is available with TeraFlex® single mode, and laser-optimized 50/125 micron 10G/150 (OM2+), 10G/300 (OM3) and 10G/550 (OM4) multimode fiber types.

## APPLICATIONS

- 10 Gb, 40 Gb, 100 Gb Ethernet and legacy speeds
- Data centers
- Trunk applications
- High density installations
- MTP/MPO array connectors
- Outside plant (OSP) to premises transitions

## FEATURES

- UL® Certified Environmental Product Declaration (EPD)
- Health Product Declaration™ (HPD™)
- 8 or 12-fiber 3 mm loose tube interconnect subunits
- Meets or exceeds ICEA 83-596-2001 and GR-409-CORE requirements for interconnect subunits and trunk cable
- Plenum (OFNP) and riser (OFNR) rated designs
- Available with TeraFlex single mode, and laser-optimized 50/125 micron multimode fiber types

## BENEFITS

- Contributes toward 1 LEED point under the Material and Resources credit (MRc)
- Contributes toward 1 LEED point under the MRc
- Connects directly to MTP/MPO 12-fiber array connectors
- Worry-free installation and performance
- UL listed cables meet NEC requirements
- Build your network with the fiber type that you need now or for the future

## SUSTAINABILITY LEADERSHIP



UL and the related logo are registered trademarks of UL LLC. Health Product Declaration, HPD and the related logo are trademarks of Health Product Declaration Collaborative. Telcordia is a registered trademark of Ericsson Inc. USGBC and the related logo are registered trademarks of U.S. Green Building Council.

**PART NUMBERS AND PHYSICAL CHARACTERISTICS**

Listing	Part Number <sup>1</sup>	Fiber Count	Cable Configuration	Nominal Diameter in (mm)	Nominal Weight lbs/kft (kg/km)	Maximum Tensile Loading		Minimum Bend Radius		Package
						Install lbs (N)	Long Term lbs (N)	Install in (mm)	Long Term in (mm)	
<b>8 Fibers Per Tube (BASE-8)</b>										
OFNR	F349-024Uxx-t991	24	4-around-1	0.42 (10.8)	60 (90)	150 (710)	45 (198)	7.0 (180)	3.5 (90)	Plywood Reel
OFNR	F349-032Uxx-t991	32	4-around-1	0.42 (10.8)	60 (90)	150 (710)	45 (198)	7.0 (180)	3.5 (90)	Plywood Reel
OFNR	F349-048Uxx-t991	48	6-around-1	0.50 (12.6)	89 (133)	150 (710)	45 (198)	10.0 (252)	5.0 (126)	Plywood Reel
OFNR	F349-064Uxx-t991	64	8-around-1	0.57 (14.5)	121 (180)	300 (1,420)	90 (396)	11.4 (290)	6.0 (152)	Plywood Reel
OFNR	F349-096Uxx-t991	96	12-around-1	0.69 (17.6)	198 (295)	300 (1,420)	90 (396)	13.8 (350)	6.9 (175)	Plywood Reel
OFNP	F449-024Uxx-t991	24	4-around-1	0.35 (8.8)	54 (81)	150 (710)	45 (198)	5.2 (132)	3.5 (88)	Plywood Reel
OFNP	F449-032Uxx-t991	32	4-around-1	0.35 (8.8)	54 (81)	150 (710)	45 (198)	5.2 (132)	3.5 (88)	Plywood Reel
OFNP	F449-048Uxx-t991	48	6-around-1	0.43 (10.9)	81 (120)	150 (710)	45 (198)	6.5 (164)	4.3 (109)	Plywood Reel
OFNP	F449-064Uxx-t991	64	8-around-1	0.51 (13.0)	121 (180)	300 (1,420)	90 (396)	11.4 (290)	6.0 (152)	Plywood Reel
OFNP	F449-096Uxx-t991	96	12-around-1	0.69 (17.6)	227 (336)	300 (1,420)	90 (396)	13.8 (350)	6.9 (175)	Plywood Reel
<b>12 Fibers Per Tube (BASE-12)</b>										
OFNR	P3024zzB1	24	4-around-1	0.42 (10.8)	60 (90)	150 (710)	45 (198)	7.0 (180)	3.5 (90)	Plywood reel
OFNR	P3036zzB1	36	4-around-1	0.42 (10.8)	60 (90)	150 (710)	45 (198)	7.0 (180)	3.5 (90)	Plywood reel
OFNR	P3048zz01	48	4-around-1	0.42 (10.8)	61 (91)	150 (710)	45 (198)	8.2 (210)	4.1 (105)	Plywood reel
OFNR	P3072zz01	72	6-around-1	0.50 (12.6)	89 (133)	150 (710)	45 (198)	10.0 (252)	5.0 (126)	Plywood reel
OFNR	P3096zz01	96	8-around-1	0.57 (14.5)	121 (180)	300 (1,420)	90 (396)	11.4 (290)	6.0 (152)	Plywood reel
OFNR	P3144zz01	144	12-around-1	0.69 (17.6)	198 (295)	300 (1,420)	90 (396)	13.8 (350)	6.9 (175)	Plywood reel
OFNP	P4024zzB1	24	4-around-1	0.35 (8.8)	54 (81)	150 (710)	45 (198)	5.2 (132)	3.5 (88)	Plywood reel
OFNP	P4036zzB1	36	4-around-1	0.35 (8.8)	54 (81)	150 (710)	45 (198)	5.2 (132)	3.5 (88)	Plywood reel
OFNP	P4048zz01	48	4-around-1	0.35 (8.8)	55 (82)	150 (710)	45 (198)	5.2 (132)	3.5 (88)	Plywood reel
OFNP	P4072zz01	72	6-around-1	0.43 (10.9)	81 (120)	150 (710)	45 (198)	6.5 (164)	4.3 (109)	Plywood reel
OFNP	P4096zz01	96	8-around-1	0.51 (13.0)	121 (180)	300 (1,420)	90 (396)	11.4 (290)	6.0 (152)	Plywood reel
OFNP	P4144zz01	144	12-around-1	0.69 (17.6)	227 (336)	300 (1,420)	90 (396)	13.8 (350)	6.9 (175)	Plywood reel

SINGLE MODE OPTICAL FIBER TYPES			
TeraFlex® Bend Resistant			
	G.657.A1	G.657.A2	G.657.B3
<sup>1</sup> Replace "xx" with:	13	14	15
<sup>1</sup> Replace "zz" with:	K1	J1	L1
Standard Jacket Colors*	Yellow (t = 6)		

MULTIMODE OPTICAL FIBER TYPES		
TeraFlex Bend Resistant Laser Optimized 50/125		
	OM3	OM4
<sup>1</sup> Replace "xx" with:	30	32
<sup>1</sup> Replace "zz" with:	NG	PG
Standard Jacket Colors*	Aqua (t = K)	

<sup>1</sup>Other jacket colors available upon request.  
See "Optical Fiber Specifications" in the "Technical Info" section for detailed fiber type specifications.

# Interlock Armored, 3 mm Microarray Breakout

OFCR/OFCP

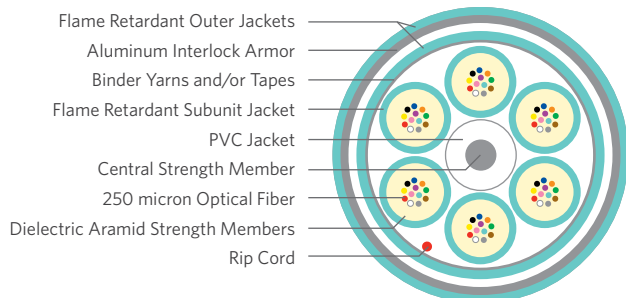

## PRODUCT DESCRIPTION



**FIRST MANUFACTURER IN THE INDUSTRY**  
to offer products that contribute toward LEED!

The Interlock Armored Microarray Breakout cable from Superior Essex is designed for high performance with robust mechanical protection. The premises loose tube design consists of 12-fiber 3 mm microarray interconnect cable subunits, each of which contain twelve 250 micron fibers. The aramid yarns inside the subunit allow the subunit to be crimped directly onto an MTP®/MPO connector. The 3 mm subunits are stranded around a central strength element that is both flexible and robust enough to pass backbone installation requirements. The stranded subunits are held to the strength element core by binder yarns and/or tapes ensuring excellent temperature performance. A RoHS-compliant flexible jacket protects the core while providing fire protection. Finally, the cable is interlock armored with aluminum and jacketed. The cable is available with TeraFlex® single mode or laser-optimized 50/125 micron 10G/150 (OM2+), 10G/300 (OM3) or 10G/550 (OM4) multimode fiber types.

## APPLICATIONS

- 10 Gb, 40 Gb, 100 Gb Ethernet and legacy speeds
- Data centers
- Trunk applications
- High density installations
- MTP/MPO array connectors
- Outside plant (OSP) to premises transitions

## FEATURES

- UL® Certified Environmental Product Declaration (EPD)
- Health Product Declaration™ (HPD™)
- 12-fiber 3 mm loose tube interconnect subunits
- Meets or exceeds ICEA 83-596-2001 and GR-409-CORE requirements for interconnect subunits and trunk cable
- Interlock armor
- Riser (OFCR) and plenum (OFCP) rated designs
- Available with TeraFlex single mode and TeraFlex laser-optimized 50/125 micron multimode bend-insensitive fiber types

## BENEFITS

- Contributes toward 1 LEED point under the Material and Resources credit (MRC)
- Contributes toward 1 LEED point under the MRC
- Connects directly to MTP/MPO 12-fiber array connectors
- Worry-free installation and performance
- Provides exceptional mechanical protection and crush resistance
- UL listed cables meet NEC requirements
- Build your network with the fiber type that you need now or for the future

## SPECIFICATIONS

Subunit Configuration	3 mm simplex loose tube cable with twelve 250 micron optical fibers surrounded by dielectric aramid strength members
Cable Configuration	3 mm loose tube subunits around a central strength member and surrounded by polyester yarns and an outer jacket
Subunit Marking	Unit 1, Unit 2, Unit 3, Unit 4...
Central Strength Element	Glass Reinforced Plastic (GRP) covered with a PVC jacket
Subunit/Cable/Outer Jacket	OFCR: Flame retardant (FR), PVC OFCP: FR, LSPVC
Armor	Flexible, heavy duty interlocking aluminum tape helically applied over the inner cable core; further protection is provided by a flame retardant outer jacket
Performance Compliance	UL 1651 CSA C22.2 No. 232 UL 1666 UL 910 NFPA 262 Telcordia® GR-409-CORE, Issue 2 ANSI/ICEA S-83-596 ANSI/TIA-568.D-3
NRTL Programs	UL, c(UL) Listed OFCR UL, c(UL) Listed OFCP
Sustainability	UL Certified EPD HPD USGBC® Member RoHS-compliant/RoHS 2-compliant REACH-compliant

## ENVIRONMENTAL SPECIFICATIONS

	Riser	Plenum
Operation	-20°C to +70°C	0°C to +70°C
Storage/Shipping	-40°C to +75°C	-40°C to +70°C
Installation	10°C to +60°C	10°C to +60°C

## SUSTAINABILITY LEADERSHIP



UL and the related logo are registered trademarks of UL LLC. Health Product Declaration, HPD and the related logo are trademarks of Health Product Declaration Collaborative. Telcordia is a registered trademark of Ericsson Inc. USGBC and the related logo are registered trademarks of U.S. Green Building Council.

**PART NUMBERS AND PHYSICAL CHARACTERISTICS**

Listing	Part Number <sup>1</sup>	Fiber Count	Nominal Diameter in (mm)	Nominal Weight lbs/kft (kg/km)	Maximum Tensile Loading		Minimum Bend Radius		Package
					Install lbs (N)	Long Term lbs (N)	Install in (mm)	Long Term in (mm)	
OFCR	L3024xPB1	24	0.77 (19.6)	195 (291)	150 (670)	50 (200)	11.6 (294)	7.7 (196)	Reel
OFCR	L3036xPB1	36	0.77 (19.6)	195 (291)	150 (670)	50 (200)	11.6 (294)	7.7 (196)	Reel
OFCR	L3048xP01	48	0.77 (19.6)	196 (293)	150 (670)	50 (200)	11.6 (294)	7.7 (196)	Reel
OFCR	L3072xP01	72	0.87 (22.0)	248 (370)	150 (670)	50 (200)	13.0 (330)	8.7 (220)	Reel
OFCR	L3096xP01	96	0.95 (24.2)	290 (432)	300 (1,340)	90 (400)	14.3 (363)	9.5 (242)	Reel
OFCR	L3144xP01	144	1.08 (27.4)	424 (632)	300 (1,340)	90 (400)	16.2 (411)	10.8 (274)	Reel
OFCP	L4024xPB1	24	0.77 (19.6)	195 (291)	150 (670)	50 (200)	11.6 (294)	7.7 (196)	Reel
OFCP	L4036xPB1	36	0.77 (19.6)	195 (291)	150 (670)	50 (200)	11.6 (294)	7.7 (196)	Reel
OFCP	L4048xP01	48	0.77 (19.6)	196 (293)	150 (670)	50 (200)	11.6 (294)	7.7 (196)	Reel
OFCP	L4072xP01	72	0.87 (22.0)	248 (370)	150 (670)	50 (200)	13.0 (330)	8.7 (220)	Reel
OFCP	L4096xP01	96	0.95 (24.2)	290 (432)	300 (1,340)	90 (400)	14.3 (363)	9.5 (242)	Reel
OFCP	L4144xP01	144	1.08 (27.4)	424 (632)	300 (1,340)	90 (400)	16.2 (411)	10.8 (274)	Reel

**SINGLE MODE OPTICAL FIBER TYPES**

	TeraFlex® Bend Resistant		
	G.657.A1	G.657.A2	G.657.B3
<sup>1</sup> Replace "x" with:	K	J	L
Standard Jacket Colors*	Yellow		

\*Other jacket colors available upon request.  
See "Optical Fiber Specifications" in the "Technical Info" section for detailed fiber type specifications.

**MULTIMODE OPTICAL FIBER TYPES**

	TeraFlex Bend Resistant Laser Optimized 50/125	
	10G/300	10G/550
<sup>1</sup> Replace "x" with:	N	P
Standard Jacket Colors*	Aqua	

# EnduraLite® Indoor/Outdoor, Loose Tube

OFNR/OFNP

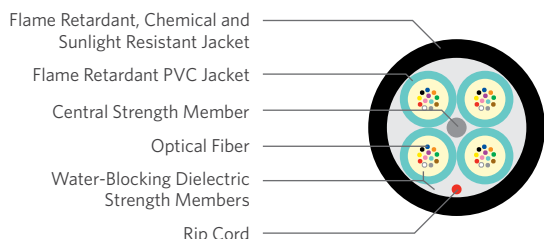
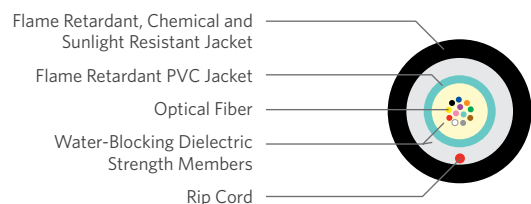

## SPECIFICATIONS

<b>2 - 12 Fiber Single Unit Configuration</b>	3 mm central subunit surrounded by additional water-blocking glass yarns and an outer jacket
<b>24-48 Fiber Multi-Unit Configuration</b>	3mm subunits stranded around a central strength element and surrounded by water blocking glass yarns, a ripcord and an outer jacket
<b>Subunit Configuration</b>	3mm subunits containing 2 to 12, 250 $\mu$ m fibers and water blocking aramid yarns surrounded by a flame retardant PVC jacket
<b>Subunit Strength Elements</b>	Water-blocking aramid yarns
<b>Subunit Jacket</b>	Flame retardant (FR) PVC
<b>Strength Elements</b>	Water-blocking glass yarns and/or glass reinforced plastic rod
<b>Outer Jacket</b>	Riser: Black, FR, chemical and sunlight resistant PVC Plenum: Black, FR, chemical and sunlight resistant fluoropolymer
<b>Performance Compliance</b>	UL 1651 CSA C22.2 No. 232 UL 1666 NFPA 130 (Plenum) NFPA 262 ANSI/ICEA S-83-596 ANSI/ICEA S-104-696 ANSI/TIA-568.3-D RoHS-compliant
<b>NRTL Programs</b>	UL, c(UL) Listed OFNR/OFNP UL, c(UL) Listed Sunlight Resistant

## ENVIRONMENTAL SPECIFICATIONS

<b>Operation</b>	-40°C to +75°C
<b>Storage/Shipping</b>	-40°C to +75°C
<b>Installation</b>	0°C to +65°C

## PRODUCT DESCRIPTION

EnduraLite® Dry Block, Sunlight Resistant Indoor/Outdoor Loose Tube riser and plenum rated cable lines offer the system designer the smallest form factor in a premises indoor/outdoor optical fiber cable. The cables can be installed in open spaces, trays, conduits, inner-ducts, trenches, steam tunnels and building riser or plenum locations. The cables incorporate the latest in dry water-blocking technology which eliminates the need to clean off the traditional gel-based water-blocking compounds. In the single unit design, a 3 mm central tube contains 2-to 12, 250  $\mu$ m fibers and water-blocking aramid yarns. In the multi-unit design, the waterblocked 3mm subunits are stranded around a central strength element. The tube or core is surrounded by additional water-blocking glass strength elements and an outer jacket, comprised of a rugged UL Listed, sunlight resistant, black polymer that allows for the cable to be exposed to long-term direct sunlight without the concern of material degradation. All fiber types are available, including 50/125  $\mu$ m, 62.5/125  $\mu$ m and single mode.

## APPLICATIONS

- Intra/inter-building backbones, such as conduit pathways or tunnels
- Conduit/duct/tray pathways
- Dry or wet locations

## FEATURES

- Exceeds ANSI/TIA-568.3-D optical performance
- Dry-block design meets Telcordia ANSI/ICEA S-104-696 water-block requirements
- 3 mm subunit
- UL/NEC Listed OFNR/OFNP
- All dielectric
- Jacket rip cord
- Black, UL Listed sunlight resistant outer jacket
- BrakeBox® payout control system
- Tube color indicates fiber type

## BENEFITS

- Future-proof fiber performance for current and future multi-gigabit applications
- Cable integrity maintained even if damage occurs to protective layers
- Attaches directly to MTP® or MPO mechanical connectors
- Eliminates the need to purchase separate cables for OSP and indoor/riser or plenum applications
- No additional grounding materials need to be purchased
- Saves time in cable preparation
- Long periods of direct sunlight exposure will not damage cable
- Adjustable tension control on reel prevents over spin and entangling of cable
- Quickly identifies the fiber type without searching for the jacket print



**PART NUMBER KEY**

<b>F</b>	<b>3 or 4</b>	<b>6</b>	<b>0</b>	<b>-</b>	<b>-</b>	<b>-</b>	<b>-</b>	<b>U</b>	<b>x</b>	<b>x</b>	<b>-</b>	<b>E</b>	<b>y</b>	<b>y</b>	<b>1</b>
1	2	3	4	5	6	7	8	9	10	11	12	13	14	15	16
Fiber cable	Listing	Cable type			Fiber count (002-012)			Fiber type			Jacket color	Package		Jacket print	

Contact Customer Service for availability of non-standard offerings.

**PART NUMBERS AND PHYSICAL CHARACTERISTICS**

Listing	Part Number <sup>1</sup>	Fiber Count	Nominal Diameter in (mm)	Nominal Weight lbs/kft (kg/km)	Maximum Tensile Loading		Minimum Bend Radius		Package <sup>1</sup>
					Install lbs (N)	Long Term lbs (N)	Install in (mm)	Long Term in (mm)	
OFNR	F360-002Uxx-Eyy1	2	0.24 (6.1)	22 (32)	300 (1,340)	90 (400)	3.6 (88)	2.4 (60)	use key
OFNR	F360-004Uxx-Eyy1	4	0.24 (6.1)	23 (34)	300 (1,340)	90 (400)	3.6 (88)	2.4 (60)	use key
OFNR	F360-006Uxx-Eyy1	6	0.24 (6.1)	23 (34)	300 (1,340)	90 (400)	3.6 (88)	2.4 (60)	use key
OFNR	F360-008Uxx-Eyy1	8	0.24 (6.1)	23 (34)	300 (1,340)	90 (400)	3.6 (88)	2.4 (60)	use key
OFNR	F360-012Uxx-Eyy1	12	0.24 (6.1)	23 (34)	300 (1,340)	90 (400)	3.6 (88)	2.4 (60)	use key
OFNP	F460-002Uxx-Eyy1	2	0.23 (5.8)	27 (41)	300 (1,340)	90 (400)	3.5 (87)	2.3 (58)	use key
OFNP	F460-004Uxx-Eyy1	4	0.23 (5.8)	28 (42)	300 (1,340)	90 (400)	3.5 (87)	2.3 (58)	use key
OFNP	F460-006Uxx-Eyy1	6	0.23 (5.8)	28 (42)	300 (1,340)	90 (400)	3.5 (87)	2.3 (58)	use key
OFNP	F460-008Uxx-Eyy1	8	0.23 (5.8)	28 (42)	300 (1,340)	90 (400)	3.5 (87)	2.3 (58)	use key
OFNP	F460-012Uxx-Eyy1	12	0.23 (5.8)	28 (42)	300 (1,340)	90 (400)	3.5 (87)	2.3 (58)	use key
OFNP	F462-024Uxx-Eyy1	24	0.39 (10.0)	109 (62)	600 (2700)	180 (800)	5.9 (145)	3.9 (96)	Plywood
OFNP	F462-036Uxx-Eyy1	36	0.39 (10.0)	109 (62)	600 (2700)	180 (800)	5.9 (145)	3.9 (96)	Plywood
OFNP	F462-048Uxx-Eyy1	48	0.39 (10.0)	109 (62)	600 (2700)	180 (800)	5.9 (145)	3.9 (96)	Plywood

**FIBER TYPES / JACKET COLOR:**

<sup>1</sup> Replace "xx" with: Indoor/Outdoor Jacket Color
--

**SINGLE MODE**

TeraFlex® Bend Resistant		
G.657.A1	G.657.A2	G.657.B3
13	14	15
Black		

**MULTIMODE**

TeraGain® 62.5/125	TeraFlex Bend Resistant Laser Optimized 50/125	
	10G/300	10G/550
23	30	32
Black		

See "Optical Fiber Specifications" in the "Technical Information" section for detailed fiber type specifications.

**PACKAGING:**

	Cut to Length Plywood Reel	1,000 ft BrakeBox®
<sup>1</sup> Replace "yy" with:	99	A5

# EnduraLite® Indoor/Outdoor, Loose Tube, Interlock Armored

## OFCR/OFCP

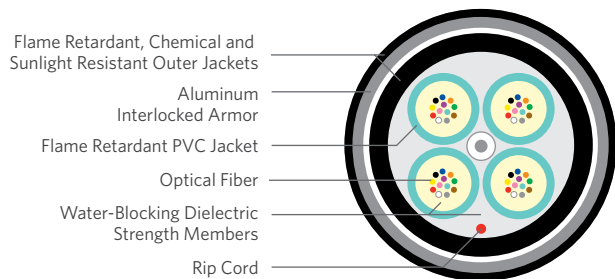
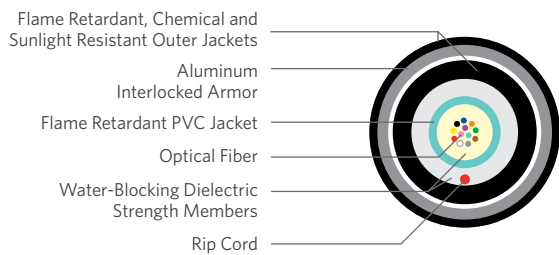

### SPECIFICATIONS

<b>2 - 12 Fiber Single Unit Configuration</b>	3 mm central subunit surrounded by additional water-blocking glass yarns and an outer jacket
<b>24-48 Fiber Multi-Unit Configuration</b>	3mm subunits stranded around a central strength element and surrounded by water blocking glass yarns, a ripcord and an outer jacket
<b>Subunit Configuration</b>	3mm subunits containing 2 to 12, 250 µm fibers and water blocking aramid yarns surrounded by a flame retardant PVC jacket
<b>Subunit Strength Elements</b>	Water-blocking aramid yarns
<b>Subunit Jacket</b>	Flame retardant (FR) PVC
<b>Strength Elements</b>	Water-blocking glass yarns and/or glass reinforced plastic rod
<b>Cable Jacket</b>	Riser: Black, FR, chemical and sunlight resistant PVC Plenum: Black, FR, chemical and sunlight resistant fluoropolymer
<b>Interlock Armored</b>	Flexible, heavy duty interlocking aluminum tape helically applied over the inner cable core; further protection is provided by an optional flame retardant outer jacket
<b>Performance Compliance</b>	UL 1569 UL 1651 CSA C22.2 No. 232 UL 1666 NFPA 130 (Plenum) NFPA 262 ANSI/ICEA S-83-596 ANSI/ICEA S-104-696 ANSI/TIA-568.3-D RoHS-compliant
<b>NRTL Programs</b>	UL, c(UL) Listed OFCR/OFCP UL, c(UL) Listed Sunlight Resistant

### ENVIRONMENTAL SPECIFICATIONS

<b>Operation</b>	-40°C to +75°C
<b>Storage/Shipping</b>	-40°C to +75°C
<b>Installation</b>	0°C to +65°C

### PRODUCT DESCRIPTION

EnduraLite® Dry Block, Sunlight Resistant Indoor/Outdoor Loose Tube riser and plenum rated Interlock Armored cable lines offer the system designer the smallest form factor in a premises indoor/outdoor optical fiber cable. The cables can be installed in open spaces, trays, conduits, inner-ducts, trenches, steam tunnels and building riser or plenum locations. The cables incorporate the latest in dry water-blocking technology which eliminates the need to clean off the traditional gel-based water-blocking compounds. In the single unit design, a 3 mm central tube contains 2 to 12, 250 µm fibers and water-blocking aramid yarns. In the multi-unit design, the waterblocked 3 mm subunits are stranded around a central strength element. The tube or core is surrounded by additional water-blocking glass strength elements and an outer jacket, comprised of a rugged UL Listed, sunlight resistant, black polymer that allows for the cable to be exposed to long-term direct sunlight without the concern of material degradation. The cable is then protected by an interlock armor and a sunlight resistant black over jacket. All fiber types are available, including 50/125 µm, 62.5/125 µm and single mode.

### APPLICATIONS

- Intra/inter-building backbones, such as conduit pathways or tunnels
- Conduit/duct/tray pathways/direct bury in trenches
- Dry or wet locations

### FEATURES

- Exceeds ANSI/TIA-568.3-D optical performance
- Dry-block design meets Telcordia ANSI/ICEA S-104-696 water-block requirements
- 3 mm subunit
- UL/NEC Listed OFCR/OFCP
- All dielectric
- Jacket rip cord
- Black, UL Listed sunlight resistant outer jacket
- BrakeBox® payout control system
- Tube color indicates fiber type

### BENEFITS

- Future-proof fiber performance for current and future multi-gigabit applications
- Cable integrity maintained even if damage occurs to protective layers
- Attaches directly to MTP® or MPO mechanical connectors
- Eliminates the need to purchase separate cables for OSP and indoor/riser or plenum applications
- No additional grounding materials need to be purchased
- Saves time in cable preparation
- Long periods of direct sunlight exposure will not damage cable
- Adjustable tension control on reel prevents over spin and entangling of cable
- Quickly identifies the fiber type without searching for the jacket print

**PART NUMBER KEY**

<b>F</b>	<b>1 or 2</b>	<b>6</b>	<b>0 or 2</b>	<b>-</b>	<b>-</b>	<b>-</b>	<b>-</b>	<b>U</b>	<b>x</b>	<b>x</b>	<b>-</b>	<b>E</b>	<b>9</b>	<b>9</b>	<b>1</b>
1	2	3	4	5	6	7	8	9	10	11	12	13	14	15	16
Fiber cable	Listing	Cable type		-	Fiber count (002-048)			Fiber type			-	Jacket color	Package		Jacket print

Contact Customer Service for availability of non-standard offerings.

**PART NUMBERS AND PHYSICAL CHARACTERISTICS**

Listing	Part Number <sup>1</sup>	Fiber Count	Nominal Diameter in (mm)	Nominal Weight lbs/kft (kg/km)	Maximum Tensile Loading		Minimum Bend Radius		Package <sup>1</sup>	
					Install lbs (N)	Long Term lbs (N)	Install in (mm)	Long Term in (mm)		
<b>Single Unit</b>										
OFCR	F160-002Uxx-E991	2	0.55 (14.0)	110 (164)	300 (1,340)	90 (400)	8.3 (210)	5.5 (140)	Plywood	
OFCR	F160-004Uxx-E991	4	0.55 (14.0)	110 (164)	300 (1,340)	90 (400)	8.3 (210)	5.5 (140)	Plywood	
OFCR	F160-006Uxx-E991	6	0.55 (14.0)	110 (164)	300 (1,340)	90 (400)	8.3 (210)	5.5 (140)	Plywood	
OFCR	F160-008Uxx-E991	8	0.55 (14.0)	110 (164)	300 (1,340)	90 (400)	8.3 (210)	5.5 (140)	Plywood	
OFCR	F160-012Uxx-E991	12	0.55 (14.0)	110 (164)	300 (1,340)	90 (400)	8.3 (210)	5.5 (140)	Plywood	
OFCP	F260-002Uxx-E991	2	0.54 (13.8)	128 (191)	300 (1,340)	90 (400)	8.1 (207)	5.4 (138)	Plywood	
OFCP	F260-004Uxx-E991	4	0.54 (13.8)	128 (191)	300 (1,340)	90 (400)	8.1 (207)	5.4 (138)	Plywood	
OFCP	F260-006Uxx-E991	6	0.54 (13.8)	128 (191)	300 (1,340)	90 (400)	8.1 (207)	5.4 (138)	Plywood	
OFCP	F260-008Uxx-E991	8	0.54 (13.8)	128 (191)	300 (1,340)	90 (400)	8.1 (207)	5.4 (138)	Plywood	
OFCP	F260-012Uxx-E991	12	0.54 (13.8)	128 (191)	300 (1,340)	90 (400)	8.1 (207)	5.4 (138)	Plywood	
<b>Multi-Unit</b>										
OFCP	F262-024Uxx-E991	24	0.74 (18.8)	203 (303)	600 (2670)	180 (800)	11.0 (282)	7.4 (188)	Plywood	
OFCP	F262-036Uxx-E991	36	0.74 (18.8)	204 (304)	600 (2670)	180 (800)	11.0 (282)	7.4 (188)	Plywood	
OFCP	F262-048Uxx-E991	48	0.74 (18.8)	205 (305)	600 (2670)	180 (800)	11.0 (282)	7.4 (188)	Plywood	

**SINGLE MODE OPTICAL FIBER TYPES**

	TeraFlex® Bend Resistant		
	G.657.A1	G.657.A2	G.657.B3
Replace "xx" with:	13	14	15
Typical Attenuation (dB/km)	0.32/0.18 (1310nm/1550nm)		
Max Attenuation (dB/km)	0.7/0.7 (1310nm/1550nm)		
Standard Jacket Color*	Black		

\*Other jacket colors available upon request. See "Optical Fiber Specifications" in the "Technical Info" section for detailed fiber type specifications.

**MULTIMODE OPTICAL FIBER TYPES**

	TeraGain® 62.5/125		TeraFlex Bend Resistant Laser Optimized 50/125	
	OM3	OM4	OM3	OM4
Replace "xx" with:	23	30	30	32
Minimum Bandwidth: OFL (MHz-km)	220/500 (850nm/1300nm)		—	—
Minimum Bandwidth: Laser EMB (MHz-km)	—	2000/500 (850nm/1300nm)	4700/500 (850nm/1300nm)	—
Typical Attenuation (dB/km)	2.5/0.7 (850nm/1300nm)			
Max Attenuation (dB/km)	3.5/1.5 (850nm/1300nm)			
Standard Jacket Color*	Black			

\*Other jacket colors available upon request. See "Optical Fiber Specifications" in the "Technical Info" section for detailed fiber type specifications.

# Breakout

OFNR

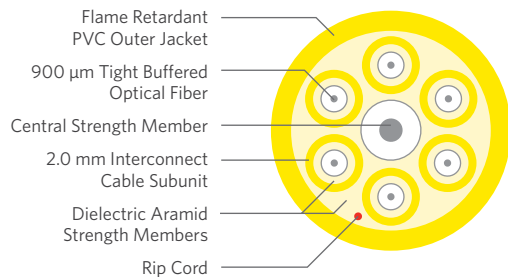
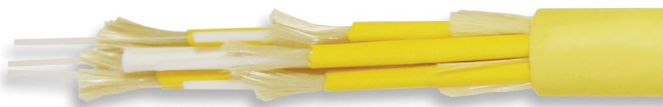

## SPECIFICATIONS

Configuration	2.0 mm subunits surrounding a central strength element with overall jacket
Subunit Configuration	2.0 mm simplex with 900 micron tight buffered fiber and aramid yarns
Subunit Marking	Unit 1, Unit 2, etc.
Strength Elements	Glass Reinforced Plastic (GRP) central strength element with PVC jacket
Jacket	Yellow, flame retardant (FR) PVC
Performance Compliance	UL 1651 CSA C22.2 No. 232 UL 1666 Telcordia® GR-409-CORE, Issue 2 ANSI/ICEA S-83-596 ANSI/TIA-568.3-D
NRTL Programs	UL, c(UL) Listed OFNR
Sustainability	UL Certified EPD HPD USGBC® Member RoHS-compliant/RoHS 2-compliant REACH-compliant

## PRODUCT DESCRIPTION

**FIRST MANUFACTURER IN THE INDUSTRY**  
to offer products that contribute toward LEED!

The optical fiber Breakout Cable from Superior Essex is designed with Central Office (CO) connectivity in mind. The cable consists of 2 mm interconnect cable subunits surrounding a central strength element. The subunits are surrounded by aramid yarns and a flame retardant PVC riser-rated jacket, and each is ideally suited to be attached to small form factor connectors. The cable is available in 6, 12 and 24-fiber count configurations.

## APPLICATIONS

- Central Office (CO)

## FEATURES

- UL® Certified Environmental Product Declaration (EPD)
- Health Product Declaration™ (HPD™)
- 2.0 mm simplex interconnect subunits
- Meets or exceeds ICEA S-83-596 and GR-409-CORE requirements for interconnect subunits and cable
- Riser (OFNR) rated designs

## BENEFITS

- Contributes toward 1 LEED point under the Material and Resources credit (MRc)
- Contributes toward 1 LEED point under the MRc
- Connects directly to small form factor connectors, like the LC
- Worry-free installation and performance
- Fire-listed cables allow placement in riser spaces

## ENVIRONMENTAL SPECIFICATIONS

Operation	-20°C to +70°C
Storage/Shipping	-40°C to +75°C
Installation	10°C to +60°C

## PART NUMBERS AND PHYSICAL CHARACTERISTICS

Listing	Part Number	Fiber Count	Nominal Diameter in (mm)	Nominal Weight lbs/kft (kg/km)	Maximum Tensile Loading		Minimum Bend Radius		Package
					Install lbs (N)	Long Term lbs (N)	Install in (mm)	Long Term in (mm)	
OFNR	T3006x201	6	0.34 (8.8)	45 (66)	150 (660)	45 (200)	5.2 (132)	3.4 (88)	Plywood reel
OFNR	T3012x201	12	0.43 (11.0)	64 (95)	150 (660)	45 (200)	6.5 (165)	4.3 (110)	Plywood reel
OFNR	T3024x201	24	0.58 (14.8)	122 (181)	300 (1,320)	90 (400)	8.7 (222)	5.8 (148)	Plywood reel

## SINGLE MODE OPTICAL FIBER TYPES

TeraFlex® Bend Resistant

G.657.A1    G.657.A2    G.657.B3

<sup>1</sup>Replace "x" with:

K    J    L

Standard Jacket Colors\*

Yellow

\*Other jacket colors available upon request.

See "Optical Fiber Specifications" in the "Technical Info" section for detailed fiber type specifications.

## MULTIMODE OPTICAL FIBER TYPES

TeraGain®    TeraFlex Bend Resistant Laser Optimized 50/125

62.5/125    10G/300    10G/550

<sup>1</sup>Replace "x" with:

6    N    P

Standard Jacket Colors\*

Orange

Aqua

## SUSTAINABILITY LEADERSHIP

**RoHS REACH**

UL and the related logo are registered trademarks of UL LLC. Health Product Declaration, HPD and the related logo are trademarks of Health Product Declaration Collaborative. Telcordia is a registered trademark

of Ericsson Inc. USGBC and the related logo are registered trademarks of U.S. Green Building Council.

# nCompass™

a suite of high performance  
cabling systems brought to you by  
**Legrand®** and **Superior Essex®**



complete efficiency.

complete flexibility.

complete reliability.

complete support.

connect. completely.

[www.nCompass-systems.com](http://www.nCompass-systems.com)

# Single Unit Distribution

OFNR/OFNP

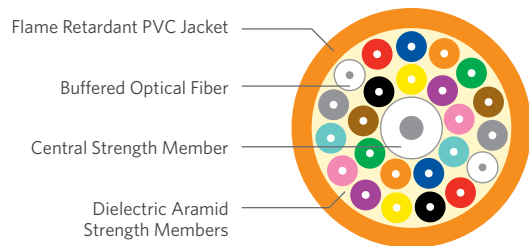

## PRODUCT DESCRIPTION



**FIRST MANUFACTURER IN THE INDUSTRY**  
to offer products that contribute toward LEED!

These Superior Essex premises distribution optical fiber cables are constructed using a single unit, single jacket RoHS-compliant design with fiber counts from 6 through 24. The design consists of flexible 900 µm tight buffered industry standard 250 µm fibers (900/250/125 µm) and is suitable for use with standard connectors, like the SC, ST, and FC, and small-form-factor connectors like the LC. Dielectric aramid yarns are applied for strength while maintaining flexibility. The 18 and 24-fiber cable designs have a flexible glass reinforced central strength element for added durability and performance. A durable, flame resistant outer jacket is applied over the cable core using appropriate OFNR or OFNP rated materials.

## APPLICATIONS

- Intrabuilding backbones
- Conduit pathways
- Service entrance to communication closets
- "Behind-the-shelf" connections

## FEATURES

- UL® Certified Environmental Product Declaration (EPD)
- Health Product Declaration™ (HPD™)
- Marked in feet and meters
- BrakeBox® payout control system

## BENEFITS

- Contributes toward 1 LEED point under the Material and Resources credit (MRc)
- Contributes toward 1 LEED point under the MRc
- Meets commercial, government and international requirements for length markings
- Adjustable tension control on reel prevents over spin and entangling of cable

## SPECIFICATIONS

6-12 Fiber Configuration	Flexible 900 µm tight buffered fibers, dielectric aramid yarns and overall jacket
18-24 Fiber Configuration	Band marked flexible 900 µm tight buffered fibers, dielectric aramid yarns, overall jacket and central strength element
Jacket	OFNR: Flame retardant (FR) PVC OFNP: FR, low smoke PVC
Performance Compliance	UL 1651 CSA C22.2 No. 232 UL 1666 NFPA 262 Telcordia® GR-409, Issue 1 Telcordia GR-409, Issue 2 ANSI/ICEA S-83-596 ANSI/TIA-568.3-D
NRTL Programs	UL, c(UL) Listed OFNR UL, c(UL) Listed OFNP
Sustainability	UL Certified EPD HPD USGBC® Member RoHS-compliant/RoHS 2-compliant REACH-compliant

## ENVIRONMENTAL SPECIFICATIONS

	Riser	Plenum
Operation	-20°C to +75°C	0°C to +75°C
Storage/Shipping	-40°C to +75°C	-40°C to +75°C
Installation	-20°C to +65°C	0°C to +65°C

## SUSTAINABILITY LEADERSHIP



**RoHS REACH**

UL and the related logo are registered trademarks of UL LLC. Health Product Declaration, HPD and the related logo are trademarks of Health Product Declaration Collaborative. Telcordia is a registered trademark of Ericsson Inc. USGBC and the related logo are registered trademarks of U.S. Green Building Council.

**PART NUMBERS AND PHYSICAL CHARACTERISTICS**

Listing	Part Number <sup>1</sup>	Fiber Count	Nominal Diameter in (mm)	Nominal Weight lbs/kft (kg/km)	Maximum Tensile Loading		Minimum Bend Radius		Package
					Install lbs (N)	Long Term lbs (N)	Install in (mm)	Long Term in (mm)	
<b>Single Mode</b>									
OFNR	43006x1zz	6	0.20 (5.0)	17 (25)	150 (660)	45 (200)	3.0 (75)	2.0 (50)	use key
OFNR	43008x1zz	8	0.24 (6.0)	20 (30)	150 (660)	45 (200)	3.5 (90)	2.4 (60)	use key
OFNR	43012x1zz	12	0.26 (6.5)	25 (37)	150 (660)	45 (200)	3.8 (98)	2.6 (65)	use key
OFNR	43018xK01*	18	0.30 (7.5)	35 (51)	300 (1,320)	90 (400)	4.4 (113)	3.0 (75)	Plywood reel
OFNR	43024xK01*	24	0.33 (8.5)	44 (66)	300 (1,320)	90 (400)	5.0 (128)	3.3 (85)	Plywood reel
OFNP	44006x1zz	6	0.20 (5.0)	17 (25)	100 (440)	30 (130)	3.0 (75)	2.0 (50)	use key
OFNP	44008x1zz	8	0.21 (5.4)	19 (28)	100 (440)	30 (130)	3.2 (81)	2.1 (54)	use key
OFNP	44012x1zz	12	0.24 (6.2)	24 (35)	100 (440)	30 (130)	3.7 (93)	2.4 (62)	use key
OFNP	44018xK01*	18	0.28 (7.0)	33 (49)	150 (660)	45 (200)	4.1 (105)	2.8 (70)	Plywood reel
OFNP	44024xK01	24	0.31 (7.8)	42 (62)	150 (660)	45 (200)	4.6 (117)	3.1 (78)	Plywood reel
<b>Multimode</b>									
OFNR	43006yGzz	6	0.20 (5.0)	17 (25)	150 (660)	45 (200)	3.0 (75)	2.0 (50)	use key
OFNR	43008yGzz	8	0.24 (6.0)	20 (30)	150 (660)	45 (200)	3.5 (90)	2.4 (60)	use key
OFNR	43012yGzz	12	0.26 (6.5)	25 (37)	150 (660)	45 (200)	3.8 (98)	2.6 (65)	use key
OFNR	43018yK01	18	0.30 (7.5)	35 (51)	300 (1,320)	90 (400)	4.4 (113)	3.0 (75)	Plywood reel
OFNR	43024yK01	24	0.33 (8.5)	44 (66)	300 (1,320)	90 (400)	5.0 (128)	3.3 (85)	Plywood reel
OFNP	44006yGzz	6	0.20 (5.0)	17 (25)	100 (440)	30 (130)	3.0 (75)	2.0 (50)	use key
OFNP	44008yGzz	8	0.21 (5.4)	19 (28)	100 (440)	30 (130)	3.2 (81)	2.1 (54)	use key
OFNP	44012yGzz	12	0.24 (6.2)	24 (35)	100 (440)	30 (130)	3.7 (93)	2.4 (62)	use key
OFNP	44018yK01	18	0.28 (7.0)	33 (49)	150 (660)	45 (200)	4.1 (105)	2.8 (70)	Plywood reel
OFNP	44024yK01	24	0.31 (7.8)	42 (62)	150 (660)	45 (200)	4.6 (117)	3.1 (78)	Plywood reel

<sup>1</sup>Only available with TeraFlex® Bend Resistant single mode optical fiber types.

	TeraFlex® Bend Resistant		
	G.657.A1	G.657.A2	G.657.B3
<sup>1</sup> Replace "x" with:	K	J	L
Standard Jacket Colors*	Yellow		

	TeraGain®		TeraFlex Bend Resistant Laser Optimized 50/125	
	62.5/125		10G/300	10G/550
<sup>1</sup> Replace "y" with:	6		N	P
Standard Jacket Colors*	Orange		Aqua	

\*Other jacket colors available upon request.

See "Optical Fiber Specifications" in the "Technical Info" section for detailed fiber type specifications.

	PACKAGING			
	Cut to Length Plywood Reel	1,000 ft BrakeBox®	1,500 ft BrakeBox®	2,000 ft BrakeBox®
<sup>1</sup> Replace "zz" with:	01	BB	BD	BC
Fiber Counts:	All	6 - 12	6 - 12	6

# Multi-Unit Distribution

OFNR/OFNP

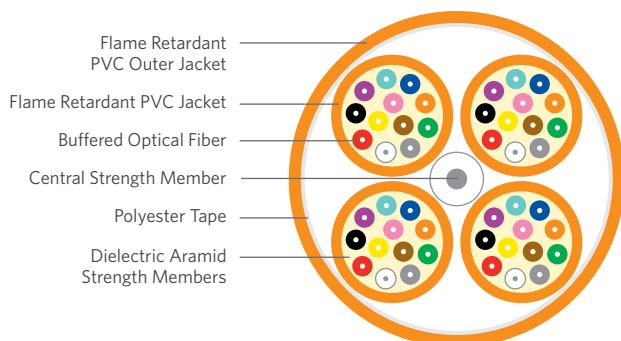

## SPECIFICATIONS

<b>18-36 Fiber Configuration</b>	6-fiber subunits, reverse oscillating lay (ROL) stranded around flexible high-strength glass reinforced rod
<b>36-144 Fiber Configuration</b>	12-fiber subunits, ROL stranded around flexible high-strength glass reinforced rod
<b>Subunit Jacket</b>	OFNR: Flame retardant (FR) PVC OFNP: FR, low smoke (LS) PVC
<b>Outer Jacket</b>	OFNR: FR PVC OFNP: FR PVDF or LS PVC
<b>Performance Compliance</b>	UL 1651 CSA C22.2 No. 232 UL 1666 NFPA 262 Telcordia® GR-409-CORE, Issue 2 ANSI/ICEA S-83-596 ANSI/TIA-568.3-D
<b>NRTL Programs</b>	UL, c(UL) Listed OFNR UL, c(UL) Listed OFNP
<b>Sustainability</b>	UL Certified EPD HPD USGBC® Member RoHS-compliant/RoHS 2-compliant REACH-compliant

## ENVIRONMENTAL SPECIFICATIONS

	Riser	Plenum
<b>Operation</b>	-20°C to +75°C	0°C to +75°C
<b>Storage/Shipping</b>	-40°C to +75°C	-40°C to +75°C
<b>Installation</b>	0°C to +65°C	0°C to +65°C

## SUSTAINABILITY LEADERSHIP



**RoHS REACH**

UL and the related logo are registered trademarks of UL LLC. Health Product Declaration, HPD and the related logo are trademarks of Health Product Declaration Collaborative. Telcordia is a registered trademark of Ericsson Inc. USGBC and the related logo are registered trademarks of U.S. Green Building Council.

## PRODUCT DESCRIPTION

**FIRST MANUFACTURER IN THE INDUSTRY**  
to offer products that contribute toward LEED!

Premises Multi-unit Distribution Optical Fiber Cables are constructed using 6 or 12-fiber subunits stranded around a central strength member in a RoHS-compliant design for fiber counts from 18 through 144. Standard fibers for these cables include Reduced Water Peak (RWP) single mode, TeraGain® 220/600 62.5 μm multimode and TeraFlex® 10G/150 - laser optimized 50 μm multimode fiber. All fibers exceed industry requirements.

The design consists of flexible 900 μm tight buffered industry standard 250 μm fibers (900/250/125 μm) and is suitable for use with standard connectors, like the SC, ST, and FC, and small-form-factor connectors like the LC. Subunits are constructed using dielectric aramid yarns for strength while maintaining flexibility and are jacketed using the color appropriate to the type of fiber in the cable. The subunits are then stranded around a flexible high-strength glass reinforced rod which provides exceptional resistance to dimensional changes due to temperature. A durable, flame resistant outer jacket is applied over the cable core using appropriate OFNR or OFNP rated materials.

## APPLICATIONS

- Intrabuilding backbones
- Conduit pathways
- Service entrance to communication closets
- "Behind-the-shelf" connections

## FEATURES

- UL® Certified Environmental Product Declaration (EPD)
- Health Product Declaration™ (HPD™)
- Subunits are color coded according to fiber type
- Numbered subunits
- Marked in feet and meters

## BENEFITS

- Contributes toward 1 LEED point under the Material and Resources credit (MRc)
- Contributes toward 1 LEED point under the MRc
- Easily identify fiber type
- Easily identifies correct subunit on each end
- Length marking for both commercial and military/government



**PART NUMBER KEY**

<b>F</b>	<b>3 or 4</b>	<b>1 or 0</b>	<b>0 or 4</b>	<b>-</b>	<b>-</b>	<b>-</b>	<b>-</b>	<b>U</b>	<b>y</b>	<b>y</b>	<b>-</b>	<b>z</b>	<b>9</b>	<b>9</b>	<b>1</b>
1	2	3	4	5	6	7	8	9	10	11	12	13	14	15	16
Fiber cable	Listing	Cable type		-	Fiber count (018-144)			Fiber type			-	Jacket color	Package		Jacket print

Contact Customer Service for availability of non-standard offerings.

**PART NUMBERS AND PHYSICAL CHARACTERISTICS**

Listing	Part Number <sup>1</sup>	Fiber Count	Fibers Per Subunit	Nominal Diameter in (mm)	Nominal Weight lbs/kft (kg/km)	Maximum Tensile Loading		Minimum Bend Radius		Package
						Install lbs (N)	Long Term lbs (N)	Install in (mm)	Long Term in (mm)	
OFNR	F310-036Uyy-z991	36	12	0.69 (17.5)	150 (224)	300 (1,320)	90 (400)	10.3 (262)	6.9 (175)	Reel
OFNR	43048xx101	48	12	0.69 (17.5)	150 (224)	300 (1,320)	90 (400)	10.3 (262)	6.9 (175)	Reel
OFNR	43060xx101	60	12	0.77 (19.5)	195 (291)	300 (1,320)	90 (400)	11.5 (292)	7.7 (195)	Reel
OFNR	43072xx101	72	12	0.82 (21.0)	233 (348)	600 (2,640)	180 (800)	12.4 (314)	8.2 (210)	Reel
OFNR	43084xx101	84	12	0.92 (23.3)	289 (431)	600 (2,640)	180 (800)	13.7 (349)	9.2 (233)	Reel
OFNR	43096xx101	96	12	0.97 (24.7)	337 (503)	600 (2,640)	180 (800)	14.6 (370)	9.7 (247)	Reel
OFNR	43144xx101	144	12	1.11 (28.3)	362 (540)	600 (2,640)	180 (800)	16.7 (425)	11.1 (283)	Reel
OFNP	F410-036Uyy-z991	36	12	0.67 (17.1)	189 (282)	300 (1,320)	90 (400)	10.1 (257)	6.7 (171)	Reel
OFNP	44048xx101	48	12	0.67 (17.1)	189 (282)	300 (1,320)	90 (400)	10.1 (257)	6.7 (171)	Reel
OFNP	44060xx101	60	12	0.74 (18.9)	229 (341)	300 (1,320)	90 (400)	11.2 (284)	7.4 (189)	Reel
OFNP	44072xx101	72	12	0.81 (20.6)	276 (412)	600 (2,640)	180 (800)	12.2 (309)	8.1 (206)	Reel
OFNP	44096xx101	96	12	0.87 (22.0)	313 (467)	600 (2,640)	180 (800)	13.0 (330)	8.7 (220)	Reel
OFNP	44144xx101	144	12	0.92 (23.4)	318 (474)	600 (2,640)	180 (800)	13.8 (351)	9.2 (234)	Reel

**SINGLE MODE OPTICAL FIBER TYPES**

	TeraFlex® Bend Resistant		
	G.657.A1	G.657.A2	G.657.B3
<sup>1</sup> Replace "xx" with:	K1	J1	L1
<sup>1</sup> Replace "yy" with:	13	14	15
Standard Jacket Colors*	Yellow (z = 6)		

**MULTIMODE OPTICAL FIBER TYPES**

	TeraGain® 62.5/125	TeraFlex Bend Resistant Laser Optimized 50/125	
		OM3	OM4
<sup>1</sup> Replace "xx" with:	6G	NG	PG
<sup>1</sup> Replace "yy" with:	23	30	32
Standard Jacket Colors*	Orange (z = D)	Aqua (z = K)	

\*Other jacket colors available upon request.  
See "Optical Fiber Specifications" in the "Technical Info" section for detailed fiber type specifications.

# Interlock Armored, Tight Buffer

OFCR/OFCP

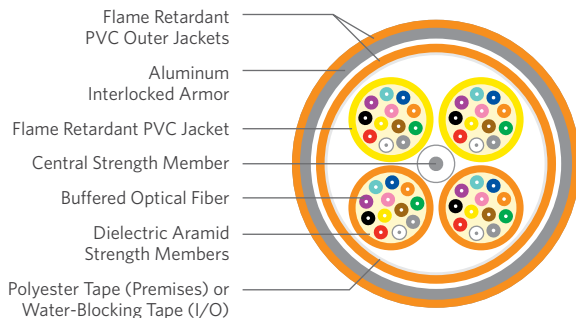

## SPECIFICATIONS

### Interlock Armored

Flexible, heavy duty interlocking aluminum tape helically applied over the inner cable core; further protection is provided by an optional flame retardant outer jacket

### Outer Jacket

OFCR: Flame retardant (FR), PVC  
OFCP: FR, LSPVC

UL 1569  
UL 1651  
CSA C22.2 No. 232  
UL 1666

### Performance Compliance

NFPA 262  
Telcordia® GR-409-CORE, Issue 1  
Telcordia GR-409-CORE, Issue 2  
ANSI/ICEA S-83-596  
ANSI/TIA-568.3-D

### NRTL Programs

UL, c(UL) Listed OFCR  
UL, c(UL) Listed OFCP

### Sustainability

UL Certified EPD  
HPD  
USGBC® Member  
RoHS-compliant/RoHS 2-compliant  
REACH-compliant

## PRODUCT DESCRIPTION

**FIRST MANUFACTURER IN THE INDUSTRY**  
to offer products that contribute toward LEED!

Interlock Armored Optical Fiber Cables provide an extremely well protected cable package ideally suited for mechanically challenging environments. The armor is available in aluminum and comes with either an OFCR (riser) or OFCP (plenum) rating. This design offers the system designer a product that can be installed in areas where added mechanical protection and security are required. The flexible interlock armored cable design is also popular for retrofit applications and eliminates the need to install rigid conduit while still meeting building code guidelines.

## APPLICATIONS

- Intrabuilding backbones
- Conduit pathways
- Service entrance to communication closets

## FEATURES

- UL® Certified Environmental Product Declaration (EPD)
- Health Product Declaration™ (HPD™)
- Thick, flexible metallic armor
- Flame retardant, UL Listed designs

## BENEFITS

- Contributes toward 1 LEED point under the Material and Resources credit (MRc)
- Contributes toward 1 LEED point under the MRc
- Reduce incidences of circuit disruption due to rodents or mechanically abusive applications
- Eliminates the need for multiple cables for installation

## ENVIRONMENTAL SPECIFICATIONS

	Riser	Plenum
Operation	-20°C to +75°C	0°C to +75°C
Storage/Shipping	-40°C to +75°C	-40°C to +75°C
Installation	-20°C to +65°C	0°C to +65°C

## SUSTAINABILITY LEADERSHIP



UL and the related logo are registered trademarks of UL LLC. Health Product Declaration, HPD and the related logo are trademarks of Health Product Declaration Collaborative. Telcordia is a registered trademark of Ericsson Inc. USGBC and the related logo are registered trademarks of U.S. Green Building Council.

**PART NUMBERS AND PHYSICAL CHARACTERISTICS**

Listing	Part Number <sup>1</sup>	Configuration	Fiber Count	Nominal Diameter in (mm)	Nominal Weight lbs/kft (kg/km)	Maximum Compression lbf/in (N/cm)	Maximum Tensile Loading		Minimum Bend Radius	
							Install lbs (N)	Long Term lbs (N)	Install in (mm)	Long Term in (mm)
OFCR	L3002x301	Single unit	2	0.54 (13.8)	90 (134)	286 (500)	150 (670)	45 (200)	8.2 (207)	5.4 (138)
OFCR	L3004x301	Single unit	4	0.54 (13.8)	93 (139)	286 (500)	150 (670)	45 (200)	8.2 (207)	5.4 (138)
OFCR	L3006x401	Single unit	6	0.54 (13.8)	96 (144)	286 (500)	150 (670)	45 (200)	8.2 (207)	5.4 (138)
OFCR	L3008x401	Single unit	8	0.54 (13.8)	101 (150)	287 (500)	150 (670)	45 (200)	8.2 (207)	5.4 (138)
OFCR	L3012x401	Single unit	12	0.61 (15.6)	116 (173)	286 (500)	150 (670)	45 (200)	9.2 (234)	6.1 (156)
OFCR	L3018xK1Q	Single unit	18	0.67 (17.1)	145 (216)	228 (400)	300 (1,340)	90 (400)	10.1 (256)	6.7 (171)
OFCR	L3024xK1Q	Single unit	24	0.73 (18.5)	174 (260)	228 (400)	300 (1,340)	90 (400)	11.0 (278)	7.3 (185)
OFCP	L4002x301	Single unit	2	0.50 (12.7)	78 (116)	286 (500)	150 (670)	45 (200)	7.5 (191)	5.0 (127)
OFCP	L4004x301	Single unit	4	0.50 (12.7)	79 (118)	286 (500)	150 (670)	45 (200)	7.5 (191)	5.0 (127)
OFCP	L4006x401	Single unit	6	0.50 (12.7)	88 (131)	286 (500)	150 (670)	45 (200)	7.5 (191)	5.0 (127)
OFCP	L4008x401	Single unit	8	0.50 (12.7)	90 (134)	286 (500)	150 (670)	45 (200)	7.5 (191)	5.0 (127)
OFCP	L4012x401	Single unit	12	0.55 (13.9)	104 (155)	286 (500)	150 (670)	45 (200)	8.2 (209)	5.5 (139)
OFCP	L4018xK1Q	Single unit	18	0.60 (15.2)	129 (192)	228 (400)	150 (670)	45 (200)	9.0 (229)	6.0 (152)
OFCP	L4024xK1Q	Single unit	24	0.62 (15.6)	139 (207)	228 (400)	150 (670)	45 (200)	9.2 (235)	6.2 (156)
OFCR	L3024x401	Multi-unit	24	0.93 (23.6)	265 (396)	228 (400)	300 (1,340)	90 (400)	14.0 (354)	9.3 (236)
OFCR	L3036x401	Multi-unit	36	1.05 (26.7)	351 (523)	171 (300)	300 (1,340)	90 (400)	15.7 (400)	10.5 (267)
OFCR	L3048x401	Multi-unit	48	1.02 (26.0)	321 (479)	171 (300)	300 (1,340)	90 (400)	15.4 (390)	10.2 (260)
OFCR	L3072x401	Multi-unit	72	1.14 (28.9)	409 (610)	171 (300)	600 (2,700)	180 (800)	17.1 (434)	11.4 (289)
OFCR	L3096x401	Multi-unit	96	1.17 (29.7)	443 (660)	171 (300)	600 (2,700)	180 (800)	17.5 (445)	11.7 (297)
OFCR	L3144x401	Multi-unit	144	1.35 (34.2)	573 (854)	171 (300)	600 (2,700)	180 (800)	20.2 (513)	13.5 (342)
OFCP	L4024x401	Multi-unit	24	0.90 (22.9)	280 (417)	228 (400)	300 (1,340)	90 (400)	13.5 (343)	9.0 (229)
OFCP	L4036x401	Multi-unit	36	1.02 (25.8)	372 (555)	171 (300)	300 (1,340)	90 (400)	15.2 (387)	10.2 (258)
OFCP	L4048x401	Multi-unit	48	1.02 (25.8)	362 (540)	171 (300)	300 (1,340)	90 (400)	15.2 (387)	10.2 (258)
OFCP	L4072x401	Multi-unit	72	1.17 (29.7)	484 (722)	171 (300)	600 (2,700)	180 (800)	17.5 (445)	11.7 (297)
OFCP	L4096x401	Multi-unit	96	1.35 (34.3)	566 (845)	171 (300)	600 (2,700)	180 (800)	20.3 (515)	13.5 (343)
OFCP	L4144x401	Multi-unit	144	1.35 (34.3)	662 (988)	171 (300)	600 (2,700)	180 (800)	20.3 (515)	13.5 (343)

<sup>1</sup>Part numbers listed above include aluminum interlock armored. Steel interlock armored available upon request.

SINGLE MODE OPTICAL FIBER TYPES			
	TeraFlex® Bend Resistant		
	G.657.A1	G.657.A2	G.657.B3
<sup>1</sup> Replace "x" with:	K	J	L
Jacket Colors*	Yellow		

MULTIMODE OPTICAL FIBER TYPES			
	TeraGain®	TeraFlex Bend Resistant Laser Optimized 50/125	
	62.5/125	OM3	OM4
<sup>1</sup> Replace "x" with:	6	N	P
Jacket Colors*	Orange	Aqua	

\*Other jacket colors available upon request. See "Optical Fiber Specifications" in the "Technical Info" section for detailed fiber type specifications.

# Ribbon Distribution

OFNR/OFNP

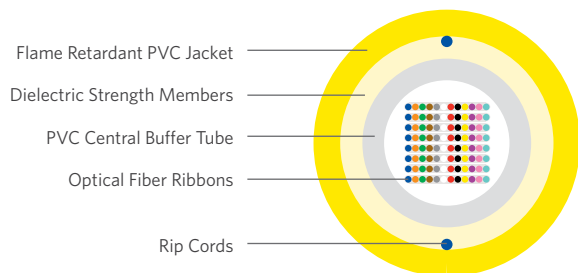
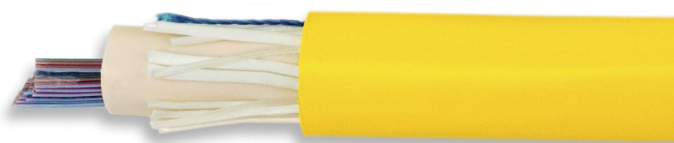

## PRODUCT DESCRIPTION

Superior Essex's Premises Ribbon Distribution cables contain 12 to 288 optical fibers. The fibers are grouped in the form of 12-fiber flat ribbons. For fiber counts greater than 216, two 12-fiber ribbons are conjoined to form a 24-fiber ribbon subunit that's easily separable into two 12-fiber ribbons. The optical fiber ribbons are stacked within a single, flame-retardant, PVC central buffer tube. Dual layers of stranded dielectric strength elements are wrapped around the central tube for tensile and compression strength. A riser or plenum rated PVC sheath covers the strength elements and the cables have highly visible ripcords underneath the jacket for rapid sheath entry.

The ribbon cables are available with an OFNR listing passing the UL® 1666 riser burn test or OFNP listing passing NFPA 262 plenum test. The cables are ideal for high density requirements where conduit space is limited. This cable also meets or exceeds the distribution cable requirements of ANSI/ICEA-596 and Telcordia® GR-409-CORE, Issue 2.

## APPLICATIONS

- Intra-building backbones
- Conduit, duct or tray pathways
- Premises locations

## FEATURES

- Exceeds ANSI/TIA-568.3-D
- Small, compact design
- 12-fiber ribbon subunits
- Two conjoined 12-fiber ribbons for counts greater than 216
- OFNR and OFNP listings
- Jacket ripcords

## BENEFITS

- Future-proof fiber performance for current and future multi-gigabit applications
- Ideal for high density installation like data centers
- Easily mass fusion spliced or attached to MTP®/MPOs
- Keeps the form factor consistent for higher fiber counts
- Allows installation in any premises space
- Save time in cable preparation

## SPECIFICATIONS

≤ 216-Fiber Configuration	Standards compliant 12-fiber ribbon subunits
> 216-Fiber Configuration	Two standards compliant 12-fiber ribbon subunits conjoined to form a 24-fiber ribbon subunit
Jacket	OFNR: Flame retardant (FR) PVC OFNP: FR, low smoke PVC
Performance Compliance	UL 1651 CSA C22.2 No. 232 UL 1666 NFPA 262 Telcordia® GR-409, Issue 2 ANSI/ICEA S-83-596 ANSI/TIA-568.3-D RoHS-compliant/RoHS 2-compliant
NRTL Programs	UL c(UL) Listed OFNR; FT4 UL c(UL) Listing OFNP; FT6

## ENVIRONMENTAL SPECIFICATIONS

	Riser	Plenum
Operation	-20°C to +75°C	0°C to +75°C
Storage/Shipping	-40°C to +75°C	-40°C to +75°C
Installation	0°C to +75°C	+20°C to +75°C

**PART NUMBER KEY**

<b>F</b>	<b>3 or 4</b>	<b>5</b>	<b>6</b>	<b>-</b>	<b>-</b>	<b>-</b>	<b>-</b>	<b>U</b>	<b>x</b>	<b>x</b>	<b>-</b>	<b>y</b>	<b>9</b>	<b>9</b>	<b>1</b>
1	2	3	4	5	6	7	8	9	10	11	12	13	14	15	16
Fiber cable	Listing	Cable type		-	Fiber count (012-288)			Fiber type			-	Jacket color	Package		Jacket print

Contact Customer Service for availability of non-standard offerings.

**PART NUMBERS AND PHYSICAL CHARACTERISTICS**

Listing	Part Number <sup>1</sup>	Fiber Count	Nominal Diameter in (mm)	Nominal Weight lbs/kft (kg/km)	Maximum Tensile Loading		Minimum Bend Radius	
					Install lbs (N)	Long Term lbs (N)	Install in (mm)	Long Term in (mm)
OFNR	F356-012Uxx-y991	12	0.56 (14.2)	126 (188)	300 (1,334)	100 (445)	10.4 (264)	5.2 (132)
OFNR	F356-024Uxx-y991	24	0.56 (14.2)	127 (189)	300 (1,334)	100 (445)	10.4 (264)	5.2 (132)
OFNR	F356-048Uxx-y991	48	0.56 (14.2)	128 (191)	300 (1,334)	100 (445)	10.4 (264)	5.2 (132)
OFNR	F356-060Uxx-y991	60	0.56 (14.2)	130 (193)	300 (1,334)	100 (445)	10.4 (264)	5.2 (132)
OFNR	F356-072Uxx-y991	72	0.56 (14.2)	130 (194)	300 (1,334)	100 (445)	10.4 (264)	5.2 (132)
OFNR	F356-084Uxx-y991	84	0.56 (14.2)	131 (195)	300 (1,334)	100 (445)	10.4 (264)	5.2 (132)
OFNR	F356-096Uxx-y991	96	0.56 (14.2)	132 (196)	300 (1,334)	100 (445)	10.4 (264)	5.2 (132)
OFNR	F356-144Uxx-y991	144	0.63 (16.0)	149 (221)	300 (1,334)	100 (445)	12.4 (314)	6.2 (157)
OFNR	F356-216Uxx-y991	216	0.63 (16.0)	155 (230)	300 (1,334)	100 (445)	12.4 (314)	6.2 (157)
OFNR	F356-288Uxx-y991	288	0.81 (20.5)	200 (298)	600 (2,670)	200 (890)	16.2 (410)	8.1 (205)
OFNP	F456-012Uxx-y991	12	0.55 (14.0)	124 (184)	300 (1,334)	100 (445)	11.0 (280)	5.5 (140)
OFNP	F456-024Uxx-y991	24	0.55 (14.0)	124 (185)	300 (1,334)	100 (445)	11.0 (280)	5.5 (140)
OFNP	F456-048Uxx-y991	48	0.55 (14.0)	126 (187)	300 (1,334)	100 (445)	11.0 (280)	5.5 (140)
OFNP	F456-060Uxx-y991	60	0.55 (14.0)	127 (189)	300 (1,334)	100 (445)	11.0 (280)	5.5 (140)
OFNP	F456-072Uxx-y991	72	0.55 (14.0)	128 (190)	300 (1,334)	100 (445)	11.0 (280)	5.5 (140)
OFNP	F456-084Uxx-y991	84	0.55 (14.0)	128 (191)	300 (1,334)	100 (445)	11.0 (280)	5.5 (140)
OFNP	F456-096Uxx-y991	96	0.55 (14.0)	129 (192)	300 (1,334)	100 (445)	11.0 (280)	5.5 (140)
OFNP	F456-144Uxx-y991	144	0.65 (16.6)	167 (249)	300 (1,334)	100 (445)	13.0 (332)	6.5 (166)
OFNP	F456-216Uxx-y991	216	0.65 (16.6)	173 (257)	300 (1,334)	100 (445)	13.0 (332)	6.5 (166)
OFNP	F456-288Uxx-y991	288	0.85 (21.6)	252 (376)	300 (1,334)	100 (445)	17.0 (432)	8.5 (216)

FIBER TYPES / STANDARD JACKET COLORS: <sup>*</sup>	SINGLE MODE			MULTIMODE		
	TeraFlex® Bend Resistant			TeraFlex Bend Resistant Laser Optimized 50/125		
	G.657.A1	G.657.A2	G.657.B3	TeraGain® 62.5/125	10G/300	10G/550
<sup>1</sup> Replace "xx" with:	13	14	15	23	30	32
<sup>1</sup> Replace "y" with:	Yellow = 6			Orange = D	Aqua = K	

<sup>\*</sup>Other jacket colors available upon request.  
See "Optical Fiber Specifications" in the "Technical Info" section for detailed fiber type specifications.

UL is a registered trademark of UL LLC. Telcordia is a registered trademark of Ericsson Inc.

# Compact and Rugged Indoor MDU

OFNR

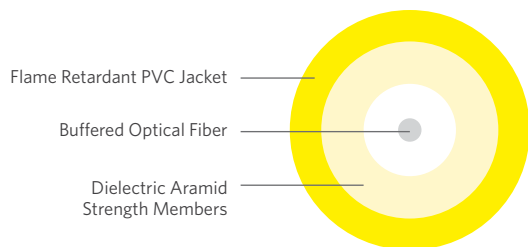

## PRODUCT DESCRIPTION



**FIRST MANUFACTURER IN THE INDUSTRY**  
to offer products that contribute toward LEED!

Both the Compact MDU 2.9 mm simplex cable and the Rugged Indoor MDU 4.8 mm simplex cable meet ICEA-730 Draft specification for MDU cables. The 2.9 mm is ideal for low-stress installations where space is a premium. The 4.8 mm is more robust and can handle installation tensions as high as 100 pounds. Both cables are available with G.657.B3 compliant bend resistant single mode fiber, preventing light loss even under tight bends.

## APPLICATIONS

- Multi-Dwelling Units (MDU)
- Horizontal (non-plenum) or riser spaces
- Optical entrance facility to end-user
- Passive optical networks

## FEATURES

- UL® Certified Environmental Product Declaration (EPD)
- Health Product Declaration™ (HPD™)
- ICEA S-115-730-2011 and ICEA-596 compliant
- Available with G.657.B3 single mode fiber
- Riser rated
- Feet/meter length marking
- BrakeBox® payout control system

## BENEFITS

- Contributes toward 1 LEED point under the Material and Resources credit (MRc)
- Contributes toward 1 LEED point under the MRc
- Insures reliable installation and performance
- Assures low attenuation loss even under installation stresses, such as tight bends and cable stapling
- Meets fire safety requirements for MDUs
- No need for length unit conversion
- Adjustable tension control on reel prevents over spin and entangling of cable

## SPECIFICATIONS

Configuration	Simplex 900 micron tight buffered fiber surrounded by aramid yarns and covered by a riser-rated flame retardant jacket
Strength Elements	Dielectric aramid yarns
Jacket	Yellow, flame retardant PVC (other jacket colors available upon request)
Performance Compliance	UL 1666 ANSI/ICEA S-83-596 ICEA S-115-730-2011 ANSI/TIA-568.3-D REACH-compliant
NRTL Programs	UL, c(UL) Listed OFNR
Sustainability	UL Certified EPD HPD USGBC® Member RoHS-compliant/RoHS 2-compliant REACH-compliant

## ENVIRONMENTAL SPECIFICATIONS

Operation	-20°C to +70°C
Storage/Shipping	-40°C to +70°C
Installation	-10°C to +65°C

## PART NUMBERS AND PHYSICAL CHARACTERISTICS

Listing	Part Number <sup>1</sup>	Fiber Count	Nominal Diameter in (mm)	Nominal Weight lbs/kft (kg/km)	Maximum Tensile Loading		Minimum Bend Radius	
					Install lbs (N)	Long Term lbs (N)	Install in (mm)	Long Term in (mm)
OFNR	D3001L3yy	1	0.11 (2.9)	2.5 (4.0)	50 (220)	15 (66)	2.0 (50)	0.2 (5)
OFNR	D3001L5yy	1	0.19 (4.8)	6.2 (9.3)	100 (450)	30 (132)	2.0 (50)	0.2 (5)

Other jacket colors available upon request.

## PACKAGING

	Cut to Length Plywood Reel	1,000 ft BrakeBox®	1,500 ft BrakeBox®	2,000 ft BrakeBox®
<sup>1</sup> Replace "yy" with:	01	BB	BD	BC

## SUSTAINABILITY LEADERSHIP



**RoHS REACH**

UL and the related logo are registered trademarks of UL LLC. Health Product Declaration, HPD and the related logo are trademarks of Health Product Declaration Collaborative. USGBC and the related logo are registered trademarks of U.S. Green Building Council.

## PRODUCT DESCRIPTION

**FIRST MANUFACTURER IN THE INDUSTRY**  
to offer products that contribute toward LEED!

The Rugged Indoor/Outdoor MDU is a 4.8 mm simplex cable that meets ICEA-730 specification for MDU cables. The cable is robust and can handle installation tensions as high as 100 pounds. The black jacket is UL® Listed Sunlight Resistant and the cable design employs dry block technology to prevent water penetration without the use of gels. This cable is available with G.657.B3 compliant bend resistant single mode fiber, preventing light loss even under tight bends.

## APPLICATIONS

- Multi-Dwelling Units (MDU)
- Indoor or outdoor environments
- Horizontal (non-plenum) or riser spaces
- Optical entrance facility to end-user
- Passive optical networks

## FEATURES

- UL Certified Environmental Product Declaration (EPD)
- Health Product Declaration™ (HPD™)
- ICEA S-115-730-2011 and ICEA-696 compliant
- Available with G.657.B3 single mode fiber
- Dry blocked core
- UL Sunlight Resistant
- Riser rated
- Feet/meter length marking
- BrakeBox® payout control system

## BENEFITS

- Contributes toward 1 LEED point under the Material and Resources credit (MRC)
- Contributes toward 1 LEED point under the MRC
- Insures reliable installation and performance
- Assures low attenuation loss even under installation stresses, such as tight bends and cable stapling
- Prevents water ingress from OSP to ISP environments
- Assures reliable performance even after long term sunlight exposure
- Meets fire safety requirements for MDUs
- No need for length unit conversion
- Adjustable tension control on reel prevents over spin and entangling of cable

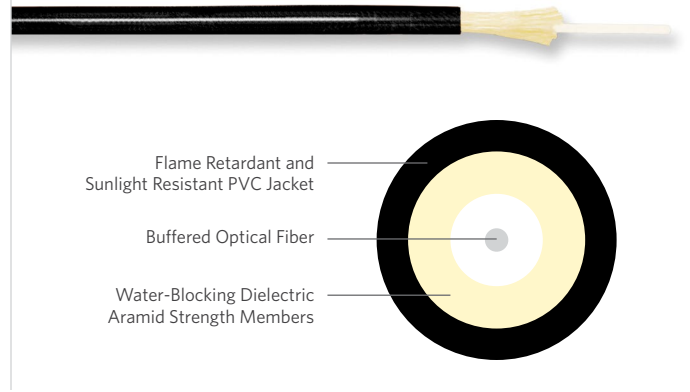

## SPECIFICATIONS

<b>Configuration</b>	Simplex 900 micron tight buffered fiber surrounded by water-blocking aramid yarns and covered by a riser-rated flame retardant and sunlight resistant jacket
<b>Strength Elements</b>	Dielectric aramid yarns
<b>Water-Blocking</b>	SAP Dry Block
<b>Jacket</b>	Black, flame retardant, sunlight resistant PVC
<b>Performance Compliance</b>	UL 1666 Telcordia® GR-409-CORE, Issue 2 ANSI/ICEA S-83-696 ICEA S-115-730-2011 ANSI/TIA-568.3-D REACH-compliant
<b>NRTL Programs</b>	UL, c(UL) Listed OFNR UL, c(UL) Listed Sunlight Resistant
<b>Sustainability</b>	UL Certified EPD HPD USGBC® Member RoHS-compliant/RoHS 2-compliant REACH-compliant

## ENVIRONMENTAL SPECIFICATIONS

<b>Operation</b>	-40°C to +70°C
<b>Storage/Shipping</b>	-40°C to +70°C
<b>Installation</b>	-10°C to +65°C

## PART NUMBERS AND PHYSICAL CHARACTERISTICS

Listing	Part Number <sup>1</sup>	Fiber Count	Nominal Diameter in (mm)	Nominal Weight lbs/kft (kg/km)	Maximum Tensile Loading		Minimum Bend Radius	
					Install lbs (N)	Long Term lbs (N)	Install in (mm)	Long Term in (mm)
OFNR	D5001L5yy	1	0.19 (4.8)	6.2 (9.3)	100 (450)	30 (132)	2.0 (50)	0.3 (7.5)

## PACKAGING

	Cut to Length Plywood Reel	1,000 ft BrakeBox®	1,500 ft BrakeBox®	2,000 ft BrakeBox®
<sup>1</sup> Replace "yy" with:	01	BB	BD	BC

## SUSTAINABILITY LEADERSHIP



UL and the related logo are registered trademarks of UL LLC. Health Product Declaration, HPD and the related logo are trademarks of Health Product Declaration Collaborative. Telcordia is a registered trademark of Ericsson Inc. USGBC and the related logo are registered trademarks of U.S. Green Building Council.

# Dry Block, Sunlight Resistant, Indoor/Outdoor, Tight Buffer

OFNR

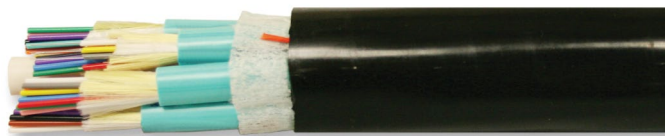

Flame Retardant, Chemical and Sunlight Resistant PVDF Jacket

Flame Retardant PVDF Jacket

Buffered Optical Fiber

Central Strength Member

Water-Blocking Tape

Water-Blocking Dielectric Aramid Strength Members

Rip Cord

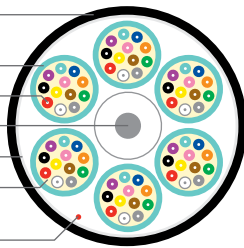

## SPECIFICATIONS

### 2-24 Fiber Single Unit Configuration

Flexible tight buffer material extruded over fiber to 900 µm diameter; color coded fibers are combined with dielectric aramid yarns for strength and water blocking

### 24-36 Fiber Multi-Unit Configuration

Dry water-blocked 6-fiber sub-units are grouped to form cable core; core consists of sub-units cabled with additional strength members and water-blocking elements

### 36-144 Fiber Multi-Unit Configuration

Dry water-blocked 12-fiber sub-units are grouped to form cable core; core consists of sub-units cabled with additional strength members and water-blocking elements

### Jacket

Flame retardant, chemical and sunlight resistant black PVC

### Performance Compliance

UL 1651  
CSA C22.2 No. 232  
UL 1666  
Telcordia® GR-20-CORE, Issue 3 - Water Penetration  
ANSI/ICEA S-104-696-2001  
ANSI/TIA-568.3-D

### NRTL Programs

UL, c(UL) Listed OFNR  
UL, c(UL) Listed Sunlight Resistant

### Sustainability

UL Certified EPD  
HPD  
USGBC® Member  
RoHS-compliant/RoHS 2-compliant  
REACH-compliant

## ENVIRONMENTAL SPECIFICATIONS

Operation	-40°C to +75°C
Storage/Shipping	-40°C to +75°C
Installation	-20°C to +65°C

## SUSTAINABILITY LEADERSHIP



**RoHS REACH**

UL and the related logo are registered trademarks of UL LLC. Health Product Declaration, HPD and the related logo are trademarks of Health Product Declaration Collaborative. Telcordia is a registered trademark of Ericsson Inc. USGBC and the related logo are registered trademarks of U.S. Green Building Council.

## PRODUCT DESCRIPTION



**FIRST MANUFACTURER IN THE INDUSTRY**  
to offer products that contribute toward LEED!

The Dry Block, Sunlight Resistant Indoor/Outdoor, Tight Buffer Riser-Rated Cable line offers the system designer the ultimate in premises optical fiber cable utility. These cables can be installed in open spaces, trays, conduits, inner-ducts, trenches, steam tunnels and building riser locations. These cables incorporate the latest in dry water-blocking technology. This system of water blocking eliminates the need to clean off the traditional gel-based water-blocking compounds found in loose tube cables. In addition, breakout kits and or other special termination equipment associated with loose tube Outside Plant (OSP) cables are not required. The outer jacket is comprised of a durable UL® Listed Sunlight Resistant, black polymer that allows for the cable to be exposed to longterm direct sunlight without the concern of material degradation. All fiber types are available, including 50/125 µm, 62.5/125 µm and single mode.

## APPLICATIONS

- Intra/inter-building backbones
- Trench/conduit/duct/tray pathways
- Dry or wet locations

## FEATURES

- UL Certified Environmental Product Declaration (EPD)
- Health Product Declaration™ (HPD™)
- Exceeds ANSI/TIA-568.3-D optical performance
- Dry-block design meets ICEA 696 water-block requirements
- 900 µm tight-buffered fibers
- UL/NEC Listed OFNR
- All dielectric
- Jacket rip cord
- Black, UL Listed sunlight resistant outer jacket
- BrakeBox® payout control system

## BENEFITS

- Contributes toward 1 LEED point under the Material and Resources credit (MRC)
- Contributes toward 1 LEED point under the MRC
- Future-proof fiber performance for current and future multi-gigabit applications
- Cable integrity maintained even if damage occurs to protective layers
- Attaches directly to mechanical connectors
- Eliminates the need to purchase separate cables for OSP and indoor/riser applications
- No additional grounding materials need to be purchased
- Saves time in cable preparation
- Long periods of direct sunlight exposure will not damage cable
- Adjustable tension control on reel prevents over spin and entangling of cable



**PART NUMBER KEY**

<b>F</b>	<b>3</b>	<b>0</b>	<b>8</b>	<b>-</b>	<b>-</b>	<b>-</b>	<b>-</b>	<b>U</b>	<b>x</b>	<b>x</b>	<b>-</b>	<b>E</b>	<b>y</b>	<b>y</b>	<b>1</b>
1	2	3	4	5	6	7	8	9	10	11	12	13	14	15	16
Fiber cable	Listing	Cable type		-	Fiber count (002-024)			Fiber type			-	Jacket color	Package		Jacket print

Contact Customer Service for availability of non-standard offerings.

**PART NUMBERS AND PHYSICAL CHARACTERISTICS**

Listing	Part Number <sup>1</sup>	Fiber Count	Nominal Diameter in (mm)	Nominal Weight lbs/kft (kg/km)	Maximum Tensile Loading		Minimum Bend Radius		Package
					Install lbs (N)	Long Term lbs (N)	Install in (mm)	Long Term in (mm)	
<b>Single Unit</b>									
OFNR	F308-002Uxx-Eyy1	2	0.23 (5.8)	19 (28)	300 (1340)	90 (402)	9.1 (232)	4.6 (116)	use key
OFNR	F308-004Uxx-Eyy1	4	0.23 (5.8)	20 (29)	300 (1340)	90 (402)	9.1 (232)	4.6 (116)	use key
OFNR	F308-006Uxx-Eyy1	6	0.23 (5.8)	21 (31)	300 (1340)	90 (402)	9.1 (232)	4.6 (116)	use key
OFNR	F308-008Uxx-Eyy1	8	0.26 (6.6)	25 (37)	300 (1340)	90 (402)	10.4 (264)	5.2 (132)	use key
OFNR	F308-012Uxx-Eyy1	12	0.30 (7.6)	36 (54)	300 (1340)	90 (402)	12.0 (304)	6.0 (152)	use key
OFNR	F308-024Uxx-E991	24	0.35 (8.8)	47 (70)	600 (2700)	180 (800)	13.9 (352)	6.9 (176)	Plywood reel
<b>Multi-Unit</b>									
OFNR	W3024zz01	24	0.59 (14.9)	122 (182)	600 (2,700)	180 (800)	23.8 (604)	11.9 (302)	Plywood reel
OFNR	W3036zz01	36	0.70 (17.7)	179 (267)	600 (2,700)	180 (800)	28.2 (716)	14.1 (358)	Plywood reel
OFNR	W3048zz01	48	0.70 (17.8)	161 (241)	600 (2,700)	180 (800)	28.0 (712)	14.0 (356)	Plywood reel
OFNR	W3072zz01	72	0.84 (21.3)	243 (362)	600 (2,700)	180 (800)	33.5 (852)	16.8 (426)	Plywood reel
OFNR	W3084zz01	84	0.91 (23.2)	294 (439)	600 (2,700)	180 (800)	36.5 (926)	18.2 (463)	Plywood reel
OFNR	W3096zz01	96	0.98 (25.0)	345 (515)	600 (2,700)	180 (800)	39.4 (1000)	19.7 (500)	Plywood reel
OFNR	W3144zz01	144	1.11 (28.3)	375 (559)	600 (2,700)	180 (800)	45.2 (1148)	22.6 (574)	Plywood reel

**SINGLE MODE OPTICAL FIBER TYPES**

	TeraFlex® Bend Resistant		
	G.657.A1	G.657.A2	G.657.B3
<sup>1</sup> Replace "xx" with:	13	14	15
<sup>1</sup> Replace "zz" with:	K1	J1	L1
I/O Jacket Color	Black		

**MULTIMODE OPTICAL FIBER TYPES**

	TeraGain®	TeraFlex Bend Resistant Laser Optimized 50/125	
	62.5/125	OM3	OM4
<sup>1</sup> Replace "xx" with:	23	30	32
<sup>1</sup> Replace "zz" with:	6G	NG	PG
I/O Jacket Color	Black		

See "Optical Fiber Specifications" in the "Technical Info" section for detailed fiber type specifications.

**PACKAGING**

	Cut to Length Plywood Reel	1,000 ft BrakeBox®	1,500 ft BrakeBox
<sup>1</sup> Replace "yy" with:	99	A5	AD
<sup>1</sup> Fiber Counts:	2-12	2-12	2-6

# Dry Block, Sunlight Resistant, Indoor/Outdoor

OFNP



Oil, Abrasion, Chemical  
and Sunlight Resistant  
PVDF Jacket

Central Strength Element

Buffered Optical Fiber

Dielectric Aramid  
Strength Members

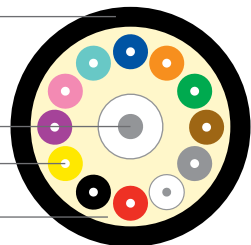

Oil, Abrasion, Chemical and  
Sunlight Resistant PVDF Jacket

Flame Retardant PVC Jacket

Buffered Optical Fiber

Central Strength Member

Water-Blocking Tape

Water-Blocking Dielectric  
Aramid Strength Members

Rip Cord

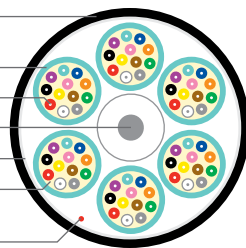

## SPECIFICATIONS

<b>Single Unit Configuration</b>	2 to 24 optical fibers surrounded by dielectric strength elements with an overall jacket
<b>Multi-unit Configuration</b>	6 or 12 fiber subunits stranded around a central strength element
<b>Subunit Jacket</b>	Plenum grade PVC whose color matches the fiber type
<b>Fiber Type</b>	900 micron tight buffered 250 micron optical fiber
<b>Dielectric Strength Elements</b>	Glass Reinforced Plastic (GRP) and aramid yarns
<b>Water-Blocking</b>	SAP Dry Block
<b>Jacket</b>	Oil, chemical, abrasion and UV resistant plenum grade black PVDF
<b>Performance Compliance</b>	UL 1651 CSA C22.2 No. 232 NFPA 130 NFPA 262 ANSI/ICEA S-104-696-2001 ANSI/TIA-568.3-D
<b>NRTL Programs</b>	UL, c(UL) Listed OFNP UL, c(UL) Listed Sunlight Resistant
<b>Sustainability</b>	UL Certified EPD HPD USGBC® Member RoHS-compliant/RoHS 2-compliant REACH-compliant

## ENVIRONMENTAL SPECIFICATIONS

<b>Operation</b>	-40°C to +70°C
<b>Storage/Shipping</b>	-40°C to +70°C
<b>Installation</b>	0°C to +60°C

## SUSTAINABILITY LEADERSHIP



UL and the related logo are registered trademarks of UL LLC. Health Product Declaration, HPD and the related logo are trademarks of Health Product Declaration Collaborative. USGBC and the related logo are registered trademarks of U.S. Green Building Council.

## PRODUCT DESCRIPTION

**FIRST MANUFACTURER IN THE INDUSTRY**  
to offer products that contribute toward LEED!

The Superior Essex Dry Block, Sunlight Resistant Indoor/Outdoor Plenum cable is designed to survive the toughest installation and environmental conditions. Not only does the cable exceed the rigorous Indoor/Outdoor plenum cable performance requirements of ICEA 696, but its proprietary thermoplastic jacket makes it resistant to mechanical abrasion, chemicals, oil and sunlight. The cable core consists of 2 through 24 fibers for the single unit and, for the multi-unit, 3 to 6 subunits of 6 or 12 fibers each. GRP and aramid yarn dielectric strength elements give the cable both strength and flexibility and the core is fully water-blocking using dry SAP technology. The cable is available in TeraFlex® Bend Resistant optical fiber types, including both single mode, 62.5, and OM3/4 multimode fiber.

## APPLICATIONS

- Intra/inter-building backbones
- Conduit/duct/tray pathways
- Dry or wet locations

## FEATURES

- UL® Certified Environmental Product Declaration (EPD)
- Health Product Declaration™ (HPD™)
- 900 micron tight buffered optical fibers
- Full water blocking with SAP Dry Block
- Tough, thermoplastic jacket
- Meets or exceeds ANSI/ICEA S-104-696-2001
- Plenum (OFNP) rated designs
- Available in both single mode and multimode TeraFlex Bend Resistant fiber types
- BrakeBox® payout control system for 2 to 12 fiber counts

## BENEFITS

- Contributes toward 1 LEED point under the Material and Resources credit (MRc)
- Contributes toward 1 LEED point under the MRC
- Allows for either fusion or mechanical connectors
- Prevents water ingress from OSP splice enclosures
- Abrasion, chemical, oil and sunlight resistant
- Worry-free installation and performance
- Plenum listing allows for cable placement in both plenum and riser spaces
- Choose the fiber needed for long distance, short-haul FTTx and data center applications
- Adjustable tension control on reel prevents over spin and entangling of cable

**PART NUMBER KEY**

<b>F</b>	<b>4</b>	<b>0</b>	<b>9</b>	<b>-</b>	<b>-</b>	<b>-</b>	<b>-</b>	<b>U</b>	<b>z</b>	<b>z</b>	<b>-</b>	<b>E</b>	<b>9</b>	<b>9</b>	<b>1</b>
1	2	3	4	5	6	7	8	9	10	11	12	13	14	15	16
Fiber cable	Listing	Cable type		-	Fiber count (002-048)			Fiber type			-	Jacket color	Package		Jacket print

Contact Customer Service for availability of non-standard offerings.

**PART NUMBERS AND PHYSICAL CHARACTERISTICS**

Part Number <sup>1</sup>	Configuration	Fiber Count	Nominal Diameter in (mm)	Nominal Weight lbs/kft (kg/km)	Maximum Tensile Loading		Minimum Bend Radius		Package <sup>1</sup>	
					Install lbs (N)	Long Term lbs (N)	Install in (mm)	Long Term in (mm)		
<b>Single Mode</b>										
W4002x1yy	Single unit	2	0.23 (5.9)	24 (36)	300 (1,340)	90 (400)	9.3 (236)	4.6 (118)	use key	
W4004x1yy	Single unit	4	0.23 (5.9)	25 (37)	300 (1,340)	90 (400)	9.3 (236)	4.6 (118)	use key	
W4006x1yy	Single unit	6	0.23 (5.9)	26 (39)	300 (1,340)	90 (400)	9.3 (236)	4.6 (118)	use key	
W4008x1yy	Single unit	8	0.26 (6.7)	32 (47)	300 (1,340)	90 (400)	10.6 (268)	5.3 (134)	use key	
W4012x1yy	Single unit	12	0.30 (7.5)	41 (62)	300 (1,340)	90 (400)	11.8 (300)	5.9 (150)	use key	
W4024xK01	Single unit	24	0.32 (8.2)	51 (77)	600 (2,680)	180 (800)	12.9 (328)	6.5 (164)	Plywood reel	
F409-024Uzz-E991	Multi-unit	24	0.59 (14.9)	133 (198)	600 (2,670)	180 (800)	23.5 (597)	11.7 (297)	Plywood reel	
F409-036Uzz-E991	Multi-unit	36	0.67 (17.1)	149 (223)	600 (2,670)	180 (800)	26.9 (683)	13.5 (343)	Plywood reel	
F409-048Uzz-E991	Multi-unit	48	0.67 (17.1)	150 (224)	600 (2,670)	180 (800)	26.9 (683)	13.5 (343)	Plywood reel	
F409-072Uzz-E991	Multi-unit	72	0.80 (20.2)	219 (327)	600 (2,670)	180 (800)	31.8 (808)	15.9 (404)	Plywood reel	
F409-096Uzz-E991	Multi-unit	96	0.91 (23.2)	359 (536)	600 (2,670)	180 (800)	36.5 (928)	18.3 (464)	Plywood reel	
<b>Multimode</b>										
W4002xGyy	Single unit	2	0.23 (5.9)	24 (36)	300 (1,340)	90 (400)	9.3 (236)	4.6 (118)	use key	
W4004xGyy	Single unit	4	0.23 (5.9)	25 (37)	300 (1,340)	90 (400)	9.3 (236)	4.6 (118)	use key	
W4006xGyy	Single unit	6	0.23 (5.9)	26 (39)	300 (1,340)	90 (400)	9.3 (236)	4.6 (118)	use key	
W4008xGyy	Single unit	8	0.26 (6.7)	32 (47)	300 (1,340)	90 (400)	10.6 (268)	5.3 (134)	use key	
W4012xGyy	Single unit	12	0.30 (7.5)	41 (62)	300 (1,340)	90 (400)	11.8 (300)	5.9 (150)	use key	
W4024xK01	Single unit	24	0.32 (8.2)	51 (77)	600 (2,680)	180 (800)	12.9 (328)	6.5 (164)	Plywood reel	
F409-024Uzz-E991	Multi-unit	24	0.59 (14.9)	133 (198)	600 (2,670)	180 (800)	23.5 (597)	11.7 (297)	Plywood reel	
F409-036Uzz-E991	Multi-unit	36	0.67 (17.1)	149 (223)	600 (2,670)	180 (800)	26.9 (683)	13.5 (343)	Plywood reel	
F409-048Uzz-E991	Multi-unit	48	0.67 (17.1)	150 (224)	600 (2,670)	180 (800)	26.9 (683)	13.5 (343)	Plywood reel	
F409-072Uzz-E991	Multi-unit	72	0.80 (20.2)	219 (327)	600 (2,670)	180 (800)	31.8 (808)	15.9 (404)	Plywood reel	
F409-096Uzz-E991	Multi-unit	96	0.91 (23.2)	359 (536)	600 (2,670)	180 (800)	36.5 (928)	18.3 (464)	Plywood reel	

**SINGLE MODE OPTICAL FIBER TYPES**

	TeraFlex® Bend Resistant		
	G.657.A1	G.657.A2	G.657.B3
Replace "x" with:	K	J	L
Replace "zz" with:	13	14	15
Typical Attenuation (dB/km)	0.32/0.18 (1310nm/1550nm)		
Max Attenuation (dB/km)	0.5/0.5 (1310nm/1550nm)		
Standard Jacket Colors*	Black		

\*Other jacket colors available upon request. See "Optical Fiber Specifications" in the "Technical Info" section for detailed fiber type specifications.

**PACKAGING**

	Cut to Length Plywood Reel	1,000 ft BrakeBox®	1,500 ft BrakeBox
<sup>1</sup> Replace "yy" with:	01	BB	BD
Fiber Counts	All	2 - 12	2 - 8

**MULTIMODE OPTICAL FIBER TYPES**

	TeraGain® 62.5/125	TeraFlex Bend Resistant Laser Optimized 50/125	
		OM3	OM4
Replace "x" with:	6	N	P
Replace "zz" with:	23	30	32
Minimum Bandwidth: (MHz-km)	220	2000	4700
Typical Attenuation (dB/km)	2.13/0.49 (850nm/1300nm)		
Max Attenuation (dB/km)	3.0/1.5 (850nm/1300nm)		
Standard Jacket Color*	Black		

\*Other jacket colors available upon request. See "Optical Fiber Specifications" in the "Technical Info" section for detailed fiber type specifications.

# Indoor/Outdoor, Interlock Armored, Tight Buffer

OFCR/OFCP



Flame Retardant and Sunlight Resistant Outer Jackets  
 Aluminum Interlocked Armor  
 Flame Retardant PVC Jacket  
 Central Strength Member  
 Buffered Optical Fiber  
 Dielectric Aramid Strength Members  
 Water-Blocking Tape

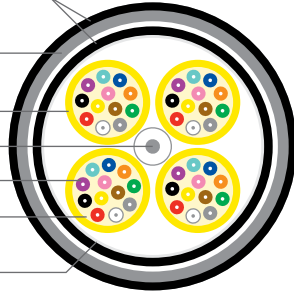

## SPECIFICATIONS

Interlock Armored	Flexible, heavy duty interlocking aluminum tape helically applied over the inner cable core; further protection is provided by flame retardant outer jacket
Outer Jacket	Black, FR, chemical resistant and sunlight resistant PVC <ul style="list-style-type: none"> <li>UL 1569</li> <li>UL 1651</li> <li>CSA C22.2 No. 232</li> <li>UL 1666</li> </ul>
Performance Compliance	NFPA 130 (Plenum) NFPA 262 Telcordia GR-409-CORE, Issue 2 ANSI/ICEA S-104-696 ANSI/TIA-568.3-D
NRTL Programs	UL, c(UL) Listed OFCR UL, c(UL) Listed OFCP UL, c(UL) Listed Sunlight Resistant
Sustainability	UL Certified EPD HPD USGBC® Member RoHS-compliant/RoHS 2-compliant REACH-compliant

## SUSTAINABILITY LEADERSHIP



**RoHS REACH**

UL and the related logo are registered trademarks of UL LLC. Health Product Declaration, HPD and the related logo are trademarks of Health Product Declaration Collaborative. Telcordia is a registered trademark of Ericsson Inc. USGBC and the related logo are registered trademarks of U.S. Green Building Council.

## PRODUCT DESCRIPTION

**FIRST MANUFACTURER IN THE INDUSTRY**  
 to offer products that contribute toward LEED!

Interlock Armored Optical Fiber Cables provide an extremely well protected cable package ideally suited for harsh environments. The armor is available in aluminum and comes with either an OFCR (riser) or OFCP (plenum) rating. This design offers the system designer a product that can be installed in areas where added mechanical protection and security are required. The flexible interlock armored cable design is also popular for retrofit applications and eliminates the need to install rigid conduit while still meeting building code guidelines.

## APPLICATIONS

- Intra-building backbones
- Conduit pathways
- Service entrance to communication closets

## FEATURES

- UL® Certified Environmental Product Declaration (EPD)
- Health Product Declaration™ (HPD™)
- Thick, flexible metallic armor
- Flame retardant, UL Listed designs
- Full line of Superior Essex cables available

## BENEFITS

- Contributes toward 1 LEED point under the Material and Resources credit (MRC)
- Contributes toward 1 LEED point under the MRC
- Reduce incidences of circuit disruption due to rodents or mechanically abusive applications
- Eliminates the need for multiple cables for installation
- Customized designs reduces cable inventory requirements

## ENVIRONMENTAL SPECIFICATIONS

	Riser	Plenum
Operation	-40°C to +75°C	-40°C to +70°C
Storage/Shipping	-40°C to +75°C	-40°C to +70°C
Installation	-20°C to +65°C	0°C to +60°C

**PART NUMBER KEY**

<b>F</b>	<b>2</b>	<b>0</b>	<b>9</b>	<b>-</b>	<b>-</b>	<b>-</b>	<b>-</b>	<b>U</b>	<b>y</b>	<b>y</b>	<b>-</b>	<b>E</b>	<b>9</b>	<b>9</b>	<b>1</b>
1	2	3	4	5	6	7	8	9	10	11	12	13	14	15	16
Fiber cable	Listing	Cable type		-	Fiber count (002-048)			Fiber type			-	Jacket color	Package		Jacket print

Contact Customer Service for availability of non-standard offerings.

**PART NUMBERS AND PHYSICAL CHARACTERISTICS**

Listing	Part Number <sup>1</sup>	Fiber Count	Nominal Diameter in (mm)	Nominal Weight lbs/kft (kg/km)	Maximum Compression lbf/in (N/cm)	Maximum Tensile Loading		Minimum Bend Radius	
						Install lbs (N)	Long Term lbs (N)	Install in (mm)	Long Term in (mm)
<b>Single Unit</b>									
OFCR	F108-002Uyy-E991	2	0.54 (13.8)	90 (134)	286 (500)	300 (1440)	90 (400)	21.8 (553)	10.9 (276)
OFCR	F108-004Uyy-E991	4	0.54 (13.8)	91 (135)	286 (500)	300 (1440)	90 (400)	21.8 (553)	10.9 (276)
OFCR	F108-006Uyy-E991	6	0.54 (13.8)	92 (137)	286 (500)	300 (1440)	90 (400)	21.8 (553)	10.9 (276)
OFCR	F108-008Uyy-E991	8	0.56 (14.1)	111 (165)	286 (500)	300 (1440)	90 (400)	22.2 (564)	11.1 (282)
OFCR	F108-012Uyy-E991	12	0.61 (15.6)	112 (167)	286 (500)	300 (1440)	90 (400)	24.6 (625)	12.3 (312)
OFCR	F108-024Uyy-E991	24	0.67 (17.0)	153 (229)	286 (500)	600 (2,700)	180 (800)	26.8 (680)	13.4 (340)
OFCP	L4002xW01	2	0.50 (12.7)	78 (116)	286 (500)	150 (670)	45 (200)	20.8 (528)	10.4 (264)
OFCP	L4004xW01	4	0.50 (12.7)	79 (118)	286 (500)	150 (670)	45 (200)	20.8 (528)	10.4 (264)
OFCP	L4006xW01	6	0.50 (12.7)	88 (131)	286 (500)	150 (670)	45 (200)	20.8 (528)	10.4 (264)
OFCP	L4008xW01	8	0.50 (12.7)	90 (134)	286 (500)	150 (670)	45 (200)	20.8 (528)	10.4 (264)
OFCP	L4012xW01	12	0.55 (13.9)	104 (155)	286 (500)	150 (670)	45 (200)	21.7 (552)	10.9 (276)
OFCP	L4024xKWQ	24	0.66 (16.8)	163 (243)	286 (500)	600 (2,700)	180 (800)	26.5 (672)	13.2 (336)
<b>Multi-Unit</b>									
OFCR	L3024xW01	24	0.93 (23.6)	265 (396)	228 (400)	600 (2,700)	180 (800)	35.7 (907)	17.8 (482)
OFCR	L3036xW01	36	1.05 (26.7)	351 (523)	171 (300)	600 (2,700)	180 (800)	42.0 (1066)	21.0 (533)
OFCR	L3048xW01	48	1.02 (26.0)	321 (479)	171 (300)	600 (2,700)	180 (800)	40.9 (1040)	20.5 (520)
OFCR	L3072xW01	72	1.14 (28.9)	409 (610)	171 (300)	600 (2,700)	180 (800)	44.7 (1135)	22.3 (567)
OFCR	L3096xW01	96	1.17 (29.7)	443 (660)	171 (300)	600 (2,700)	180 (800)	51.1 (1299)	25.6 (649)
OFCR	L3144xW01	144	1.35 (34.2)	573 (854)	171 (300)	600 (2,700)	180 (800)	55.2 (1402)	27.6 (701)
OFCP	F209-024Uyy-E991	24	1.40 (35.6)	297 (442)	228 (400)	600 (2,700)	180 (800)	36.9 (936)	18.4 (468)
OFCP	F209-036Uyy-E991	36	1.50 (38.1)	335 (499)	171 (300)	600 (2,700)	180 (800)	40.9 (1040)	20.5 (520)
OFCP	F209-048Uyy-E991	48	1.50 (38.1)	336 (500)	171 (300)	600 (2,700)	180 (800)	40.9 (1040)	20.5 (520)
OFCP	F209-072Uyy-E991	72	1.50 (38.1)	450 (670)	171 (300)	600 (2,700)	180 (800)	48.0 (1220)	24.0 (610)

<sup>1</sup>Part numbers listed above are aluminum interlock armored. Steel interlock armored available upon request.

**SINGLE MODE OPTICAL FIBER TYPES**

	TeraFlex® Bend Resistant		
	G.657.A1	G.657.A2	G.657.B3
Replace "x" with:	K	J	L
Replace "yy" with:	13	14	15
Typical Attenuation (dB/km)	0.32/0.32/0.18 (1310/1382/1550nm)		
Max Attenuation (dB/km)	0.5/0.5/0.5 (1310/1382/1550nm)		
Standard Jacket Color*	Black		

\*Other jacket colors available upon request. See "Optical Fiber Specifications" in the "Technical Info" section for detailed fiber type specifications.

**MULTIMODE OPTICAL FIBER TYPES**

	TeraFlex Bend Resistant Laser Optimized 50/125	
	TeraGain® 62.5/125	OM3 OM4
Replace "x" with:	6	N P
Replace "yy" with:	23	30 32
Minimum Bandwidth: OFL (MHz-km)	220/500 (850/1300nm)	— —
Minimum Bandwidth: Laser EMB (MHz-km)	—	2000/500 (850/1300nm) 4700/500 (850/1300nm)
Typical Attenuation (dB/km)	2.5/0.7 (850/1300nm)	
Max Attenuation (dB/km)	3.5/1.5 (850/1300nm)	
Standard Jacket Color*	Black	

\*Other jacket colors available upon request. See "Optical Fiber Specifications" in the "Technical Info" section for detailed fiber type specifications.

# Composite (formerly Hybrid)

OFNR/OFNP

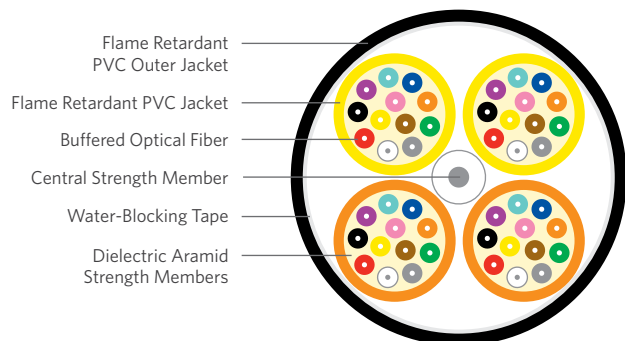

## SPECIFICATIONS

<b>Fiber Configuration</b>	Single mode fibers are placed first in the color sequence, followed by multimode fibers
<b>Performance Compliance</b>	UL 1651 CSA C22.2 No. 232 UL 1666 NFPA 262 Premises: Telcordia GR-409-CORE, Issue 2 and ANSI/ICEA S-83-596 Indoor/Outdoor: Telcordia GR-20-CORE, Issue 3 - ANSI/ICEA S-104-696 ANSI/TIA-568.3-D
<b>NRTL Programs</b>	UL, c(UL) Listed OFNR UL, c(UL) Listed OFNP
<b>Sustainability</b>	UL Certified EPD HPD USGBC® Member RoHS-compliant/RoHS 2-compliant REACH-compliant

## ENVIRONMENTAL SPECIFICATIONS

<b>Operation</b>	
<b>Storage/Shipping</b>	Refer to specification construction
<b>Installation</b>	

## PRODUCT DESCRIPTION

**FIRST MANUFACTURER IN THE INDUSTRY**  
to offer products that contribute toward LEED!

Superior Essex composite cables which have both multimode and single mode fibers within the same optical fiber cable in every construction type. The use of composite fiber designs have proven useful to network systems designers because they offer the flexibility to run diverse applications upgrades without the need to install new cables. Superior Essex composite optical fiber cables are available in tight buffer and loose tube premises distribution cables, as well as all other product designs. Composite cables are used for standard campus networking applications and can be manufactured with a wide variety of fiber type combinations. They can save the designer and the customer significant costs over the lifetime of the physical cable plant.

The standard configuration has single mode fibers first in the color and/or sub-unit scheme followed by multimode fibers.

## APPLICATIONS

- Intrabuilding backbones
- Interbuilding backbone (in conduit)
- Conduit pathways
- Service entrance to communication closets

## FEATURES

- UL® Certified Environmental Product Declaration (EPD)
- Health Product Declaration™ (HPD™)
- Telcordia® GR-409-CORE and GR-20-CORE qualified designs
- Multimode and single mode under one jacket
- Compliant with ANSI/TIA-568.3-D
- Design options include: interlock armored, indoor/outdoor, tight buffered riser and plenum
- Subunits are color coded according to fiber type

## BENEFITS

- Contributes toward 1 LEED point under the Material and Resources credit (MRc)
- Contributes toward 1 LEED point under the MRC
- Most cost-effective cables for the varied applications
- Eliminates the need for additional pathway space for different cable types
- Assures compliance for all current networking applications
- Cable designs available for every application
- Easily identify fiber type

## SUSTAINABILITY LEADERSHIP



UL and the related logo are registered trademarks of UL LLC. Health Product Declaration, HPD and the related logo are trademarks of Health Product Declaration Collaborative. Telcordia is a registered trademark of Ericsson Inc. USGBC and the related logo are registered trademarks of U.S. Green Building Council.

## PART NUMBER KEY

F	-	-	-	-	-	-	-	U	x	x	-	y	9	9	1	-	z	z	z
1	2	3	4	5	6	7	8	9	10	11	12	13	14	15	16	17	18	19	20
Family				-	Fiber Count			Fiber Supplier	Fiber Combination		-	Jacket Color	Package		-	Fiber Count of Second Fiber Type			
Fxxx				-	nnn			U	xx		-	y	991		-	zzz			

## Example

Part Number	Cable Type	Primary Fiber Type	Number of Primary Fibers	Secondary Fiber Type	Number of Secondary Fibers	Jacket Color
F308-072UAJ-E991-024	I/O Riser Tight Buffer Multi-unit	G.657.A1 SMF	48	OM4	24	Black

Contact Customer Service for availability of non-standard offerings.

**PART NUMBERS AND PHYSICAL CHARACTERISTICS**

Listing	Part Number	Fiber Count	Nominal Diameter in (mm)	Nominal Weight lbs/kft (kg/km)	Maximum Tensile Loading		Minimum Bend Radius		Package	
					Install lbs (N)	Long Term lbs (N)	Install in (mm)	Long Term in (mm)		
<b>Single Unit Tight Buffer Premises Distribution</b>										
OFNR	F303-006Uxx-y991-zzz	6	0.20 (5.0)	17 (25)	150 (660)	45 (200)	3.0 (75)	2.0 (50)	Reel	
OFNR	F303-008Uxx-y991-zzz	8	0.24 (6.0)	20 (30)	150 (660)	45 (200)	3.5 (90)	2.4 (60)	Reel	
OFNR	F303-012Uxx-y991-zzz	12	0.26 (6.5)	25 (37)	150 (660)	45 (200)	3.8 (98)	2.6 (65)	Reel	
OFNR	F303-024Uxx-y991-zzz	24	0.33 (8.5)	44 (66)	300 (1,320)	90 (400)	5.0 (128)	3.3 (85)	Reel	
OFNP	F403-006Uxx-y991-zzz	6	0.20 (5.0)	17 (25)	100 (440)	30 (130)	3.0 (75)	2.0 (50)	Reel	
OFNP	F403-008Uxx-y991-zzz	8	0.21 (5.4)	19 (28)	100 (440)	30 (130)	3.2 (81)	2.1 (54)	Reel	
OFNP	F403-012Uxx-y991-zzz	12	0.24 (6.2)	24 (35)	100 (440)	30 (130)	3.7 (93)	2.4 (62)	Reel	
OFNP	F403-024Uxx-y991-zzz	24	0.31 (7.8)	42 (62)	300 (1,320)	90 (400)	4.6 (117)	3.1 (78)	Reel	
<b>Multi-Unit Tight Buffer Premises Distribution</b>										
OFNR	F310-024Uxx-y991-zzz	24	0.69 (17.5)	150 (224)	300 (1,320)	90 (400)	10.3 (262)	6.9 (175)	Reel	
OFNR	F310-036Uxx-y991-zzz	36	0.69 (17.5)	150 (224)	300 (1,320)	90 (400)	10.3 (262)	6.9 (175)	Reel	
OFNR	F304-048Uxx-y991-zzz	48	0.69 (17.5)	155 (232)	300 (1,320)	90 (400)	10.3 (262)	6.9 (175)	Reel	
OFNR	F304-072Uxx-y991-zzz	72	0.82 (21.0)	233 (348)	600 (2,640)	180 (800)	12.4 (314)	8.2 (210)	Reel	
OFNR	F304-096Uxx-y991-zzz	96	0.97 (24.7)	337 (503)	600 (2,640)	180 (800)	14.6 (370)	9.7 (247)	Reel	
OFNR	F304-144Uxx-y991-zzz	144	1.11 (28.3)	362 (540)	600 (2,640)	180 (800)	16.7 (425)	11.1 (283)	Reel	
OFNP	F410-024Uxx-y991-zzz	24	0.67 (17.1)	184 (275)	300 (1,320)	90 (400)	10.1 (257)	6.7 (171)	Reel	
OFNP	F410-036Uxx-y991-zzz	36	0.67 (17.1)	184 (275)	300 (1,320)	90 (400)	10.1 (257)	6.7 (171)	Reel	
OFNP	F404-048Uxx-y991-zzz	48	0.67 (17.1)	184 (275)	300 (1,320)	90 (400)	10.1 (257)	6.7 (171)	Reel	
OFNP	F404-072Uxx-y991-zzz	72	0.81 (20.6)	276 (412)	600 (2,640)	180 (800)	12.2 (309)	8.1 (206)	Reel	
OFNP	F404-096Uxx-y991-zzz	96	0.87 (22.0)	313 (467)	600 (2,640)	180 (800)	13.0 (330)	8.7 (220)	Reel	
OFNP	F404-144Uxx-y991-zzz	144	0.92 (23.4)	318 (474)	600 (2,640)	180 (800)	12.2 (309)	8.1 (206)	Reel	
<b>Single Unit Tight Buffer Indoor/Outdoor Tight Buffer</b>										
OFNR	F308-006Uxx-y991-zzz	6	0.23 (5.8)	21 (31)	300 (1340)	90 (400)	9.1 (232)	4.6 (116)	Reel	
OFNR	F308-008Uxx-y991-zzz	8	0.26 (6.6)	25 (37)	300 (1340)	90 (400)	10.4 (264)	5.2 (132)	Reel	
OFNR	F308-012Uxx-y991-zzz	12	0.30 (7.6)	36 (54)	300 (1340)	90 (400)	12.0 (304)	6.0 (152)	Reel	
OFNR	F308-024Uxx-y991-zzz	24	0.35 (8.8)	47 (70)	600 (2,640)	180 (800)	13.9 (352)	6.9 (176)	Reel	
OFNP	F408-006Uxx-y991-zzz	6	0.23 (5.9)	26 (39)	300 (1340)	90 (400)	9.3 (236)	4.6 (118)	Reel	
OFNP	F408-008Uxx-y991-zzz	8	0.26 (6.7)	32 (47)	300 (1340)	90 (400)	10.6 (268)	5.3 (134)	Reel	
OFNP	F408-012Uxx-y991-zzz	12	0.30 (7.5)	41 (62)	300 (1340)	90 (400)	11.8 (300)	5.9 (150)	Reel	
OFNP	F408-024Uxx-y991-zzz	24	0.32 (8.2)	51 (77)	600 (2,640)	180 (800)	12.9 (328)	6.5 (164)	Reel	
<b>Multi-Unit Tight Buffer Indoor/Outdoor Tight Buffer</b>										
OFNR	F309-024Uxx-y991-zzz	24	0.59 (14.9)	123 (184)	600 (2,640)	180 (800)	23.8 (604)	11.9 (302)	Reel	
OFNR	F309-036Uxx-y991-zzz	36	0.70 (17.7)	179 (267)	600 (2,640)	180 (800)	28.2 (716)	14.1 (358)	Reel	
OFNR	F309-048Uxx-y991-zzz	48	0.70 (17.8)	162 (242)	600 (2,640)	180 (800)	28.0 (712)	14.0 (356)	Reel	
OFNR	F309-072Uxx-y991-zzz	72	0.84 (21.3)	243 (362)	600 (2,640)	180 (800)	33.5 (852)	16.8 (426)	Reel	
OFNR	F309-096Uxx-y991-zzz	96	0.98 (25.0)	345 (515)	600 (2,640)	180 (800)	39.4 (1000)	19.7 (500)	Reel	
OFNR	F309-144Uxx-y991-zzz	144	1.11 (28.3)	375 (559)	600 (2,640)	180 (800)	45.2 (1148)	22.6 (574)	Reel	
OFNP	F409-024Uxx-y991-zzz	24	0.59 (14.9)	133 (198)	600 (2,640)	180 (800)	23.5 (597)	11.7 (297)	Reel	
OFNP	F409-036Uxx-y991-zzz	36	0.67 (17.1)	149 (223)	600 (2,640)	180 (800)	26.9 (683)	13.5 (343)	Reel	
OFNP	F409-048Uxx-y991-zzz	48	0.67 (17.1)	150 (224)	600 (2,640)	180 (800)	26.9 (683)	13.5 (343)	Reel	
OFNP	F409-072Uxx-y991-zzz	72	0.80 (20.2)	219 (327)	600 (2,640)	180 (800)	31.8 (808)	15.9 (404)	Reel	
OFNP	F409-096Uxx-y991-zzz	96	0.91 (23.2)	359 (536)	600 (2,640)	180 (800)	36.5 (928)	18.3 (464)	Reel	

SINGLE MODE OPTICAL FIBER TYPES			MULTIMODE OPTICAL FIBER TYPES			FIBER COMBINATION TABLE				
Subunit Color*	TeraFlex® Bend Resistant		TeraGain® 62.5/125	TeraFlex Bend Resistant Laser Optimized 50/125		Part Number Code	First Fiber Type	Second Fiber Type	Premises Jacket Color	Indoor/Outdoor Jacket Color
	G.657.A1	G.657.A2		G.657.B3	OM3					
	Yellow = 6		Orange = D	Aqua = K		AA		OM1	Orange = D	
						AJ	G.657.A1 SMF	OM4	Aqua = K	Black = E
						AR		OM3		

\*Other configurations available upon request.  
See "Optical Fiber Specifications" in the "Technical Info" section for detailed fiber type specifications.

# PowerWise® Fiber

CL3R-OF/CL3P-OF, CMR-OF/CMP-OF and FPLR-OF/FPLP-OF

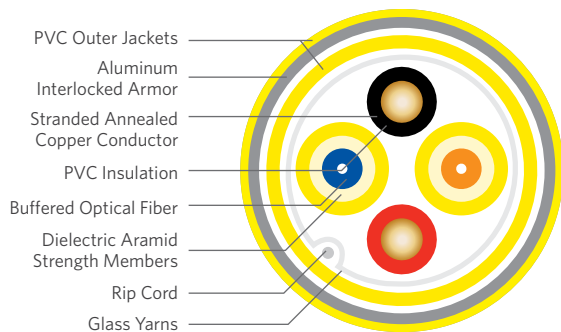
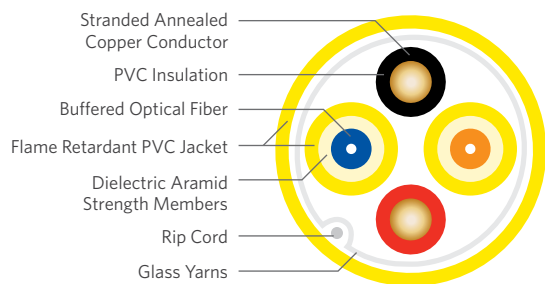

## SPECIFICATIONS

Configuration	Two (2) - 2 mm simplex and two (2) stranded 16 AWG copper conductors
2 mm Simplex	900 micron tight buffered fiber surrounded by aramid yarns strength elements and PVC jacket
Stranded 16 AWG conductors	19 strand annealed copper conductors insulated with PVC
Strength Elements	Glass yarn
Jacket	FR PVC
Interlock Armored	Flexible, heavy duty interlocking aluminum tape helically applied over the inner cable core; further protection is provided by an optional flame retardant outer jacket
Performance Compliance	UL® 13 CL3R-OF/CL3P-OF UL 444 CMR-OF/CMP-OF UL 1424 FPLR-OF/FPLP-OF UL 1666 NFPA 262 ANSI/ICEA S-83-596 Telcordia® GR-409-CORE, Issue 2 ANSI/TIA-568.3-D RoHS compliant/RoHS-2 compliant
NRTL Programs	UL Listed CL3R-OF/CL3P-OF, CMR-OF/CMP-OF, FPLR-OF/FPLP-OF

## ENVIRONMENTAL SPECIFICATIONS

	Riser	Plenum
Operation	-20 °C to +70 °C	0 °C to +70 °C
Installation	0 °C to +55 °C	0 °C to +55 °C

## PRODUCT DESCRIPTION

The PowerWise® cable is designed for premises applications where either the distance or the power requirements of the end device exceed what Power over Ethernet is capable of reaching or supplying. The cable consists of two (2) - 2 mm bend resistant fiber simplex interconnect cables and two (2) - stranded 16 AWG copper conductors. The two simplex interconnect cables allow direct and secure connection to LC or SC type mechanical connectors. The core is surrounded by strength yarns that provide the cable with the tensile strength to meet the distribution cable requirements of ANSI/ICEA S-83-596. The cable is UL Listed CL3R-OF/CL3P-OF, CMR-OF/CMP-OF and FPLR-OF/FPLP-OF.

## APPLICATIONS

- Security cameras and devices
- Devices placed in areas that exceed PoE distance or power requirements

## FEATURES

- Two (2) - 2 mm simplex
- 19-strand 16 AWG Conductors
- UL Listed CL3R-OF/CL3P-OF, CMR-OF/CMP-OF, and FPLR-OF/FPLP-OF
- Marked in Feet and Meters
- Interlock Armored Version

## BENEFITS

- Provides robust attachment to single ferrule connectors.
- Provides exceptional flexibility for easier installation and routing
- Multiple listings allows for different fire and safety applications
- Provides both commercial and military units of measure
- Provides additional protection to cable



**PART NUMBERS AND PHYSICAL CHARACTERISTICS**

Part Number <sup>1</sup>	Armor	Fiber Count	Conductor Count	AWG (mm)	Nominal Diameter in (mm)	Approx. Weight lbs/kft (kg/km)	Package
Riser							
F3C3-002Uxx-y991-CE9	No armor	2	2	16 (1.47)	0.26 (6.6)	37 (56)	Plywood reel
F1C3-002Uxx-y991-CE9	Interlock armor	2	2	16 (1.47)	0.54 (13.8)	106 (159)	Plywood reel
Plenum							
F4C3-002U15-6991-CE9	No armor	2	2	16 (1.47)	0.29 (7.3)	47 (71)	Plywood reel
F2C3-002U15-6991-CE9	Interlock armor	2	2	16 (1.47)	0.64 (16.2)	118 (176)	Plywood reel

FIBER TYPES / STANDARD JACKET COLORS: <sup>*</sup>	SINGLE MODE			MULTIMODE		
	TeraFlex® Bend Resistant			TeraGain®	TeraFlex Bend Resistant Laser Optimized 50/125	
	G.657.A1	G.657.A2	G.657.B3	62.5/125	OM3	OM4
<sup>1</sup> Replace "xx" with:	13	14	15	23	30	32
<sup>1</sup> Replace "y" with:	Yellow = 6			Orange = D	Aqua = K	

<sup>\*</sup>Other jacket colors available upon request. See "Optical Fiber Specifications" in the "Technical Info" section for detailed fiber type specifications.

# PowerWise® CLT Fiber

CL3P-OF, CMP-OF

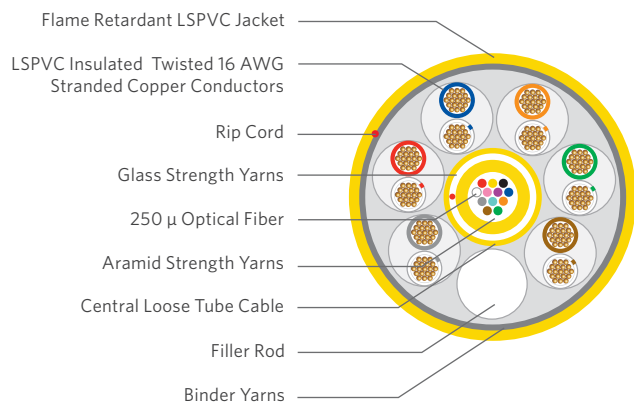
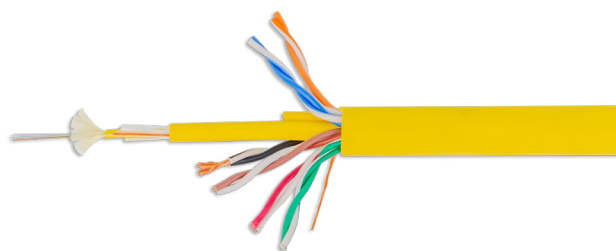

## SPECIFICATIONS

Configuration	12 fiber central loose tube cable and six pairs of stranded 16 AWG copper conductors
Central Loose Tube Cable	12 fibers and aramid yarns in 3 mm loose tube surrounded by glass strength elements and LSPVC plenum jacket
Stranded Conductors	Six pairs of 19 strand annealed 16 AWG copper conductors insulated with LSPVC
Jacket	Low Smoke Plenum PVC
Maximum Mutual Capacitance	< 40 pF
Voltage Rating	300 V
Performance Compliance	UL 13 CL3P-OF UL 444 CMP-OF NFPA 262 ANSI/ICEA S-83-596 ANSI/TIA-568.3-D RoHS, RoHS-2, RoHS-3 compliant
NRTL Programs	UL Listed CL3P-OF, c(UL) CMP-OF

## ENVIRONMENTAL SPECIFICATIONS

Operation	0 °C to +70 °C
Installation	0 °C to +55 °C
Storage	-40 °C to +70 °C

## PRODUCT DESCRIPTION

The PowerWise® cable is designed for remote antenna premises applications for either 5G or IEEE 802.11ax applications where the distance or the power requirements of the end device exceed Power-over-Ethernet limitations. The cable consists of a central loose tube cable with a 3 mm subunit containing bend resistant fiber and six pairs of stranded 16 AWG copper conductors. The overall cable meets the horizontal distribution cable requirements of ANSI/ICEA S-83-596 and is compliant with ANSI/TIA-568.3-D. The cable is UL Listed CL3P-OF and CMP-OF.

## APPLICATIONS

- IEEE 802.11ax Wireless Access Points
- 5G Remote Premises Antennas
- Security cameras and devices
- Devices placed in areas that exceed PoE distance or power limitations

## FEATURES

- 12 Fiber Loose Tube Cable
- 19-strand 16 AWG Conductors
- UL® Listed CL3P-OF, and CMP-OF
- Marked in Feet and Meters

## BENEFITS

- Provides data path for up to six end devices in small form factor
- Provides exceptional flexibility for easier installation and routing
- Listings allows for different fire and safety applications
- Provides both imperial and metric units of measure

**PART NUMBERS AND PHYSICAL CHARACTERISTICS**

Part Number <sup>1</sup>	Fiber Count	Nominal Diameter in (mm)	Approx. Weight lbs/kft (kg/km)	Maximum Tensile Loading		Package
				Install lbs (N)	Long Term lbs (N)	
F4C5-012Uxx-6991-CEC	12	0.63 (15)	212 (316)	150 (660)	45 (200)	Plywood reel

**SINGLE MODE**

TeraFlex® Bend Resistant		
G.657.A1	G.657.A2	G.657.B3
13	14	15

<sup>1</sup>Other jacket colors available upon request.  
See "Optical Fiber Specifications" in the "Technical Info" section for detailed fiber type specifications.  
UL is a registered trademark of UL LLC.

# PowerWise® Indoor/Outdoor 2x2 Hybrid

CL3R-OF/FPLR-OF Wet Location and CMR-OF

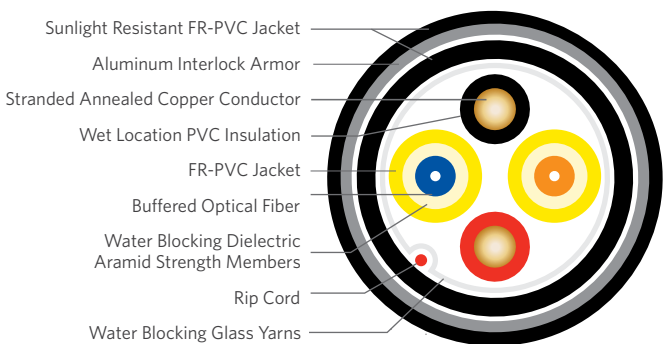
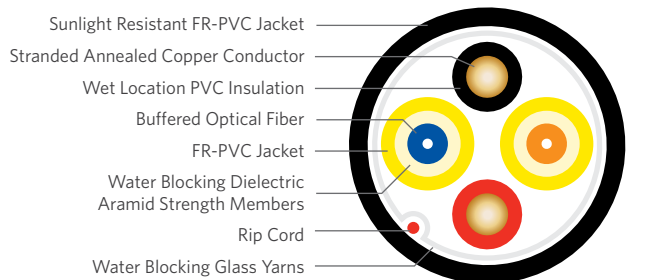
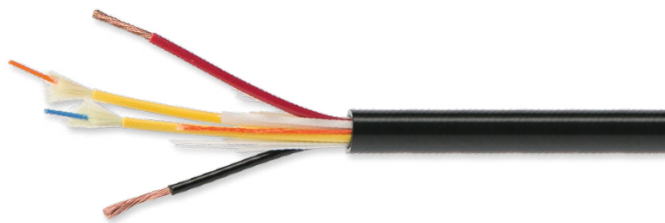

## PRODUCT DESCRIPTION

The PowerWise® Indoor/Outdoor 2x2 Fiber cable is designed for applications where either the distance or the power requirements of the end device exceed the limits of Power over Ethernet (PoE, PoE+). The cable consists of two (2) 2 mm interconnect simplexes and two (2) wet location PVC insulated 12 or 16 AWG stranded copper conductors. The core is surrounded by water-blocking glass strength yarns and a UL® Sunlight Resistant black jacket. The entire cable is ICEA-104-696 compliant and UL Listed CL3R-OF, CMR-OF and FPLR-OF. The cable is UL Wet Location listed. Other wire gauge sizes are available upon request.

## APPLICATIONS

- Security cameras and devices
- Applications exceeding 100 meter channel limit of PoE
- Passive Optical Networks (PON) / Passive Optical LAN (POL)

## FEATURES

- 2 (two) - 2 mm Interconnect Simplexes
- 12 or 16 AWG Stranded Conductors
- UL Listed CL3R-OF/FPLR-OF Wet Location and CMR-OF
- Marked in Feet and Meters
- Interlock Armored Version
- UL Sunlight Resistant black jacket on both armored and unarmored versions

## BENEFITS

- Allows internal cable to be routed separately from conductors
- Provides exceptional flexibility for easier installation and routing
- Multiple listings allows for different fire and security applications in wet locations
- Provides both commercial and military units of measure
- Provides additional mechanical protection to cable
- Insures long lifetime even in direct sunlight

## SPECIFICATIONS

<b>Configuration</b>	2 (two) - 2 mm interconnect simplexes and two (2) insulated 16 AWG stranded copper conductors
<b>Conductors</b>	Wet location PVC insulated stranded copper
16 AWG	19 x 0.0117"
12 AWG	19 x 0.0185"
<b>Optical Fiber</b>	2 mm OFNR Simplex Interconnects
<b>Strength Elements</b>	Water blocking glass yarns
<b>Jacket</b>	UL Sunlight Resistant Black FR PVC
<b>Interlock Armored</b>	Flexible, heavy duty interlocking aluminum tape helically applied over the inner cable core; further protection is provided by a UL Sunlight Resistant flame retardant black outer jacket
<b>Performance Compliance</b>	UL 13 CL3R-OF Wet Location UL 444 CMR-OF UL 1424 FPLR-OF Wet Location UL 1666 UL Sunlight Resistant UL Direct Burial (Interlock Armored) ANSI/ICEA S-83-596 ANSI/ICEA S-104-696 ANSI/TIA-568.3-D RoHS compliant/RoHS-2 compliant
<b>NRTL Programs</b>	UL Listed Sunlight Resistant, Wet Location, CL3R-OF, CMR-OF, FPLR-OF

## ENVIRONMENTAL SPECIFICATIONS

<b>Operation</b>	-40 °C to +70 °C
<b>Installation</b>	0 °C to +55 °C
<b>Storage</b>	-40 °C to +70 °C

**PART NUMBERS AND PHYSICAL CHARACTERISTICS**

Part Number <sup>1</sup>	Armor	Fiber Count	Conductor Count	AWG (mm)	Jacket Color	Nominal Diameter in (mm)	Approx. Weight lbs/kft (kg/km)	Package
F3C4-002Uxx-E991-CE9	No armor	2	2	16 (1.46)	Black	0.33 (8.4)	36.1 (54)	Plywood reel
F1C4-002Uxx-E991-CE9	Interlock armor	2	2	16 (1.46)	Black	0.64 (16.3)	128.3 (192)	Plywood reel
F3C4-002Uxx-E991-CED	No armor	2	2	12 (2.05)	Black	0.35 (9.0)	39.8 (60)	Plywood reel
F1C4-002Uxx-E991-CED	Interlock armor	2	2	12 (2.05)	Black	0.68 (17.2)	128.3 (203)	Plywood reel

FIBER TYPES / STANDARD JACKET COLORS: <sup>*</sup>	SINGLE MODE		MULTIMODE		
		TeraFlex® Bend Resistant		TeraFlex Bend Resistant Laser Optimized 50/125	
	G.657.B3		TeraGain® 62.5/125	OM3	OM4
<sup>1</sup> Replace "xx" with:	15		23	30	32
Standard Simplex Colors	Yellow		Orange	Aqua	

<sup>\*</sup>See "Optical Fiber Specifications" in the "Technical Info" section for detailed fiber type specifications.

# PowerWise® Indoor/Outdoor Tight Buffer Fiber

CL3R-OF, CMR-OF and FPLR-OF

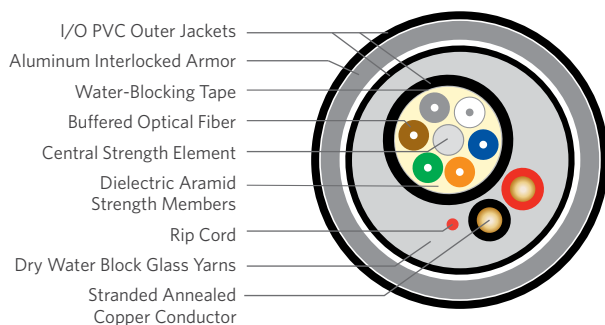
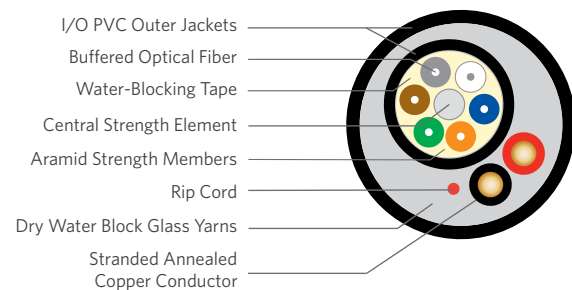
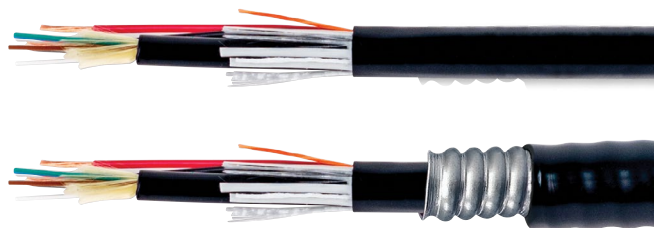

## PRODUCT DESCRIPTION

The PowerWise® Indoor/Outdoor Fiber cable is designed for applications where either the distance or the power requirements of the end device exceed the limits of Power over Ethernet (PoE, PoE+). The cable consists of self-contained ICEA-104-696 compliant 6-fiber indoor/outdoor distribution cable containing six (6) 900 micron tight buffered 62.5 micron multi-mode fibers. Alongside this cable are two (2) 18 AWG stranded copper conductors. The core is surrounded by water-blocking strength yarns and a UL Sunlight Resistant black jacket. An interlock armored version is also available. The entire cable is UL Listed CL3R-OF, CMR-OF and FPLR-OF.

## APPLICATIONS

- Security cameras and devices
- Applications exceeding TIA 100 meter channel requirements and powered by PoE
- Passive Optical Networks (PON) / Passive Optical LAN (POL)

## FEATURES

- 6 (six) - 62.5 MMF in an ICEA-696 Compliant Cable
- 18 AWG Conductors
- UL Listed CL3R-OF, CMR-OF, and FPLR-OF
- Marked in Feet and Meters
- Interlock Armored Version
- UL Sunlight Resistant black jacket on internal optical fiber cable, core cable and interlock armored cable.

## BENEFITS

- Allows internal cable to be routed separately from conductors
- Provides exceptional flexibility for easier installation and routing
- Multiple listings allows for different fire and security applications
- Provides both commercial and military units of measure
- Provides additional mechanical protection to cable
- Insures long lifetime even in direct sunlight

## SPECIFICATIONS

Configuration	6 (six) - 62.5 tight buffered indoor/outdoor with two (2) 18 AWG stranded copper conductors
Indoor/Outdoor cable	6 (six) - 62.5 micron tight buffered fiber single unit with black UL Sunlight Resistant jacket
18 AWG conductors	7 x 26 AWG stranded annealed copper conductors insulated with PVC
Strength Elements	Water blocking glass yarns
Jacket	UL Sunlight Resistant Black FR PVC
Interlock Armored	Flexible, heavy duty interlocking aluminum tape helically applied over the inner cable core; further protection is provided by a UL Sunlight Resistant flame retardant black outer jacket
Performance Compliance	UL® 13 CL3R-OF UL 444 CMR-OF UL 1424 FPLR-OF UL 1666 UL Sunlight Resistant ANSI/ICEA S-104-696 ANSI/TIA-568.3-D RoHS compliant/RoHS-2 compliant
NRTL Programs	UL Listed Sunlight Resistant, CL3R-OF, CMR-OF, FPLR-OF

## ENVIRONMENTAL SPECIFICATIONS

Operation	-40 °C to +70 °C
Installation	0 °C to +55 °C
Storage	-40 °C to +70 °C

**PART NUMBERS AND PHYSICAL CHARACTERISTICS**

Part Number	Armor	Fiber Count	Conductor Count	AWG (mm)	Jacket Color	Nominal Diameter in (mm)	Approx. Weight lbs/kft (kg/km)	Package
FG30-006U23-E991-CEB	No armor	6	2	18 (1.16)	Black	0.37 (9.3)	89.6 (134)	Plywood reel
FG31-006U23-E991-CEB	Interlock armor	6	2	18 (1.16)	Black	0.65 (16.6)	137 (202)	Plywood reel

# Bundled Composite Category 6

## CMR

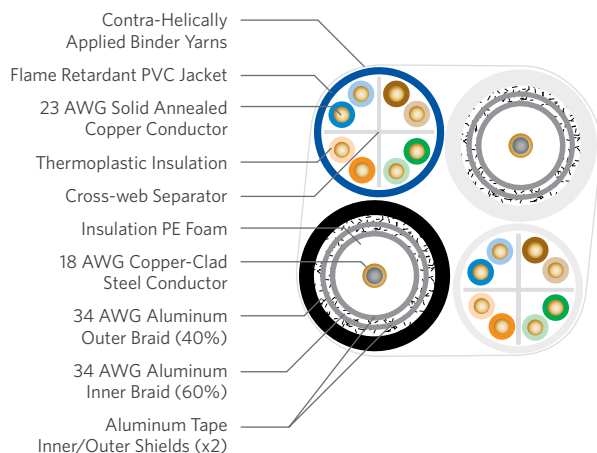

### SPECIFICATIONS

<b>CAT 6 UTP Component</b>	Pair Count: 4 Conductor: Solid annealed copper AWG (mm): 23 (0.57) Insulation: Thermoplastic Separator: Cross-web Jacket: Flame retardant PVC
<b>Characteristic Impedance (Ohms)</b>	100 ± 15
<b>Nominal Velocity of Propagation (%)</b>	70
<b>Fiber Component*</b>	62.5/125 µm duplex, 5 mm round, 900 µm tight buffered
<b>Coax RG-6 Quad Shield Component</b>	Conductor: Copper clad steel AWG (mm): 18 (1.02) Insulation: Polyethylene Inner Shield: 2.8 mil aluminum foil Inner Braid: 34 AWG aluminum (60%) Outer Shield: 1.8 mil aluminum foil Outer Braid: 34 AWG aluminum (40%) Jacket: PVC Electrical: See "Coax RG-6, Quad Shield CM, CMR, CMP" on page A-134
<b>Binder Yarn</b>	Flexible, dual binder yarns, contra-helically applied

### PRODUCT DESCRIPTION

Superior Essex offers multiple configurations of skip-wrapped or bundled riser-rated (CMR) composite cables to support common drop configurations used in residential structured wiring installations. These composite cables improve installation time and reduce the chance of violating minimum bend radius of the cable. The individual components support many technologies, including extended bandwidth satellite service, 1000BASE-T and 100BASE-TX Ethernet and high-definition TV signals. This product is also available with an optical fiber cable.

### APPLICATIONS

- 10BASE-T through 1000BASE-T Ethernet
- Power over Ethernet (PoE) - IEEE 802.3af
- PoE+ - IEEE 802.3at Type 1 and 2
- ATM and token ring
- HDTV, CATV, CCTV and DBS

### FEATURES

- All-in-one cable design
- RG-6 Quad Shield coaxial cable with typical bandwidth that exceeds 3 GHz
- Multiple constructions available
- Optional optical fiber premises cable
- Flexible, dual binder yarns, contra-helically applied

### BENEFITS

- Reduces installation time, provides additional protection to the individual cables
- "Future-Proofing" the installation. Supports extended bandwidth satellite service and high-definition TV signals
- Customized flexibility for the application
- Integrated fiber reduces the need to install separate cables for home interior optical networks
- Maintains maximum flexibility and allows for easy breakout

### SPECIFICATIONS (CONTINUED)

<b>Component Performance Compliance</b>	UL® 444 CSA C22.2 No. 214-08 UL 1666 ANSI/TIA-568.2-D ANSI/ICEA S-83-596-2001 Article 800, NEC (NFPA 70) RoHS-compliant/RoHS 2-compliant
<b>Component NRTL Programs</b>	UL, c(UL) Listed CMR

### PART NUMBERS AND PHYSICAL CHARACTERISTICS

Listing	Part Number	Type and Number of Cable Components			Nominal Diameter in (mm)	Nominal Weight lbs/kft (kg/km)	Package
		CAT 6	RG-6 Quad	62.5 2-fiber*			
CMR	D3-2009SA	1	1	-	0.53 (14)	56 (124)	Cut to length on plywood reel
CMR	D3-5009SA	1	2	-	0.56 (14)	88 (195)	Cut to length on plywood reel
CMR	D3-A009SA	2	1	-	0.51 (13)	81 (178)	Cut to length on plywood reel
CMR	D3-D009SA	2	2	-	0.67 (17)	113 (248)	Cut to length on plywood reel
CMR	D3-J009SA	3	1	-	0.67 (17)	105 (232)	Cut to length on plywood reel
CMR	D3-M009SA	3	2	-	0.81 (21)	137 (302)	Cut to length on plywood reel
CMR	D3-S009SA	4	1	-	0.82 (21)	130 (286)	Cut to length on plywood reel
CMR	D3-V009SA	4	2	-	0.85 (22)	162 (356)	Cut to length on plywood reel
CMR	D3-B169SA	2	1	1	0.56 (14)	95 (210)	Cut to length on plywood reel
CMR	D3-E169SA	2	2	1	0.51 (13)	127 (280)	Cut to length on plywood reel
CMR	D3-K169SA	3	1	1	0.67 (17)	120 (263)	Cut to length on plywood reel
CMR	D3-N169SA	3	2	1	0.67 (17)	152 (334)	Cut to length on plywood reel
CMR	D3-T169SA	4	1	1	0.81 (21)	144 (317)	Cut to length on plywood reel

\*Other fiber types and fiber counts available upon request. UL is a registered trademark of UL LLC.



# Bundled Composite Category 5e

CMR

## PRODUCT DESCRIPTION

Superior Essex offers multiple configurations of skip-wrapped or bundled riser-rated (CMR) composite cables to support common drop configurations used in residential structured wiring installations. These composite cables improve installation time and reduce the chance of violating minimum bend radius of the cable. The individual components support many technologies, including extended bandwidth satellite service, 1000BASE-T and 100BASE-TX Ethernet and high definition TV signals. This product is also available with an optical fiber cable.

## APPLICATIONS

- 10BASE-T through 1000BASE-T Ethernet
- Power over Ethernet (PoE) - IEEE 802.3af
- PoE+ - IEEE 802.3at Type 1 and 2
- ATM and token ring
- HDTV, CATV, CCTV and DBS

## FEATURES

- All-in-one cable design
- RG-6 Quad Shield coaxial cable with typical bandwidth that exceeds 3 GHz
- Multiple constructions available
- Optional optical fiber premises cable
- Flexible, dual binder yarns, contra-helically applied

## BENEFITS

- Reduces installation time, provides additional protection to the individual cables
- "Future-Proofing" the installation. Supports extended bandwidth satellite service and high-definition TV signals
- Customized flexibility for the application
- Integrated fiber reduces the need to install separate cables for home interior optical networks
- Maintains maximum flexibility and allows for easy breakout

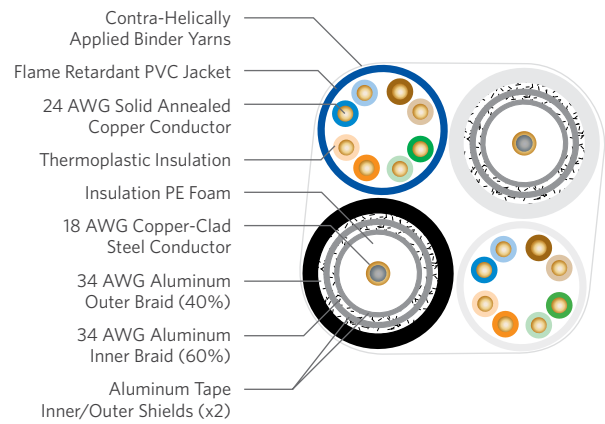

## SPECIFICATIONS

<b>CAT 5e UTP Component</b>	Pair Count: 4 Conductor: Solid annealed copper AWG (mm): 24 (0.51) Insulation: Thermoplastic Jacket: Flame retardant PVC
<b>Characteristic Impedance (Ohms)</b>	100 ± 15
<b>Nominal Velocity of Propagation (%)</b>	70
<b>Fiber Component*</b>	62.5/125 µm duplex, 5 mm round, 900 µm tight buffered
<b>Coax RG-6 Quad Shield Component</b>	Conductor: Copper clad steel AWG (mm): 18 (1.02) Insulation: Polyethylene Inner Shield: 2.8 mil aluminum foil Inner Braid: 34 AWG aluminum (60%) Outer Shield: 1.8 mil aluminum foil Outer Braid: 34 AWG aluminum (40%) Jacket: PVC Electrical: See "Coax RG-6, Quad Shield CM, CMR, CMP" on page A-134
<b>Binder Yarn</b>	Flexible, dual binder yarns, contra-helically applied

## SPECIFICATIONS (CONTINUED)

<b>Component Performance Compliance</b>	UL® 444 CSA C22.2 No. 214-08 UL 1666 ANSI/TIA-568.2-D ANSI/ICEA S-83-596-2001 Article 800, NEC (NFPA 70) RoHS-compliant/RoHS 2-compliant
<b>Component NRTL Programs</b>	UL, c(UL) Listed CMR

## PART NUMBERS AND PHYSICAL CHARACTERISTICS

Listing	Part Number	Type and Number of Cable Components			Nominal Diameter in (mm)	Nominal Weight lbs/kft (kg/km)	Package
		CAT 5e	RG-6 Quad	62.5 2-fiber*			
CMR	D1-2009S5	1	1	-	0.49 (12)	51 (113)	Cut to length on plywood reel
CMR	D1-5009S5	1	2	-	0.53 (13)	83 (183)	Cut to length on plywood reel
CMR	D1-A009S5	2	1	-	0.45 (12)	71 (156)	Cut to length on plywood reel
CMR	D1-D009S5	2	2	-	0.61 (16)	103 (226)	Cut to length on plywood reel
CMR	D1-J009S5	3	1	-	0.58 (15)	90 (198)	Cut to length on plywood reel
CMR	D1-M009S5	3	2	-	0.73 (19)	122 (269)	Cut to length on plywood reel
CMR	D1-S009S5	4	1	-	0.71 (18)	110 (241)	Cut to length on plywood reel
CMR	D1-V009S5	4	2	-	0.85 (22)	142 (311)	Cut to length on plywood reel
CMR	D1-3169S5	1	1	1	0.53 (13)	66 (145)	Cut to length on plywood reel
CMR	D1-6169S5	1	2	1	0.45 (12)	98 (215)	Cut to length on plywood reel
CMR	D1-B169S5	2	1	1	0.61 (16)	85 (187)	Cut to length on plywood reel
CMR	D1-E169S5	2	2	1	0.58 (15)	117 (258)	Cut to length on plywood reel
CMR	D1-K169S5	3	1	1	0.73 (19)	105 (230)	Cut to length on plywood reel
CMR	D1-N169S5	3	2	1	0.71 (18)	137 (300)	Cut to length on plywood reel
CMR	D1-T169S5	4	1	1	0.85 (22)	124 (273)	Cut to length on plywood reel
CMR	D1-W169S5	4	2	1	0.85 (22)	156 (343)	Cut to length on plywood reel

\*Other fiber types and fiber counts available upon request. UL is a registered trademark of UL LLC.

# Residential Broadband Riser

Coax RG-6 Quad Shield, Category 6 and Optical Fiber

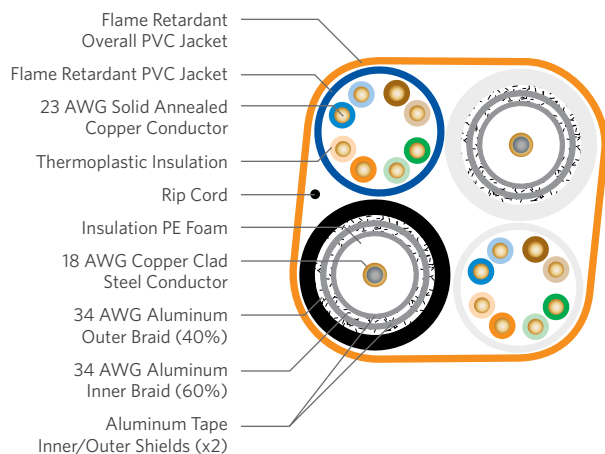

## SPECIFICATIONS

<b>CAT 6 UTP Component</b>	Pair Count: 4 Conductor: Solid annealed copper AWG (mm): 23 (0.57) Insulation: Thermoplastic Jacket: Flame retardant PVC
<b>Characteristic Impedance Ohms</b>	100 ± 15
<b>Nominal Velocity of Propagation %</b>	70
<b>Fiber Component</b>	62.5/125 µm duplex, 5 mm round, 900 µm tight buffered
<b>Coax RG-6 Quad Shield Component</b>	Conductor: Copper clad steel AWG (mm): 18 (1.02) Insulation: Polyethylene Inner Shield: 2.8 mil aluminum foil Inner Braid: 34 AWG aluminum (60%) Outer Shield: 1.8 mil aluminum foil Outer Braid: 34 AWG aluminum (40%) Jacket: PVC Electrical: See "Coax RG-6, Quad Shield CM, CMR, CMP" on page A-134
<b>Overall Jacket</b>	Orange, flame retardant PVC UL® 444 CSA C22.2 No. 214-08 UL 1666
<b>Performance Compliance</b>	ANSI/TIA-568.2-D ANSI/ICEA S-83-596-2001 Article 800, NEC (NFPA 70) RoHS-compliant/RoHS 2-compliant
<b>NRTL Programs</b>	UL, c(UL) Listed CMR

## PRODUCT DESCRIPTION

Superior Essex offers multiple configurations of Residential Broadband riser-rated (CMR) composite cables to support the three common drop configurations used in residential structured wiring installations. These composite cables improve installation time and reduce the chance of violating minimum bend radius of the cable. The individual components support many technologies, including extended bandwidth satellite service, 1000BASE-T and 100BASE-TX Ethernet and high-definition TV signals. This product is also available with a 62.5 µm duplex multimode fiber.

## APPLICATIONS

- 10BASE-T through 1000BASE-T Ethernet
- Power over Ethernet (PoE) - IEEE 802.3af
- PoE+ - IEEE 802.3at Type 1 and 2
- ATM and token ring
- HDTV, CATV, CCTV and DBS

## FEATURES

- All-in-one cable design
- RG-6 Quad Shield coaxial cable with typical bandwidth that exceeds 3 GHz
- Multiple constructions available
- TeraGain® multimode optical fiber (optional)

## BENEFITS

- Reduces installation time, provides additional protection to the individual cables
- "Future-Proofing" the installation. Supports extended bandwidth satellite service and high-definition TV signals
- Customized flexibility for the application
- Integrated fiber reduces the need to install separate cables for home interior optical networks

## PART NUMBERS AND PHYSICAL CHARACTERISTICS

Part Number	Description	Nominal Diameter in (mm)	Approx. Weight lbs/kft (kg/km)	Standard Length ft (m)	Package	Packages per Pallet
72-512-01	1 RG-6 Quad x 1 CAT 6	0.37 x 0.54 (9.27 x 13.59)	70 (104)	1,000 (305)	Plywood reel	4
72-621-03	2 RG-6 Quad x 2 CAT 6	0.62 x 0.54 (15.7 x 13.5)	130 (193)	500 (152)	Plywood reel	4
7A-621-03	2 RG-6 Quad x 2 CAT 6 x 1 Duplex 62.5/125 MMF	0.62 x 0.54 (15.7 x 13.6)	144 (214)	500 (152)	Plywood reel	4

UL is a registered trademark of UL LLC.

# Residential Broadband Riser

## Coax RG-6 Quad Shield, Category 5e and Optical Fiber

### PRODUCT DESCRIPTION

Superior Essex offers multiple configurations of Residential Broadband riser-rated (CMR) composite cables to support the three common drop configurations used in residential structured wiring installations. These composite cables improve installation time and reduce the chance of violating minimum bend radius of the cable. The individual components support many technologies, including extended bandwidth satellite service, 1000BASE-T and 100BASE-TX Ethernet and high definition TV signals. This product is also available with a 62.5 µm duplex multimode fiber.

### APPLICATIONS

- 10BASE-T through 1000BASE-T Ethernet
- Power over Ethernet (PoE) - IEEE 802.3af
- PoE+ - IEEE 802.3at Type 1 and 2
- ATM and token ring
- HDTV, CATV, CCTV and DBS

### FEATURES

- All-in-one cable design
- RG-6 Quad Shield coaxial cable with typical bandwidth that exceeds 3 GHz
- Multiple constructions available
- TeraGain® multimode optical fiber (optional)
- CAT 5e, 4-pair

### BENEFITS

- Reduces installation time, provides additional protection to the individual cables
- "Future-Proofing" the installation. Supports extended bandwidth satellite service and high-definition TV signals
- Customized flexibility for the application
- Integrated fiber reduces the need to install separate cables for home interior optical networks
- For high bandwidth applications

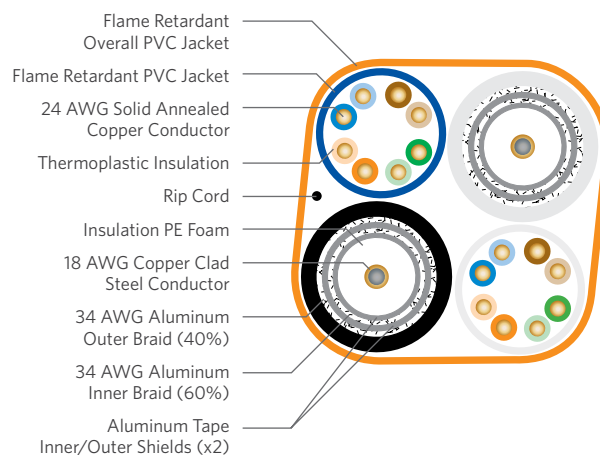

### SPECIFICATIONS

<b>CAT 5e UTP Component</b>	Pair Count: 4 Conductor: Solid annealed copper AWG (mm): 24 (0.51) Insulation: Thermoplastic Jacket: Flame retardant PVC
<b>Characteristic Impedance Ohms</b>	100 ± 15
<b>Nominal Velocity of Propagation %</b>	70
<b>Fiber Component</b>	62.5/125 µm duplex, 5 mm round, 900 µm tight buffered
<b>Coax RG-6 Quad Shield Component</b>	Conductor: Copper clad steel AWG (mm): 18 (1.02) Insulation: Polyethylene Inner Shield: 2.8 mil aluminum foil Inner Braid: 34 AWG aluminum (60%) Outer Shield: 1.8 mil aluminum foil Outer Braid: 34 AWG aluminum (40%) Jacket: PVC Electrical: See "Coax RG-6, Quad Shield CM, CMR, CMP" on page A-134
<b>Overall Jacket</b>	Orange, flame retardant PVC UL® 444 CSA C22.2 No. 214-08 UL 1666
<b>Performance Compliance</b>	ANSI/TIA-568.2-D ANSI/ICEA S-83-596-2001 Article 800, NEC (NFPA 70) RoHS-compliant/RoHS 2-compliant
<b>NRTL Programs</b>	UL, c(UL) Listed CMR

### PART NUMBERS AND PHYSICAL CHARACTERISTICS

Part Number	Description	Nominal Diameter in (mm)	Approx. Weight lbs/kft (kg/km)	Standard Length ft (m)	Package	Packages per Pallet
72-312-01	1 RG-6 Quad x 1 CAT 5e	0.365 x 0.535 (9.27 x 13.59)	73 (109)	1,000 (305)	Plywood reel	4
72-421-03	2 RG-6 Quad x 2 CAT 5e	0.640 x 0.535 (16.00 x 13.59)	135 (201)	500 (152)	Plywood reel	4
7A-421-03	2 RG-6 Quad x 2 CAT 5e x 1 Duplex 62.5/125 MMF	0.660 x 0.537 (16.80 x 13.64)	149 (222)	500 (152)	Plywood reel	4

UL is a registered trademark of UL LLC.

# 10Gain® XP Category 6A

CMR-LP/CMP-LP

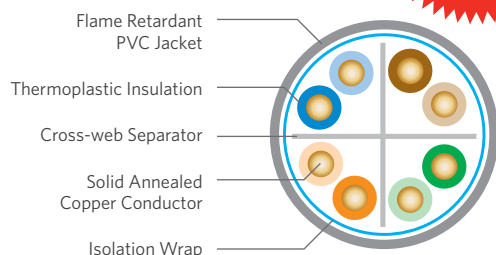

## SPECIFICATIONS

Pair Count	4
Conductor	Solid annealed copper
AWG (mm)	23 (0.57)
Insulation	CMR: Thermoplastic CMP: FEP
Insulation Colors	Pair 1: ColorTip Light Blue, Blue Pair 2: ColorTip Light Orange, Orange Pair 3: ColorTip Light Green, Green Pair 4: ColorTip Light Brown, Brown
Separator	Cross-web
Isolation Wrap	Proprietary construction
Jacket	CMR: Flame retardant (FR) PVC CMP: FR, low smoke PVC
Characteristic Impedance Ohms	100 ± 15
Velocity of Propagation %	CMR: 66 CMP: 71
Performance Compliance	UL 444 CSA C22.2 No. 214-08 UL 1666 NFPA 262 ANSI/TIA-568.2-D Article 800, NEC (NFPA 70) HDBaseT Class A and B
NRTL Programs	UL Verified CAT 6A UL Listed CMR-LP (0.5) c(UL) Listed CMR UL Listed CMP-LP (0.6) c(UL) Listed CMP HDBaseT Certified
Sustainability	UL Certified EPD HPD Multi-Attribute Certification USGBC® Member RoHS-compliant/RoHS 2-compliant REACH-compliant

## PRODUCT DESCRIPTION

**FIRST MANUFACTURER IN THE INDUSTRY**  
to offer products that contribute toward LEED!

**10Gain® XP** is the first Category 6A cable without a continuous shield to offer 7 dB margin over Alien Crosstalk (AXT) performance requirements in ANSI/TIA-568.2-D. Its uniquely designed Isolation Wrap contains discontinuous sections of metallized material, held in place by a polymeric layer. **10Gain XP** has a nominal 0.25" (CMP) or 0.275" (CMR) diameter that allows for higher cable density than other CAT 6A cable products. 10Gain XP is ideal for PoE applications requiring higher levels of current and simultaneously up to 10 Gigabit Ethernet. 10Gain XP is certified for HD A/V applications using HDBaseT Class A and B protocol.

## APPLICATIONS

- 10BASE-T through 10GBASE-T Ethernet
- Power over Ethernet (PoE) - IEEE 802.3bt Type 1 to 4
- ATM and token ring
- Backward compatible to legacy protocols and applications
- HDBaseT Class A and B

## FEATURES

- UL Certified Environmental Product Declaration (EPD)
- Health Product Declaration™ (HPD™)
- Multi-Attribute Certification by GreenCircle Certified, LLC
- Non-conductive Isolation Wrap
- Tested to 650 MHz
- Nominal 0.25 (CMP) or 0.275 (CMR) inch diameter
- CableID® alpha numeric code printed every 2 feet
- ColorTip® circuit identification system
- Tested up to 100 W in most severe temperature conditions in a bundle of 100 cables
- HDBaseT Class A and B certified
- UL LP listed
- Temperature cable rating: 75°C for CMR and 90°C for CMP

## BENEFITS

- Contributes toward 1 LEED credit under the Material and Resources credit (MRc)
- Contributes toward 1 LEED credit under the MRc
- Offers an overview of the sustainability of a product, its packaging and manufacturing
- 8 dB AXT performance without grounding or bonding
- Assures ample bandwidth headroom
- Higher cable density, smaller bend radius and lowers installation costs
- Easily identifies both ends of a cable run without the need to separately label or tone the cable
- Easily identify conductor mates even in low-light environments
- Offers 82% power efficiency and lowest temperature increase inside a bundle
- Ideal for any A/V application up to 100m channel
- Third-party assurance of product safety in high-heat and high-power applications
- Temperature rating of the insulation AND of the jacket provide improved cable lifespan despite high-heat and high-power applications

## PART NUMBERS AND PHYSICAL CHARACTERISTICS

Listing	Part Number <sup>1</sup>	Nominal Diameter in (mm)	Approx. Weight lbs/kft (kg/km)	Package	Packages per Pallet
CMR	6H-246-xA	0.275 (6.99)	28 (12.5)	1,000' BrakeBox®	12
CMR	6H-272-xA	0.275 (6.99)	28 (12.5)	1,000' Plywood reel	16
CMP	6H-246-xB	0.25 (6.35)	29 (13)	1,000' BrakeBox	12
CMP	6H-272-xB	0.25 (6.35)	29 (13)	1,000' Plywood reel	16

**JACKET COLORS**

¹Replace "x" with: Blue = 2 Gray = 3 White = 4 Green = 5 Yellow = 6 Purple = 7 Red = 9 Orange = D Black = E

**ELECTRICAL SPECIFICATIONS**

Frequency MHz	Insertion Loss @ 20°C Maximum dB/100 m		NEXT Minimum dB/100 m		ACR Minimum dB/100 m		PSNEXT Minimum dB/100 m		PSACR Minimum dB/100 m	
	Guaranteed	Typical	Guaranteed	Typical	Guaranteed	Typical	Guaranteed	Typical	Guaranteed	Typical
1	2.1	2.0	74.3	78.3	72.2	77.3	72.3	77.3	70.2	76.3
4	3.8	3.7	65.3	69.3	61.5	66.6	63.3	68.3	59.5	65.6
8	5.3	5.1	60.8	64.8	55.4	60.6	58.8	63.8	53.4	59.6
10	5.9	5.7	59.3	63.3	53.4	58.6	57.3	62.3	51.4	57.6
16	7.5	7.3	56.2	60.2	48.8	54.0	54.2	59.2	46.8	53.0
20	8.4	8.1	54.8	58.8	46.4	51.7	52.8	57.8	44.4	51.2
25	9.4	9.1	53.3	57.3	44.0	49.7	51.3	56.3	42.0	49.0
31.25	10.5	10.2	51.9	55.9	41.4	47.2	49.9	54.9	39.4	46.7
62.5	15.0	14.4	47.4	51.4	32.4	39.0	45.4	50.4	30.4	38.4
100	19.1	18.4	44.3	48.3	25.2	32.4	42.3	47.3	23.2	31.7
200	27.6	26.5	39.8	43.8	12.2	20.1	37.8	42.8	10.2	19.5
250	31.1	29.8	38.3	42.3	7.3	15.5	36.3	41.3	5.3	15.1
300	34.3	32.9	37.1	41.1	2.9	11.4	35.1	40.1	0.9	10.8
400	40.1	38.3	35.3	39.3		4.6	33.3	38.3		3.6
500	45.3	43.0	33.8	37.8			31.8	36.8		
600		47.5		36.4				35.6		
650		49.7		35.9				35.1		
700		51.4		35.5				34.6		
750		53.3		35.1				34.2		

Frequency MHz	Return Loss Minimum dB/100 m		ACRF Minimum dB/100 m		PSACRF Minimum dB/100 m		PSANEXT Minimum dB/100 m		PSAACRF Minimum dB/100 m	
	Guaranteed	Typical	Guaranteed	Typical	Guaranteed	Typical	Guaranteed	Typical	Guaranteed	Typical
1	20.0	22.0	67.8	73.8	64.8	70.8	75.0	96.5	75.0	80.0
4	23.0	25.0	55.8	61.8	52.8	58.8	75.0	87.5	74.2	79.2
8	24.5	26.5	49.7	55.7	46.7	52.7	75.0	83.0	68.1	73.1
10	25.0	27.0	47.8	53.8	44.8	50.8	75.0	81.5	66.2	71.2
16	25.0	27.0	43.7	49.7	40.7	46.7	75.0	80.0	62.1	67.1
20	25.0	27.0	41.8	47.8	38.8	44.8	75.0	80.0	60.2	65.2
25	24.3	26.3	39.8	45.8	36.8	42.8	75.0	80.0	58.2	63.2
31.25	23.6	25.6	37.9	43.9	34.9	40.9	75.0	80.0	56.3	61.3
62.5	21.5	23.5	31.9	37.9	28.9	34.9	73.6	78.6	50.3	55.3
100	20.1	22.1	27.8	33.8	24.8	30.8	70.5	75.5	46.2	51.2
200	18.0	20.0	21.8	27.8	18.8	24.8	66.0	71.0	40.2	45.2
250	17.3	19.3	19.8	25.8	16.8	22.8	64.5	69.5	38.2	43.2
300	16.8	18.8	18.3	24.3	15.3	21.3	63.3	68.3	36.7	41.7
400	15.9	17.9	15.8	21.8	12.8	18.8	64.5	66.5	35.2	39.2
500	15.2	17.2	13.8	19.8	10.8	16.8	60.0	65.0	32.3	37.2
600		16.7		18.2		15.2		63.8		35.6
650		16.4		17.5		14.5		63.3		34.9
700		16.2		16.9		13.9				
750		16.0		16.3		13.3				

**SUSTAINABILITY LEADERSHIP**



UL and the related logo are registered trademarks of UL LLC. Health Product Declaration, HPD and the related logo are trademarks of Health Product Declaration Collaborative. GreenCircle Certified logo is a registered trademark of GreenCircle Certified, LLC. USGBC and the related logo are registered trademarks of U.S. Green Building Council.

# 10Gain<sup>®</sup> + Category 6A

CMR/CMP

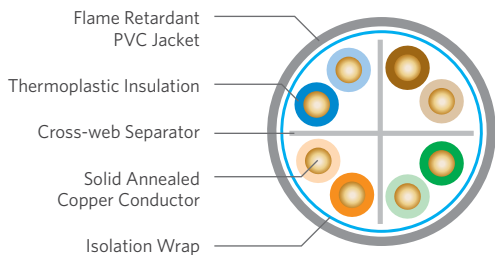

## SPECIFICATIONS

Pair Count	4
Conductor	Solid annealed copper
AWG (mm)	23 (0.57)
Insulation	CMR: Thermoplastic CMP: FEP
Insulation Colors	Pair 1: ColorTip Light Blue, Blue Pair 2: ColorTip Light Orange, Orange Pair 3: ColorTip Light Green, Green Pair 4: ColorTip Light Brown, Brown
Separator	Cross-web
Core Wrap	Proprietary construction
Jacket	CMR: Flame retardant (FR) PVC CMP: FR, low smoke PVC
Characteristic Impedance Ohms	100 ± 15
Velocity of Propagation %	CMR: 66 CMP: 71
Performance Compliance	UL 444 CSA C22.2 No. 214-08 UL 1666 ANSI/TIA-568.2-D Article 800, NEC (NFPA 70)
NRTL Programs	UL Verified CAT 6A UL Listed CMR-LP (0.5) c(UL) Listed CMR UL Listed CMP-LP (0.5) c(UL) Listed CMP
Sustainability	UL Certified EPD HPD Multi-Attribute Certification USGBC <sup>®</sup> Member RoHS-compliant/RoHS 2-compliant REACH-compliant

## PRODUCT DESCRIPTION

This CAT 6A cable meets or exceeds all industry requirements including ANSI/TIA-568.2-D. The cable utilizes a proprietary core wrap which assures excellent alien crosstalk performance. This cable fully complies with UL 444 requirements for an unshielded twisted pair product.

## APPLICATIONS

- 10BASE-T through 10GBASE-T Ethernet
- Power over Ethernet (PoE) - IEEE 802.3bt Type 1 to 4
- ATM and token ring
- Backward compatible to legacy protocols and applications
- HDBaseT Class A and B

## FEATURES

- UL Certified Environmental Product Declaration (EPD)
- Health Product Declaration<sup>™</sup> (HPD<sup>™</sup>)
- Multi-Attribute Certification by GreenCircle Certified, LLC
- Guaranteed 2 dB AXT margin
- UL Verified CAT 6A
- Tested to 650 MHz
- Nominal 0.29 (CMP)/0.265 (CMP) inch diameter
- Non-conductive core wrap
- CableID<sup>®</sup> alpha numeric code printed every 2 feet
- QuickCount<sup>®</sup> marking system in feet and meters
- ColorTip<sup>™</sup> circuit identification system

## BENEFITS

- Contributes toward 1 LEED credit under the Material and Resources credit (MRc)
- Contributes toward 1 LEED credit under the MRC
- Offers an overview of the sustainability of a product, its packaging and manufacturing
- Guaranteed AXT performance in virtually any installation environment
- Assures consistent worry-free performance
- Assures ample bandwidth headroom
- Higher cable density, smaller bend radius and lowers installation costs
- Provides substantially more AXT protection without grounding or bonding
- Allows both ends of a cable run to be easily identifiable without the need to separately label or tone the cable
- Provides remaining length of cable on reel
- Easily identifiable conductor mates even in low-light environments

## PART NUMBERS AND PHYSICAL CHARACTERISTICS

Listing	Part Number <sup>1</sup>	Nominal Diameter in (mm)	Approx. Weight lbs/kft (kg/km)	Package	Packages per Pallet
CMR	6B-246-xA	0.29 (7.4)	31 (47)	1,000' BrakeBox <sup>®</sup>	12
CMR	6B-272-xA	0.29 (7.4)	31 (47)	1,000' Plywood reel	16
CMP	6B-246-xB	0.265 (6.7)	34 (50)	1,000' BrakeBox <sup>®</sup>	12
CMP	6B-272-xB	0.265 (6.7)	34 (50)	1,000' Plywood reel	16

## JACKET COLORS

<sup>1</sup>Replace "x" with: Blue = 2 Gray = 3 White = 4 Green = 5 Yellow = 6 Purple = 7 Red = 9 Orange = D

**ELECTRICAL SPECIFICATIONS**

Frequency MHz	Insertion Loss @ 20°C Maximum dB/100 m		NEXT Minimum dB/100 m		ACR Minimum dB/100 m		PSNEXT Minimum dB/100 m		PSACR Minimum dB/100 m	
	Guaranteed	Typical	Guaranteed	Typical	Guaranteed	Typical	Guaranteed	Typical	Guaranteed	Typical
1	2.1	2.0	74.3	78.3	72.2	77.3	72.3	77.3	70.2	76.3
4	3.8	3.7	65.3	69.3	61.5	66.6	63.3	68.3	59.5	65.6
8	5.3	5.1	60.8	64.8	55.4	60.6	58.8	63.8	53.4	59.6
10	5.9	5.7	59.3	63.3	53.4	58.6	57.3	62.3	51.4	57.6
16	7.5	7.3	56.2	60.2	48.8	54.0	54.2	59.2	46.8	53.0
20	8.4	8.1	54.8	58.8	46.4	51.7	52.8	57.8	44.4	51.2
25	9.4	9.1	53.3	57.3	44.0	49.7	51.3	56.3	42.0	49.0
31.25	10.5	10.2	51.9	55.9	41.4	47.2	49.9	54.9	39.4	46.7
62.5	15.0	14.4	47.4	51.4	32.4	39.0	45.4	50.4	30.4	38.4
100	19.1	18.4	44.3	48.3	25.2	32.4	42.3	47.3	23.2	31.7
200	27.6	26.5	39.8	43.8	12.2	20.1	37.8	42.8	10.2	19.5
250	31.1	29.8	38.3	42.3	7.3	15.5	36.3	41.3	5.3	15.1
300	34.3	32.9	37.1	41.1	2.9	11.4	35.1	40.1	0.9	10.8
400	40.1	38.3	35.3	39.3		4.6	33.3	38.3		3.6
500	45.3	43.0	33.8	37.8			31.8	36.8		
600		47.5		36.4				35.6		
650		49.7		35.9				35.1		
700		51.4		35.5				34.6		
750		53.3		35.1				34.2		

Frequency MHz	Return Loss Minimum dB/100 m		ACRF Minimum dB/100 m		PSACRF Minimum dB/100 m		PSANEXT Minimum dB/100 m		PSAACRF Minimum dB/100 m	
	Guaranteed	Typical	Guaranteed	Typical	Guaranteed	Typical	Guaranteed	Typical	Guaranteed	Typical
1	20.0	22.0	67.8	73.8	64.8	70.8	69.0	96.5	69.0	80.0
4	23.0	25.0	55.8	61.8	52.8	58.8	69.0	87.5	68.2	79.2
8	24.5	26.5	49.7	55.7	46.7	52.7	69.0	83.0	62.1	73.1
10	25.0	27.0	47.8	53.8	44.8	50.8	69.0	81.5	60.2	71.2
16	25.0	27.0	43.7	49.7	40.7	46.7	69.0	80.0	56.1	67.1
20	25.0	27.0	41.8	47.8	38.8	44.8	69.0	80.0	54.2	65.2
25	24.3	26.3	39.8	45.8	36.8	42.8	69.0	80.0	52.2	63.2
31.25	23.6	25.6	37.9	43.9	34.9	40.9	69.0	80.0	51.3	61.3
62.5	21.5	23.5	31.9	37.9	28.9	34.9	67.6	78.6	44.3	55.3
100	20.1	22.1	27.8	33.8	24.8	30.8	64.5	75.5	40.2	51.2
200	18.0	20.0	21.8	27.8	18.8	24.8	60.0	71.0	34.2	45.2
250	17.3	19.3	19.8	25.8	16.8	22.8	58.5	69.5	32.2	43.2
300	16.8	18.8	18.3	24.3	15.3	21.3	57.3	68.3	30.7	41.7
400	15.9	17.9	15.8	21.8	12.8	18.8	55.5	66.5	29.2	39.2
500	15.2	17.2	13.8	19.8	10.8	16.8	54.0	65.0	26.2	37.2
600		16.7		18.2		15.2		63.8		35.6
650		16.4		17.5		14.5		63.3		34.9
700		16.2		16.9		13.9				
750		16.0		16.3		13.3				

**SUSTAINABILITY LEADERSHIP**



UL and the related logo are registered trademarks of UL LLC. Health Product Declaration, HPD and the related logo are trademarks of Health Product Declaration Collaborative. GreenCircle Certified logo is a registered trademark of GreenCircle Certified, LLC. USGBC and the related logo are registered trademarks of U.S. Green Building Council.

# PowerWise® 10G 4PPoE

## CMP-LP

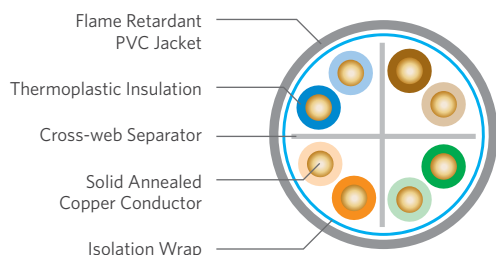

### SPECIFICATIONS

Pair Count	4
Conductor	Solid annealed copper
AWG (mm)	22 (0.64)
Insulation	FEP
Insulation Colors	Pair 1: ColorTip Light Blue, Blue Pair 2: ColorTip Light Orange, Orange Pair 3: ColorTip Light Green, Green Pair 4: ColorTip Light Brown, Brown
Jacket	FR, low smoke PVC
Characteristic Impedance Ohms	100 ± 15
Nominal Velocity of Propagation %	68
Performance Compliance	UL 444 CSA C22.2 No. 214-08 NFPA 262 ANSI/TIA-568.2-D ANSI/ICEA S-90-661-2012 Article 800, NEC (NFPA 70)
NRTL Programs	UL Verified CAT 6A UL listed CMP-LP (0.7) c(UL) CMP c(UL) listed CMR UL Listed CMP-LP (0.6) c(UL) Listed CMP HDBaseT Certified

### PRODUCT DESCRIPTION

PowerWise® 10G 4PPoE cables provide the best performance and overall value for 4 Pair Power over Ethernet (4PPoE) applications requiring up to 100W of power and up to 10 Gigabit Ethernet performance. PowerWise 10G 4PPoE cables are specifically designed to mitigate temperature build up, offer exceptional energy efficiency and ensure performance (up to 10 Gigabit Ethernet) over the lifetime of your system.

PowerWise 10G 4PPoE cable provides the performance benefits of a typical CAT6A cable without a continuous shield to offer 7 dB margin over Alien Crosstalk (AXT) performance requirements in ANSI/TIA-568.2-D. Its uniquely designed Isolation Wrap contains discontinuous sections of metallized material, held in place by a polymeric layer. Cable temperature increases are reduced and power efficiency is increased as a result of 22 gauge conductors. Plenum rated conductors are also 100% FEP insulated and ensure cable performance over the life of your system. PowerWise 10G 4PPoE cables are the best solution to connect and power your 4PPoE applications compared to standard CAT 6A designs.

### APPLICATIONS

- 10BASE-T through 10GBASE-T Ethernet
- Power over Ethernet (PoE) - IEEE 802.3af
- PoE+ - IEEE 802.3at Type 1 and 2
- 4PPoE - IEEE 802.3bt Type 3 and 4 draft D1.2
- ATM and token ring
- Backward compatible to legacy protocols and applications

### FEATURES

- Non-conductive Isolation Wrap
- Tested to 650 MHz
- Tested in most severe temperature conditions in bundle of 100 cables
- CableID® alpha numeric code printed every 2 feet
- QuickCount® marking system in feet and meters
- ColorTip® circuit identification system
- Color coded box labels
- UL LP listed
- Temperature cable rating: 90°C for CM

### BENEFITS

- 7 dB AXT performance without grounding or bonding
- Assures ample bandwidth headroom
- AWG 22 insulated wire offers 88% power efficiency and lowest temperature increase inside a bundle, the best of its class
- Allows both ends of a cable run to be easily identifiable without the need to separately label or tone the cable
- Provides remaining length of cable on reel
- Easily identifiable conductor mates even in low-light environments
- Easily identifies jacket colors
- Third-party assurance of product safety in high-heat and high-power applications
- Temperature rating of the insulation AND of the jacket provide improved cable lifespan despite high-heat and high-power applications

### PART NUMBERS AND PHYSICAL CHARACTERISTICS

Listing	Part Number <sup>1</sup>	Nominal Diameter in (mm)	Approx. Weight lbs/kft (kg/km)	Package	Packages per Pallet
CMP-LP	PW6H-H72-xB	0.30 (7.6)	48 (72)	1,000 ft Reel	12

### JACKET COLORS

<sup>1</sup>Replace "x" with: Blue = 2 Gray = 3 White = 4 Green = 5 Yellow = 6 Purple = 7 Red = 9 Black = E



## ELECTRICAL SPECIFICATIONS

Frequency MHz	Insertion Loss @ 20°C Maximum dB/100 m		NEXT Minimum dB/100 m		ACR Minimum dB/100 m		PSNEXT Minimum dB/100 m		PSACR Minimum dB/100 m	
	Guaranteed	Typical	Guaranteed	Typical	Guaranteed	Typical	Guaranteed	Typical	Guaranteed	Typical
1	2.1	2.0	74.3	78.3	72.2	77.3	72.3	77.3	70.2	76.3
4	3.8	3.7	65.3	69.3	61.5	66.6	63.3	68.3	59.5	65.6
8	5.3	5.1	60.8	64.8	55.4	60.6	58.8	63.8	53.4	59.6
10	5.9	5.7	59.3	63.3	53.4	58.6	57.3	62.3	51.4	57.6
16	7.5	7.3	56.2	60.2	48.8	54.0	54.2	59.2	46.8	53.0
20	8.4	8.1	54.8	58.8	46.4	51.7	52.8	57.8	44.4	51.2
25	9.4	9.1	53.3	57.3	44.0	49.7	51.3	56.3	42.0	49.0
31.25	10.5	10.2	51.9	55.9	41.4	47.2	49.9	54.9	39.4	46.7
62.5	15.0	14.4	47.4	51.4	32.4	39.0	45.4	50.4	30.4	38.4
100	19.1	18.4	44.3	48.3	25.2	32.4	42.3	47.3	23.2	31.7
200	27.6	26.5	39.8	43.8	12.2	20.1	37.8	42.8	10.2	19.5
250	31.1	29.8	38.3	42.3	7.3	15.5	36.3	41.3	5.3	15.1
300	34.3	32.9	37.1	41.1	2.9	11.4	35.1	40.1	0.9	10.8
400	40.1	38.3	35.3	39.3		4.6	33.3	38.3		3.6
500	45.3	43.0	33.8	37.8			31.8	36.8		
600		47.5		36.4				35.6		
650		49.7		35.9				35.1		
700		51.4		35.5				34.6		
750		53.3		35.1				34.2		

Frequency MHz	Return Loss Minimum dB/100 m		ACRF Minimum dB/100 m		PSACRF Minimum dB/100 m		PSANEXT Minimum dB/100 m		PSAACRF Minimum dB/100 m	
	Guaranteed	Typical	Guaranteed	Typical	Guaranteed	Typical	Guaranteed	Typical	Guaranteed	Typical
1	20.0	22.0	67.8	73.8	64.8	70.8	74.0	96.5	74.0	80.0
4	23.0	25.0	55.8	61.8	52.8	58.8	74.0	87.5	73.2	79.2
8	24.5	26.5	49.7	55.7	46.7	52.7	74.0	83.0	67.1	73.1
10	25.0	27.0	47.8	53.8	44.8	50.8	74.0	81.5	65.2	71.2
16	25.0	27.0	43.7	49.7	40.7	46.7	74.0	80.0	61.1	67.1
20	25.0	27.0	41.8	47.8	38.8	44.8	74.0	80.0	59.2	65.2
25	24.3	26.3	39.8	45.8	36.8	42.8	74.0	80.0	57.2	63.2
31.25	23.6	25.6	37.9	43.9	34.9	40.9	74.0	80.0	55.3	61.3
62.5	21.5	23.5	31.9	37.9	28.9	34.9	72.6	78.6	49.3	55.3
100	20.1	22.1	27.8	33.8	24.8	30.8	69.5	75.5	45.2	51.2
200	18.0	20.0	21.8	27.8	18.8	24.8	65.0	71.0	39.2	45.2
250	17.3	19.3	19.8	25.8	16.8	22.8	63.5	69.5	37.2	43.2
300	16.8	18.8	18.3	24.3	15.3	21.3	62.3	68.3	35.7	41.7
400	15.9	17.9	15.8	21.8	12.8	18.8	60.5	66.5	34.2	39.2
500	15.2	17.2	13.8	19.8	10.8	16.8	59.0	65.0	31.2	37.2
600		16.7		18.2		15.2		63.8		35.6
650		16.4		17.5		14.5		63.3		34.9
700		16.2		16.9		13.9				
750		16.0		16.3		13.3				

## SUSTAINABILITY LEADERSHIP



UL and the related logo are registered trademarks of UL LLC. Health Product Declaration, HPD and the related logo are trademarks of Health Product Declaration Collaborative. GreenCircle Certified logo is a registered trademark of GreenCircle Certified, LLC. USGBC and the related logo are registered trademarks of U.S. Green Building Council. GreenCircle Certified logo identifies this product as being manufactured in a certified Zero Waste to Landfill facility.

# 10Gain® Category 6A

CMR/CMP

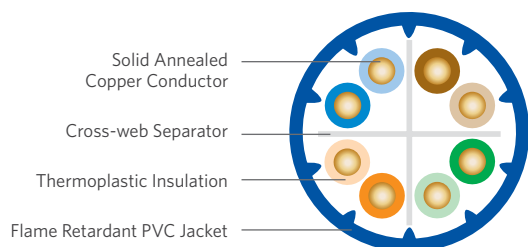

## SPECIFICATIONS

Pair Count	4
Conductor	Solid annealed copper
AWG (mm)	22 (0.63)
Insulation	CMR: Polyolefin CMP: FEP
Insulation Colors	Pair 1: ColorTip Light Blue, Blue Pair 2: ColorTip Light Orange, Orange Pair 3: ColorTip Light Green, Green Pair 4: ColorTip Light Brown, Brown
Separator	Cross-web
Jacket	CMR: Flame retardant (FR) PVC CMP: FR, low smoke PVC
Characteristic Impedance Ohms	100 ± 15
Velocity of Propagation %	CMR: 65 CMP: 68
Performance Compliance	UL 444 CSA C22.2 No. 214-08 UL 1666 NFPA 262 ANSI/TIA-568.2-D Article 800, NEC (NFPA 70)
NRTL Programs	UL Verified CAT 6A UL, c(UL) Listed CMR UL, c(UL) Listed CMP
Sustainability	UL Certified EPD HPD Multi-Attribute Certification USGBC® Member RoHS-compliant/RoHS 2-compliant REACH-compliant

## PRODUCT DESCRIPTION

10Gain® cable brings Category 6A UTP performance to a new level. This cable meets the internal and alien cross-talk performance requirements of ANSI/TIA-568.2-D as tested in a 6 around 1 configuration. With guaranteed performance out to 500 MHz and independently verified and monitored by UL, 10Gain CAT 6A cable demonstrates superior capability for 10 Gigabit Ethernet (10 GbE) and all other bandwidth intensive and legacy applications.

## APPLICATIONS

- 10BASE-T through 10GBASE-T Ethernet
- Power over Ethernet (PoE) - IEEE 802.3bt Type 1 to 4
- ATM and token ring
- Backward compatible to legacy protocols and applications

## FEATURES

- UL Verified CAT 6A
- Tested to 650 MHz
- Exceptional PSACR and PSAACRF (PSAELFEXT) performance
- CableID® alpha numeric code printed every 2 feet
- QuickCount® marking system in feet and meters
- ColorTip® circuit identification system

## BENEFITS

- Assures consistent, worry-free performance
- Assures ample bandwidth headroom
- Performance assurance for 10 GbE and multiple high-bandwidth applications
- Allows both ends of a cable run to be easily identifiable without the need to separately label or tone the cable
- Provides remaining length of cable on reel
- Easily identifiable conductor mates even in low-light environments

## PART NUMBERS AND PHYSICAL CHARACTERISTICS

Listing	Part Number <sup>1</sup>	Nominal Diameter in (mm)	Approx. Weight lbs/kft (kg/km)	Package	Packages per Pallet
CMR	6A-272-xA	0.350 (8.9)	51 (76)	1,000' Plywood reel	12
CMP	6A-246-xB	0.320 (8.1)	48 (72)	1,000' BrakeBox®	12
CMP	6A-272-xB	0.320 (8.1)	48 (72)	1,000' Plywood reel	12

## JACKET COLORS

<sup>1</sup>Replace "x" with: Blue = 2 Gray = 3 White = 4 Green = 5 Yellow = 6 Purple = 7 Red = 9 Orange = D Black = E

**ELECTRICAL SPECIFICATIONS**

Frequency MHz	Insertion Loss @ 20°C Maximum dB/100 m			NEXT Minimum dB/100 m			ACR Minimum dB/100 m			PSNEXT Minimum dB/100 m			PSACR Minimum dB/100 m		
	TIA-568.2-D		Superior Essex	TIA-568.2-D		Superior Essex	TIA-568.2-D		Superior Essex	TIA-568.2-D		Superior Essex	TIA-568.2-D		Superior Essex
	Specified	Guar.	Typical	Specified	Guar.	Typical	Calculated	Guar.	Typical	Specified	Guar.	Typical	Calculated	Guar.	Typical
1	2.7	2.0	1.7	74.3	75.3	92.4	72.2	74.3	90.7	72.3	74.3	90.3	70.2	72.3	88.7
4	3.8	3.6	3.4	65.3	66.3	82.2	61.5	63.5	78.9	63.3	65.3	80.5	59.5	61.5	77.2
8	5.3	5.1	4.7	60.8	61.8	78.0	55.5	57.5	73.3	58.8	60.8	76.4	53.5	55.5	71.7
10	5.9	5.7	5.3	59.3	60.3	76.5	53.4	55.4	71.2	57.3	59.3	74.8	51.4	53.4	69.6
16	7.5	7.2	6.7	56.2	57.2	73.8	48.8	50.8	67.2	54.2	56.2	72.0	46.7	48.8	65.4
20	8.4	8.1	7.6	54.8	55.8	71.1	46.4	48.5	63.6	52.8	54.8	69.7	44.4	46.5	62.2
25	9.4	9.1	8.5	53.3	54.3	68.9	43.9	46.0	60.5	51.3	53.3	67.4	41.9	44.0	59.1
31.25	10.5	10.2	9.5	51.9	52.9	68.3	41.4	43.5	58.9	49.9	51.9	67.0	39.4	41.5	57.6
62.5	15.0	14.5	13.6	47.4	48.4	64.3	32.4	34.5	50.8	45.4	47.4	62.3	30.4	32.5	49.0
100	19.1	18.5	17.4	44.3	45.3	61.2	25.2	27.3	44.0	42.3	44.3	59.2	23.2	25.3	42.2
200	27.6	26.8	25.1	39.8	40.8	57.1	12.2	14.3	32.4	37.8	39.8	54.9	10.2	12.3	30.3
250	31.1	30.2	28.2	38.3	39.3	55.9	7.2	9.4	27.6	36.3	38.3	53.3	5.2	7.4	25.4
300	34.3	33.3	31.1	37.1	38.1	53.7	2.8	5.0	22.8	35.1	37.1	51.5	0.8	3.0	20.9
350	37.2	36.3	33.8	36.1	37.1	52.7		1.0	19.1	34.1	36.1	50.1			16.9
400	40.1	39.0	36.3	35.3	37.3	52.4			15.3	33.3	36.3	49.3			13.5
500	45.3	44.1	41.0	33.8	35.8	48.7			7.7	31.8	34.8	46.2			5.8
550			43.2			45.6			2.3			43.7			1.0
600			45.3			44.0						42.2			
650			47.5			42.0						40.2			
700			48.3			41.1						40.8			
750			50.0			40.5						40.3			

Frequency MHz	Return Loss Minimum dB/100 m			ACRF Minimum dB/100 m			PSACRF Minimum dB/100 m			PSANEXT Minimum dB/100 m			PSAACRF Minimum dB/100 m		
	TIA-568.2-D		Superior Essex	TIA-568.2-D		Superior Essex	TIA-568.2-D		Superior Essex	TIA-568.2-D		Superior Essex	TIA-568.2-D		Superior Essex
	Specified	Guar.	Typical	Specified	Guar.	Typical	Specified	Guar.	Typical	Specified	Guar.	Typical	Specified	Guar.	Typical
1	20.0	20.0	27.3	67.8	69.8	83.6	64.8	68.8	81.2	67.0	67.0	94.8	67.0	67.0	71.2
4	23.0	23.0	33.1	55.8	57.8	72.0	52.8	56.8	69.6	67.0	67.0	85.7	66.2	66.2	70.3
8	24.5	24.5	35.3	49.7	51.7	66.2	46.7	50.7	63.7	67.0	67.0	81.2	60.1	60.1	64.3
10	25.0	25.0	36.0	47.8	49.8	64.4	44.8	48.8	61.8	67.0	67.0	79.8	58.2	58.2	62.4
16	25.0	25.0	36.5	43.7	45.7	60.3	40.7	44.7	57.8	67.0	67.0	76.7	54.1	54.1	58.3
20	25.0	25.0	38.4	41.8	43.8	58.4	38.8	42.8	56.0	67.0	67.0	75.3	52.2	52.2	56.4
25	24.3	24.3	37.6	39.8	41.8	56.3	36.8	40.8	54.1	67.0	67.0	73.8	50.2	50.2	54.4
31.25	23.6	23.6	37.8	37.9	39.9	54.3	34.9	38.9	52.1	67.0	67.0	72.4	48.3	48.3	52.5
62.5	21.5	21.5	36.6	31.9	33.9	48.3	28.9	32.9	46.1	65.6	65.6	67.8	42.3	42.3	46.5
100	20.1	20.1	33.5	27.8	29.8	44.5	24.8	28.8	42.3	62.5	62.5	64.8	38.2	38.2	42.4
200	18.0	18.0	30.7	21.8	23.8	38.4	18.8	22.8	36.2	58.0	58.0	60.3	32.2	32.2	36.4
250	17.3	17.3	30.3	19.8	21.8	35.0	16.8	20.8	33.4	56.5	56.5	58.8	30.2	30.2	34.4
300	16.8	16.8	26.9	18.3	19.3	33.8	15.3	19.3	31.6	55.3	55.3	57.6	28.7	28.7	32.8
350	16.3	16.3	27.0	16.9	17.9	32.5	13.9	17.9	30.4	54.3	54.3	56.6	27.3	27.3	31.5
400	15.9	15.9	26.9	15.8	15.8	31.8	12.8	16.8	29.8	53.5	53.5	55.7	26.2	26.2	30.3
500	15.2	15.2	24.8	13.8	13.8	29.8	10.8	14.8	28.1	52.0	52.0	54.3	24.2	24.2	28.4
550			24.2			28.8			26.9			53.7			27.6
600			22.7			28.6			26.4			53.1			26.8
650			19.6			27.2			25.3			52.6			26.1
700			19.1			26.8			24.9			52.1			25.5
750			17.8			26.2			24.3			51.7			24.9

**SUSTAINABILITY LEADERSHIP**



# Category 6A U/FTP (STP)

CMR/CMP

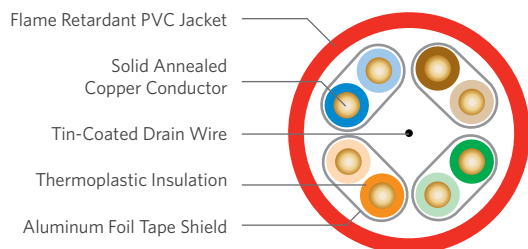

## SPECIFICATIONS

Configuration	Copper pairs each surrounded by aluminum/Mylar foil with center drain wire and jacket
Pair Count	4
Conductor	Solid annealed copper
AWG (mm)	23 (0.57)
Insulation	CMR: Polyolefin CMP: FEP
Insulation Colors	Pair 1: ColorTip Light Blue, Blue Pair 2: ColorTip Light Orange, Orange Pair 3: ColorTip Light Green, Green Pair 4: ColorTip Light Brown, Brown
Drain Wire	Tinned copper
Jacket	CMR: Flame retardant (FR) PVC CMP: FR, low smoke PVC
Characteristic Impedance Ohms	100 ± 15
Nominal Velocity of Propagation %	CMR: 73 CMP: 77
Performance Compliance	UL 444 CSA C22.2 No. 214-08 UL 1666 NFPA 262 ANSI/TIA-568.2-D Article 800, NEC (NFPA 70)
NRTL Programs	UL, c(UL) or ETL, c(ETL) Listed CMR UL, c(UL) or ETL, c(ETL) Listed CMP
Sustainability	UL Certified EPD HPD Multi-Attribute Certification USGBC® Member RoHS-compliant/RoHS 2-compliant REACH-compliant

## PRODUCT DESCRIPTION



**FIRST MANUFACTURER IN THE INDUSTRY**  
to offer products that contribute toward LEED!

Superior Essex offers Shielded Twisted Pair Category 6A cables in both plenum and riser versions. The cable has guaranteed performance to 600 MHz and meets or exceeds ANSI/TIA-568.2-D for CAT 6A cables required for 10GBASE-T applications. The cable consists of four (4) balanced 23 AWG copper pairs. Each pair is wrapped with a Mylar® backed aluminum foil with the drain wire in the center of all 4 copper pairs. The wrapped pairs are then jacketed with an appropriate flexible PVC jacket for either plenum or riser applications.

## APPLICATIONS

- 10BASE-T through 10GBASE-T Ethernet
- Power over Ethernet (PoE) - IEEE 802.3bt Type 1 to 4
- ATM and token ring
- Backward compatible to legacy protocols and applications

## FEATURES

- UL Certified Environmental Product Declaration (EPD)
- Health Product Declaration™ (HPD™)
- Multi-Attribute Certification by GreenCircle Certified, LLC
- Individually foil shielded pairs
- Exceeds specification ANSI/TIA-568.2-D for CAT 6A cable performance
- Riser and plenum rated designs
- QuickCount® marking system in feet and meters
- ColorTip® circuit identification system

## BENEFITS

- Contributes toward 1 LEED point under the Material and Resources credit (MRC)
- Contributes toward 1 LEED point under the MRC
- Offers an overview of the sustainability of a product, its packaging and manufacturing
- Protects against EMI/RFI and provides exceptional NEXT, PSNEXT, ELFEXT, and electrical performance
- Meets 10GBASE-T application requirements for both Insertion Loss and Return Loss and exceeds requirements for alien and internal crosstalk performance
- UL 1666 and NFPA 262 fire rating options help to reduce additional expensive materials required to meet building safety codes
- Provides remaining length of cable on reel
- Easily identifiable conductor mates even in low-light environments

## PART NUMBERS AND PHYSICAL CHARACTERISTICS

Listing	Part Number <sup>1</sup>	Nominal Diameter in (mm)	Approx. Weight lbs/kft (kg/km)	Package	Packages per Pallet
CMR	6S-220-xA	0.32 (8.1)	44 (66)	1,000' Plywood reel	12
CMP	6S-220-xB	0.32 (8.1)	51 (76)	1,000' Plywood reel	12

## JACKET COLORS

<sup>1</sup>Replace "x" with:

Blue = 2

Gray = 3

White = 4

Green = 5

Yellow = 6

Red = 9

Orange = D

Black = E

**ELECTRICAL SPECIFICATIONS**

Frequency MHz	Insertion Loss @ 20°C Maximum dB/100 m			NEXT Minimum dB/100 m			ACR Minimum dB/100 m			PSNEXT Minimum dB/100 m			PSACR Minimum dB/100 m		
	TIA-568.2-D		Superior Essex	TIA-568.2-D		Superior Essex	TIA-568.2-D		Superior Essex	TIA-568.2-D		Superior Essex	TIA-568.2-D		Superior Essex
	Specified	Guar.	Typical	Specified	Guar.	Typical	Calculated	Guar.	Typical	Specified	Guar.	Typical	Calculated	Guar.	Typical
1	2.1	2.1	2.0	74.3	82.3	84.8	72.2	80.2	82.8	72.3	80.3	82.8	70.2	78.2	80.8
4	3.8	3.8	3.7	65.3	73.3	75.8	61.5	69.5	72.1	63.3	71.3	73.8	59.5	67.5	70.1
8	5.3	5.3	5.2	60.8	68.8	71.3	55.5	63.5	66.1	58.8	66.8	69.3	53.5	61.5	64.1
10	5.9	5.9	5.8	59.3	67.3	69.8	53.4	61.4	64.0	57.3	65.3	67.8	51.4	59.4	62.0
16	7.5	7.5	7.3	56.2	64.2	66.7	48.7	56.7	59.4	54.2	62.2	64.7	46.7	54.7	57.4
20	8.4	8.4	8.2	54.8	62.8	65.3	46.4	54.4	57.1	52.8	60.8	63.3	44.4	52.4	55.1
25	9.4	9.4	9.2	53.3	61.3	63.8	43.9	51.9	54.6	51.3	59.3	61.8	41.9	49.9	52.6
31.25	10.5	10.5	10.3	51.9	59.9	62.4	41.4	49.4	52.1	49.9	57.9	60.4	39.4	47.4	50.1
62.5	15.0	15.0	14.7	47.4	55.4	57.9	32.4	40.4	43.2	45.4	53.4	55.9	30.4	38.4	41.2
100	19.1	19.1	18.8	44.3	52.3	54.8	25.2	33.2	36.0	42.3	50.3	52.8	23.2	31.2	34
200	27.6	27.6	27.0	39.8	47.8	50.3	12.2	20.2	23.3	37.8	45.8	48.3	10.2	18.2	21.3
250	31.1	31.1	30.4	38.3	46.3	48.8	7.2	15.2	18.4	36.3	44.3	46.8	5.2	13.2	16.4
300	34.3	34.3	33.6	37.1	45.1	47.6	2.8	10.8	14.0	35.1	43.1	45.6	0.8	8.8	12.0
350	37.2	37.2	36.5	36.1	44.1	46.6		6.9	10.1	34.1	42.1	44.6		4.9	8.1
400	40.1	40.1	39.3	35.3	43.3	45.8		3.2	6.5	33.3	41.3	43.8		1.2	4.5
500	45.3	45.3	44.4	33.8	41.8	44.3				31.8	39.8	42.3			
600		50.1	49.5		40.6	43.1					38.6	41.1			

Frequency MHz	Return Loss Minimum dB/100 m			ACRF Minimum dB/100 m			PSACRF Minimum dB/100 m			PSANEXT Minimum dB/100 m			PSAACRF Minimum dB/100 m		
	TIA-568.2-D		Superior Essex	TIA-568.2-D		Superior Essex	TIA-568.2-D		Superior Essex	TIA-568.2-D		Superior Essex	TIA-568.2-D		Superior Essex
	Specified	Guar.	Typical	Specified	Guar.	Typical	Specified	Guar.	Typical	Specified	Guar.	Typical	Specified	Guar.	Typical
1	20.0	20.0	20.6	67.8	69.8	73.8	64.8	66.8	70.8	67.0	70.0	72.0	67.0	70.0	72.0
4	23.0	23.0	23.7	55.8	57.8	61.8	52.8	54.8	58.8	67.0	70.0	72.0	66.2	69.2	71.2
8	24.5	24.5	25.3	49.7	51.7	55.7	46.7	48.7	52.7	67.0	70.0	72.0	60.1	63.1	65.1
10	25.0	25.0	25.8	47.8	49.8	53.8	44.8	46.8	50.8	67.0	70.0	72.0	58.2	61.2	63.2
16	25.0	25.0	25.8	43.7	45.7	49.7	40.7	42.7	46.7	67.0	70.0	72.0	54.1	57.1	59.1
20	25.0	25.0	25.8	41.8	43.8	47.8	38.8	40.8	44.8	67.0	70.0	72.0	52.2	55.2	57.2
25	24.3	24.3	25.1	39.8	41.8	45.8	36.8	38.8	42.8	67.0	70.0	72.0	50.2	53.2	55.2
31.25	23.6	23.6	24.3	37.9	39.9	43.9	34.9	36.9	40.9	67.0	70.0	72.0	48.3	51.3	53.3
62.5	21.5	21.5	22.2	31.9	33.9	37.9	28.9	30.9	34.9	65.6	68.6	70.6	42.3	45.3	47.3
100	20.1	20.1	20.7	27.8	29.8	33.8	24.8	26.8	30.8	62.5	65.5	67.5	38.2	41.2	43.2
200	18.0	18.0	18.5	21.8	23.8	27.8	18.8	20.8	24.8	58.0	61.0	63.0	32.2	35.2	37.2
250	17.3	17.3	17.8	19.8	21.8	25.8	16.8	18.8	22.8	56.5	59.5	61.5	30.2	33.2	35.2
300	16.8	16.8	17.3	18.3	20.3	24.3	15.3	17.3	21.3	55.3	58.3	60.3	28.7	31.7	33.7
350	16.3	16.3	16.8	16.9	18.9	22.9	13.9	15.9	19.9	54.3	57.3	59.3	27.3	30.3	32.3
400	15.9	15.9	16.4	15.8	17.8	21.8	12.8	14.8	18.8	53.5	56.5	58.5	26.2	29.2	31.2
500	15.2	15.2	15.7	13.8	15.8	19.8	10.8	12.8	16.8	52.0	55.0	57.0	24.2	27.2	29.2
600			15.1		14.2	18.2		11.2	15.2			55.1			28.6

**SUSTAINABILITY LEADERSHIP**



UL and the related logo are registered trademarks of UL LLC. Health Product Declaration, HPD and the related logo are trademarks of Health Product Declaration Collaborative. GreenCircle Certified logo is a registered trademark of GreenCircle Certified, LLC. USGBC and the related logo are registered trademarks of U.S. Green Building Council. Mylar is a registered trademark of E. I. du Pont de Nemours and Company or its affiliates.



# Category 6A U/FTP (STP) with FEP Jacket

CMP

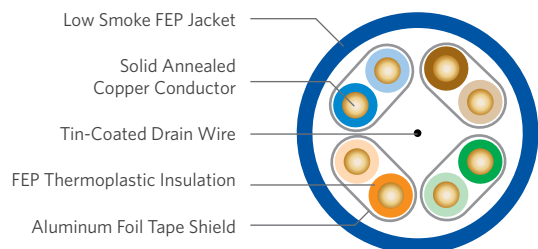
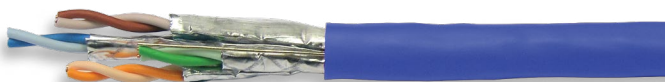

## SPECIFICATIONS

Configuration	Copper pairs each surrounded by aluminum/Mylar® foil with center drain wire and jacket
Pair Count	4
Conductor	Solid annealed copper
AWG (mm)	23 (0.57)
Insulation	FEP
Insulation Colors	Pair 1: ColorTip Light Blue, Blue Pair 2: ColorTip Light Orange, Orange Pair 3: ColorTip Light Green, Green Pair 4: ColorTip Light Brown, Brown
Drain Wire	Tinned copper
Jacket	Low smoke FEP
Characteristic Impedance Ohms	100 ± 15
Nominal Velocity of Propagation %	77
Performance Compliance	UL 444 NFPA 262 ANSI/TIA-568.2-D Article 800, NEC (NFPA 70) RoHS-compliant
NRTL Programs	UL Verified 6A UL, c(UL) or ETL, c(ETL) Listed CMP

## PRODUCT DESCRIPTION

Superior Essex offers Shielded Twisted Pair Category 6A cables with a plenum FEP jacket. The cable has guaranteed performance to 600 MHz and meets or exceeds ANSI/TIA-568.2-D for CAT 6A cables required for 10GBASE-T applications. The cable consists of four (4) balanced 23 AWG copper pairs. Each pair is wrapped with a Mylar® backed aluminum foil with the drain wire in the center of all 4 copper pairs. The wrapped pairs are then jacketed with a flexible FEP jacket for plenum applications.

## APPLICATIONS

- 10BASE-T through 10GBASE-T Ethernet
- Power over Ethernet (PoE) - IEEE 802.3af
- PoE+ - IEEE 802.3at Type 1 and 2
- ATM and token ring
- Backward compatible to legacy protocols and applications

## FEATURES

- Individually foil shielded pairs
- Exceeds specification ANSI/TIA-568.2-D for CAT 6A cable performance
- Plenum rated design
- FEP Jacket
- All fluoropolymer construction
- RoHS-compliant
- QuickCount® marking system in feet and meters
- ColorTip® circuit identification system
- Color-coded box labels

## BENEFITS

- Protects against EMI/RFI and provides exceptional NEXT, PSNEXT, ELFEXT, and electrical performance
- Meets 10GBASE-T application requirements for both Insertion Loss and Return Loss and exceeds requirements for alien and internal crosstalk performance
- NFPA 262 fire rating options help to reduce additional expensive materials required to meet building safety codes
- Lower smoke emission in plenum test than PVC
- Resistant to chemical, moisture, thermal exposure
- No heavy metals; no toxic components
- Provides remaining length of cable on reel
- Easily identifiable conductor mates even in low-light environments
- Easily identifiable jacket colors

## PART NUMBERS AND PHYSICAL CHARACTERISTICS

Part Number <sup>1</sup>	Nominal Diameter in (mm)	Approx. Weight lbs/kft (kg/km)	Package	Packages per Pallet
6S-220-xP	0.27 (6.9)	55 (82)	1,000' Plywood reel	12

## JACKET COLORS

<sup>1</sup>Replace "x" with: Blue = 2 White = 4

**ELECTRICAL SPECIFICATIONS**

Frequency MHz	Insertion Loss @ 20°C Maximum dB/100 m			NEXT Minimum dB/100 m			ACR Minimum dB/100 m			PSNEXT Minimum dB/100 m			PSACR Minimum dB/100 m		
	TIA-568.2-D		Superior Essex	TIA-568.2-D		Superior Essex	TIA-568.2-D		Superior Essex	TIA-568.2-D		Superior Essex	TIA-568.2-D		Superior Essex
	Specified	Guar.	Typical	Specified	Guar.	Typical	Calculated	Guar.	Typical	Specified	Guar.	Typical	Calculated	Guar.	Typical
1	2.1	2.1	2.0	74.3	82.3	84.8	72.2	80.2	82.8	72.3	80.3	82.8	70.2	78.2	80.8
4	3.8	3.8	3.7	65.3	73.3	75.8	61.5	69.5	72.1	63.3	71.3	73.8	59.5	67.5	70.1
8	5.3	5.3	5.2	60.8	68.8	71.3	55.5	63.5	66.1	58.8	66.8	69.3	53.5	61.5	64.1
10	5.9	5.9	5.8	59.3	67.3	69.8	53.4	61.4	64.0	57.3	65.3	67.8	51.4	59.4	62.0
16	7.5	7.5	7.3	56.2	64.2	66.7	48.7	56.7	59.4	54.2	62.2	64.7	46.7	54.7	57.4
20	8.4	8.4	8.2	54.8	62.8	65.3	46.4	54.4	57.1	52.8	60.8	63.3	44.4	52.4	55.1
25	9.4	9.4	9.2	53.3	61.3	63.8	43.9	51.9	54.6	51.3	59.3	61.8	41.9	49.9	52.6
31.25	10.5	10.5	10.3	51.9	59.9	62.4	41.4	49.4	52.1	49.9	57.9	60.4	39.4	47.4	50.1
62.5	15.0	15.0	14.7	47.4	55.4	57.9	32.4	40.4	43.2	45.4	53.4	55.9	30.4	38.4	41.2
100	19.1	19.1	18.8	44.3	52.3	54.8	25.2	33.2	36.0	42.3	50.3	52.8	23.2	31.2	34
200	27.6	27.6	27.0	39.8	47.8	50.3	12.2	20.2	23.3	37.8	45.8	48.3	10.2	18.2	21.3
250	31.1	31.1	30.4	38.3	46.3	48.8	7.2	15.2	18.4	36.3	44.3	46.8	5.2	13.2	16.4
300	34.3	34.3	33.6	37.1	45.1	47.6	2.8	10.8	14.0	35.1	43.1	45.6	0.8	8.8	12.0
350	37.2	37.2	36.5	36.1	44.1	46.6		6.9	10.1	34.1	42.1	44.6		4.9	8.1
400	40.1	40.1	39.3	35.3	43.3	45.8		3.2	6.5	33.3	41.3	43.8		1.2	4.5
500	45.3	45.3	44.4	33.8	41.8	44.3				31.8	39.8	42.3			
600		50.1	49.5		40.6	43.1					38.6	41.1			

Frequency MHz	Return Loss Minimum dB/100 m			ACRF Minimum dB/100 m			PSACRF Minimum dB/100 m			PSANEXT Minimum dB/100 m			PSAACRF Minimum dB/100 m		
	TIA-568.2-D		Superior Essex	TIA-568.2-D		Superior Essex	TIA-568.2-D		Superior Essex	TIA-568.2-D		Superior Essex	TIA-568.2-D		Superior Essex
	Specified	Guar.	Typical	Specified	Guar.	Typical	Specified	Guar.	Typical	Specified	Guar.	Typical	Specified	Guar.	Typical
1	20.0	20.0	20.6	67.8	69.8	73.8	64.8	66.8	70.8	67.0	70.0	72.0	67.0	70.0	72.0
4	23.0	23.0	23.7	55.8	57.8	61.8	52.8	54.8	58.8	67.0	70.0	72.0	66.2	69.2	71.2
8	24.5	24.5	25.3	49.7	51.7	55.7	46.7	48.7	52.7	67.0	70.0	72.0	60.1	63.1	65.1
10	25.0	25.0	25.8	47.8	49.8	53.8	44.8	46.8	50.8	67.0	70.0	72.0	58.2	61.2	63.2
16	25.0	25.0	25.8	43.7	45.7	49.7	40.7	42.7	46.7	67.0	70.0	72.0	54.1	57.1	59.1
20	25.0	25.0	25.8	41.8	43.8	47.8	38.8	40.8	44.8	67.0	70.0	72.0	52.2	55.2	57.2
25	24.3	24.3	25.1	39.8	41.8	45.8	36.8	38.8	42.8	67.0	70.0	72.0	50.2	53.2	55.2
31.25	23.6	23.6	24.3	37.9	39.9	43.9	34.9	36.9	40.9	67.0	70.0	72.0	48.3	51.3	53.3
62.5	21.5	21.5	22.2	31.9	33.9	37.9	28.9	30.9	34.9	65.6	68.6	70.6	42.3	45.3	47.3
100	20.1	20.1	20.7	27.8	29.8	33.8	24.8	26.8	30.8	62.5	65.5	67.5	38.2	41.2	43.2
200	18.0	18.0	18.5	21.8	23.8	27.8	18.8	20.8	24.8	58.0	61.0	63.0	32.2	35.2	37.2
250	17.3	17.3	17.8	19.8	21.8	25.8	16.8	18.8	22.8	56.5	59.5	61.5	30.2	33.2	35.2
300	16.8	16.8	17.3	18.3	20.3	24.3	15.3	17.3	21.3	55.3	58.3	60.3	28.7	31.7	33.7
350	16.3	16.3	16.8	16.9	18.9	22.9	13.9	15.9	19.9	54.3	57.3	59.3	27.3	30.3	32.3
400	15.9	15.9	16.4	15.8	17.8	21.8	12.8	14.8	18.8	53.5	56.5	58.5	26.2	29.2	31.2
500	15.2	15.2	15.7	13.8	15.8	19.8	10.8	12.8	16.8	52.0	55.0	57.0	24.2	27.2	29.2
600			15.1		14.2	18.2		11.2	15.2			55.1			28.6

# Category 6A F/UTP (ScTP)

CMR/CMP



MADE  
IN THE USA

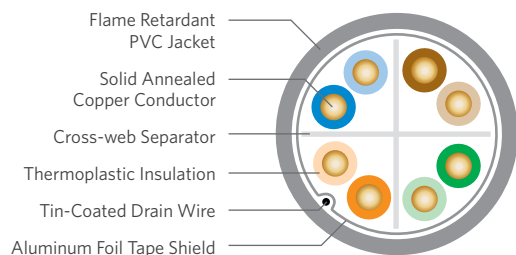

## SPECIFICATIONS

Configuration	Copper pairs surrounded by aluminum PET foil with an outer drain wire and jacket
Pair Count	4
Conductor	Solid annealed copper
AWG (mm)	23 (0.57)
Insulation	CMR: Thermoplastic CMP: FEP
Insulation Colors	Pair 1: ColorTip Light Blue, Blue Pair 2: ColorTip Light Orange, Orange Pair 3: ColorTip Light Green, Green Pair 4: ColorTip Light Brown, Brown
Separator	Cross-web
Shield	Aluminum/PET
Drain Wire	Stranded Tinned copper
Jacket	CMR: Flame retardant (FR) PVC CMP: FR, low smoke PVC
Characteristic Impedance Ohms	100 ± 15
Nominal Velocity of Propagation %	CMR: 66 CMP: 71
Performance Compliance	UL 444 CSA C22.2 No. 214-08 UL 1666 NFPA 262 ANSI/TIA-568.2-D Article 800, NEC (NFPA 70)
NRTL Programs	UL Verified CAT 6A UL Listed CMR-LP (0.5) c(UL) Listed CMR UL Listed CMP-LP (0.6) c(UL) Listed CMP
Sustainability	UL Certified EPD HPD Multi-Attribute Certification USGBC® Member RoHS-compliant/RoHS 2-compliant REACH-compliant

## PRODUCT DESCRIPTION



**FIRST MANUFACTURER IN THE INDUSTRY**  
to offer products that contribute toward LEED!

Category 6A F/UTP (ScTP) cable, swept out to 650 MHz, meets or exceeds ANSI/TIA-568.2-D for CAT 6A cables, a requirement for 10GBASE-T applications. The cable is UL® Verified CAT 6A and has a typical Alien Crosstalk margin of 18 dB.

The cable consists of four (4) balanced 23 AWG copper pairs around a flame retardant cross-web. The core is wrapped with a Mylar® backed aluminum foil. A drain wire is applied longitudinally against the tape. The cable is then protected with a flexible riser or plenum rated PVC jacket.

## APPLICATIONS

- 10BASE-T through 10GBASE-T Ethernet
- Power over Ethernet (PoE) - IEEE 802.3af
- 4PPoE+ - IEEE 802.3bt Type 3 and 4 draft D1.2
- ATM and token ring
- Backward compatible to legacy protocols and applications

## FEATURES

- UL Certified Environmental Product Declaration (EPD)
- Health Product Declaration™ (HPD™)
- Multi-Attribute Certification by GreenCircle Certified, LLC
- Overall shielded core
- Exceeds ANSI/TIA-568.2-D specification for CAT 6A cable performance
- CableID® alpha numeric code printed every 2 feet
- QuickCount® marking system in feet and meters
- ColorTip® circuit identification system
- UL LP listed
- ColorTip® circuit identification system
- Temperature cable rating: 75°C for CMR and 90°C for CMP

## BENEFITS

- Contributes toward 1 LEED point under the Material and Resources credit (MRC)
- Contributes toward 1 LEED point under the MRC
- Offers an overview of the sustainability of a product, its packaging and manufacturing
- Protects against EMI/RFI
- 18 dB typical margin Alien Crosstalk performance
- Exceeds requirements for Alien Crosstalk performance
- Allows both ends of a cable run to be easily identifiable without the need to separately label or tone the cable
- Provides remaining length of cable on reel
- Easily identifiable conductor mates even in low-light environments
- Third-party assurance of product safety in high-heat and high-power applications
- Easily identify conductor mates even in low-light environments
- Temperature rating of the insulation AND of the jacket provide improved cable lifespan despite high-heat and high-power applications

## PART NUMBERS AND PHYSICAL CHARACTERISTICS

Listing	Part Number <sup>1</sup>	Nominal Diameter in (mm)	Approx. Weight lbs/kft (kg/km)	Package	Packages per Pallet
CMR	6F-246-xA	0.29 (7.3)	32 (48)	1,000' BrakeBox®	12
CMR	6F-272-xA	0.29 (7.3)	32 (48)	1,000' Plywood reel	12
CMR	6F-273-xA	0.29 (7.3)	32 (48)	2,500' Plywood reel	8
CMP	6F-246-xB	0.28 (7.1)	37 (55)	1,000' BrakeBox	12
CMP	6F-272-xB	0.28 (7.1)	37 (55)	1,000' Plywood reel	12
CMP	6F-273-xB	0.28 (7.1)	37 (55)	2,500' Plywood reel	8



JACKET COLORS										
<sup>1</sup> Replace "x" with:	Blue = 2	Gray = 3	White = 4	Green = 5	Yellow = 6	Purple = 7	Red = 9	Orange = D		

**ELECTRICAL SPECIFICATIONS**

Frequency MHz	Insertion Loss @ 20°C Maximum dB/100 m			NEXT Minimum dB/100 m			ACR Minimum dB/100 m			PSNEXT Minimum dB/100 m			PSACR Minimum dB/100 m		
	TIA-568.2-D	Superior Essex		TIA-568.2-D	Superior Essex		TIA-568.2-D	Superior Essex		TIA-568.2-D	Superior Essex		TIA-568.2-D	Superior Essex	
	Specified	Guar.	Typical	Specified	Guar.	Typical	Specified	Guar.	Typical	Specified	Guar.	Typical	Specified	Guar.	Typical
1	2.1	2.1	2.0	74.3	74.3	76.8	72.2	72.2	74.8	72.3	72.3	74.8	70.2	70.2	72.8
4	3.8	3.8	3.7	65.3	65.3	67.8	61.5	61.5	64.1	63.3	63.3	65.8	59.5	59.5	62.1
8	5.3	5.3	5.2	60.8	60.8	63.3	55.5	55.5	58.1	58.8	58.8	61.3	53.5	53.5	56.1
10	5.9	5.9	5.8	59.3	59.3	61.8	53.4	53.4	56.0	57.3	57.3	59.8	51.4	51.4	54.0
16	7.5	7.5	7.3	56.2	56.2	58.7	48.7	48.7	51.4	54.2	54.2	56.7	46.7	46.7	49.4
20	8.4	8.4	8.2	54.8	54.8	57.3	46.4	46.4	49.1	52.8	52.8	55.3	44.4	44.4	47.1
25	9.4	9.4	9.2	53.3	53.3	55.8	43.9	43.9	46.6	51.3	51.3	53.8	41.9	41.9	44.6
31.25	10.5	10.5	10.3	51.9	51.9	54.4	41.4	41.4	44.1	49.9	49.9	52.4	39.4	39.4	42.1
62.5	15.0	15.0	14.7	47.4	47.4	49.9	32.4	32.4	35.2	45.4	45.4	47.9	30.4	30.4	33.2
100	19.1	19.1	18.8	44.3	44.3	46.8	25.2	25.2	28.0	42.3	42.3	44.8	23.2	23.2	26.0
200	27.6	27.6	27.0	39.8	39.8	42.3	12.2	12.2	15.3	37.8	37.8	40.3	10.2	10.2	13.3
250	31.1	31.1	30.4	38.3	38.3	40.8	7.2	7.2	10.4	36.3	36.3	38.8	5.2	5.2	8.4
300	34.3	34.3	33.6	37.1	37.1	39.6	2.8	2.8	6.0	35.1	35.1	37.6	0.8	0.8	4.0
350	37.2	37.2	36.5	36.1	36.1	38.6			2.1	34.1	34.1	36.6			0.1
400	40.1	40.1	39.3	35.3	35.3	37.8				33.3	33.3	35.8			
500	45.3	45.3	44.4	33.8	33.8	36.3				31.8	31.8	34.3			
600		50.1	49.5		32.6	35.1					30.6	33.1			

Frequency MHz	Return Loss Minimum dB/100 m			ACRF Minimum dB/100 m			PSACRF Minimum dB/100 m			PSANEXT Minimum dB/100 m			PSAACRF Minimum dB/100 m		
	TIA-568.2-D	Superior Essex		TIA-568.2-D	Superior Essex		TIA-568.2-D	Superior Essex		TIA-568.2-D	Superior Essex		TIA-568.2-D	Superior Essex	
	Specified	Guar.	Typical	Specified	Guar.	Typical	Specified	Guar.	Typical	Specified	Guar.	Typical	Specified	Guar.	Typical
1	20.0	20.0	20.6	67.8	67.8	71.8	64.8	64.8	68.8	67.0	70.0	72.0	67.0	70.0	72.0
4	23.0	23.0	23.7	55.8	55.8	59.8	52.8	52.8	56.8	67.0	70.0	72.0	66.2	69.2	71.2
8	24.5	24.5	25.3	49.7	49.7	53.7	46.7	46.7	50.7	67.0	70.0	72.0	60.1	63.1	65.1
10	25.0	25.0	25.8	47.8	47.8	51.8	44.8	44.8	48.8	67.0	70.0	72.0	58.2	61.2	63.2
16	25.0	25.0	25.8	43.7	43.7	47.7	40.7	40.7	44.7	67.0	70.0	72.0	54.1	57.1	59.1
20	25.0	25.0	25.8	41.8	41.8	45.8	38.8	38.8	42.8	67.0	70.0	72.0	52.2	55.2	57.2
25	24.3	24.3	25.1	39.8	39.8	43.8	36.8	36.8	40.8	67.0	70.0	72.0	50.2	53.2	55.2
31.25	23.6	23.6	24.3	37.9	37.9	41.9	34.9	34.9	38.9	67.0	70.0	72.0	48.3	51.3	53.3
62.5	21.5	21.5	22.2	31.9	31.9	35.9	28.9	28.9	32.9	65.6	68.6	70.6	42.3	45.3	47.3
100	20.1	20.1	20.7	27.8	27.8	31.8	24.8	24.8	28.8	62.5	65.5	67.5	38.2	41.2	43.2
200	18.0	18.0	18.5	21.8	21.8	25.8	18.8	18.8	22.8	58.0	61.0	63.0	32.2	35.2	37.2
250	17.3	17.3	17.8	19.8	19.8	23.8	16.8	16.8	20.8	56.5	59.5	61.5	30.2	33.2	35.2
300	16.8	16.8	17.3	18.3	18.3	22.3	15.3	15.3	19.3	55.3	58.3	60.3	28.7	31.7	33.7
350	16.3	16.3	16.8	16.9	16.9	20.9	13.9	13.9	17.9	54.3	57.3	59.3	27.3	30.3	32.3
400	15.9	15.9	16.4	15.8	15.8	19.8	12.8	12.8	16.8	53.5	56.5	58.5	26.2	29.2	31.2
500	15.2	15.2	15.7	13.8	13.8	17.8	10.8	10.8	14.8	52.0	55.0	57.0	24.2	27.2	29.2
600			15.1		12.2	16.2		9.8	13.8			55.1			28.6

**PRINT LEGENDS**

CAT 6A xxxx FT (xxxx.xM) ID yyyy CAT 6A ScTP 4PR 23 SUPERIOR ESSEX (UL) CMP-LP (0.6A) 90C or c(UL) CMP 90C VERIFIED (UL) CAT 6A XXX\_-H MADE IN USA PAT p.spx.us  
 CAT 6A xxxx FT (xxxx.xM) ID yyyy CAT 6A ScTP 4PR 23 SUPERIOR ESSEX (UL) CMR-LP (0.5A) 75C or c(UL) CMR 75C VERIFIED (UL) CAT 6A XXX\_-H MADE IN USA PAT p.spx.us

**SUSTAINABILITY LEADERSHIP**



UL and the related logo are registered trademarks of UL LLC. Health Product Declaration, HPDC and the related logo are trademarks of Health Product Declaration Collaborative. GreenCircle Certified logo is a registered trademark of GreenCircle Certified, LLC. USGBC and the related logo are registered trademarks of U.S. Green Building Council. Mylar is a registered trademark of E. I. du Pont de Nemours and Company or its affiliates.

# NextGain® Category 6eX

CMR/CMP

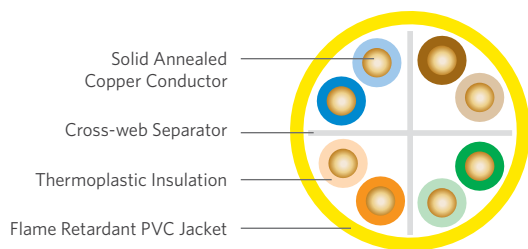

## SPECIFICATIONS

Pair Count	4
Conductor	Solid annealed copper
AWG (mm)	23 (0.57)
Insulation	CMR: Polyolefin CMP: FEP
Insulation Colors	Pair 1: ColorTip Light Blue, Blue Pair 2: ColorTip Light Orange, Orange Pair 3: ColorTip Light Green, Green Pair 4: ColorTip Light Brown, Brown
Separator	Cross-web
Jacket	CMR: Flame retardant (FR) PVC CMP: FR, low smoke PVC
Characteristic Impedance Ohms	100 ± 15
Nominal Velocity of Propagation %	CMR: 70 CMP: 74
Performance Compliance	UL 444 CSA C22.2 No. 214-08 UL 1666 NFPA 262 ANSI/TIA-568.2-D Article 800, NEC (NFPA 70)
NRTL Programs	UL Verified CAT 6 UL, c(UL) Listed CMR UL, c(UL) Listed CMP
Sustainability	UL Certified EPD HPD Multi-Attribute Certification USGBC® Member RoHS-compliant/RoHS 2-compliant REACH-compliant

## PART NUMBERS AND PHYSICAL CHARACTERISTICS

Listing	Part Number <sup>1</sup>	Nominal Diameter in (mm)	Approx. Weight lbs/kft (kg/km)	Package	Packages per Pallet
CMR	54-246-xA	0.23 (5.8)	24 (36)	1,000' BrakeBox	12
CMR	54-272-xA	0.23 (5.8)	24 (36)	1,000' Plywood reel	16
CMP	54-246-xB	0.23 (5.7)	28 (42)	1,000' BrakeBox	12
CMP	54-272-xB	0.23 (5.7)	28 (42)	1,000' Plywood reel	16

## JACKET COLORS

<sup>1</sup>Replace "x" with: Blue = 2   Gray = 3   White = 4   Green = 5   Yellow = 6   Purple = 7   Red = 9   Black = E

## PRODUCT DESCRIPTION



**FIRST MANUFACTURER IN THE INDUSTRY**  
to offer products that contribute toward LEED!

NextGain® Category 6eX cable brings UTP performance to a new level. Guaranteed for 7 dB of margin (headroom) over base requirements of CAT 6 NEXT standards, this cable maximizes bandwidth for today's leading edge applications and those of the future. With positive ACR verified beyond 300 MHz, NextGain CAT 6eX cable demonstrates superior capability for ATM, Gigabit Ethernet and other bandwidth intensive applications.

## APPLICATIONS

- 10BASE-T through 1000BASE-T Ethernet
- PoE+ - IEEE 802.3bt Type 1 to Type 4
- ATM and token ring
- Supports legacy protocols and applications

## FEATURES

- UL Certified Environmental Product Declaration (EPD)
- Health Product Declaration™ (HPD™)
- Multi-Attribute Certification by GreenCircle Certified, LLC
- Guaranteed NEXT of 7 dB greater than CAT 6 requirements
- Guaranteed ACR of 30 dB at 100 MHz and 11.7 dB at 250 MHz
- Exceptional performance over CAT 6 requirements
- BrakeBox® payout control system
- Warrantied with numerous connectivity manufacturers
- CableID® alpha numeric code printed every 2 feet
- QuickCount® marking system in feet and meters
- ColorTip® circuit identification system
- Color coded box labels

## BENEFITS

- Contributes toward 1 LEED point under the Material and Resources credit (MRc)
- Contributes toward 1 LEED point under the MRC
- Offers an overview of the sustainability of a product, its packaging and manufacturing
- "Future-proofing" the cable installation
- Performance assurance for multiple high-bandwidth applications (e.g., fast Ethernet, ATM, Gigabit Ethernet)
- Reduces BER, improving network efficiency
- Adjustable tension control on reel prevents over spin and entangling of cable
- Offers flexibility in selection of connectivity solutions
- Allows both ends of a cable run to be easily identifiable without the need to separately label or tone the cable
- Provides remaining length of cable on reel
- Easily identifiable conductor mates even in low-light environments
- Easily identifies jacket colors

**ELECTRICAL SPECIFICATIONS**

Frequency MHz	Insertion Loss @ 20°C Maximum dB/100 m			NEXT Minimum dB/100 m			ACR Minimum dB/100 m			PSNEXT Minimum dB/100 m		
	TIA-568.2-D	Superior Essex		TIA-568.2-D	Superior Essex		TIA-568.2-D	Superior Essex		TIA-568.2-D	Superior Essex	
	Specified	Guaranteed	Typical	Specified	Guaranteed	Typical	Calculated	Guaranteed	Typical	Specified	Guaranteed	Typical
1	2.0	2.0	1.7	74.3	81.3	94.7	72.3	79.3	92.9	72.3	79.3	92.4
4	3.8	3.8	3.4	65.3	72.3	85.5	61.5	68.5	82.1	63.3	70.3	83.4
10	6.0	5.9	5.4	59.3	66.3	78.9	53.3	60.4	73.6	57.3	64.3	76.9
16	7.6	7.5	6.9	56.2	63.2	76.2	48.6	55.7	69.3	54.2	61.2	74.0
20	8.5	8.4	7.7	54.8	61.8	74.7	46.3	53.4	66.9	52.8	59.8	72.6
25	9.5	9.4	8.7	53.3	60.3	73.2	43.8	50.9	64.5	51.3	58.3	71.1
31.25	10.7	10.6	9.8	51.9	58.9	71.1	41.2	48.3	61.3	49.9	56.9	69.2
62.5	15.4	15.3	14.1	47.4	54.4	66.6	32.0	39.1	52.6	45.4	52.4	64.6
100	19.8	19.7	18.1	44.3	51.3	64.4	24.5	31.6	46.3	42.3	49.3	62.3
200	29.0	28.8	26.3	39.8	46.8	59.0	10.8	18.0	32.9	37.8	44.8	57.0
250	32.8	32.6	29.8	38.3	45.3	58.0	5.5	12.7	28.0	36.3	43.3	55.8
300		36.2	33.0		41.2	56.5		4.7	23.5		39.2	54.3
350		39.5	35.9		40.2	55.1		0.4	19.1		38.2	52.8
400		43.0	38.5		39.3	52.9			14.2		37.3	50.6
450		46.0	41.3		38.5	50.3			9.0		36.5	49.3
500		48.9	44.0		37.8	49.8			6.9		35.8	48.8
550		51.8	46.6		37.2	49.1			3.6		35.2	48.0
650			51.1			47.0						45.1

Frequency MHz	PSACR Minimum dB/100 m			Return Loss Minimum dB/100 m			ELFEXT (ACRF) Minimum dB/100 m			PSELFEXT (PSACRF) Minimum dB/100 m		
	TIA-568.2-D	Superior Essex		TIA-568.2-D	Superior Essex		TIA-568.2-D	Superior Essex		TIA-568.2-D	Superior Essex	
	Calculated	Guaranteed	Typical	Specified	Guaranteed	Typical	Specified	Guaranteed	Typical	Specified	Guaranteed	Typical
1	70.3	77.3	90.7	20.0	20.0	28.8	67.8	73.8	86.7	64.8	70.8	84.8
4	59.5	66.5	80.1	23.0	23.0	33.2	55.7	61.7	74.8	52.7	58.7	73.0
10	51.3	58.4	71.6	25.0	25.0	35.2	47.8	53.8	67.1	44.8	50.8	65.1
16	46.6	53.7	67.2	25.0	25.0	34.8	43.7	49.7	63.2	40.7	46.7	61.2
20	44.3	51.4	65.0	25.0	25.0	35.0	41.7	47.7	61.3	38.7	44.7	59.3
25	41.8	48.9	62.5	24.3	24.3	36.6	39.8	45.8	59.4	36.8	42.8	57.4
31.25	39.2	46.3	59.6	23.6	23.6	36.6	37.9	43.9	57.6	34.9	40.9	55.5
62.5	30.0	37.1	50.7	21.5	21.5	36.0	31.8	37.8	51.8	28.8	34.8	49.7
100	22.5	29.6	44.4	20.1	20.1	35.0	27.8	33.8	48.0	24.8	30.8	45.7
200	8.8	16.0	31.0	18.0	18.0	32.6	21.7	27.7	42.1	18.7	24.7	39.8
250	3.5	10.7	26.3	17.3	17.3	31.8	19.8	25.8	40.1	16.8	22.8	37.8
300		2.7	21.8		16.8	30.7		24.2	38.3		21.2	36.0
350			17.3		16.3	29.3		22.9	37.0		19.9	34.7
400			12.6		15.9	28.7		21.7	35.6		18.7	33.1
450			7.5		15.5	27.8			34.4			32.1
500			5.3		15.2	26.7			32.9			30.6
550			2.0		14.9	25.1			31.5			29.2
650						20.4			28.2			26.0

**SUSTAINABILITY LEADERSHIP**



UL and the related logo are registered trademarks of UL LLC. Health Product Declaration, HPDC and the related logo are trademarks of Health Product Declaration Collaborative. GreenCircle Certified logo is a registered trademark of GreenCircle Certified, LLC. USGBC and the related logo are registered trademarks of U.S. Green Building Council.

# DataGain® Category 6+

CMR/CMP

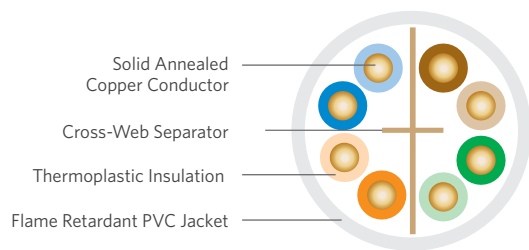

## SPECIFICATIONS

Pair Count	4
Conductor	Solid annealed copper
AWG (mm)	23 (0.57)
Insulation	CMR: Polyolefin CMP: FEP
Insulation Colors	Pair 1: ColorTip Light Blue, Blue Pair 2: ColorTip Light Orange, Orange Pair 3: ColorTip Light Green, Green Pair 4: ColorTip Light Brown, Brown
Separator	Cross-Web
Jacket	CMR: Flame retardant (FR) PVC CMP: FR, low smoke PVC
Characteristic Impedance Ohms	100 ± 15
Nominal Velocity of Propagation %	CMR: 70 CMP: 72
Performance Compliance	UL 444 CSA C22.2 No. 214-08 UL 1666 NFPA 262 ANSI/TIA-568.2-D ANSI/ICEA S-90-661-2012 Article 800, NEC (NFPA 70)
NRTL Programs	UL Verified CAT 6 UL, c(UL) Listed CMR UL, c(UL) Listed CMP
Sustainability	UL Certified EPD HPD Multi-Attribute Certification USGBC® Member RoHS-compliant/RoHS 2-compliant REACH-compliant

## PRODUCT DESCRIPTION



**FIRST MANUFACTURER IN THE INDUSTRY**  
to offer products that contribute toward LEED!

DataGain® cable provides the best value in Category 6+ cables on the market today. The innovative design, which utilizes a tape separator, yields exceptional performance that exceeds TIA/EIA CAT 6 specifications. DataGain easily surpasses the performance of other cost-competitive CAT 6 cables.

## APPLICATIONS

- 10BASE-T through 1000BASE-T Ethernet
- Power over Ethernet (PoE) - IEEE 802.3bt Type 1 to 4
- ATM and token ring

## FEATURES

- UL Certified Environmental Product Declaration (EPD)
- Health Product Declaration™ (HPD™)
- Multi-Attribute Certification by GreenCircle Certified, LLC
- Guaranteed electrical performance to 400 MHz
- Guaranteed 5 dB margin in NEXT, PSNEXT, ELFEXT, PSELFEXT, ACR and PSACR
- Tested to 550 MHz
- Round design with cross-web separator
- Warranted with numerous connectivity manufacturers
- BrakeBox® payout control system
- CableID® alpha numeric code printed every 2 feet
- QuickCount® marking system in feet and meters
- ColorTip® circuit identification system
- Color coded box labels

## BENEFITS

- Contributes toward 1 LEED point under the Material and Resources credit (MRc)
- Contributes toward 1 LEED point under the MRC
- Offers an overview of the sustainability of a product, its packaging and manufacturing
- Greater assurance of exceptional overall channel performance at a great value
- “Future-proofs” the cable installation
- Assures ample bandwidth headroom
- Reduces installation time
- Offers flexibility in selection of connectivity solutions
- Adjustable tension control on reel prevents over spin and entangling of cable
- Allows both ends of a cable run to be easily identifiable without the need to separately label or tone the cable
- Provides remaining length of cable on reel
- Easily identifiable conductor mates even in low-light environments
- Easily identifies jacket colors

**PART NUMBERS AND PHYSICAL CHARACTERISTICS**

Listing	Part Number <sup>1</sup>	Nominal Diameter in (mm)	Approx. Weight lbs/kft (kg/km)	Package	Packages per Pallet
CMR	66-246-xA	0.22 (5.5)	24 (36)	1,000' BrakeBox®	27
CMR	66-272-xA	0.22 (5.5)	24 (36)	1,000' Plywood reel	16
CMR	66-240-xA	0.22 (5.5)	24 (36)	1,000' POP™ box	36
CMP	66-246-xB	0.22 (5.5)	26 (39)	1,000' BrakeBox	27
CMP	66-272-xB	0.22 (5.5)	26 (39)	1,000' Plywood reel	16
CMP	66-240-xB	0.22 (5.5)	26 (39)	1,000' POP box	36

**JACKET COLORS**

<sup>1</sup>Replace "x" with: Blue = 2 Gray = 3 White = 4 Green = 5 Yellow = 6 Purple = 7 Red = 9 Pink = C Orange = D Black = E

**ELECTRICAL SPECIFICATIONS**

Frequency MHz	Insertion Loss @ 20°C Maximum dB/100 m			NEXT Minimum dB/100 m			ACR Minimum dB/100 m			PSNEXT Minimum dB/100 m		
	TIA-568.2-D		Superior Essex	TIA-568.2-D		Superior Essex	TIA-568.2-D		Superior Essex	TIA-568.2-D		Superior Essex
	Specified	Guaranteed	Typical	Specified	Guaranteed	Typical	Calculated	Guaranteed	Typical	Specified	Guaranteed	Typical
1	2.0	2.0	1.7	74.3	79.3	90.6	72.3	77.3	88.9	72.3	77.3	88.2
4	3.8	3.8	3.4	65.3	70.3	80.9	61.5	66.5	77.5	63.3	68.3	78.6
10	6.0	5.9	5.4	59.3	64.3	74.4	53.3	58.4	69.0	57.3	62.3	72.1
16	7.6	7.5	6.9	56.2	61.2	71.4	48.6	53.7	64.5	54.2	59.2	69.1
20	8.5	8.4	7.8	54.8	59.8	70.1	46.3	51.4	62.4	52.8	57.8	67.8
25	9.5	9.4	8.7	53.3	58.3	68.4	43.8	48.9	59.7	51.3	56.3	66.1
31.25	10.7	10.6	9.8	51.9	56.9	67.2	41.2	46.3	57.3	49.9	54.9	64.8
62.5	15.4	15.3	14.1	47.4	52.4	62.5	32.0	37.1	48.4	45.4	50.4	60.3
100	19.8	19.7	18.1	44.3	49.3	59.7	24.5	29.6	41.5	42.3	47.3	57.3
200	29.0	28.8	26.4	39.8	44.8	54.5	10.8	16.0	28.3	37.8	42.8	52.3
250	32.8	32.6	29.8	38.3	43.3	53.5	5.5	10.7	23.5	36.3	41.3	50.8
400		42.7	38.9		36.3	48.2			9.2		34.3	45.6
500			44.2			45.4			1.2			43.0
550			47.2			44.0						42.1

Frequency MHz	PSACR Minimum dB/100 m			Return Loss Minimum dB/100 m			ELFEXT (ACRF) Minimum dB/100 m			PSELFEXT (PSACRF) Minimum dB/100 m		
	TIA-568.2-D		Superior Essex	TIA-568.2-D		Superior Essex	TIA-568.2-D		Superior Essex	TIA-568.2-D		Superior Essex
	Calculated	Guaranteed	Typical	Specified	Guaranteed	Typical	Specified	Guaranteed	Typical	Specified	Guaranteed	Typical
1	70.3	75.3	85.6	20.0	20.0	28.5	67.8	72.7	82.6	64.8	69.8	80.6
4	59.5	64.5	74.3	23.0	23.0	33.8	55.8	60.7	70.7	52.8	57.8	68.8
10	51.3	56.5	65.7	25.0	25.0	36.1	47.8	52.7	62.9	44.8	49.8	60.9
16	46.6	51.7	61.3	25.0	25.0	36.2	43.7	48.6	58.9	40.7	45.7	56.9
20	44.3	49.4	59.2	25.0	25.0	35.9	41.8	46.7	57.0	38.8	43.8	54.9
25	41.8	46.9	56.5	24.3	24.3	36.0	39.8	44.7	55.2	36.8	41.8	53.0
31.25	39.2	44.3	54.2	23.6	23.6	35.7	37.9	42.8	53.3	34.9	39.9	51.1
62.5	30.0	35.1	45.3	21.5	21.5	33.2	31.9	36.8	47.5	28.9	33.9	45.2
100	22.5	27.6	38.5	20.1	20.1	32.2	27.8	32.7	43.6	24.8	29.8	41.3
200	8.8	14.0	25.2	18.0	18.0	30.2	21.8	26.7	37.7	18.8	23.8	35.4
250	3.5	8.7	20.4	17.3	17.3	30.1	19.8	24.7	35.7	16.8	21.8	33.4
400			6.2		15.9	27.0		17.8	30.2		12.8	28.8
500						25.5			28.2			25.9
550						24.6			26.6			24.5

**SUSTAINABILITY LEADERSHIP**



UL and the related logo are registered trademarks of UL LLC. Health Product Declaration, HPD and the related logo are trademarks of Health Product Declaration Collaborative. GreenCircle Certified logo is a registered trademark of GreenCircle Certified, LLC. USGBC and the related logo are registered trademarks of U.S. Green Building Council.



# Category 6+ LSHF

## CMR-LSHF

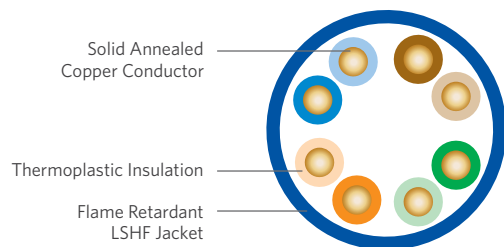

### SPECIFICATIONS

Pair Count	4
Conductor	Solid annealed copper
AWG (mm)	23 (0.57)
Insulation	Solid HPDE
Insulation Colors	Pair 1: ColorTip Light Blue, Blue Pair 2: ColorTip Light Orange, Orange Pair 3: ColorTip Light Green, Green Pair 4: ColorTip Light Brown, Brown
Jacket	Flame retardant LSHF
Characteristic Impedance Ohms	100 ± 15
Nominal Velocity of Propagation %	67
Performance Compliance	UL® 444 CSA C22.2 No. 214-08 UL 1666 IEC 60134 IEC 60332-1 IEC 60754 IEC 62821-1 IEC 62821-2 IEC 62821-3 ANSI/TIA-568.2-D Article 800, NEC (NFPA 70)
NRTL Programs	UL Verified CAT 6 UL, c(UL) Listed CMR-LSHF
Sustainability	HPD USGBC® Member RoHS-compliant/RoHS 2-compliant REACH-compliant

### PRODUCT DESCRIPTION



**FIRST MANUFACTURER IN THE INDUSTRY**  
to offer products that contribute toward LEED!

Superior Essex Category 6+ LSHF CMR cable is designed for applications requiring a Low Smoke Halogen-free (LSHF) construction. This cable does not contain any red list materials in its composition. CAT 6 compliance ensures this cable will support 1000BASE-T Gigabit Ethernet. This cable easily surpasses the Grade 2 requirements specified in the ANSI/TIA/EIA-570-B Residential Telecommunications standard.

### APPLICATIONS

- 10BASE-T through 1000BASE-T Ethernet
- Power over Ethernet (PoE) - IEEE 802.3af
- PoE+ - IEEE 802.3at Type 1 and 2
- ATM and token ring

### FEATURES

- Health Product Declaration™ (HPD™)
- Low Smoke Halogen-free
- Guaranteed 2 dB margin in NEXT, PSNEXT, RL, ACR and PSACR
- UL Listed CMR-LSHF
- Meets and exceeds ANSI/TIA-568.2-D specification
- Round design without separator
- BrakeBox® payout control system
- CableID® alpha numeric code printed every 2 feet
- QuickCount® marking system in feet and meters
- ColorTip® Circuit Identification System
- Color coded box labels

### BENEFITS

- Contributes toward 1 LEED point under the MRc
- Meets IEC 62821 requirements for toxicity, acidity and smoke
- “Future-proofs” the cable installation
- UL listing allows for CMR specific installations
- CAT 6+ compliance
- Reduces installation time
- Adjustable tension control on reel prevents over spin and entangling of cable
- Allows both ends of a cable run to be easily identifiable without the need to separately label or tone the cable
- Provides remaining length of cable on reel
- Easily identifiable conductor mates even in low light environments
- Easily identifies jacket colors

### PART NUMBERS AND PHYSICAL CHARACTERISTICS

Listing	Part Number <sup>1</sup>	Nominal Diameter in (mm)	Approx. Weight lbs/kft (kg/km)	Package	Packages per Pallet
CMR-LSHF	66-246-xM	0.25 (6.3)	28 (42)	1,000' BrakeBox	12

### JACKET COLORS

<sup>1</sup>Replace “x” with: Blue = 2   Gray = 3   White = 4   Green = 5   Yellow = 6   Purple = 7   Red = 9   Orange = D   Black = E

**ELECTRICAL SPECIFICATIONS**

Frequency MHz	Insertion Loss @ 20°C Maximum dB/100 m			NEXT Minimum dB/100 m			ACR Minimum dB/100 m			PSNEXT Minimum dB/100 m		
	TIA-568.2-D	Superior Essex		TIA-568.2-D	Superior Essex		TIA-568.2-D	Superior Essex		TIA-568.2-D	Superior Essex	
	Specified	Guaranteed	Typical	Specified	Guaranteed	Typical	Calculated	Guaranteed	Typical	Specified	Guaranteed	Typical
1	2	2	1.7	74.3	76.3	83.9	72.3	74.3	83.2	72.3	74.3	82.9
4	3.8	3.8	3.4	65.3	67.3	78.6	61.5	63.5	75.2	63.3	65.3	76
10	6	6	5.4	59.3	61.3	71.1	53.3	55.3	65.7	57.3	59.3	69.3
16	7.6	7.6	6.9	56.2	58.2	70.6	48.6	50.6	63.5	54.2	56.2	68.1
20	8.5	8.5	7.8	54.8	56.8	69.7	46.3	48.3	61.7	52.8	54.8	66.7
25	9.5	9.5	8.8	53.3	55.3	67.1	43.8	45.8	59.7	51.3	53.3	65.7
31.25	10.7	10.7	9.8	51.9	53.9	66.8	41.2	43.2	57.2	49.9	51.9	64.4
62.5	15.4	15.4	14.2	47.4	49.4	65	32	34	48.8	45.4	47.4	60.1
100	19.8	19.8	18.2	44.3	46.3	59	24.5	26.5	39.7	42.3	44.3	56
200	29	29	26.6	39.8	41.8	54.8	10.8	12.8	27.5	37.8	39.8	51.6
250	32.8	32.8	30.1	38.3	40.3	52	5.5	7.5	22.1	36.3	38.3	49.7
400			39.5			50.1			9			45.5
500			45.1			43.9						42.7
550			47.7			42.6						40.1

Frequency MHz	PSACR Minimum dB/100 m			Return Loss Minimum dB/100 m			ELFEXT (ACRF) Minimum dB/100 m			PSELFEXT (PSACRF) Minimum dB/100 m		
	TIA-568.2-D	Superior Essex		TIA-568.2-D	Superior Essex		TIA-568.2-D	Superior Essex		TIA-568.2-D	Superior Essex	
	Calculated	Guaranteed	Typical	Specified	Guaranteed	Typical	Specified	Guaranteed	Typical	Specified	Guaranteed	Typical
1	70.3	72.3	81.2	20	22	26.5	67.8	67.8	79.7	64.8	64.8	77.6
4	59.5	61.5	72.6	23	25	31.6	55.8	55.8	66.9	52.8	52.8	65.2
10	51.3	53.3	63.9	25	27	36.8	47.8	47.8	59.1	44.8	44.8	57.4
16	46.6	48.6	61.2	25	27	37.7	43.7	43.7	55	40.7	40.7	53.2
20	44.3	46.3	59.1	25	27	36.5	41.8	41.8	53.1	38.8	38.8	51.3
25	41.8	43.8	57.1	24.3	26.3	39.1	39.8	39.8	51.2	36.8	36.8	49.4
31.25	39.2	41.2	54.3	23.6	25.6	35.2	37.9	37.9	49.1	34.9	34.9	47.4
62.5	30	32	46	21.5	23.5	32.9	31.9	31.9	42.4	28.9	28.9	41.3
100	22.5	24.5	38	20.1	22.1	31.2	27.8	27.8	37.9	24.8	24.8	36.2
200	8.8	10.8	25	18	20	28.2	21.8	21.8	33.6	18.8	18.8	32.8
250	3.5	5.5	19.8	17.3	19.3	29.1	19.8	19.8	33.5	16.8	16.8	32.3
400			6			25.4			25.7			24.5
500						25.5			23.5			22.5
550						24.6			23.4			24

**SUSTAINABILITY LEADERSHIP**



UL and the related logo are registered trademarks of UL LLC. Health Product Declaration, HPD and the related logo are trademarks of Health Product Declaration Collaborative. GreenCircle Certified logo is a registered trademark of GreenCircle Certified, LLC. USGBC and the related logo are registered trademarks of U.S. Green Building Council.

# Category 6+ F/UTP (ScTP)

CMR/CMP

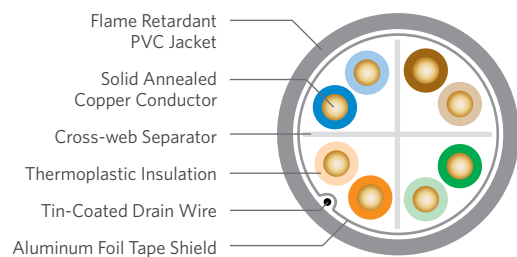

## SPECIFICATIONS

Configuration	Copper pairs surrounded by aluminum PET foil with an outer drain wire and jacket
Pair Count	4
Conductor	Solid annealed copper
AWG (mm)	23 (0.57)
Insulation	CMR: Thermoplastic; CMP: FEP
Insulation Colors	Pair 1: ColorTip Light Blue, Blue Pair 2: ColorTip Light Orange, Orange Pair 3: ColorTip Light Green, Green Pair 4: ColorTip Light Brown, Brown
Separator	Cross-web
Shield	Aluminum/PET with 10% overlap
Drain Wire	Tinned copper
Jacket	CMR: Flame retardant (FR) PVC CMP: FR, low smoke PVC
Characteristic Impedance Ohms	100 ± 15
Nominal Velocity of Propagation %	CMR: 66; CMP: 71
Performance Compliance	UL 444 CSA C22.2 No. 214-08 UL 1666 NFPA 262 ANSI/TIA-568.2-D ANSI/TIA/EIA-TSB-155 Article 800, NEC (NFPA 70) HDBaseT Class A and B
NRTL Programs	UL Verified CAT 6; UL, c(UL) Listed CMR; UL, c(UL) Listed CMP; HDBaseT Certified
Sustainability	UL Certified EPD HPD Multi-Attribute Certification USGBC® Member RoHS-compliant/RoHS 2-compliant REACH-compliant

## PRODUCT DESCRIPTION



**FIRST MANUFACTURER IN THE INDUSTRY**  
to offer products that contribute toward LEED!

Category 6+ F/UTP (ScTP) cable, with guaranteed performance out to 500 MHz, exceeds ANSI/TIA-568.2-D for CAT 6 cables. The cable is UL Verified CAT 6 and has a typical Alien Crosstalk margin of 18 dB. The cable can be used for 10GBASE-T applications for up to 55 meters per ANSI/TIA/EIA-TSB-155.

The cable consists of four (4) balanced 23 AWG copper pairs around a flame retardant cross-web. The core is wrapped with a Mylar® backed aluminum foil. A drain wire is applied longitudinally against the tape. The cable is then protected with a flexible riser or plenum rated PVC jacket. Category 6+ F/UTP (ScTP) is certified for HD A/V applications using HDBaseT Class A and B protocol.

## APPLICATIONS

- 10GBASE-T (up to 55 meters), 1000BASE-T, 100BASE-T and legacy Ethernet applications
- Power over Ethernet (PoE) – IEEE 802.3af
- PoE+ – IEEE 802.3at Type 1 and 2
- ATM and token ring
- HDBaseT Class A and B

## FEATURES

- UL Certified Environmental Product Declaration (EPD)
- Health Product Declaration™ (HPD™)
- Multi-Attribute Certification by GreenCircle Certified, LLC
- Overall shielded core
- Guaranteed performance to 500 MHz
- Exceeds ANSI/TIA-568.2-D specification for CAT 6 cable performance
- CableID® alpha numeric code printed every 2 feet
- QuickCount® marking system in feet and meters
- ColorTip® circuit identification system
- HDBaseT Class A and B certified

## BENEFITS

- Contributes toward 1 LEED point under the Material and Resources credit (MRC)
- Contributes toward 1 LEED point under the MRC
- Offers an overview of the sustainability of a product, its packaging and manufacturing
- Protects against EMI/RFI
- 18 dB typical margin Alien Crosstalk performance
- Assures ample headroom for existing and future high bandwidth applications
- Allows for 10GBASE-T applications up to 55 meters
- Allows both ends of a cable run to be easily identifiable without the need to separately label or tone the cable
- Provides remaining length of cable on reel
- Easily identifiable conductor mates even in low-light environments
- Ideal for any A/V applications up to 100m channel

## PART NUMBERS AND PHYSICAL CHARACTERISTICS

Listing	Part Number <sup>1</sup>	Nominal Diameter in (mm)	Approx. Weight lbs/kft (kg/km)	Package	Packages per Pallet
CMR	6T-246-xA	0.29 (7.3)	32 (48)	1,000' BrakeBox®	12
CMR	6T-272-xA	0.29 (7.3)	32 (48)	1,000' Plywood reel	12
CMP	6T-246-xB	0.28 (7.1)	37 (55)	1,000' BrakeBox®	12
CMP	6T-272-xB	0.28 (7.1)	37 (55)	1,000' Plywood reel	12

## JACKET COLORS

<sup>1</sup>Replace "x" with: Blue = 2 Gray = 3 White = 4 Green = 5 Yellow = 6 Purple = 7 Red = 9 Orange = D



**ELECTRICAL SPECIFICATIONS**

Frequency MHz	Insertion Loss @ 20°C Maximum dB/100 m			NEXT Minimum dB/100 m			ACR Minimum dB/100 m			PSNEXT Minimum dB/100 m		
	TIA-568.2-D		Superior Essex	TIA-568.2-D		Superior Essex	TIA-568.2-D		Superior Essex	TIA-568.2-D		Superior Essex
	Specified	Guaranteed	Typical	Specified	Guaranteed	Typical	Calculated	Guaranteed	Typical	Specified	Guaranteed	Typical
1	2.0	2.0	1.7	74.3	74.3	82.9	72.3	72.3	82.2	72.3	72.3	81.9
4	3.8	3.8	3.4	65.3	65.3	77.6	61.5	61.5	74.2	63.3	63.3	75.0
10	6.0	6.0	5.4	59.3	59.3	70.1	53.3	53.3	64.7	57.3	57.3	68.3
16	7.6	7.6	6.9	56.2	56.2	69.6	48.6	48.6	62.5	54.2	54.2	67.1
20	8.5	8.5	7.8	54.8	54.8	68.7	46.3	46.3	60.7	52.8	52.8	65.7
25	9.5	9.5	8.8	53.3	53.3	66.1	43.8	43.8	58.7	51.3	51.3	64.7
31.25	10.7	10.7	9.8	51.9	51.9	67.8	41.2	41.2	56.2	49.9	49.9	63.4
62.5	15.4	15.4	14.2	47.4	47.4	64.0	32.0	32.0	47.8	45.4	45.4	59.1
100	19.8	19.8	18.2	44.3	44.3	58.0	24.5	24.5	38.7	42.3	42.3	55.0
200	29.0	29.0	26.6	39.8	39.8	53.8	10.8	10.8	26.5	37.8	37.8	50.6
250	32.8	32.8	30.1	38.3	38.3	51.0	5.5	5.5	21.1	36.3	36.3	48.7
300		35.5	33.4		36.2	53.8		0.6	19.4		34.8	49.1
400		42.1	39.5		34.4	49.1			8.0		32.5	44.5
500		48.0	45.1		32.9	42.9					31.0	41.7

Frequency MHz	PSACR Minimum dB/100 m			Return Loss Minimum dB/100 m			ELFEXT (ACRF) Minimum dB/100 m			PSELFEXT (PSACRF) Minimum dB/100 m		
	TIA-568.2-D		Superior Essex	TIA-568.2-D		Superior Essex	TIA-568.2-D		Superior Essex	TIA-568.2-D		Superior Essex
	Calculated	Guaranteed	Typical	Specified	Guaranteed	Typical	Specified	Guaranteed	Typical	Specified	Guaranteed	Typical
1	70.3	70.3	80.2	20.0	20.0	26.0	67.8	67.8	78.7	64.8	64.8	76.6
4	59.5	59.5	71.6	23.0	23.0	31.1	55.8	55.8	65.9	52.8	52.8	64.2
10	51.3	51.3	62.9	25.0	25.0	36.3	47.8	47.8	58.1	44.8	44.8	56.4
16	46.6	46.6	60.2	25.0	25.0	37.7	43.7	43.7	54.0	40.7	40.7	52.2
20	44.3	44.3	58.1	25.0	25.0	36.0	41.8	41.8	52.1	38.8	38.8	50.3
25	41.8	41.8	56.1	24.3	24.3	38.6	39.8	39.8	50.2	36.8	36.8	48.4
31.25	39.2	39.2	53.6	23.6	23.6	38.3	37.9	37.9	48.1	34.9	34.9	46.4
62.5	30.0	30.0	45.0	21.5	21.5	32.8	31.9	31.9	41.4	28.9	28.9	40.3
100	22.5	22.5	37.0	20.1	20.1	30.7	27.8	27.8	36.8	24.8	24.8	35.2
200	8.8	8.8	24.0	18.0	18.0	27.6	21.8	21.8	32.6	18.8	18.8	31.8
250	3.5	3.5	18.8	17.3	17.3	28.5	19.8	19.8	32.5	16.8	16.8	31.3
300			15.8		15.9	28.6		17.5	30.8		14.5	28.9
400			5.0		14.9	24.9		14.9	24.7		11.9	23.5
500					13.7	25.0		12.5	22.5		9.5	21.5

**SUSTAINABILITY LEADERSHIP**



UL and the related logo are registered trademarks of UL LLC. Health Product Declaration, HPD and the related logo are trademarks of Health Product Declaration Collaborative. GreenCircle Certified logo is a registered trademark of GreenCircle Certified, LLC. USGBC and the related logo are registered trademarks of U.S. Green Building Council. Mylar is a registered trademark of E. I. du Pont de Nemours and Company or its affiliates.

# Category 6

CMR/CMP

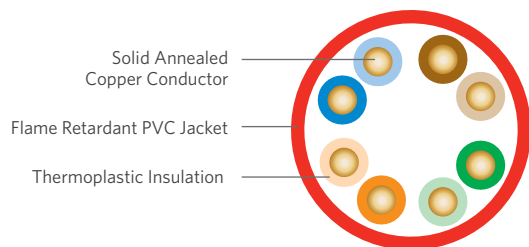

## SPECIFICATIONS

Pair Count	4
Conductor	Solid annealed copper
AWG (mm)	23 (0.57)
Insulation	CMR: Polyolefin CMP: FEP
Insulation Colors	Pair 1: ColorTip Light Blue, Blue Pair 2: ColorTip Light Orange, Orange Pair 3: ColorTip Light Green, Green Pair 4: ColorTip Light Brown, Brown
Jacket	CMR: Flame retardant (FR) PVC CMP: FR, low smoke PVC
Characteristic Impedance Ohms	100 ± 15
Nominal Velocity of Propagation %	CMR: 70 CMP: 73
Performance Compliance	UL 444 CSA C22.2 No. 214-08 UL 1666 NFPA 262 ANSI/TIA-568.2-D Article 800, NEC (NFPA 70)
NRTL Programs	UL Verified CAT 6 UL, c(UL) Listed CMR UL, c(UL) Listed CMP
Sustainability	UL Certified EPD HPD Multi-Attribute Certification USGBC® Member RoHS-compliant/RoHS 2-compliant REACH-compliant

## PRODUCT DESCRIPTION



**FIRST MANUFACTURER IN THE INDUSTRY**  
to offer products that contribute toward LEED!

Superior Essex Series 77 product line provides exceptional value for jobs that require standards compliant Category 6 cable at a cost-effective price.

## APPLICATIONS

- 10BASE-T through 1000BASE-T Ethernet
- Power over Ethernet (PoE) – IEEE 802.3af
- PoE+ – IEEE 802.3at Type 1 and 2
- ATM and token ring

## FEATURES

- UL Certified Environmental Product Declaration (EPD)
- Health Product Declaration™ (HPD™)
- Multi-Attribute Certification by GreenCircle Certified, LLC
- Meets ANSI/TIA-568.2-D specification
- BrakeBox® payout control system
- CableID® alpha numeric code printed every 2 feet
- QuickCount® marking system in feet and meters
- ColorTip® circuit identification system
- Color coded box labels

## BENEFITS

- Contributes toward 1 LEED point under the Material and Resources credit (MRC)
- Contributes toward 1 LEED point under the MRC
- Offers an overview of the sustainability of a product, its packaging and manufacturing
- Provides cost effective solution
- Adjustable tension control on reel prevents over spin and entangling of cable
- Allows both ends of a cable run to be easily identifiable without the need to separately label or tone the cable
- Provides remaining length of cable on reel
- Easily identifiable conductor mates even in low-light environments
- Easily identifies jacket colors

## PART NUMBERS AND PHYSICAL CHARACTERISTICS

Listing	Part Number <sup>1</sup>	Nominal Diameter in (mm)	Approx. Weight lbs/kft (kg/km)	Package
CMR	77-xxx-yA	0.21 (5.3)	22 (33)	use key
CMP	77-xxx-yB	0.20 (5.1)	23 (34)	use key

## PACKAGING

	150 ft Coil	200 ft Coil	250 ft Coil	300 ft Coil	1,000 ft POP Box	1,000 ft BrakeBox	1,000 ft Plywood Reel	2,500 ft Plywood Reel
<sup>1</sup> Replace "xxx" with:	225	229	230	231	240	246	272	273
Packages per Pallet	120	120	144	120	36	27	16	12

## JACKET COLORS

<sup>1</sup>Replace "y" with: Blue = 2 Gray = 3 White = 4 Green = 5 Yellow = 6 Purple = 7 Red = 9 Pink = C Orange = D Black = E

**ELECTRICAL SPECIFICATIONS**

Frequency MHz	Insertion Loss @ 20°C Maximum dB/100 m		NEXT Minimum dB/100 m		ACR Minimum dB/100 m		PSNEXT Minimum dB/100 m	
	TIA-568.2-D	Superior Essex	TIA-568.2-D	Superior Essex	TIA-568.2-D	Superior Essex	TIA-568.2-D	Superior Essex
	Specified	Typical	Specified	Typical	Calculated	Typical	Specified	Typical
1	2.0	1.7	74.3	82.9	72.3	82.2	72.3	81.9
4	3.8	3.4	65.3	77.6	61.5	74.2	63.3	75.0
8	5.3	4.8	60.8	74.4	55.4	68.9	58.8	71.9
10	6.0	5.4	59.3	70.1	53.3	64.7	57.3	68.3
16	7.6	6.9	56.2	69.6	48.6	62.5	54.2	67.1
20	8.5	7.8	54.8	68.7	46.3	60.7	52.8	65.7
25	9.5	8.8	53.3	66.1	43.8	58.7	51.3	64.7
31.25	10.7	9.8	51.9	67.8	41.2	56.2	49.9	63.4
62.5	15.4	14.2	47.4	64.0	32.0	47.8	45.4	59.1
100	19.8	18.2	44.3	58.0	24.5	38.7	42.3	55.0
155	25.2	23.0	41.4	54.5	16.3	31.6	39.4	52.1
200	29.0	26.6	39.8	53.8	10.8	26.5	37.8	50.6
250	32.8	30.1	38.3	51.0	5.5	21.1	36.3	48.7
300		33.4		53.8		19.4		49.1
350		36.5		50.1		14.3		47.5
400		39.5		49.1		8.0		44.5
450		42.3		44.6		3.3		43.4
500		45.1		42.9				41.7
550		47.7		41.6				39.1

Frequency MHz	PSACR Minimum dB/100 m		Return Loss Minimum dB/100 m		ELFEXT Minimum dB/100 m		PSELFEXT Minimum dB/100 m	
	TIA-568.2-D	Superior Essex	TIA-568.2-D	Superior Essex	TIA-568.2-D	Superior Essex	TIA-568.2-D	Superior Essex
	Calculated	Typical	Specified	Typical	Specified	Typical	Specified	Typical
1	70.3	80.2	20.0	26.0	67.8	78.7	64.8	76.6
4	59.5	71.6	23.0	31.1	55.8	65.9	52.8	64.2
8	53.4	67.1	24.5	34.5	49.7	60.1	46.7	58.4
10	51.3	62.9	25.0	36.3	47.8	58.1	44.8	56.4
16	46.6	60.2	25.0	37.7	43.7	54.0	40.7	52.2
20	44.3	58.1	25.0	36.0	41.8	52.1	38.8	50.3
25	41.8	56.1	24.3	38.6	39.8	50.2	36.8	48.4
31.25	39.2	53.6	23.6	38.3	37.9	48.1	34.9	46.4
62.5	30.0	45.0	21.5	32.8	31.9	41.4	28.9	40.3
100	22.5	37.0	20.1	30.7	27.8	36.8	24.8	35.2
155	14.3	29.1	18.8	28.8	24.0	33.3	21.0	31.9
200	8.8	24.0	18.0	27.6	21.8	32.6	18.8	31.8
250	3.5	18.8	17.3	28.5	19.8	32.5	16.8	31.3
300		15.8		28.6		30.8		28.9
350		11.6		29.0		26.8		25.4
400		5.0		24.9		24.7		23.5
450		1.2		23.9		23.2		21.9
500				25.0		22.5		21.5
550				24.2		22.4		22.0

**SUSTAINABILITY LEADERSHIP**



UL and the related logo are registered trademarks of UL LLC. Health Product Declaration, HPD and the related logo are trademarks of Health Product Declaration Collaborative. GreenCircle Certified logo is a registered trademark of GreenCircle Certified, LLC. USGBC and the related logo are registered trademarks of U.S. Green Building Council.



# Category 6

## CM

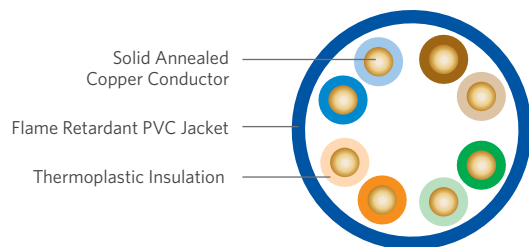

### SPECIFICATIONS

Pair Count	4
Conductor	Solid annealed copper
AWG (mm)	23 (0.57)
Insulation	Polyolefin
Insulation Colors	Pair 1: ColorTip Light Blue, Blue Pair 2: ColorTip Light Orange, Orange Pair 3: ColorTip Light Green, Green Pair 4: ColorTip Light Brown, Brown
Jacket	Flame retardant (FR) PVC
Characteristic Impedance Ohms	100 ± 15
Nominal Velocity of Propagation %	70
Performance Compliance	UL® 444 CSA C22.2 No. 214-08 UL 1685 ANSI/TIA-568.2-D ANSI/TIA/EIA-570-B Article 800, NEC (NFPA 70) RoHS-compliant/RoHS 2-compliant
NRTL Programs	UL Verified CAT 6 UL, c(UL) Listed CM

### PRODUCT DESCRIPTION

Superior Essex Category 6 CM cable is designed for residential LAN applications. CAT 6 compliance ensures this cable will support 1000BASE-T Gigabit Ethernet. This cable easily surpasses the Grade 2 requirements specified in the ANSI/TIA/EIA-570-B Residential Telecommunications standard.

### APPLICATIONS

- 10BASE-T through 1000BASE-T Ethernet
- Power over Ethernet (PoE) – IEEE 802.3af
- PoE+ – IEEE 802.3at Type 1 and 2
- ATM and token ring

### FEATURES

- Meets ANSI/TIA-568.2-D specification
- CableID® alpha numeric code printed every 2 feet
- QuickCount® marking system in feet and meters
- ColorTip® circuit identification system
- Color coded box labels

### BENEFITS

- Provides cost effective solution
- Allows both ends of a cable run to be easily identifiable without the need to separately label or tone the cable
- Provides remaining length of cable on reel
- Easily identifiable conductor mates even in low-light environments
- Easily identifies jacket colors

### PART NUMBERS AND PHYSICAL CHARACTERISTICS

Listing	Part Number <sup>1</sup>	Nominal Diameter in (mm)	Approx. Weight lbs./kft (kg/km)	Package	Packages per Pallet
CM	77-272-xG	0.20 (5.1)	20 (30)	1,000' Plywood reel	16

### JACKET COLORS

<sup>1</sup> Replace "x" with:	Blue = 2	Gray = 3	White = 4	Green = 5	Red = 9
--------------------------------	----------	----------	-----------	-----------	---------

UL is a registered trademark of UL LLC.

**ELECTRICAL SPECIFICATIONS**

Frequency MHz	Insertion Loss @ 20°C Maximum dB/100 m		NEXT Minimum dB/100 m		ACR Minimum dB/100 m		PSNEXT Minimum dB/100 m	
	TIA-568.2-D	Superior Essex	TIA-568.2-D	Superior Essex	TIA-568.2-D	Superior Essex	TIA-568.2-D	Superior Essex
	Specified	Typical	Specified	Typical	Calculated	Typical	Specified	Typical
1	2.0	1.7	74.3	82.9	72.3	82.2	72.3	81.9
4	3.8	3.4	65.3	77.6	61.5	74.2	63.3	75.0
8	5.3	4.8	60.8	74.4	55.4	68.9	58.8	71.9
10	6.0	5.4	59.3	70.1	53.3	64.7	57.3	68.3
16	7.6	6.9	56.2	69.6	48.6	62.5	54.2	67.1
20	8.5	7.8	54.8	68.7	46.3	60.7	52.8	65.7
25	9.5	8.8	53.3	66.1	43.8	58.7	51.3	64.7
31.25	10.7	9.8	51.9	67.8	41.2	56.2	49.9	63.4
62.5	15.4	14.2	47.4	64.0	32.0	47.8	45.4	59.1
100	19.8	18.2	44.3	58.0	24.5	38.7	42.3	55.0
155	25.2	23.0	41.4	54.5	16.3	31.6	39.4	52.1
200	29.0	26.6	39.8	53.8	10.8	26.5	37.8	50.6
250	32.8	30.1	38.3	51.0	5.5	21.1	36.3	48.7
300		33.4		53.8		19.4		49.1
350		36.5		50.1		14.3		47.5
400		39.5		49.1		8.0		44.5
450		42.3		44.6		3.3		43.4
500		45.1		42.9				41.7
550		47.7		41.6				39.1

Frequency MHz	PSACR Minimum dB/100 m		Return Loss Minimum dB/100 m		ELFEXT Minimum dB/100 m		PSELFEXT Minimum dB/100 m	
	TIA-568.2-D	Superior Essex	TIA-568.2-D	Superior Essex	TIA-568.2-D	Superior Essex	TIA-568.2-D	Superior Essex
	Calculated	Typical	Specified	Typical	Specified	Typical	Specified	Typical
1	70.3	80.2	20.0	26.0	67.8	78.7	64.8	76.6
4	59.5	71.6	23.0	31.1	55.8	65.9	52.8	64.2
8	53.4	67.1	24.5	34.5	49.7	60.1	46.7	58.4
10	51.3	62.9	25.0	36.3	47.8	58.1	44.8	56.4
16	46.6	60.2	25.0	37.7	43.7	54.0	40.7	52.2
20	44.3	58.1	25.0	36.0	41.8	52.1	38.8	50.3
25	41.8	56.1	24.3	38.6	39.8	50.2	36.8	48.4
31.25	39.2	53.6	23.6	38.3	37.9	48.1	34.9	46.4
62.5	30.0	45.0	21.5	32.8	31.9	41.4	28.9	40.3
100	22.5	37.0	20.1	30.7	27.8	36.8	24.8	35.2
155	14.3	29.1	18.8	28.8	24.0	33.3	21.0	31.9
200	8.8	24.0	18.0	27.6	21.8	32.6	18.8	31.8
250	3.5	18.8	17.3	28.5	19.8	32.5	16.8	31.3
300		15.8		28.6		30.8		28.9
350		11.6		29.0		26.8		25.4
400		5.0		24.9		24.7		23.5
450		1.2		23.9		23.2		21.9
500				25.0		22.5		21.5
550				24.2		22.4		22.0

# Category 6 with FEP Jacket

CMP

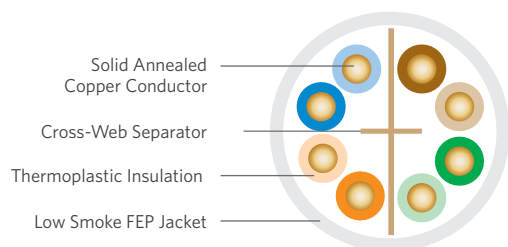

## SPECIFICATIONS

Pair Count	4
Conductor	Solid annealed copper
AWG (mm)	23
Insulation	FEP
Insulation Colors	Pair 1: ColorTip Light Blue, Blue Pair 2: ColorTip Light Orange, Orange Pair 3: ColorTip Light Green, Green Pair 4: ColorTip Light Brown, Brown
Jacket	Low smoke FEP
Characteristic Impedance Ohms	100 ± 15
Nominal Velocity of Propagation %	75
Performance Compliance	NFPA 262 ANSI/TIA-568.2-D Article 800, NEC (NFPA 70)
NRTL Programs	UL Verified 6 UL, c(UL) Listed CMP
Sustainability	UL Certified EPD HPD Multi-Attribute Certification USGBC® Member RoHS-compliant/RoHS 2-compliant REACH-compliant

## ENVIRONMENTAL SPECIFICATIONS

Operation	-40°C to +200°C
Storage/Shipping	-40°C to +200°C
Installation	-40°C to +200°C

## PART NUMBERS AND PHYSICAL CHARACTERISTICS

Part Number <sup>1</sup>	Nominal Diameter in (mm)	Approx. Weight lbs/kft (kg/km)	Package	Packages per Pallet
66-246-xP	0.20 (5.1)	24 (35.82)	1,000' BrakeBox	27
66-272-xP	0.20 (5.1)	24 (35.82)	1,000' Plywood Reel	16

## JACKET COLORS

<sup>1</sup>Replace "x" with: Blue = 2 White = 4

## PRODUCT DESCRIPTION



**FIRST MANUFACTURER IN THE INDUSTRY**  
to offer products that contribute toward LEED!

FEP Jacketed Category 6 Plenum is designed for high-risk applications such as chemical processing plants, petroleum refineries, and temperature extremes. Employing the latest polymer technology, FEP Jacketed Category 6 Plenum is constructed entirely of chemical, oil, heat, and moisture resistant FEP fluoropolymer. It is ideally suited for industrial UTP applications where severe environmental stresses would compromise standard PVC plenum cables. Additionally, the cable is specially processed to ensure a more durable print legend.

## APPLICATIONS

- 10BASE-T through 1000BASE-T Ethernet
- Power over Ethernet (PoE) - IEEE 802.3af
- PoE+ - IEEE 802.3at Type 1 and 2
- ATM and token ring
- Works well in high-risk environments
- For installations with thermal or chemical exposure

## FEATURES

- UL® Certified Environmental Product Declaration (EPD)
- Health Product Declaration™ (HPD™)
- Multi-Attribute Certification by GreenCircle Certified, LLC
- FEP Jacket
- All fluoropolymer construction
- RoHS-compliant
- Meets or exceeds CAT 6 requirements
- Durable cable print
- BrakeBox® payout control system
- QuickCount® marking system in feet and meters
- ColorTip® circuit identification system
- Color-coded box labels

## BENEFITS

- Contributes toward 1 LEED point under the Material and Resources credit (MRc)
- Contributes toward 1 LEED point under the MRc
- Offers an overview of the sustainability of a product, its packaging and manufacturing
- Lower smoke emission in plenum test than PVC
- Resistant to chemical, moisture, thermal exposure
- No heavy metals; no toxic components
- Reliable performance
- Print legend does not rub off
- Adjustable tension control on reel prevents over spin and entangling of cable
- Provides remaining length of cable on reel
- Easily identifiable conductor mates, even in low-light environments
- Easily identifiable jacket colors

**ELECTRICAL SPECIFICATIONS**

Frequency MHz	Insertion Loss @ 20°C Maximum dB/100 m		NEXT Minimum dB/100 m		ACR Minimum dB/100 m		PSNEXT Minimum dB/100 m	
	TIA-568.2-D	Superior Essex	TIA-568.2-D	Superior Essex	TIA-568.2-D	Superior Essex	TIA-568.2-D	Superior Essex
	Specified	Typical	Specified	Typical	Calculated	Typical	Specified	Typical
1	2.0	1.7	74.3	82.9	72.3	82.2	72.3	81.9
4	3.8	3.4	65.3	77.6	61.5	74.2	63.3	75.0
8	5.3	4.8	60.8	74.4	55.4	68.9	58.8	71.9
10	6.0	5.4	59.3	70.1	53.3	64.7	57.3	68.3
16	7.6	6.9	56.2	69.6	48.6	62.5	54.2	67.1
20	8.5	7.8	54.8	68.7	46.3	60.7	52.8	65.7
25	9.5	8.8	53.3	66.1	43.8	58.7	51.3	64.7
31.25	10.7	9.8	51.9	67.8	41.2	56.2	49.9	63.4
62.5	15.4	14.2	47.4	64.0	32.0	47.8	45.4	59.1
100	19.8	18.2	44.3	58.0	24.5	38.7	42.3	55.0
155	25.2	23.0	41.4	54.5	16.3	31.6	39.4	52.1
200	29.0	26.6	39.8	53.8	10.8	26.5	37.8	50.6
250	32.8	30.1	38.3	51.0	5.5	21.1	36.3	48.7
300		33.4		53.8		19.4		49.1
350		36.5		50.1		14.3		47.5
400		39.5		49.1		8.0		44.5
450		42.3		44.6		3.3		43.4
500		45.1		42.9				41.7
550		47.7		41.6				39.1

Frequency MHz	PSACR Minimum dB/100 m		Return Loss Minimum dB/100 m		ELFEXT Minimum dB/100 m		PSELFEXT Minimum dB/100 m	
	TIA-568.2-D	Superior Essex	TIA-568.2-D	Superior Essex	TIA-568.2-D	Superior Essex	TIA-568.2-D	Superior Essex
	Calculated	Typical	Specified	Typical	Specified	Typical	Specified	Typical
1	70.3	80.2	20.0	26.0	67.8	78.7	64.8	76.6
4	59.5	71.6	23.0	31.1	55.8	65.9	52.8	64.2
8	53.4	67.1	24.5	34.5	49.7	60.1	46.7	58.4
10	51.3	62.9	25.0	36.3	47.8	58.1	44.8	56.4
16	46.6	60.2	25.0	37.7	43.7	54.0	40.7	52.2
20	44.3	58.1	25.0	36.0	41.8	52.1	38.8	50.3
25	41.8	56.1	24.3	38.6	39.8	50.2	36.8	48.4
31.25	39.2	53.6	23.6	38.3	37.9	48.1	34.9	46.4
62.5	30.0	45.0	21.5	32.8	31.9	41.4	28.9	40.3
100	22.5	37.0	20.1	30.7	27.8	36.8	24.8	35.2
155	14.3	29.1	18.8	28.8	24.0	33.3	21.0	31.9
200	8.8	24.0	18.0	27.6	21.8	32.6	18.8	31.8
250	3.5	18.8	17.3	28.5	19.8	32.5	16.8	31.3
300		15.8		28.6		30.8		28.9
350		11.6		29.0		26.8		25.4
400		5.0		24.9		24.7		23.5
450		1.2		23.9		23.2		21.9
500				25.0		22.5		21.5
550				24.2		22.4		22.0

**SUSTAINABILITY LEADERSHIP**



UL and the related logo are registered trademarks of UL LLC. Health Product Declaration, HPD and the related logo are trademarks of Health Product Declaration Collaborative. GreenCircle Certified logo is a registered trademark of GreenCircle Certified, LLC. USGBC and the related logo are registered trademarks of U.S. Green Building Council.

# Category 6

## CMR/CMX Outdoor Sunlight Resistant

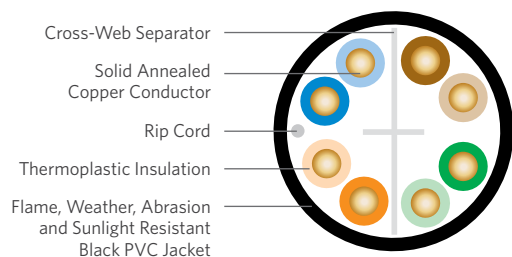

### SPECIFICATIONS

Pair Count	4
Conductor	Solid annealed copper
AWG (mm)	23 (0.57)
Insulation	Polyolefin
Insulation Colors	Pair 1: ColorTip Light Blue, Blue Pair 2: ColorTip Light Orange, Orange Pair 3: ColorTip Light Green, Green Pair 4: ColorTip Light Brown, Brown
Ripcord	Non-wicking polyester yarn
Jacket	Tough, flame retardant, weather, sunlight and abrasion resistant riser PVC
Jacket Color	Black
Characteristic Impedance Ohms	100 ± 15
Nominal Velocity of Propagation %	70
Performance Compliance	UL 444 CSA C22.2 No. 214-08 UL 1581 UL 1666 ANSI/TIA-568.2-D ANSI/TIA/EIA-570-B Article 800, NEC (NFPA 70) RoHS-compliant/RoHS 2-compliant
NRTL Programs	UL Verified CAT 6 UL, c(UL) Listed CMR UL, c(UL) Listed CMX Outdoor Sunlight Resistant

### ENVIRONMENTAL SPECIFICATIONS AND TESTS

Operation	-40°F to +167°F (-40°C to +75°C)
Installation	-40°F to +140°F (-40°C to +60°C)
ANSI/ICEA S-100-685-2009 <b>Tested down to -67°F (-55°C)</b>	Section 7.1: -4°F (-20°C) cold bend test Section 7.2: +14°F (-10°C) cold impact test Section 7.3: -40°F (-40°C) anvil test

### PART NUMBERS AND PHYSICAL CHARACTERISTICS

Part Number	Nominal Diameter in (mm)	Approx. Weight lbs/kft (kg/km)	Package	Packages per Pallet
77-246-E1	0.27 (6.9)	33 (49.25)	1,000' BrakeBox	12

UL is a registered trademark of UL LLC.

### PRODUCT DESCRIPTION

The Superior Essex Category 6 CMR/CMX Outdoor Sunlight Resistant cable is specifically designed for extreme sunlight and temperature applications. The level of UV blocking compounds is the same as in traditional Outside Plant (OSP) cable products, with the black color preventing damage from long-term UV sunlight exposure. Applications include Ethernet interconnect cable for Wi-Fi or retrofit cable installations that employ exterior runs having long-term outdoor exposure between two environmentally protected points. CMX Outdoor cables are designed to extend the run between the Network Interface Unit and the point of entry into the interior of a residence or a premise.

Superior Essex CAT 6 CMR/CMX Outdoor Sunlight Resistant black premises cable has been tested and listed as UL® 444 Sunlight Resistant compliant. This designation requires the cable to resist 720 hours of harsh UV and heat, which is more than twice the exposure time of the standard 300 hours required in the CMX Outdoor test. In addition, the CMR listing allows the cable to be used in riser spaces per UL 1666, eliminating the need to transition to fire resistant cables.

### APPLICATIONS

- 10BASE-T through 1000BASE-T Ethernet
- Power over Ethernet (PoE) - IEEE 802.3af
- PoE+ - IEEE 802.3at Type 1 and 2
- Wi-Fi - IEEE 802.11a/b/g/n

### FEATURES

- Combined indoor/outdoor rating
- UL 444/UL 1581 Sunlight Resistant Listed
- Meets ANSI/TIA-568.2-D specification
- BrakeBox® payout control system
- Moisture-resistant package
- CableID® alpha numeric code printed every 2 feet
- QuickCount® marking system in feet and meters
- ColorTip® Circuit Identification System
- Rip cord applied under jacket
- RoHS-compliant

### BENEFITS

- Reduces inventory by eliminating multiple cable types
- Increased life in direct, long term sunlight
- CAT 6 performance
- Adjustable tension control on reel prevents over spin and entangling of cable
- Resists damp conditions that might weaken standard packages
- Allows both ends of a cable run to be easily identifiable without the need to separately label or tone the cable
- Provides remaining length of cable on reel
- Easily identifiable conductor mates even in low-light environments
- Facilitates easy opening
- No heavy metals; and no toxic components



### CAUTIONARY INFORMATION

- Do not use as a substitute for Outside Plant (OSP) cables.
- Do not use in conduit or direct burial which can flood. These cables are not designed for extended exposure to water.



**ELECTRICAL SPECIFICATIONS**

Frequency MHz	Insertion Loss @ 20°C Maximum dB/100 m		NEXT Minimum dB/100 m		ACR Minimum dB/100 m		PSNEXT Minimum dB/100 m	
	TIA-568.2-D	Superior Essex	TIA-568.2-D	Superior Essex	TIA-568.2-D	Superior Essex	TIA-568.2-D	Superior Essex
	Specified	Typical	Specified	Typical	Calculated	Typical	Specified	Typical
1	2.0	1.7	74.3	82.9	72.3	82.2	72.3	81.9
4	3.8	3.4	65.3	77.6	61.5	74.2	63.3	75.0
8	5.3	4.8	60.8	74.4	55.4	68.9	58.8	71.9
10	6.0	5.4	59.3	70.1	53.3	64.7	57.3	68.3
16	7.6	6.9	56.2	69.6	48.6	62.5	54.2	67.1
20	8.5	7.8	54.8	68.7	46.3	60.7	52.8	65.7
25	9.5	8.8	53.3	66.1	43.8	58.7	51.3	64.7
31.25	10.7	9.8	51.9	67.8	41.2	56.2	49.9	63.4
62.5	15.4	14.2	47.4	64.0	32.0	47.8	45.4	59.1
100	19.8	18.2	44.3	58.0	24.5	38.7	42.3	55.0
155	25.2	23.0	41.4	54.5	16.3	31.6	39.4	52.1
200	29.0	26.6	39.8	53.8	10.8	26.5	37.8	50.6
250	32.8	30.1	38.3	51.0	5.5	21.1	36.3	48.7
300		33.4		53.8		19.4		49.1
350		36.5		50.1		14.3		47.5
400		39.5		49.1		8.0		44.5
450		42.3		44.6		3.3		43.4
500		45.1		42.9				41.7
550		47.7		41.6				39.1

Frequency MHz	PSACR Minimum dB/100 m		Return Loss Minimum dB/100 m		ELFEXT Minimum dB/100 m		PSELFEXT Minimum dB/100 m	
	TIA-568.2-D	Superior Essex	TIA-568.2-D	Superior Essex	TIA-568.2-D	Superior Essex	TIA-568.2-D	Superior Essex
	Calculated	Typical	Specified	Typical	Specified	Typical	Specified	Typical
1	70.3	80.2	20.0	26.0	67.8	78.7	64.8	76.6
4	59.5	71.6	23.0	31.1	55.8	65.9	52.8	64.2
8	53.4	67.1	24.5	34.5	49.7	60.1	46.7	58.4
10	51.3	62.9	25.0	36.3	47.8	58.1	44.8	56.4
16	46.6	60.2	25.0	37.7	43.7	54.0	40.7	52.2
20	44.3	58.1	25.0	36.0	41.8	52.1	38.8	50.3
25	41.8	56.1	24.3	38.6	39.8	50.2	36.8	48.4
31.25	39.2	53.6	23.6	38.3	37.9	48.1	34.9	46.4
62.5	30.0	45.0	21.5	32.8	31.9	41.4	28.9	40.3
100	22.5	37.0	20.1	30.7	27.8	36.8	24.8	35.2
155	14.3	29.1	18.8	28.8	24.0	33.3	21.0	31.9
200	8.8	24.0	18.0	27.6	21.8	32.6	18.8	31.8
250	3.5	18.8	17.3	28.5	19.8	32.5	16.8	31.3
300		15.8		28.6		30.8		28.9
350		11.6		29.0		26.8		25.4
400		5.0		24.9		24.7		23.5
450		1.2		23.9		23.2		21.9
500				25.0		22.5		21.5
550				24.2		22.4		22.0

# Category 6

## CMR/CMX Outdoor

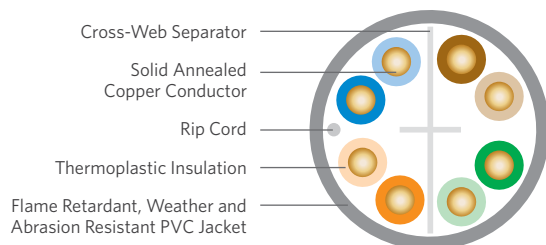

### SPECIFICATIONS

Pair Count	4
Conductor	Solid annealed copper
AWG (mm)	23 (0.57)
Insulation	Polyolefin
Insulation Colors	Pair 1: ColorTip Light Blue, Blue Pair 2: ColorTip Light Orange, Orange Pair 3: ColorTip Light Green, Green Pair 4: ColorTip Light Brown, Brown
Ripcord	Non-wicking polyester yarn
Jacket	Tough, flame retardant, weather, UV and abrasion resistant riser PVC
Characteristic Impedance Ohms	100 ± 15
Nominal Velocity of Propagation %	70
Performance Compliance	UL 444 CSA C22.2 No. 214-08 UL 1581 UL 1666 ANSI/TIA-568.2-D ANSI/TIA/EIA-570-B Article 800, NEC (NFPA 70) RoHS-compliant/RoHS 2-compliant
NRTL Programs	UL Verified CAT 6 UL, c(UL) Listed CMR UL, c(UL) Listed CMX Outdoor

### ENVIRONMENTAL SPECIFICATIONS AND TESTS

Operation	-40°F to +167°F (-40°C to +75°C)
Installation	-40°F to +140°F (-40°C to +60°C)
ANSI/ICEA S-100-685-2009 Tested down to -67°F (-55°C)	Section 7.1: -4°F (-20°C) cold bend test Section 7.2: +14°F (-10°C) cold impact test Section 7.3: -40°F (-40°C) anvil test

### PART NUMBERS AND PHYSICAL CHARACTERISTICS

Part Number <sup>1</sup>	Nominal Diameter in (mm)	Approx. Weight lbs/kft (kg/km)	Package	Packages per Pallet
77-246-x1	0.27 (6.9)	33 (49.25)	1,000' BrakeBox	12

### JACKET COLORS

<sup>1</sup> Replace "x" with:	Beige = 1	Blue = 2	Gray = 3	White = 4
--------------------------------	-----------	----------	----------	-----------

UL is a registered trademark of UL LLC.

### PRODUCT DESCRIPTION

The Superior Essex Category 6 CMR/CMX Outdoor cable is specifically designed for outdoor applications. UV-blocking compounds aid in protecting the cable from light. Applications include Ethernet interconnect cable for Wi-Fi or retrofit cable installations that employ exterior runs having long-term outdoor exposure between two environmentally protected points. CMX Outdoor cables are designed to extend the run between the Network Interface Unit and the point of entry into the interior of a residence or a premise.

Superior Essex CAT 6 CMR/CMX Outdoor premises cable has been tested and listed as UL® 444 Outdoor compliant. This designation requires the cable to resist 300 hours of UV and heat. In addition, the CMR listing allows the cable to be used in riser spaces per UL 1666, eliminating the need to transition to fire resistant cables.

### APPLICATIONS

- 10BASE-T through 1000BASE-T Ethernet
- Power over Ethernet (PoE) - IEEE 802.3af
- PoE+ - IEEE 802.3at Type 1 and 2
- Wi-Fi - IEEE 802.11a/b/g/n

### FEATURES

- Combined indoor/outdoor rating
- Meets ANSI/TIA-568.2-D specification
- BrakeBox® payout control system
- Moisture-resistant package
- CableID® alpha numeric code printed every 2 feet
- QuickCount® marking system in feet and meters
- ColorTip® Circuit Identification System
- Rip cord applied under jacket
- RoHS-compliant

### BENEFITS

- Reduces inventory by eliminating multiple cable types
- CAT 6 performance
- Adjustable tension control on reel prevents over spin and entangling of cable
- Resists damp conditions that might weaken standard packages
- Allows both ends of a cable run to be easily identifiable without the need to separately label or tone the cable
- Provides remaining length of cable on reel
- Easily identifiable conductor mates even in low-light environments
- Facilitates easy opening
- No heavy metals; and no toxic components



### CAUTIONARY INFORMATION

- Do not use as a substitute for Outside Plant (OSP) cables.
- Do not use in conduit or direct burial which can flood. These cables are not designed for extended exposure to water.

**ELECTRICAL SPECIFICATIONS**

Frequency MHz	Insertion Loss @ 20°C Maximum dB/100 m		NEXT Minimum dB/100 m		ACR Minimum dB/100 m		PSNEXT Minimum dB/100 m	
	TIA-568.2-D	Superior Essex	TIA-568.2-D	Superior Essex	TIA-568.2-D	Superior Essex	TIA-568.2-D	Superior Essex
	Specified	Typical	Specified	Typical	Calculated	Typical	Specified	Typical
1	2.0	1.7	74.3	82.9	72.3	82.2	72.3	81.9
4	3.8	3.4	65.3	77.6	61.5	74.2	63.3	75.0
8	5.3	4.8	60.8	74.4	55.4	68.9	58.8	71.9
10	6.0	5.4	59.3	70.1	53.3	64.7	57.3	68.3
16	7.6	6.9	56.2	69.6	48.6	62.5	54.2	67.1
20	8.5	7.8	54.8	68.7	46.3	60.7	52.8	65.7
25	9.5	8.8	53.3	66.1	43.8	58.7	51.3	64.7
31.25	10.7	9.8	51.9	67.8	41.2	56.2	49.9	63.4
62.5	15.4	14.2	47.4	64.0	32.0	47.8	45.4	59.1
100	19.8	18.2	44.3	58.0	24.5	38.7	42.3	55.0
155	25.2	23.0	41.4	54.5	16.3	31.6	39.4	52.1
200	29.0	26.6	39.8	53.8	10.8	26.5	37.8	50.6
250	32.8	30.1	38.3	51.0	5.5	21.1	36.3	48.7
300		33.4		53.8		19.4		49.1
350		36.5		50.1		14.3		47.5
400		39.5		49.1		8.0		44.5
450		42.3		44.6		3.3		43.4
500		45.1		42.9				41.7
550		47.7		41.6				39.1

Frequency MHz	PSACR Minimum dB/100 m		Return Loss Minimum dB/100 m		ELFEXT Minimum dB/100 m		PSELFEXT Minimum dB/100 m	
	TIA-568.2-D	Superior Essex	TIA-568.2-D	Superior Essex	TIA-568.2-D	Superior Essex	TIA-568.2-D	Superior Essex
	Calculated	Typical	Specified	Typical	Specified	Typical	Specified	Typical
1	70.3	80.2	20.0	26.0	67.8	78.7	64.8	76.6
4	59.5	71.6	23.0	31.1	55.8	65.9	52.8	64.2
8	53.4	67.1	24.5	34.5	49.7	60.1	46.7	58.4
10	51.3	62.9	25.0	36.3	47.8	58.1	44.8	56.4
16	46.6	60.2	25.0	37.7	43.7	54.0	40.7	52.2
20	44.3	58.1	25.0	36.0	41.8	52.1	38.8	50.3
25	41.8	56.1	24.3	38.6	39.8	50.2	36.8	48.4
31.25	39.2	53.6	23.6	38.3	37.9	48.1	34.9	46.4
62.5	30.0	45.0	21.5	32.8	31.9	41.4	28.9	40.3
100	22.5	37.0	20.1	30.7	27.8	36.8	24.8	35.2
155	14.3	29.1	18.8	28.8	24.0	33.3	21.0	31.9
200	8.8	24.0	18.0	27.6	21.8	32.6	18.8	31.8
250	3.5	18.8	17.3	28.5	19.8	32.5	16.8	31.3
300		15.8		28.6		30.8		28.9
350		11.6		29.0		26.8		25.4
400		5.0		24.9		24.7		23.5
450		1.2		23.9		23.2		21.9
500				25.0		22.5		21.5
550				24.2		22.4		22.0

# Category 6 Patch Cable

CMR

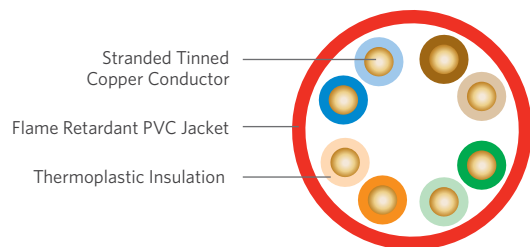
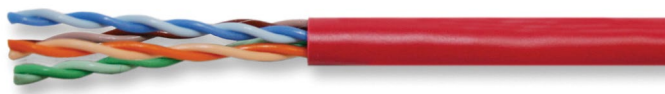

## SPECIFICATIONS

Pair Count	4
Conductor	Stranded tinned copper
AWG (mm)	24 (0.50)
Insulation	CMR: Polyolefin
Insulation Colors	Pair 1: ColorTip Light Blue, Blue Pair 2: ColorTip Light Orange, Orange Pair 3: ColorTip Light Green, Green Pair 4: ColorTip Light Brown, Brown
Jacket	CMR: Flame retardant (FR) PVC
Characteristic Impedance Ohms	100 ± 15
Nominal Velocity of Propagation %	CMR: 68
Performance Compliance	UL 444 CSA C22.2 No. 214-08 UL 1666 ANSI/TIA-568.2-D Article 800, NEC (NFPA 70)
NRTL Programs	UL Verified CAT 6 UL, c(UL) Listed CMR

## PART NUMBERS AND PHYSICAL CHARACTERISTICS

Listing	Part Number <sup>1</sup>	Nominal Diameter in (mm)	Approx. Weight lbs/kft (kg/km)	Package
CMR	P7-L33-yA	0.21 (5.3)	20 (30)	500' Reel
CMR	P7-L72-yA	0.21 (5.3)	20 (30)	1,000' Reel
CMR	P7-L21-yA	0.21 (5.3)	20 (30)	5,000' Reel

## JACKET COLORS

<sup>1</sup>Replace "y" with:

Blue = 2

Gray = 3

White = 4

Green = 5

Yellow = 6

Purple = 7

Red = 9

Pink = C

Orange = D

Black = E

## PRODUCT DESCRIPTION

Superior Essex Category 6 patch cable product line provides exceptional value for jobs that require standards compliant Category 6 patch cable at a cost-effective price.

## APPLICATIONS

- 10BASE-T through 1000BASE-T Ethernet
- PoE+ - IEEE 802.3bt Type 1 to Type 4
- ATM and token ring

## FEATURES

- Meets ANSI/TIA-568.2-D specification
- BrakeBox® payout control system
- ColorTip® circuit identification system

## BENEFITS

- Provides cost effective solution
- Adjustable tension control on reel prevents over spin and entangling of cable
- Easily identifiable conductor mates even in low-light environments

# Category 6 Patch Cable

CM

**PRODUCT DESCRIPTION**

Superior Essex Category 6 patch cable product line provides exceptional value for jobs that require standards compliant Category 6 patch cable at a cost-effective price.

**APPLICATIONS**

- 10BASE-T through 1000BASE-T Ethernet
- PoE+ - IEEE 802.3bt Type 1 to Type 4
- ATM and token ring

**FEATURES**

- Meets ANSI/TIA-568.2-D specification
- BrakeBox® payout control system
- ColorTip® circuit identification system

**BENEFITS**

- Provides cost effective solution
- Adjustable tension control on reel prevents over spin and entangling of cable
- Easily identifiable conductor mates even in low-light environments

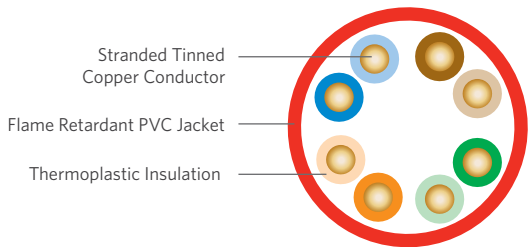

SPECIFICATIONS	
Pair Count	4
Conductor	Stranded tinned copper
AWG (mm)	24 (0.50)
Insulation	CM: Polyolefin
Insulation Colors	Pair 1: ColorTip Light Blue, Blue Pair 2: ColorTip Light Orange, Orange Pair 3: ColorTip Light Green, Green Pair 4: ColorTip Light Brown, Brown
Jacket	CM: Flame retardant (FR) PVC
Characteristic Impedance Ohms	100 ± 15
Nominal Velocity of Propagation %	CM: 68
Performance Compliance	UL 444 CSA C22.2 No. 214-08 UL 1685 ANSI/TIA-568.2-D Article 800, NEC (NFPA 70)
NRTL Programs	UL Verified CAT 6 UL, c(UL) Listed CM

**PART NUMBERS AND PHYSICAL CHARACTERISTICS**

Listing	Part Number <sup>1</sup>	Nominal Diameter in (mm)	Approx. Weight lbs/kft (kg/km)	Package
CM	P7-L33-yG	0.21 (5.3)	20 (30)	500' Reel
CM	P7-L72-yG	0.21 (5.3)	20 (30)	1,000' Reel
CM	P7-L21-yG	0.21 (5.3)	20 (30)	5,000' Reel

**JACKET COLORS**

<sup>1</sup>Replace "y" with:

Blue = 2	Gray = 3	White = 4	Green = 5	Yellow = 6	Purple = 7	Red = 9	Pink = C	Orange = D	Black = E
----------	----------	-----------	-----------	------------	------------	---------	----------	------------	-----------

# Cobra Category 5e+

CMR/CMP

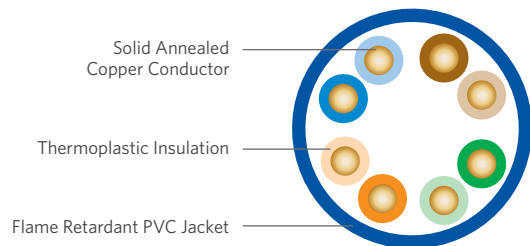

## PRODUCT DESCRIPTION



**FIRST MANUFACTURER IN THE INDUSTRY**  
to offer products that contribute toward LEED!

Cobra Category 5e+ cable is the performance leader in its class. Cobra cable is ideal for installations that require true “future proofing” in channel performance. By design, Cobra cables are manufactured to the highest quality standards, design requirements and materials to ensure that every box provides significant margin over ANSI/TIA-568.2-D specifications for NEXT, Power Sum NEXT and Insertion Loss.

## APPLICATIONS

- 10BASE-T through 100BASE-T Ethernet
- Power over Ethernet (PoE) - IEEE 802.3af
- PoE+ - IEEE 802.3at Type 1 and 2
- ATM and token ring

## FEATURES

- UL Certified Environmental Product Declaration (EPD)
- Health Product Declaration™ (HPD™)
- Multi-Attribute Certification by GreenCircle Certified, LLC
- Guaranteed NEXT of 3 dB greater than ANSI/TIA-568.2-D specification across frequency range
- Guaranteed ACR of 19.5 dB at 100 MHz
- Exceptional PSNEXT, PSELFEXT and PSACR over CAT 5e
- “WideMouth” POP™ Box design
- CableID® alpha numeric code printed every 2 feet
- QuickCount® marking system in feet and meters
- ColorTip® circuit identification system
- Color coded box labels
- Contributes toward 1 LEED point under the Material and Resources credit (MRC)
- Contributes toward 1 LEED point under the MRC
- Offers an overview of the sustainability of a product, its packaging and manufacturing
- Greater assurance of exceptional overall channel performance
- Performance assurance for multiple high-bandwidth applications
- Reduces BER, improving network efficiency
- Reduces tension on wire to ensure proper electrical performance after installation
- Allows both ends of a cable run to be easily identifiable without the need to separately label or tone the cable
- Provides remaining length of cable on reel
- Easily identifiable conductor mates even in low-light environments
- Easily identifies jacket colors

## BENEFITS

SPECIFICATIONS	
Pair Count	4
Conductor	Solid annealed copper
AWG (mm)	24 (0.51)
Insulation	CMR: Polyolefin CMP: FEP
Insulation Colors	Pair 1: ColorTip Light Blue, Blue Pair 2: ColorTip Light Orange, Orange Pair 3: ColorTip Light Green, Green Pair 4: ColorTip Light Brown, Brown
Jacket	CMR: Flame retardant (FR) PVC CMP: FR, low smoke PVC
Characteristic Impedance Ohms	100 ± 15
Nominal Velocity of Propagation %	CMR: 70 CMP: 73
Performance Compliance	UL 444 CSA C22.2 No. 214-08 UL 1666 NFPA 262 ANSI/TIA-568.2-D ANSI/ICEA S-90-661-2012 Article 800, NEC (NFPA 70)
NRTL Programs	UL Verified CAT 5e UL, c(UL) Listed CMR UL, c(UL) Listed CMP
Sustainability	UL Certified EPD HPD Multi-Attribute Certification USGBC® Member RoHS-compliant/RoHS 2-compliant REACH-compliant

## PART NUMBERS AND PHYSICAL CHARACTERISTICS

Listing	Part Number <sup>1</sup>	Nominal Diameter in (mm)	Approx. Weight lbs./kft (kg./km)	Package	Packages per Pallet
CMR	52-200-x5	0.19 (4.8)	19 (28)	1,000' Reel-in-a-Box	45
CMR	52-240-x5	0.19 (4.8)	19 (28)	1,000' POP box	36
CMP	52-200-x8	0.19 (4.8)	19 (28)	1,000' Reel-in-a-Box	45
CMP	52-241-x8	0.19 (4.8)	19 (28)	1,000' POP box	36

## JACKET COLORS

<sup>1</sup>Replace “x” with: Blue = 2 Gray = 3 White = 4 Green = 5 Yellow = 6 Purple = 7 Red = 9 Brown = B Orange = D Black = E

**ELECTRICAL SPECIFICATIONS**

Frequency MHz	Insertion Loss @ 20°C Maximum dB/100 m			NEXT Minimum dB/100 m			ACR Minimum dB/100 m			PSNEXT Minimum dB/100 m		
	TIA-568.2-D	Superior Essex		TIA-568.2-D	Superior Essex		TIA-568.2-D	Superior Essex		TIA-568.2-D	Superior Essex	
	Specified	Guaranteed	Typical	Specified	Guaranteed	Typical	Calculated	Guaranteed	Typical	Specified	Guaranteed	Typical
1	2.0	2.0	1.8	65.3	68.3	79.5	63.3	67.4	77.7	62.3	66.3	77.2
4	4.1	4.0	3.6	56.3	59.3	69.9	52.2	56.4	66.4	53.3	57.3	67.5
8	5.8	5.7	5.1	51.8	54.8	65.1	46.0	50.3	60.0	48.8	52.8	62.7
10	6.5	6.4	5.8	50.3	53.3	63.6	43.8	48.2	57.9	47.3	51.3	61.2
16	8.2	8.1	7.4	47.2	50.3	60.4	39.0	43.4	53.1	44.2	48.3	58.0
20	9.3	9.2	8.3	45.8	48.8	59.0	36.5	41.0	50.9	42.8	46.8	56.6
25	10.4	10.3	9.3	44.3	47.3	57.5	33.9	38.5	48.3	41.3	45.3	55.1
31.25	11.7	11.6	10.4	42.9	45.9	56.0	31.2	35.8	45.7	39.9	43.9	53.5
62.5	17.0	16.8	14.9	38.4	41.4	51.7	21.4	26.2	36.8	35.4	39.4	49.2
100	22.0	21.7	19.1	35.3	38.3	48.5	13.3	21.0	29.5	32.3	36.3	46.0
155		27.7	24.2		35.5	45.7		9.3	21.6		33.5	43.1
200		32.1	27.8		29.8	43.6		3.5	16.0		27.8	41.0
250		36.5	31.4		28.3	42.0			10.7		26.3	39.4
300		40.5	34.7		27.2	40.4			5.9		25.2	37.9
350		44.4	37.7		26.2	39.3			1.7		24.2	36.8

Frequency MHz	PSACR Minimum dB/100 m			Return Loss Minimum dB/100 m			ELFEXT Minimum dB/100 m			PSELFEXT Minimum dB/100 m		
	TIA-568.2-D	Superior Essex		TIA-568.2-D	Superior Essex		TIA-568.2-D	Superior Essex		TIA-568.2-D	Superior Essex	
	Calculated	Guaranteed	Typical	Specified	Guaranteed	Typical	Specified	Guaranteed	Typical	Specified	Guaranteed	Typical
1	60.3	64.4	75.4	20.0	20.0	28.5	63.8	63.8	72.6	60.8	60.8	70.8
4	49.2	53.4	64.0	23.0	23.0	35.6	51.8	51.7	60.7	48.8	48.8	59.0
8	43.0	47.3	57.7	24.5	24.5	35.7	45.7	45.7	54.8	42.7	42.7	53.1
10	40.8	45.2	55.6	25.0	25.0	35.9	43.8	43.8	52.9	40.8	40.8	51.1
16	36.0	40.4	50.8	25.0	25.0	35.2	39.7	39.7	48.9	36.7	36.7	47.1
20	33.5	38.0	48.6	25.0	25.0	34.9	37.8	37.7	47.0	34.8	34.8	45.2
25	30.9	35.5	46.0	24.3	24.3	35.3	35.8	35.8	45.1	32.8	32.8	43.3
31.25	28.2	32.8	43.4	23.6	23.6	34.8	33.9	33.9	43.2	30.9	30.9	41.3
62.5	18.4	23.2	34.6	21.5	21.5	31.8	27.9	27.8	37.2	24.9	24.9	35.2
100	10.3	18.0	27.3	20.1	20.1	30.1	23.8	23.8	33.2	20.8	20.8	31.1
155		6.3	19.4		18.8	28.4		19.9	29.3		16.9	27.2
200		0.5	13.9		18.0	27.3		11.7	27.1		10.7	25.0
250			8.6		17.3	26.1		9.8	25.1		8.8	23.1
300			3.8		16.8	25.1		8.2	23.7		7.2	21.5
350					16.3	24.0		6.9	22.5		5.9	20.3

**SUSTAINABILITY LEADERSHIP**



UL and the related logo are registered trademarks of UL LLC. Health Product Declaration, HPD and the related logo are trademarks of Health Product Declaration Collaborative. GreenCircle Certified logo is a registered trademark of GreenCircle Certified, LLC. USGBC and the related logo are registered trademarks of U.S. Green Building Council.

# Category 5e+ F/UTP (ScTP)

CMR/CMP

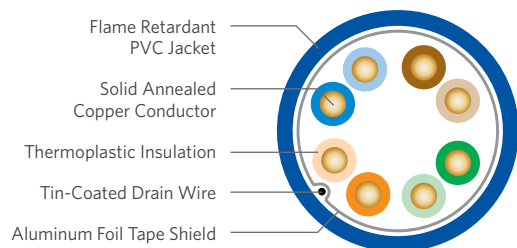

## SPECIFICATIONS

Pair Count	4
Conductor	Solid annealed copper
AWG (mm)	24 (0.51)
Insulation	CMR: Polyolefin CMP: FEP
Insulation Colors	Pair 1: ColorTip Light Blue, Blue Pair 2: ColorTip Light Orange, Orange Pair 3: ColorTip Light Green, Green Pair 4: ColorTip Light Brown, Brown
Shield	Aluminum foil tape
Drain Wire	24 AWG tinned copper
Jacket	CMR: Flame retardant (FR) PVC CMP: FR, low smoke PVC
Characteristic Impedance Ohms	100 ± 15
Nominal Velocity of Propagation %	CMR: 67 CMP: 70
Performance Compliance	UL 444 CSA C22.2 No. 214-08 UL 1666 NFPA 262 ANSI/TIA-568.2-D ANSI/ICEA S-90-661-2012 Article 800, NEC (NFPA 70)
NRTL Programs	UL Verified CAT 5e UL, c(UL) Listed CMR UL, c(UL) Listed CMP
Sustainability	UL Certified EPD HPD Multi-Attribute Certification USGBC® Member RoHS-compliant/RoHS 2-compliant REACH-compliant

## PART NUMBERS AND PHYSICAL CHARACTERISTICS

Listing	Part Number <sup>1</sup>	Nominal Diameter in (mm)	Approx. Weight lbs./kft (kg/km)	Package	Packages per Pallet
CMR	5F-220-x5	0.26 (6.6)	31 (46)	1,000' Plywood reel	12
CMP	5F-220-x8	0.25 (6.4)	30 (45)	1,000' Plywood reel	12

## JACKET COLORS

<sup>1</sup>Replace "x" with:

Blue = 2

Gray = 3

White = 4

Green = 5

Yellow = 6

Red = 9

Orange = D

Black = E

## PRODUCT DESCRIPTION



**FIRST MANUFACTURER IN THE INDUSTRY**  
to offer products that contribute toward LEED!

Superior Essex offers Screen Twisted Pair (ScTP) shielded Category 5e+ cables in both plenum and riser versions. The cable has guaranteed performance out to 350 MHz and meets all applicable ANSI/TIA-568.2-D requirements. The cable consists of four balanced 24 AWG copper pairs. The core is wrapped with an aluminum foil tape and has a tin coated drain wire. The tape wrapped core is jacketed with the appropriate flexible PVC jacket for plenum or riser applications.

## APPLICATIONS

- 10BASE-T through 1000BASE-T Ethernet
- Power over Ethernet (PoE) - IEEE 802.3af
- PoE+ - IEEE 802.3at Type 1 and 2
- ATM and token ring
- Applications requiring secure networks or protection from EMI/RFI

## FEATURES

- UL Certified Environmental Product Declaration (EPD)
- Health Product Declaration™ (HPD™)
- Multi-Attribute Certification by GreenCircle Certified, LLC
- Aluminum foil tape covers all 4-pair
- Exceeds ANSI/TIA-568.2-D for CAT 5e cable performance
- Guaranteed performance to 350 MHz
- CableID® alpha numeric code printed every 2 feet
- QuickCount® marking system in feet and meters
- ColorTip® circuit identification system
- Color coded box labels

## BENEFITS

- Contributes toward 1 LEED point under the Material and Resources credit (MRc)
- Contributes toward 1 LEED point under the MRC
- Offers an overview of the sustainability of a product, its packaging and manufacturing
- Protects against EMI/RFI and provides greater security
- Assures compliance for all current networking applications (up to 1000BASE-T)
- Assures ample bandwidth headroom
- Allows both ends of a cable run to be easily identifiable without the need to separately label or tone the cable
- Provides remaining length of cable on reel
- Easily identifiable conductor mates even in low-light environments
- Easily identifies jacket colors



**ELECTRICAL SPECIFICATIONS**

Frequency MHz	Insertion Loss @ 20°C Maximum dB/100 m			NEXT Minimum dB/100 m			ACR Minimum dB/100 m			PSNEXT Minimum dB/100 m		
	TIA-568.2-D	Superior Essex		TIA-568.2-D	Superior Essex		TIA-568.2-D	Superior Essex		TIA-568.2-D	Superior Essex	
	Specified	Guaranteed	Typical	Specified	Guaranteed	Typical	Calculated	Guaranteed	Typical	Specified	Guaranteed	Typical
1	2.0	2.0	1.8	65.3	68.3	79.5	63.3	67.4	77.7	62.3	66.3	77.2
4	4.1	4.0	3.6	56.3	59.3	69.9	52.2	56.4	66.4	53.3	57.3	67.5
8	5.8	5.7	5.1	51.8	54.8	65.1	46.0	50.3	60.0	48.8	52.8	62.7
10	6.5	6.4	5.8	50.3	53.3	63.6	43.8	48.2	57.9	47.3	51.3	61.2
16	8.2	8.1	7.4	47.2	50.3	60.4	39.0	43.4	53.1	44.2	48.3	58.0
20	9.3	9.2	8.3	45.8	48.8	59.0	36.5	41.0	50.9	42.8	46.8	56.6
25	10.4	10.3	9.3	44.3	47.3	57.5	33.9	38.5	48.3	41.3	45.3	55.1
31.25	11.7	11.6	10.4	42.9	45.9	56.0	31.2	35.8	45.7	39.9	43.9	53.5
62.5	17.0	16.8	14.9	38.4	41.4	51.7	21.4	26.2	36.8	35.4	39.4	49.2
100	22.0	21.7	19.1	35.3	38.3	48.5	13.3	21.0	29.5	32.3	36.3	46.0
155		27.7	24.2		35.5	45.7		9.3	21.6		33.5	43.1
200		32.1	27.8		29.8	43.6		3.5	16.0		27.8	41.0
250		36.5	31.4		28.3	42.0			10.7		26.3	39.4
300		40.5	34.7		27.2	40.4			5.9		25.2	37.9
350		44.4	37.7		26.2	39.3			1.7		24.2	36.8

Frequency MHz	PSACR Minimum dB/100 m			Return Loss Minimum dB/100 m			ELFEXT Minimum dB/100 m			PSELFEXT Minimum dB/100 m		
	TIA-568.2-D	Superior Essex		TIA-568.2-D	Superior Essex		TIA-568.2-D	Superior Essex		TIA-568.2-D	Superior Essex	
	Calculated	Guaranteed	Typical	Specified	Guaranteed	Typical	Specified	Guaranteed	Typical	Specified	Guaranteed	Typical
1	60.3	64.4	75.4	20.0	20.0	28.5	63.8	63.8	72.6	60.8	60.8	70.8
4	49.2	53.4	64.0	23.0	23.0	35.6	51.8	51.7	60.7	48.8	48.8	59.0
8	43.0	47.3	57.7	24.5	24.5	35.7	45.7	45.7	54.8	42.7	42.7	53.1
10	40.8	45.2	55.6	25.0	25.0	35.9	43.8	43.8	52.9	40.8	40.8	51.1
16	36.0	40.4	50.8	25.0	25.0	35.2	39.7	39.7	48.9	36.7	36.7	47.1
20	33.5	38.0	48.6	25.0	25.0	34.9	37.8	37.7	47.0	34.8	34.8	45.2
25	30.9	35.5	46.0	24.3	24.3	35.3	35.8	35.8	45.1	32.8	32.8	43.3
31.25	28.2	32.8	43.4	23.6	23.6	34.8	33.9	33.9	43.2	30.9	30.9	41.3
62.5	18.4	23.2	34.6	21.5	21.5	31.8	27.9	27.8	37.2	24.9	24.9	35.2
100	10.3	18.0	27.3	20.1	20.1	30.1	23.8	23.8	33.2	20.8	20.8	31.1
155		6.3	19.4		18.8	28.4		19.9	29.3		16.9	27.2
200		0.5	13.9		18.0	27.3		11.7	27.1		10.7	25.0
250			8.6		17.3	26.1		9.8	25.1		8.8	23.1
300			3.8		16.8	25.1		8.2	23.7		7.2	21.5
350					16.3	24.0		6.9	22.5		5.9	20.3

**SUSTAINABILITY LEADERSHIP**



UL and the related logo are registered trademarks of UL LLC. Health Product Declaration, HPD and the related logo are trademarks of Health Product Declaration Collaborative. GreenCircle Certified logo is a registered trademark of GreenCircle Certified, LLC. USGBC and the related logo are registered trademarks of U.S. Green Building Council.

# PowerWise® 1G 4PPoE

CMR-LP/CMP-LP

# 4PPoE

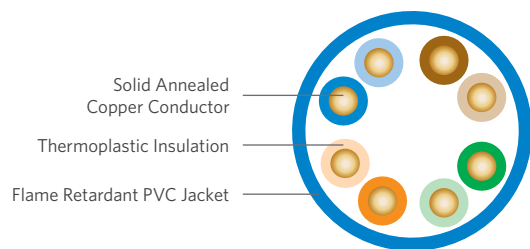

## SPECIFICATIONS

Pair Count	4
Conductor	Solid annealed copper
AWG (mm)	22 (0.64)
Insulation	CMR: Polyolefin CMP: FEP
Insulation Colors	Pair 1: ColorTip Light Blue, Blue Pair 2: ColorTip Light Orange, Orange Pair 3: ColorTip Light Green, Green Pair 4: ColorTip Light Brown, Brown
Jacket	CMR: Flame retardant (FR) PVC CMP: FR, low smoke PVC
Characteristic Impedance Ohms	100 ± 15
Nominal Velocity of Propagation %	CMR: 71 CMP: 74
Performance Compliance	UL 444 CSA C22.2 No. 214-08 UL 1666 NFPA 262 ANSI/TIA-568.2-D ANSI/ICEA S-90-661-2012 Article 800, NEC (NFPA 70) HDBaseT Class A and B
NRTL Programs	UL Verified CAT 5e UL listed CMR-LP (0.5) c(UL) listed CMR UL Listed CMP-LP (0.6) c(UL) Listed CMP HDBaseT Certified
Sustainability	UL Certified EPD HPD USGBC® Member RoHS-compliant/RoHS 2-compliant REACH-compliant

## PRODUCT DESCRIPTION

**FIRST MANUFACTURER IN THE INDUSTRY**  
to offer products that contribute toward LEED!

PowerWise® 1G 4PPoE cables provide the best performance and overall value for 4 Pair Power over Ethernet (4PPoE) applications requiring up to 100W of power and up to 1 Gigabit Ethernet performance. PowerWise 1G 4PPoE cables are specifically designed to mitigate temperature build-up, offer exceptional energy efficiency and ensure performance (up to 1 Gigabit Ethernet) over the lifetime of your system.

PowerWise 1G 4PPoE cable provides the performance benefits of a typical CAT 5E cable including a small diameter. Cable temperature increases are reduced and power efficiency is increased as a result of 22 gauge conductors. Plenum rated conductors are also 100% FEP insulated and ensure cable performance over the life of your system. PowerWise 1G 4PPoE cables are the best solution to connect and power your 4PPoE applications compared to standard CAT 5e and 6 designs.

## APPLICATIONS

- 10BASE-T through 1000BASE-T Ethernet
- Power over Ethernet (PoE) – IEEE 802.3af
- PoE+ – IEEE 802.3at Type 1 and 2
- 4PPoE – IEEE 802.3bt Type 3 and 4 draft D1.2
- ATM and token ring
- HDBaseT Class A and B

## FEATURES

- UL Certified Environmental Product Declaration (EPD)
- Health Product Declaration™ (HPD™)
- Guaranteed 0.3 dB headroom for IL, ACR and PSACR
- Tested 350 MHz
- Tested in most severe temperature conditions in bundle of 100 cables
- CableID® alpha numeric code printed every 2 feet
- QuickCount® marking system in feet and meters
- ColorTip® circuit identification system
- Color coded box labels
- HDBaseT Class A and B certified
- UL LP listed
- Temperature cable rating: 75°C for CMR and 90°C for CMP

## BENEFITS

- Contributes toward 1 LEED credit under the Material and Resources credit (MRc)
- Contributes toward 1 LEED credit under the MRc
- Performance assurance for exceptional overall channel performance
- Assures ample bandwidth Headroom
- AWG 22 insulated wire offers 88% power efficiency and lowest temperature increase inside a bundle, the best of its class
- Allows both ends of a cable run to be easily identifiable without the need to separately label or tone the cable
- Provides remaining length of cable on reel
- Easily identifiable conductor mates even in low-light environments
- Easily identifies jacket colors
- Ideal for any A/V applications up to 100m channel
- Third-party assurance of product safety in high-heat and high-power applications
- Temperature rating of the insulation AND of the jacket provide improved cable lifespan despite high-heat and high-power applications

**PART NUMBERS AND PHYSICAL CHARACTERISTICS**

Listing	Part Number <sup>1</sup>	Nominal Diameter in (mm)	Approx. Weight lbs/kft (kg/km)	Package	Packages per Pallet
CMR	PW52-H46-x5	0.23 (5.8)	28 (42)	1,000 ft BrakeBox®	12
CMR	PW52-H72-x5	0.23 (5.8)	28 (42)	1,000 ft Plywood Reel	16
CMP	PW52-H46-x8	0.23 (5.8)	37 (55)	1,000 ft BrakeBox	12
CMP	PW52-H72-x8	0.23 (5.8)	37 (55)	1,000 ft Plywood Reel	16

**JACKET COLORS**

<sup>1</sup>Replace "x" with: Blue = 2 Gray = 3 White = 4 Green = 5 Yellow = 6 Purple = 7 Red = 9 Black = E

**ELECTRICAL SPECIFICATIONS**

Frequency MHz	Insertion Loss @ 20°C Maximum dB/100 m			NEXT Minimum dB/100 m		ACR Minimum dB/100 m			PSNEXT Minimum dB/100 m	
	TIA-568.2-D	Superior Essex		TIA-568.2-D	Superior Essex	TIA-568.2-D	Superior Essex		TIA-568.2-D	Superior Essex
	Specified	Guaranteed	Typical	Specified	Typical	Calculated	Guaranteed	Typical	Specified	Typical
1	2	1.7	1.7	65.3	76.8	63.3	63.6	81.0	62.3	75.3
4	4.1	3.8	3.7	56.3	67.8	52.2	52.5	70.1	53.3	66.3
8	5.8	5.5	5.4	51.8	63.3	46.0	46.3	63.9	48.8	61.8
10	6.5	6.2	6.0	50.3	61.8	43.8	44.1	61.8	47.3	60.3
16	8.2	7.9	7.7	47.2	58.7	39.0	39.3	57.0	44.3	57.2
20	9.3	9.0	8.6	45.8	57.3	36.5	36.8	54.7	42.8	55.8
25	10.4	10.1	9.6	44.3	55.8	33.9	34.2	52.2	41.3	54.3
31.25	11.7	11.4	10.8	42.9	54.4	31.2	31.5	49.6	39.9	52.9
62.5	17	16.7	15.5	38.4	49.9	21.4	21.7	40.4	35.4	48.4
100	22	21.7	19.8	35.3	46.8	13.3	13.6	33.0	32.3	45.3
155			24.8		43.9			25.1		42.4
200			28.2		42.3			20.1		40.8
250			31.8		40.8			15.0		39.3
300			35		39.6			10.6		38.1
350			38.3		38.6			6.3		37.1

Frequency MHz	PSACR Minimum dB/100 m			Return Loss Minimum dB/100 m		ELFEXT Minimum dB/100 m		PSELFEXT Minimum dB/100 m	
	TIA-568.2-D	Superior Essex		TIA-568.2-D	Superior Essex	TIA-568.2-D	Superior Essex	TIA-568.2-D	Superior Essex
	Calculated	Guaranteed	Typical	Specified	Typical	Specified	Typical	Specified	Typical
1	60.3	60.6	78.3	20.0	33.0	63.8	74.6	60.8	69.3
4	49.2	49.5	67.4	23.0	36.0	51.8	62.6	48.8	57.3
8	43.0	43.3	61.2	24.5	37.5	45.7	56.5	42.7	51.2
10	40.8	41.1	59.1	25.0	38.0	43.8	54.6	40.8	49.3
16	36.1	36.4	54.3	25.0	38.0	39.7	50.5	36.7	45.2
20	33.5	33.8	52.0	25.0	38.0	37.8	48.6	34.8	43.3
25	30.9	31.2	49.5	24.3	37.3	35.8	46.6	32.8	41.3
31.25	28.2	28.5	46.9	23.6	36.6	33.9	44.7	30.9	39.4
62.5	18.4	18.7	37.7	21.5	34.5	27.9	38.7	24.9	33.4
100	10.3	10.6	30.3	20.1	33.1	23.8	34.6	20.8	29.3
155			22.4		31.8		30.8		25.5
200			17.4		31.0		28.6		23.3
250			12.3		30.3		26.6		21.3
300			7.9		29.8		25.1		19.8
350			3.6		29.3		23.7		18.4

**SUSTAINABILITY LEADERSHIP**



UL and the related logo are registered trademarks of UL LLC. Health Product Declaration, HPD and the related logo are trademarks of Health Product Declaration Collaborative. GreenCircle Certified logo is a registered trademark of GreenCircle Certified, LLC. USGBC and the related logo are registered trademarks of U.S. Green Building Council. GreenCircle Certified logo identifies this product as being manufactured in a certified Zero Waste to Landfill facility.

# PowerWise® 1G 4PPoE Indoor/Outdoor

CMR/CMX Sunlight Resistant

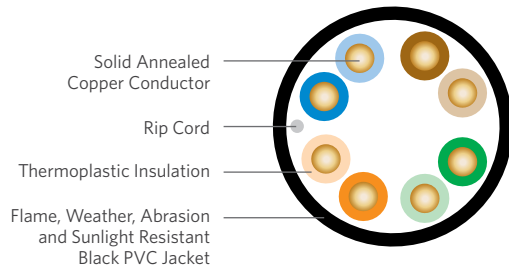

## SPECIFICATIONS

Pair Count	4
Conductor	Solid annealed copper
AWG (mm)	22 (0.64)
Insulation	Polyolefin
Insulation Colors	Pair 1: ColorTip Light Blue, Blue Pair 2: ColorTip Light Orange, Orange Pair 3: ColorTip Light Green, Green Pair 4: ColorTip Light Brown, Brown
Ripcord	Non-wicking polyester yarn
Jacket	Tough, flame retardant, weather, sunlight and abrasion resistant riser PVC
Jacket Color	Black
Characteristic Impedance Ohms	100 ± 15
Nominal Velocity of Propagation %	70
Performance Compliance	UL 444 CSA C22.2 No. 214-08 UL 1581 UL 1666 ANSI/TIA-568.2-D ANSI/ICEA S-90-661-2012 ANSI/TIA/EIA-570-B Article 800, NEC (NFPA 70) RoHS-compliant/RoHS 2-compliant
NRTL Programs	UL, c(UL) Listed CMR UL, c(UL) Listed CMX Outdoor Sunlight Resistant

## ENVIRONMENTAL SPECIFICATIONS AND TESTS

Operation	-40°F to +167°F (-40°C to +75°C)
Installation	-40°F to +140°F (-40°C to +60°C)
ANSI/ICEA S-100-685-2009 <b>Tested down to -67°F (-55°C)</b>	Section 7.1: -4°F (-20°C) cold bend test Section 7.2: +14°F (-10°C) cold impact test Section 7.3: -40°F (-40°C) anvil test

## PRODUCT DESCRIPTION

PowerWise® 1G 4PPoE Indoor/Outdoor Sunlight Resistant AWG 22 cable is specifically designed for extreme sunlight and temperature applications. The level of UV-blocking compounds is the same as in traditional Outside Plant (OSP) cable products with the black color preventing damage from long-term UV sunlight exposure. Applications include Ethernet interconnect cable for Wi-Fi or retrofit cable installations that employ exterior runs having long-term outdoor exposure between two environmentally protected points. CMX Outdoor cables are designed to extend the run between the Network Interface Unit and the point of entry into the interior of a residence or a premise. This cable has been tested and listed as UL® 444 Sunlight Resistant compliant. This designation requires the cable to resist 720 hours of harsh UV and heat, which is more than twice the exposure time of the standard 300 hours required in the CMX Outdoor test. In addition, the CMR listing allows the cable to be used in riser spaces per UL 1666, eliminating the need to transition to fire resistant cables.

PowerWise 1G 4PPoE Indoor/Outdoor AWG 22 cables provide the best performance and overall value for 4-Pair Power over Ethernet (4PPoE) applications requiring up to 100W of power and up to 1 Gigabit Ethernet performance compared to standard CAT 5e and 6 designs. PowerWise 1G 4PPoE cables are specifically designed to mitigate temperature build-up, offer exceptional energy efficiency and ensure performance (up to 1 Gigabit Ethernet) over the lifetime of your system provided the performance benefits of a CAT 5E+ cable including a small diameter. Plenum rated conductors are also 100% FEP insulated and ensure cable performance over the life of your system.

## APPLICATIONS

- 10BASE-T through 1000BASE-T Ethernet
- Power over Ethernet (PoE) - IEEE 802.3af
- PoE+ - IEEE 802.3at Type 1 and 2
- 4PPoE - IEEE 802.3bt Type 3 and 4 draft D1.2
- ATM and token ring
- Wi-Fi - IEEE 802.11a/b/g/n

## FEATURES

- Guaranteed 0.3 dB headroom for IL, ACR and PSACR
- Tested 350 MHz
- Tested in most severe temperature conditions in bundle of 100 cables
- Combines indoor/outdoor applications into one product with the added feature of Sunlight Resistant black color jacket
- Exceeds UL 444
- Moisture-resistant package
- CableID® alpha numeric code printed every 2 feet
- QuickCount® marking system in feet and meters
- ColorTip® Circuit Identification System
- Rip cord applied under jacket
- Combined indoor/outdoor rating
- UL 444/UL 1581 Sunlight Resistant Listed
- BrakeBox® payout control system

## BENEFITS

- Provides cost-effective solution
- 720 hour sunlight resistant specification
- Resists damp conditions that might weaken standard packages
- Allows both ends of a cable run to be easily identifiable without the need to separately label or tone the cable
- Provides remaining length of cable on reel
- Easily identifiable conductor mates even in low-light environments
- Facilitates easy opening
- Reduces inventory by eliminating multiple cable types
- Increased life in direct, long term sunlight
- Adjustable tension control on reel prevents over spin and entangling of cable



## CAUTIONARY INFORMATION

- Do not use as a substitute for Outside Plant (OSP) cables.
- Do not use in conduit or direct burial which can flood.  
These cables are not designed for extended exposure to water.

**PART NUMBERS AND PHYSICAL CHARACTERISTICS**

Part Number	Nominal Diameter in (mm)	Approx. Weight lbs/kft (kg/km)	Package	Packages per Pallet
PW52-H46-E1	0.27 (6.9)	34 (15.4)	1,000 ft BrakeBox®	12

**ELECTRICAL SPECIFICATIONS**

Frequency MHz	Insertion Loss @ 20°C Maximum dB/100 m		NEXT Minimum dB/100 m		ACR Minimum dB/100 m		PSNEXT Minimum dB/100 m	
	TIA-568.2-D	Superior Essex	TIA-568.2-D	Superior Essex	TIA-568.2-D	Superior Essex	TIA-568.2-D	Superior Essex
	Specified	Guaranteed Typical	Specified	Typical	Calculated	Guaranteed Typical	Specified	Typical
1	2	1.7 1.7	65.3	76.8	63.3	63.6 81.0	62.3	75.3
4	4.1	3.8 3.7	56.3	67.8	52.2	52.5 70.1	53.3	66.3
8	5.8	5.5 5.4	51.8	63.3	46.0	46.3 63.9	48.8	61.8
10	6.5	6.2 6.0	50.3	61.8	43.8	44.1 61.8	47.3	60.3
16	8.2	7.9 7.7	47.2	58.7	39.0	39.3 57.0	44.3	57.2
20	9.3	9.0 8.6	45.8	57.3	36.5	36.8 54.7	42.8	55.8
25	10.4	10.1 9.6	44.3	55.8	33.9	34.2 52.2	41.3	54.3
31.25	11.7	11.4 10.8	42.9	54.4	31.2	31.5 49.6	39.9	52.9
62.5	17	16.7 15.5	38.4	49.9	21.4	21.7 40.4	35.4	48.4
100	22	21.7 19.8	35.3	46.8	13.3	13.6 33.0	32.3	45.3
155		24.8		43.9		25.1		42.4
200		28.2		42.3		20.1		40.8
250		31.8		40.8		15.0		39.3
300		35		39.6		10.6		38.1
350		38.3		38.6		6.3		37.1

Frequency MHz	PSACR Minimum dB/100 m		Return Loss Minimum dB/100 m		ELFEXT Minimum dB/100 m		PSELFEXT Minimum dB/100 m	
	TIA-568.2-D	Superior Essex	TIA-568.2-D	Superior Essex	TIA-568.2-D	Superior Essex	TIA-568.2-D	Superior Essex
	Calculated	Guaranteed Typical	Specified	Typical	Specified	Typical	Specified	Typical
1	60.3	60.6 78.3	20.0	33.0	63.8	74.6	60.8	69.3
4	49.2	49.5 67.4	23.0	36.0	51.8	62.6	48.8	57.3
8	43.0	43.3 61.2	24.5	37.5	45.7	56.5	42.7	51.2
10	40.8	41.1 59.1	25.0	38.0	43.8	54.6	40.8	49.3
16	36.1	36.4 54.3	25.0	38.0	39.7	50.5	36.7	45.2
20	33.5	33.8 52.0	25.0	38.0	37.8	48.6	34.8	43.3
25	30.9	31.2 49.5	24.3	37.3	35.8	46.6	32.8	41.3
31.25	28.2	28.5 46.9	23.6	36.6	33.9	44.7	30.9	39.4
62.5	18.4	18.7 37.7	21.5	34.5	27.9	38.7	24.9	33.4
100	10.3	10.6 30.3	20.1	33.1	23.8	34.6	20.8	29.3
155		22.4		31.8		30.8		25.5
200		17.4		31.0		28.6		23.3
250		12.3		30.3		26.6		21.3
300		7.9		29.8		25.1		19.8
350		3.6		29.3		23.7		18.4

# PowerWise® 1G 4PPoE Indoor/Outdoor

CMR/CMX

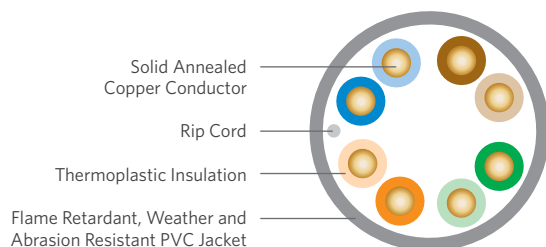

## SPECIFICATIONS

Pair Count	4
Conductor	Solid annealed copper
AWG (mm)	22 (0.64)
Insulation	Polyolefin
Insulation Colors	Pair 1: ColorTip Light Blue, Blue Pair 2: ColorTip Light Orange, Orange Pair 3: ColorTip Light Green, Green Pair 4: ColorTip Light Brown, Brown
Ripcord	Non-wicking polyester yarn
Jacket	Tough, flame retardant, weather and abrasion resistant PVC
Characteristic Impedance Ohms	100 ± 15
Nominal Velocity of Propagation %	70
Performance Compliance	UL 444 CSA C22.2 No. 214-08 UL 1581 UL 1666 ANSI/TIA-568.2-D ANSI/ICEA S-90-661-2012 ANSI/TIA/EIA-570-B Article 800, NEC (NFPA 70) RoHS-compliant/RoHS 2-compliant
NRTL Programs	UL, c(UL) Listed CMR UL, c(UL) Listed CMX Outdoor

## ENVIRONMENTAL SPECIFICATIONS AND TESTS

Operation	-40°F to +167°F (-40°C to +75°C)
Installation	-40°F to +140°F (-40°C to +60°C)
ANSI/ICEA S-100-685-2009 Tested down to -67°F (-55°C)	Section 7.1: -4°F (-20°C) cold bend test Section 7.2: +14°F (-10°C) cold impact test Section 7.3: -40°F (-40°C) anvil test

## PRODUCT DESCRIPTION

PowerWise® 1G 4PPoE Indoor/Outdoor cable is specifically designed for outdoor applications. UV-blocking compounds aid in protecting the cable from light. Applications include Ethernet interconnect cable for Wi-Fi or retrofit cable installations that employ exterior runs having long-term outdoor exposure between two environmentally protected points. CMX Outdoor cables are designed to extend the run between the Network Interface Unit and the point of entry into the interior of a residence or a premise. This cable has been tested and listed as UL® 444 Outdoor compliant. This designation requires the cable to resist 300 hours of UV and heat. In addition, the CMR listing allows the cable to be used in riser spaces per UL 1666, eliminating the need to transition to fire resistant cables.

PowerWise 1G 4PPoE Indoor/Outdoor AWG 22 cables provide the best performance and overall value for 4-Pair Power over Ethernet (4PPoE) applications requiring up to 100W of power and up to 1 Gigabit Ethernet performance compared to standard CAT 5e and 6 designs. PowerWise 1G 4PPoE cables are specifically designed to mitigate temperature build-up, offer exceptional energy efficiency and ensure performance (up to 1 Gigabit Ethernet) over the lifetime of your system provided the performance benefits of a CAT 5E+ cable including a small diameter. Plenum rated conductors are also 100% FEP insulated and ensure cable performance over the life of your system.

## APPLICATIONS

- 10BASE-T through 1000BASE-T Ethernet
- Power over Ethernet (PoE) – IEEE 802.3af
- PoE+ – IEEE 802.3at Type 1 and 2
- 4PPoE – IEEE 802.3bt Type 3 and 4 draft D1.2
- ATM and token ring
- Wi-Fi – IEEE 802.11a/b/g/n

## FEATURES

- Guaranteed 0.3 dB headroom for IL, ACR and PSACR
- Tested 350 MHz
- Tested in most severe temperature conditions in bundle of 100 cables
- Tough, weather resistant PVC jacket
- Combined indoor/outdoor rating
- Moisture-resistant package
- CableID® alpha numeric code printed every 2 feet
- QuickCount® marking system in feet and meters
- ColorTip® Circuit Identification System
- BrakeBox® payout control system

## BENEFITS

- Increases life of cable by providing low temperature handling and UV resistance; cable jacket resists cracking over time
- Reduces inventory by eliminating multiple cable types
- Resists damp conditions that might weaken standard packages
- Allows both ends of a cable run to be easily identifiable without the need to separately label or tone the cable
- Provides remaining length of cable on reel
- Easily identifiable conductor mates even in low light environments
- Adjustable tension control on reel prevents over spin and entangling of cable



## CAUTIONARY INFORMATION

- Do not use as a substitute for Outside Plant (OSP) cables.
- Do not use in conduit or direct burial which can flood. These cables are not designed for extended exposure to water.

**PART NUMBERS AND PHYSICAL CHARACTERISTICS**

Part Number <sup>1</sup>	Nominal Diameter in (mm)	Approx. Weight lbs/kft (kg/km)	Package	Packages per Pallet
PW52-H46-x1	0.27 (6.9)	34 (15.4)	1,000 ft BrakeBox®	12

**JACKET COLORS**

<sup>1</sup> Replace "x" with:	Blue = 2	Gray = 3	Purple = 7
--------------------------------	----------	----------	------------

UL is a registered trademark of UL LLC.

**ELECTRICAL SPECIFICATIONS**

Frequency MHz	Insertion Loss @ 20°C Maximum dB/100 m			NEXT Minimum dB/100 m		ACR Minimum dB/100 m			PSNEXT Minimum dB/100 m	
	TIA-568.2-D	Superior Essex		TIA-568.2-D	Superior Essex	TIA-568.2-D	Superior Essex		TIA-568.2-D	Superior Essex
	Specified	Guaranteed	Typical	Specified	Typical	Calculated	Guaranteed	Typical	Specified	Typical
1	2	1.7	1.7	65.3	76.8	63.3	63.6	81.0	62.3	75.3
4	4.1	3.8	3.7	56.3	67.8	52.2	52.5	70.1	53.3	66.3
8	5.8	5.5	5.4	51.8	63.3	46.0	46.3	63.9	48.8	61.8
10	6.5	6.2	6.0	50.3	61.8	43.8	44.1	61.8	47.3	60.3
16	8.2	7.9	7.7	47.2	58.7	39.0	39.3	57.0	44.3	57.2
20	9.3	9.0	8.6	45.8	57.3	36.5	36.8	54.7	42.8	55.8
25	10.4	10.1	9.6	44.3	55.8	33.9	34.2	52.2	41.3	54.3
31.25	11.7	11.4	10.8	42.9	54.4	31.2	31.5	49.6	39.9	52.9
62.5	17	16.7	15.5	38.4	49.9	21.4	21.7	40.4	35.4	48.4
100	22	21.7	19.8	35.3	46.8	13.3	13.6	33.0	32.3	45.3
155			24.8		43.9			25.1		42.4
200			28.2		42.3			20.1		40.8
250			31.8		40.8			15.0		39.3
300			35		39.6			10.6		38.1
350			38.3		38.6			6.3		37.1

Frequency MHz	PSACR Minimum dB/100 m			Return Loss Minimum dB/100 m		ELFEXT Minimum dB/100 m		PSELFEXT Minimum dB/100 m	
	TIA-568.2-D	Superior Essex		TIA-568.2-D	Superior Essex	TIA-568.2-D	Superior Essex	TIA-568.2-D	Superior Essex
	Calculated	Guaranteed	Typical	Specified	Typical	Specified	Typical	Specified	Typical
1	60.3	60.6	78.3	20.0	33.0	63.8	74.6	60.8	69.3
4	49.2	49.5	67.4	23.0	36.0	51.8	62.6	48.8	57.3
8	43.0	43.3	61.2	24.5	37.5	45.7	56.5	42.7	51.2
10	40.8	41.1	59.1	25.0	38.0	43.8	54.6	40.8	49.3
16	36.1	36.4	54.3	25.0	38.0	39.7	50.5	36.7	45.2
20	33.5	33.8	52.0	25.0	38.0	37.8	48.6	34.8	43.3
25	30.9	31.2	49.5	24.3	37.3	35.8	46.6	32.8	41.3
31.25	28.2	28.5	46.9	23.6	36.6	33.9	44.7	30.9	39.4
62.5	18.4	18.7	37.7	21.5	34.5	27.9	38.7	24.9	33.4
100	10.3	10.6	30.3	20.1	33.1	23.8	34.6	20.8	29.3
155			22.4		31.8		30.8		25.5
200			17.4		31.0		28.6		23.3
250			12.3		30.3		26.6		21.3
300			7.9		29.8		25.1		19.8
350			3.6		29.3		23.7		18.4

# Marathon LAN<sup>®</sup> Category 5e

CMR/CMP

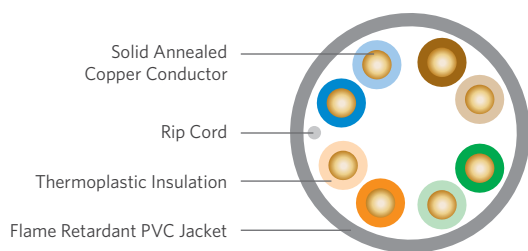

## SPECIFICATIONS

Pair Count	4
Conductor	Solid annealed copper
AWG (mm)	24 (0.51)
Insulation	Thermoplastic
Insulation Colors	Pair 1: ColorTip Light Blue, Blue Pair 2: ColorTip Light Orange, Orange Pair 3: ColorTip Light Green, Green Pair 4: ColorTip Light Brown, Brown
Jacket	CMR: Flame retardant (FR) PVC CMP: FR, low smoke PVC
Characteristic Impedance Ohms	100 ± 15
Nominal Velocity of Propagation %	CMR: 71 CMP: 74
Performance Compliance	UL 444 CSA C22.2 No. 214-08 UL 1666 NFPA 262 ANSI/TIA-568.2-D ANSI/ICEA S-90-661-2012 Article 800, NEC (NFPA 70)
NRTL Programs	UL or ETL Verified CAT 5e UL, c(UL) Listed CMR UL, c(UL) Listed CMP
Sustainability	UL Certified EPD HPD Multi-Attribute Certification USGBC <sup>®</sup> Member RoHS-compliant/RoHS 2-compliant REACH-compliant

## PRODUCT DESCRIPTION



**FIRST MANUFACTURER IN THE INDUSTRY**  
to offer products that contribute toward LEED!

Marathon LAN<sup>®</sup> Category 5e cable offers an exceptional value for jobs that require standards compliance at a cost-effective price. While Marathon LAN cable meets all of the ANSI/TIA-568.2-D specifications, it also offers other features that make it easier to use, save on installation time and expense and ensure product quality during the installation. From the QuickCount<sup>®</sup> feature, which marks the exact cable remaining in the box, to the WideMouth payout design, which reduces tension on the wire as it is pulled during installation, Marathon LAN cable provides more overall value than any other CAT 5e product available today.

## APPLICATIONS

- 10BASE-T through 100BASE-T Ethernet
- Power over Ethernet (PoE) – IEEE 802.3af
- PoE+ – IEEE 802.3at Type 1 and 2
- ATM and token ring

## FEATURES

- UL Certified Environmental Product Declaration (EPD)
- Health Product Declaration™ (HPD™)
- Multi-Attribute Certification by GreenCircle Certified, LLC
- Meets ANSI/TIA-568.2-D specification
- Tested to 350 MHz
- “WideMouth” POP™ box design
- CableID<sup>®</sup> alpha numeric code printed every 2 feet
- QuickCount marking system in feet and meters
- ColorTip<sup>®</sup> circuit identification system
- Color coded box labels

## BENEFITS

- Contributes toward 1 LEED point under the Material and Resources credit (MRC)
- Contributes toward 1 LEED point under the MRC
- Offers an overview of the sustainability of a product, its packaging and manufacturing
- Provides cost-effective solution
- Assures ample bandwidth headroom
- Reduces tension on wire to ensure proper electrical performance after installation
- Allows both ends of a cable run to be easily identifiable without the need to separately label or tone the cable
- Provides remaining length of cable on reel
- Easily identifiable conductor mates even in low-light environments
- Easily identifies jacket colors

## PART NUMBERS AND PHYSICAL CHARACTERISTICS

Listing	Part Number <sup>1</sup>	Nominal Diameter in (mm)	Approx. Weight lbs/kft (kg/km)	Package
CMR	51-xxx-y5	0.18 (4.6)	17 (25)	use key
CMP	51-xxx-y8	0.19 (4.8)	19 (28)	use key

## PACKAGING

	150 ft Coil	200 ft Coil	250 ft Coil	300 ft Coil	1,000 ft POP Box	1,000 ft Reel-in-a-box	1,000 ft Plywood Reel	2,500 ft Plywood Reel
<sup>1</sup> Replace “xxx” with:	225	229	230	231	CMR: 240 CMP: 241	243	220	273
Packages per Pallet	240	120	144	120	45	45	36	16

## JACKET COLORS

<sup>1</sup>Replace “y” with: Blue = 2 Gray = 3 White = 4 Green = 5 Yellow = 6 Purple = 7 Red = 9 Pink = C Orange = D Black = E



## ELECTRICAL SPECIFICATIONS

Frequency MHz	Insertion Loss @ 20°C Maximum dB/100 m		NEXT Minimum dB/100 m		ACR Minimum dB/100 m		PSNEXT Minimum dB/100 m	
	TIA-568.2-D	Superior Essex	TIA-568.2-D	Superior Essex	TIA-568.2-D	Superior Essex	TIA-568.2-D	Superior Essex
	Specified	Typical	Specified	Typical	Calculated	Typical	Specified	Typical
1	2.0	1.8	65.3	76.8	63.3	81.0	62.3	75.3
4	4.1	3.7	56.3	67.8	52.2	70.1	53.3	66.3
8	5.8	5.4	51.8	63.3	46.0	63.9	48.8	61.8
10	6.5	6.0	50.3	61.8	43.8	61.8	47.3	60.3
16	8.2	7.7	47.2	58.7	39.0	57.0	44.3	57.2
20	9.3	8.6	45.8	57.3	36.5	54.7	42.8	55.8
25	10.4	9.6	44.3	55.8	33.9	52.2	41.3	54.3
31.25	11.7	10.8	42.9	54.4	31.2	49.6	39.9	52.9
62.5	17.0	15.5	38.4	49.9	21.4	40.4	35.4	48.4
100	22.0	19.8	35.3	46.8	13.3	33.0	32.3	45.3
155		24.8		43.9		25.1		42.4
200		28.2		42.3		20.1		40.8
250		31.8		40.8		15.0		39.3
300		35.0		39.6		10.6		38.1
350		38.3		38.6		6.3		37.1

Frequency MHz	PSACR Minimum dB/100 m		Return Loss Minimum dB/100 m		ELFEXT Minimum dB/100 m		PSELFEXT Minimum dB/100 m	
	TIA-568.2-D	Superior Essex	TIA-568.2-D	Superior Essex	TIA-568.2-D	Superior Essex	TIA-568.2-D	Superior Essex
	Calculated	Typical	Specified	Typical	Specified	Typical	Specified	Typical
1	60.3	78.3	20.0	33.0	63.8	74.6	60.8	69.3
4	49.2	67.4	23.0	36.0	51.8	62.6	48.8	57.3
8	43.0	61.2	24.5	37.5	45.7	56.5	42.7	51.2
10	40.8	59.1	25.0	38.0	43.8	54.6	40.8	49.3
16	36.1	54.3	25.0	38.0	39.7	50.5	36.7	45.2
20	33.5	52.0	25.0	38.0	37.8	48.6	34.8	43.3
25	30.9	49.5	24.3	37.3	35.8	46.6	32.8	41.3
31.25	28.2	46.9	23.6	36.6	33.9	44.7	30.9	39.4
62.5	18.4	37.7	21.5	34.5	27.9	38.7	24.9	33.4
100	10.3	30.3	20.1	33.1	23.8	34.6	20.8	29.3
155		22.4		31.8		30.8		25.5
200		17.4		31.0		28.6		23.3
250		12.3		30.3		26.6		21.3
300		7.9		29.8		25.1		19.8
350		3.6		29.3		23.7		18.4

## SUSTAINABILITY LEADERSHIP



UL and the related logo are registered trademarks of UL LLC. Health Product Declaration, HPD and the related logo are trademarks of Health Product Declaration Collaborative. GreenCircle Certified logo is a registered trademark of GreenCircle Certified, LLC. USGBC and the related logo are registered trademarks of U.S. Green Building Council.

# Marathon LAN<sup>®</sup> Category 5e with FEP Jacket

CMP

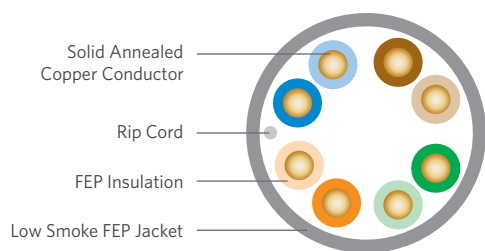

## SPECIFICATIONS

Pair Count	4
Conductor	Solid annealed copper
AWG (mm)	24 (0.51)
Insulation	FEP
Insulation Colors	Pair 1: ColorTip Light Blue, Blue Pair 2: ColorTip Light Orange, Orange Pair 3: ColorTip Light Green, Green Pair 4: ColorTip Light Brown, Brown
Jacket	FR, low smoke FEP
Characteristic Impedance Ohms	100 ± 15
Nominal Velocity of Propagation %	74
Performance Compliance	UL 444 CSA C22.2 No. 214-08 NFPA 262 ANSI/TIA-568.2-D Article 800, NEC (NFPA 70)
NRTL Programs	UL Verified CAT 5e UL, c(UL) Listed CMP

## ENVIRONMENTAL SPECIFICATIONS

Operation	-40°C to +200°C
Storage/Shipping	-40°C to +200°C
Installation	-40°C to +200°C

## PART NUMBERS AND PHYSICAL CHARACTERISTICS

Listing	Part Number <sup>1</sup>	Nominal Diameter in (mm)	Approx. Weight lbs/kft (kg/km)	Package	Packages per Pallet
CMP	51-243-yP	0.17 (4.3)	18 (26.8)	1,000 ft Reel-in-a-box	45

## JACKET COLORS

<sup>1</sup>Replace "y" with: Blue = 2 Gray = 3 White = 4 Green = 5 Yellow = 6 Purple = 7 Red = 9 Pink = C Orange = D Black = E

UL is a registered trademark of UL LLC.

## PRODUCT DESCRIPTION

Marathon LAN<sup>®</sup> Category 5e cable offers an exceptional value for jobs that require standards compliance at a cost-effective price. While Marathon LAN cable meets all of the ANSI/TIA-568.2-D specifications, it also offers other features that make it easier to use, save on installation time and expense and ensure product quality during the installation. From the QuickCount<sup>®</sup> feature, which marks the exact cable remaining in the box, to the WideMouth payout design, which reduces tension on the wire as it is pulled during installation, Marathon LAN cable provides more overall value than any other CAT 5e product available today.

## APPLICATIONS

- 10BASE-T through 1000BASE-T Ethernet
- Power over Ethernet (PoE) - IEEE 802.3af
- PoE+ - IEEE 802.3at Type 1 and 2
- ATM and token ring

## FEATURES

- FEP Jacket
- All fluoropolymer construction
- RoHS-compliant
- Meets ANSI/TIA-568.2-D specification
- Tested to 350 MHz
- "WideMouth" POP<sup>™</sup> box design
- CableID<sup>®</sup> alpha numeric code printed every 2 feet
- QuickCount marking system in feet and meters
- ColorTip<sup>®</sup> circuit identification system
- Color coded box labels

## BENEFITS

- Lower smoke emission in plenum test than PVC
- Resistant to chemical, moisture, thermal exposure
- No heavy metals; no toxic components
- Provides cost-effective solution
- Assures ample bandwidth headroom
- Reduces tension on wire to ensure proper electrical performance after installation
- Allows both ends of a cable run to be easily identifiable without the need to separately label or tone the cable
- Provides remaining length of cable on reel
- Easily identifiable conductor mates even in low-light environments
- Easily identifies jacket colors

**ELECTRICAL SPECIFICATIONS**

Frequency MHz	Insertion Loss @ 20°C Maximum dB/100 m		NEXT Minimum dB/100 m		ACR Minimum dB/100 m		PSNEXT Minimum dB/100 m	
	TIA-568.2-D	Superior Essex	TIA-568.2-D	Superior Essex	TIA-568.2-D	Superior Essex	TIA-568.2-D	Superior Essex
	Specified	Typical	Specified	Typical	Calculated	Typical	Specified	Typical
1	2.0	1.8	65.3	76.8	63.3	81.0	62.3	75.3
4	4.1	3.7	56.3	67.8	52.2	70.1	53.3	66.3
8	5.8	5.4	51.8	63.3	46.0	63.9	48.8	61.8
10	6.5	6.0	50.3	61.8	43.8	61.8	47.3	60.3
16	8.2	7.7	47.2	58.7	39.0	57.0	44.3	57.2
20	9.3	8.6	45.8	57.3	36.5	54.7	42.8	55.8
25	10.4	9.6	44.3	55.8	33.9	52.2	41.3	54.3
31.25	11.7	10.8	42.9	54.4	31.2	49.6	39.9	52.9
62.5	17.0	15.5	38.4	49.9	21.4	40.4	35.4	48.4
100	22.0	19.8	35.3	46.8	13.3	33.0	32.3	45.3
155		24.8		43.9		25.1		42.4
200		28.2		42.3		20.1		40.8
250		31.8		40.8		15.0		39.3
300		35.0		39.6		10.6		38.1
350		38.3		38.6		6.3		37.1

Frequency MHz	PSACR Minimum dB/100 m		Return Loss Minimum dB/100 m		ELFEXT Minimum dB/100 m		PSELFEXT Minimum dB/100 m	
	TIA-568.2-D	Superior Essex	TIA-568.2-D	Superior Essex	TIA-568.2-D	Superior Essex	TIA-568.2-D	Superior Essex
	Calculated	Typical	Specified	Typical	Specified	Typical	Specified	Typical
1	60.3	78.3	20.0	33.0	63.8	74.6	60.8	69.3
4	49.2	67.4	23.0	36.0	51.8	62.6	48.8	57.3
8	43.0	61.2	24.5	37.5	45.7	56.5	42.7	51.2
10	40.8	59.1	25.0	38.0	43.8	54.6	40.8	49.3
16	36.1	54.3	25.0	38.0	39.7	50.5	36.7	45.2
20	33.5	52.0	25.0	38.0	37.8	48.6	34.8	43.3
25	30.9	49.5	24.3	37.3	35.8	46.6	32.8	41.3
31.25	28.2	46.9	23.6	36.6	33.9	44.7	30.9	39.4
62.5	18.4	37.7	21.5	34.5	27.9	38.7	24.9	33.4
100	10.3	30.3	20.1	33.1	23.8	34.6	20.8	29.3
155		22.4		31.8		30.8		25.5
200		17.4		31.0		28.6		23.3
250		12.3		30.3		26.6		21.3
300		7.9		29.8		25.1		19.8
350		3.6		29.3		23.7		18.4



800.551.8948

[SuperiorEssexCommunications.com](http://SuperiorEssexCommunications.com)

All information, content, data, specifications, packaging and part numbers detailed herein are subject to change. For the most up-to-date information, please visit [SuperiorEssexCommunications.com](http://SuperiorEssexCommunications.com). Purchase of this product is subject exclusively to the then current **Superior Essex International LP Terms and Conditions of Sale for Communications Cable, Wire and Connectivity Products**, which can be found on our website, [SuperiorEssexCommunications.com](http://SuperiorEssexCommunications.com), or provided to you upon request.

## PRODUCT DESCRIPTION

Superior Essex Category 5e CM cable is designed for residential LAN applications. CAT 5e compliance ensures this cable will support 1000BASE-T Gigabit Ethernet. This cable easily surpasses the Grade 2 requirements specified in the ANSI/TIA/EIA-570-B Residential Telecommunications standard.

## APPLICATIONS

- 10BASE-T through 1000BASE-T Ethernet
- Power over Ethernet (PoE) - IEEE 802.3af
- PoE+ - IEEE 802.3at Type 1 and 2
- ATM and token ring

## FEATURES

- Meets ANSI/TIA-568.2-D specification
- CableID® alpha numeric code printed every 2 feet
- QuickCount® marking system in feet and meters
- ColorTip® Circuit Identification System

## BENEFITS

- CAT 5e compliance
- Allows both ends of a cable run to be easily identifiable without the need to separately label or tone the cable
- Provides remaining length of cable on reel
- Easily identifiable conductor mates even in low light environments

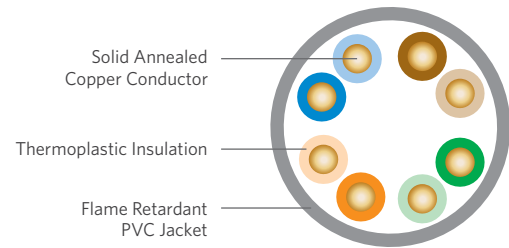

## SPECIFICATIONS

Pair Count	4
Conductor	Solid annealed copper
AWG (mm)	24 (0.51)
Insulation	Polyolefin
Insulation Colors	Pair 1: ColorTip Light Blue, Blue Pair 2: ColorTip Light Orange, Orange Pair 3: ColorTip Light Green, Green Pair 4: ColorTip Light Brown, Brown
Jacket	Flame retardant PVC
Characteristic Impedance Ohms	100 ± 15
Nominal Velocity of Propagation %	72
Performance Compliance	UL® 444 CSA C22.2 No. 214-08 UL 1685 ANSI/TIA-568.2-D ANSI/ICEA S-90-661-2012 ANSI/TIA/EIA-570-B Article 800, NEC (NFPA 70) RoHS-compliant/RoHS 2-compliant
NRTL Programs	UL Verified CAT 5e UL, c(UL) Listed CM

## PART NUMBERS AND PHYSICAL CHARACTERISTICS

Listing	Part Number <sup>1</sup>	Nominal Diameter in (mm)	Approx. Weight lbs/kft (kg/km)	Package	Packages per Pallet
CM	51-240-xG	0.18 (4.6)	17 (25)	1,000' POP™ box	45

## JACKET COLORS

<sup>1</sup> Replace "x" with:	Blue = 2	Gray = 3	White = 4	Green = 5	Red = 9
--------------------------------	----------	----------	-----------	-----------	---------

UL is a registered trademark of UL LLC.

# Category 5e

CMR/CMX Outdoor Sunlight Resistant

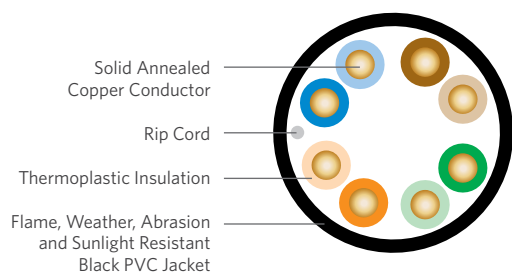

Solid Annealed  
Copper Conductor

Rip Cord

Thermoplastic Insulation

Flame, Weather, Abrasion  
and Sunlight Resistant  
Black PVC Jacket

## SPECIFICATIONS

Pair Count	4
Conductor	Solid annealed copper
AWG (mm)	24 (0.51)
Insulation	Polyolefin
Insulation Colors	Pair 1: ColorTip Light Blue, Blue Pair 2: ColorTip Light Orange, Orange Pair 3: ColorTip Light Green, Green Pair 4: ColorTip Light Brown, Brown
Ripcord	Non-wicking polyester yarn
Jacket	Tough, flame retardant, weather, sunlight and abrasion resistant riser PVC
Jacket Color	Black
Characteristic Impedance Ohms	100 ± 15
Nominal Velocity of Propagation %	70
Performance Compliance	UL 444 CSA C22.2 No. 214-08 UL 1581 UL 1666 ANSI/TIA-568.2-D ANSI/ICEA S-90-661-2012 ANSI/TIA/EIA-570-B Article 800, NEC (NFPA 70) RoHS-compliant/RoHS 2-compliant
NRTL Programs	UL, c(UL) Listed CMR UL, c(UL) Listed CMX Outdoor Sunlight Resistant

## ENVIRONMENTAL SPECIFICATIONS AND TESTS

Operation	-40°F to +167°F (-40°C to +75°C)
Installation	-40°F to +140°F (-40°C to +60°C)
ANSI/ICEA S-100-685-2009 <b>Tested down to -67°F (-55°C)</b>	Section 7.1: -4°F (-20°C) cold bend test Section 7.2: +14°F (-10°C) cold impact test Section 7.3: -40°F (-40°C) anvil test

## PART NUMBERS AND PHYSICAL CHARACTERISTICS

Part Number	Nominal Diameter in (mm)	Approx. Weight lbs/kft (kg/km)	Package	Packages per Pallet
51-240-E1	0.21 (5.3)	21 (31)	1,000' POP™ box	36

## PRODUCT DESCRIPTION

The Superior Essex Category 5e CMR/CMX Outdoor Sunlight Resistant cable is specifically designed for extreme sunlight and temperature applications. The level of UV-blocking compounds is the same as in traditional Outside Plant (OSP) cable products with the black color preventing damage from long-term UV sunlight exposure. Applications include Ethernet interconnect cable for Wi-Fi or retrofit cable installations that employ exterior runs having long-term outdoor exposure between two environmentally protected points. CMX Outdoor cables are designed to extend the run between the Network Interface Unit and the point of entry into the interior of a residence or a premise.

Superior Essex CAT 5e CMR/CMX Outdoor Sunlight Resistant black premises cable has been tested and listed as UL® 444 Sunlight Resistant compliant. This designation requires the cable to resist 720 hours of harsh UV and heat, which is more than twice the exposure time of the standard 300 hours required in the CMX Outdoor test. In addition, the CMR listing allows the cable to be used in riser spaces per UL 1666, eliminating the need to transition to fire resistant cables.

## APPLICATIONS

- 10BASE-T through 1000BASE-T Ethernet
- Power over Ethernet (PoE) - IEEE 802.3af
- PoE+ - IEEE 802.3at Type 1 and 2
- Wi-Fi - IEEE 802.11a/b/g/n

## FEATURES

- Combines indoor/outdoor applications into one product with the added feature of Sunlight Resistant black color jacket
- Exceeds UL 444
- Meets ANSI/TIA-568.2-D specification
- Moisture-resistant package
- CableID® alpha numeric code printed every 2 feet
- QuickCount® marking system in feet and meters
- ColorTip® Circuit Identification System
- Rip cord applied under jacket
- RoHS-compliant
- Combined indoor/outdoor rating
- UL 444/UL 1581 Sunlight Resistant Listed

## BENEFITS

- Provides cost-effective solution
- 720 hour sunlight resistant specification
- CAT 5e performance
- Resists damp conditions that might weaken standard packages
- Allows both ends of a cable run to be easily identifiable without the need to separately label or tone the cable
- Provides remaining length of cable on reel
- Easily identifiable conductor mates even in low-light environments
- Facilitates easy opening
- No heavy metals; and no toxic components
- Reduces inventory by eliminating multiple cable types
- Increased life in direct, long term sunlight



## CAUTIONARY INFORMATION

- Do not use as a substitute for Outside Plant (OSP) cables.
- Do not use in conduit or direct burial which can flood. These cables are not designed for extended exposure to water.

**ELECTRICAL SPECIFICATIONS**

Frequency MHz	Insertion Loss @ 20°C Maximum dB/100 m		NEXT Minimum dB/100 m		ACR Minimum dB/100 m		PSNEXT Minimum dB/100 m	
	TIA-568.2-D	Superior Essex	TIA-568.2-D	Superior Essex	TIA-568.2-D	Superior Essex	TIA-568.2-D	Superior Essex
	Specified	Typical	Specified	Typical	Calculated	Typical	Specified	Typical
1	2.0	1.8	65.3	76.8	63.3	81.0	62.3	75.3
4	4.1	3.7	56.3	67.8	52.2	70.1	53.3	66.3
8	5.8	5.4	51.8	63.3	46.0	63.9	48.8	61.8
10	6.5	6.0	50.3	61.8	43.8	61.8	47.3	60.3
16	8.2	7.7	47.2	58.7	39.0	57.0	44.3	57.2
20	9.3	8.6	45.8	57.3	36.5	54.7	42.8	55.8
25	10.4	9.6	44.3	55.8	33.9	52.2	41.3	54.3
31.25	11.7	10.8	42.9	54.4	31.2	49.6	39.9	52.9
62.5	17.0	15.5	38.4	49.9	21.4	40.4	35.4	48.4
100	22.0	19.8	35.3	46.8	13.3	33.0	32.3	45.3
155		24.8		43.9		25.1		42.4
200		28.2		42.3		20.1		40.8
250		31.8		40.8		15.0		39.3
300		35.0		39.6		10.6		38.1
350		38.3		38.6		6.3		37.1

Frequency MHz	PSACR Minimum dB/100 m		Return Loss Minimum dB/100 m		ELFEXT Minimum dB/100 m		PSELFEXT Minimum dB/100 m	
	TIA-568.2-D	Superior Essex	TIA-568.2-D	Superior Essex	TIA-568.2-D	Superior Essex	TIA-568.2-D	Superior Essex
	Calculated	Typical	Specified	Typical	Specified	Typical	Specified	Typical
1	60.3	78.3	20.0	33.0	63.8	74.6	60.8	69.3
4	49.2	67.4	23.0	36.0	51.8	62.6	48.8	57.3
8	43.0	61.2	24.5	37.5	45.7	56.5	42.7	51.2
10	40.8	59.1	25.0	38.0	43.8	54.6	40.8	49.3
16	36.1	54.3	25.0	38.0	39.7	50.5	36.7	45.2
20	33.5	52.0	25.0	38.0	37.8	48.6	34.8	43.3
25	30.9	49.5	24.3	37.3	35.8	46.6	32.8	41.3
31.25	28.2	46.9	23.6	36.6	33.9	44.7	30.9	39.4
62.5	18.4	37.7	21.5	34.5	27.9	38.7	24.9	33.4
100	10.3	30.3	20.1	33.1	23.8	34.6	20.8	29.3
155		22.4		31.8		30.8		25.5
200		17.4		31.0		28.6		23.3
250		12.3		30.3		26.6		21.3
300		7.9		29.8		25.1		19.8
350		3.6		29.3		23.7		18.4

UL is a registered trademark of UL LLC.

# Category 5e

CMR/CMX Outdoor

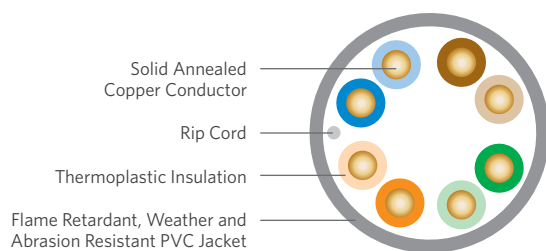

## SPECIFICATIONS

Pair Count	4
Conductor	Solid annealed copper
AWG (mm)	24 (0.51)
Insulation	Polyolefin
Insulation Colors	Pair 1: ColorTip Light Blue, Blue Pair 2: ColorTip Light Orange, Orange Pair 3: ColorTip Light Green, Green Pair 4: ColorTip Light Brown, Brown
Ripcord	Non-wicking polyester yarn
Jacket	Tough, flame retardant, weather and abrasion resistant PVC
Characteristic Impedance Ohms	100 ± 15
Nominal Velocity of Propagation %	70
Performance Compliance	UL 444 CSA C22.2 No. 214-08 UL 1581 UL 1666 ANSI/TIA-568.2-D ANSI/ICEA S-90-661-2012 ANSI/TIA/EIA-570-B Article 800, NEC (NFPA 70) RoHS-compliant/RoHS 2-compliant
NRTL Programs	UL, c(UL) Listed CMR UL, c(UL) Listed CMX Outdoor

## ENVIRONMENTAL SPECIFICATIONS AND TESTS

Operation	-40°F to +167°F (-40°C to +75°C)
Installation	-40°F to +140°F (-40°C to +60°C)
ANSI/ICEA S-100-685-2009 <b>Tested down to -67°F (-55°C)</b>	Section 7.1: -4°F (-20°C) cold bend test Section 7.2: +14°F (-10°C) cold impact test Section 7.3: -40°F (-40°C) anvil test

## PART NUMBERS AND PHYSICAL CHARACTERISTICS

Part Number <sup>1</sup>	Nominal Diameter in (mm)	Approx. Weight lbs/kft (kg/km)	Package	Packages per Pallet
51-240-x1	0.21 (5.3)	21 (31)	1,000' POP™ box	36

## JACKET COLORS

<sup>1</sup> Replace "x" with:	Beige = 1	Blue = 2	Gray = 3	White = 4
--------------------------------	-----------	----------	----------	-----------

UL is a registered trademark of UL LLC.

## PRODUCT DESCRIPTION

The Superior Essex Category 5e CMR/CMX Outdoor cable is specifically designed for outdoor applications. UV-blocking compounds aid in protecting the cable from light. Applications include Ethernet interconnect cable for Wi-Fi or retrofit cable installations that employ exterior runs having long-term outdoor exposure between two environmentally protected points. CMX Outdoor cables are designed to extend the run between the Network Interface Unit and the point of entry into the interior of a residence or a premise.

Superior Essex CAT 5e CMR/CMX Outdoor premises cable has been tested and listed as UL® 444 Outdoor compliant. This designation requires the cable to resist 300 hours of UV and heat. In addition, the CMR listing allows the cable to be used in riser spaces per UL 1666, eliminating the need to transition to fire resistant cables.

## APPLICATIONS

- 10BASE-T through 1000BASE-T Ethernet
- Power over Ethernet (PoE) - IEEE 802.3af
- PoE+ - IEEE 802.3at Type 1 and 2
- ATM and token ring

## FEATURES

- Tough, weather resistant PVC jacket
- Combined indoor/outdoor rating
- Meets ANSI/TIA-568.2-D specification
- Moisture-resistant package
- CableID® alpha numeric code printed every 2 feet
- QuickCount® marking system in feet and meters
- ColorTip® Circuit Identification System

## BENEFITS

- Increases life of cable by providing low temperature handling and UV resistance; cable jacket resists cracking over time
- Reduces inventory by eliminating multiple cable types
- CAT 5e compliance
- Resists damp conditions that might weaken standard packages
- Allows both ends of a cable run to be easily identifiable without the need to separately label or tone the cable
- Provides remaining length of cable on reel
- Easily identifiable conductor mates even in low light environments



## CAUTIONARY INFORMATION

- Do not use as a substitute for Outside Plant (OSP) cables.
- Do not use in conduit or direct burial which can flood. These cables are not designed for extended exposure to water.



**ELECTRICAL SPECIFICATIONS**

Frequency MHz	Insertion Loss @ 20°C Maximum dB/100 m		NEXT Minimum dB/100 m		ACR Minimum dB/100 m		PSNEXT Minimum dB/100 m	
	TIA-568.2-D	Superior Essex	TIA-568.2-D	Superior Essex	TIA-568.2-D	Superior Essex	TIA-568.2-D	Superior Essex
	Specified	Typical	Specified	Typical	Calculated	Typical	Specified	Typical
1	2.0	1.8	65.3	76.8	63.3	81.0	62.3	75.3
4	4.1	3.7	56.3	67.8	52.2	70.1	53.3	66.3
8	5.8	5.4	51.8	63.3	46.0	63.9	48.8	61.8
10	6.5	6.0	50.3	61.8	43.8	61.8	47.3	60.3
16	8.2	7.7	47.2	58.7	39.0	57.0	44.3	57.2
20	9.3	8.6	45.8	57.3	36.5	54.7	42.8	55.8
25	10.4	9.6	44.3	55.8	33.9	52.2	41.3	54.3
31.25	11.7	10.8	42.9	54.4	31.2	49.6	39.9	52.9
62.5	17.0	15.5	38.4	49.9	21.4	40.4	35.4	48.4
100	22.0	19.8	35.3	46.8	13.3	33.0	32.3	45.3
155		24.8		43.9		25.1		42.4
200		28.2		42.3		20.1		40.8
250		31.8		40.8		15.0		39.3
300		35.0		39.6		10.6		38.1
350		38.3		38.6		6.3		37.1

Frequency MHz	PSACR Minimum dB/100 m		Return Loss Minimum dB/100 m		ELFEXT Minimum dB/100 m		PSELFEXT Minimum dB/100 m	
	TIA-568.2-D	Superior Essex	TIA-568.2-D	Superior Essex	TIA-568.2-D	Superior Essex	TIA-568.2-D	Superior Essex
	Calculated	Typical	Specified	Typical	Specified	Typical	Specified	Typical
1	60.3	78.3	20.0	33.0	63.8	74.6	60.8	69.3
4	49.2	67.4	23.0	36.0	51.8	62.6	48.8	57.3
8	43.0	61.2	24.5	37.5	45.7	56.5	42.7	51.2
10	40.8	59.1	25.0	38.0	43.8	54.6	40.8	49.3
16	36.1	54.3	25.0	38.0	39.7	50.5	36.7	45.2
20	33.5	52.0	25.0	38.0	37.8	48.6	34.8	43.3
25	30.9	49.5	24.3	37.3	35.8	46.6	32.8	41.3
31.25	28.2	46.9	23.6	36.6	33.9	44.7	30.9	39.4
62.5	18.4	37.7	21.5	34.5	27.9	38.7	24.9	33.4
100	10.3	30.3	20.1	33.1	23.8	34.6	20.8	29.3
155		22.4		31.8		30.8		25.5
200		17.4		31.0		28.6		23.3
250		12.3		30.3		26.6		21.3
300		7.9		29.8		25.1		19.8
350		3.6		29.3		23.7		18.4

# Category 5e F/UTP (ScTP)

CMR/CMX Outdoor Sunlight Resistant



Flame, Weather, Abrasion and Sunlight Resistant Black PVC Jacket

Solid Annealed Copper Conductor

Thermoplastic Insulation

Tin-Coated Drain Wire

Aluminum Foil Tape Shield

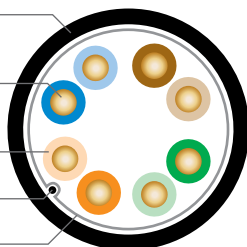

## SPECIFICATIONS

Pair Count	4
Conductor	Solid annealed copper
AWG (mm)	24 (0.51)
Insulation	Polyolefin
Insulation Colors	Pair 1: ColorTip Light Blue, Blue Pair 2: ColorTip Light Orange, Orange Pair 3: ColorTip Light Green, Green Pair 4: ColorTip Light Brown, Brown
Shield	Aluminum foil tape
Drain Wire	24 AWG tinned copper
Jacket	Tough, flame retardant, sunlight, weather, and abrasion resistant, black, riser-rated PVC
Characteristic Impedance Ohms	100 ± 15
Nominal Velocity of Propagation %	67
Performance Compliance	UL 444 CSA C22.2 No. 214-08 UL 1581 UL 1666 NFPA 262 ANSI/TIA-568.2-D ANSI/ICEA S-90-661-2012 Article 800, NEC (NFPA 70) RoHS-compliant/RoHS 2-compliant
NRTL Programs	UL Verified CAT 5e UL, c(UL) Listed CMR UL, c(UL) Listed CMX Outdoor Sunlight Resistant

## ENVIRONMENTAL SPECIFICATIONS AND TESTS

Operation	-40°F/+167°F (-40°C to +75°C)
Installation	-40°F to +140°F (-40°C to +60°C)
ANSI/ICEA S-100-685-2009 <b>Tested down to -67°F (-55°C)</b>	Section 7.1: -4°F (-20°C) cold bend test Section 7.2: +14°F (-10°C) cold impact test Section 7.3: -40°F (-40°C) anvil test

## PART NUMBERS AND PHYSICAL CHARACTERISTICS

Part Number <sup>1</sup>	Nominal Diameter in (mm)	Approx. Weight lbs/kft (kg/km)	Package	Packages per Pallet
5F-220-E1	0.26 (6.6)	29 (43)	1,000' Plywood reel	12

## PRODUCT DESCRIPTION

The Superior Essex Category 5e F/UTP (ScTP) CMR/CMX Outdoor Sunlight Resistant cable is specifically designed for extreme sunlight and temperature applications that require shielding and a ground wire for Power-over-Ethernet (PoE) devices. The level of UV-blocking compounds is the same as in traditional Outside Plant (OSP) cable products with the black color preventing damage from long-term UV sunlight exposure. Applications include Ethernet interconnect cable for Wi-Fi or retrofit cable installations that employ exterior runs having long-term outdoor exposure between two environmentally protected points. CMX Outdoor cables are designed to extend the run between the Network Interface Unit and the point of entry into the interior of a residence or a premise.

Superior Essex CAT 5e F/UTP (ScTP) CMR/CMX Outdoor Sunlight Resistant black premises cable has been tested and listed as UL® 444 Sunlight Resistant compliant. This designation requires the cable to resist 720 hours of harsh UV and heat, which is more than twice the exposure time of the standard 300 hours required in the CMX Outdoor test. In addition, the CMR listing allows the cable to be used in riser spaces per UL 1666, eliminating the need to transition to fire resistant cables.

The cable is sweep-tested to 350 MHz and meets all applicable ANSI/TIA-568.2-D requirements. It supports 1000BASE-T and surpasses the Grade 2 requirements specified in the ANSI/TIA/EIA-570-B Residential Telecommunications Standard.

## APPLICATIONS

- 10BASE-T through 1000BASE-T Ethernet
- Power over Ethernet (PoE) - IEEE 802.3af
- PoE+ - IEEE 802.3at Type 1 and 2
- Wi-Fi - IEEE 802.11a/b/g/n
- Applications requiring secure networks or protection from EMI/RFI
- Indoor/Outdoor Ethernet applications

## FEATURES

- UL 444/UL 1581 Sunlight Resistant Listed
- Combined CMR Riser Indoor and CMX Outdoor Sunlight Resistant Listing
- Meets ANSI/TIA-568.2-D specification
- Moisture-resistant package
- CableID® alpha numeric code printed every 2 feet
- QuickCount® marking system in feet and meters
- ColorTip® Circuit Identification System
- RoHS-compliant

## BENEFITS

- Increased life in direct, long term sunlight
- Reduces inventory by eliminating multiple cable types
- CAT 5e compliant
- Resists damp conditions that might weaken standard packages
- Allows both ends of a cable run to be easily identifiable without the need to separately label or tone the cable
- Provides remaining length of cable on reel
- Easily identifiable conductor mates even in low-light environments
- Free of heavy metal and toxic components



## CAUTIONARY INFORMATION

- Do not use as a substitute for Outside Plant (OSP) cables.
- Do not use in conduit or direct burial which can flood. These cables are not designed for extended exposure to water.

**ELECTRICAL SPECIFICATIONS**

Frequency MHz	Insertion Loss @ 20°C Maximum dB/100 m		NEXT Minimum dB/100 m		ACR Minimum dB/100 m		PSNEXT Minimum dB/100 m	
	TIA-568.2-D	Superior Essex	TIA-568.2-D	Superior Essex	TIA-568.2-D	Superior Essex	TIA-568.2-D	Superior Essex
	Specified	Typical	Specified	Typical	Calculated	Typical	Specified	Typical
1	2.0	1.8	65.3	79.4	63.3	77.7	62.3	77.2
4	4.1	3.6	56.3	69.9	52.2	66.4	53.3	67.4
8	5.8	5.1	51.8	65.1	46.0	60.0	48.8	62.7
10	6.5	5.8	50.3	63.6	43.8	57.9	47.3	61.2
16	8.2	7.4	47.3	60.4	39.1	53.1	44.3	58.0
20	9.3	8.2	45.8	59.0	36.5	50.9	42.8	56.6
25	10.4	9.3	44.3	57.5	33.9	48.3	41.3	55.1
31.25	11.7	10.5	42.9	56.0	31.2	45.7	39.9	53.5
62.5	17.0	14.9	38.4	51.7	21.4	36.8	35.4	49.2
100	22.0	19.2	35.3	48.5	13.3	29.5	32.3	46.0
155		24.2		45.7		21.6		43.1
200		27.8		43.6		16.0		41.0
250		31.4		42.0		10.7		39.4
300		34.7		40.4		5.9		37.7
350		37.8		39.3		1.7		36.8

Frequency MHz	PSACR Minimum dB/100 m		Return Loss Minimum dB/100 m		ELFEXT Minimum dB/100 m		PSELFEXT Minimum dB/100 m	
	TIA-568.2-D	Superior Essex	TIA-568.2-D	Superior Essex	TIA-568.2-D	Superior Essex	TIA-568.2-D	Superior Essex
	Calculated	Typical	Specified	Typical	Specified	Typical	Specified	Typical
1	60.3	75.4	20.0	28.5	63.8	72.6	60.8	70.6
4	49.2	64.0	23.0	35.6	51.7	60.7	48.7	59.0
8	43.0	57.7	24.5	35.7	45.7	54.8	42.7	53.1
10	40.8	55.6	25.0	35.9	43.8	52.9	40.8	51.1
16	36.1	50.8	25.0	35.2	39.7	48.9	36.7	47.1
20	33.5	48.6	25.0	34.9	37.7	47.0	34.7	45.2
25	30.9	46.0	24.3	35.2	35.8	45.1	32.8	43.3
31.25	28.2	43.4	23.6	34.8	33.9	43.2	30.9	41.3
62.5	18.4	34.6	21.5	31.8	27.8	37.2	24.8	35.2
100	10.3	27.3	20.1	30.1	23.8	33.2	20.8	31.1
155		19.4		28.4		29.3		27.2
200		13.9		27.3		27.1		25.0
250		8.6		26.1		25.1		23.1
300		3.8		25.1		23.7		21.5
350				24.0		22.5		20.3

UL is a registered trademark of UL LLC.

# Category 5e F/UTP (ScTP)

CMR/CMX Outdoor



Flame Retardant, Weather and Abrasion Resistant PVC Jacket

Solid Annealed Copper Conductor

Thermoplastic Insulation

Tin-Coated Drain Wire

Aluminum Foil Tape Shield

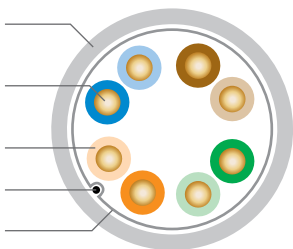

## SPECIFICATIONS

Pair Count	4
Conductor	Solid annealed copper
AWG (mm)	24 (0.51)
Insulation	Polyolefin
Insulation Colors	Pair 1: ColorTip Light Blue, Blue Pair 2: ColorTip Light Orange, Orange Pair 3: ColorTip Light Green, Green Pair 4: ColorTip Light Brown, Brown
Shield	Aluminum foil tape
Drain Wire	24 AWG tinned copper
Jacket	Tough, flame retardant, UV, weather, and abrasion resistant PVC
Characteristic Impedance Ohms	100 ± 15
Nominal Velocity of Propagation %	67
Performance Compliance	UL 444 CSA C22.2 No. 214-08 UL 1666 NFPA 262 ANSI/TIA-568.2-D ANSI/ICEA S-90-661-2012 Article 800, NEC (NFPA 70) RoHS-compliant/RoHS 2-compliant
NRTL Programs	UL Verified CAT 5e UL, c(UL) Listed CMR UL, c(UL) Listed CMX Outdoor

## ENVIRONMENTAL SPECIFICATIONS AND TESTS

Operation	-40°F to +167°F (-40°C to +75°C)
Installation	-40°F to +140°F (-40°C to +60°C)
ANSI/ICEA S-100-685-2009 Tested down to -67°F (-55°C)	Section 7.1: -4°F (-20°C) cold bend test Section 7.2: +14°F (-10°C) cold impact test Section 7.3: -40°F (-40°C) anvil test

## PART NUMBERS AND PHYSICAL CHARACTERISTICS

Part Number <sup>1</sup>	Nominal Diameter in (mm)	Approx. Weight lbs/kft (kg/km)	Package	Packages per Pallet
5F-220-x1	0.26 (6.6)	29 (43)	1,000' Plywood reel	12

## JACKET COLORS

<sup>1</sup>Replace "x" with:

Beige = 1

Blue = 2

Gray = 3

White = 4

## PRODUCT DESCRIPTION

The Superior Essex Category 5e F/UTP (ScTP) CMR/CMX Outdoor cable is specifically designed for outdoor applications that require shielding and a ground wire for Power-over-Ethernet (PoE) devices. UV-blocking compounds aid in protecting the cable from light. Applications include Ethernet interconnect cable for Wi-Fi or retrofit cable installations that employ exterior runs having long-term outdoor exposure between two environmentally protected points. CMX Outdoor cables are designed to extend the run between the Network Interface Unit and the point of entry into the interior of a residence or a premise.

Superior Essex CAT 5e F/UTP (ScTP) CMR/CMX Outdoor premises cable has been tested and listed as UL® 444 Outdoor compliant. This designation requires the cable to resist 300 hours of UV and heat. In addition, the CMR listing allows the cable to be used in riser spaces per UL 1666, eliminating the need to transition to fire resistant cables.

The cable is sweep-tested to 350 MHz and meets all applicable ANSI/TIA-568.2-D requirements. It supports 1000BASE-T and surpasses the Grade 2 requirements specified in the ANSI/TIA/EIA-570-B Residential Telecommunications Standard.

## APPLICATIONS

- 10BASE-T through 1000BASE-T Ethernet
- Power over Ethernet (PoE) - IEEE 802.3af
- PoE+ - IEEE 802.3at Type 1 and 2
- ATM and token ring
- Applications requiring secure networks or protection from EMI/RFI
- Indoor/Outdoor Ethernet Applications

## FEATURES

- Tough, weather resistant PVC jacket
- Combined indoor/outdoor rating
- Meets ANSI/TIA-568.2-D
- Moisture-resistant package
- CableID® alpha numeric code printed every 2 feet
- QuickCount® marking system in feet and meters
- ColorTip® Circuit Identification System
- RoHS-compliant

## BENEFITS

- Increases life of cable by providing low temperature handling and sunlight resistance; cable jacket resists cracking over time
- Reduces inventory by eliminating multiple cable types
- CAT 5e compliant
- Resists damp conditions that might weaken standard packages
- Allows both ends of a cable run to be easily identifiable without the need to separately label or tone the cable
- Provides remaining length of cable on reel
- Easily identifiable conductor mates even in low-light environments
- Free of heavy metal and toxic components



## CAUTIONARY INFORMATION

- Do not use as a substitute for Outside Plant (OSP) cables.
- Do not use in conduit or direct burial which can flood. These cables are not designed for extended exposure to water.

**ELECTRICAL SPECIFICATIONS**

Frequency MHz	Insertion Loss @ 20°C Maximum dB/100 m		NEXT Minimum dB/100 m		ACR Minimum dB/100 m		PSNEXT Minimum dB/100 m	
	TIA-568.2-D	Superior Essex	TIA-568.2-D	Superior Essex	TIA-568.2-D	Superior Essex	TIA-568.2-D	Superior Essex
	Specified	Typical	Specified	Typical	Calculated	Typical	Specified	Typical
1	2.0	1.8	65.3	79.4	63.3	77.7	62.3	77.2
4	4.1	3.6	56.3	69.9	52.2	66.4	53.3	67.4
8	5.8	5.1	51.8	65.1	46.0	60.0	48.8	62.7
10	6.5	5.8	50.3	63.6	43.8	57.9	47.3	61.2
16	8.2	7.4	47.3	60.4	39.1	53.1	44.3	58.0
20	9.3	8.2	45.8	59.0	36.5	50.9	42.8	56.6
25	10.4	9.3	44.3	57.5	33.9	48.3	41.3	55.1
31.25	11.7	10.5	42.9	56.0	31.2	45.7	39.9	53.5
62.5	17.0	14.9	38.4	51.7	21.4	36.8	35.4	49.2
100	22.0	19.2	35.3	48.5	13.3	29.5	32.3	46.0
155		24.2		45.7		21.6		43.1
200		27.8		43.6		16.0		41.0
250		31.4		42.0		10.7		39.4
300		34.7		40.4		5.9		37.7
350		37.8		39.3		1.7		36.8

Frequency MHz	PSACR Minimum dB/100 m		Return Loss Minimum dB/100 m		ELFEXT Minimum dB/100 m		PSELFEXT Minimum dB/100 m	
	TIA-568.2-D	Superior Essex	TIA-568.2-D	Superior Essex	TIA-568.2-D	Superior Essex	TIA-568.2-D	Superior Essex
	Calculated	Typical	Specified	Typical	Specified	Typical	Specified	Typical
1	60.3	75.4	20.0	28.5	63.8	72.6	60.8	70.6
4	49.2	64.0	23.0	35.6	51.7	60.7	48.7	59.0
8	43.0	57.7	24.5	35.7	45.7	54.8	42.7	53.1
10	40.8	55.6	25.0	35.9	43.8	52.9	40.8	51.1
16	36.1	50.8	25.0	35.2	39.7	48.9	36.7	47.1
20	33.5	48.6	25.0	34.9	37.7	47.0	34.7	45.2
25	30.9	46.0	24.3	35.2	35.8	45.1	32.8	43.3
31.25	28.2	43.4	23.6	34.8	33.9	43.2	30.9	41.3
62.5	18.4	34.6	21.5	31.8	27.8	37.2	24.8	35.2
100	10.3	27.3	20.1	30.1	23.8	33.2	20.8	31.1
155		19.4		28.4		29.3		27.2
200		13.9		27.3		27.1		25.0
250		8.6		26.1		25.1		23.1
300		3.8		25.1		23.7		21.5
350				24.0		22.5		20.3

UL is a registered trademark of UL LLC.

# 6-Pair Category 5e

CMR

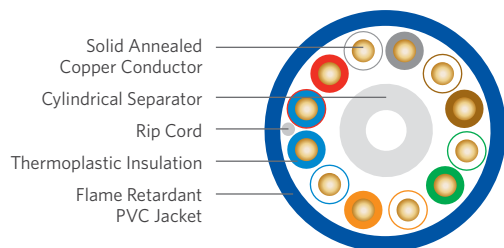

## SPECIFICATIONS

Pair Count	6
Conductor	Solid annealed copper
AWG (mm)	24 (0.51)
Insulation	Polyolefin
Separator	Round filler
Jacket	Flame retardant PVC
Characteristic Impedance Ohms	100 ± 15
Nominal Velocity of Propagation %	71
Performance Compliance	UL® 444 CSA C22.2 No. 214-08 UL 1666 ANSI/TIA-568.2-D ANSI/ICEA S-90-661-2012 Article 800, NEC (NFPA 70) RoHS-compliant/RoHS 2-compliant
NRTL Programs	UL, c(UL) Listed CMR

## PART NUMBERS AND PHYSICAL CHARACTERISTICS

Listing	Part Number <sup>1</sup>	Nominal Diameter in (mm)	Approx. Weight lbs/kft (kg/km)	Package	Packages per Pallet
CMR	51-347-x5	0.26 (6.6)	32 (48)	1,000' Reel-in-a-Box	27
CMR	51-372-x5	0.26 (6.6)	32 (48)	1,000' Plywood reel	16

## JACKET COLORS

<sup>1</sup>Replace "x" with: Blue = 2      Gray = 3

UL is a registered trademark of UL LLC.

## PRODUCT DESCRIPTION

6-pair UTP cable, with Category 5e (ANSI/TIA-568.2-D) performance, is the solution to a growing number of special installation needs. More customers are demanding two additional pairs above the standard 4-pair cable for high-bandwidth applications. Two additional pairs provide the flexibility for utility metering and other telemetry needs without the expense of adding a separate cable and without additional space. The Superior Essex 6-pair CAT 5e cable delivers the performance expected, while offering the many features and user advantages of all our high performance premises products.

## APPLICATIONS

- 10BASE-T through 1000BASE-T Ethernet
- Power over Ethernet (PoE) - IEEE 802.3af
- PoE+ - IEEE 802.3at Type 1 and 2
- ATM and token ring

## FEATURES

- Two additional pairs in excess of the standard 4-pair construction
- ANSI/TIA-568.2-D compliance
- CableID® alpha numeric code printed every 2 feet
- QuickCount® marking system in feet and meters
- Warrantied with all leading connectivity manufacturers

## BENEFITS

- Eliminates expense of additional cable when 6-pair are required, reduces cabling space requirements; speeds installation time
- Any of the 6-pair can be used for CAT 5e applications
- Allows both ends of a cable run to be easily identifiable without the need to separately label or tone the cable
- Eliminates guesswork of footage on reel and reduces scrap
- Offers flexibility in selection of connectivity solutions

# 25-Pair Power Sum Category 5e

CMR/CMP

## PRODUCT DESCRIPTION

25-Pair Power Sum Category 5e UTP cables are designed to provide support for both backbone and horizontal applications. These applications include inter-closet backbone links, equipment cabling between cross-connect and hub equipment and zone distribution horizontal cabling between wiring closets and multiple work area transition points. The cable is available in CMP and CMR ratings and is UL® verified to meet all requirements of ANSI/TIA-568.2-D.

## APPLICATIONS

- 10BASE-T through 1000BASE-T Ethernet
- Power over Ethernet (PoE) - IEEE 802.3af
- PoE+ - IEEE 802.3at Type 1 and 2
- ATM and token ring

## FEATURES

- Small outside diameter
- Vibrant insulation colors
- Flexible jacket material
- Marked in feet and meters

## BENEFITS

- Handles tight installations
- Easier identification of conductors
- Ease of use during installation
- Dual length marking complies with government, military and international requirements

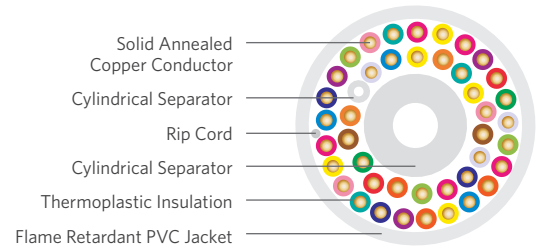
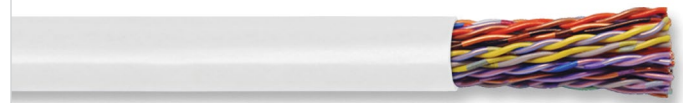

## SPECIFICATIONS

<b>Pair Count</b>	25
<b>Conductor</b>	Solid annealed copper
<b>AWG (mm)</b>	24 (0.51)
<b>Insulation</b>	CMR: Thermoplastic CMP: FEP
<b>Separator</b>	Cylindrical
<b>Jacket</b>	CMR: White, flame retardant PVC CMP: White, fluoropolymer
<b>Characteristic Impedance Ohms</b>	100 ± 15
<b>Nominal Velocity of Propagation %</b>	CMR: 69 CMP: 73
<b>Performance Compliance</b>	UL 444 CSA C22.2 No. 214-08 UL 1666 NFPA 262 ANSI/TIA-568.2-D ANSI/ICEA S-90-661-2012 Article 800, NEC (NFPA 70) RoHS-compliant/RoHS 2-compliant
<b>NRTL Programs</b>	UL Verified CAT 5e UL, c(UL) Listed CMR UL, c(UL) Listed CMP

## PART NUMBERS AND PHYSICAL CHARACTERISTICS

Listing	Part Number <sup>1</sup>	Nominal Diameter in (mm)	Approx. Weight lbs/kft (kg/km)	Package	Packages per Pallet
CMR	51-478-45	0.57 (14.5)	144 (214)	1,000' Plywood reel	4
CMP	51-478-48	0.48 (12.2)	148 (220)	1,000' Plywood reel	4

UL is a registered trademark of UL LLC.

# 25-Pair Category 5e Indoor/Outdoor

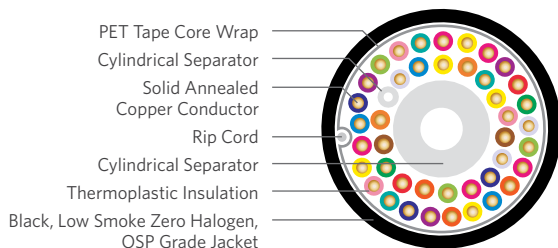

## SPECIFICATIONS

Pair Count	25
Conductor	Solid annealed copper
AWG (mm)	24 (0.51)
Insulation	Thermoplastic
Separators	Cylindrical, flame retardant thermoplastic
Core Wrap	PET Tape
Jacket	Black, CM rated, non-halogen OSP grade
Input Impedance Ohms Guaranteed @ 1-100 MHz	100 ± 15
Delay Skew ns/100 m	Maximum: 45 Typical: 30
Nominal Velocity of Propagation %	69
DC Resistance Ohms/100 m	Maximum: 9.38 Typical: 9.0
Resistance Unbalance %	Maximum: 5.0 Typical: 0.7
Performance Compliance	UL® 444 CSA C22.2 No. 214-08 ANSI/TIA-568.2-D ANSI/ICEA S-90-661-2012 Article 800, NEC (NFPA 70) RoHS-compliant/RoHS 2-compliant
NRTL Programs	UL, c(UL) Listed CM

## PART NUMBERS AND PHYSICAL CHARACTERISTICS

Part Number	Nominal Diameter in (mm)	Approx. Weight lbs/kft (kg/km)	Package
51-499-EL	0.59 (15)	148 (221)	cut to length

UL is a registered trademark of UL LLC.

## PRODUCT DESCRIPTION

With its CM fire rating and UV resistant black jacket, this 25-pair, 24 gauge, Category 5e tight twisted copper conductor cable can be installed in both premises and outside plant (OSP) environments. The CAT 5e tight twist lays provide superior crosstalk performance, supporting digital subscriber line (xDSL) and IPTV broadband technologies in both the OSP pedestal and customer premises. In addition, the cable jacket is fungus resistant which is important in OSP pedestal environments. The cable meets or exceeds ANSI/TIA-568.2-D for CAT 5e backbone cables and is able to support up to 1000BASE-T Ethernet technologies.

## APPLICATIONS

- ADSL, VDSL, VDSL+ and VDSL+2
- 10BASE-T through 1000BASE-T Ethernet
- Power over Ethernet (PoE) – IEEE 802.3af
- PoE+ – IEEE 802.3at Type 1 and 2
- ATM and token ring

## FEATURES

- Small outside diameter
- Vibrant insulation colors
- Black, CM rated, non-halogen, OSP grade jacket material
- Fungus resistance
- Compliant to ANSI/TIA-568.2-D for CAT 5e
- Specially designed tight twist lays
- Low temperature bend performance

## BENEFITS

- Handles tight installations
- Easy identification of conductors
- Provides full sunlight resistance and fire protection in a flexible jacket
- Non-nutritive to fungus and ideal for installation in humid environments
- Capable of 1000BASE-T
- Provides superior Alien Crosstalk performance for xDSL applications
- Allows installation at -20°C temperatures



# Interlock Armored

## Premises Copper CMR

**PRODUCT DESCRIPTION**

Interlock Armored Category 6, Category 5e, Category 3 and/or RG-6 Quad Coax Riser cables provide significant mechanical protection. Interlock armored cables with two or more components of the same type can have either different colored components or uniquely labeled components with the same color. Multiple cables can be constructed in aluminum interlock armored; and the final cable is available in bare metal or with an overall jacket. Each component cable is tested after interlock armoring to ensure that it meets all applicable industry requirements. Cable configurations that include optical fiber distribution cables are also available.

**FEATURES**

- Aluminum interlock armored
- Category components meets ANSI/TIA-568.2-D for CAT 3, CAT 5e and CAT 6
- CMR rated components

**BENEFITS**

- Protects against mechanical stresses
- Protects against EMI/RFI for reliable performance
- Provides additional fire protection over riser rating
- Installs faster and easier than EMT conduit and conventional wire
- Supports applications up to 1000BASE-T
- Maintains the fire rating with interlock armored removed

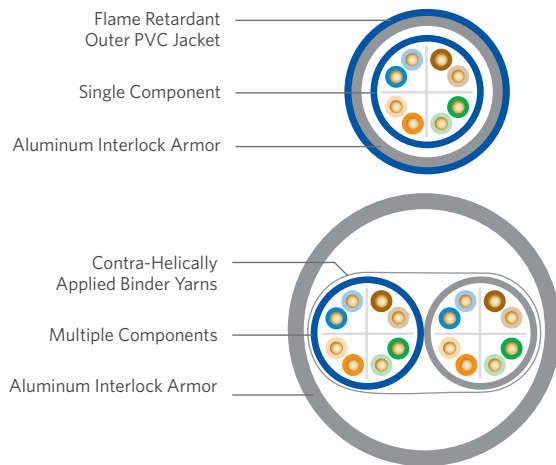
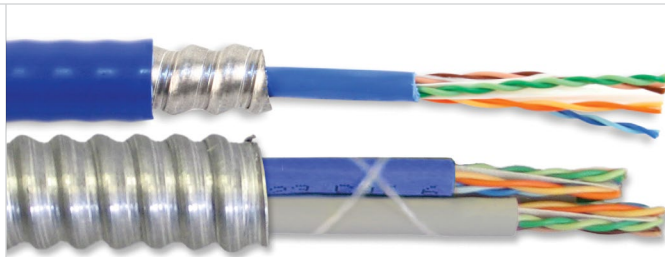

**SPECIFICATIONS**

<b>Overall Cable Configuration</b>	Single to multiple component riser cables surrounded by aluminum or steel interlock armored
<b>Armor</b>	Interlocked aluminum
<b>Armor Jacket Options</b>	Non-jacketed or jacketed (matches component color)
<b>Armor/Component Jacket</b>	Riser grade PVC
<b>Component Fire Listings</b>	UL® 1666, UL CMR, c(UL) CMR
<b>Performance Compliance</b>	UL 1569 UL 444 CSA C22.2 No. 214-08 ANSI/TIA-568.2-D ANSI/ICEA S-90-661-2012 Article 800, NEC (NFPA 70) RoHS-compliant/RoHS 2-compliant
<b>NRTL Programs</b>	UL, c(UL) Listed CMR

**PART NUMBERS AND PHYSICAL CHARACTERISTICS**

Part Number <sup>1</sup>	Configuration	Component	Number of Components	Nominal Diameter in (mm)	Approx. Weight lbs/kft (kg/km)	Package
K4-199-xA	Aluminum interlock armored, no outer jacket	4-pair CAT 6	1	0.49 (12.5)	67 (100)	1,000' Wood reel
L4-199-xA	Aluminum interlock armored, with outer jacket*	4-pair CAT 6	1	0.55 (14.0)	104 (155)	1,000' Wood reel
K4-299-yA	Aluminum interlock armored, no outer jacket	4-pair CAT 6	2	0.80 (20.2)	117 (174)	1,000' Wood reel
L4-299-yA	Aluminum interlock armored, with outer jacket*	4-pair CAT 6	2	0.87 (22.2)	196 (292)	1,000' Wood reel
K2-199-x5	Aluminum interlock armored, no outer jacket	4-pair CAT 5e	1	0.44 (11.1)	55 (82)	1,000' Wood reel
L2-199-x5	Aluminum interlock armored, with outer jacket*	4-pair CAT 5e	1	0.50 (12.6)	88 (132)	1,000' Wood reel
K2-299-y5	Aluminum interlock armored, no outer jacket	4-pair CAT 5e	2	0.80 (20.2)	105 (156)	1,000' Wood reel
L2-299-y5	Aluminum interlock armored, with outer jacket*	4-pair CAT 5e	2	0.88 (22.2)	184 (274)	1,000' Wood reel
KC-919-x5	Aluminum interlock armored, no outer jacket	RG-6 Quad**	1	0.53 (13.5)	73 (109)	1,000' Wood reel
K8-A99-33	Aluminum interlock armored, no outer jacket	25-pair CAT 3	1	0.79 (20.2)	159 (237)	1,000' Wood reel

\*For single unit cables, the outer jacket color matches the internal component jacket color. For multi-unit cables, the outer jacket standard color is blue. Additional cable combinations are available. \*\*Coaxial available with component jacket color in black or white.

**SINGLE COMPONENT JACKET COLORS**

<sup>1</sup>Replace "x" with:

Blue = 2	Gray = 3	White = 4	Green = 5	Yellow = 6	Purple = 7	Red = 9	Orange = D	Black = E
----------	----------	-----------	-----------	------------	------------	---------	------------	-----------

**DUAL COMPONENT JACKET COLORS**

<sup>1</sup>Replace "y" with "S"      <sup>1</sup>Replace "y" with "T"

Blue	White	Blue	Gray
------	-------	------	------

Other color sequences are available upon request. UL is a registered trademark of UL LLC.

# Bundled Category 6

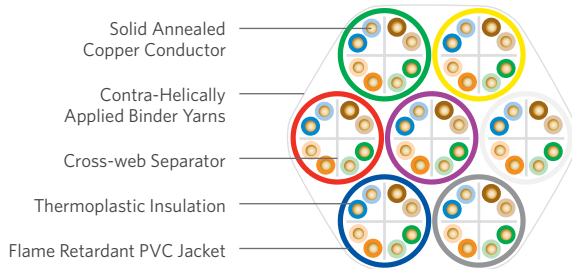

## SPECIFICATIONS

Conductor	Solid annealed copper
AWG (mm)	23 (0.57)
Insulation	CMR: Thermoplastic CMP: FEP
Insulation Colors	Pair 1: ColorTip Light Blue, Blue Pair 2: ColorTip Light Orange, Orange Pair 3: ColorTip Light Green, Green Pair 4: ColorTip Light Brown, Brown
Separator	Cross-web
Jacket	CMR: Flame retardant (FR) PVC CMP: FR, low smoke PVC
Characteristic Impedance Ohms	100 ± 15
Nominal Velocity of Propagation %	CMR: 70 CMP: 74
Component Performance Compliance	UL® 444 CSA C22.2 No. 214-08 UL 1666 NFPA 262 ANSI/TIA-568.2-D Article 800, NEC (NFPA 70) RoHS-compliant/RoHS 2-compliant
Component NRTL Programs	UL, c(UL) Listed CMR UL, c(UL) Listed CMP

## PRODUCT DESCRIPTION

Superior Essex Bundled UTP cables reduce the amount of cable pulls in an installation and simplify cable management. These bundled cables consist of multiple Category 6 compliant cables bundled together and bound by contra-helically applied binder yarns. The binder configuration allows for easy breakout and offers greater flexibility compared to an overjacket design. Contrasting jacket colors allow for easy identification.

## APPLICATIONS

- 10BASE-T through 1000BASE-T Ethernet
- Power over Ethernet (PoE) - IEEE 802.3af
- PoE+ - IEEE 802.3at Type 1 and 2
- ATM and token ring

## FEATURES

- Binding of multiple UTP cables
- Multiple construction options (2 to 7 cable sub-units)
- Warrantied with numerous connectivity manufacturers
- ColorTip® circuit identification system
- Flexible, dual binder yarns, contra-helically applied

## BENEFITS

- Reduces installation time
- Improves cable management
- Sizes available for small and large projects
- Easily identifiable conductor mates, even in low light environment
- Maintains maximum flexibility and allows for easy breakout

## PART NUMBERS AND PHYSICAL CHARACTERISTICS

Listing	Part Number	Cable Sub-units	Jacket Colors*	Nominal Diameter in (mm)	Approx. Weight lbs/kft (kg/km)	Standard Length ft (m)	Reel Size F x T x D (in)
CMR	56-202-2A	2	Blue, Gray	0.44 (11.2)	48 (106)	2,500 (762)	30 x 18 x 12
CMR	56-202-3A	3	Blue, Gray, White	0.48 (12.1)	72 (159)	2,500 (762)	30 x 18 x 12
CMR	56-202-4A	4	Blue, Gray, White, Yellow	0.53 (13.6)	97 (213)	2,500 (762)	30 x 18 x 12
CMR	56-201-5A	5	Blue, Gray, White, Yellow, Green	0.61 (15.5)	121 (266)	2,500 (762)	30 x 18 x 12
CMR	56-201-6A	6	Blue, Gray, White, Yellow, Green, Red	0.70 (17.8)	145 (319)	2,500 (762)	30 x 18 x 12
CMR	56-201-7A	7	Blue, Gray, White, Yellow, Green, Red, Purple	0.70 (17.8)	176 (387)	1,000 (305)	30 x 18 x 12
CMP	56-202-2B	2	Blue, Gray	0.48 (12.1)	57 (126)	2,500 (762)	30 x 18 x 12
CMP	56-202-3B	3	Blue, Gray, White	0.51 (13.0)	86 (189)	2,500 (762)	30 x 18 x 12
CMP	56-202-4B	4	Blue, Gray, White, Yellow	0.57 (14.6)	115 (252)	2,500 (762)	30 x 18 x 12
CMP	56-201-5B	5	Blue, Gray, White, Yellow, Green	0.64 (16.3)	143 (315)	2,500 (762)	30 x 18 x 12
CMP	56-201-6B	6	Blue, Gray, White, Yellow, Green, Red	0.71 (18.1)	172 (378)	2,500 (762)	30 x 18 x 12
CMP	56-201-7B	7	Blue, Gray, White, Yellow, Green, Red, Purple	0.71 (18.1)	201 (441)	1,000 (305)	30 x 18 x 12

\*Other jacket color combinations available.

## JACKET COLORS



UL is a registered trademark of UL LLC.

## PRODUCT DESCRIPTION

Superior Essex Bundled UTP cables reduce the amount of cable pulls in an installation and simplify cable management. These bundled cables consist of multiple Category 5e compliant cables bundled together and bound by contra-helically applied binder yarns. The binder configuration allows for easy breakout and offers greater flexibility compared to a composite overjacket design. Contrasting jacket colors allow easy identification.

## APPLICATIONS

- 10BASE-T through 1000BASE-T Ethernet
- Power over Ethernet (PoE) - IEEE 802.3af
- PoE+ - IEEE 802.3at Type 1 and 2
- ATM and token ring

## FEATURES

- Binding of multiple UTP cables
- Multiple construction options (2 to 7 cable sub-units)
- Warrantied with numerous connectivity manufacturers
- ColorTip® circuit identification system
- Flexible, dual binder yarns, contra-helically applied

## BENEFITS

- Reduces installation time
- Improves cable management
- Sizes available for small and large projects
- Easily identifiable conductor mates, even in low light environment
- Maintains maximum flexibility and allows for easy breakout

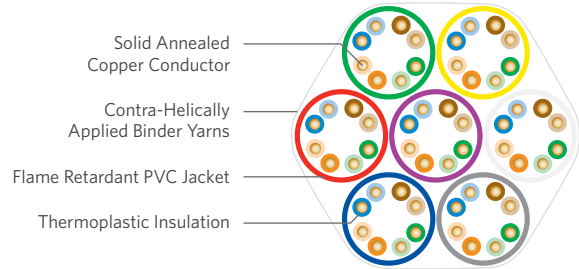

## SPECIFICATIONS

<b>Conductor</b>	Solid annealed copper
<b>AWG (mm)</b>	24 (0.51)
<b>Insulation</b>	Thermoplastic
<b>Insulation Colors</b>	Pair 1: ColorTip Light Blue, Blue Pair 2: ColorTip Light Orange, Orange Pair 3: ColorTip Light Green, Green Pair 4: ColorTip Light Brown, Brown
<b>Jacket</b>	CMR: Flame retardant (FR) PVC CMP: FR, low smoke PVC
<b>Characteristic Impedance Ohms</b>	100 ± 15
<b>Nominal Velocity of Propagation %</b>	CMR: 70 CMP: 73
<b>Component Performance Compliance</b>	UL® 444 CSA C22.2 No. 214-08 UL 1666 NFPA 262 ANSI/TIA-568.2-D ANSI/ICEA S-90-661-2012 Article 800, NEC (NFPA 70) RoHS-compliant/RoHS 2-compliant
<b>Component NRTL Programs</b>	UL, c(UL) Listed CMP UL, c(UL) Listed CMR

## PART NUMBERS AND PHYSICAL CHARACTERISTICS

Listing	Part Number	Cable Sub-units	Jacket Colors*	Nominal Diameter in (mm)	Approx. Weight lbs/kft (kg/km)	Standard Length ft (m)	Reel Size F x T x D (in)
CMR	56-202-25	2	Blue, Gray	0.38 (9.7)	38 (083)	2,500 (762)	30 x 18 x 12
CMR	56-202-35	3	Blue, Gray, White	0.41 (10.4)	57 (125)	2,500 (762)	30 x 18 x 12
CMR	56-202-45	4	Blue, Gray, White, Yellow	0.46 (11.7)	76 (167)	2,500 (762)	30 x 18 x 12
CMR	56-201-55	5	Blue, Gray, White, Yellow, Green	0.51 (13.0)	95 (208)	2,500 (762)	30 x 18 x 12
CMR	56-201-65	6	Blue, Gray, White, Yellow, Green, Red	0.56 (14.2)	114 (250)	2,500 (762)	30 x 18 x 12
CMR	56-201-75	7	Blue, Gray, White, Yellow, Green, Red, Purple	0.56 (14.2)	133 (292)	1,000 (305)	30 x 18 x 12
CMP	56-202-28	2	Blue, Gray	0.35 (8.9)	39 (085)	2,500 (762)	30 x 18 x 12
CMP	56-202-38	3	Blue, Gray, White	0.38 (9.6)	58 (127)	2,500 (762)	30 x 18 x 12
CMP	56-202-48	4	Blue, Gray, White, Yellow	0.42 (10.8)	77 (170)	2,500 (762)	30 x 18 x 12
CMP	56-201-58	5	Blue, Gray, White, Yellow, Green	0.48 (12.1)	96 (212)	2,500 (762)	30 x 18 x 12
CMP	56-201-68	6	Blue, Gray, White, Yellow, Green, Red	0.53 (13.4)	116 (254)	2,500 (762)	30 x 18 x 12
CMP	56-201-78	7	Blue, Gray, White, Yellow, Green, Red, Purple	0.53 (13.4)	135 (297)	1,000 (305)	30 x 18 x 12

\*Other jacket color combinations available.

## JACKET COLORS

Blue	Gray	White	Yellow	Green	Red	Purple
------	------	-------	--------	-------	-----	--------

UL is a registered trademark of UL LLC.

# EnduraGain® OSP Unshielded

Formerly BBD

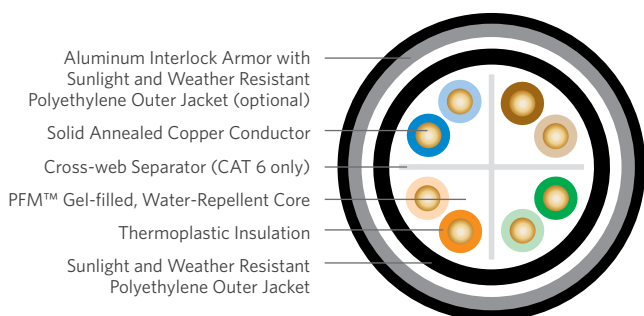
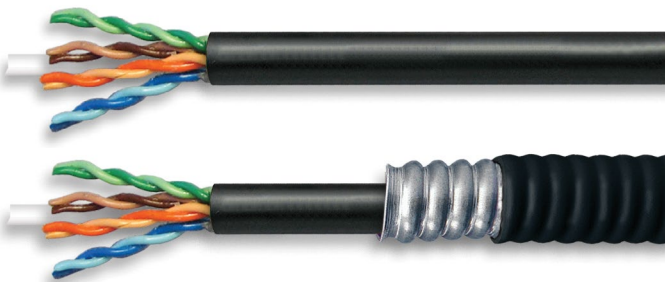

Aluminum Interlock Armor with Sunlight and Weather Resistant Polyethylene Outer Jacket (optional)  
Solid Annealed Copper Conductor  
Cross-web Separator (CAT 6 only)  
PFM™ Gel-filled, Water-Repellent Core  
Thermoplastic Insulation  
Sunlight and Weather Resistant Polyethylene Outer Jacket

## SPECIFICATIONS

Pair Count	4
Conductor	Solid annealed copper
Insulation	Polyolefin
Separator	CAT 6A/6: Polyolefin cross-web CAT 5e: none
Jacket	Black, sunlight and weather resistant polyethylene
Optional Outer Armor	Interlocked aluminum armor covered with black, sunlight and weather resistant polyethylene jacket
Characteristic Impedance Ohms	100 ± 15
Nominal Velocity of Propagation %	CAT 6A/6: 68 CAT 5e: 65
Performance Compliance	ANSI/TIA-568.2-D ANSI/ICEA S-107-704-2012 RoHS-compliant/RoHS 2-compliant REACH-compliant

## ENVIRONMENTAL SPECIFICATIONS AND TESTS

Operation	-40°F to +167°F (-40°C to +75°C)
Installation	-40°F to +140°F (-40°C to +60°C)
ANSI/ICEA S-100-685-2009 Tested down to -67°F (-55°C)	Section 7.1: -4°F (-20°C) cold bend test Section 7.2: +14°F (-10°C) cold impact test Section 7.3: -40°F (-40°C) anvil test

## PART NUMBERS AND PHYSICAL CHARACTERISTICS

Category	Configuration	Part Number	Product Type	AWG (mm)	Nominal Diameter in (mm)	Approx. Weight lbs/kft (kg/km)	Package
CAT 6A	n/a	04-001-A8	UTP	23 (0.57)	0.39 (9.8)	33 (49)	1,000' Plywood reel
CAT 6	Interlock armored	L4-001-68	UTP	23 (0.57)	0.56 (14.1)	101 (150)	1,000' Plywood reel
CAT 6	n/a	04-001-68	UTP	23 (0.57)	0.30 (7.6)	33 (49)	1,000' Plywood reel
CAT 5e	n/a	04-001-58	UTP	24 (0.51)	0.26 (6.6)	24 (36)	1,000' Plywood reel

Additional part numbers, constructions and packaging available upon request.

## PRODUCT DESCRIPTION

EnduraGain® OSP Unshielded is a robust category cable designed to provide an extension of the LAN beyond the premises or in situations where the NEC code requires an OSP-rated cable when it is in contact with earth, whether in a conduit or not. The cable consists of a core of four (4) balanced twisted pairs surrounded by Superior Essex PFM™ gel that does not drip or flow, even in cell tower applications at elevated temperatures. The core is jacketed with a sunlight and abrasion resistant black, polyethylene outer jacket. This unshielded design is suitable for the following deployments: duct, underground conduit and tower.

EnduraGain OSP Unshielded is available in a variety of performances including CAT 5e, CAT 6 and CAT 6A. An optional Aluminum Interlock Armor with overjacket is also available (not suitable for tower deployment).

## APPLICATIONS

- CAT 6A: 10BASE-T through 10GBASE-T Ethernet
- CAT 6/5e: 10BASE-T through 1000BASE-T Ethernet
- Power over Ethernet (PoE) - IEEE 802.3af
- PoE+ - IEEE 802.3bt Type 1 to Type 4
- ATM and token ring

## FEATURES

- Transmission performance characterized to 500 MHz for CAT 6A/6 and 350 MHz for CAT 5e
- Unshielded
- PFM gel-filled core construction
- OSP-grade black polyethylene jacket
- ColorTip® circuit identification system
- Aluminum interlock armored construction

## BENEFITS

- Assures ample overhead for reliable transmission in an OSP-rated cable allowing extension of the premises LAN
- Small, robust design
- Prevents intrusion of and easily wipes clean during installation
- Outside plant rated cable for years of reliable performance
- Easily identifiable conductor mates even in low-light environments
- Protects against mechanical stresses
- Installs faster and easier than EMT conduit and conventional wire



## TECHNICAL GUIDELINE

Special connectivity is required for these cable designs. Refer to the "Resources" section on our site for the Technical Guideline, "OSP Broadband Installation Guidelines," for more information.

## PRODUCT DESCRIPTION

EnduraGain® OSP Shielded is a robust category cable designed to provide an extension of the LAN beyond the premises or in situations where the NEC code requires an OSP-rated cable when it is in contact with earth, whether in a conduit or not. The cable consists of four (4) balanced twisted pairs surrounded by Superior Essex PFM™ gel that does not drip or flow, even in cell tower applications at elevated temperatures. The jacketed core is covered with dry block and an 8 mil aluminum tape shield providing exceptional Alien Crosstalk (AXT) performance. The outer jacket is OSP-grade black, polyethylene for superior sunlight and abrasion resistance. This shielded design is suitable for the following deployments: duct, underground conduit, tower, lashed aerial or open trench.

EnduraGain OSP Shielded is available in a variety of performances including CAT 5e, CAT 6 and CAT 6A. An optional Aluminum Interlock Armor with overjacket is also available (not suitable for tower deployment).

## APPLICATIONS

- CAT 6A: 10BASE-T through 10GBASE-T Ethernet;  
CAT 6/5e: 10BASE-T through 1000BASE-T Ethernet
- Power over Ethernet (PoE) - IEEE 802.3af
- PoE+ - IEEE 802.3at Type 1 and 2
- ATM and token ring

## FEATURES

- Transmission performance characterized to 500 MHz for CAT 6A/6 and 350 MHz for CAT 5e
- 8 mil aluminum tape shield
- Dry block between shield and inner jacket
- PFM gel-filled core construction
- OSP-grade black polyethylene jacket
- ColorTip® circuit identification system
- Aluminum interlock armored construction

## BENEFITS

- Assures ample overhead for reliable transmission in an OSP-rated cable allowing extension of the premises LAN
- Rugged shield provides protection against EMI/RFI
- Prevents water ingress between shield and inner cable preventing damage to equipment
- Prevents intrusion of moisture and easily wipes clean during installation
- Outside plant rated cable for years of reliable performance
- Easily identifiable conductor mates even in low-light environments
- Protects against mechanical stresses
- Installs faster and easier than EMT conduit and conventional wire



## TECHNICAL GUIDELINE

Special connectivity is required for these cable designs. Bonding and grounding is important to prevent EMI. Refer to the "Resources" section on our site for the Technical Guideline, "OSP Broadband Installation Guidelines," for more information.

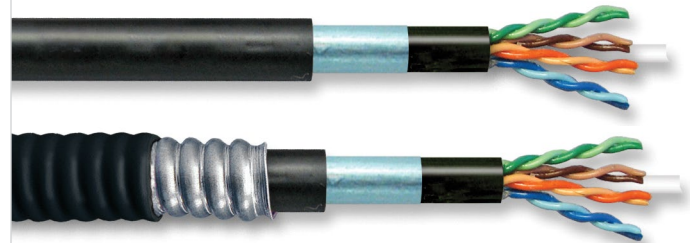

- Aluminum Interlock Armor with Sunlight and Weather Resistant Polyethylene Outer Jacket (optional)
- Solid Annealed Copper Conductor
- Polyethylene Inner Jacket
- Rip Cord
- Cross-web Separator (CAT 6/6A only)
- PFM™ Gel-filled, Water-Repellent Core
- Thermoplastic Insulation
- Aluminum Tape Shield
- Sunlight and Weather Resistant Polyethylene Outer Jacket

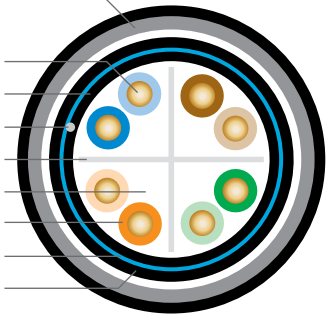

## SPECIFICATIONS

Pair Count	4
Conductor	Solid annealed copper
Insulation	Polyolefin
Separator	CAT 6A/6: Polyolefin cross-web CAT 5e: none
Inner Shield	Electrically continuous 0.008 in (0.20 mm) polymer coated smooth aluminum tape shield, applied with an overlap
Dry Water Block	SAP powder
Jacket	Black, sunlight and weather resistant polyethylene
Optional Outer Armor	Interlocked aluminum armor covered with black, sunlight and weather resistant polyethylene jacket
Characteristic Impedance Ohms	100 ± 15
Nominal Velocity of Propagation %	CAT 6A/6: 68 CAT 5e: 65
Performance Compliance	ANSI/TIA-568.2-D ANSI/ICEA S-107-704-2012 RoHS-compliant/RoHS 2-compliant REACH-compliant

## ENVIRONMENTAL SPECIFICATIONS AND TESTS

Operation	-40°F to +167°F (-40°C to +75°C)
Installation	-40°F to +140°F (-40°C to +60°C)
ANSI/ICEA S-100-685-2009 Tested down to -67°F (-55°C)	Section 7.1: -4°F (-20°C) cold bend test Section 7.2: +14°F (-10°C) cold impact test Section 7.3: -40°F (-40°C) anvil test

## PART NUMBERS AND PHYSICAL CHARACTERISTICS

Category	Part Number	Product Type	AWG (mm)	Nominal Diameter in (mm)	Approx. Weight lbs/kft (kg/km)	Package
CAT 6A	04-001-A4	FTP	23 (0.57)	0.39 (9.8)	59 (88)	1,000' Plywood reel
CAT 6	04-001-64	FTP	23 (0.57)	0.39 (9.8)	59 (88)	1,000' Plywood reel
CAT 5e	04-001-54	FTP	24 (0.51)	0.36 (9.1)	49 (73)	1,000' Plywood reel

Additional part numbers, constructions and packaging available upon request.

# EnduraGain® OSP Armored

Formerly BBDG

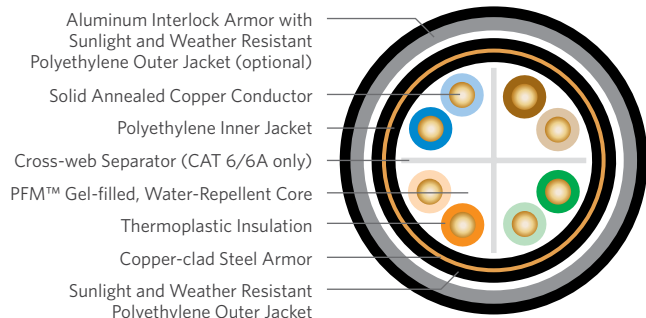

## SPECIFICATIONS

Pair Count	4
Conductor	Solid annealed copper
Insulation	Polyolefin
Separator	CAT 6A/6: Polyolefin cross-web CAT 5e: none
Inner Armor	Electrically continuous 0.005 in (0.13 mm) corrugated copper-clad steel armor, applied with an overlap
Dry Water Block	SAP yarn
Jacket	Black, sunlight and weather resistant polyethylene
Optional Outer Armor	Interlocked aluminum armor covered with black, sunlight and weather resistant polyethylene jacket
Characteristic Impedance Ohms	100 ± 15
Nominal Velocity of Propagation %	CAT 6A/6: 68 CAT 5e: 65
Performance Compliance	ANSI/TIA-568.2-D ANSI/ICEA S-107-704-2012 RoHS-compliant/RoHS 2-compliant REACH-compliant

## ENVIRONMENTAL SPECIFICATIONS AND TESTS

Operation	-40°F to +167°F (-40°C to +75°C)
Installation	-40°F to +140°F (-40°C to +60°C)
ANSI/ICEA S-100-685-2009 Tested down to -67°F (-55°C)	Section 7.1: -4°F (-20°C) cold bend test Section 7.2: +14°F (-10°C) cold impact test Section 7.3: -40°F (-40°C) anvil test

## PART NUMBERS AND PHYSICAL CHARACTERISTICS

Category	Part Number	Product Type	AWG (mm)	Nominal Diameter in (mm)	Approx. Weight lbs/kft (kg/km)	Package
CAT 6A	04-001-A5	Armored	23 (0.57)	0.39 (9.8)	72 (107)	1,000' Plywood reel
CAT 6	04-001-65	Armored	23 (0.57)	0.39 (9.8)	72 (107)	1,000' Plywood reel
CAT 5e	04-001-55	Armored	24 (0.51)	0.36 (9.1)	60 (89)	1,000' Plywood reel

Additional part numbers, constructions and packaging available upon request.

## PRODUCT DESCRIPTION

EnduraGain® OSP Armored is a robust category cable designed to provide an extension of the LAN beyond the premises or in situations where the NEC code requires an OSP-rated cable when it is in contact with earth, whether in a conduit or not. The cable consists of four (4) balanced twisted pairs surrounded by Superior Essex PFM™ gel that does not drip or flow, even in cell tower applications at elevated temperatures. The jacketed core is covered with dry block and a corrugated, copper-clad steel armor providing exceptional Alien Crosstalk (AXT) performance. The outer jacket is an OSP-grade black polyethylene for superior sunlight and abrasion resistance. This armored design is suitable for the following deployments: duct, underground conduit, tower, lashed aerial, direct burial or open trench.

EnduraGain OSP Armored is available in a variety of performances including CAT 5e, CAT 6 and CAT 6A. An optional Aluminum Interlock Armor with overjacket is also available (not suitable for tower deployment).

## APPLICATIONS

- CAT 6A: 10BASE-T through 10GBASE-T Ethernet;
- CAT 6/5e: 10BASE-T through 1000BASE-T Ethernet
- Power over Ethernet (PoE) - IEEE 802.3af
- PoE+ - IEEE 802.3at Type 1 and 2
- ATM and token ring

## FEATURES

- Transmission performance characterized to 500 MHz for CAT 6A/6 and 350 MHz for CAT 5e
- Corrugated, copper-clad steel armor
- Dry block between armor and inner jacket
- PFM gel-filled core construction
- OSP-grade black polyethylene jacket
- ColorTip® circuit identification system
- Aluminum interlock armored construction

## BENEFITS

- Assures ample overhead for reliable transmission in an OSP-rated cable allowing extension of the premises LAN
- Rugged shield provides protection against EMI/RFI and provides rodent resistance
- Prevents water ingress between armor and inner cable preventing damage to equipment
- Prevents intrusion of moisture and easily wipes clean during installation
- Outside plant rated cable for years of reliable performance
- Easily identifiable conductor mates even in low-light environments
- Protects against mechanical stresses
- Installs faster and easier than EMT conduit and conventional wire



## TECHNICAL GUIDELINE

Special connectivity is required for these cable designs. Bonding and grounding is important to prevent EMI. Refer to the "Resources" section on our site for the Technical Guideline, "OSP Broadband Installation Guidelines," for more information.



## We've Got You Covered

- Standard Product Warranty (1 Year)
- PerformaLink® Warranty (25 Years)
  - Extended Premises cable warranty
  - Covers network's permanent link
  - 25 years with Legrand/Ortronics or 20 years with other approved connectivity manufacturers
- Campus Warranty (25 Years)
  - Covers Premises and OSP cables
  - 25 years with Legrand/Ortronics or 20 years with other approved connectivity manufacturers



For copies of our warranty terms and application forms, visit [ce.SuperiorEssexCommunications.com/Resources/Warranties-and-Policies](http://ce.SuperiorEssexCommunications.com/Resources/Warranties-and-Policies)

# EnduraGain® OSP Shielded Indoor/Outdoor

Halogen-Free CM | Formerly BBDN I/O

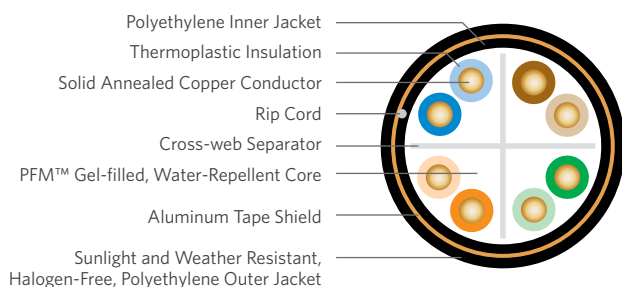
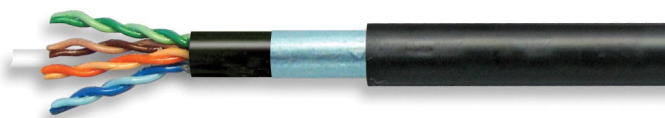

## PRODUCT DESCRIPTION

EnduraGain® OSP Shielded Indoor/Outdoor is a CM rated category cable combining Outside Plant (OSP) Broadband features with an indoor application. It is designed to provide an extension of the LAN beyond the premises or in situations where the NEC code requires an OSP-rated cable and can be used inside the building according to NEC CM rated rules. The cable consists of four (4) balanced twisted pairs surrounded by Superior Essex PFM™ gel that does not drip or flow, even in cell tower applications at elevated temperatures. The jacketed core is covered with dry block and a shield providing exceptional Alien Crosstalk (AXT) performance. The outer jacket is an OSP-grade, black, halogen-free polyethylene for superior sunlight and abrasion resistance. This shielded design is suitable for the following deployments: duct, underground conduit, tower, lashed aerial, open trench or low-risk direct burial.

EnduraGain OSP Shielded Indoor/Outdoor is available in a variety of performances including CAT 6 and CAT 6A.

## SPECIFICATIONS

Pair Count	4
Conductor	Solid annealed copper
Insulation	Polyolefin
Separator	CAT 6A/6: Polyolefin cross-web
Shield	Electrically continuous 0.008 in (0.20 mm) polymer coated smooth aluminum tape shield, applied with an overlap
Dry Water Block	SAP powder
Inner/Outer Jackets	Black, halogen-free, sunlight and weather-resistant polyethylene
Characteristic Impedance Ohms	100 ± 15
Nominal Velocity of Propagation %	CAT 6A/6: 68
Performance Compliance	ANSI/TIA-568.2-D CSA C22.2 No. 214-08 UL 444 UL 1685 UL 2556 ANSI/ICEA S-107-704-2012 RoHS-compliant/RoHS 2-compliant REACH-compliant
NRTL Programs	UL, c(UL) listed CM

## ENVIRONMENTAL SPECIFICATIONS AND TESTS

Operation	-40°F to +167°F (-40°C to +75°C)
Installation	-40°F to +140°F (-40°C to +60°C)
ANSI/ICEA S-100-685-2009	Section 7.1: -4°F (-20°C) cold bend test Section 7.2: +14°F (-10°C) cold impact test Section 7.3: -40°F (-40°C) anvil test

## APPLICATIONS

- CAT 6A: 10BASE-T through 10GBASE-T Ethernet;
- CAT 6: 10BASE-T through 1000BASE-T
- Power over Ethernet (PoE) - IEEE 802.3af
- PoE+ - IEEE 802.3at Type 1 and 2
- ATM and token ring

## FEATURES

- Transmission performance characterized to 500 MHz
- Shield
- Dry block between shield and inner jacket
- PFM gel-filled core construction
- OSP-grade black polyethylene jacket
- UL® CM listed

## BENEFITS

- Assures ample overhead for reliable transmission in an OSP-rated cable allowing extension of the premises LAN
- Rugged shield provides protection against EMI/RFI and provides rodent resistance
- Prevents water ingress between shield and inner cable preventing damage to equipment
- Prevents intrusion of moisture and easily wipes clean during installation
- Outside plant rated cable for years of reliable performance
- Allows for CM specific application
- Ideal for indoor/outdoor deployment



## TECHNICAL GUIDELINE

*Special connectivity is required for these cable designs. Bonding and grounding is important to prevent EMI. Refer to the "Resources" section on our site for the Technical Guideline, "OSP Broadband Installation Guidelines," for more information.*

## PART NUMBERS AND PHYSICAL CHARACTERISTICS

Category	Part Number	Product Type	AWG (mm)	Nominal Diameter in (mm)	Approx. Weight lbs/kft (kg/km)	Package
CAT 6A	04-001-A2	FTP	23 (0.57)	0.39 (9.8)	84 (125)	1,000' Plywood reel
CAT 6	04-001-62	FTP	23 (0.57)	0.39 (9.8)	84 (125)	1,000' Plywood reel

Additional part numbers, constructions and packaging available upon request. UL is a registered trademark of UL LLC.



# EnduraGain® OSP Armored Indoor/Outdoor

Halogen-Free CM | Formerly BBDG I/O

## PRODUCT DESCRIPTION

EnduraGain® OSP Armored Indoor/Outdoor is a CM rated category cable combining Outside Plant (OSP) Broadband features with an indoor application. It is designed to provide an extension of the LAN beyond the premises or in situations where the NEC code requires an OSP-rated cable and can be used inside the building according to NEC CM rated rules. The cable consists of four (4) balanced twisted pairs surrounded by Superior Essex PFM™ gel that does not drip or flow, even in cell tower applications at elevated temperatures. The jacketed core is covered with dry block and a shield providing exceptional Alien Crosstalk (AXT) performance. The outer jacket is an OSP-grade, black, halogen-free polyethylene for superior sunlight and abrasion resistance. This shielded design is suitable for the following deployments: duct, underground conduit, tower, lashed aerial, open trench or low-risk direct burial.

EnduraGain OSP Armored Indoor/Outdoor is available in a variety of performances including CAT 6 and CAT 6A.

## APPLICATIONS

- CAT 6A: 10BASE-T through 10GBASE-T Ethernet; CAT 6: 10BASE-T through 1000BASE-T
- Power over Ethernet (PoE) - IEEE 802.3af
- PoE+ - IEEE 802.3at Type 1 and 2
- ATM and token ring

## FEATURES

- Transmission performance characterized to 500 MHz
- Corrugated, copper-clad steel armor
- Dry block between armor and inner jacket
- PFM gel-filled core construction
- OSP-grade black polyethylene jacket
- UL® CM listed

## BENEFITS

- Assures ample overhead for reliable transmission in an OSP-rated cable allowing extension of the premises LAN
- Rugged armor provides protection against EMI/RFI and provides rodent resistance
- Prevents water ingress between shield/armor and inner cable preventing damage to equipment
- Prevents intrusion of moisture and easily wipes clean during installation
- Outside plant rated cable for years of reliable performance
- Allows for CM specific application
- Ideal for indoor/outdoor deployment



## TECHNICAL GUIDELINE

Special connectivity is required for these cable designs. Bonding and grounding is important to prevent EMI. Refer to the "Resources" section on our site for the Technical Guideline, "OSP Broadband Installation Guidelines," for more information.

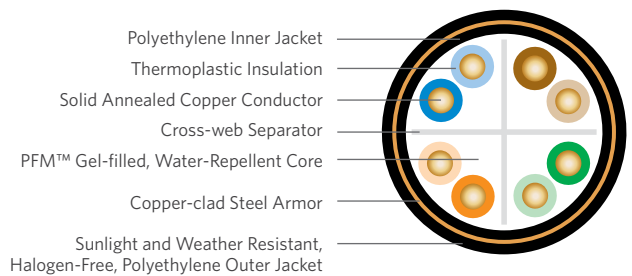

## SPECIFICATIONS

Pair Count	4
Conductor	Solid annealed copper
Insulation	Polyolefin
Separator	CAT 6A/6: Polyolefin cross-web
Armor	Electrically continuous 0.005 in (0.13 mm) corrugated copper-clad steel armor, applied with an overlap
Dry Water Block	SAP yarn
Inner/Outer Jackets	Black, halogen-free, sunlight and weather-resistant polyethylene
Characteristic Impedance Ohms	100 ± 15
Nominal Velocity of Propagation %	CAT 6A/6: 68
Performance Compliance	ANSI/TIA-568.2-D CSA C22.2 No. 214-08 UL 444 UL 1685 UL 2556 ANSI/ICEA S-107-704-2012 RoHS-compliant/RoHS 2-compliant REACH-compliant
NRTL Programs	UL, c(UL) listed CM

## ENVIRONMENTAL SPECIFICATIONS AND TESTS

Operation	-40°F to +167°F (-40°C to +75°C)
Installation	-40°F to +140°F (-40°C to +60°C)
ANSI/ICEA S-100-685-2009	Section 7.1: -4°F (-20°C) cold bend test Section 7.2: +14°F (-10°C) cold impact test Section 7.3: -40°F (-40°C) anvil test

## PART NUMBERS AND PHYSICAL CHARACTERISTICS

Category	Part Number	Product Type	AWG (mm)	Nominal Diameter in (mm)	Approx. Weight lbs/kft (kg/km)	Package
CAT 6A	04-001-A3	Armored	23 (0.57)	0.39 (9.8)	91 (136)	1,000' Plywood reel
CAT 6	04-001-63	Armored	23 (0.57)	0.39 (9.8)	91 (136)	1,000' Plywood reel

Additional part numbers, constructions and packaging available upon request. UL is a registered trademark of UL LLC.

# EnduraGain® OSP Duplex

Formerly OSP Broadband Duplex

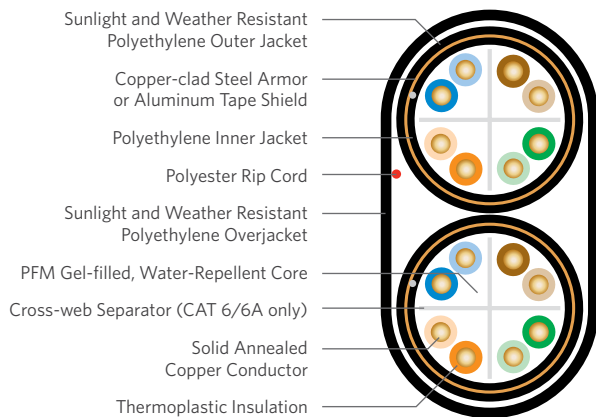
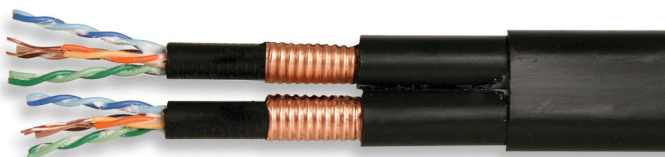

## SPECIFICATIONS

Pair Count	4
Conductor	Solid annealed copper
Insulation	Polyolefin
Separator	CAT 6A/6: Polyolefin cross-web CAT 5e: none
Shield/Armor	Armored: Electrically continuous 0.005 in (0.13 mm) corrugated copper-clad steel armor, applied with an overlap FTP: Electrically continuous 0.008 in (0.20 mm) polymer coated smooth aluminum tape shield, applied with an overlap
Dry Water Block	Armored: SAP yarn FTP: SAP powder
Inner Jacket/Outer Jacket/Overjacket	Black, sunlight and weather-resistant polyethylene
Characteristic Impedance Ohms	100 ± 15
Nominal Velocity of Propagation %	CAT 6A/6: 68 CAT 5e: 65
Performance Compliance	ANSI/TIA-568.2-D ANSI/ICEA S-107-704-2012 RoHS-compliant/RoHS 2-compliant REACH-compliant

## ENVIRONMENTAL SPECIFICATIONS AND TESTS

Operation	-40°F to +167°F (-40°C to +75°C)
Installation	-40°F to +140°F (-40°C to +60°C)
ANSI/ICEA S-100-685-2009	Section 7.1: -4°F (-20°C) cold bend test Section 7.2: +14°F (-10°C) cold impact test Section 7.3: -40°F (-40°C) anvil test

## PART NUMBERS AND PHYSICAL CHARACTERISTICS

Category	Part Number	Product Type	AWG (mm)	Dimensions		Approx. Weight lbs/kft (kg/km)	Package
				Minor in (mm)	Major in (mm)		
CAT 5e	04-A01-55	Armored	24 (0.51)	0.44 (11.2)	0.76 (19.3)	148 (221)	1,000' Plywood reel

Additional part numbers, constructions and packaging available upon request.

## PRODUCT DESCRIPTION

EnduraGain® OSP Duplex is a robust category cable designed to provide an extension of the LAN beyond the premises or in situations where the NEC code requires an OSP-rated cable when it is in contact with earth, whether in a conduit or not. The cable consists of a core of four balanced twisted pairs surrounded by Superior Essex PFM™ gel that does not drip or flow, even in cell tower applications at elevated temperatures. The jacketed core is covered with dry block and a shield providing exceptional Alien Crosstalk (AXT) performance. Two cores are then jacketed together under a sunlight and abrasion-resistant black, polyethylene overjacket including an aramid rip cord. This feature reduces installation and lease costs in tower application. This shielded design is suitable for the following deployments: duct, underground conduit, tower, lashed aerial, open trench or direct burial.

EnduraGain OSP Duplex is available in a variety of performances including CAT 5e, CAT 6 and CAT 6A. It is also available in Armored (copper-clad steel armor) and FTP (aluminum tape shield; not suitable for direct burial deployment) constructions.

## APPLICATIONS

- CAT 6A: 10BASE-T through 10GBASE-T Ethernet;
- CAT 6/5e: 10BASE-T through 1000BASE-T
- Power over Ethernet (PoE) - IEEE 802.3af
- PoE+ - IEEE 802.3at Type 1 and 2
- ATM and token ring

## FEATURES

- Transmission performance characterized to 500 MHz for CAT 6A/6 and 350 MHz for CAT 5e
- Corrugated, copper-clad steel armor
- Shield/armor
- Dry block between shield/armor and inner jacket
- PFM gel-filled core construction
- OSP-grade black polyethylene jacket
- ColorTip™ circuit identification system

## BENEFITS

- Assures ample overhead for reliable transmission in an OSP-rated cable allowing extension of the premises LAN
- Rugged shield provides protection against EMI/RFI and provides rodent resistance
- Rugged shield provides protection against EMI/RFI and provides rodent resistance (Armored only)
- Prevents water ingress between shield in inner cable preventing damage to equipment
- Prevents intrusion of moisture and easily wipes clean during installation
- Outside plant rated cable for years of reliable performance
- Easily identifiable conductor mates even in low-light environments



## TECHNICAL GUIDELINE

Special connectivity is required for these cable designs. Bonding and grounding is important to prevent EMI. Refer to the "Resources" section on our site for the Technical Guideline, "OSP Broadband Installation Guidelines," for more information.

# MEGAPIC® OSP Broadband Backbone Category 5

## PRODUCT DESCRIPTION

MEGAPIC® Category 5 cables provide an extension of the LAN beyond the premises. These cables are ideal for direct burial, underground and lashed aerial applications.

## APPLICATIONS

- 10BASE-T
- ATM and token ring
- ADSL, VDSL, VDSL+
- MEGAPIC-NF: Higher pair count shielded distribution cable for use in lashed aerial, direct burial and duct installations
- MEGAPIC-GF: Higher pair count shielded distribution cable for use in lashed aerial, direct burial and installations in high risk areas where additional mechanical protection is required

## FEATURES

- Transmission performance characterized to 100 MHz
- Metallic shield tapes
- Fully filled constructions

## BENEFITS

- Extends the LAN to the entire campus
- Facilitates grounding according to NEC requirements
- Helps prevent intrusion of moisture

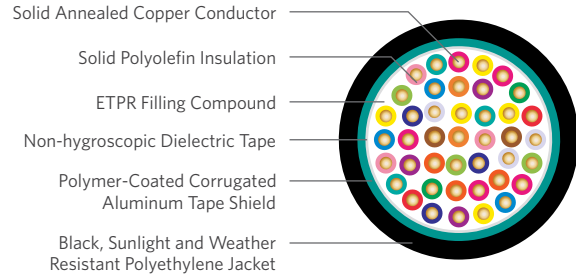

## SPECIFICATIONS

Pair Count	Available in 12-pair, 25-pair, 50-pair and 100-pair
Conductor	Solid annealed copper
AWG (mm)	24 (0.51)
Filling Compound	80°C ETPR (extended thermoplastic rubber)
Core Wrap	Non-hygroscopic dielectric tape
Shield	MEGAPIC-NF: Electrically continuous 0.008 in (0.20 mm) polymer coated corrugated aluminum tape, applied with an overlap and shield interface is flooded MEGAPIC-GF: ASP sheath consisting of an inner electrically continuous 0.008 in (0.20 mm) polymer coated corrugated aluminum tape applied with a gap and covered with an outer electrically continuous 0.006 in (0.15 mm) polymer coated corrugated steel tape applied with an overlap; interfaces of both tapes are flooded
Jacket	Black, sunlight and weather resistant polyethylene
Characteristic Impedance Ohms	100 ± 15
Nominal Velocity of Propagation %	58
Performance Compliance	ANSI/TIA-568.2-D ANSI/ICEA S-84-608-2012 RoHS-compliant/RoHS 2-compliant

## PART NUMBERS AND PHYSICAL CHARACTERISTICS

Part Number	Name	Pair Count	Nominal Diameter in (mm)	Approx. Weight lbs/kft (kg/km)	Standard Length ft (m)	Package
04-094-31	MEGAPIC-NF	12	0.52 (13.2)	120 (179)	10,000 (3,048)	Wood reel
04-097-31	MEGAPIC-NF	25	0.70 (17.8)	208 (310)	5,000 (1,524)	Wood reel
04-100-31	MEGAPIC-NF	50	0.92 (23.4)	388 (578)	5,000 (1,524)	Wood reel
04-104-31	MEGAPIC-NF	100	1.28 (32.5)	701 (1,044)	1,000 (305)	Wood reel
04-097-37	MEGAPIC-GF	25	0.71 (18.0)	258 (385)	5,000 (1,524)	Wood reel
04-100-37	MEGAPIC-GF	50	0.98 (24.9)	436 (650)	5,000 (1,524)	Wood reel
04-104-37	MEGAPIC-GF	100	1.33 (33.8)	807 (1,202)	1,000 (305)	Wood reel



## TECHNICAL GUIDELINE

Special connectivity is required for these cable designs. Refer to the "Resources" section on our site for the Technical Guideline, "OSP Broadband Installation Guidelines," for more information.

# Category 3

CMR/CMP 2-Pair - 400-Pair

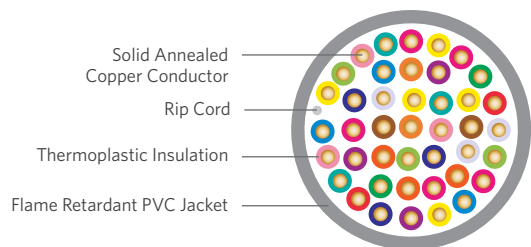

## SPECIFICATIONS

Pair Count	Available in 2-pair up to 400-pair
Conductor	Solid annealed copper
AWG (mm)	24 (0.51)
Insulation	Thermoplastic
Jacket	CMR: Flame retardant (FR) PVC CMP: FR, low smoke PVC
Characteristic Impedance Ohms	100 ± 15
Performance Compliance	UL® 444 CSA C22.2 No. 214-08 UL 1666 NFPA 262 ANSI/TIA-568.2-D ANSI/ICEA S-90-661-2012 Article 800, NEC (NFPA 70) RoHS-compliant/RoHS 2-compliant
NRTL Programs	UL, c(UL) Listed CMR UL, c(UL) Listed CMP

## PRODUCT DESCRIPTION

The ideal choice for LAN transmission with specified bandwidth up to 16 MHz. These cables are used for voice and data communications and can handle application bandwidths up to 16 MHz. Other uses for these cables include indoor use on customer premises for the interconnection of telephone key systems, PBX and intercom systems. Product is offered for both plenum (CMP) and riser (CMR) applications.

## APPLICATIONS

- 4 Mbps token ring (IEEE 802.5)
- Analog voice
- 10 Mbps 10BASE-T Ethernet (IEEE 802.3)
- Telecommunications closet wiring

## FEATURES

- CMR and CMP constructions use extremely flexible, FR-PVC jacket
- Jacket color options
- Band marked or striped insulated conductors

## BENEFITS

- Easier and less time-consuming installations, no kinking of outer jacket
- Improves backbone sub-system identification, reduces labor and mistakes
- Reduces termination time and improves circuit identification

**PART NUMBERS AND PHYSICAL CHARACTERISTICS**

Listing	Part Number	Pair Count	Jacket Color	Nominal Diameter in (mm)	Approx. Weight lbs/kft (kg/km)	Package	Packages per Pallet
CMR	18-042-13	2	Beige	0.12 (3.1)	9 (13)	1,000' POP™ box	45
CMR	18-042-33	2	Gray	0.12 (3.1)	9 (13)	1,000' POP box	45
CMR	18-141-13	3	Beige	0.14 (3.5)	12 (18)	1,000' POP box	45
CMR	18-141-33	3	Gray	0.14 (3.5)	12 (18)	1,000' POP box	45
CMR	18-241-13	4	Beige	0.16 (3.9)	15 (22)	1,000' POP box	45
CMR	18-241-23	4	Blue	0.16 (3.9)	15 (22)	1,000' POP box	45
CMR	18-241-33	4	Gray	0.16 (3.9)	15 (22)	1,000' POP box	45
CMR	18-241-43	4	White	0.16 (3.9)	15 (22)	1,000' POP box	45
CMR	18-341-13	6	Beige	0.19 (4.8)	22 (32)	1,000' POP box	45
CMR	18-341-33	6	Gray	0.19 (4.8)	22 (32)	1,000' POP box	45
CMR	18-872-13	12	Beige	0.27 (6.9)	47 (71)	1,000' Plywood reel	16
CMR	18-872-33	12	Gray	0.27 (6.9)	47 (71)	1,000' Plywood reel	16
CMR	18-475-13	25	Beige	0.38 (9.6)	92 (137)	1,000' Plywood reel	12
CMR	18-499-13	25	Beige	0.38 (9.6)	92 (137)	Cut to length	1
CMR	18-475-33	25	Gray	0.38 (9.6)	92 (137)	1,000' Plywood reel	12
CMR	18-499-33	25	Gray	0.38 (9.6)	92 (137)	Cut to length	1
CMR	18-579-13	50	Beige	0.56 (14.2)	187 (279)	1,000' Plywood reel	4
CMR	18-599-13	50	Beige	0.56 (14.2)	187 (279)	Cut to length	1
CMR	18-579-33	50	Gray	0.56 (14.2)	187 (279)	1,000' Plywood reel	4
CMR	18-599-33	50	Gray	0.56 (14.2)	187 (279)	Cut to length	1
CMR	18-789-13	100	Beige	0.74 (18.7)	361 (538)	Cut to length	1
CMR	18-789-33	100	Gray	0.74 (18.7)	361 (538)	Cut to length	1
CMR	18-D99-33	150	Gray	0.92 (23.4)	541 (807)	Cut to length	1
CMR	18-A99-33	200	Gray	1.05 (26.6)	711 (1,060)	Cut to length	1
CMR	18-B99-33	300	Gray	1.27 (32.2)	1,049 (1,564)	Cut to length	1
CMR	18-C99-33	400	Gray	1.45 (36.9)	1,386 (2,067)	Cut to length	1
CMP	18-041-36	2	Gray	0.13 (3.3)	10 (15)	1,000' POP box	45
CMP	18-141-36	3	Gray	0.15 (3.7)	14 (20)	1,000' POP box	45
CMP	18-241-26	4	Blue	0.16 (4.2)	17 (26)	1,000' POP box	45
CMP	18-241-36	4	Gray	0.16 (4.2)	17 (26)	1,000' POP box	45
CMP	18-241-46	4	White	0.16 (4.2)	17 (26)	1,000' POP box	45
CMP	18-241-56	4	Green	0.16 (4.2)	17 (26)	1,000' POP box	45
CMP	18-341-36	6	Gray	0.20 (5.0)	24 (37)	1,000' POP box	45
CMP	18-341-46	6	White	0.20 (5.0)	24 (37)	1,000' POP box	45
CMP	18-872-46	12	White	0.30 (7.6)	49 (73)	1,000' Plywood reel	16
CMP	18-475-36	25	Gray	0.43 (10.9)	114 (171)	1,000' Plywood reel	12
CMP	18-499-36	25	Gray	0.43 (10.9)	114 (171)	Cut to length	1
CMP	18-475-46	25	White	0.43 (10.9)	114 (171)	1,000' Plywood reel	12
CMP	18-499-46	25	White	0.43 (10.9)	114 (171)	Cut to length	1
CMP	18-579-36	50	Gray	0.60 (15.3)	227 (339)	1,000' Plywood reel	4
CMP	18-599-36	50	Gray	0.60 (15.3)	227 (339)	Cut to length	1
CMP	18-599-46	50	White	0.60 (15.3)	227 (339)	Cut to length	1
CMP	18-799-36	100	Gray	0.84 (21.3)	446 (665)	Cut to length	1
CMP	18-799-46	100	White	0.84 (21.3)	446 (666)	Cut to length	1
CMP	18-A99-36	200	Gray	1.16 (29.4)	850 (1,268)	Cut to length	1
CMP	18-B99-36	300	Gray	1.44 (36.7)	1,315 (1,960)	Cut to length	1
CMP	18-B99-46	300	White	1.44 (36.7)	1,315 (1,961)	Cut to length	1
CMP	18-C99-36	400	Gray	1.64 (41.7)	1,720 (2,565)	Cut to length	1

UL is a registered trademark of UL LLC.

# Category 3 Station Wire

CMR/CMX Outdoor

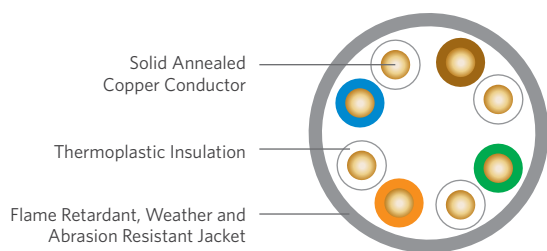

## SPECIFICATIONS

Pair Count	Available in 2-pair to 12-pair
Conductor	Solid annealed copper
AWG (mm)	Available in 22 (0.64) and 24 (0.51)
Insulation	Thermoplastic
Jacket	Tough, flame retardant, weather and abrasion resistant PVC
Performance Compliance	UL 444 CSA C22.2 No. 214-08 UL 1666 Extreme CMR/CMX Outdoor Includes ICEA -40°C Anvil Test ANSI/TIA-568.2-D ANSI/ICEA S-100-685 Article 800, NEC (NFPA 70) RoHS-compliant/RoHS 2-compliant
NRTL Programs	UL, c(UL) Listed CMR UL, c(UL) Listed CMX Outdoor

## ENVIRONMENTAL SPECIFICATIONS AND TESTS

Operation	CMR/CMX Outdoor: -4°F to +149°F (-20°C to +65°C) Extreme CMR/CMX Outdoor: -40°F to +167°F (-40°C to +75°C)
Installation	+14°F to +140°F (-10°C to +60°C)
ANSI/ICEA S-100-685-2009	CMR/CMX Outdoor: Section 7.1: -4°F (-20°C) cold bend test Section 7.2: +14°F (-10°C) cold impact test Extreme CMR/CMX Outdoor: Section 7.1: -4°F (-20°C) cold bend test Section 7.2: +14°F (-10°C) cold impact test Section 7.3: -40°F (-40°C) anvil test

## PRODUCT DESCRIPTION

The Superior Essex Category 3 Station Wires CMR/CMX Outdoor cable is specifically designed for outdoor, indoor, or a combination of both applications. CMX Outdoor cables extend the run between the Network Interface Unit and the point of entry into the interior of a residence or a premise. Their twisted pair construction is small and lightweight.

These Category 3 (CAT 3) cables have been tested and listed as UL® 444 Outdoor compliant, requiring the cable to resist 300 hours of UV and heat. In addition, the CMR listing allows the cable to be used in riser spaces per UL 1666, eliminating the need to transition to fire resistant cables. UV-blocking compounds also aid in protecting the cable from light.

Two levels of Outdoor Protection are available: CMR/CMX Outdoor and Extreme CMR/CMX Outdoor which meets the -40°C anvil test.

## APPLICATIONS

- 4 Mbps token ring (IEEE 802.5)
- Analog voice
- 10 Mbps 10BASE-T Ethernet (IEEE 802.3)
- Telecommunications closet wiring

## FEATURES

- Extremely flexible, FR-PVC jacket
- CMR/CMX Outdoor combination
- Extreme CMR/CMX Outdoor combination
- Beige, gray and ivory jacket colors
- Various conductor colors

## BENEFITS

- Easier and less time-consuming installations, no kinking of outer jacket
- Indoor/outdoor use
- Indoor/outdoor use with extreme cold temperature feature
- Enhances appearance on outdoor siding
- Customer preference



## CAUTIONARY INFORMATION

- Do not use as a substitute for Outside Plant (OSP) cables.
- Do not use in conduit or direct burial which can flood. These cables are not designed for extended exposure to water.

**PART NUMBERS AND PHYSICAL CHARACTERISTICS**

Listing	Part Number	Pair Count	AWG (mm)	Jacket Color	Nominal Diameter in (mm)	Approx. Weight lbs/kft (kg/km)	Package	Packages per Pallet
CMR/CMX Outdoor	12-202-37 <sup>1</sup>	2	22 (0.64)	Beige	0.18 (4.7)	17 (26)	1,000' POP™ box	45
CMR/CMX Outdoor	12-203-37 <sup>1</sup>	3	22 (0.64)	Beige	0.22 (5.5)	24 (36)	1,000' POP box	45
CMR/CMX Outdoor	12-204-37 <sup>1</sup>	4	22 (0.64)	Beige	0.22 (5.6)	29 (43)	1,000' POP box	36
CMR/CMX Outdoor	12-214-37 <sup>1</sup>	4	22 (0.64)	Gray	0.22 (5.6)	29 (43)	1,000' POP box	36
CMR/CMX Outdoor	12-402-37 <sup>1</sup>	2	24 (0.51)	Beige	0.15 (3.7)	12 (18)	1,000' POP box	45
CMR/CMX Outdoor	12-403-37 <sup>1</sup>	3	24 (0.51)	Beige	0.17 (4.3)	16 (24)	1,000' POP box	45
CMR/CMX Outdoor	12-404-37 <sup>1</sup>	4	24 (0.51)	Beige	0.20 (5.0)	20 (30)	1,000' POP box	45
CMR/CMX Outdoor	12-212-32 <sup>2</sup>	2	22 (0.64)	Beige	0.18 (4.7)	17 (26)	1,000' POP box	45
CMR/CMX Outdoor	12-213-32 <sup>2</sup>	3	22 (0.64)	Beige	0.22 (5.5)	24 (36)	1,000' POP box	45
CMR/CMX Outdoor	12-206-32 <sup>2</sup>	4	22 (0.64)	Beige	0.22 (5.6)	29 (43)	1,000' POP box	45
CMR/CMX Outdoor	12-412-32 <sup>2</sup>	2	24 (0.51)	Beige	0.15 (3.7)	12 (18)	1,000' POP box	45
CMR/CMX Outdoor	12-414-32 <sup>2</sup>	4	24 (0.51)	Beige	0.20 (5.0)	20 (30)	1,000' POP box	45
Extreme CMR/CMX Outdoor	11-002-89 <sup>3</sup>	2	22 (0.64)	Gray	0.17 (4.3)	19 (29)	125' Coil pack	128
Extreme CMR/CMX Outdoor	11-002-88 <sup>3</sup>	2	22 (0.64)	Ivory	0.17 (4.3)	19 (29)	125' Coil pack	256
Extreme CMR/CMX Outdoor	11-002-87 <sup>3</sup>	2	22 (0.64)	Ivory	0.17 (4.3)	19 (29)	1,000' POP box	45
Extreme CMR/CMX Outdoor	11-003-12 <sup>3</sup>	2	24 (0.51)	Ivory	0.15 (3.7)	12 (18)	1,000' POP box	45
Extreme CMR/CMX Outdoor	11-003-13 <sup>3</sup>	2	24 (0.51)	Gray	0.15 (3.7)	12 (18)	1,000' POP box	45
Extreme CMR/CMX Outdoor	11-003-91 <sup>3</sup>	4	24 (0.51)	White	0.20 (5.0)	20 (30)	1,000' POP box	45
Extreme CMR/CMX Outdoor	11-003-92 <sup>3</sup>	4	24 (0.51)	Ivory	0.20 (5.0)	20 (30)	1,000' POP box	45
Extreme CMR/CMX Outdoor	12-303-62 <sup>3*</sup>	6	24 (0.51)	Gray	0.21 (5.3)	27 (41)	1,000' POP box	36
Extreme CMR/CMX Outdoor	12-805-62 <sup>3*</sup>	12	24 (0.51)	Gray	0.28 (7.2)	49 (74)	1,000' Plywood reel	16
Extreme CMR/CMX Outdoor	12-414-52 <sup>4</sup>	3	22 (0.64)	Beige	0.22 (5.5)	24 (36)	1,000' POP box	45
Extreme CMR/CMX Outdoor	12-415-52 <sup>4</sup>	2	24 (0.51)	Beige	0.15 (3.7)	12 (18)	1,000' POP box	45
Extreme CMR/CMX Outdoor	12-416-52 <sup>4</sup>	3	24 (0.51)	Beige	0.17 (4.3)	16 (24)	1,000' POP box	45
Extreme CMR/CMX Outdoor	12-417-52 <sup>4</sup>	4	24 (0.51)	Beige	0.20 (5.0)	20 (30)	1,000' POP box	45

<sup>1</sup>These products use a tubed jacket design with the following color code: Blue/White, Orange/White, Green/White, Brown/White.

<sup>2</sup>These products use a tubed jacket design with the following color code: Red/Green, Yellow/Black, Blue/White, Orange/Brown.

<sup>3</sup>These products use a tubed jacket design with the following color code: Blue/White, Orange/White, Green/White and Brown/White. 2-pair 22 AWG products are a pressure extruded design.

<sup>3\*</sup>Copper conductors are PVC insulated.

<sup>4</sup>These products use a tubed jacket design with the following color code: Red/Green, Yellow/Black, Blue/White, Orange/Brown.

UL is a registered trademark of UL LLC.

# ARMM Series

## CMR

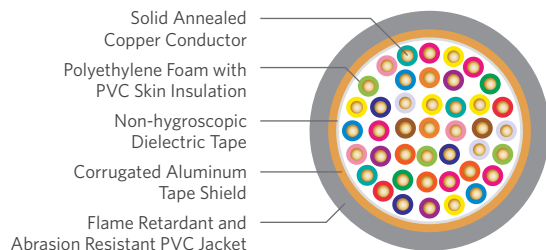
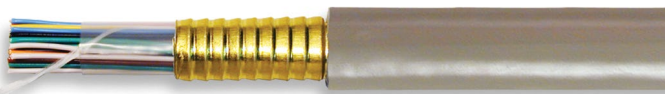

### SPECIFICATIONS

Pair Count	Available in 25-pair up to 2,400-pair
Conductor	Solid annealed copper
AWG (mm)	24 (0.51)
Insulation	Polyethylene foam with PVC skin
Shield	Corrugated 8 mil aluminum tape
Jacket	Gray, flame retardant and abrasion resistant PVC
Characteristic Impedance Ohms	100 ± 15
Nominal Velocity of Propagation %	71
Performance Compliance	UL® 444 CSA C22.2 No. 214-08 UL 1666 Telcordia® GR-111 ANSI/TIA-568.2-D Article 800, NEC (NFPA 70) RoHS-compliant/RoHS 2-compliant
NRTL Programs	UL, c(UL) Listed CMR

### PRODUCT DESCRIPTION

The ARMM Series cables are intended for vertical and horizontal distribution in commercial buildings and meet Category 3 electrical specifications. This includes all applications except those in plenums. These cables have a fire-retardant PVC jacket and have been listed as CMR rated, in accordance with the National Electrical Code. ARMM cables are color coded to match standard Outside Plant (OSP) cable designs. The cable consists of solid soft bare copper that's insulated with foam polyethylene and a skin of PVC. Cores through 900-pair are color coded to match the standard PIC color code. Cables 1,200-pair and larger have a "Mirror Image" color code. Spare pairs are offered in cables of 1,200-pair and larger. An alvyn sheath is applied overall. The alvyn sheath consists of a 8 mil aluminum tape applied longitudinally and bonded to a gray PVC outer jacket.

### APPLICATIONS

- Riser shafts without using conduits
- 4 Mbps token ring
- Analog voice
- 10BASE-T Ethernet

### FEATURES

- CMR rating
- Shielded design

### BENEFITS

- Meets NFPA code for riser applications
- Provides EMI/RFI shielding

### PART NUMBERS AND PHYSICAL CHARACTERISTICS

Listing	Part Number	Pair Count	Nominal Diameter in (mm)	Approx. Weight lbs/kft (kg/km)	Package
CMR	02-097-03	25	0.51 (13)	146 (218)	Cut to length
CMR	02-100-03	50	0.64 (16)	241 (360)	Cut to length
CMR	02-104-03	100	0.89 (23)	447 (667)	Cut to length
CMR	02-106-03	150	1.02 (26)	618 (922)	Cut to length
CMR	02-108-03	200	1.14 (29)	788 (1,175)	Cut to length
CMR	02-110-03	300	1.35 (34)	1,129 (1,684)	Cut to length
CMR	02-112-03	400	1.53 (39)	1,427 (2,128)	Cut to length
CMR	02-116-03	600	1.85 (47)	2,106 (3,140)	Cut to length
CMR	02-118-03	900	2.20 (56)	3,060 (4,563)	Cut to length
CMR	02-120-03	1,200	2.50 (63)	4,008 (5,977)	Cut to length
CMR	02-121-03	1,500	2.80 (71)	5,013 (7,476)	Cut to length
CMR	02-124-03	1,800	3.05 (77)	5,958 (8,884)	Cut to length
CMR	02-125-03	2,100	3.30 (84)	6,908 (10,302)	Cut to length
CMR	02-126-03	2,400	3.52 (89)	7,852 (11,709)	Cut to length

UL is a registered trademark of UL LLC.





# Save Time, Save Money

Superior Essex Offers Multiple Product Features  
To Make Your Next Cable Installation Run More Smoothly

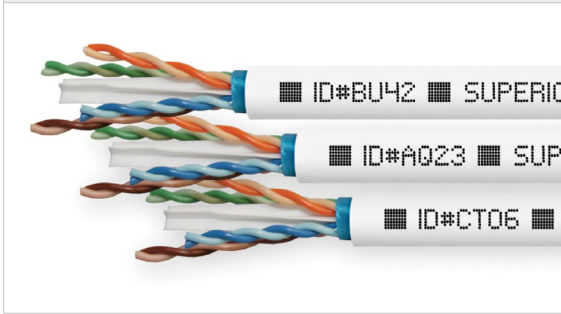

## CABLEID® ALPHA NUMERIC CODING

- Unique 4-character code printed every 2 feet on the cable jacket for each 1000-foot box and reel of copper data cable
- Both ends of each cable run are easily identifiable without the need to separately label or tone the cable
- Reduces installation time and cost for initial installations and for moves, adds and changes



## COLORTIP® CIRCUIT IDENTIFICATION

- Circumferentially colors 100% of the conductor for easily identifiable tip and ring mates
- Distinct colors reduces termination time and errors, even in low light environments
- Permanent, heavy-metal-free color that doesn't rub or wear off



## QUICKCOUNT® FEET/METERS MARKING

- Jacket marking in feet and meters
- Provides remaining length of cable on reel removing the guesswork for cable installers
- Saves time and cost during installation



## BRAKEBOX® PAYOUT CONTROL

The BrakeBox packaging is a true advantage for installers who are pulling cable in multiple locations.

- Stacks, travels and protects cable better than an open reel
- Two resistance mechanisms on both sides of the box, each with three variable resistance settings
- Controls back-tension to prevent over-spin and tangling

# Coax RG-11, Quad Shield

CMR, CMP

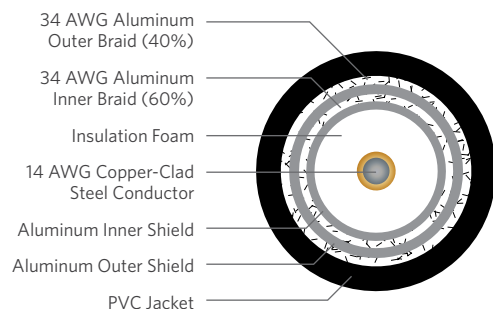

## SPECIFICATIONS

Conductor	Copper clad steel
AWG (mm)	14 (1.62)
Inner Shield	Aluminum/Poly Tape
Inner Braid	34 AWG aluminum (60%)
Outer Shield	Aluminum/Poly Tape
Outer Braid	34 AWG aluminum (40%)
Insulation	CMR: Foam PE CMP: FEP
Jacket	PVC (polyvinyl chloride)
Nominal Impedance Ohms	75
Nominal Velocity of Propagation %	CMR: 84 CMP: 84
Performance Compliance	UL® 13 UL 444 CSA C22.2 No. 214-08 UL 1685 UL 1666 NFPA 262 RoHS-compliant/RoHS 2-compliant
NRTL Programs	UL, c(UL) Listed CMR UL, c(UL) Listed CMP

UL is a registered trademark of UL LLC.

## PRODUCT DESCRIPTION

Superior Essex RG-11, Quad Shield coaxial cables are designed to support technologies such as extended bandwidth satellite service, high definition TV signals, CATV and two-way cable modems. Superior Essex maintains tight tolerances to cable diameter requirements of leading connector manufacturers.

## APPLICATIONS

- HDTV, CATV
- Two-way cable modems
- Extended bandwidth satellite service

## FEATURES

- RG-11, Quad Shield Coaxial cable with bandwidth that exceeds 3 GHz
- Tight foamed polyethylene (CM and CMR) or fluoropolymer (CMP) insulating skin bonds around center conductor
- Black and white jacket colors available for CMR and CMP versions
- Interlock armored version

## BENEFITS

- "Future-proofing" the installation. Supports extended bandwidth satellite service and high-definition TV signals
- Exhibits better transmission characteristics
- Helps differentiate incoming service versus internal cabling infrastructure
- Provides additional mechanical and fire safety protection

## PART NUMBERS AND PHYSICAL CHARACTERISTICS

Listing	Part Number	Component Jacket Color	Nominal Diameter			Approx. Weight lbs/kft (kg/km)	Package	Packages per Pallet
			Overall in (mm)	Dielectric in (mm)	Shield in (mm)			
CMR	79-348-91	Black	0.41 (10.3)	0.28 (7.11)	0.33 (8.6)	56 (85)	1,000' Plywood reel	24
CMR	78-348-91	White	0.41 (10.3)	0.28 (7.11)	0.33 (8.6)	56 (85)	1,000' Plywood reel	24
CMP	78-34C-91	White	0.37 (9.6)	0.28 (7.11)	0.33 (8.6)	67 (100)	1,000' Plywood reel	36

ELECTRICAL SPECIFICATIONS			ELECTRICAL SPECIFICATIONS		
CMR			CMP/CL2P		
Frequency MHz	Attenuation Maximum		Frequency MHz	Attenuation, Nominal	
	Specification dB/100 ft (dB/100 m)	SRL, Typical dB		Specification dB/100 ft (dB/100 m)	SRL, Nominal dB
5	0.38 (1.25)	20	1	0.25 (0.82)	20
55	0.96 (3.15)	20	10	0.80 (2.62)	20
211	2.13 (6.99)	20	50	1.20 (3.93)	20
350	2.42 (7.94)		100	1.70 (5.57)	20
550	3.04 (9.97)		200	2.50 (8.20)	20
750	3.65 (11.97)		400	3.60 (11.80)	
870	4.06 (13.32)		700	5.10 (16.72)	
1000	4.35 (14.27)		900	6.00 (19.67)	
1450	5.29 (17.35)		1000	6.50 (21.31)	
3000	7.81 (25.62)		1450	8.00 (26.23)	
			1800	9.10 (29.84)	
			2200	10.10 (33.11)	
			3000	12.00 (39.34)	

# Coax RG-11, 95% Shield

CMR, CMP

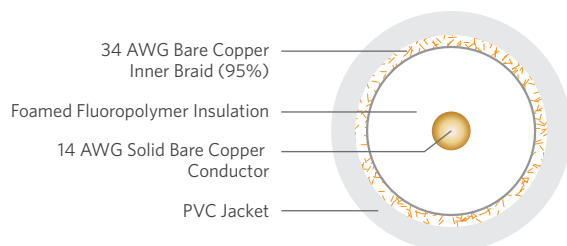

## PRODUCT DESCRIPTION

The Superior Essex RG-11, 95% Shield coaxial plenum cable is designed to support CCTV application. Superior Essex maintains tight tolerances to cable diameter requirements of leading connector manufacturers.

## APPLICATIONS

- CCTV
- Two-way cable modems
- Video camera signals

## FEATURES

- RG-11, 95% Shield coaxial cable with bandwidth that exceeds 1 GHz
- Tight foamed fluoropolymer insulating skin bonds around center conductor
- Black and white jacket colors available

## BENEFITS

- "Future-proofing" the installation
- Exhibits better transmission characteristics
- Helps differentiate incoming service versus internal cabling infrastructure

## SPECIFICATIONS

Conductor	Solid bare copper clad steel
AWG (mm)	14 (1.63)
Inner Braid	34 AWG bare copper (95%)
Insulation	CMR: Foam PE CMP: Foam FEP
Jacket	PVC
Nominal Impedance Ohms	75
Nominal Velocity of Propagation %	CMR: 82 CMP: 84
Performance Compliance	UL® 13 UL 444 UL 1666 NFPA 262 RoHS-compliant/RoHS 2-compliant
NRTL Programs	UL, c(UL) Listed CMP

UL is a registered trademark of UL LLC.

## PART NUMBERS AND PHYSICAL CHARACTERISTICS

Listing	Part Number	Component Jacket Color	Nominal Diameter			Approx. Weight lbs/kft (kg/km)	Package	Packages per Pallet
			Overall in (mm)	Dielectric in (mm)	Shield in (mm)			
CMR	79-758-91	Black	0.36 (9.2)	0.28 (7.11)	0.30 (7.70)	71 (112)	1,000' Plywood reel	24
CMP	78-75C-91	White	0.35 (8.90)	0.28 (7.11)	0.30 (7.70)	81 (118)	1,000' Plywood reel	36

## ELECTRICAL SPECIFICATIONS

CMR			CMP		
Frequency MHz	Attenuation Maximum		Frequency MHz	Attenuation, Nominal	
	Specification dB/100 ft (dB/100 m)	SRL, Typical dB		Specification dB/100 ft (dB/100 m)	SRL, Nominal dB
5	0.38 (1.25)	20	1	0.15 (0.49)	20
55	1.20 (3.94)	20	10	0.80 (2.62)	20
100	1.55 (5.08)	20	50	1.20 (3.93)	20
200	2.30 (7.54)	20	100	1.70 (5.57)	20
400	3.30 (10.82)		200	2.50 (8.20)	20
750	4.80 (15.74)		400	3.60 (11.80)	
870	5.60 (18.37)		700	5.10 (16.72)	
1000	5.70 (18.70)		900	6.00 (19.67)	
			1000	6.50 (21.31)	

# What is a Multi-Attribute Certification?

## Certified Environmental Facts™

**Company:** Superior Essex®  
**Products:** Cobra CAT 5e+ and Marathon LAN® CAT 5e  
**Packaging:** Reel-in-a-Box  
**Plant Location:** Hoisington, KS

---

**Product Specific:**

Recyclable Material <sup>1</sup>	50%
Completed LCA/EPD	Yes — Published EPD
Completed HPD	Yes — Published HPD

**Packaging Specific:**

Pre-Consumer Recycled Content	41%
Post-Consumer Recycled Content	47%
Recyclable Material <sup>2</sup>	100%

**Manufacturing Specific:**

Carbon Footprint Reduction — Facility <sup>3</sup>	92%
Reduced Energy Usage	4%
Reduced Water Usage	23%
Reduced Waste <sup>4</sup>	0.4%
Zero Waste to Landfill Facility <sup>5</sup>	Yes
ISO 9001:2008 Registered/TL 9000 Registered	Yes

**Evaluation Period:** 2011 - 2014  
**Certification Number:** 14-0280  
**Certification Period:** 11/1/2014 - 10/31/2015  
 For more information on the Certified Environmental Facts of this product, please contact: [info@GreenCircleCertified.com](mailto:info@GreenCircleCertified.com)  
[www.GreenCircleCertified.com](http://www.GreenCircleCertified.com)



1. Pertains to copper wire only. Wire must be stripped to be recycled.  
 2. 100% recyclable in areas with #5 plastic recycling capabilities.  
 3. Pertains to Scope 1 emissions only.  
 4. Pertains to non-hazardous waste only.  
 5. Details on GreenCircle certificate # 15-0238

© Copyright 2014 by GreenCircle Certified, LLC

A Multi-Attribute Certification provides a complete **overview of the sustainability of a product, its packaging and manufacturing operations**. Superior Essex Multi-Attribute Certifications are published through GreenCircle Certified, LLC in accordance with internationally recognized standards and the Federal Trade Commission's Green Guides.

Superior Essex provides CAT 5e – CAT 6 premises copper cabling products with Multi-Attribute Labels.

Visit [SuperiorEssexCommunications.com/Enviro](http://SuperiorEssexCommunications.com/Enviro) for more information.

The GreenCircle Certified logo is a registered trademark of GreenCircle Certified, LLC.

# Coax RG-6, Quad Shield

CM, CMR, CMP

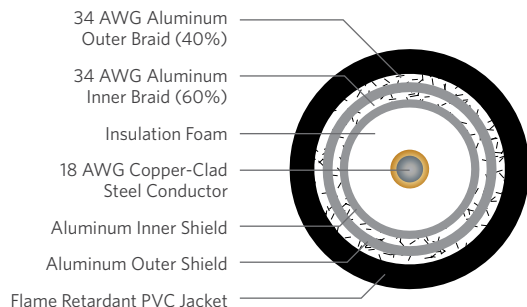

## SPECIFICATIONS

Conductor	Copper clad steel
AWG (mm)	18 (1.02)
Inner Shield	CM/CMR: 2.8 mil aluminum foil CMP: Aluminum/polyester/aluminum
Inner Braid	34 AWG aluminum (60%)
Outer Shield	CM/CMR: 1.8 mil aluminum foil CMP: Aluminum/polyester/aluminum
Outer Braid	34 AWG aluminum (40%)
Insulation	CM/CMR: Polyethylene CMP: FEP
Jacket	PVC (polyvinyl chloride)
Nominal Impedance Ohms	75
Nominal Velocity of Propagation %	CM/CMR: 85 CMP: 80
Performance Compliance	UL® 13 UL 444 CSA C22.2 No. 214-08 UL 1685 UL 1666 NFPA 262 RoHS-compliant/RoHS 2-compliant
NRTL Programs	UL, c(UL) Listed CM UL, c(UL) Listed CMR UL, c(UL) Listed CMP

UL is a registered trademark of UL LLC.

## PRODUCT DESCRIPTION

Superior Essex RG-6, Quad Shield coaxial cables are designed to support technologies such as extended bandwidth satellite service, high definition TV signals, CATV and two-way cable modems. Superior Essex maintains tight tolerances to cable diameter requirements of leading connector manufacturers.

## APPLICATIONS

- HDTV and CATV
- Two-way cable modems
- Extended bandwidth satellite service

## FEATURES

- RG-6, Quad Shield Coaxial cable with bandwidth that exceeds 3 GHz
- Tight foamed polyethylene (CM and CMR) or fluoropolymer (CMP) insulating skin bonds around center conductor
- Black and white jacket colors available for CM, CMR and CMP versions

## BENEFITS

- "Future-proofing" the installation. Supports extended bandwidth satellite service and high-definition TV signals
- Exhibits better transmission characteristics
- Helps differentiate incoming service versus internal cabling infrastructure

## PART NUMBERS AND PHYSICAL CHARACTERISTICS

Listing	Part Number	Component Jacket Color	Nominal Diameter			Approx. Weight lbs/kft (kg/km)	Package	Packages per Pallet
			Overall in (mm)	Dielectric in (mm)	Shield in (mm)			
CM	78-147-91	White	0.30 (7.5)	0.18 (4.6)	0.19 (4.8)	29 (43)	1,000' Plywood reel	27
CM	79-147-91	Black	0.30 (7.5)	0.18 (4.6)	0.19 (4.8)	29 (43)	1,000' Plywood reel	27
CM	78-147-9P	White	0.30 (7.5)	0.18 (4.6)	0.19 (4.8)	29 (43)	1,000' POP™ box	20
CM	79-147-9P	Black	0.30 (7.5)	0.18 (4.6)	0.19 (4.8)	29 (43)	1,000' POP box	20
CMR	78-148-91	White	0.30 (7.5)	0.18 (4.6)	0.19 (4.8)	30 (45)	1,000' Plywood reel	27
CMR	79-148-91	Black	0.30 (7.5)	0.18 (4.6)	0.19 (4.8)	30 (45)	1,000' Plywood reel	27
CMP	78-14C-91	White	0.26 (6.7)	0.17 (4.3)	0.23 (5.9)	30 (45)	1,000' Plywood reel	25
CMP	78-14C-9P	White	0.26 (6.7)	0.17 (4.3)	0.22 (5.5)	32 (47)	1,000' POP box	36
CMP	79-14C-91	Black	0.26 (6.7)	0.17 (4.3)	0.23 (5.9)	30 (45)	1,000' Plywood reel	25

## ELECTRICAL SPECIFICATIONS

Frequency MHz	CM/CATV and CMR/CATVR Attenuation Maximum		CM/CATV and CMR/CATVR SRL, Typical dB
	Specification dB/100 ft (dB/100 m)	Typical dB/100 ft (dB/100 m)	
55	1.6 (5.3)	1.3 (4.8)	20
211	3.1 (10.1)	2.7 (9.0)	20
270	3.5 (11.5)	3.1 (10.3)	20
300	3.7 (12.1)	3.4 (11.0)	20
330	3.9 (12.8)	3.6 (11.7)	20
400	4.3 (14.1)	4.0 (13.1)	20
450	4.6 (15.0)	4.1 (13.6)	20
550	5.1 (16.7)	4.7 (15.3)	20
750	6.0 (19.7)	5.2 (17.1)	20
870	6.5 (21.3)	6.0 (19.7)	20
1000	7.0 (23.0)	6.5 (21.2)	20
1200		7.2 (23.7)	18
1450		8.0 (26.1)	18
1800		8.8 (29.0)	18
2200		9.8 (32.1)	18
2600		10.7 (35.2)	15
3000		11.7 (38.3)	15

Frequency MHz	CMP/CL2P Attenuation, Nominal dB/100 ft (dB/100 m)	CMP/CL2P SRL, Nominal dB
1	0.50 (1.64)	10
3.6	0.78 (2.56)	10
10	0.94 (3.08)	10
50	1.93 (6.33)	10
71.5	2.32 (7.61)	10
100	2.74 (8.99)	10
135	3.19 (10.47)	10
200	3.89 (12.76)	10
360	5.22 (17.13)	10
540	6.19 (20.31)	10
720	7.72 (25.33)	10
900	9.01 (29.56)	10
1000	9.61 (31.53)	10
1450	12.40 (40.68)	10
1800	14.36 (47.11)	10
2000	15.50 (50.85)	10
2250	16.96 (55.64)	10
3000	20.76 (68.11)	10

# Coax RG-6, 95% Shield

CMR, CMP

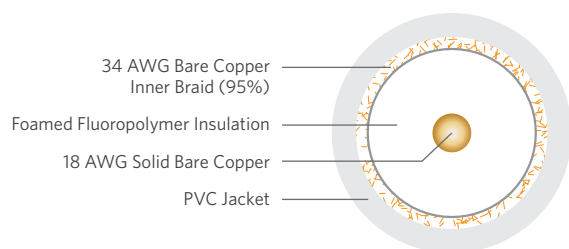

## SPECIFICATIONS

Conductor	Solid bare copper
AWG (mm)	18 (1.02)
Inner Braid	34 AWG bare copper (95%)
Insulation	CMR: Foam PE CMP: FEP
Jacket	PVC
Nominal Impedance Ohms	75
Nominal Velocity of Propagation %	CMR: 82 CMP: 84
Performance Compliance	UL® 13 UL 444 UL 1666 NFPA 262 RoHS-compliant/RoHS 2-compliant
NRTL Programs	UL, c(UL) Listed CMP UL, c(UL) Listed CMR

UL is a registered trademark of UL LLC.

## PRODUCT DESCRIPTION

The Superior Essex RG-6, 95% Shield coaxial plenum cable is designed to support CCTV application. Superior Essex maintains tight tolerances to cable diameter requirements of leading connector manufacturers.

## APPLICATIONS

- CCTV
- Two-way cable modems
- Video camera signals

## FEATURES

- RG-6, 95% Shield coaxial cable with bandwidth that exceeds 1 GHz
- Tight foamed fluoropolymer insulating skin bonds around center conductor
- Black and white jacket colors available

## BENEFITS

- “Future-proofing” the installation
- Exhibits better transmission characteristics
- Helps differentiate incoming service versus internal cabling infrastructure

## PART NUMBERS AND PHYSICAL CHARACTERISTICS

Listing	Part Number	Jacket Color	Nominal Diameter			Approx. Weight lbs/kft (kg/km)	Package	Packages per Pallet
			Overall in (mm)	Dielectric in (mm)	Shield in (mm)			
CMR	79-658-91	Black	0.25 (6.5)	0.18 (4.5)	0.20 (5.0)	34 (49)	1,000' Plywood reel	27
CMP	78-65C-91	White	0.23 (5.9)	0.17 (4.32)	0.18 (4.8)	36 (52)	1,000' Plywood reel	36
CMP	78-65C-9P	White	0.23 (5.9)	0.17 (4.32)	0.18 (4.8)	36 (52)	1,000' POP™ box	22

## ELECTRICAL SPECIFICATIONS

CMR			CMP		
Frequency MHz	Attenuation Maximum		Frequency MHz	Attenuation, Nominal	
	Specification dB/100 ft (dB/100 m)	SRL, Nominal dB		Specification dB/100 ft (dB/100 m)	SRL, Nominal dB
5	0.58 (1.90)	20	1	0.50 (1.64)	20
55	1.65 (5.41)	20	10	0.94 (3.08)	20
100	2.30 (7.54)	20	50	1.93 (6.33)	20
200	3.25 (10.66)	20	100	2.74 (8.98)	20
400	4.80 (15.74)		200	3.89 (12.75)	20
750	6.75 (22.14)		400	5.50 (18.03)	
870	7.35 (24.11)		700	7.70 (25.25)	
1000	8.00 (26.24)		900	9.01 (29.54)	
			1000	9.61 (31.51)	



# Coax RG-6, Tri-Shield 70%

CM, CMR

## PRODUCT DESCRIPTION

Superior Essex RG-6 Tri-Shield 70% braided coaxial cables exceed the requirements specified in ANSI/SCTE 74-2003. The shielding consists of an inner aluminum/polyester foil bonded to the insulation, an aluminum 34 AWG braid, and an outer aluminum/polyester foil. This RG-6 Tri-Shield will support such technologies as extended bandwidth satellite service, high definition TV signals, CATV and two-way cable modems.

## APPLICATIONS

- HDTV
- Extended bandwidth satellite service

## FEATURES

- RG-6 (18 AWG copper clad steel center conductor)
- Available in CM Outdoor (60°C rated jacket) or CMR (75°C rated jacket)
- Tri-Shield consists of inner aluminum/polyester foil, aluminum braid, outer aluminum/polyester foil
- Bonded inner foil
- 100% coverage over the 70% (34 AWG aluminum) braiding
- Reel-in-a-Box design
- White or black outer jacket (UV rated for exterior use)

## BENEFITS

- Standard and popular size
- Indoor/outdoor use
- Added shielding for higher service levels
- Stops moisture
- Offers better shielding protection and stops interference
- Water-resistant package is easy to carry and store
- Jacket color helps differentiate incoming versus internal cabling

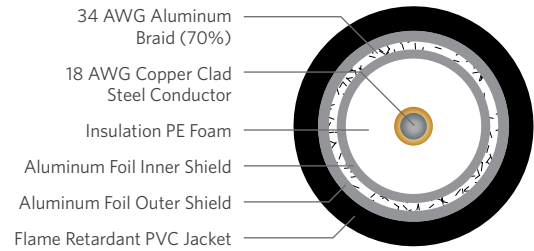

## SPECIFICATIONS

<b>Conductor</b>	Copper clad steel
<b>AWG (mm)</b>	18 (1.0)
<b>Inner Shield</b>	Aluminum/polyester foil (100%)
<b>Center Shield</b>	34 AWG aluminum braid (70%)
<b>Outer Shield</b>	Aluminum/polyester foil (100%)
<b>Nominal Impedance Ohms</b>	75
<b>Jacket</b>	Flame retardant PVC
<b>Performance Compliance</b>	UL 444 CSA C22.2 No. 214-08 UL 1685 ANSI/SCTE 74-2003 Appropriate ASTM standards RoHS-compliant
<b>NRTL Programs</b>	UL, c(UL) Listed CM UL, c(UL) Listed CMR

## PART NUMBERS AND PHYSICAL CHARACTERISTICS

Listing	Part Number	Jacket Color	Nominal Diameter in (mm)	Approx. Weight lbs/kft (kg/km)	Package	Packages per Pallet
CM	78-11A-9R	White	0.28 (7.1)	32 (48)	1,000' Reel-in-a-Box	27
CM	79-11A-9R	Black	0.28 (7.1)	32 (48)	1,000' Reel-in-a-Box	27
CMR	79-11B-9R	Black	0.28 (7.1)	32 (48)	1,000' Reel-in-a-Box	27

## ELECTRICAL SPECIFICATIONS

Frequency MHz	Maximum Attenuation @ 68°F (20°C) dB/100 m
55	5.2
211	10.0
250	10.8
270	11.0
330	12.2
350	12.6
450	14.4
500	15.3
550	16.1
600	16.7
750	18.5
870	20.0
1000	21.5

# Coax RG-6, 60% Shield

CM, CMG, CMP

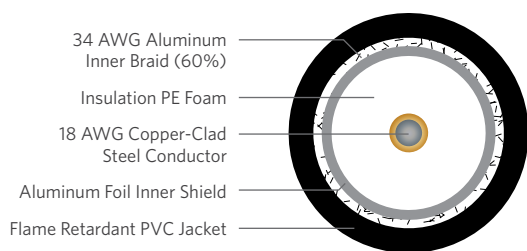

34 AWG Aluminum  
Inner Braid (60%)

Insulation PE Foam

18 AWG Copper-Clad  
Steel Conductor

Aluminum Foil Inner Shield

Flame Retardant PVC Jacket

## SPECIFICATIONS

Conductor	Copper clad steel
AWG (mm)	18 (1.02)
Inner Braid	34 AWG aluminum (60%)
Inner Shield	2.8 mil aluminum foil
Insulation	CM, CMG: Foam PE CMP: FEP
Jacket	Flame retardant PVC
Nominal Impedance Ohms	75
Nominal Velocity of Propagation %	CM: 85 CMG: 82 CMP: 84
Performance Compliance	UL® 444 UL 1685 NFPA 262 ANSI/SCTE 74-2003 RoHS-compliant/RoHS 2-compliant
NRTL Programs	UL, c(UL) Listed CM UL, c(UL) Listed CMG UL, c(UL) Listed CMP

UL is a registered trademark of UL LLC.

## PRODUCT DESCRIPTION

Superior Essex RG-6, 60% Shield coaxial cables are designed to support analog, digital and high-bandwidth technologies. Superior Essex maintains tight tolerances to cable diameter requirements of leading connector manufacturers.

## APPLICATIONS

- HDTV and CATV
- Two-way cable modems
- Extended bandwidth satellite service

## FEATURES

- RG-6, 60% Shield Coaxial cable with bandwidth that exceeds 3 GHz
- Tight foamed polyethylene insulating skin bonds around center conductor
- Black and white jacket colors available

## BENEFITS

- “Future-proofing” the installation with bandwidth that exceeds 3 GHz
- Exhibits better transmission characteristics
- Helps differentiate incoming service versus internal cabling infrastructure

## PART NUMBERS AND PHYSICAL CHARACTERISTICS

Listing	Part Number	Jacket Color	Nominal Diameter		Approx. Weight lbs/kft (kg/km)	Package	Packages per Pallet
			Inner Shield in (mm)	Overall in (mm)			
CM	78-107-9P	White	0.18 (4.6)	0.28 (7.1)	21 (13.5)	1,000' POP™ box	20
CM	79-107-9P	Black	0.18 (4.6)	0.28 (7.1)	21 (13.5)	1,000' POP box	20
CM	78-107-91	White	0.18 (4.6)	0.28 (7.1)	21 (13.5)	1,000' Plywood reel	27
CM	79-107-91	Black	0.18 (4.6)	0.28 (7.1)	21 (13.5)	1,000' Plywood reel	27
CMG	79-10G-9P	Black	0.18 (4.6)	0.27 (6.8)	21 (13.5)	1,000' POP box	20
CMG	78-10G-9P	White	0.18 (4.6)	0.27 (6.8)	21 (13.5)	1,000' POP box	20
CMP	78-10C-91	White	0.20 (5.08)	0.23 (5.9)	30 (13.7)	1,000' Plywood reel	36
CMP	78-10C-9P	White	0.20 (5.08)	0.23 (5.9)	30 (13.7)	1,000' POP box	36
CMP	79-10C-9P	Black	0.20 (5.08)	0.23 (5.9)	30 (13.7)	1,000' POP box	36

## ELECTRICAL SPECIFICATIONS

CM			CMG		
Frequency MHz	Attenuation, Nominal		Frequency MHz	Attenuation, Nominal	
	Specification dB/100 ft (dB/100 m)	SRL, Nominal dB		Specification dB/100 ft (dB/100 m)	SRL, Nominal dB
55	6.04 (1.84)	20	55	1.60(5.25)	20
211	11.6 (3.55)	20	250	3.30(10.82)	20
250	12.6 (3.85)	20	300	3.55(11.64)	20
270	13.1 (4.00)	20	400	4.15(13.61)	20
330	14.5 (4.41)	20	500	4.66(15.29)	20
350	14.9 (4.54)	20	600	5.10(16.73)	20
450	16.9 (5.14)	20	750	5.65(18.54)	20
500	17.7 (5.41)	20	1000	6.55(21.49)	20
550	18.6 (5.66)	20	1200	6.60(21.65)	15
600	19.4 (5.91)	20	1500	9.30(30.50)	15
750	21.6 (6.59)	20	2000	9.76(32.01)	15
870	23.2 (7.08)	20	2200	9.79(32.11)	15
1000	24.8 (7.57)	20	2500	10.13(33.23)	15
1200	27.1 (8.27)	17	3000	14.61(47.92)	15
1450	29.7 (9.05)	17			
1800	32.9 (10.0)	17			
2250	36.6 (11.2)	17			

CMP		
Frequency MHz	Attenuation, Nominal	
	Specification dB/100 ft (dB/100 m)	SRL, Nominal dB
1	0.50 (1.64)	20
10	0.94 (3.08)	20
50	1.75 (5.74)	20
100	2.60 (8.52)	20
200	3.80 (12.46)	20
400	5.50 (18.03)	
700	7.60 (24.92)	
900	8.90 (29.18)	
1000	9.30 (30.49)	
1200	10.60 (34.75)	
1450	12.00 (39.34)	
1800	13.60 (44.59)	
2200	14.80 (48.52)	
3000	18.00 (59.02)	

# Coax RG-59, 95% Shield

CMR, CMP

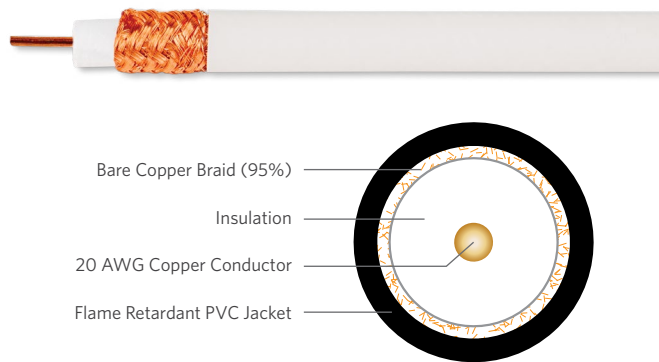

## SPECIFICATIONS

Conductor	Solid copper
AWG (mm)	20 (0.81)
Braid	Bare copper (95%)
Jacket	Flame retardant PVC
Nominal Impedance Ohms	75.0
Nominal Velocity of Propagation %	CMR: 83 CMP: 84
Performance Compliance	UL® 13 UL 444 UL 1666 NEC Article 725 NEC Article 800 NFPA 262 RoHS-compliant/RoHS 2-compliant
NRTL Programs	UL, c(UL) Listed CMR UL, c(UL) Listed CMP

UL is a registered trademark of UL LLC.

## PRODUCT DESCRIPTION

Closed circuit security cameras use baseband frequencies, typically under 5 MHz. These applications are best suited for the bare copper center conductors of the Superior Essex RG-59 coaxial cable, which also features 95% copper braiding. RG-59 is specifically designed for applications operating below 1 GHz, but will also support higher frequency applications at shorter distances than RG-6 coaxial cable.

## APPLICATIONS

- CCTV
- Video camera signals

## FEATURES

- Small size
- Copper center conductor
- Foamed polyethylene dielectric (CMR) or fluoropolymer (CMP)
- Bonded aluminum shield tape
- 95% tinned copper braid
- Black and white jacket colors available for CMR version

## BENEFITS

- Suitable for tight applications and preferred for lower frequency signals
- Ideal for lower frequency signals
- Exhibits better transmission characteristics
- Blocks RFI
- Ideal for lower frequency signals
- Helps differentiate incoming service versus internal cabling infrastructure

## PART NUMBERS AND PHYSICAL CHARACTERISTICS

Listing	Part Number	Jacket Color	Nominal Diameter in (mm)	Approx. Weight lbs/kft (kg/km)	Package	Packages per Pallet
CMR/CL2R	78-558-91	White	0.24 (6.1)	34 (50.7)	1,000' Plywood reel	25
CMR/CL2R	79-558-91	Black	0.24 (6.1)	34 (50.7)	1,000' Plywood reel	25
CMP/CL2P	78-55C-91	White	0.19 (5.1)	27 (12.0)	1,000' Plywood reel	25

## ELECTRICAL SPECIFICATIONS

Frequency MHz	CMR/CL2R Attenuation, Nominal dB/100 ft (dB/100 m)	CMP/CL2P Attenuation, Nominal dB/100 ft (dB/100 m)
1	0.3 (1.0)	0.3 (1.0)
3.58	0.6 (1.8)	0.6 (2.0)
5	0.6 (2.1)	0.7 (2.3)
7	0.7 (2.4)	0.8 (2.7)
10	0.9 (2.9)	1.1 (3.4)
67.5	2.1 (6.7)	2.2 (7.2)
71.5	2.1 (6.9)	2.3 (7.4)
100	2.3 (7.6)	2.7 (8.9)
135	2.7 (8.9)	3.2 (10.5)
143	2.8 (9.1)	3.3 (10.7)
180	3.1 (10.2)	3.7 (12.0)
270	3.8 (12.5)	4.6 (14.9)
360	4.4 (14.5)	5.3 (17.2)
540	5.5 (17.9)	6.4 (21.0)
720	6.4 (20.9)	7.3 (23.9)
750	6.5 (21.3)	7.4 (24.3)
1000	7.6 (24.9)	9.4 (30.8)
2000	10.9 (35.8)	14.6 (47.8)
3000	13.3 (43.7)	18.8 (61.5)

## What is an Environmental Product Declaration (EPD)?

An Environmental Product Declaration is a **source of transparent, scientifically-based information that discloses the potential environmental impact of a product or product family**. Superior Essex Environmental Product Declarations are verified by UL® Environment, a division of the safety science company Underwriters Laboratories.

Superior Essex provides premises copper and optical fiber cabling products with EPDs. Visit [SuperiorEssexCommunications.com/Enviro](https://www.superioressex.com/Enviro) for more information.



## What is a Health Product Declaration™ (HPD™)?



A Health Product Declaration is a **report that describes product contents and each ingredient's relationship to human and ecological health**. Superior Essex Health Product Declarations are published according to the Health Product Declaration Collaborative Standard.

Superior Essex provides premises copper and optical fiber cabling products with HPDs. Visit [SuperiorEssexCommunications.com/Enviro](https://www.superioressex.com/Enviro) for more information.

UL and the related logo are registered trademarks of UL LLC. Health Product Declaration, HPD and the related logo are trademarks of Health Product Declaration Collaborative.

# Coax RG-59, 95% Shield + 18/2

CMR, CMP

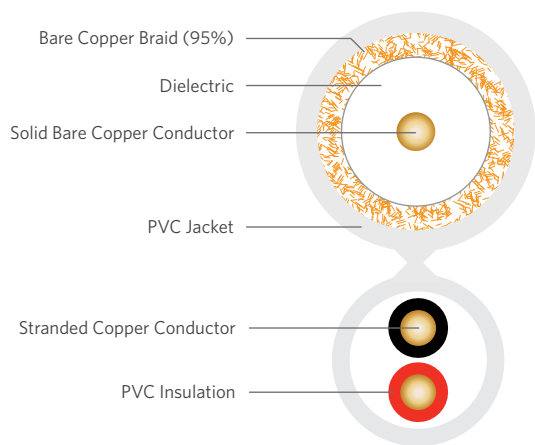

## PRODUCT DESCRIPTION

Closed circuit security cameras use baseband frequencies, typically under 5 MHz. These applications are best suited for the bare copper center conductors of the Superior Essex RG-59 coaxial cable, which also features 95% bare copper braiding. RG-59 is specifically designed for applications operating below 1 GHz, but will also support higher frequency applications at shorter distances than RG-6 coaxial cable. This cable includes a web-attached 18 AWG copper pair to power camera.

## APPLICATIONS

- CCTV with power feed
- Video camera signals

## FEATURES

- Small size
- Copper center conductor
- Foamed fluoropolymer
- 95% bare copper braid
- Web-attached 18 AWG power-pairs

## BENEFITS

- Suitable for tight applications and preferred for lower frequency signals
- Lower signal attenuation
- Exhibits better transmission characteristics
- Lower signal attenuation
- Single cable run for video and power feeds

## COAX COMPONENT SPECIFICATIONS

Conductor	Solid bare copper
AWG (mm)	20 (0.82)
Dielectric	CMR: PE CMP: FEP
Braid	Bare copper (95% coverage)
Nominal Velocity of Propagation %	82
Nominal Impedance Ohms	75.0
DC Resistance Ohms/kft	10.5

## COMPOSITE SPECIFICATIONS

Jacket	PVC
Performance Compliance	UL® 13 UL 444 UL 1666 NFPA 262 RoHS-compliant/RoHS 2-compliant
NRTL Programs	UL, c(UL) Listed CMP UL, c(UL) Listed CMR

UL is a registered trademark of UL LLC.

## POWER COMPONENT SPECIFICATIONS

Conductor Count	2
Conductor	Stranded copper
AWG (mm)	18 (1.22)
Insulation	PVC
Insulation Colors	Conductor 1: Black Conductor 2: Red
DC Resistance Ohms/kft	6.6

## PART NUMBERS AND PHYSICAL CHARACTERISTICS

Listing	Part Number	Jacket Color	Nominal Diameter in (mm)	Approx. Weight lbs/kft (kg/km)	Package	Packages per Pallet
CMP/CL2P	86-57D-A1	White	0.36 (9.2) x 0.20 (5.0)	47 (70.1)	1,000' Plywood reel	27
CMR	89-578-A1	Black	0.23(5.95) x 0.20 (5.1)	57 (85)	1,000' Plywood reel	24
CMR	86-578-A1	White	0.23(5.95) x 0.20 (5.1)	57 (85)	1,000' Plywood reel	24

## ELECTRICAL SPECIFICATIONS

CMR			CMP/CL2P			CMP		
Frequency MHz	Attenuation, Nominal		SRL, Typical dB	Frequency MHz	Attenuation, Nominal		SRL, Typical dB	
	Specification dB/100 ft (dB/100 m)				Specification dB/100 ft (dB/100 m)			
5	0.86 (2.82)		20	1	0.35 (1.15)		20	
211	3.95 (12.96)		20	10	1.04 (3.41)		20	
400	5.50 (18.04)			100	3.25 (10.66)		20	
750	7.60 (24.93)			200	4.63 (15.19)		20	
870	8.30 (27.22)			400	7.12 (23.60)			
1000	9.00 (29.52)			700	9.97 (32.43)			
				900	10.79 (36.06)			
				1000	11.66 (38.25)			

# Fire Alarm, Non-Shielded

Power Limited, Riser/Plenum

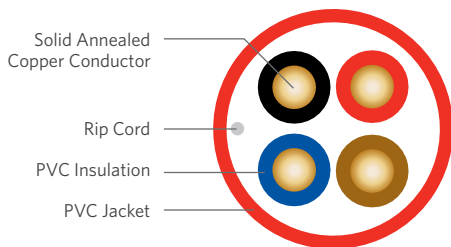

## SPECIFICATIONS

Conductor Count	Available with 2 through 8 conductors
Conductor	Fully annealed, solid bare copper
AWG (mm)	Available in 12 (2.05) through 22 (0.64)
Insulation	PVC
Insulation Colors	Conductor 1: Black Conductor 2: Red Conductor 3: Brown Conductor 4: Blue Conductor 5: Orange Conductor 6: Yellow Conductor 7: Violet Conductor 8: Gray
Jacket	Riser: Red, Flame Retardant (FR) PVC (Available in other jacket colors) Plenum: Red, Low smoke PVC (Available in other jacket colors)
Package	Black, ribbed, plastic recyclable spool, Reel-in-a-Box or wood reel
Performance Compliance	NEC Article 760 NEC Article 725 NEC Article 800 UL® 1424 FPLR/FPLP UL 13 CL3R/CL3P UL 444 CMR/CMP* UL 1666 NFPA 262 California State Fire Marshall RoHS-compliant/RoHS 2-compliant
NRTL Programs	UL Listed CMR, CL3R, FPLR UL Listed CMP, CL3P, FPLP

\*CMR/CMP listing does not apply to 12 AWG and 14 AWG Superior Essex Fire Alarm cables. UL is a registered trademark of UL LLC.

## ENVIRONMENTAL SPECIFICATIONS

Operation	-4°F to +167°F (-20°C to +75°C)
Installation	+32°F to +149°F (0°C to +65°C)

## PRODUCT DESCRIPTION

Fire Alarm cables are used for a variety of life safety devices, and are required to comply with many codes and standards. Superior Essex has grouped its fire alarm cable products into just two categories for simplicity: riser and plenum. All riser listed fire alarm cables provide full compliance to NEC Article 760, NEC Article 725, FPLR and CL3R. All plenum listed fire alarm cables provide compliance to NEC Article 760, NEC Article 725, FPLP and CL3P. These cables are offered in a wide range of conductor counts and gauges. All cables are power limited rated for 300V.

## APPLICATIONS

- Smoke detectors
- Alarm notification
- Strobes
- Sirens
- Pull stations
- Addressable control systems
- Circuits controlled and powered by the fire alarm system
- Sprinkler and sprinkler supervisory systems

## FEATURES

- Red color jacket (standard)
- Non-plenum, riser rated
- Plenum rated
- Jacket rip cord
- CableID® alpha numeric code printed every 2 feet
- QuickCount® marking system in feet and meters
- Black, plastic recyclable spool packaging (standard)

## BENEFITS

- Identified as universal fire alarm cable
- Simplifies selection with multiple listings (FPL, FPLR, CL3R and CMR\*)
- Simplifies selection with multiple listings (FPLP, CL3P and CMP\*)
- Easy to open; saves cable preparation time
- Allows both ends of a cable run to be easily identifiable without the need to separately label or tone the cable
- Saves on installation time
- Provides remaining length of cable on spool resulting in less scrap
- Robust and easy to handle



**PART NUMBERS AND PHYSICAL CHARACTERISTICS**

Listing	Part Number <sup>1</sup>	Conductor Count	AWG (mm)	Nominal Diameter in (mm)	Approx. Weight lbs/kft (kg/km)
FPLR/CL3R	2F-41x-91	2	12 (2.05)	0.23 (5.8)	49 (73)
FPLR/CL3R	2F-42x-91	3	12 (2.05)	0.25 (6.2)	73 (33)
FPLR/CL3R	2F-31x-91	2	14 (1.63)	0.20 (5.1)	33 (49)
FPLR/CL3R	2F-32x-91	3	14 (1.63)	0.21 (5.4)	46 (20)
FPLR/CL3R	2F-33x-91	4	14 (1.63)	0.25 (6.4)	66 (99)
FPLR/CL3R/CMR	2F-21x-91	2	16 (1.29)	0.17 (4.3)	23 (34)
FPLR/CL3R/CMR	2F-22x-91	3	16 (1.29)	0.18 (4.6)	32 (14)
FPLR/CL3R/CMR	2F-23x-91	4	16 (1.29)	0.20 (5.1)	42 (63)
FPLR/CL3R/CMR	2F-11x-91	2	18 (1.02)	0.15 (3.8)	16 (24)
FPLR/CL3R/CMR	2F-12x-91	3	18 (1.02)	0.16 (4.1)	22 (9)
FPLR/CL3R/CMR	2F-13x-91	4	18 (1.02)	0.17 (4.3)	29 (43)
FPLR/CL3R/CMR	2F-14x-91	6	18 (1.02)	0.21 (5.3)	42 (63)
FPLR/CL3R/CMR	2F-51x-91	2	22 (0.64)	0.12 (3.0)	8 (12)
FPLR/CL3R/CMR	2F-52x-91	3	22 (0.64)	0.13 (3.3)	10 (4)
FPLR/CL3R/CMR	2F-53x-91	4	22 (0.64)	0.14 (3.6)	14 (21)
FPLP/CL3P	2F-41x-93	2	12 (2.05)	0.23 (5.8)	50 (74)
FPLP/CL3P	2F-31x-93	2	14 (1.63)	0.20 (5.1)	34 (51)
FPLP/CL3P	2F-32x-93	3	14 (1.63)	0.21 (5.4)	47 (21)
FPLP/CL3P	2F-33x-93	4	14 (1.63)	0.23 (5.8)	64 (95)
FPLP/CL3P/CMP	2F-21x-93	2	16 (1.29)	0.17 (4.3)	24 (36)
FPLP/CL3P/CMP	2F-22x-93	3	16 (1.29)	0.18 (4.6)	33 (14)
FPLP/CL3P/CMP	2F-23x-93	4	16 (1.29)	0.20 (5.1)	43 (64)
FPLP/CL3P/CMP	2F-11x-93	2	18 (1.02)	0.15 (3.8)	17 (25)
FPLP/CL3P/CMP	2F-12x-93	3	18 (1.02)	0.16 (4.1)	23 (10)
FPLP/CL3P/CMP	2F-13x-93	4	18 (1.02)	0.17 (4.3)	29 (43)
FPLP/CL3P/CMP	2F-14x-93	6	18 (1.02)	0.21 (5.3)	43 (64)
FPLP/CL3P/CMP	2F-15x-93	8	18 (1.02)	0.23 (5.8)	56 (83)
FPLP/CL3P/CMP	2F-51x-93	2	22 (0.64)	0.12 (3.0)	9 (13)
FPLP/CL3P/CMP	2F-52x-93	3	22 (0.64)	0.13 (3.3)	11 (4)
FPLP/CL3P/CMP	2F-53x-93	4	22 (0.64)	0.14 (3.6)	15 (22)

Additional jacket colors are available.

	Plastic Spool		Reel-in-a-Box		Wood Reel
	1,000'	500'	1,000'	500'	1,000'
<sup>1</sup> Replace "x" with:	2	3	4	5	6

# Fire Alarm, Shielded

Power Limited, Riser/Plenum

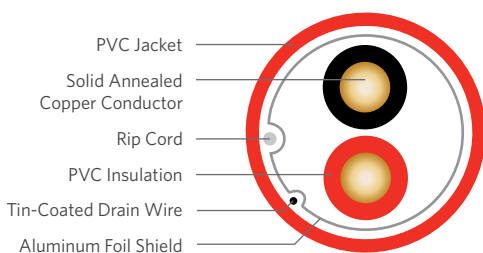

## SPECIFICATIONS

<b>Conductor Count</b>	Available with 2 through 6 conductors
<b>Conductor</b>	Fully annealed, solid bare copper
<b>AWG (mm)</b>	Available in 12 (2.05) through 22 (0.64)
<b>Insulation</b>	PVC
<b>Insulation Colors</b>	Conductor 1: Black Conductor 2: Red Conductor 3: Brown Conductor 4: Blue Conductor 5: Orange Conductor 6: Yellow Conductor 7: Violet Conductor 8: Gray
<b>Shield</b>	1-mil overall aluminum polyester foil shield with 24 AWG (0.51 mm) solid tinned copper drain wire
<b>Jacket</b>	Riser: Red, Flame Retardant (FR) PVC (Available in other jacket colors) Plenum: Red, Low smoke PVC (Available in other jacket colors)
<b>Package</b>	Black, ribbed, plastic recyclable spool, Reel-in-a-Box or wood reel
<b>Performance Compliance</b>	NEC Article 760 NEC Article 725 NEC Article 800 UL® 1424 FPLR/FPLP UL 13 CL3R/CL3P UL 444 CMR/CMP* UL 1666 NFPA 262 California State Fire Marshall RoHS-compliant/RoHS 2-compliant
<b>NRTL Programs</b>	UL Listed CMR, CL3R, FPLR UL Listed CMP, CL3P, FPLP

\*CMR/CMP listing does not apply to 12 AWG and 14 AWG Superior Essex Fire Alarm cables. UL is a registered trademark of UL LLC.

## ENVIRONMENTAL SPECIFICATIONS

<b>Operation</b>	-4°F to +167°F (-20°C to +75°C)
<b>Installation</b>	+32°F to +149°F (0°C to +65°C)

## PRODUCT DESCRIPTION

Fire Alarm cables are used for a variety of life safety devices, and are required to comply with many codes and standards. Superior Essex has grouped its fire alarm cable products into just two categories for simplicity: riser and plenum. All riser listed fire alarm cables provide full compliance to NEC Article 760, NEC Article 725, FPLR and CL3R. All plenum listed fire alarm cables provide compliance to NEC Article 760, NEC Article 725, FPLP and CL3P. These cables are offered in a wide range of conductor counts and gauges. All cables are power limited rated for 300V.

## APPLICATIONS

- Smoke detectors
- Alarm notification
- Strobes
- Sirens
- Pull stations
- Addressable control systems
- Circuits controlled and powered by the fire alarm system
- Sprinkler and sprinkler supervisory systems

## FEATURES

- Red color jacket (standard)
- Non-plenum, riser rated
- Plenum rated
- Jacket rip cord
- CableID® alpha numeric code printed every 2 feet
- QuickCount® marking system in feet and meters
- Black, plastic recyclable spool packaging (standard)
- Shielded

## BENEFITS

- Identified as universal fire alarm cable
- Simplifies selection with multiple listings (FPL, FPLR, CL3R and CMR\*)
- Simplifies selection with multiple listings (FPLP, CL3P and CMP\*)
- Easy to open; saves cable preparation time
- Allows both ends of a cable run to be easily identifiable without the need to separately label or tone the cable
- Saves on installation time
- Provides remaining length of cable on spool resulting in less scrap
- Robust and easy to handle
- Electromagnetic Interference (EMI) protection

**PART NUMBERS AND PHYSICAL CHARACTERISTICS**

Listing	Part Number <sup>1</sup>	Conductor Count	AWG (mm)	Nominal Diameter in (mm)	Approx. Weight lbs/kft (kg/km)
FPLR/CL3R	2F-41x-92	2	12 (2.05)	0.24 (6.1)	51 (76)
FPLR/CL3R	2F-31x-92	2	14 (1.63)	0.21 (5.3)	36 (54)
FPLR/CL3R	2F-32x-92	3	14 (1.63)	0.22 (5.7)	49 (22)
FPLR/CL3R	2F-33x-92	4	14 (1.63)	0.24 (6.1)	65 (97)
FPLR/CL3R/CMR	2F-21x-92	2	16 (1.29)	0.18 (4.6)	25 (37)
FPLR/CL3R/CMR	2F-22x-92	3	16 (1.29)	0.19 (4.9)	35 (15)
FPLR/CL3R/CMR	2F-23x-92	4	16 (1.29)	0.21 (5.3)	44 (65)
FPLR/CL3R/CMR	2F-11x-92	2	18 (1.02)	0.16 (4.1)	18 (27)
FPLR/CL3R/CMR	2F-12x-92	3	18 (1.02)	0.17 (4.3)	25 (11)
FPLR/CL3R/CMR	2F-13x-92	4	18 (1.02)	0.18 (4.6)	31 (46)
FPLR/CL3R/CMR	2F-14x-92	6	18 (1.02)	0.22 (5.6)	44 (65)
FPLR/CL3R/CMR	2F-51x-92	2	22 (0.64)	0.13 (3.3)	10 (15)
FPLR/CL3R/CMR	2F-52x-92	3	22 (0.64)	0.14 (3.5)	13 (5)
FPLR/CL3R/CMR	2F-53x-92	4	22 (0.64)	0.15 (3.8)	16 (24)
FPLP/CL3P	2F-41x-94	2	12 (2.05)	0.24 (6.1)	53 (79)
FPLP/CL3P	2F-42x-94	3	12 (2.05)	0.26 (6.5)	76 (34)
FPLP/CL3P	2F-31x-94	2	14 (1.63)	0.21 (5.3)	36 (54)
FPLP/CL3P	2F-32x-94	3	14 (1.63)	0.22 (5.7)	50 (22)
FPLP/CL3P	2F-33x-94	4	14 (1.63)	0.24 (6.1)	66 (98)
FPLP/CL3P/CMP	2F-21x-94	2	16 (1.29)	0.18 (4.6)	26 (39)
FPLP/CL3P/CMP	2F-22x-94	3	16 (1.29)	0.19 (4.9)	35 (15)
FPLP/CL3P/CMP	2F-23x-94	4	16 (1.29)	0.21 (5.3)	45 (67)
FPLP/CL3P/CMP	2F-11x-94	2	18 (1.02)	0.16 (4.1)	19 (28)
FPLP/CL3P/CMP	2F-12x-94	3	18 (1.02)	0.17 (4.3)	25 (11)
FPLP/CL3P/CMP	2F-13x-94	4	18 (1.02)	0.18 (4.6)	32 (48)
FPLP/CL3P/CMP	2F-14x-94	6	18 (1.02)	0.22 (5.6)	45 (67)
FPLP/CL3P/CMP	2F-51x-94	2	22 (0.64)	0.13 (3.3)	11 (16)
FPLP/CL3P/CMP	2F-52x-94	3	22 (0.64)	0.14 (3.5)	13 (5)
FPLP/CL3P/CMP	2F-53x-94	4	22 (0.64)	0.15 (3.8)	17 (25)

Additional jacket colors are available.

**PACKAGING OPTIONS**

	Plastic Spool		Reel-in-a-Box		Wood Reel
	1,000'	500'	1,000'	500'	1,000'
<sup>1</sup> Replace "x" with:	2	3	4	5	6

# Interlock Armored

## Fire Alarm Riser

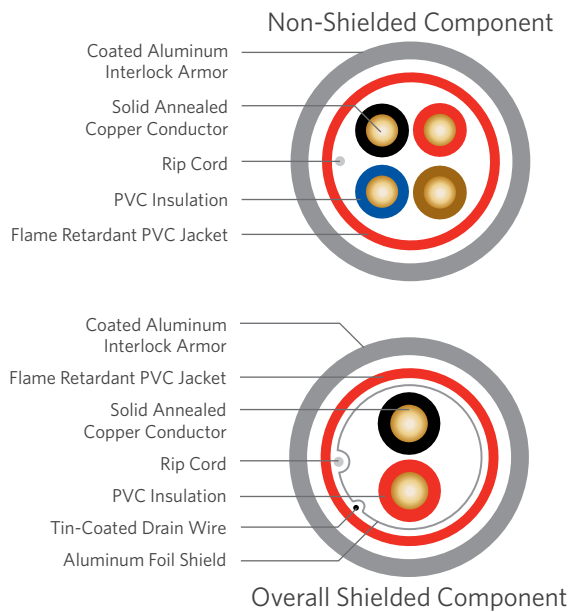

### SPECIFICATIONS

<b>Overall Cable Configuration</b>	Single component cable surrounded by red aluminum interlock armor
<b>Component Jacket</b>	Red, Flame Retardant PVC
<b>Armor</b>	Interlocked aluminum
<b>Performance Compliance</b>	NEC Article 760 NEC Article 725 NEC Article 800 UL® 1424 FPLR UL 13 CL3R UL 444 CMR* UL 1666 UL 1569, Sections 19 and 23 California State Fire Marshall RoHS-compliant/RoHS 2-compliant
<b>NRTL Programs</b>	UL Listed FPLR, CL3R, CMR

\*CMR listing does not apply to 12 AWG and 14 AWG Superior Essex Fire Alarm cables. UL is a registered trademark of UL LLC.

### ENVIRONMENTAL SPECIFICATIONS

<b>Operation</b>	-4°F to +167°F (-20°C to +75°C)
<b>Installation</b>	+32°F to +149°F (0°C to +65°C)

### PRODUCT DESCRIPTION

Superior Essex has a full line of fire alarm riser rated cables with interlocked aluminum armor. The addition of aluminum interlock armor over the red jacketed fire alarm cable provides significant mechanical protection and installation savings; adding the interlock armor eliminates the requirement for rigid, expensive pipes or conduits. These cables are available in both shielded and non-shielded versions with a wide range of conductor counts and gauges. The fire alarm cables with interlock armor can be used for a variety of life safety devices such as sirens, smoke detectors, and control systems. Together the cable and the interlocking armor provide multiple compliance levels, including NEC Article 760 (FPLR), NEC Article 725 (CL3R), and NEC Article 800 (CMR). All fire alarm cables are power limited rated for 300V. Each individual cable is retested after adding the interlock armoring to ensure all applicable industry requirements are met.

### APPLICATIONS

- Smoke detectors
- Alarm notification
- Strobes
- Sirens
- Pull stations
- Addressable control systems
- Circuits controlled and powered by the fire alarm system
- Sprinkler and sprinkler supervisory systems

### FEATURES

- Aluminum interlock armor
- Installed directly from reel
- 50% cost savings
- Aluminum interlock armor can be removed

### BENEFITS

- Protects against mechanical stress and EMI/RFI for ensured and reliable performance
- Faster installation; fewer tools/equipment and less labor is required
- Saves labor and installation time; rigid conduit and pipes not necessary; finish job faster
- Maintains the fire rating even after interlock armor is removed

## PART NUMBERS AND PHYSICAL CHARACTERISTICS

Listing	Part Number	Conductor Count	AWG (mm)	Nominal Diameter in (mm)	Approx. Weight lbs/kft (kg/km)	Package
<b>Non-Shielded Component</b>						
FPLR/CL3R	K2F-419-91	2	12 (2.05)	0.50 (12.7)	83 (124)	1,000' Wood reel
FPLR/CL3R	K2F-429-91	3	12 (2.05)	0.50 (12.7)	107 (159)	1,000' Wood reel
FPLR/CL3R	K2F-319-91	2	14 (1.63)	0.50 (12.7)	67 (100)	1,000' Wood reel
FPLR/CL3R	K2F-329-91	3	14 (1.63)	0.50 (12.7)	80 (119)	1,000' Wood reel
FPLR/CL3R	K2F-339-91	4	14 (1.63)	0.50 (12.7)	100 (149)	1,000' Wood reel
FPLR/CL3R/CMR	K2F-219-91	2	16 (1.29)	0.50 (12.7)	57 (85)	1,000' Wood reel
FPLR/CL3R/CMR	K2F-229-91	3	16 (1.29)	0.50 (12.7)	66 (98)	1,000' Wood reel
FPLR/CL3R/CMR	K2F-239-91	4	16 (1.29)	0.50 (12.7)	76 (113)	1,000' Wood reel
FPLR/CL3R/CMR	K2F-119-91	2	18 (1.02)	0.50 (12.7)	50 (74)	1,000' Wood reel
FPLR/CL3R/CMR	K2F-129-91	3	18 (1.02)	0.50 (12.7)	56 (83)	1,000' Wood reel
FPLR/CL3R/CMR	K2F-139-91	4	18 (1.02)	0.50 (12.7)	63 (94)	1,000' Wood reel
FPLR/CL3R/CMR	K2F-519-91	2	22 (0.64)	0.50 (12.7)	42 (63)	1,000' Wood reel
FPLR/CL3R/CMR	K2F-529-91	3	22 (0.64)	0.50 (12.7)	44 (66)	1,000' Wood reel
FPLR/CL3R/CMR	K2F-539-91	4	22 (0.64)	0.50 (12.7)	48 (71)	1,000' Wood reel
<b>Overall Shielded Component</b>						
FPLR/CL3R	K2F-419-92	2	12 (2.05)	0.50 (12.7)	85 (127)	1,000' Wood reel
FPLR/CL3R	K2F-319-92	2	14 (1.63)	0.50 (12.7)	70 (104)	1,000' Wood reel
FPLR/CL3R	K2F-329-92	3	14 (1.63)	0.50 (12.7)	83 (124)	1,000' Wood reel
FPLR/CL3R	K2F-339-92	4	14 (1.63)	0.50 (12.7)	99 (147)	1,000' Wood reel
FPLR/CL3R/CMR	K2F-219-92	2	16 (1.29)	0.50 (12.7)	59 (88)	1,000' Wood reel
FPLR/CL3R/CMR	K2F-229-92	3	16 (1.29)	0.50 (12.7)	69 (103)	1,000' Wood reel
FPLR/CL3R/CMR	K2F-239-92	4	16 (1.29)	0.50 (12.7)	78 (116)	1,000' Wood reel
FPLR/CL3R/CMR	K2F-119-92	2	18 (1.02)	0.50 (12.7)	52 (77)	1,000' Wood reel
FPLR/CL3R/CMR	K2F-129-92	3	18 (1.02)	0.50 (12.7)	59 (88)	1,000' Wood reel
FPLR/CL3R/CMR	K2F-139-92	4	18 (1.02)	0.50 (12.7)	65 (97)	1,000' Wood reel
FPLR/CL3R/CMR	K2F-519-92	2	22 (0.64)	0.50 (12.7)	44 (66)	1,000' Wood reel
FPLR/CL3R/CMR	K2F-529-92	3	22 (0.64)	0.50 (12.7)	47 (70)	1,000' Wood reel
FPLR/CL3R/CMR	K2F-539-92	4	22 (0.64)	0.50 (12.7)	50 (74)	1,000' Wood reel

Additional cable combinations are available. Other color sequences available upon request.

# Security Control, Non-Shielded

Power Limited, Riser/Plenum

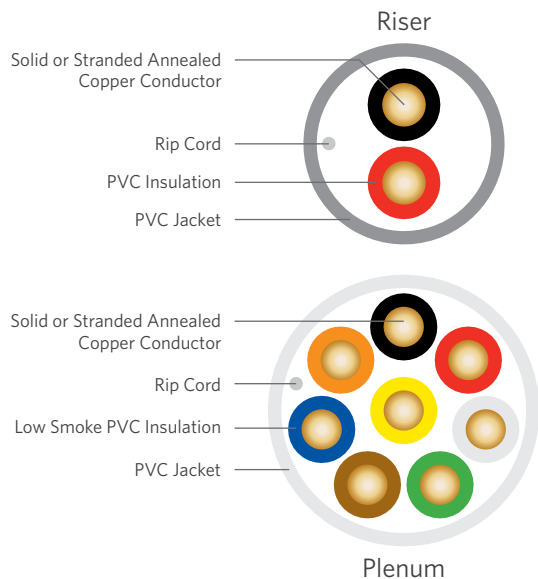

## SPECIFICATIONS

<b>Conductor Count</b>	Available with 2 through 12 conductors
<b>Conductor</b>	Fully annealed, solid or stranded bare copper
<b>AWG (mm)</b>	Available in 12 (2.05) through 22 (0.64)
<b>Insulation</b>	Low smoke PVC
<b>Insulation Colors</b>	Conductor 1: Black Conductor 2: Red Conductor 3: White Conductor 4: Green Conductor 5: Brown Conductor 6: Blue Conductor 7: Orange Conductor 8: Yellow Conductor 9: Violet Conductor 10: Gray Conductor 11: Pink Conductor 12: Tan
<b>Jacket</b>	Riser: Gray, Flame Retardant (FR) PVC (Available in other jacket colors) Plenum: White, Low smoke PVC (Available in other jacket colors)
<b>Package</b>	Black, ribbed, plastic recyclable spool, Reel-in-a-Box or wood reel
<b>Performance Compliance</b>	NEC Article 725 NEC Article 800 NEC Article 760 UL® 13 CL3R/CL3P UL 444 CMR/CMP* UL 1424 FPLR/FPLP UL 1666 NFPA 262 California State Fire Marshall RoHS-compliant/RoHS 2-compliant
<b>NRTL Programs</b>	UL Listed CL3R, CMR, FPLR UL Listed CL3P, CMP, FPLP

\*CMP listing does not apply to 12 AWG and 14 AWG Superior Essex Security Control cables.  
UL is a registered trademark of UL LLC.

## PRODUCT DESCRIPTION

Security Control cables are used for a variety of building control and audio applications. The non-shielded security control cable series is ideal for environments where electromagnetic interference (EMI) is not a concern or the cable is not required to be grounded. All riser listed security control cables provide compliance to NEC Article 725, NEC Article 760, CL3R and FPLR. All plenum listed security control cables provide compliance to NEC Article 725, NEC Article 760, CL3P and FPLP. All security control cables are power limited rated for 300V.

## APPLICATIONS

- Intercom
- Security
- Audio, public address system, speakers
- Burglar alarm system
- Telephone stations
- Background music
- Sensors

## FEATURES

- Non-plenum, riser rated
- Plenum rated
- Jacket rip cord
- CableID® alpha numeric code printed every 2 feet
- QuickCount® marking system in feet and meters
- Black, plastic recyclable spool packaging (standard)

## BENEFITS

- Simplifies selection with multiple listings (CL3R, CMR, FPL and FPLR)
- Simplifies selection with multiple listings (CL3P, CMP\* and FPLP)
- Easy to open; saves cable preparation time
- Allows both ends of a cable run to be easily identifiable without the need to separately label or tone the cable
- Saves on installation time
- Provides remaining length of cable on spool resulting in less scrap
- Robust and easy to handle

## ENVIRONMENTAL SPECIFICATIONS

<b>Operation</b>	-4°F to +167°F (-20°C to +75°C)
<b>Installation</b>	+32°F to +149°F (0°C to +65°C)

**PART NUMBERS AND PHYSICAL CHARACTERISTICS**

Listing	Part Number <sup>1</sup>	Conductor Count	AWG (mm)	Conductor Type	Jacket Color <sup>2</sup>	Nominal Diameter in (mm)	Approx. Weight lbs/kft (kg/km)
CL3R/CMR/FPLR	2F-F1x-31	2	12 (2.05)	19 x 0.0185	Gray	0.25 (6.4)	51 (76)
CL3R/CMR/FPLR	2F-F2x-31	3	12 (2.05)	19 x 0.0185	Gray	0.27 (6.8)	77 (34)
CL3R/CMR/FPLR	2F-E1x-31	2	14 (1.85)	19 x 0.0147	Gray	0.22 (5.6)	34 (51)
CL3R/CMR/FPLR	2F-E2x-31	3	14 (1.85)	19 x 0.0147	Gray	0.23 (6.0)	47 (21)
CL3R/CMR/FPLR	2F-E3x-31	4	14 (1.85)	19 x 0.0147	Gray	0.25 (6.4)	64 (95)
CL3R/CMR/FPLR	2F-D1x-31	2	16 (1.46)	19 x 0.0117	Gray	0.19 (4.8)	24 (36)
CL3R/CMR/FPLR	2F-D2x-31	3	16 (1.46)	19 x 0.0117	Gray	0.20 (5.1)	32 (14)
CL3R/CMR/FPLR	2F-D3x-31	4	16 (1.46)	19 x 0.0117	Gray	0.22 (5.6)	43 (64)
CL3R/CMR/FPLR	2F-C1x-31	2	18 (1.16)	7 x 26 AWG	Gray	0.16 (4.1)	17 (25)
CL3R/CMR/FPLR	2F-C2x-31	3	18 (1.16)	7 x 26 AWG	Gray	0.17 (4.3)	22 (9)
CL3R/CMR/FPLR	2F-C3x-31	4	18 (1.16)	7 x 26 AWG	Gray	0.19 (4.8)	30 (45)
CL3R/CMR/FPLR	2F-C4x-31	6	18 (1.16)	7 x 26 AWG	Gray	0.23 (5.8)	43 (64)
CL3R/CMR/FPLR	2F-C5x-31	8	18 (1.16)	7 x 26 AWG	Gray	0.25 (6.4)	56 (83)
CL3R/CMR/FPLR	2F-C7x-31	12	18 (1.16)	7 x 26 AWG	Gray	0.30 (7.6)	83 (124)
CL3R/CMR/FPLR	2F-B1x-31	2	20 (0.92)	7 x 28 AWG	Gray	0.14 (3.6)	12 (18)
CL3R/CMR/FPLR	2F-B2x-31	3	20 (0.92)	7 x 28 AWG	Gray	0.15 (3.8)	15 (6)
CL3R/CMR/FPLR	2F-B3x-31	4	20 (0.92)	7 x 28 AWG	Gray	0.16 (4.1)	21 (31)
CL3R/CMR/FPLR	2F-A1x-31	2	22 (0.73)	7 x 30 AWG	Gray	0.13 (3.3)	9 (13)
CL3R/CMR/FPLR	2F-A2x-31	3	22 (0.73)	7 x 30 AWG	Gray	0.14 (3.5)	11 (4)
CL3R/CMR/FPLR	2F-A3x-31	4	22 (0.73)	7 x 30 AWG	Gray	0.15 (3.8)	15 (22)
CL3R/CMR/FPLR	2F-A4x-31	6	22 (0.73)	7 x 30 AWG	Gray	0.18 (4.6)	21 (31)
CL3R/CMR/FPLR	2F-A5x-31	8	22 (0.73)	7 x 30 AWG	Gray	0.19 (4.8)	28 (42)
CL3R/CMR/FPLR	2F-A6x-31	10	22 (0.73)	7 x 30 AWG	Gray	0.22 (5.6)	34 (51)
CL3R/CMR/FPLR	2F-A7x-31	12	22 (0.73)	7 x 30 AWG	Gray	0.23 (5.8)	40 (60)
CL3R/CMR/FPLR	2F-51x-31	2	22 (0.64)	Solid	Gray	0.12 (3.0)	8 (12)
CL3R/CMR/FPLR	2F-52x-31	3	22 (0.64)	Solid	Gray	0.13 (3.3)	10 (4)
CL3R/CMR/FPLR	2F-53x-31	4	22 (0.64)	Solid	Gray	0.14 (3.6)	14 (21)
CL3P/FPLP	2F-F1x-43	2	12 (2.05)	19 x 0.0185	White	0.25 (6.4)	52 (77)
CL3P/FPLP	2F-F2x-43	3	12 (2.05)	19 x 0.0185	White	0.27 (6.8)	78 (35)
CL3P/FPLP	2F-E1x-43	2	14 (1.85)	19 x 0.0147	White	0.22 (5.6)	35 (52)
CL3P/FPLP	2F-E2x-43	3	14 (1.85)	19 x 0.0147	White	0.23 (6.0)	48 (21)
CL3P/FPLP	2F-E3x-43	4	14 (1.85)	19 x 0.0147	White	0.25 (6.4)	65 (97)
CL3P/CMP/FPLP	2F-D1x-43	2	16 (1.46)	19 x 0.0117	White	0.19 (4.8)	24 (36)
CL3P/CMP/FPLP	2F-D2x-43	3	16 (1.46)	19 x 0.0117	White	0.20 (5.1)	32 (14)
CL3P/CMP/FPLP	2F-D3x-43	4	16 (1.46)	19 x 0.0117	White	0.22 (5.6)	44 (65)
CL3P/CMP/FPLP	2F-C1x-43	2	18 (1.16)	7 x 26 AWG	White	0.16 (4.1)	17 (25)
CL3P/CMP/FPLP	2F-C2x-43	3	18 (1.16)	7 x 26 AWG	White	0.17 (4.3)	22 (9)
CL3P/CMP/FPLP	2F-C3x-43	4	18 (1.16)	7 x 26 AWG	White	0.19 (4.8)	30 (45)
CL3P/CMP/FPLP	2F-C4x-43	6	18 (1.16)	7 x 26 AWG	White	0.23 (5.8)	44 (65)
CL3P/CMP/FPLP	2F-C5x-43	8	18 (1.16)	7 x 26 AWG	White	0.25 (6.4)	57 (85)
CL3P/CMP/FPLP	2F-C7x-43	12	18 (1.16)	7 x 26 AWG	White	0.30 (7.6)	85 (126)
CL3P/CMP/FPLP	2F-B1x-43	2	20 (0.92)	7 x 28 AWG	White	0.14 (3.6)	13 (19)
CL3P/CMP/FPLP	2F-B2x-43	3	20 (0.92)	7 x 28 AWG	White	0.15 (3.8)	16 (7)
CL3P/CMP/FPLP	2F-B3x-43	4	20 (0.92)	7 x 28 AWG	White	0.16 (4.1)	22 (33)
CL3P/CMP/FPLP	2F-A1x-43	2	22 (0.73)	7 x 30 AWG	White	0.13 (3.3)	9 (13)
CL3P/CMP/FPLP	2F-A2x-43	3	22 (0.73)	7 x 30 AWG	White	0.14 (3.5)	11 (4)
CL3P/CMP/FPLP	2F-A3x-43	4	22 (0.73)	7 x 30 AWG	White	0.15 (3.8)	16 (24)
CL3P/CMP/FPLP	2F-A4x-43	6	22 (0.73)	7 x 30 AWG	White	0.18 (4.6)	22 (33)
CL3P/CMP/FPLP	2F-A5x-43	8	22 (0.73)	7 x 30 AWG	White	0.19 (4.8)	28 (42)
CL3P/CMP/FPLP	2F-A6x-43	10	22 (0.73)	7 x 30 AWG	White	0.22 (5.6)	35 (52)
CL3P/CMP/FPLP	2F-A7x-43	12	22 (0.73)	7 x 30 AWG	White	0.23 (5.8)	41 (61)
CL3P/CMP/FPLP	2F-51x-43	2	22 (0.64)	Solid	White	0.12 (3.0)	9 (13)
CL3P/CMP/FPLP	2F-52x-43	3	22 (0.64)	Solid	White	0.13 (3.3)	11 (4)
CL3P/CMP/FPLP	2F-53x-43	4	22 (0.64)	Solid	White	0.14 (3.6)	15 (22)

<sup>1</sup>Additional jacket colors are available.

	Plastic Spool		Reel-in-a-Box		Wood Reel
	1,000'	500'	1,000'	500'	1,000'
<sup>1</sup> Replace "x" with:	2	3	4	5	6

# Security Control, Shielded

Power Limited, Riser/Plenum

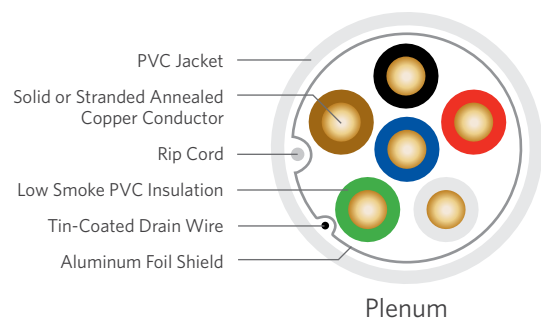
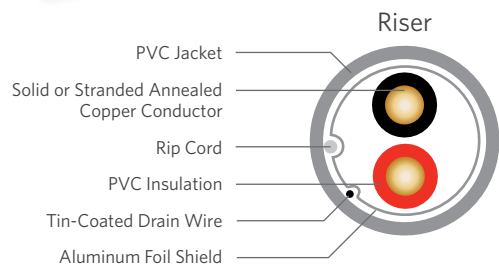

## SPECIFICATIONS

<b>Conductor Count</b>	Available with 2 through 12 conductors
<b>Conductor</b>	Fully annealed, solid or stranded bare copper
<b>AWG (mm)</b>	Available in 12 (2.05) through 22 (0.64)
<b>Insulation</b>	PVC
<b>Insulation Colors</b>	Conductor 1: Black Conductor 2: Red Conductor 3: White Conductor 4: Green Conductor 5: Brown Conductor 6: Blue Conductor 7: Orange Conductor 8: Yellow Conductor 9: Violet Conductor 10: Gray Conductor 11: Pink Conductor 12: Tan
<b>Shield</b>	1-mil overall aluminum polyester foil shield with 24 AWG (0.51 mm) solid tinned copper drain wire
<b>Jacket</b>	Riser: Gray, Flame Retardant (FR) PVC (Available in other jacket colors) Plenum: White, Low smoke PVC (Available in other jacket colors)
<b>Package</b>	Black, ribbed, plastic recyclable spool, Reel-in-a-Box or wood reel
<b>Performance Compliance</b>	NEC Article 725 NEC Article 800 NEC Article 760 UL® 13 CL3R/CL3P UL 444 CMR/CMP* UL 1424 FPLR/FPLP UL 1666 NFPA 262 California State Fire Marshall RoHS-compliant/RoHS 2-compliant
<b>NRTL Programs</b>	UL Listed CL3R, CMR, FPLR UL Listed CL3P, CMP, FPLP

\*CMR/CMP listing does not apply to 12 AWG and 14 AWG Superior Essex Security Control cables. UL is a registered trademark of UL LLC.

## PRODUCT DESCRIPTION

Security Control cables are used for a variety building control and audio applications. The security control, shielded cable series is ideal for environments where electromagnetic interference (EMI) is a concern or the cable is required to be grounded. All riser listed security control cables provide compliance to NEC Article 725, NEC Article 760, CL3R and FPLR. All plenum listed security control cables provide compliance to NEC Article 725, NEC Article 760, CL3P and FPLP. All security control cables are power limited rated for 300V.

## APPLICATIONS

- Intercom
- Security
- Audio, public address system, speakers
- Burglar alarm system
- Telephone stations
- Background music

## FEATURES

- Non-plenum, riser rated
- Plenum rated
- Jacket rip cord
- Overall shield
- CableID® alpha numeric code printed every 2 feet
- QuickCount® marking system in feet and meters
- Black, plastic recyclable spool packaging (standard)

## BENEFITS

- Simplifies selection with multiple listings (CL3R, CMR\*, FPL and FPLR)
- Simplifies selection with multiple listings (CL3P, CMP\* and FPLP)
- Easy to open; saves cable preparation time
- Electromagnetic Interference (EMI) protection
- Allows both ends of a cable run to be easily identifiable without the need to separately label or tone the cable
- Saves on installation time
- Provides remaining length of cable on spool resulting in less scrap
- Robust and easy to handle

## ENVIRONMENTAL SPECIFICATIONS

<b>Operation</b>	-4°F to +167°F (-20°C to +75°C)
<b>Installation</b>	+32°F to +149°F (0°C to +65°C)



**PART NUMBERS AND PHYSICAL CHARACTERISTICS**

Listing	Part Number <sup>1</sup>	Conductor Count	AWG (mm)	Conductor Type	Jacket Color <sup>2</sup>	Nominal Diameter in (mm)	Approx. Weight lbs/kft (kg/km)
CL3R/FPLR	2F-F1x-32	2	12 (2.05)	19 x 0.0185	Gray	0.26 (6.6)	53 (79)
CL3R/FPLR	2F-E1x-32	2	14 (1.85)	19 x 0.0147	Gray	0.23 (5.8)	36 (54)
CL3R/FPLR	2F-E2x-32	3	14 (1.85)	19 x 0.0147	Gray	0.25 (6.2)	49 (22)
CL3R/FPLR	2F-E3x-32	4	14 (1.85)	19 x 0.0147	Gray	0.26 (6.6)	66 (98)
CL3R/CMR/FPLR	2F-D1x-32	2	16 (1.46)	19 x 0.0117	Gray	0.20 (5.1)	26 (39)
CL3R/CMR/FPLR	2F-D2x-32	3	16 (1.46)	19 x 0.0117	Gray	0.21 (5.4)	35 (15)
CL3R/CMR/FPLR	2F-D3x-32	4	16 (1.46)	19 x 0.0117	Gray	0.23 (5.8)	45 (67)
CL3R/CMR/FPLR	2F-C1x-32	2	18 (1.16)	7 x 26 AWG	Gray	0.17 (4.3)	19 (28)
CL3R/CMR/FPLR	2F-C2x-32	3	18 (1.16)	7 x 26 AWG	Gray	0.18 (4.6)	24 (10)
CL3R/CMR/FPLR	2F-C3x-32	4	18 (1.16)	7 x 26 AWG	Gray	0.20 (5.1)	32 (48)
CL3R/CMR/FPLR	2F-C4x-32	6	18 (1.16)	7 x 26 AWG	Gray	0.24 (6.1)	45 (67)
CL3R/CMR/FPLR	2F-C5x-32	8	18 (1.16)	7 x 26 AWG	Gray	0.26 (6.6)	59 (88)
CL3R/CMR/FPLR	2F-C6x-32	10	18 (1.16)	7 x 26 AWG	Gray	0.29 (7.4)	72 (107)
CL3R/CMR/FPLR	2F-C7x-32	12	18 (1.16)	7 x 26 AWG	Gray	0.31 (7.9)	86 (128)
CL3R/CMR/FPLR	2F-B1x-32	2	20 (0.92)	7 x 28 AWG	Gray	0.15 (3.8)	14 (21)
CL3R/CMR/FPLR	2F-B2x-32	3	20 (0.92)	7 x 28 AWG	Gray	0.16 (4.1)	18 (8)
CL3R/CMR/FPLR	2F-B3x-32	4	20 (0.92)	7 x 28 AWG	Gray	0.17 (4.3)	23 (34)
CL3R/CMR/FPLR	2F-A1x-32	2	22 (0.73)	7 x 30 AWG	Gray	0.14 (3.6)	11 (16)
CL3R/CMR/FPLR	2F-A2x-32	3	22 (0.73)	7 x 30 AWG	Gray	0.15 (3.8)	13 (5)
CL3R/CMR/FPLR	2F-A3x-32	4	22 (0.73)	7 x 30 AWG	Gray	0.16 (4.1)	17 (25)
CL3R/CMR/FPLR	2F-A4x-32	6	22 (0.73)	7 x 30 AWG	Gray	0.19 (4.8)	24 (36)
CL3R/CMR/FPLR	2F-A5x-32	8	22 (0.73)	7 x 30 AWG	Gray	0.20 (5.1)	30 (45)
CL3R/CMR/FPLR	2F-A6x-32	10	22 (0.73)	7 x 30 AWG	Gray	0.23 (5.8)	36 (54)
CL3R/CMR/FPLR	2F-A7x-32	12	22 (0.73)	7 x 30 AWG	Gray	0.24 (6.1)	42 (63)
CL3R/CMR/FPLR	2F-51x-32	2	22 (0.64)	Solid	Gray	0.13 (3.3)	10 (15)
CL3R/CMR/FPLR	2F-52x-32	3	22 (0.64)	Solid	Gray	0.14 (3.5)	13 (5)
CL3P/FPLP	2F-F1x-44	2	12 (2.05)	19 x 0.0185	White	0.26 (6.6)	54 (80)
CL3P/FPLP	2F-F2x-44	3	12 (2.05)	19 x 0.0185	White	0.28 (7.0)	81 (36)
CL3P/FPLP	2F-E1x-44	2	14 (1.85)	19 x 0.0147	White	0.23 (5.8)	37 (55)
CL3P/FPLP	2F-E2x-44	3	14 (1.85)	19 x 0.0147	White	0.25 (6.2)	50 (22)
CL3P/FPLP	2F-E3x-44	4	14 (1.85)	19 x 0.0147	White	0.26 (6.6)	67 (100)
CL3P/CMP/FPLP	2F-D1x-44	2	16 (1.46)	19 x 0.0117	White	0.20 (5.1)	26 (39)
CL3P/CMP/FPLP	2F-D2x-44	3	16 (1.46)	19 x 0.0117	White	0.21 (5.4)	35 (15)
CL3P/CMP/FPLP	2F-D3x-44	4	16 (1.46)	19 x 0.0117	White	0.23 (5.8)	46 (68)
CL3P/CMP/FPLP	2F-C1x-44	2	18 (1.16)	7 x 26 AWG	White	0.17 (4.3)	19 (28)
CL3P/CMP/FPLP	2F-C2x-44	3	18 (1.16)	7 x 26 AWG	White	0.18 (4.6)	25 (11)
CL3P/CMP/FPLP	2F-C3x-44	4	18 (1.16)	7 x 26 AWG	White	0.20 (5.1)	33 (49)
CL3P/CMP/FPLP	2F-C4x-44	6	18 (1.16)	7 x 26 AWG	White	0.24 (6.1)	47 (70)
CL3P/CMP/FPLP	2F-C5x-44	8	18 (1.16)	7 x 26 AWG	White	0.26 (6.6)	60 (89)
CL3P/CMP/FPLP	2F-C7x-44	12	18 (1.16)	7 x 26 AWG	White	0.31 (7.9)	87 (129)
CL3P/CMP/FPLP	2F-B1x-44	2	20 (0.92)	7 x 28 AWG	White	0.15 (3.8)	15 (22)
CL3P/CMP/FPLP	2F-B2x-44	3	20 (0.92)	7 x 28 AWG	White	0.16 (4.1)	18 (8)
CL3P/CMP/FPLP	2F-B3x-44	4	20 (0.92)	7 x 28 AWG	White	0.17 (4.3)	24 (36)
CL3P/CMP/FPLP	2F-A1x-44	2	22 (0.73)	7 x 30 AWG	White	0.14 (3.6)	11 (16)
CL3P/CMP/FPLP	2F-A2x-44	3	22 (0.73)	7 x 30 AWG	White	0.15 (3.8)	14 (6)
CL3P/CMP/FPLP	2F-A3x-44	4	22 (0.73)	7 x 30 AWG	White	0.16 (4.1)	18 (27)
CL3P/CMP/FPLP	2F-A4x-44	6	22 (0.73)	7 x 30 AWG	White	0.19 (4.8)	24 (36)
CL3P/CMP/FPLP	2F-A5x-44	8	22 (0.73)	7 x 30 AWG	White	0.20 (5.1)	31 (46)
CL3P/CMP/FPLP	2F-A6x-44	10	22 (0.73)	7 x 30 AWG	White	0.23 (5.8)	37 (55)
CL3P/CMP/FPLP	2F-A7x-44	12	22 (0.73)	7 x 30 AWG	White	0.24 (6.1)	43 (64)
CL3P/CMP/FPLP	2F-51x-44	2	22 (0.64)	Solid	White	0.13 (3.3)	11 (16)
CL3P/CMP/FPLP	2F-52x-44	3	22 (0.64)	Solid	White	0.14 (3.5)	13 (5)

<sup>2</sup>Additional jacket colors are available.

	Plastic Spool		Reel-in-a-Box		Wood Reel
	1,000'	500'	1,000'	500'	1,000'
<sup>1</sup> Replace "x" with:	2	3	4	5	6

# Access Control Composite

Riser/Plenum

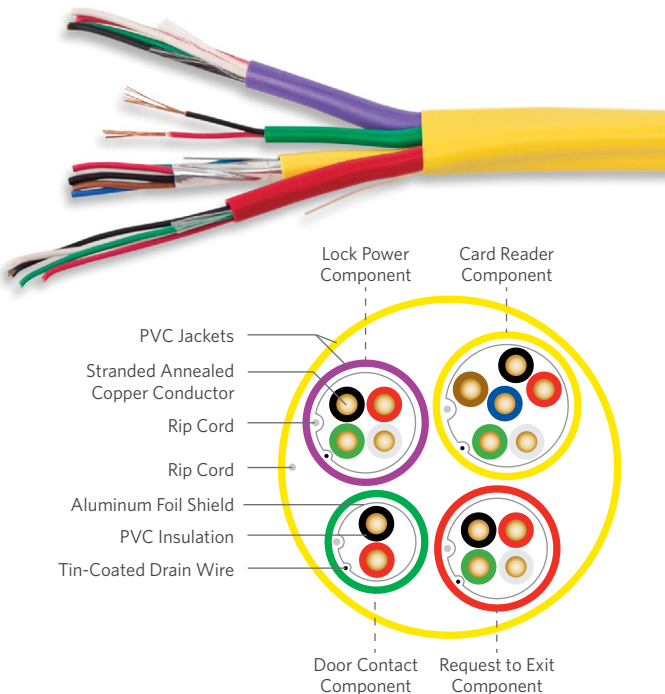

## PRODUCT DESCRIPTION

The Access Control Composite series combines four components that are required for card reader/keypad, door contact, request to exit and lock power device connectivity in a single cable. These composites are offered with an option to shield all components or just the single card reader component. Both riser and plenum jacket constructions are available.

## APPLICATIONS

- Access control

## FEATURES

- Four components in a single jacket
- Twisted pair in card reader component
- Jacket rip cord
- Overall shield (where applicable)
- QuickCount® marking system in feet and meters

## BENEFITS

- Save labor costs with a one cable run
- Satisfies requirements of RS-232 and RS-485 protocols
- Easy to open; saves cable preparation time
- Electromagnetic Interference (EMI) protection
- Provides remaining length of cable on spool resulting in less scrap

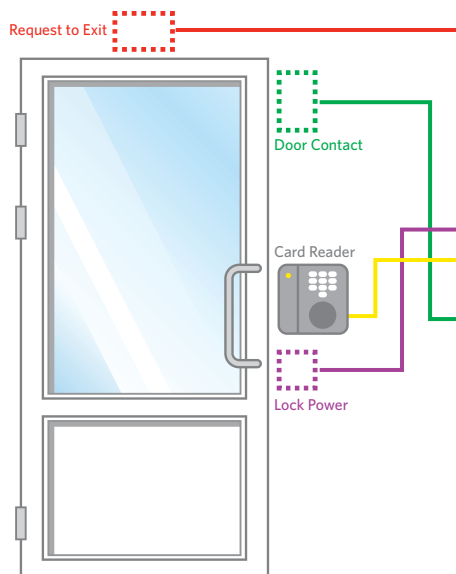

## COMPONENT COLOR CODING AND APPLICATION

Component Number	Cable Type	Application	Component Jacket Color
1	18 AWG x 4 conductors	Lock Power	Purple
2	22 AWG x 3 twisted pairs	Card Reader	Yellow
3	22 AWG x 4 conductors	Request to Exit	Red
4	22 AWG x 2 conductors	Door Contact	Green

## ENVIRONMENTAL SPECIFICATIONS

Operation	-4°F to +167°F (-20°C to +75°C)
Installation	+32°F to +149°F (0°C to +65°C)

## COMPOSITE SPECIFICATIONS

Outer Jacket	Riser: Flame Retardant (FR) PVC Plenum: Low smoke PVC
Jacket Marking	Example: XXXX FT/XXXX M SUPERIOR ESSEX ACCESS CONTROL CABLE DOOR / ZONE A B C D E / 0 1 2 3 4 5 6 7 8 9 18/4C + 22/3PR SHLD + 22/4C + 22/2C (UL) CMR/CL3R OR c(UL) CMR 75°C "ROHS COMPLIANT"
Package	Wood reel
Performance Compliance	NEC Article 725 NEC Article 800 NEC Article 760 UL® 13 CL3R/CL3P UL 444 CMR/CMP UL 1424 FPLR/FPLP UL 1666 NFPA 262 California State Fire Marshall RoHS-compliant/RoHS 2-compliant
NRTL Programs	UL Listed CL3R, CMR, FPLR UL Listed CL3P, CMP, FPLP c(UL) Listed CMR c(UL) Listed CMP

UL is a registered trademark of UL LLC.

## COMPONENT SPECIFICATIONS

Conductor/Pair Count	Available with 2 through 4 conductors and available with 3 twisted pairs
Conductor	Fully annealed, stranded bare copper
AWG (mm)	Available in 18 (1.16) and 22 (0.64)
Insulation	Low smoke PVC
Shield (where applicable)	1-mil overall aluminum polyester foil shield with 24 AWG (0.51 mm) solid tinned copper drain wire
Component Jacket	Riser: Flame Retardant (FR) PVC Plenum: Low smoke PVC
Component Jacket Marking	Example: LOCK POWER DOOR / ZONE A B C D E / 0 1 2 3 4 5 6 7 8 9 18 AWG/4C PLENUM

**PART NUMBERS AND PHYSICAL CHARACTERISTICS**

Listing	Part Number <sup>1</sup>	Component Number	Application	Component Description	Insulation Colors	Component Jacket Color	Outer Jacket Color	Nominal Diameter in (mm)	Approx. Weight lbs/kft (kg/km)
CMR/CL3R/ FPLR	AC-A1x-55	1	Lock Power	18 AWG x 4 conductors, non-shielded	Black, Red, White, Green	Purple	Green	0.46 (11.7)	105 (156)
		2	Card Reader	22 AWG x 3 twisted pairs, shielded	Black/Red, White/Green, Brown/Blue	Yellow			
		3	Request Exit	22 AWG x 4 conductors, non-shielded	Black, Red, White, Green	Red			
		4	Door Contact	22 AWG x 2 conductors, non-shielded	Black, Red	Green			
CMR/CL3R/ FPLR	AC-A2x-55	1	Lock Power	18 AWG x 4 conductors, shielded	Black, Red, White, Green	Purple	Green	0.47 (11.9)	110 (164)
		2	Card Reader	22 AWG x 3 twisted pairs, shielded	Black/Red, White/Green, Brown/Blue	Yellow			
		3	Request Exit	22 AWG x 4 conductors, shielded	Black, Red, White, Green	Red			
		4	Door Contact	22 AWG x 2 conductors, shielded	Black, Red	Green			
CMP/CL3P/ FPLP	AC-A1x-68	1	Lock Power	18 AWG x 4 conductors, non-shielded	Black, Red, White, Green	Purple	Yellow	0.46 (11.7)	105 (156)
		2	Card Reader	22 AWG x 3 twisted pairs, shielded	Black/Red, White/Green, Brown/Blue	Yellow			
		3	Request Exit	22 AWG x 4 conductors, non-shielded	Black, Red, White, Green	Red			
		4	Door Contact	22 AWG x 2 conductors, non-shielded	Black, Red	Green			
CMP/CL3P/ FPLP	AC-A2x-68	1	Lock Power	18 AWG x 4 conductors, shielded	Black, Red, White, Green	Purple	Yellow	0.47 (11.9)	110 (164)
		2	Card Reader	22 AWG x 3 twisted pairs, shielded	Black/Red, White/Green, Brown/Blue	Yellow			
		3	Request Exit	22 AWG x 4 conductors, shielded	Black, Red, White, Green	Red			
		4	Door Contact	22 AWG x 2 conductors, shielded	Black, Red	Green			

**PACKAGING OPTIONS**

	Wood Reel	
	1,000'	500'
<sup>1</sup> Replace "x" with:	2	3

# ABAM (600B) and ABMM Series

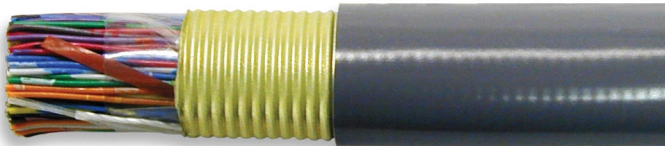

## SPECIFICATIONS

Conductor	Tinned copper
Insulation	PE/PVC
Core Wrap	Non-hygroscopic, dielectric tape
Shield	Corrugated 8 mil aluminum bonded to the outer jacket
Jacket	Gray PVC printed at 2 foot intervals including product identification, pair count, UL information and sequential lengths in feet and meters
Performance Compliance	Telcordia® GR-137 (select sections) Telcordia GR-111 ASTM B33 - Tinned Copper UL® 444 CSA C22.2 No. 214-08 UL 1666 ANSI/TIA-568.2-D RoHS-compliant/RoHS 2-compliant
NRTL Programs	UL, c(UL) Listed CMR

## PRODUCT DESCRIPTION

The ABAM (600B) and ABMM Series Central Office (CO) Cables are designed for use between switching and transmission equipment for distances up to 650 feet. The ABAM (600B) series offers low attenuation by using 22 AWG conductors. Both ABAM (600B) and ABMM series (24 AWG) are manufactured with a dark gray smooth PVC jacket and a 0.008 inch corrugated aluminum shield for additional Electromagnetic Interference (EMI) reduction.

## APPLICATIONS

- T1/DS1
- T1C/DS1C
- DS2
- 4 Mbps token ring (IEEE 802.5)
- 10 Mbps 10BASE-T Ethernet (IEEE 802.3)

## FEATURES

- 22 and 24 AWG tinned copper conductors
- 100 Ohm nominal Impedance
- 0.008 inch corrugated aluminum shield
- CMR listed
- CAT 3 compliant
- Band marked conductors

## BENEFITS

- Low attenuation, enabling longer run length; tinned copper conductors minimize change in wire-wrap joint resistance
- Impedance mismatch with OSP cable is minimized
- Higher EMI isolation over foil shields; great mechanical strength
- Suitable for horizontal and vertical installations
- Suitable for network applications
- Easy identification of conductor ring mates

## PART NUMBERS AND PHYSICAL CHARACTERISTICS

Series	Part Number	Product Code	Pair Count	AWG (mm)	Nominal Diameter in (mm)	Approx. Weight lbs/kft (kg/km)	Standard Length ft (m)	Package
ABAM	55-399-25	606B	6	22 (0.6)	0.42 (11)	87 (129)	10,000 (3,048)	Reel
ABAM	55-499-25	607B	12	22 (0.6)	0.50 (13)	132 (196)	7,000 (2,135)	Reel
ABAM	55-599-25	608B	16	22 (0.6)	0.55 (14)	159 (237)	7,000 (2,135)	Reel
ABAM	55-999-25	613B	30	22 (0.6)	0.69 (18)	257 (382)	5,000 (1,524)	Reel
ABAM	55-A99-25	615B	32	22 (0.6)	0.71 (18)	270 (402)	5,000 (1,524)	Reel
ABAM	55-B99-25	610B	50	22 (0.6)	0.84 (21)	383 (570)	7,500 (2,285)	Reel
ABAM	55-D99-25	612B	75	22 (0.6)	1.02 (26)	561 (835)	3,000 (915)	Reel
ABAM	55-E99-25	611B	100	22 (0.6)	1.14 (29)	711 (1,058)	7,500 (2,285)	Reel
ABMM	55-799-24	-	25	24 (0.5)	0.57 (15)	164 (244)	10,000 (3,048)	Reel
ABMM	55-B99-24	-	50	24 (0.5)	0.73 (19)	276 (411)	10,000 (3,048)	Reel
ABMM	55-E99-24	-	100	24 (0.5)	0.99 (25)	505 (725)	10,000 (3,048)	Reel
ABMM	55-V99-24	-	600	24 (0.5)	2.10 (53)	2,378 (3,539)	1,000 (305)	Reel
ABMM	55-W99-24	-	900	24 (0.5)	2.51 (64)	3,456 (5,143)	1,000 (305)	Reel

## ELECTRICAL SPECIFICATIONS

Frequency MHz	Attenuation @ 68°F (20°C) Maximum Guaranteed dB/100 m	PSNEXT Minimum Guaranteed dB/100 m	Minimum SRL dB/100 m
0.772	2.2	43	12
1	2.6	41	12
4	5.6	32	12
8	8.5	27	12
10	9.7	26	12
16	13.1	23	10

Characteristic Impedance Ohms	Delay Skew Maximum ns/100 m	DC Resistance Maximum Ohms/100 m	Resistance Unbalance Maximum %
100 ± 15	45	9.38	5

Telcordia is a registered trademark of Ericsson Inc. UL is a registered trademark of UL LLC.



## PRODUCT DESCRIPTION

The 1249C Series Central Office (CO) Cables are designed for use between switching and transmission equipment for distances up to 450 feet. With short twist lays, 1249C series offers superior crosstalk performance over standard telephone cable. It is manufactured with a dual foil shield for additional Electromagnetic Interference (EMI) reduction and is double jacketed for protection of the twisted pairs. The 1249C series meets or exceeds all applicable requirements of Telcordia® GR-137 specifications.

## APPLICATIONS

- T1/DS1
- T1C/DS1C
- DS2

## FEATURES

- 26 AWG tinned copper conductors
- Solid Polyolefin insulation
- 100 Ohm nominal Impedance
- Short pair lays/tight twists
- Dual aluminum foil shields
- Tinned copper drain wire
- CMR listed
- Rip cord
- Solid color insulation

## BENEFITS

- Small diameter and light weight result in smaller cable bundles and easier handling; minimize change in wire-wrap joint resistance
- Greater crush resistance and improved transmission characteristics
- Impedance mismatch with OSP cable is minimized
- Improved crosstalk performance and pair identification
- Higher EMI isolation over a single foil shield
- Easier termination and superior grounding
- Suitable for horizontal and riser installations
- Added ease of jacket removal
- Easy identification of conductor ring mates

## SPECIFICATIONS

<b>Conductor</b>	Tinned copper
<b>Insulation</b>	Flame retardant polyethylene
<b>Shield</b>	Dual aluminum foil
<b>Jacket</b>	Gray PVC printed at 2 foot intervals including product identification, pair count, UL information and sequential lengths in feet and meters
<b>Performance Compliance</b>	Telcordia® GR-137-CORE, Issue 2, May 2013 Telcordia GR-499-CORE (Pulse shape compliance at 450 feet) ASTM B33 - Tinned Copper UL® 444 CSA C22.2 No. 214-08 UL 1666 RoHS-compliant/RoHS 2-compliant
<b>NRTL Programs</b>	UL, c(UL) Listed CMR

## PART NUMBERS AND PHYSICAL CHARACTERISTICS

Part Number	Pair Count	AWG (mm)	Nominal Diameter in (mm)	Approx. Weight lbs/kft (kg/km)	Standard Length ft (m)	Package
55-499-20	12	26 (0.4)	0.35 (8.8)	50 (74)	7,000 (2,133)	Reel
55-799-20	25	26 (0.4)	0.45 (11.4)	88 (131)	5,000 (1,524)	Reel
55-899-20	28	26 (0.4)	0.47 (11.9)	93 (138)	5,000 (1,524)	Reel
55-999-20	30	26 (0.4)	0.49 (12.4)	101 (150)	4,000 (1,219)	Reel
55-A99-20	32	26 (0.4)	0.50 (12.7)	105 (156)	4,000 (1,219)	Reel
55-B99-20	50	26 (0.4)	0.59 (14.9)	153 (228)	3,000 (914)	Reel
55-E99-20	100	26 (0.4)	0.76 (19.3)	277 (412)	3,000 (914)	Reel

## ELECTRICAL SPECIFICATIONS

Frequency MHz	PSNEXT Mean dB		PSNEXT Worst Pair dB	
	Minimum	Typical	Minimum	Typical
0.15	58	66	53	60
0.772	47	53	42	48
1.6	43	47	38	43
3.15	38	42	33	37
6.3	34	38	29	32

Bit Rate Mb/s	Frequency MHz	Attenuation @ 68°F (20°C)		Conductor DC Resistance @ 68°F (20°C) Maximum Individual Ohms/kft (Ohms/km)	Mutual Capacitance Nominal pF/ft (pF/m)	Characteristic Impedance @ 0.772 MHz Ohms
		Maximum Average* dB/kft (dB/100 m)	Typical dB/kft (dB/100 m)			
1.544	0.772	7.8 (2.6)	6.4 (2.1)	46.1 (151)	16 (52)	102 ± 15.3

\*For cables with 12-pair or less, the maximum average attenuation may be increased by 10% over the values shown.

Telcordia is a registered trademark of Ericsson Inc. UL is a registered trademark of UL LLC.

# 1161A Series Category 3

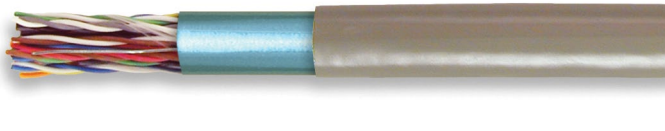

## PRODUCT DESCRIPTION

The 1161A Series Central Office (CO) Cables are designed for use between switching and transmission equipment, spanning distances up to 565 feet. With short twist lays, 1161A series offers superior crosstalk performance over standard telephone cable. It is manufactured with a foil shield for Electromagnetic Interference (EMI) reduction. The 1161A series meets or exceeds all applicable requirements of Telcordia® GR-137 specifications.

## APPLICATIONS

- T1/DS1
- T1C/DS1C
- DS2

## FEATURES

- 24 AWG tinned copper conductors
- Solid color Polyolefin insulation
- 100 Ohm nominal Impedance
- Short pair lays/tight twists
- Aluminum foil shield
- Tinned copper drain wire
- CMR listed
- 75°C rating
- Rip cord

## BENEFITS

- Small diameter and light weight results in smaller bundles of cables and improved flexibility (compared with 600 Series)
- Tinned copper conductors minimize change in wire-wrap joint resistance
- Greater crush resistance and improved transmission characteristics
- Impedance mismatch with OSP cable is minimized
- Improved crosstalk performance and pair identification
- EMI isolation
- Easier termination and superior grounding
- Suitable for horizontal and riser installations
- Wider operating temperature range
- Added ease of jacket removal

## SPECIFICATIONS

Conductor	Tinned copper
Insulation	Polyolefin
Core Wrap	Non-hygroscopic, dielectric tape
Shield	Aluminum foil
Jacket	Gray PVC printed at 2 foot intervals including product identification, pair count, UL information and sequential lengths in feet and meters
Performance Compliance	Telcordia® GR-137-CORE, Issue 2, May 2013 Telcordia GR-499-CORE (Pulse shape compliance at 565 feet) ASTM B33 - Tinned Copper UL® 444 CSA C22.2 No. 214-08 UL 1666 ANSI/TIA-568.2-D RoHS-compliant/RoHS 2-compliant
NRTL Programs	UL, c(UL) Listed CMR

## PART NUMBERS AND PHYSICAL CHARACTERISTICS

Part Number	Pair Count	AWG (mm)	Nominal Diameter in (mm)	Approx. Weight lbs/kft (kg/km)	Standard Length ft (m)	Package
55-F99-21	8	24 (0.5)	0.35 (8.9)	45 (67)	10,000 (3,048)	Reel
55-599-21*	16	24 (0.5)	0.41 (10)	77 (115)	7,000 (2,133)	Reel
55-799-21*	25	24 (0.5)	0.48 (12)	112 (167)	5,000 (1,524)	Reel
55-899-21*	28	24 (0.5)	0.51 (13)	123 (183)	5,000 (1,524)	Reel
55-A99-21*	32	24 (0.5)	0.55 (14)	143 (213)	4,000 (1,219)	Reel
55-B99-21*	50	24 (0.5)	0.66 (17)	210 (313)	3,000 (914)	Reel
55-E99-21*	100	24 (0.5)	0.89 (23)	389 (579)	1,000 (305)	Reel

\*For cables with 12-pair or less, the maximum average attenuation may be increased by 10% over the values shown.

## ELECTRICAL SPECIFICATIONS

Frequency MHz	PSNEXT Mean		PSNEXT Worst Pair	
	Minimum dB	Typical dB	Minimum dB	Typical dB
0.15	58	66	53	60
0.772	47	53	42	48
1.6	43	47	38	43
3.15	38	42	33	37
6.3	34	38	29	32

Attenuation @ 68°F (20°C)		Maximum Individual Conductor DC Resistance @ 68°F (20°C)		Mutual Capacitance Nominal	Characteristic Impedance @ 0.772 MHz	
Bit Rate Mb/s	Frequency MHz	Maximum Average* dB/kft (dB/100 m)	Typical dB/kft (dB/100 m)	Nominal pF/ft (pF/m)	@ 0.772 MHz Ohms	
1.544	0.772	6.3 (2.1)	5.4 (1.8)	28.6 (93.8)	16 (52)	102 ± 15.3

\*For cables with 12-pair or less, the maximum average attenuation may be increased by 10% over the values shown. Telcordia is a registered trademark of Ericsson Inc. UL is a registered trademark of UL LLC.



## PRODUCT DESCRIPTION

The 600C Series Central Office (CO) Cables are designed for use between switching and transmission equipment for distances up to 650 feet. This series offers the lowest attenuation of all the CO cable products by using 22 AWG conductors. It is manufactured with a dual foil shield for additional Electromagnetic Interference (EMI) reduction. The 600C series meets or exceeds all applicable requirements of Telcordia® GR-137 specifications.

## APPLICATIONS

- T1/DS1
- T1C/DS1C
- DS2

## FEATURES

- 22 AWG tinned copper conductors
- Solid Polyolefin insulation
- 100 Ohm nominal Impedance
- Dual aluminum foil shield
- Tinned copper drain wire
- CMR listed
- Rip cord
- Band marked

## BENEFITS

- Low attenuation, enabling longer run length; tinned copper conductors minimize change in wire-wrap joint resistance
- Greater crush resistance and improved transmission characteristics; smaller cable over dual insulated type
- Impedance mismatch with OSP cable is minimized
- Higher EMI isolation over a single foil shield; smaller cable diameter than 600B Series
- Easier termination and superior grounding
- Suitable for horizontal and riser installations
- Added ease of jacket removal
- Easy identification of conductor ring mates

## SPECIFICATIONS

<b>Conductor</b>	Tinned copper
<b>Insulation</b>	Polyolefin
<b>Shield</b>	Dual aluminum foil
<b>Jacket</b>	Gray PVC printed at 2 foot intervals including product identification, pair count, UL information and sequential lengths in feet and meters
<b>Performance Compliance</b>	Telcordia® GR-137-CORE, Issue 2, May 2013 Telcordia GR-499-CORE (Pulse shape compliance at 650 feet) ASTM B33 - Tinned Copper UL® 444 CSA C22.2 No. 214-08 UL 1666 RoHS-compliant/RoHS 2-compliant
<b>NRTL Programs</b>	UL, c(UL) Listed CMR

## PART NUMBERS AND PHYSICAL CHARACTERISTICS

Part Number	Product Code	Pair Count	AWG (mm)	Nominal Diameter in (mm)	Approx. Weight lbs/kft (kg/km)	Standard Length ft (m)	Package
55-399-38	606C	6	22 (0.6)	0.33 (8.3)	52 (77)	10,000 (3,048)	Reel
55-499-38	607C	12	22 (0.6)	0.43 (10.9)	89 (132)	7,000 (2,133)	Reel
55-599-38	608C	16	22 (0.6)	0.49 (12.4)	118 (176)	7,000 (2,133)	Reel
55-699-38	617C	20	22 (0.6)	0.53 (13.4)	141 (210)	5,000 (1,524)	Reel
55-799-38	609C	25	22 (0.6)	0.58 (14.7)	172 (256)	5,000 (1,524)	Reel
55-899-38	616C	28	22 (0.6)	0.61 (15.5)	189 (281)	5,000 (1,524)	Reel
55-999-38	613C	30	22 (0.6)	0.64 (16.2)	201 (299)	5,000 (1,524)	Reel
55-A99-38	615C	32	22 (0.6)	0.65 (16.5)	213 (317)	5,000 (1,524)	Reel
55-B99-38	610C	50	22 (0.6)	0.79 (20.0)	324 (482)	3,000 (914)	Reel

## ELECTRICAL SPECIFICATIONS

Frequency MHz	PSNEXT Mean		PSNEXT Worst Pair	
	Minimum dB	Typical dB	Minimum dB	Typical dB
0.15	58	66	53	60
0.772	47	53	42	48
1.6	43	47	38	43
3.15	38	42	33	37
6.3	34	38	29	32

Attenuation @ 68°F (20°C)				Conductor DC Resistance @ 68°F (20°C)	Mutual Capacitance	Characteristic Impedance @ 0.772 MHz
Bit Rate Mb/s	Frequency MHz	Maximum Average* dB/kft (dB/100 m)	Typical dB/kft (dB/100 m)	Maximum Individual Ohms/kft (Ohms/km)	Nominal pF/ft (pF/m)	@ 0.772 MHz Ohms
1.544	0.772	5.0 (1.6)	4.0 (1.3)	18 (59.1)	16 (52)	102 ± 15.3

\*For cables with 12-pair or less, the maximum average attenuation may be increased by 10% over the values shown. Telcordia is a registered trademark of Ericsson Inc. UL is a registered trademark of UL LLC.

# 25-Pair Category 5e Shielded

CMR



## SPECIFICATIONS

Conductor	Tinned copper
Insulation	Polyolefin
Shield	Aluminum foil
Jacket	Flame retardant PVC
Jacket Marking	Printed at 2 foot intervals; information includes product identification, pair count, UL information and sequential lengths in feet and meters
Input Impedance Ohms	100 ± 15 @ 1-100 MHz
Nominal Velocity of Propagation %	69
Performance Compliance	ASTM B33 - Tinned Copper UL® 444 CSA C22.2 No. 214-08 UL 1666 ANSI/TIA-568.2-D RoHS-compliant/RoHS 2-compliant
NRTL Programs	UL, c(UL) Listed CMR

## PRODUCT DESCRIPTION

This 25-pair, 24 AWG, Category 5e Tin Copper Shielded Cable is utilized to connect equipment within a remote terminal cabinet or within a Central Office (CO). Tight twist lays offer superior crosstalk performance for supporting digital subscriber line (xDSL) technologies and higher IPTV data speeds. Assembled with a cable connector on both ends, the combination facilitates quick installation within the cabinet. The cable is manufactured with a blue or gray colored double jacket separated by a single aluminum foil shield for additional Electromagnetic Interference (EMI) reduction and added protection for the twisted pairs.

## APPLICATIONS

- Remote terminal connecting cable
- Central Office cable

## FEATURES

- Small outside diameter
- Vibrant insulation colors
- Performance compliance with ANSI/TIA-568.2-D specification

## BENEFITS

- Facilitates routing within a remote terminal
- Easier identification of conductors
- Provides cost-effective solution

## PART NUMBERS AND PHYSICAL CHARACTERISTICS

Part Number	Pair Count	AWG (mm)	Jacket Color	Nominal Diameter in (mm)	Approx. Weight lbs/kft (kg/km)	Package
55-779-19	25	24 (0.5)	Green	0.57 (15)	145 (216)	5,000' Reel
55-789-19	25	24 (0.5)	Gray	0.57 (15)	145 (216)	5,000' Reel
55-799-19	25	24 (0.5)	Blue	0.57 (15)	145 (216)	5,000' Reel

## ELECTRICAL SPECIFICATIONS

Frequency MHz	Attenuation @ 68°F (20°C) Maximum dB/100 m		NEXT Minimum dB/100 m		ACR Minimum dB/100 m		PSNEXT Minimum dB/100 m	
	TIA-568.2-D	Superior Essex	TIA-568.2-D	Superior Essex	TIA-568.2-D	Superior Essex	TIA-568.2-D	Superior Essex
	Specified	Typical	Specified	Typical	Calculated	Typical	Specified	Typical
1	2.0	1.8	65.3	77.7	63.3	75.9	62.3	75.2
4	4.1	3.7	56.3	68.7	52.2	64.9	53.3	66.0
8	5.8	5.4	51.8	61.3	46.0	55.8	48.8	58.7
10	6.5	6.0	50.3	60.7	43.8	54.5	47.3	58.3
16	8.2	7.7	47.2	56.1	39.1	48.3	44.3	53.7
20	9.3	8.6	45.8	55.3	36.5	46.5	42.8	52.9
25	10.4	9.6	44.3	53.8	33.9	44.0	41.3	51.4
31.25	11.7	10.8	42.9	52.7	31.2	41.6	39.9	50.0
62.5	17.0	15.5	38.4	48.0	21.4	32.2	35.4	45.5
100	22.0	19.8	35.3	44.5	13.3	24.2	32.3	42.2

Frequency MHz	PSACR Minimum dB/100 m		Return Loss Minimum dB/100 m		ELFEXT Minimum dB/100 m		PSELFEXT Minimum dB/100 m	
	TIA-568.2-D	Superior Essex	TIA-568.2-D	Superior Essex	TIA-568.2-D	Superior Essex	TIA-568.2-D	Superior Essex
	Calculated	Typical	Specified	Typical	Specified	Typical	Specified	Typical
1	60.3	73.3	20.0	40.1	63.8	69.2	60.8	68.5
4	49.2	62.2	23.0	40.1	51.7	57.7	48.7	57.0
8	43.0	53.2	24.5	39.8	45.7	51.6	42.7	49.5
10	40.8	52.2	25.0	37.3	43.8	49.0	40.8	48.2
16	36.1	46.0	25.0	36.7	39.7	45.6	36.7	43.8
20	33.5	44.2	25.0	36.0	37.7	43.6	34.7	42.8
25	30.9	41.7	24.3	34.5	35.8	42.0	32.8	40.7
31.25	28.2	39.0	23.6	32.6	33.9	40.1	30.9	39.3
62.5	18.4	29.9	21.5	31.6	27.8	34.7	24.8	33.5
100	10.3	22.1	20.1	31.7	23.8	30.4	20.8	29.4

UL is a registered trademark of UL LLC



# Resources at Your Fingertips

Our Web site is a great resource for information to help with your next installation, including:

**Support** ▪ **Product FAQs** ▪ **Warranties**  
**Videos** ▪ **Technical Guidelines**  
**Literature** ▪ **Installation References**

All-in-one convenient location.  
Visit [SuperiorEssexCommunications.com](http://SuperiorEssexCommunications.com)  
for the latest information and tools.

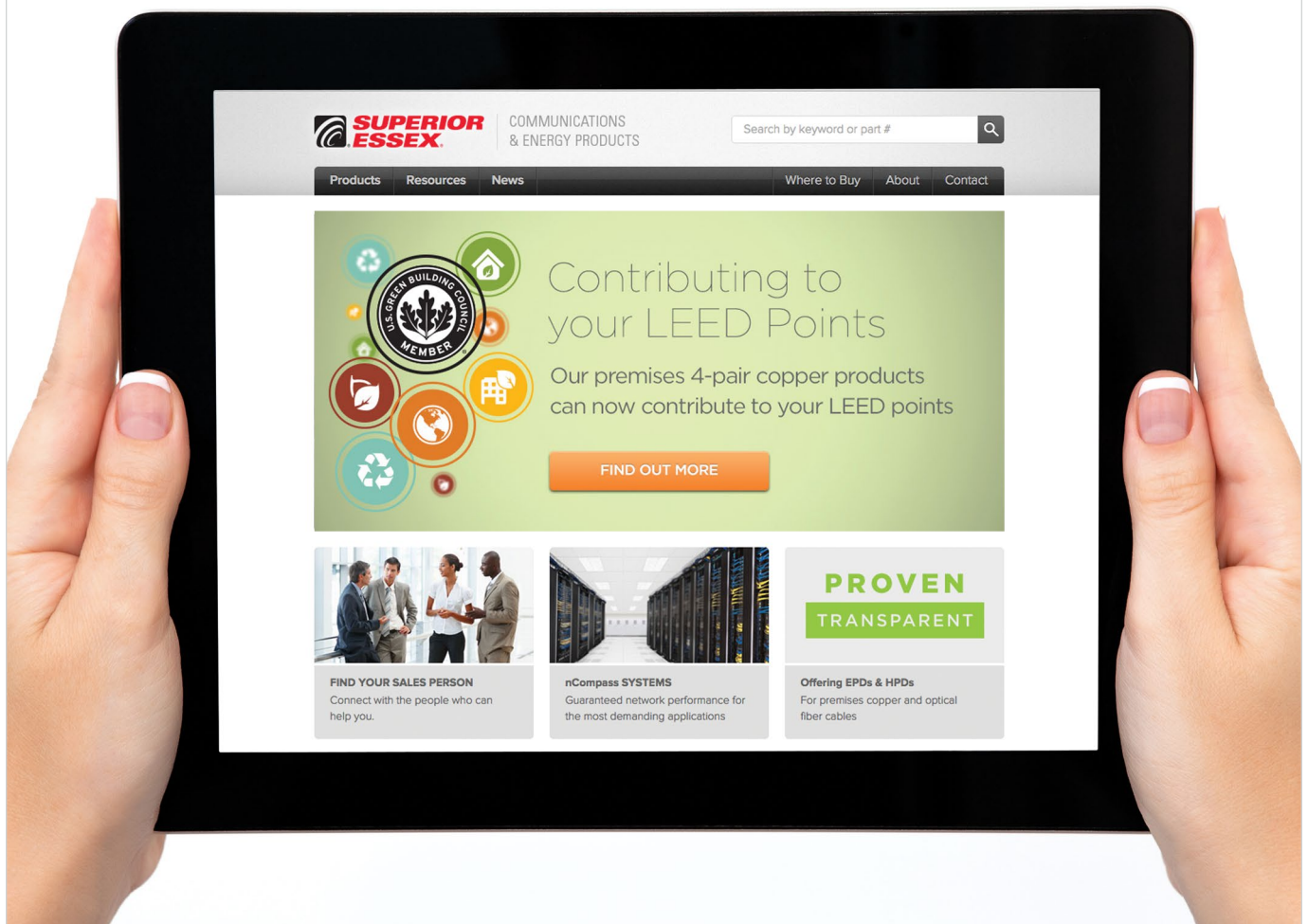

# Switchboard 100 Ohm



## SPECIFICATIONS

Conductor	Tinned copper
Insulation	PVC
Jacket	Gray PVC
Jacket Marking	Printed at 2 foot intervals; information includes product identification, pair count, UL information and sequential lengths in feet and meters
Performance Compliance	ASTM B33 - Tinned Copper UL® 444 CSA C22.2 No. 214-08 UL 1666 Telcordia® GR-137-CORE, Issue 2, May 2013 (select sections) RoHS-compliant/RoHS 2-compliant
NRTL Programs	UL, c(UL) Listed CMR

## ELECTRICAL SPECIFICATIONS

Conductor Size AWG (mm)	Conductor DC Resistance @ 68°F (20°C) Maximum Individual Ohms/kft (Ohms/km)	Mutual Capacitance Nominal pF/ft (pF/m)	Characteristic Impedance @ 1 MHz Ohms	Maximum Average Attenuation* @ 0.772 MHz @ 68°F (20°C) dB/kft (dB/km)
24 (0.5)	28.6 (93.8)	20 (66)	100 ± 15	6.3 (20)
26 (0.4)	46.1 (151)	20 (66)	100 ± 15	7.8 (25)

\*For cables with 12-pair or less, the maximum average attenuation may be increased by 10% over the values shown.

UL is a registered trademark of UL LLC. Telcordia is a registered trademark of Ericsson Inc.

## PRODUCT DESCRIPTION

Switchboard 100 Central Office (CO) Cables are designed for indoor use in CO exchanges, or in premises telephone rooms. These cables are used for interconnection of distribution frames and digital switching and transmission equipment systems. Switchboard 100 provides 100 Ohm characteristic impedance. The product line consists of 24 or 26 AWG tinned insulated copper wires that are twisted into pairs. The pairs are stranded together utilizing a standard color code scheme.

## APPLICATIONS

- T1/DS1
- T1C/DS1C
- 4 Mbps token ring (IEEE 802.5)
- 10 Mbps 10BASE-T Ethernet (IEEE 802.3)

## FEATURES

- 100 Ohm nominal Impedance
- Tinned copper conductors
- CMR listed
- Rip cord
- Band marked

## BENEFITS

- Impedance mismatch with Outside Plant (OSP) cable is minimized
- Minimize change in wire-wrap joint resistance
- Suitable for horizontal and riser installations
- Added ease of jacket removal
- Easy identification of conductor ring mates

## PART NUMBERS AND PHYSICAL CHARACTERISTICS

Part Number	Product Code	Pair Count	AWG (mm)	Nominal Diameter in (mm)	Approx. Weight lbs/kft (kg/km)	Standard Length ft (m)	Package
55-021-23	TIW 2/24	2	24 (0.5)	0.14 (4)	10 (15)	5,000 (1,524)	Reel
55-241-23	TIW 4/24 or 286A	4	24 (0.5)	0.18 (5)	18 (27)	1,000 (305)	POP box
55-341-23	TIW 6/24 or 252A	6	24 (0.5)	0.22 (6)	26 (39)	1,000 (305)	POP box
55-F31-23	294A	8	24 (0.5)	0.24 (7)	33 (49)	1,000 (305)	Reel
55-G99-23	TIW 10/24 or 253A	10	24 (0.5)	0.25 (7)	40 (60)	7,000 (2,133)	Reel
55-499-23	TIW 12/24 or 265A	12	24 (0.5)	0.28 (7)	49 (73)	7,000 (2,133)	Reel
55-599-23	TIW 16/24	16	24 (0.5)	0.32 (8)	64 (95)	7,000 (2,133)	Reel
55-699-23	255A	20	24 (0.5)	0.35 (9)	78 (116)	5,000 (1,524)	Reel
55-799-23	TIW 25/24	25	24 (0.5)	0.39 (10)	96 (143)	5,000 (1,524)	Reel
55-899-23	TIW 28/24	28	24 (0.5)	0.41 (10)	107 (159)	5,000 (1,524)	Reel
55-A99-23	TIW 32/24	32	24 (0.5)	0.43 (11)	121 (180)	5,000 (1,524)	Reel
55-P99-23	269A	36	24 (0.5)	0.46 (12)	135 (201)	5,000 (1,524)	Reel
55-B99-23	TIW 50/24 or 270A	50	24 (0.5)	0.53 (13)	184 (274)	3,000 (914)	Reel
55-S99-23	267A	72	24 (0.5)	0.65 (17)	276 (411)	3,000 (914)	Reel
55-E99-23	TIW 100/24 or 262A	100	24 (0.5)	0.77 (20)	374 (557)	1,000 (305)	Reel
55-U99-23	287A	120	24 (0.5)	0.83 (21)	445 (662)	1,000 (305)	Reel
55-399-26	816A	6	26 (0.4)	0.18 (5)	17 (25)	5,000 (1,524)	Reel
55-F99-26	811A	8	26 (0.4)	0.19 (5)	22 (33)	5,000 (1,524)	Reel
55-G99-26	820A	10	26 (0.4)	0.20 (6)	27 (40)	5,000 (1,524)	Reel
55-799-26	824A	25	26 (0.4)	0.31 (8)	65 (97)	5,000 (1,524)	Reel
55-A99-26	808A	32	26 (0.4)	0.35 (9)	81 (121)	5,000 (1,524)	Reel
55-Q99-26	803A	40	26 (0.4)	0.39 (10)	100 (149)	5,000 (1,524)	Reel
55-P99-26	822A	48	26 (0.4)	0.42 (11)	118 (176)	5,000 (1,524)	Reel
55-B99-26	813A	50	26 (0.4)	0.43 (11)	123 (183)	5,000 (1,524)	Reel
55-R99-26	809A	64	26 (0.4)	0.48 (12)	154 (229)	5,000 (1,524)	Reel
55-K99-26	823A	96	26 (0.4)	0.58 (15)	228 (339)	5,000 (1,524)	Reel
55-E99-26	806A	100	26 (0.4)	0.61 (16)	236 (351)	5,000 (1,524)	Reel
55-H99-26	810A	128	26 (0.4)	0.69 (18)	316 (470)	5,000 (1,524)	Reel
55-L99-26	814A	144	26 (0.4)	0.73 (19)	353 (525)	5,000 (1,524)	Reel

Note: Standard USA Color Code Scheme

# Switchboard 100 Ohm

## 200A/800A Series (Canadian Color Code)



### PRODUCT DESCRIPTION

The 200A and 800A Series Central Office (CO) Cables are designed for indoor use in central offices or in premises telephone rooms, and are utilized between a distribution frame and digital switching/transmission equipment. This series offers 24 and 26 AWG tinned copper at 100 Ohm characteristic impedance levels. Used primarily in Canada, the color code and lay-up scheme has distinctively colored insulation in combination with single dots and double dots or dashes of colored ink. Each wire within a unit is readily distinguishable from all other wires within the same unit. Cables may contain pairs or a combination of pairs and singles. The pairs and singles are assembled together to form a core. Some cable sizes contain "spare pairs." The core is covered by a gray PVC jacket. The 200A and 800A series meet or exceed all applicable requirements of Telcordia® GR-137.

### APPLICATIONS

- T1/DS1
- T1C/DS1C

### FEATURES

- 24 and 26 AWG tinned copper conductors
- Solid PVC insulation
- 100 Ohm nominal impedance
- Standard pair lays
- CMR listed
- Non-shielded design
- Rip cord

### BENEFITS

- Small diameter and light weight result in smaller cable bundles and easier handling; tinned copper conductors minimize change in wire-wrap joint resistance
- Greater crush resistance and improved transmission characteristics
- Impedance mismatch with OSP cable is minimized
- Improved crosstalk performance and pair identification
- Suitable for horizontal and riser installations
- Lower cost
- Added ease of jacket removal

### SPECIFICATIONS

Conductor	Tinned copper
Insulation	PVC
Jacket	Gray PVC
Jacket Marking	Printed at 2 foot intervals on the jacket; information includes product identification, pair count, UL information and sequential lengths in feet and meters
Performance Compliance	Telcordia® GR-137-CORE, Issue 2, May 2013 (select sections) ASTM B33 - Tinned Copper UL® 444 CSA C22.2 No. 214-08 UL 1666 RoHS-compliant/RoHS 2-compliant
NRTL Programs	UL, c(UL) Listed CMR

### PART NUMBERS AND PHYSICAL CHARACTERISTICS

Part Number	Product Code	Pair Count	AWG (mm)	Nominal Diameter in (mm)	Approx. Weight lbs/kft (kg/km)	Standard Length ft (m)	Package
55-399-46	252A	6	24 (0.5)	0.22 (5.6)	26 (39)	3,000 (915)	Reel
55-699-46	255A	20	24 (0.5)	0.35 (8.9)	78 (116)	3,000 (915)	Reel
55-E99-46	262A	101.5	24 (0.5)	0.82 (21)	383 (570)	400 (120)	Reel
55-N99-46	266A	24	24 (0.5)	0.42 (11)	94 (140)	1,200 (365)	Reel
55-P99-46	269A	36	24 (0.5)	0.44 (11)	134 (199)	1,000 (305)	Reel
55-599-47	807A	17	26 (0.4)	0.26 (6.6)	47 (70)	3,000 (915)	Reel
55-A99-47	808A	33	26 (0.4)	0.37 (9.4)	86 (128)	2,000 (610)	Reel
55-R99-47	809A	66	26 (0.4)	0.51 (13)	164 (244)	1,325 (405)	Reel
55-H99-47	810A	132	26 (0.4)	0.67 (17)	330 (491)	700 (215)	Reel
55-Y99-47	821A	52	26 (0.4)	0.45 (11)	131 (195)	1,100 (335)	Reel
55-N99-47	824A	25	26 (0.4)	0.32 (8.1)	66 (98)	2,400 (730)	Reel
55-E99-47	806A	103	26 (0.4)	0.65 (17)	265 (394)	1,000 (305)	Reel

Note: Standard Canadian Color Scheme

### ELECTRICAL SPECIFICATIONS

Conductor Size AWG (mm)	Conductor DC Resistance @ 68°F (20°C) Maximum Individual Ohms/kft (Ohms/km)	Mutual Capacitance Nominal pF/ft (pF/m)	Characteristic Impedance @ 1 MHz Ohms	Maximum Average Attenuation* @ 0.772 MHz @ 68°F (20°C) dB/kft (dB/km)
24 (0.5)	28.6 (93.8)	20 (66)	100 ± 15	6.3 (20.7)
26 (0.4)	46.1 (151)	20 (66)	100 ± 15	7.8 (25.6)

\*For cables with 12-pair or less, the maximum average attenuation may be increased by 10% over the values shown.

Telcordia is a registered trademark of Ericsson Inc. UL is a registered trademark of UL LLC.



## PRODUCT DESCRIPTION

The T100 Series Central Office (CO) Cables are designed for use between switching and transmission equipment for distances up to 450 feet. They are manufactured with a longitudinal aluminum-polyester foil shield with aluminum facing the jacket for additional Electromagnetic Interference (EMI) reduction. The pairs are stranded together utilizing distinctive colored insulation in combination with markings of colored ink. The outer jacket is a gray flame retardant PVC. T100 series meets or exceeds all applicable requirements of Telcordia® GR-137 specifications.

## APPLICATIONS

- T1/DS1
- T1C/DS1C

## FEATURES

- 24 AWG tinned copper conductors
- CMR listed
- Solid PVC insulation
- 100 Ohm nominal impedance
- Standard pair lays
- Longitudinal aluminum/polyester foil shield with aluminum facing the jacket
- 24 AWG tinned copper drain wire
- Rip cord
- Band marked

## BENEFITS

- Small diameter and light weight result in smaller cable bundles and easier handling; tinned copper conductors minimize change in wire-wrap joint resistance
- Suitable for horizontal and riser installations
- Greater crush resistance and improved transmission characteristics
- Impedance mismatch with OSP cable is minimized
- Improved crosstalk performance and pair identification
- EMI isolation
- Easier termination and superior grounding
- Added ease of jacket removal
- Easy pair identification

## SPECIFICATIONS

<b>Conductor</b>	Tinned copper
<b>Insulation</b>	PVC
<b>Shield</b>	Aluminum/polyester foil
<b>Jacket</b>	Gray PVC
<b>Jacket Marking</b>	Printed at 2 foot intervals; information includes product identification, pair count, UL information and sequential lengths in feet and meters
<b>Performance Compliance</b>	Telcordia® GR-137-CORE, Issue 2, May 2013 (select sections) ASTM B33 - Tinned Copper UL® 444 (pulse shape compliance at 450 feet) CSA C22.2 No. 214-08 UL 1666 RoHS-compliant/RoHS 2-compliant
<b>NRTL Programs</b>	UL, c(UL) Listed CMR

## PART NUMBERS AND PHYSICAL CHARACTERISTICS

Part Number	Product Code	Pair Count	AWG (mm)	Nominal Diameter in (mm)	Approx. Weight lbs/kft (kg/km)	Standard Length ft (m)	Package
55-399-43	T106	6	24 (0.5)	0.30 (7.6)	37 (55)	6,644 (2,025)	Reel
55-F99-43	T108	8	24 (0.5)	0.31 (7.9)	45 (67)	5,578 (1,700)	Reel
55-499-43	T112	12	24 (0.5)	0.34 (8.6)	59 (88)	6,644 (2,025)	Reel
55-599-43	T116	16	24 (0.5)	0.36 (9.1)	74 (110)	6,644 (2,025)	Reel
55-699-43	T120	20	24 (0.5)	0.41 (10)	91 (135)	5,315 (1,620)	Reel
55-799-43	T125	25	24 (0.5)	0.43 (11)	106 (158)	5,315 (1,620)	Reel
55-899-43	T128	28	24 (0.5)	0.44 (11)	114 (170)	5,000 (1,524)	Reel
55-999-43	T130	30	24 (0.5)	0.44 (11)	121 (180)	4,429 (1,350)	Reel
55-A99-43	T132	32	24 (0.5)	0.47 (12)	131 (195)	3,937 (1,200)	Reel

## ELECTRICAL SPECIFICATIONS

Conductor DC Resistance @ 68°F (20°C) Maximum Individual Ohms/kft (Ohms/km)	Mutual Capacitance Nominal pF/ft (pF/m)	Characteristic Impedance @ 1 MHz Ohms	Maximum Average Attenuation @ 0.772 MHz @ 68°F (20°C) dB/kft (dB/km)
28.6 (93.8)	20 (66)	100 ± 15	7.2 (23.6)

Telcordia is a registered trademark of Ericsson Inc. UL is a registered trademark of UL LLC.

# Switchboard 85 and Shielded Switchboard 85

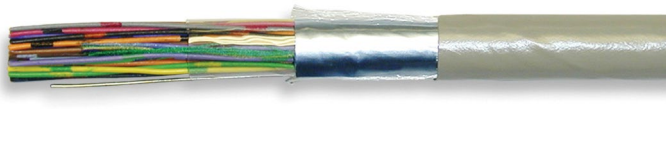

## SPECIFICATIONS

Conductor	Tinned copper
Insulation	PVC
Jacket	Gray PVC
Jacket Marking	Printed at 2 foot intervals; information includes product identification, pair count, UL information and sequential lengths in feet and meters
Shield	SSWBD: Aluminum/polyester SWBD: None
Performance Compliance	ASTM B33 - Tinned Copper UL® 444 CSA C22.2 No. 214-08 UL 1666 RoHS-compliant/RoHS 2-compliant
NRTL Programs	UL, c(UL) Listed CMR

## PRODUCT DESCRIPTION

Switchboard Cables are designed for indoor use in central exchanges, the interconnection of distribution frames, and for switching and transmission equipment systems. Switchboard cables are available in both shielded and unshielded designs.

## APPLICATIONS

- T1/DS1
- T1C/DS1C

## FEATURES

- SSWBD: Aluminum foil shield
- SSWBD: Tinned copper drain wire
- Tinned copper conductors
- CMR listed
- Rip cord
- Band marked

## BENEFITS

- EMI isolation
- Easier termination and superior grounding
- Minimize change in wire-wrap joint resistance
- Suitable for horizontal and riser installations
- Added ease of jacket removal
- Easy identification of conductor ring mates

## PART NUMBERS AND PHYSICAL CHARACTERISTICS

Part Number	Product Code	Shield	Pair Count	AWG (mm)	Nominal Diameter in (mm)	Approx. Weight lbs/kft (kg/km)	Standard Length ft (m)	Package
02-097-61	SSWBD	Aluminum foil	25	24 (0.5)	0.35 (8.9)	88 (131)	5,000 (1,524)	Reel
02-098-61	SSWBD	Aluminum foil	32	24 (0.5)	0.41 (10)	113 (168)	5,000 (1,524)	Reel
02-100-61	SSWBD	Aluminum foil	50	24 (0.5)	0.48 (12)	167 (249)	5,000 (1,524)	Reel
02-104-61	SSWBD	Aluminum foil	100	24 (0.5)	0.63 (16)	314 (467)	5,000 (1,524)	Reel
02-840-10	SWBD	-	6	24 (0.5)	0.18 (4.6)	22 (33)	1,000 (305)	Reel
02-841-10	SWBD	-	12	24 (0.5)	0.24 (6.1)	41 (61)	1,000 (305)	Reel
02-431-10	SWBD	-	25	24 (0.5)	0.31 (7.9)	79 (118)	1,000 (305)	Reel
02-815-10	SWBD	-	25	24 (0.5)	0.31 (7.9)	79 (118)	5,000 (1,524)	Reel
02-832-10	SWBD	-	32	24 (0.5)	0.36 (9.1)	100 (149)	5,000 (1,524)	Reel
02-813-10	SWBD	-	50	24 (0.5)	0.45 (11)	157 (234)	5,000 (1,524)	Reel
02-820-10	SWBD	-	100	24 (0.5)	0.60 (15)	302 (449)	5,000 (1,524)	Reel

## ELECTRICAL SPECIFICATIONS

Product	Conductor DC Resistance @ 68°F (20°C) Maximum Individual Ohms/kft (Ohms/km)	Mutual Capacitance Nominal pF/ft (pF/m)	Characteristic Impedance @ 1 MHz Ohms	Attenuation Nominal @ 0.772 MHz @ 68°F (20°C) dB/kft (dB/km)
SSWBD	28.6 (93.8)	20 (66)	85 ± 15	11 (36)
SWBD	28.6 (93.8)	20 (66)	85 ± 15	11 (36)

UL is a registered trademark of UL LLC.

## PRODUCT DESCRIPTION

Distribution Frame Wires are designed for cross-connection of equipment in telephone switch and equipment rooms requiring point-to-point hook ups.

## APPLICATIONS

- Normal use

## FEATURES

- Solid tinned copper conductors in 22 AWG or 24 AWG are insulated with semi-rigid polyvinyl chloride (PVC)
- Each insulated conductor is identified by a solid insulation color

## BENEFITS

- Facilitates wire wrapping and tight connections
- Easy identification



## SPECIFICATIONS

<b>Conductor</b>	Tinned copper
<b>Insulation</b>	Semi-rigid PVC
<b>Performance Compliance</b>	ASTM B33 - Tinned Copper UL® 444 CSA C22.2 No. 214-08 GR 136 CORE (normal use) RoHS-compliant/RoHS 2-compliant
<b>NRTL Programs</b>	UL, c(UL) Listed CM

## PART NUMBERS AND PHYSICAL CHARACTERISTICS

Part Number	Number of Conductors	AWG (mm)	Insulation Color	Nominal Diameter in (mm)	Approx. Weight lbs/kft (kg/km)	Package
12-001-11	1	22 (0.6)	Red	0.04 (1.0)	2 (3)	750 m Spool
12-002-11	1	22 (0.6)	White	0.04 (1.0)	2 (3)	750 m Spool
12-004-11	1	22 (0.6)	Black	0.04 (1.0)	2 (3)	750 m Spool
12-303-13	1	22 (0.6)	Green	0.04 (1.0)	2 (3)	1,000 m Spool
12-001-12	2	22 (0.6)	Red/Green	0.08 (2.0)	5 (7)	500 m Spool
12-003-12	2	22 (0.6)	Blue/White	0.08 (2.0)	5 (7)	500 m Spool
12-004-12	2	22 (0.6)	Brown/Blue	0.08 (2.0)	5 (7)	500 m Spool
12-005-12	2	22 (0.6)	Black/White	0.08 (2.0)	5 (7)	500 m Spool
12-001-13	2	22 (0.6)	Red/White	0.08 (2.0)	5 (7)	305 m Spool
12-003-13	2	22 (0.6)	Blue/White	0.08 (2.0)	5 (7)	1,000' Spool
12-005-13	2	22 (0.6)	Black/White	0.08 (2.0)	5 (7)	1,000' Spool
12-101-13	2	24 (0.5)	Red/White	0.08 (2.0)	4 (6)	1,000' Spool
12-102-13	2	24 (0.5)	Red/Yellow	0.08 (2.0)	4 (6)	1,000' Spool
12-103-13	2	24 (0.5)	White/Blue	0.08 (2.0)	4 (6)	1,000' Spool
12-104-13	2	24 (0.5)	Violet/Blue	0.08 (2.0)	4 (6)	305 m Spool
12-105-13	2	24 (0.5)	Black/White	0.08 (2.0)	4 (6)	1,000' Spool
12-106-13	2	24 (0.5)	Red/White	0.08 (2.0)	4 (6)	6,000' Spool
12-107-13	2	24 (0.5)	Black/White	0.08 (2.0)	4 (6)	6,000' Spool
12-108-13	2	24 (0.5)	White/Blue	0.08 (2.0)	4 (6)	6,000' Spool
12-109-13	2	24 (0.5)	Yellow/Blue	0.08 (2.0)	4 (6)	1,000' Spool
12-112-13	2	24 (0.5)	Red/White	0.08 (2.0)	4 (6)	3,000' Parallel cone
12-304-13	2	22 (0.6)	Brown/Blue	0.08 (2.0)	5 (7)	1,000 m Parallel cone
12-305-13	2	22 (0.6)	Black/White	0.08 (2.0)	5 (7)	1,000 m Parallel cone
12-311-13	2	22 (0.6)	Red/Green	0.08 (2.0)	5 (7)	3,000' Spool
12-313-13	2	22 (0.6)	Blue/White	0.08 (2.0)	5 (7)	3,280' Parallel cone
12-318-13	2	22 (0.6)	White/Orange	0.08 (2.0)	5 (7)	3,000' Spool
12-403-13	2	22 (0.6)	White/Blue	0.08 (2.0)	5 (7)	3,000' Spool
12-406-13	2	22 (0.6)	Yellow/Violet	0.08 (2.0)	5 (7)	3,000' Spool
12-501-13	2	22 (0.6)	Red/White	0.08 (2.0)	5 (7)	2,300' Spool
12-031-12	4	22 (0.6)	Blue/White, Red/Green	0.12 (3.0)	9 (13)	1,640' Parallel cone
12-032-13	4	22 (0.6)	Black/White, Black/White	0.12 (3.0)	9 (13)	1,640' Parallel cone
12-033-13	4	22 (0.6)	Yellow/Blue, Orange/Brown	0.12 (3.0)	9 (13)	1,640' Parallel cone
12-034-13	5	22 (0.6)	Yellow/Blue, Orange/Brown, Green	0.17 (4.3)	13 (20)	500 m Parallel cone
12-035-13	5	22 (0.6)	Black/White, Black/White, Green	0.17 (4.3)	13 (20)	500 m Parallel cone

UL is a registered trademark of UL LLC.

# Heavy Duty Distribution Frame Wire

HD-DFW



## SPECIFICATIONS

Conductor	Tinned copper
Insulation	Heavy duty, abrasion resistant PVC
Performance Compliance	ASTM B33 - Tinned Copper UL® 444 CSA C22.2 No. 214-08 UL 1666 GR-136-CORE (high stress use) Applicable GR-136 Core requirements for high stress applications RoHS-compliant/RoHS 2-compliant
NRTL Programs	UL, c(UL) Listed CMR

## PRODUCT DESCRIPTION

Heavy Duty Distribution Frame Wire consists of 22 AWG tinned copper conductors with a heavy duty, abrasion resistant, flame retardant PVC insulation. HD-DFW is available in 2 or 4 conductors, and is used for making an interconnection between the incoming cable (tip termination) terminals and the equipment on the main distribution frame in the Central Office (CO). HD-DFW is suitable for use with either a solderless wrap or soldered terminals.

## APPLICATIONS

- High stress use

## FEATURES

- Solid tinned copper conductors in 22 AWG (0.6 mm) are insulated with PVC
- Each insulated conductor is identified by a solid insulation color
- Heavy duty insulation

## BENEFITS

- Facilitates solid connections
- Easy identification
- Added protection for long runs

## PART NUMBERS AND PHYSICAL CHARACTERISTICS

Part Number	Number of Conductors	AWG (mm)	Insulation Color	Nominal Diameter in (mm)	Approx. Weight lbs/kft (kg/km)	Standard Length ft (m)	Package
12-201-15	2	22 (0.6)	White/Blue	0.08 (2.0)	5 (7)	3,000 (914)	Parallel cone
12-202-15	2	22 (0.6)	White/Blue	0.08 (2.0)	5 (7)	574 (175)	Parallel cone
12-203-15	2	22 (0.6)	White/Blue	0.08 (2.0)	5 (7)	3,281 (1,000)	Parallel cone
12-204-15	2	22 (0.6)	White/Green	0.08 (2.0)	5 (7)	3,000 (914)	Parallel cone
12-205-15	2	22 (0.6)	White/Orange	0.08 (2.0)	5 (7)	3,000 (914)	Parallel cone
12-206-15	2	22 (0.6)	White/Red	0.08 (2.0)	5 (7)	3,000 (914)	Parallel cone
12-207-15	2	22 (0.6)	Yellow/Black	0.08 (2.0)	5 (7)	3,000 (914)	Parallel cone
12-208-15	2	22 (0.6)	Yellow/Green	0.08 (2.0)	5 (7)	3,000 (914)	Parallel cone
12-209-15	2	22 (0.6)	Yellow/Orange	0.08 (2.0)	5 (7)	3,000 (914)	Parallel cone
12-210-15	2	22 (0.6)	Black/Orange	0.08 (2.0)	5 (7)	3,000 (914)	Parallel cone
12-211-15	2	22 (0.6)	Orange/Blue	0.08 (2.0)	5 (7)	3,000 (914)	Parallel cone
12-216-15	2	22 (0.6)	Black/Green	0.08 (2.0)	5 (7)	3,000 (914)	Parallel cone
12-401-15	4	22 (0.6)	White/Blue, Red/Green	0.12 (3.0)	9 (13)	1,500 (457)	Parallel cone
12-402-15	4	22 (0.6)	Yellow/Blue, Red/Green	0.12 (3.0)	9 (13)	1,500 (457)	Parallel cone

UL is a registered trademark of UL LLC.



# Tight Twist Distribution Frame Wire

DFW

## PRODUCT DESCRIPTION

Tight Twist Distribution Frame Wire is necessary for the deployment of both xDSL and HI-CAP (T-1/HDSL) circuits within the distribution frames of central offices. This higher capacity frame wire is manufactured with a tight twist to minimize the impacts of electromagnetic interferences within this indoor environment. The Tight Twist Distribution Frame Wire is available in a 24 gauge size with a heavy duty flame retardant PVC insulation. Heavy duty in this application means a higher level of abrasion resistance, higher cut through and a higher temperature rating. The 22 AWG product is intended for use on main distribution frames (conventional type), while the 24 AWG is intended for use on COSMIC (Modular) distributing frames. The product is available in various put-ups.

## APPLICATIONS

- xDSL
- HI-CAP
- T-1/HDSL
- High stress use

## FEATURES

- 24 AWG solid tinned annealed copper
- Heavy duty, high temperature, high stress insulation
- Twisting sufficient to meet xDSL requirements

## BENEFITS

- Facilitates solid connection
- Added protection for long wire runs
- Twist pattern sufficient for xDSL transmission level



## SPECIFICATIONS

<b>Conductor</b>	Tinned copper
<b>Insulation</b>	Flame retardant PVC
<b>Performance Compliance</b>	ASTM B33 - Tinned Copper UL® 444 CSA C22.2 No. 214-08 Applicable GR-136 Core requirement for high stress applications RoHS-compliant/RoHS 2-compliant
<b>NRTL Programs</b>	UL, c(UL) Listed CM

## PART NUMBERS AND PHYSICAL CHARACTERISTICS

Part Number	AWG (mm)	Insulation Color	Nominal Diameter in (mm)	Standard Length ft (m)	Package
12-217-T5	24 (0.5)	Violet/Blue	0.07 (1.8)	500 (152)	Spool
12-218-T5	24 (0.5)	Violet/Blue	0.07 (1.8)	1,000 (305)	Spool

UL is a registered trademark of UL LLC.



800.551.8948

[SuperiorEssexCommunications.com](http://SuperiorEssexCommunications.com)

All information, content, data, specifications, packaging and part numbers detailed herein are subject to change. For the most up-to-date information, please visit [SuperiorEssexCommunications.com](http://SuperiorEssexCommunications.com). Purchase of this product is subject exclusively to the then current **Superior Essex International LP Terms and Conditions of Sale for Communications Cable, Wire and Connectivity Products**, which can be found on our website, [SuperiorEssexCommunications.com](http://SuperiorEssexCommunications.com), or provided to you upon request.

## OSP FIBER CABLE

Dri-Lite® Loose Tube Single Jacket All Dielectric Series 11D	B-2
Dri-Lite® Loose Tube Double Jacket Non-Armor Series 1GD	B-3
Dri-Lite® Loose Tube Single Jacket Single Armor Series 12D	B-4
Dri-Lite® Loose Tube Double Jacket Single Armor Series 1AD	B-5
Dri-Lite® Loose Tube Double Jacket Double Armor Series 1DD	B-6
Dri-Lite® Loose Tube Triple Jacket Double Armor Series 1CD	B-7
Loose Tube Single Jacket All Dielectric Series 11	B-8
Loose Tube Double Jacket Non-Armor Series 1G	B-9
Loose Tube Single Jacket Single Armor Series 12	B-10
Loose Tube Double Jacket Single Armor Series 1A	B-11
Loose Tube Double Jacket Double Armor Series 1D	B-12
Loose Tube Triple Jacket Double Armor Series 1C	B-13
Dri-Lite® Loose Tube Single Jacket Self Support Series 11DM	B-14
Dri-Lite® Loose Tube Double Jacket Self Support Series 1GDM	B-15
Dri-Lite® Loose Tube Single Jacket Single Armor Self Support Series 12DM	B-16
Dri-Lite® Loose Tube Double Jacket Single Armor Self Support Series 1ADM	B-17
Loose Tube Single Jacket Self Support Series 11M	B-18
Loose Tube Double Jacket Self Support Series 1GM	B-19
Loose Tube Single Jacket Single Armor Self Support Series 12M	B-20
Loose Tube Double Jacket Single Armor Self Support Series 1AM	B-21
Dri-Lite® Loose Tube Single Jacket Long-Span Self Support Series 11MLS	B-22
EnduraSpan™ ADSS	B-23
Single Loose Tube All Dielectric Series 51	B-32
Single Loose Tube Single Armor Series 52	B-33
Single Flex Tube All Dielectric Series F1	B-34
Single Flex Tube Single Armor Series F2	B-35
Flex Tube Locate Series FM	B-36
Ribbon Locate Series RM	B-37
Loose Tube Single Jacket All Dielectric Nylon Series 1NY	B-38
Dri-Lite® Loose Tube Indoor/Outdoor OFNR Series 13D	B-39
Loose Tube Indoor/Outdoor OFNR Series 13	B-40
Interlock Armored OSP Fiber OFCR Series 13I	B-41
Dri-Lite® Loose Tube Single Jacket All Dielectric I/O LSZH Series HZD	B-42
Dri-Lite® Loose Tube Single Jacket Single Armor I/O LSZH Series HZA	B-43
Single Loose Tube Indoor/Outdoor OFNR Series 53	B-46
Heavy Duty Loose Tube OFNR Series 1H	B-47
Telco Hybrid Loose Tube, Single 12 AWG Stranded Conductor Series 1N	B-48
UG FTTP Series 513	B-49
Buried FTTP, Steel Armor Series 52S	B-50
Buried FTTP, Steel Armor Series 52U	B-51
Figure 8 FTTP Series 573Q	B-52
Buried FTTP, Aluminum Armor Series 523	B-53
Telco Hybrid Buried Drop, Aluminum Armor Series 72	B-54
Telco Hybrid Buried Drop, Steel Armor Series 72S	B-55
Universal Drop FTTP Series 6U	B-56
Toneable Drop FTTP Series 6T	B-57
Universal FTTP Tight Buffered Indoor/Outdoor Drop Series W7U	B-58
Toneable FTTP Tight Buffered Indoor/Outdoor Drop Series W7T	B-59
W7 Fiber Drop Assemblies Series ADWSA	B-60
FTTP Tight Buffered Indoor/Outdoor Round Drop Series WR	B-61
Dri-Lite® Ribbon Series R1D	B-62
Dri-Lite® Ribbon Single Armor Series R2D	B-63
Stranded Loose Tube Ribbon Single Jacket All Dielectric Series S1	B-64
Stranded Loose Tube Ribbon Single Armor Series S2	B-66
Single Tube Ribbon Series R1	B-67
Single Tube Ribbon Single Armor Series R2	B-68
MicroLite™ OSP Air Blown LT Series	B-69

## OSP HYBRID CABLE

Telco Hybrid Right of Way Series MR	B-70
Telco Hybrid Line Powering Series MR	B-71
Telco Hybrid Web Drop, Category 5e & OSP Fiber Series 5F	B-72
Telco Hybrid Web Drop, OSP Copper & Fiber Series 5W	B-73
Telco Hybrid Overjacket Drop, OSP Copper & Fiber Series 71 OJ	B-74
Telco Hybrid Web OSP Series 5V	B-75
Telco Hybrid Overjacket OSP Series 70 OJ	B-76
Telco Hybrid Loose Tube, Stranded 24AWG Copper Pairs Series L	B-77
PowerWise® Hybrid Series DE	B-78

## RDUP/RUS OSP COPPER CABLE

POWERPIC™ OSP Copper Cable for Line Powering	B-79
SEALPIC®	B-80
SEALPIC®-84	B-82
SEALPIC®-FSF-84	B-84
SEALPIC®-FSF RDUP PE-89	B-86
CASPIC®-FSF RDUP PE-89	B-88
SEALPIC®-F RDUP PE-39	B-90
CUPIC-F® RDUP PE-39	B-92
GOPIC®-F RDUP PE-39	B-94

## BELL OSP COPPER CABLE

ALPETH BHBA, BHAA, BKMA and BKTA	B-96
PASP BHBH, BHAH, BKMH and BKTH	B-98
Self-Support BHAS and BKMS	B-100
Reinforced Self-Support BHAP, BKMP and BKTP	B-101
Bonded STALPETH DCAZ, DCMZ and DCTZ	B-102
STEAMPETH DKTN	B-104
Power Station High Potential Filled ASP CMAW	B-105
Filled ALPETH ANBA, ANAA, ANMA and ANTA	B-106
Filled ASP ANBW, ANAW, ANMW and ANTW	B-108
T-SCREEN® Filled ASP KNAW and KHAH	B-111

## CANADIAN OSP COPPER CABLE

CELFLIF BJBB, BJAB, BJMB and BJTB	B-112
Canadian ALPETH BHBB, BHAB, BKMB and BKTB	B-114
SEALPAP BHBFB, BHAF, BKMF and BKTF	B-116
Canadian Bonded STALPETH DCAZ, DCMZ and DCTZ	B-118
Canadian Integrated Messenger Wire IM/F, IM/H and IM/G	B-120
Canadian ADP NMS with QuickCount® in Meters	B-121
Aerial Drop Wire ADW	B-122
Buried Distribution Wire BCBD	B-123

## OSP COPPER WIRE

C-Rural Wire	B-124
IMRDW	B-125
IMRDWS	B-126
ADP NMS	B-127
ADP NMS Compact Design 6 x 24	B-128
ADP S	B-129
Integrated Messenger Wire IM/F, IM/H and IM/G	B-130
BDW A	B-131
BDW G	B-132
BW GDJ	B-133
BW AF	B-135
Non-Jacketed Tight Twist Cable Core	B-136
Air Pipe	B-136
Bridle Wire	B-137
Temporary Drop Wire TDW	B-137
E-Block Wire	B-138
Ground Wire Bare or Jacketed	B-139
Cross-Connect Category 5 Wire XCW	B-140
Indoor/Outdoor Cross-Connect Wire XCW	B-141

# Dri-Lite® Loose Tube Single Jacket All Dielectric

Series 11D

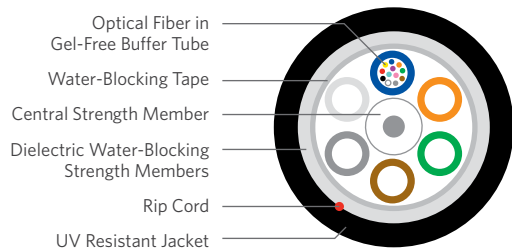

## PRODUCT DESCRIPTION

Loose tube cables are the product of choice as the backbone in Outside Plant (OSP) environments. The durable loose tube design offers reliable transmission performance over a broad temperature range. Optical fibers and water-blocking elements are placed inside gel-free buffer tubes. The core is constructed by stranding the buffer tubes around a central member using a reverse oscillating lay (ROL). The core is wrapped with flexible strength members covered with a water-blocking tape, then encased with a black jacket. A rip cord is included under the jacket for ease of entry.

## APPLICATIONS

- Underground duct and lashed aerial
- Trunk, distribution and feeder cable
- Local loop, metro, long-haul and broadband network

## FEATURES

- Available with up to 432-fiber
- Multiple fiber types including composites
- Central strength members available in metallic or dielectric
- Dry (SAP) core standard
- Standard tube size for all fiber counts
- Gel-free tubes

## BENEFITS

- High fiber density
- Multiple network applications
- Metallic option offers ease of location, dielectric design eliminates grounding issues
- Reduces cable prep and installation time
- Reduces the number of tools required
- Speeds fiber access and cleanup

## SPECIFICATIONS

**Fiber Count** Available in 6-fiber up to 432-fiber

**Standards Compliance** Telcordia® GR-20-CORE  
RDUP PE-90 Designation MLT  
ICEA S-87-640-2011  
RoHS-compliant

Telcordia is a registered trademark of Ericsson Inc.

## ENVIRONMENTAL SPECIFICATIONS

**Operation/Storage** -40°C to +70°C

**Installation** -30°C to +70°C

## PART NUMBER KEY

1	1	-	-	-	x	D	0	y
1	2	3	4	5	6	7	8	9
Product family	Fiber count (006-432)				Fiber type	Internal designator	Water block/markings (1-8)	

Contact Customer Service for availability of non-standard offerings.

## PART NUMBERS AND PHYSICAL CHARACTERISTICS

Part Number <sup>1</sup>	Fiber Count	Nominal Diameter in (mm)	Approx. Weight lbs/kft (kg/km)	Maximum Tensile Loading		Minimum Bend Radius	
				Install lbs (N)	Long Term lbs (N)	Install in (mm)	Long Term in (mm)
11006xD0y	6	0.41 (10.3)	47 (70)	600 (2,700)	200 (890)	8.2 (206)	4.1 (103)
11012xD0y	12	0.41 (10.3)	47 (70)	600 (2,700)	200 (890)	8.2 (206)	4.1 (103)
11024xD0y	24	0.41 (10.3)	47 (70)	600 (2,700)	200 (890)	8.2 (206)	4.1 (103)
11036xD0y	36	0.41 (10.3)	47 (70)	600 (2,700)	200 (890)	8.2 (206)	4.1 (103)
11048xD0y	48	0.41 (10.3)	47 (70)	600 (2,700)	200 (890)	8.2 (206)	4.1 (103)
11060xD0y	60	0.41 (10.3)	47 (70)	600 (2,700)	200 (890)	8.2 (206)	4.1 (103)
11072xD0y	72	0.43 (11.0)	61 (91)	600 (2,700)	200 (890)	8.6 (220)	4.3 (110)
11096xD0y	96	0.50 (12.7)	79 (118)	600 (2,700)	200 (890)	10.0 (254)	5.0 (127)
11144xD0y	144	0.63 (16.0)	124 (185)	600 (2,700)	200 (890)	12.6 (320)	6.3 (160)
11192xD0y	192	0.69 (17.6)	177 (264)	600 (2,700)	200 (890)	13.8 (352)	6.9 (176)
11216xD0y	216	0.63 (16.0)	120 (179)	600 (2,700)	200 (890)	12.6 (320)	6.3 (160)
11288xD0y	288	0.74 (18.9)	161 (240)	600 (2,700)	200 (890)	14.8 (378)	7.4 (189)
11432xD0y	432	0.82 (21.0)	121.9 (181.5)	600 (2,700)	200 (890)	16.4 (420)	8.2 (210)

## FIBER TYPES:

### SINGLE MODE

Reduced Water Peak    Zero Water Peak    TeraFlex® Bend Resistant  
G.657.A1    G.657.A2    G.657.B3    NZDS    LEAF

<sup>1</sup>Replace "x" with:

3    2    K    J    L    8    S

See "Optical Fiber Specifications" in the "Technical Info" section for detailed fiber type specifications.

### MULTIMODE

TeraGain®    TeraFlex Bend Resistant Laser Optimized 50/125  
62.5/125    10G/150    10G/300    10G/550

6    M    N    P

## WATER BLOCK AND JACKET PRINT CODES

Dry core    Dry core special

Feet    Meters    Feet    Meters

<sup>1</sup>Replace "y" with:

1    2    5    6

# Dri-Lite® Loose Tube Double Jacket Non-Armor

Series 1GD

## PRODUCT DESCRIPTION

Loose tube cables are the product of choice as the backbone in Outside Plant (OSP) environments. The durable loose tube design offers reliable transmission performance over a broad temperature range. Optical fibers are placed inside gel-free buffer tubes. The core is constructed by stranding the buffer tubes around a central member using a reverse oscillating lay (ROL). The core is wrapped with flexible strength members covered with a water-blocking tape, then encased with a black inner jacket. Water-blocking yarns and a black outer jacket are applied. Rip cords are included under each jacket for ease of entry.

## APPLICATIONS

- Underground duct and lashed aerial
- Trunk, distribution and feeder cables
- Local loop, metro, long-haul and broadband network

## FEATURES

- Available with up to 288-fiber
- Multiple fiber types including composites
- Central strength members available in metallic or dielectric
- Dry (SAP) core standard
- Standard tube size for all fiber counts
- Gel-free tubes

## BENEFITS

- High fiber density
- Multiple network applications
- Metallic option offers ease of location, dielectric design eliminates grounding issues
- Reduces cable prep and installation time
- Reduces the number of tools required
- Speeds fiber access and cleanup

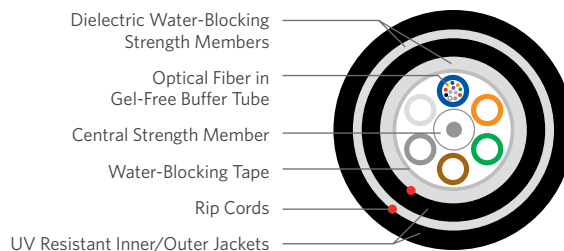

## SPECIFICATIONS

<b>Fiber Count</b>	Available in 12-fiber up to 288-fiber
<b>Standards Compliance</b>	Telcordia® GR-20-CORE RDUP PE-90 Designation MLT ICEA S-87-640-2011 RoHS-compliant

Telcordia is a registered trademark of Ericsson Inc.

## ENVIRONMENTAL SPECIFICATIONS

<b>Operation/Storage</b>	-40°C to +70°C
<b>Installation</b>	-30°C to +70°C

## PART NUMBER KEY

1	G	-	-	-	x	D	0	y
1	2	3	4	5	6	7	8	9
Product family	Fiber count (012-288)	Fiber type	Internal designator	Water block/ marking (1-8)				

Contact Customer Service for availability of non-standard offerings.

## PART NUMBERS AND PHYSICAL CHARACTERISTICS

Part Number <sup>1</sup>	Fiber Count	Nominal Diameter in (mm)	Approx. Weight lbs/kft (kg/km)	Maximum Tensile Loading		Minimum Bend Radius	
				Install lbs (N)	Long Term lbs (N)	Install in (mm)	Long Term in (mm)
1G012xD0y	12	0.50 (12.8)	73 (109)	600 (2,700)	200 (890)	10.0 (256)	5.0 (128)
1G024xD0y	24	0.50 (12.8)	73 (109)	600 (2,700)	200 (890)	10.0 (256)	5.0 (128)
1G036xD0y	36	0.50 (12.8)	73 (109)	600 (2,700)	200 (890)	10.0 (256)	5.0 (128)
1G048xD0y	48	0.50 (12.8)	73 (109)	600 (2,700)	200 (890)	10.0 (256)	5.0 (128)
1G072xD0y	72	0.53 (13.4)	86 (128)	600 (2,700)	200 (890)	10.6 (268)	5.3 (134)
1G096xD0y	96	0.59 (15.1)	110 (164)	600 (2,700)	200 (890)	11.8 (302)	5.9 (151)
1G144xD0y	144	0.72 (18.4)	162 (242)	600 (2,700)	200 (890)	14.4 (368)	7.2 (184)
1G216xD0y	216	0.72 (18.4)	157 (235)	600 (2,700)	200 (890)	14.4 (368)	7.2 (184)
1G288xD0y	288	0.84 (21.3)	205 (306)	600 (2,700)	200 (890)	16.8 (426)	8.4 (213)

## FIBER TYPES:

### SINGLE MODE

Reduced Water Peak	Zero Water Peak	TeraFlex® Bend Resistant					
		G.657.A1	G.657.A2	G.657.B3	NZDS	LEAF	
<sup>1</sup> Replace "x" with:	3	2	K	J	L	8	S

See "Optical Fiber Specifications" in the "Technical Info" section for detailed fiber type specifications.

### MULTIMODE

TeraGain® 62.5/125	TeraFlex Bend Resistant Laser Optimized 50/125			
	10G/150	10G/300	10G/550	
	6	M	N	P

## WATER BLOCK AND JACKET PRINT CODES

	Dry core		Dry core special	
	Feet	Meters	Feet	Meters
<sup>1</sup> Replace "y" with:	1	2	5	6

# Dri-Lite® Loose Tube Single Jacket Single Armor

Series 12D

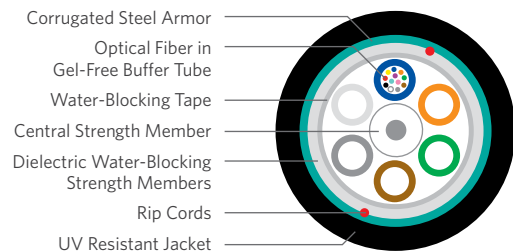

## SPECIFICATIONS

<b>Fiber Count</b>	Available in 6-fiber up to 432-fiber
<b>Standards Compliance</b>	Telcordia® GR-20-CORE RDUP PE-90 Designation MLT ICEA S-87-640-2011 RoHS-compliant

Telcordia is a registered trademark of Ericsson Inc.

## ENVIRONMENTAL SPECIFICATIONS

<b>Operation/Storage</b>	-40°C to +70°C
<b>Installation</b>	-30°C to +70°C

## PART NUMBER KEY

1	2	-	-	-	x	D	0	y
1	2	3	4	5	6	7	8	9
Product family	Fiber count (006-432)			Fiber type	Internal designator	Water block/markings (1-8)		

Contact Customer Service for availability of non-standard offerings.

## PRODUCT DESCRIPTION

Loose tube cables are the product of choice as the backbone in Outside Plant (OSP) environments. The durable loose tube design offers reliable transmission performance over a broad temperature range. Optical fibers and water-blocking elements are placed inside gel-free buffer tubes. The core is constructed by stranding the buffer tubes around a central member using a reverse oscillating lay (ROL). The core is wrapped with flexible strength members covered with a water-blocking tape. A corrugated steel armor is applied and then encased with a black jacket. Rip cords are included under the armor for ease of entry.

## APPLICATIONS

- Direct bury, underground duct and lashed aerial
- Trunk, distribution and feeder cable
- Local loop, metro, long-haul and broadband network

## FEATURES

- Available with up to 432-fiber
- Multiple fiber types including composites
- Dry (SAP) core standard
- Standard tube size for all fiber counts
- Corrugated steel armor
- Gel-free tubes

## BENEFITS

- High fiber density
- Multiple network applications
- Reduces cable prep and installation time
- Reduces the number of tools required
- Improves compressive strength and rodent protection
- Speeds fiber access and cleanup

## PART NUMBERS AND PHYSICAL CHARACTERISTICS

Part Number <sup>1</sup>	Fiber Count	Nominal Diameter in (mm)	Approx. Weight lbs/kft (kg/km)	Maximum Tensile Loading		Minimum Bend Radius	
				Install lbs (N)	Long Term lbs (N)	Install in (mm)	Long Term in (mm)
12006xD0y	6	0.46 (11.7)	84 (125)	600 (2,700)	200 (890)	9.2 (234)	4.6 (117)
12012xD0y	12	0.46 (11.7)	84 (125)	600 (2,700)	200 (890)	9.2 (234)	4.6 (117)
12024xD0y	24	0.46 (11.7)	84 (125)	600 (2,700)	200 (890)	9.2 (234)	4.6 (117)
12036xD0y	36	0.46 (11.7)	84 (125)	600 (2,700)	200 (890)	9.2 (234)	4.6 (117)
12048xD0y	48	0.46 (11.7)	84 (125)	600 (2,700)	200 (890)	9.2 (234)	4.6 (117)
12072xD0y	72	0.49 (12.3)	100 (149)	600 (2,700)	200 (890)	9.8 (246)	4.9 (123)
12096xD0y	96	0.56 (14.3)	125 (186)	600 (2,700)	200 (890)	11.2 (286)	5.6 (143)
12144xD0y	144	0.69 (17.6)	182 (271)	600 (2,700)	200 (890)	13.8 (352)	6.9 (176)
12192xD0y	192	0.69 (17.6)	177 (264)	600 (2,700)	200 (890)	13.8 (352)	6.9 (176)
12216xD0y	216	0.69 (17.6)	177 (264)	600 (2,700)	200 (890)	13.8 (352)	6.9 (176)
12288xD0y	288	0.80 (20.3)	228 (340)	600 (2,700)	200 (890)	16.0 (406)	8.0 (203)
12432xD0y	432	0.91 (21.0)	273.7 (407.4)	600 (2,700)	200 (890)	18.2 (460)	9.2 (234)

## FIBER TYPES:

### SINGLE MODE

Reduced Water Peak	Zero Water Peak	TeraFlex® Bend Resistant			NZDS	LEAF	
		G.657.A1	G.657.A2	G.657.B3			
<sup>1</sup> Replace "x" with:	3	2	K	J	L	8	S

### MULTIMODE

TeraGain®	TeraFlex Bend Resistant Laser Optimized 50/125		
62.5/125	10G/150	10G/300	10G/550
6	M	N	P

See "Optical Fiber Specifications" in the "Technical Info" section for detailed fiber type specifications.

## WATER BLOCK AND JACKET PRINT CODES

	Dry core		Dry core special	
	Feet	Meters	Feet	Meters
<sup>1</sup> Replace "y" with:	1	2	5	6

# Dri-Lite® Loose Tube Double Jacket Single Armor

Series 1AD

## PRODUCT DESCRIPTION

Loose tube cables are the product of choice as the backbone in Outside Plant (OSP) environments. The durable loose tube design offers reliable transmission performance over a broad temperature range. Optical fibers are placed inside gel-free buffer tubes. The core is constructed by stranding the buffer tubes around a central member using a reverse oscillating lay (ROL). The core is wrapped with flexible strength members covered with a water-blocking tape then encased with a black inner jacket. Water-blocking yarns and a corrugated steel armor are applied and a black outer jacket completes the cable construction. Rip cords are included under the inner jacket and armor for ease of entry.

## APPLICATIONS

- Direct bury, underground duct and lashed aerial
- Trunk, distribution and feeder cables
- Local loop, metro, long-haul and broadband network

## FEATURES

- Available with up to 288-fiber
- Multiple fiber types including composites
- Dry (SAP) core standard
- Standard tube size for all fiber counts
- Corrugated steel armor
- Gel-free tubes

## BENEFITS

- High fiber density
- Multiple network applications
- Reduces cable prep and installation time
- Reduces the number of tools required
- Improves compressive strength and rodent protection
- Speeds fiber access and cleaning

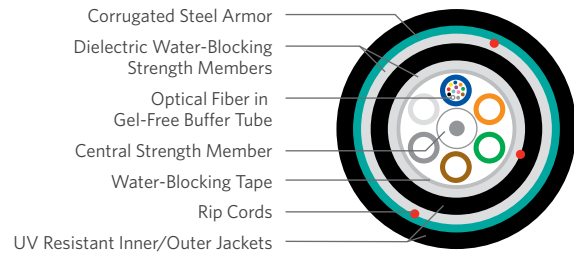

## SPECIFICATIONS

<b>Fiber Count</b>	Available in 12-fiber up to 288-fiber
<b>Standards Compliance</b>	Telcordia® GR-20-CORE RDUP PE-90 Designation MLT ICEA S-87-640-2011 RoHS-compliant

Telcordia is a registered trademark of Ericsson Inc.

## ENVIRONMENTAL SPECIFICATIONS

<b>Operation/Storage</b>	-40°C to +70°C
<b>Installation</b>	-30°C to +70°C

## PART NUMBER KEY

1	A	-	-	-	x	D	0	y
1	2	3	4	5	6	7	8	9
Product family	Fiber count (012-288)	Fiber type	Internal designator	Water block/ marking (1-8)				

Contact Customer Service for availability of non-standard offerings.

## PART NUMBERS AND PHYSICAL CHARACTERISTICS

Part Number <sup>1</sup>	Fiber Count	Nominal Diameter in (mm)	Approx. Weight lbs/kft (kg/km)	Maximum Tensile Loading		Minimum Bend Radius	
				Install lbs (N)	Long Term lbs (N)	Install in (mm)	Long Term in (mm)
1A012xD0y	12	0.56 (14.1)	119 (178)	600 (2,700)	200 (890)	11.2 (282)	5.6 (141)
1A024xD0y	24	0.56 (14.1)	119 (178)	600 (2,700)	200 (890)	11.2 (282)	5.6 (141)
1A036xD0y	36	0.56 (14.1)	119 (178)	600 (2,700)	200 (890)	11.2 (282)	5.6 (141)
1A048xD0y	48	0.56 (14.1)	119 (178)	600 (2,700)	200 (890)	11.2 (282)	5.6 (141)
1A072xD0y	72	0.58 (14.9)	138 (206)	600 (2,700)	200 (890)	11.6 (298)	5.8 (149)
1A096xD0y	96	0.65 (16.6)	166 (248)	600 (2,700)	200 (890)	13.0 (322)	6.5 (166)
1A144xD0y	144	0.78 (19.9)	230 (343)	600 (2,700)	200 (890)	15.6 (398)	7.8 (199)
1A216xD0y	216	0.78 (19.9)	226 (336)	600 (2,700)	200 (890)	15.6 (398)	7.8 (199)
1A288xD0y	288	0.90 (22.9)	283 (422)	600 (2,700)	200 (890)	18.0 (458)	9.0 (229)

## FIBER TYPES:

### SINGLE MODE

Reduced Water Peak	Zero Water Peak	TeraFlex® Bend Resistant					
		G.657.A1	G.657.A2	G.657.B3	NZDS	LEAF	
<sup>1</sup> Replace "x" with:	3	2	K	J	L	8	S

See "Optical Fiber Specifications" in the "Technical Info" section for detailed fiber type specifications.

### MULTIMODE

TeraGain® 62.5/125	TeraFlex Bend Resistant Laser Optimized 50/125			
	10G/150	10G/300	10G/550	
	6	M	N	P

## WATER BLOCK AND JACKET PRINT CODES

Dry core		Dry core special		
Feet	Meters	Feet	Meters	
<sup>1</sup> Replace "y" with:	1	2	5	6

# Dri-Lite® Loose Tube Double Jacket Double Armor

Series 1DD

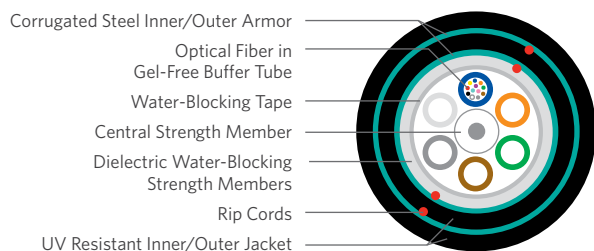

## PRODUCT DESCRIPTION

Loose tube cables are the product of choice as the backbone in Outside Plant (OSP) environments. The durable loose tube design offers reliable transmission performance over a broad temperature range. Optical fibers are placed inside gel-free buffer tubes. The core is constructed by stranding the buffer tubes around a central member using a reverse oscillating lay (ROL). The core is wrapped with flexible strength members and covered with a water-blocking tape. A corrugated steel armor is applied and encased with a black inner jacket. More water-blocking yarns, a corrugated steel armor and a black outer jacket complete the cable construction. Rip cords are included under each armor for ease of entry.

## APPLICATIONS

- Direct bury, underground duct and lashed aerial
- Trunk, distribution and feeder cable
- Local loop, metro, long-haul and broadband network

## FEATURES

- Available with up to 216-fiber
- Multiple fiber types including composites
- Dry (SAP) core standard
- Standard tube size for all fiber counts
- Corrugated steel armor
- Gel-free tubes

## BENEFITS

- High fiber density
- Multiple network applications
- Reduces cable prep and installation time
- Reduces the number of tools required
- Improves compressive strength and rodent protection
- Speeds fiber access and cleanup

## SPECIFICATIONS

**Fiber Count** Available in 12-fiber up to 216-fiber

**Standards Compliance** Telcordia® GR-20-CORE  
RDUP PE-90 Designation MLT  
ICEA S-87-640-2011  
RoHS-compliant

Telcordia is a registered trademark of Ericsson Inc.

## ENVIRONMENTAL SPECIFICATIONS

**Operation/Storage** -40°C to +70°C

**Installation** -30°C to +70°C

## PART NUMBER KEY

1	D	—	—	—	x	D	0	y
1	2	3	4	5	6	7	8	9
Product family	Fiber count (012-216)	Fiber type	Internal designator	Water block/marking (1-8)				

Contact Customer Service for availability of non-standard offerings.

## PART NUMBERS AND PHYSICAL CHARACTERISTICS

Part Number <sup>1</sup>	Fiber Count	Nominal Diameter in (mm)	Approx. Weight lbs/kft (kg/km)	Maximum Tensile Loading		Minimum Bend Radius	
				Install lbs (N)	Long Term lbs (N)	Install in (mm)	Long Term in (mm)
1D0y2xD0y	12	0.63 (16.1)	178 (266)	600 (2,700)	200 (890)	12.6 (322)	6.3 (161)
1D024xD0y	24	0.63 (16.1)	178 (266)	600 (2,700)	200 (890)	12.6 (322)	6.3 (161)
1D036xD0y	36	0.63 (16.1)	178 (266)	600 (2,700)	200 (890)	12.6 (322)	6.3 (161)
1D048xD0y	48	0.63 (16.1)	178 (266)	600 (2,700)	200 (890)	12.6 (322)	6.3 (161)
1D072xD0y	72	0.66 (16.9)	196 (293)	600 (2,700)	200 (890)	13.2 (338)	6.6 (169)
1D096xD0y	96	0.74 (18.9)	233 (348)	600 (2,700)	200 (890)	14.8 (378)	7.4 (189)
1D144xD0y	144	0.88 (22.4)	315 (470)	600 (2,700)	200 (890)	17.6 (448)	8.8 (224)
1D216xD0y	216	0.88 (22.4)	310 (463)	600 (2,700)	200 (890)	17.6 (448)	8.8 (224)

## FIBER TYPES:

### SINGLE MODE

Reduced Water Peak    Zero Water Peak    TeraFlex® Bend Resistant  
G.657.A1    G.657.A2    G.657.B3    NZDS    LEAF

<sup>1</sup>Replace "x" with:

3    2    K    J    L    8    S

See "Optical Fiber Specifications" in the "Technical Info" section for detailed fiber type specifications.

### MULTIMODE

TeraGain®    TeraFlex Bend Resistant Laser Optimized 50/125  
62.5/125    10G/150    10G/300    10G/550

6    M    N    P

## WATER BLOCK AND JACKET PRINT CODES

Dry core    Dry core special  
Feet    Meters    Feet    Meters

<sup>1</sup>Replace "y" with: 1    2    5    6



# Dri-Lite® Loose Tube Triple Jacket Double Armor

Series 1CD

## PRODUCT DESCRIPTION

Loose tube cables are the product of choice as the backbone in Outside Plant (OSP) environments. The durable loose tube design offers reliable transmission performance over a broad temperature range. Optical fibers are placed inside gel-free buffer tubes. The core is constructed by stranding the buffer tubes around a central member using a reverse oscillating lay (ROL). The core is wrapped with flexible strength members covered with a water-blocking tape, then encased in a black inner jacket. Flexible strength members are applied with a corrugated steel armor and an intermediate black jacket. Another layer of flexible strength members with a corrugated steel armor and a black outer jacket completes the cable construction. Rip cords are included under the inner jacket and each armor for ease of entry.

## APPLICATIONS

- Direct bury, underground duct and lashed aerial
- Trunk, distribution and feeder cables
- Local loop, metro, long-haul and broadband network

## FEATURES

- Available with up to 144-fiber
- Multiple fiber types including composites
- Dry (SAP) core standard
- Standard tube size for all fiber counts
- Corrugated steel armor
- Gel-free tubes

## BENEFITS

- High fiber density
- Multiple network applications
- Reduces cable prep and installation time
- Reduces the number of tools required
- Improves compressive strength and rodent protection
- Speeds fiber access and cleanup



- Corrugated Steel Inner/Outer Armor
- Optical Fiber in Gel-Free Buffer Tube
- Water-Blocking Tape
- Central Strength Member
- Dielectric Water-Blocking Strength Members
- Rip Cords
- UV Resistant Inner, Central and Outer Jackets

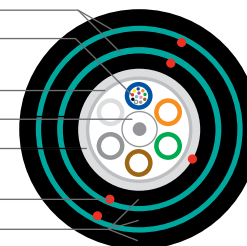

## SPECIFICATIONS

<b>Fiber Count</b>	Available in 12-fiber up to 144-fiber
<b>Standards Compliance</b>	Telcordia® GR-20-CORE RDUP PE-90 Designation MLT ICEA S-87-640-2011 RoHS-compliant

Telcordia is a registered trademark of Ericsson Inc.

## ENVIRONMENTAL SPECIFICATIONS

<b>Operation/Storage</b>	-40°C to +70°C
<b>Installation</b>	-30°C to +70°C

## PART NUMBER KEY

1	C	_	_	_	x	D	0	y
1	2	3	4	5	6	7	8	9
Product family	Fiber count (012-144)				Fiber type	Internal designator	Water block/marking (1-8)	

Contact Customer Service for availability of non-standard offerings.

## PART NUMBERS AND PHYSICAL CHARACTERISTICS

Part Number <sup>1</sup>	Fiber Count	Nominal Diameter in (mm)	Approx. Weight lbs/kft (kg/km)	Maximum Tensile Loading		Minimum Bend Radius	
				Install lbs (N)	Long Term lbs (N)	Install in (mm)	Long Term in (mm)
1C012xD0y	12	0.73 (18.6)	229 (341)	600 (2,700)	200 (890)	14.6 (372)	7.3 (186)
1C024xD0y	24	0.73 (18.6)	229 (341)	600 (2,700)	200 (890)	14.6 (372)	7.3 (186)
1C036xD0y	36	0.73 (18.6)	229 (341)	600 (2,700)	200 (890)	14.6 (372)	7.3 (186)
1C048xD0y	48	0.73 (18.6)	229 (341)	600 (2,700)	200 (890)	14.6 (372)	7.3 (186)
1C072xD0y	72	0.76 (19.4)	252 (376)	600 (2,700)	200 (890)	15.2 (384)	7.6 (194)
1C096xD0y	96	0.83 (21.1)	289 (431)	600 (2,700)	200 (890)	16.6 (422)	8.3 (211)
1C144xD0y	144	0.96 (24.4)	376 (560)	600 (2,700)	200 (890)	19.2 (488)	9.6 (244)

## FIBER TYPES:

### SINGLE MODE

Reduced Water Peak	Zero Water Peak	TeraFlex® Bend Resistant				
		G.657.A1	G.657.A2	G.657.B3	NZDS	LEAF

<sup>1</sup>Replace "x" with:

3	2	K	J	L	8	S
---	---	---	---	---	---	---

See "Optical Fiber Specifications" in the "Technical Info" section for detailed fiber type specifications.

### MULTIMODE

TeraGain® 62.5/125	TeraFlex Bend Resistant Laser Optimized 50/125		
	10G/150	10G/300	10G/550

6	M	N	P
---	---	---	---

## WATER BLOCK AND JACKET PRINT CODES

	Dry core		Dry core special	
	Feet	Meters	Feet	Meters
<sup>1</sup> Replace "y" with:	1	2	5	6

# Loose Tube Single Jacket All Dielectric

Series 11

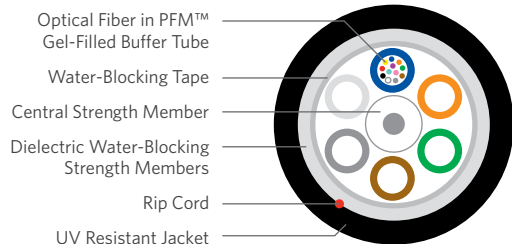

## SPECIFICATIONS

**Fiber Count** Available in 2-fiber up to 432-fiber

**Standards Compliance** Telcordia® GR-20-CORE  
RDUP PE-90 Designation MLT  
ICEA S-87-640-2011  
RoHS-compliant

Telcordia is a registered trademark of Ericsson Inc.

## ENVIRONMENTAL SPECIFICATIONS

**Operation/Storage** -40°C to +70°C

**Installation** -30°C to +70°C

## PART NUMBER KEY

1	1	–	–	–	x	x	0	y
1	2	3	4	5	6	7	8	9
Product family	Fiber count (002-432)			Fiber type	Internal designator	Water block/marking (1-8)		

Contact Customer Service for availability of non-standard offerings.

## PART NUMBERS AND PHYSICAL CHARACTERISTICS

Part Number <sup>1</sup>	Fiber Count	Nominal Diameter in (mm)	Approx. Weight lbs/kft (kg/km)	Maximum Tensile Loading		Minimum Bend Radius	
				Install lbs (N)	Long Term lbs (N)	Install in (mm)	Long Term in (mm)
11006xx0y	6	0.41 (10.3)	47 (70)	600 (2,700)	200 (890)	8.2 (206)	4.1 (103)
11012xx0y	12	0.41 (10.3)	47 (70)	600 (2,700)	200 (890)	8.2 (206)	4.1 (103)
11018xx0y	18	0.41 (10.3)	47 (70)	600 (2,700)	200 (890)	8.2 (206)	4.1 (103)
11024xx0y	24	0.41 (10.3)	47 (70)	600 (2,700)	200 (890)	8.2 (206)	4.1 (103)
11036xx0y	36	0.41 (10.3)	47 (70)	600 (2,700)	200 (890)	8.2 (206)	4.1 (103)
11048xx0y	48	0.41 (10.3)	47 (70)	600 (2,700)	200 (890)	8.2 (206)	4.1 (103)
11060xx0y	60	0.41 (10.3)	47 (70)	600 (2,700)	200 (890)	8.2 (206)	4.1 (103)
11072xx0y	72	0.43 (11.0)	61 (91)	600 (2,700)	200 (890)	8.6 (220)	4.3 (110)
11096xx0y	96	0.50 (12.7)	79 (118)	600 (2,700)	200 (890)	10.0 (254)	5.0 (127)
11144xx0y	144	0.63 (16.0)	124 (185)	600 (2,700)	200 (890)	12.6 (320)	6.3 (160)
11216xx0y	216	0.63 (16.0)	120 (179)	600 (2,700)	200 (890)	12.6 (320)	6.3 (160)
11288xx0y	288	0.74 (18.9)	161 (240)	600 (2,700)	200 (890)	14.8 (378)	7.4 (189)
11432xx0y	432	0.82 (21.0)	137 (205)	600 (2,700)	200 (890)	16.4 (420)	8.2 (210)

## FIBER TYPES:

### SINGLE MODE

Reduced Water Peak    Zero Water Peak    TeraFlex® Bend Resistant

G.657.A1   G.657.A2   G.657.B3   NZDS   LEAF

<sup>1</sup>For ≤ 36 fibers replace "xx" with:

3T    2T    KT    JT    LT    8T    ST

<sup>1</sup>For > 36 fibers replace "xx" with:

31    21    K1    J1    L1    81    S1

### MULTIMODE

TeraGain®    TeraFlex Bend Resistant Laser Optimized 50/125

62.5/125    10G/150    10G/300    10G/550

6G    MG    NG    PG

See "Optical Fiber Specifications" in the "Technical Info" section for detailed fiber type specifications.

## WATER BLOCK AND JACKET PRINT CODES

Dry core    Dry core special

Feet    Meters    Feet    Meters

<sup>1</sup>Replace "y" with:    1    2    5    6

## PRODUCT DESCRIPTION

Loose tube cables are the product of choice as the backbone in Outside Plant (OSP) environments. The durable loose tube design offers reliable transmission performance over a broad temperature range. Optical fibers are placed inside filled buffer tubes containing PFM™ gel. The core is constructed by stranding the buffer tubes around a central member using a reverse oscillating lay (ROL). The core is wrapped with flexible strength members covered with a water-blocking tape, then encased with a black jacket. A rip cord is included under the jacket for ease of entry.

## APPLICATIONS

- Underground duct and lashed aerial
- Trunk, distribution and feeder cable
- Local loop, metro, long-haul and broadband network

## FEATURES

- Available with up to 432-fiber
- Multiple fiber types including composites
- Central strength members available in metallic or dielectric
- Dry (SAP) core standard
- Standard tube size for all fiber counts
- PFM gel

## BENEFITS

- High fiber density
- Multiple network applications
- Metallic option offers ease of location, dielectric design eliminates grounding issues
- Reduces cable prep and installation time
- Reduces the number of tools required
- Non-sticky gel speeds fiber access and cleanup

# Loose Tube Double Jacket Non-Armor

Series 1G

## PRODUCT DESCRIPTION

Loose tube cables are the product of choice as the backbone in Outside Plant (OSP) environments. The durable loose tube design offers reliable transmission performance over a broad temperature range. Optical fibers are placed inside filled buffer tubes containing PFM™ gel. The core is constructed by stranding the buffer tubes around a central member using a reverse oscillating lay (ROL). The core is wrapped with flexible strength members covered with a water-blocking tape, then encased with a black inner jacket. Water-blocking yarns and a black outer jacket are applied. Rip cords are included under each jacket for ease of entry.

## APPLICATIONS

- Underground duct and lashed aerial
- Trunk, distribution and feeder cables
- Local loop, metro, long-haul and broadband network

## FEATURES

- Available with up to 288-fiber
- Multiple fiber types including composites
- Central strength members available in metallic or dielectric
- Dry (SAP) core standard
- Standard tube size for all fiber counts
- PFM gel

## BENEFITS

- High fiber density
- Multiple network applications
- Metallic option offers ease of location, dielectric design eliminates grounding issues
- Reduces cable prep and installation time
- Reduces the number of tools required
- Non-sticky gel speeds fiber access and clean-up

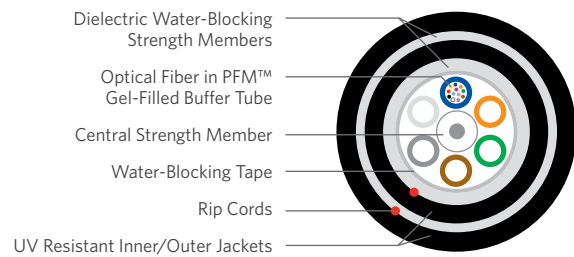

## SPECIFICATIONS

<b>Fiber Count</b>	Available in 6-fiber up to 288-fiber
<b>Standards Compliance</b>	Telcordia® GR-20-CORE RDUP PE-90 Designation MLT ICEA S-87-640-2011 RoHS-compliant

Telcordia is a registered trademark of Ericsson Inc.

## ENVIRONMENTAL SPECIFICATIONS

<b>Operation/Storage</b>	-40°C to +70°C
<b>Installation</b>	-30°C to +70°C

## PART NUMBER KEY

1	G	_	_	_	x	x	0	y
1	2	3	4	5	6	7	8	9
Product family	Fiber count (006-288)			Fiber type	Internal designator	Water block/ marking (1-8)		

Contact Customer Service for availability of non-standard offerings.

## PART NUMBERS AND PHYSICAL CHARACTERISTICS

Part Number <sup>1</sup>	Fiber Count	Nominal Diameter in (mm)	Approx. Weight lbs/kft (kg/km)	Maximum Tensile Loading		Minimum Bend Radius	
				Install lbs (N)	Long Term lbs (N)	Install in (mm)	Long Term in (mm)
1G006xx0y	6	0.50 (12.8)	73 (109)	600 (2,700)	200 (890)	10.0 (256)	5.0 (128)
1G012xx0y	12	0.50 (12.8)	73 (109)	600 (2,700)	200 (890)	10.0 (256)	5.0 (128)
1G024xx0y	24	0.50 (12.8)	73 (109)	600 (2,700)	200 (890)	10.0 (256)	5.0 (128)
1G036xx0y	36	0.50 (12.8)	73 (109)	600 (2,700)	200 (890)	10.0 (256)	5.0 (128)
1G048xx0y	48	0.50 (12.8)	73 (109)	600 (2,700)	200 (890)	10.0 (256)	5.0 (128)
1G072xx0y	72	0.53 (13.4)	86 (128)	600 (2,700)	200 (890)	10.6 (268)	5.3 (134)
1G096xx0y	96	0.59 (15.1)	110 (164)	600 (2,700)	200 (890)	11.8 (302)	5.9 (151)
1G144xx0y	144	0.72 (18.4)	163 (242)	600 (2,700)	200 (890)	14.4 (368)	7.2 (184)
1G216xx0y	216	0.72 (18.4)	157 (235)	600 (2,700)	200 (890)	14.4 (368)	7.2 (184)
1G288xx0y	288	0.84 (21.3)	205 (306)	600 (2,700)	200 (890)	16.8 (426)	8.4 (213)

## FIBER TYPES:

### SINGLE MODE

Reduced Water Peak	Zero Water Peak	TeraFlex® Bend Resistant				
		G.657.A1	G.657.A2	G.657.B3	NZDS	LEAF
3T	2T	KT	JT	LT	8T	ST
31	21	K1	J1	L1	81	S1

<sup>1</sup>For ≤ 36 fibers replace "xx" with:

<sup>1</sup>For > 36 fibers replace "xx" with:

### MULTIMODE

TeraGain® 62.5/125	TeraFlex Bend Resistant Laser Optimized 50/125		
	10G/150	10G/300	10G/550
6G	MG	NG	PG

See "Optical Fiber Specifications" in the "Technical Info" section for detailed fiber type specifications.

## WATER BLOCK AND JACKET PRINT CODES

	Dry core		Dry core special	
	Feet	Meters	Feet	Meters
<sup>1</sup> Replace "y" with:	1	2	5	6

# Loose Tube Single Jacket Single Armor

Series 12

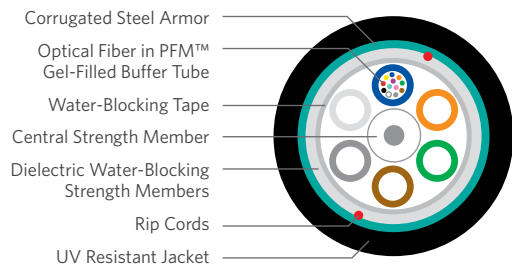

## SPECIFICATIONS

**Fiber Count** Available in 2-fiber up to 432-fiber

**Standards Compliance** Telcordia® GR-20-CORE  
RDUP PE-90 Designation MLT  
ICEA S-87-640-2011  
RoHS-compliant

Telcordia is a registered trademark of Ericsson Inc.

## ENVIRONMENTAL SPECIFICATIONS

**Operation/Storage** -40°C to +70°C

**Installation** -30°C to +70°C

## PART NUMBER KEY

1	2	—	—	—	x	x	0	y
1	2	3	4	5	6	7	8	9
Product family	Fiber count (002-432)			Fiber type	Internal designator	Water block/marking (1-8)		

Contact Customer Service for availability of non-standard offerings.

## PART NUMBERS AND PHYSICAL CHARACTERISTICS

Part Number <sup>1</sup>	Fiber Count	Nominal Diameter in (mm)	Approx. Weight lbs/kft (kg/km)	Maximum Tensile Loading		Minimum Bend Radius	
				Install lbs (N)	Long Term lbs (N)	Install in (mm)	Long Term in (mm)
12006xx0y	6	0.46 (11.7)	84 (125)	600 (2,700)	200 (890)	9.2 (234)	4.6 (117)
12012xx0y	12	0.46 (11.7)	84 (125)	600 (2,700)	200 (890)	9.2 (234)	4.6 (117)
12018xx0y	18	0.46 (11.7)	84 (125)	600 (2,700)	200 (890)	9.2 (234)	4.6 (117)
12024xx0y	24	0.46 (11.7)	84 (125)	600 (2,700)	200 (890)	9.2 (234)	4.6 (117)
12036xx0y	36	0.46 (11.7)	84 (125)	600 (2,700)	200 (890)	9.2 (234)	4.6 (117)
12048xx0y	48	0.46 (11.7)	84 (125)	600 (2,700)	200 (890)	9.2 (234)	4.6 (117)
12072xx0y	72	0.49 (12.3)	100 (149)	600 (2,700)	200 (890)	9.8 (246)	4.9 (123)
12096xx0y	96	0.56 (14.3)	125 (186)	600 (2,700)	200 (890)	11.2 (286)	5.6 (143)
12144xx0y	144	0.69 (17.6)	182 (271)	600 (2,700)	200 (890)	13.8 (352)	6.9 (176)
12192xx0y	192	0.69 (17.6)	177 (264)	600 (2,700)	200 (890)	13.8 (352)	6.9 (176)
12216xx0y	216	0.69 (17.6)	177 (264)	600 (2,700)	200 (890)	13.8 (352)	6.9 (176)
12288xx0y	288	0.80 (20.3)	228 (340)	600 (2,700)	200 (890)	16.0 (406)	8.0 (203)
12432xx0y	432	0.91 (23.0)	289 (431)	600 (2,700)	200 (890)	18.2 (460)	9.1 (230)

## FIBER TYPES:

### SINGLE MODE

Reduced Water Peak	Zero Water Peak	TeraFlex® Bend Resistant				
		G.657.A1	G.657.A2	G.657.B3	NZDS	LEAF
3T	2T	KT	JT	LT	8T	ST
31	21	K1	J1	L1	81	S1

<sup>1</sup>For ≤ 36 fibers replace "xx" with:

<sup>1</sup>For > 36 fibers replace "xx" with:

### MULTIMODE

TeraFlex Bend Resistant Laser Optimized 50/125			
TeraGain®	10G/150	10G/300	10G/550
6G	MG	NG	PG

See "Optical Fiber Specifications" in the "Technical Info" section for detailed fiber type specifications.

## WATER BLOCK AND JACKET PRINT CODES

Dry core		Dry core special	
Feet	Meters	Feet	Meters
<sup>1</sup> Replace "y" with:	1	2	5
	2	5	6

<sup>1</sup>Replace "y" with:

## PRODUCT DESCRIPTION

Loose tube cables are the product of choice as the backbone in Outside Plant (OSP) environments. The durable loose tube design offers reliable transmission performance over a broad temperature range. Optical fibers are placed inside filled buffer tubes containing PFM™ gel. The core is constructed by stranding the buffer tubes around a central member using a reverse oscillating lay (ROL). The core is wrapped with flexible strength members covered with a water-blocking tape. A corrugated steel armor is applied and then encased with a black jacket. Rip cords are included under the armor for ease of entry.

## APPLICATIONS

- Direct bury, underground duct and lashed aerial
- Trunk, distribution and feeder cable
- Local loop, metro, long-haul and broadband network

## FEATURES

- Available with up to 432-fiber
- Multiple fiber types including composites
- Dry (SAP) core standard
- Standard tube size for all fiber counts
- Corrugated steel armor
- PFM gel

## BENEFITS

- High fiber density
- Multiple network applications
- Reduces cable prep and installation time
- Reduces the number of tools required
- Improves compressive strength and rodent protection
- Non-sticky gel speeds fiber access and clean-up

# Loose Tube Double Jacket Single Armor

Series 1A

## PRODUCT DESCRIPTION

Loose tube cables are the product of choice as the backbone in Outside Plant (OSP) environments. The durable loose tube design offers reliable transmission performance over a broad temperature range. Optical fibers are placed inside filled buffer tubes containing PFM™ gel. The core is constructed by stranding the buffer tubes around a central member using a reverse oscillating lay (ROL). The core is wrapped with flexible strength members covered with a water-blocking tape then encased with a black inner jacket. Water-blocking yarns and a corrugated steel armor are applied and a black outer jacket completes the cable construction. Rip cords are included under the inner jacket and armor for ease of entry.

## APPLICATIONS

- Direct bury, underground duct and lashed aerial
- Trunk, distribution and feeder cables
- Local loop, metro, long-haul and broadband network

## FEATURES

- Available with up to 288-fiber
- Multiple fiber types including composites
- Dry (SAP) core standard
- Standard tube size for all fiber counts
- Corrugated steel armor
- PFM gel

## BENEFITS

- High fiber density
- Multiple network applications
- Reduces cable prep and installation time
- Reduces the number of tools required
- Improves compressive strength and rodent protection
- Non-sticky gel speeds fiber access and clean-up

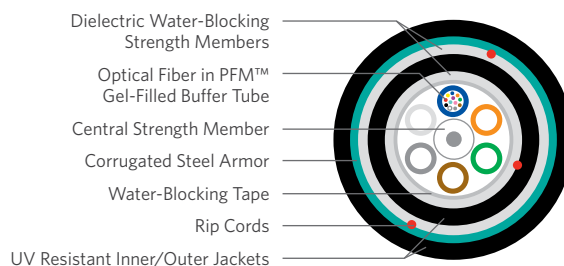

## SPECIFICATIONS

<b>Fiber Count</b>	Available in 2-fiber up to 288-fiber
<b>Standards Compliance</b>	Telcordia® GR-20-CORE RDUP PE-90 Designation MLT ICEA S-87-640-2011 RoHS-compliant

Telcordia is a registered trademark of Ericsson Inc.

## ENVIRONMENTAL SPECIFICATIONS

<b>Operation/Storage</b>	-40°C to +70°C
<b>Installation</b>	-30°C to +70°C

## PART NUMBER KEY

1	A	—	—	—	x	x	0	y
1	2	3	4	5	6	7	8	9
Product family	Fiber count (002-288)				Fiber type	Internal designator	Water block/markings (1-8)	

Contact Customer Service for availability of non-standard offerings.

## PART NUMBERS AND PHYSICAL CHARACTERISTICS

Part Number <sup>1</sup>	Fiber Count	Nominal Diameter in (mm)	Approx. Weight lbs/kft (kg/km)	Maximum Tensile Loading		Minimum Bend Radius	
				Install lbs (N)	Long Term lbs (N)	Install in (mm)	Long Term in (mm)
1A006xx0y	6	0.56 (14.1)	119 (178)	600 (2,700)	200 (890)	11.2 (282)	5.6 (141)
1A012xx0y	12	0.56 (14.1)	119 (178)	600 (2,700)	200 (890)	11.2 (282)	5.6 (141)
1A024xx0y	24	0.56 (14.1)	119 (178)	600 (2,700)	200 (890)	11.2 (282)	5.6 (141)
1A036xx0y	36	0.56 (14.1)	119 (178)	600 (2,700)	200 (890)	11.2 (282)	5.6 (141)
1A048xx0y	48	0.56 (14.1)	119 (178)	600 (2,700)	200 (890)	11.2 (282)	5.6 (141)
1A072xx0y	72	0.58 (14.9)	138 (206)	600 (2,700)	200 (890)	11.6 (298)	5.8 (149)
1A096xx0y	96	0.65 (16.6)	166 (248)	600 (2,700)	200 (890)	13.0 (322)	6.5 (166)
1A144xx0y	144	0.78 (19.9)	230 (343)	600 (2,700)	200 (890)	15.6 (398)	7.8 (199)
1A216xx0y	216	0.78 (19.9)	226 (336)	600 (2,700)	200 (890)	15.6 (398)	7.8 (199)
1A288xx0y	288	0.90 (22.9)	283 (422)	600 (2,700)	200 (890)	18.0 (458)	9.0 (229)

## FIBER TYPES:

### SINGLE MODE

	Reduced Water Peak	Zero Water Peak	TeraFlex® Bend Resistant				
			G.657.A1	G.657.A2	G.657.B3	NZDS	LEAF
<sup>1</sup> For ≤ 36 fibers replace "xx" with:	3T	2T	KT	JT	LT	8T	ST
<sup>1</sup> For > 36 fibers replace "xx" with:	31	21	K1	J1	L1	81	S1

See "Optical Fiber Specifications" in the "Technical Info" section for detailed fiber type specifications.

### MULTIMODE

TeraGain®	TeraFlex Bend Resistant Laser Optimized 50/125			
	62.5/125	10G/150	10G/300	10G/550
6G	MG	NG	PG	

## WATER BLOCK AND JACKET PRINT CODES

	Dry core		Dry core special	
	Feet	Meters	Feet	Meters
<sup>1</sup> Replace "y" with:	1	2	5	6

# Loose Tube Double Jacket Double Armor

Series 1D

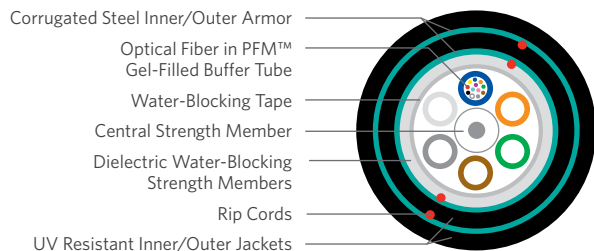

## PRODUCT DESCRIPTION

Loose tube cables are the product of choice as the backbone in Outside Plant (OSP) environments. The durable loose tube design offers reliable transmission performance over a broad temperature range. Optical fibers are placed inside filled buffer tubes containing PFM™ gel. The core is constructed by stranding the buffer tubes around a central member using a reverse oscillating lay (ROL). The core is wrapped with flexible strength members and covered with a water-blocking tape. A corrugated steel armor is applied and encased with a black inner jacket. More water-blocking yarns, a corrugated steel armor and a black outer jacket complete the cable construction. Rip cords are included under each armor for ease of entry.

## APPLICATIONS

- Direct bury, underground duct and lashed aerial
- Trunk, distribution and feeder cable
- Local loop, metro, long-haul and broadband network

## SPECIFICATIONS

Fiber Count	Available in 6-fiber up to 288-fiber
Standards Compliance	Telcordia® GR-20-CORE RDUP PE-90 Designation MLT ICEA S-87-640-2011 RoHS-compliant

Telcordia is a registered trademark of Ericsson Inc.

## ENVIRONMENTAL SPECIFICATIONS

Operation/Storage	-40°C to +70°C
Installation	-30°C to +70°C

## PART NUMBER KEY

1	D	—	—	—	x	x	0	y
1	2	3	4	5	6	7	8	9
Product family	Fiber count (006-288)	Fiber type	Internal designator	Water block/markings (1-8)				

Contact Customer Service for availability of non-standard offerings.

## PART NUMBERS AND PHYSICAL CHARACTERISTICS

Part Number <sup>1</sup>	Fiber Count	Nominal Diameter in (mm)	Approx. Weight lbs/kft (kg/km)	Maximum Tensile Loading		Minimum Bend Radius	
				Install lbs (N)	Long Term lbs (N)	Install in (mm)	Long Term in (mm)
1D006xx0y	6	0.63 (16.1)	178 (266)	600 (2,700)	200 (890)	12.6 (322)	6.3 (161)
1D012xx0y	12	0.63 (16.1)	178 (266)	600 (2,700)	200 (890)	12.6 (322)	6.3 (161)
1D024xx0y	24	0.63 (16.1)	178 (266)	600 (2,700)	200 (890)	12.6 (322)	6.3 (161)
1D036xx0y	36	0.63 (16.1)	178 (266)	600 (2,700)	200 (890)	12.6 (322)	6.3 (161)
1D048xx0y	48	0.63 (16.1)	178 (266)	600 (2,700)	200 (890)	12.6 (322)	6.3 (161)
1D072xx0y	72	0.66 (16.9)	196 (293)	600 (2,700)	200 (890)	13.2 (338)	6.6 (169)
1D096xx0y	96	0.74 (18.9)	233 (348)	600 (2,700)	200 (890)	14.8 (378)	7.4 (189)
1D144xx0y	144	0.88 (22.4)	315 (470)	600 (2,700)	200 (890)	17.6 (448)	8.8 (224)
1D216xx0y	216	0.88 (22.4)	310 (463)	600 (2,700)	200 (890)	17.6 (448)	8.8 (224)
1D288xx0y	288	0.99 (25.1)	377 (562)	600 (2,700)	200 (890)	19.8 (502)	9.9 (251)

## FIBER TYPES:

### SINGLE MODE

Reduced Water Peak	Zero Water Peak	TeraFlex® Bend Resistant				
		G.657.A1	G.657.A2	G.657.B3	NZDS	LEAF
<sup>1</sup> For ≤ 36 fibers replace "xx" with: 3T	2T	KT	JT	LT	8T	ST
<sup>1</sup> For > 36 fibers replace "xx" with: 31	21	K1	J1	L1	81	S1

### MULTIMODE

TeraGain® 62.5/125	TeraFlex Bend Resistant Laser Optimized 50/125		
	10G/150	10G/300	10G/550
6G	MG	NG	PG

See "Optical Fiber Specifications" in the "Technical Info" section for detailed fiber type specifications.

## WATER BLOCK AND JACKET PRINT CODES

	Dry core		Dry core special	
	Feet	Meters	Feet	Meters
<sup>1</sup> Replace "y" with:	1	2	5	6

## FEATURES

- Available with up to 288-fiber
- Multiple fiber types including composites
- Dry (SAP) core standard
- Standard tube size for all fiber counts
- Corrugated steel armor
- PFM gel

## BENEFITS

- High fiber density
- Multiple network applications
- Reduces cable prep and installation time
- Reduces the number of tools required
- Improves compressive strength and rodent protection
- Non-sticky gel speeds fiber access and clean-up

# Loose Tube Triple Jacket Double Armor

Series 1C

## PRODUCT DESCRIPTION

Loose tube cables are the product of choice as the backbone in Outside Plant (OSP) environments. The durable loose tube design offers reliable transmission performance over a broad temperature range. Optical fibers are placed inside filled buffer tubes containing PFM™ gel. The core is constructed by stranding the buffer tubes around a central member using a reverse oscillating lay (ROL). The core is wrapped with flexible strength members covered with a water-blocking tape, then encased in a black inner jacket. Flexible strength members are applied with a corrugated steel armor and an intermediate black jacket. Another layer of flexible strength members with a corrugated steel armor and a black outer jacket completes the cable construction. Rip cords are included under the inner jacket and each armor for ease of entry.

## APPLICATIONS

- Direct bury, underground duct and lashed aerial
- Trunk, distribution and feeder cables
- Local loop, metro, long-haul and broadband network

## FEATURES

- Available with up to 144-fiber
- Multiple fiber types including composites
- Dry (SAP) core standard
- Standard tube size for all fiber counts
- Corrugated steel armor
- PFM gel

## BENEFITS

- High fiber density
- Multiple network applications
- Reduces cable prep and installation time
- Reduces the number of tools required
- Improves compressive strength and rodent protection
- Non-sticky gel speeds fiber access and clean-up

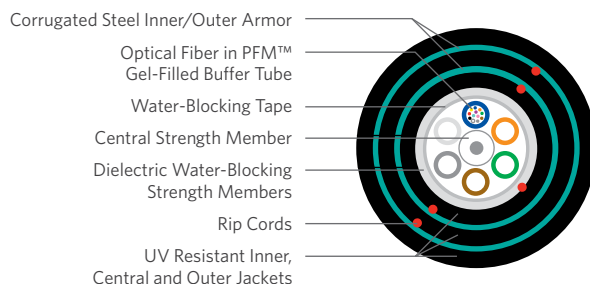

## SPECIFICATIONS

<b>Fiber Count</b>	Available in 6-fiber up to 144-fiber
<b>Standards Compliance</b>	Telcordia® GR-20-CORE RDUP PE-90 Designation MLT ICEA S-87-640-2011 RoHS-compliant

Telcordia is a registered trademark of Ericsson Inc.

## ENVIRONMENTAL SPECIFICATIONS

<b>Operation/Storage</b>	-40°C to +70°C
<b>Installation</b>	-30°C to +70°C

## PART NUMBER KEY

1	C	-	-	-	x	x	0	y
1	2	3	4	5	6	7	8	9
Product family	Fiber count (006-144)	Fiber type	Internal designator	Water block/ marking (1-8)				

Contact Customer Service for availability of non-standard offerings.

## PART NUMBERS AND PHYSICAL CHARACTERISTICS

Part Number <sup>1</sup>	Fiber Count	Nominal Diameter in (mm)	Approx. Weight lbs/kft (kg/km)	Maximum Tensile Loading		Minimum Bend Radius	
				Install lbs (N)	Long Term lbs (N)	Install in (mm)	Long Term in (mm)
1C006xx0y	6	0.73 (18.6)	229 (341)	600 (2,700)	200 (890)	14.6 (372)	7.3 (186)
1C012xx0y	12	0.73 (18.6)	229 (341)	600 (2,700)	200 (890)	14.6 (372)	7.3 (186)
1C024xx0y	24	0.73 (18.6)	229 (341)	600 (2,700)	200 (890)	14.6 (372)	7.3 (186)
1C036xx0y	36	0.73 (18.6)	229 (341)	600 (2,700)	200 (890)	14.6 (372)	7.3 (186)
1C048xx0y	48	0.73 (18.6)	229 (341)	600 (2,700)	200 (890)	14.6 (372)	7.3 (186)
1C072xx0y	72	0.76 (19.4)	252 (376)	600 (2,700)	200 (890)	15.2 (384)	7.6 (194)
1C096xx0y	96	0.83 (21.1)	289 (431)	600 (2,700)	200 (890)	16.6 (422)	8.3 (211)
1C144xx0y	144	0.96 (24.4)	376 (560)	600 (2,700)	200 (890)	19.2 (488)	9.6 (244)

## FIBER TYPES:

### SINGLE MODE

	TeraFlex® Bend Resistant						
	Reduced Water Peak	Zero Water Peak	G.657.A1	G.657.A2	G.657.B3	NZDS	LEAF
<sup>1</sup> For ≤ 36 fibers replace "xx" with:	3T	2T	KT	JT	LT	8T	ST
<sup>1</sup> For > 36 fibers replace "xx" with:	31	21	K1	J1	L1	81	S1

See "Optical Fiber Specifications" in the "Technical Info" section for detailed fiber type specifications.

### MULTIMODE

TeraGain® Laser Optimized 50/125			
62.5/125	10G/150	10G/300	10G/550
6G	MG	NG	PG

## WATER BLOCK AND JACKET PRINT CODES

	Dry core		Dry core special	
	Feet	Meters	Feet	Meters
<sup>1</sup> Replace "y" with:	1	2	5	6

# Dri-Lite® Loose Tube Single Jacket Self Support

Series 11DM

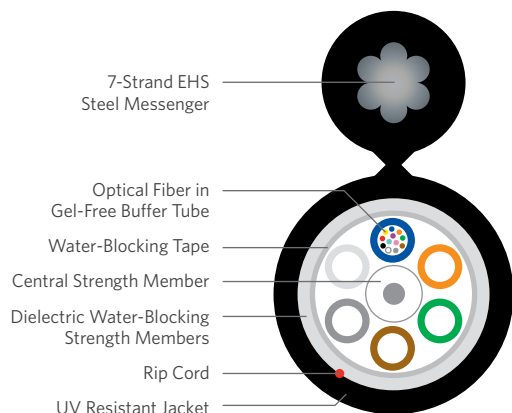

## PRODUCT DESCRIPTION

Loose tube cables are the product of choice as the backbone in Outside Plant (OSP) applications. Loose tube self support cables are designed for use in aerial applications as an alternative to lashing. These cables reduce installation time and costs. Superior Essex offers self support cables for spans up to 700 feet. The loose tube design offers reliable transmission performance over a broad temperature range. The durable loose tube design features optical fibers placed inside gel-free buffer tubes. The core is constructed by stranding the buffer tubes around a central member using a reverse oscillating lay (ROL). The core is wrapped with flexible strength members, a water-blocking tape and then encased with a black jacket and an integrated EHS steel messenger. A rip cord is included under the jacket for ease of entry.

## APPLICATIONS

- Aerial self support
- Trunk, distribution and feeder cable
- Local loop, metro, long-haul and broadband network

## FEATURES

- Available with up to 288-fiber
- Multiple fiber types including composites
- Dry (SAP) core standard
- Standard tube size for all fiber counts
- Conforms to standard pole attachment hardware
- Gel-free construction

## BENEFITS

- High fiber density
- Multiple network applications
- Reduces cable prep and installation time
- Reduces the number of tools required
- Standard installation practices
- Speeds fiber access and clean-up

## SPECIFICATIONS

<b>Fiber Count</b>	Available in 6-fiber up to 288-fiber
<b>Standards Compliance</b>	Telcordia® GR-20-CORE RDUP PE-90 Designation MLT-8 ICEA S-87-640-2011 RoHS-compliant

Telcordia is a registered trademark of Ericsson Inc.

## PART NUMBER KEY

1	1	_	_	_	x	D	M	y
1	2	3	4	5	6	7	8	9
Product family	Fiber count (006-288)		Fiber type	Internal designator	Water block/ marking (1-8)			

Contact Customer Service for availability of non-standard offerings.

## ENVIRONMENTAL SPECIFICATIONS

<b>Operation/Storage</b>	-40°C to +70°C
<b>Installation</b>	-30°C to +70°C

## PART NUMBERS AND PHYSICAL CHARACTERISTICS

Part Number <sup>1</sup>	Fiber Count	Dimensions		Nominal Weight lbs/kft (kg/km)	Fiber Cable Component Maximum Tensile Loading		Support Messenger Breaking Strength lbs	Minimum Bend Radius	
		Minor in (mm)	Major in (mm)		Install lbs (N)	Long Term lbs (N)		Install in (mm)	Long Term in (mm)
11012xDMy	12	0.41 (10.4)	0.89 (22.6)	208 (310)	600 (2,700)	200 (890)	6,650	8.2 (208)	4.1 (104)
11024xDMy	24	0.41 (10.4)	0.89 (22.6)	208 (310)	600 (2,700)	200 (890)	6,650	8.2 (208)	4.1 (104)
11048xDMy	48	0.41 (10.4)	0.89 (22.6)	208 (310)	600 (2,700)	200 (890)	6,650	8.2 (208)	4.1 (104)
11072xDMy	72	0.43 (10.9)	0.93 (23.6)	224 (334)	600 (2,700)	200 (890)	6,650	8.6 (218)	4.3 (109)
11096xDMy	96	0.50 (12.7)	1.01 (25.7)	245 (365)	600 (2,700)	200 (890)	6,650	10.0 (254)	5.0 (127)
11144xDMy	144	0.63 (16.0)	1.13 (28.7)	290 (432)	600 (2,700)	200 (890)	6,650	12.6 (320)	6.3 (160)
11216xDMy	216	0.63 (16.0)	1.13 (28.7)	290 (432)	600 (2,700)	200 (890)	6,650	12.6 (320)	6.3 (160)
11288xDMy	288	0.74 (18.8)	1.24 (31.5)	327 (488)	600 (2,700)	200 (890)	6,650	14.8 (376)	7.4 (188)

## FIBER TYPES:

### SINGLE MODE

Reduced Water Peak	Zero Water Peak	TeraFlex® Bend Resistant			NZDS	LEAF
		G.657.A1	G.657.A2	G.657.B3		
<sup>1</sup> Replace "x" with:	3	2	K	J	L	8 S

See "Optical Fiber Specifications" in the "Technical Info" section for detailed fiber type specifications.

### MULTIMODE

TeraGain®	TeraFlex Bend Resistant Laser Optimized 50/125		
62.5/125	10G/150	10G/300	10G/550
6	M	N	P

## WATER BLOCK AND JACKET PRINT CODES

Dry core		Dry core special	
Feet	Meters	Feet	Meters
<sup>1</sup> Replace "y" with:	1	2	5 6



# Dri-Lite® Loose Tube Double Jacket Self Support

Series 1GDM

## PRODUCT DESCRIPTION

Loose tube cables are the product of choice as the backbone in Outside Plant (OSP) applications. Loose tube self support cables are designed for use in aerial applications as an alternative to lashing. These cables reduce installation time and costs. Superior Essex offers self support cables for spans up to 700 feet. The loose tube design offers reliable transmission performance over a broad temperature range. Optical fibers are placed inside gel-free buffer tubes. The core is constructed by stranding the buffer tubes around a central member using a reverse oscillating lay (ROL) and wrapped with flexible strength members, a water-blocking tape and then encased with a black inner jacket. Flexible strength members are applied and a black outer jacket with integrated EHS steel messenger completes the cable construction. Rip cords are included under each jacket for ease of entry.

## APPLICATIONS

- Aerial self support
- Trunk, distribution and feeder cable
- Local loop, metro, long-haul and broadband network

## FEATURES

- Available with up to 120-fiber
- Multiple fiber types including composites
- Dry (SAP) core standard
- Conforms to standard pole attachment hardware
- Gel-free construction

## BENEFITS

- High fiber density
- Multiple network applications
- Reduces cable prep and installation time
- Standard installation practices
- Speeds fiber access and clean-up

## ENVIRONMENTAL SPECIFICATIONS

Operation/Storage	-40°C to +70°C
Installation	-30°C to +70°C

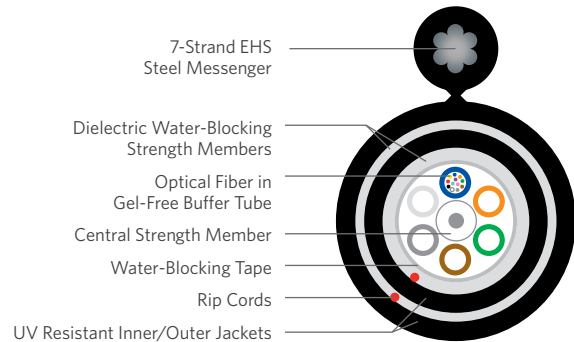
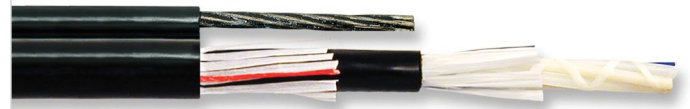

## SPECIFICATIONS

Fiber Count	Available in 6-fiber up to 120-fiber
Standards Compliance	Telcordia® GR-20-CORE RDUP PE-90 Designation MLT-8 ICEA S-87-640-2011 RoHS-compliant

Telcordia is a registered trademark of Ericsson Inc.

## PART NUMBER KEY

1	G	_	_	_	x	D	M	y
1	2	3	4	5	6	7	8	9
Product family	Fiber count (006-120)			Fiber type	Internal designator	Water block/markings (1-8)		

Contact Customer Service for availability of non-standard offerings.

## PART NUMBERS AND PHYSICAL CHARACTERISTICS

Part Number <sup>1</sup>	Fiber Count	Dimensions		Nominal Weight lbs/kft (kg/km)	Fiber Cable Component Maximum Tensile Loading		Support Messenger Breaking Strength lbs	Minimum Bend Radius	
		Minor in (mm)	Major in (mm)		Install lbs (N)	Long Term lbs (N)		Install in (mm)	Long Term in (mm)
1G006xDMy	6	0.50 (12.8)	0.99 (25.0)	242 (360)	600 (2,700)	200 (890)	6,650	10.0 (256)	5.0 (128)
1G012xDMy	12	0.50 (12.8)	0.99 (25.0)	242 (360)	600 (2,700)	200 (890)	6,650	10.0 (256)	5.0 (128)
1G024xDMy	24	0.50 (12.8)	0.99 (25.0)	242 (360)	600 (2,700)	200 (890)	6,650	10.0 (256)	5.0 (128)
1G036xDMy	36	0.50 (12.8)	0.99 (25.0)	242 (360)	600 (2,700)	200 (890)	6,650	10.0 (256)	5.0 (128)
1G048xDMy	48	0.50 (12.8)	0.99 (25.0)	242 (360)	600 (2,700)	200 (890)	6,650	10.0 (256)	5.0 (128)
1G072xDMy	72	0.53 (13.4)	1.03 (26.0)	257 (382)	600 (2,700)	200 (890)	6,650	10.6 (268)	5.3 (134)
1G096xDMy	96	0.59 (15.1)	1.10 (28.0)	279 (415)	600 (2,700)	200 (890)	6,650	11.8 (302)	5.9 (151)
1G120xDMy	120	0.66 (16.8)	1.26 (32.0)	343 (510)	600 (2,700)	200 (890)	6,650	13.2 (336)	6.6 (168)

## FIBER TYPES:

### SINGLE MODE

Reduced Water Peak	Zero Water Peak	TeraFlex® Bend Resistant			
		G.657.A1	G.657.A2	G.657.B3	NZDS LEAF
<sup>1</sup> Replace "x" with:	3	2	K	J	8 S

### MULTIMODE

TeraGain®	TeraFlex Bend Resistant	Laser Optimized 50/125	
62.5/125	10G/150	10G/300	10G/550
6	M	N	P

See "Optical Fiber Specifications" in the "Technical Info" section for detailed fiber type specifications.

## WATER BLOCK AND JACKET PRINT CODES

	Dry core		Dry core special	
	Feet	Meters	Feet	Meters
<sup>1</sup> Replace "y" with:	1	2	5	6

# Dri-Lite® Loose Tube Single Jacket Single Armor Self Support

Series 12DM

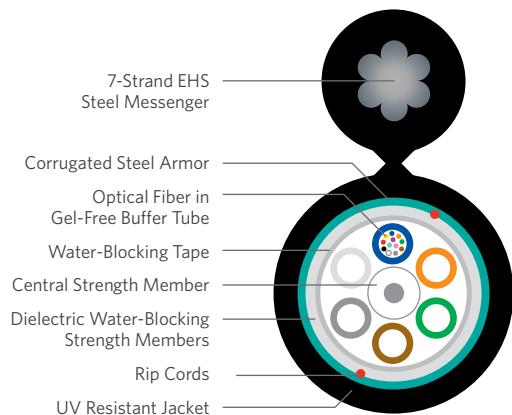
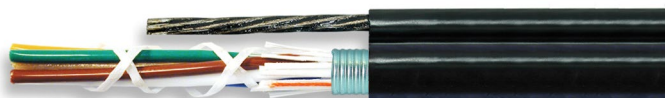

## PRODUCT DESCRIPTION

Loose tube cables are the product of choice as the backbone in Outside Plant (OSP) applications. Loose tube self support cables are designed for use in aerial applications as an alternative to lashing. These cables reduce installation time and costs. Superior Essex offers self support cables for spans up to 700 feet. The loose tube design offers reliable transmission performance over a broad temperature range. The durable loose tube design features optical fibers placed inside gel-free buffer tubes. The core is constructed by stranding the buffer tubes around a central member using a reverse oscillating lay (ROL) and wrapped with flexible strength members covered with a water-blocking tape. A corrugated steel armor is applied and then encased in a black jacket with an integrated EHS steel messenger. Rip cords are included under the armor for ease of entry.

## APPLICATIONS

- Aerial self support
- Trunk, distribution and feeder cable
- Local loop, metro, long-haul and broadband network

## FEATURES

- Available with up to 288-fiber
- Multiple fiber types including composites
- Dry (SAP) core standard
- Corrugated steel armor
- Utilizes standard pole attachment hardware
- Gel-free construction

## BENEFITS

- High fiber density
- Multiple network applications
- Reduces cable prep and installation time
- Improves compressive strength and rodent protection
- Standard installation practices
- Speeds fiber access and clean-up

## SPECIFICATIONS

**Fiber Count** Available in 6-fiber up to 288-fiber

**Standards Compliance** Telcordia® GR-20-CORE  
RDUP PE-90 Designation MLT-8  
ICEA S-87-640-2011  
RoHS-compliant

Telcordia is a registered trademark of Ericsson Inc.

## PART NUMBER KEY

1	2	-	-	-	x	D	M	y
1	2	3	4	5	6	7	8	9
Product family	Fiber count (006-288)			Fiber type	Internal designator	Water block/ marking (1-8)		

Contact Customer Service for availability of non-standard offerings.

## ENVIRONMENTAL SPECIFICATIONS

**Operation/Storage** -40°C to +70°C

**Installation** -30°C to +70°C

## PART NUMBERS AND PHYSICAL CHARACTERISTICS

Part Number <sup>1</sup>	Fiber Count	Dimensions		Nominal Weight lbs/kft (kg/km)	Fiber Cable Component Maximum Tensile Loading		Support Messenger Breaking Strength lbs	Minimum Bend Radius	
		Minor in (mm)	Major in (mm)		Install lbs (N)	Long Term lbs (N)		Install in (mm)	Long Term in (mm)
12012xDMy	12	0.46 (11.7)	0.94 (23.9)	249 (371)	600 (2,700)	200 (890)	6,650	9.2 (234)	4.6 (117)
12024xDMy	24	0.46 (11.7)	0.94 (23.9)	249 (371)	600 (2,700)	200 (890)	6,650	9.2 (234)	4.6 (117)
12048xDMy	48	0.46 (11.7)	0.94 (23.9)	249 (371)	600 (2,700)	200 (890)	6,650	9.2 (234)	4.6 (117)
12072xDMy	72	0.49 (12.4)	0.99 (25.1)	266 (397)	600 (2,700)	200 (890)	6,650	9.8 (249)	4.9 (124)
12096xDMy	96	0.56 (14.2)	1.09 (27.7)	306 (456)	600 (2,700)	200 (890)	6,650	11.2 (284)	5.6 (142)
12144xDMy	144	0.69 (17.5)	1.19 (30.2)	348 (519)	600 (2,700)	200 (890)	6,650	13.8 (351)	6.9 (175)
12216xDMy	216	0.69 (17.5)	1.19 (30.2)	348 (519)	600 (2,700)	200 (890)	6,650	13.8 (351)	6.9 (175)
12288xDMy	288	0.80 (20.3)	1.30 (33.0)	394 (588)	600 (2,700)	200 (890)	6,650	16.0 (406)	8.0 (203)

## FIBER TYPES:

### SINGLE MODE

Reduced Water Peak	Zero Water Peak	TeraFlex® Bend Resistant			NZDS	LEAF
		G.657.A1	G.657.A2	G.657.B3		
3	2	K	J	L	8	S

<sup>1</sup>Replace "x" with:

### MULTIMODE

TeraGain®	TeraFlex Bend Resistant Laser Optimized 50/125		
62.5/125	10G/150	10G/300	10G/550
6	M	N	P

See "Optical Fiber Specifications" in the "Technical Info" section for detailed fiber type specifications.

## WATER BLOCK AND JACKET PRINT CODES

Dry core		Dry core special	
Feet	Meters	Feet	Meters
1	2	5	6

<sup>1</sup>Replace "y" with:

# Dri-Lite® Loose Tube Double Jacket Single Armor Self Support

Series 1ADM

## PRODUCT DESCRIPTION

Loose tube cables are the product of choice as the backbone in Outside Plant (OSP) applications. Loose tube self support cables are designed for use in aerial applications as an alternative to lashing. These cables reduce installation time and costs. Superior Essex offers self support cables for spans up to 700 feet. The loose tube design offers reliable transmission performance over a broad temperature range. Optical fibers are placed inside gel-free buffer tubes. The core is constructed by stranding the buffer tubes around a central member using a reverse oscillating lay (ROL). The core is wrapped with flexible strength members covered with a water-blocking tape then encased with a black polyethylene inner jacket. Water-blocking yarns and a corrugated steel armor are applied and a black outer jacket with an integrated EHS steel messenger completes the cable construction. Rip cords are included under the armor and inner jacket for ease of entry.

## APPLICATIONS

- Aerial self support
- Trunk, distribution and feeder cable
- Local loop, metro, long-haul and broadband network

## FEATURES

- Available with up to 120-fiber
- Multiple fiber types including composites
- Dry (SAP) core standard
- Corrugated steel armor
- Utilizes standard pole attachment hardware
- Gel-free construction

## BENEFITS

- High fiber density
- Multiple network applications
- Reduces cable prep and installation time
- Improves compressive strength and rodent protection
- Standard installation practices
- Speeds fiber access and clean-up

## ENVIRONMENTAL SPECIFICATIONS

Operation/Storage	-40°C to +70°C
Installation	-30°C to +70°C

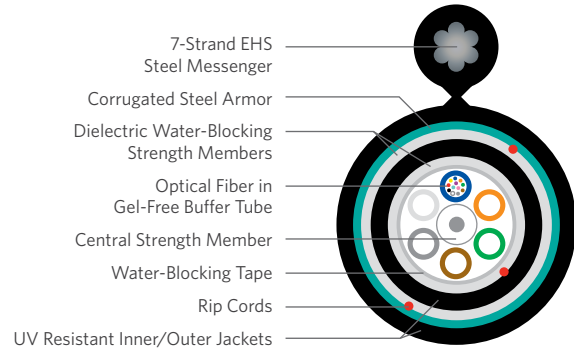
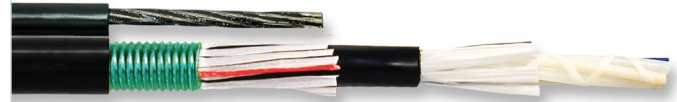

## SPECIFICATIONS

Fiber Count	Available in 6-fiber up to 120-fiber
Standards Compliance	Telcordia® GR-20-CORE RDUP PE-90 Designation MLT-8 ICEA S-87-640-2011 RoHS-compliant

Telcordia is a registered trademark of Ericsson Inc.

## PART NUMBER KEY

1	A	-	-	-	x	D	M	y
1	2	3	4	5	6	7	8	9
Product family	Fiber count (006-120)			Fiber type	Internal designator	Water block/ marking (1-8)		

Contact Customer Service for availability of non-standard offerings.

## PART NUMBERS AND PHYSICAL CHARACTERISTICS

Part Number <sup>1</sup>	Fiber Count	Dimensions		Nominal Weight lbs/kft (kg/km)	Fiber Cable Component Maximum Tensile Loading		Support Messenger Breaking Strength lbs	Minimum Bend Radius	
		Minor in (mm)	Major in (mm)		Install lbs (N)	Long Term lbs (N)		Install in (mm)	Long Term in (mm)
1A006xDMy	6	0.56 (14.1)	1.03 (26.0)	287 (427)	600 (2,700)	200 (890)	6,650	11.2 (282)	5.6 (141)
1A012xDMy	12	0.56 (14.1)	1.03 (26.0)	287 (427)	600 (2,700)	200 (890)	6,650	11.2 (282)	5.6 (141)
1A024xDMy	24	0.56 (14.1)	1.03 (26.0)	287 (427)	600 (2,700)	200 (890)	6,650	11.2 (282)	5.6 (141)
1A036xDMy	36	0.56 (14.1)	1.03 (26.0)	287 (427)	600 (2,700)	200 (890)	6,650	11.2 (282)	5.6 (141)
1A048xDMy	48	0.56 (14.1)	1.03 (26.0)	287 (427)	600 (2,700)	200 (890)	6,650	11.2 (282)	5.6 (141)
1A072xDMy	72	0.58 (14.9)	1.12 (28.0)	322 (479)	600 (2,700)	200 (890)	6,650	11.6 (298)	5.8 (149)
1A096xDMy	96	0.65 (16.6)	1.18 (30.0)	354 (527)	600 (2,700)	200 (890)	6,650	13.0 (332)	6.5 (166)
1A120xDMy	120	0.72 (18.3)	1.35 (34.0)	432 (643)	600 (2,700)	200 (890)	6,650	14.4 (376)	7.2 (183)

## FIBER TYPES:

### SINGLE MODE

Reduced Water Peak	Zero Water Peak	TeraFlex® Bend Resistant			NZDS	LEAF	
		G.657.A1	G.657.A2	G.657.B3			
<sup>1</sup> Replace "x" with:	3	2	K	J	L	8	S

See "Optical Fiber Specifications" in the "Technical Info" section for detailed fiber type specifications.

### MULTIMODE

TeraGain®	TeraFlex Bend Resistant Laser Optimized 50/125		
62.5/125	10G/150	10G/300	10G/550
6	M	N	P

## WATER BLOCK AND JACKET PRINT CODES

	Dry core		Dry core special	
	Feet	Meters	Feet	Meters
<sup>1</sup> Replace "y" with:	1	2	5	6

# Loose Tube Single Jacket Self Support

Series 11M

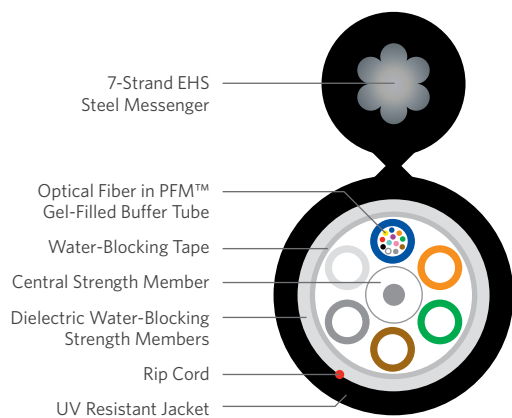

## PRODUCT DESCRIPTION

Loose tube cables are the product of choice as the backbone in Outside Plant (OSP) applications. Loose tube self support cables are designed for use in aerial applications as an alternative to lashing. These cables reduce installation time and costs. Superior Essex offers self support cables for spans up to 700 feet. The loose tube design offers reliable transmission performance over a broad temperature range. The durable loose tube design features optical fibers placed inside PFM™ gel-filled buffer tubes. The core is constructed by stranding the buffer tubes around a central member using a reverse oscillating lay (ROL). The core is wrapped with flexible strength members, a water-blocking tape and then encased with a black jacket and an integrated EHS steel messenger. A rip cord is included under the jacket for ease of entry.

## APPLICATIONS

- Aerial self support
- Trunk, distribution and feeder cable
- Local loop, metro, long-haul and broadband network

## FEATURES

- Available with up to 288-fiber
- Multiple fiber types including composites
- Dry (SAP) core standard
- Standard tube size for all fiber counts
- Conforms to standard pole attachment hardware
- PFM gel

## BENEFITS

- High fiber density
- Multiple network applications
- Reduces cable prep and installation time
- Reduces the number of tools required
- Standard installation practices
- Non-sticky gel speeds fiber access and clean-up

## SPECIFICATIONS

**Fiber Count** Available in 6-fiber up to 288-fiber

**Standards Compliance** Telcordia® GR-20-CORE  
RDUP PE-90 Designation MLT-8  
ICEA S-87-640-2011  
RoHS-compliant

## PART NUMBER KEY

1	1	—	—	—	x	x	M	y
1	2	3	4	5	6	7	8	9
Product family	Fiber count (006-288)			Fiber type	Internal designator		Water block/marking (1-8)	

Contact Customer Service for availability of non-standard offerings.

## ENVIRONMENTAL SPECIFICATIONS

<b>Operation/Storage</b>	-40°C to +70°C
<b>Installation</b>	-30°C to +70°C

## PART NUMBERS AND PHYSICAL CHARACTERISTICS

Part Number <sup>1</sup>	Fiber Count	Dimensions		Nominal Weight lbs/kft (kg/km)	Fiber Cable Component Maximum Tensile Loading		Support Messenger Breaking Strength lbs	Minimum Bend Radius	
		Minor in (mm)	Major in (mm)		Install lbs (N)	Long Term lbs (N)		Install in (mm)	Long Term in (mm)
11012xxMy	12	0.41 (10.4)	0.89 (22.6)	208 (310)	600 (2,700)	200 (890)	6,650	8.2 (208)	4.1 (104)
11024xxMy	24	0.41 (10.4)	0.89 (22.6)	208 (310)	600 (2,700)	200 (890)	6,650	8.2 (208)	4.1 (104)
11048xxMy	48	0.41 (10.4)	0.89 (22.6)	208 (310)	600 (2,700)	200 (890)	6,650	8.2 (208)	4.1 (104)
11072xxMy	72	0.43 (10.9)	0.93 (23.6)	224 (334)	600 (2,700)	200 (890)	6,650	8.6 (218)	4.3 (109)
11096xxMy	96	0.50 (12.7)	1.01 (25.7)	245 (365)	600 (2,700)	200 (890)	6,650	10.0 (254)	5.0 (127)
11144xxMy	144	0.63 (16.0)	1.13 (28.7)	290 (432)	600 (2,700)	200 (890)	6,650	12.6 (320)	6.3 (160)
11216xxMy	216	0.63 (16.0)	1.13 (28.7)	290 (432)	600 (2,700)	200 (890)	6,650	12.6 (320)	6.3 (160)
11288xxMy	288	0.74 (18.8)	1.24 (31.5)	327 (488)	600 (2,700)	200 (890)	6,650	14.8 (376)	7.4 (188)

## FIBER TYPES:

### SINGLE MODE

Reduced Water Peak	Zero Water Peak	TeraFlex® Bend Resistant			NZDS	LEAF
		G.657.A1	G.657.A2	G.657.B3		
3T	2T	KT	JT	LT	8T	ST
31	21	K1	J1	L1	81	S1

<sup>1</sup>For ≤ 36 fibers replace "xx" with:

<sup>1</sup>For > 36 fibers replace "xx" with:

### MULTIMODE

TeraGain® 62.5/125	TeraFlex Bend Resistant Laser Optimized 50/125		
	10G/150	10G/300	10G/550
6G	MG	NG	PG

## WATER BLOCK AND JACKET PRINT CODES

Dry core		Dry core special	
Feet	Meters	Feet	Meters
1	2	5	6

<sup>1</sup>Replace "y" with:

# Loose Tube Double Jacket Self Support

Series 1GM

## PRODUCT DESCRIPTION

Loose tube cables are the product of choice as the backbone in Outside Plant (OSP) applications. Loose tube self support cables are designed for use in aerial applications as an alternative to lashing. These cables reduce installation time and costs. Superior Essex offers self support cables for spans up to 700 feet. The loose tube design offers reliable transmission performance over a broad temperature range. Optical fibers are placed inside filled buffer tubes containing PFM™ gel. The core is constructed by stranding the buffer tubes around a central member using a reverse oscillating lay (ROL) and wrapped with flexible strength members, a water-blocking tape and then encased with a black inner jacket. Flexible strength members are applied and a black outer jacket with integrated EHS steel messenger completes the cable construction. Rip cords are included under each jacket for ease of entry.

## APPLICATIONS

- Aerial self support
- Trunk, distribution and feeder cable
- Local loop, metro, long-haul and broadband network

## FEATURES

- Available with up to 120-fiber
- Multiple fiber types including composites
- Dry (SAP) core standard
- Conforms to standard pole attachment hardware
- PFM gel

## BENEFITS

- High fiber density
- Multiple network applications
- Reduces cable prep and installation time
- Standard installation practices
- Non-sticky gel speeds fiber access and clean-up

## ENVIRONMENTAL SPECIFICATIONS

Operation/Storage	-40°C to +70°C
Installation	-30°C to +70°C

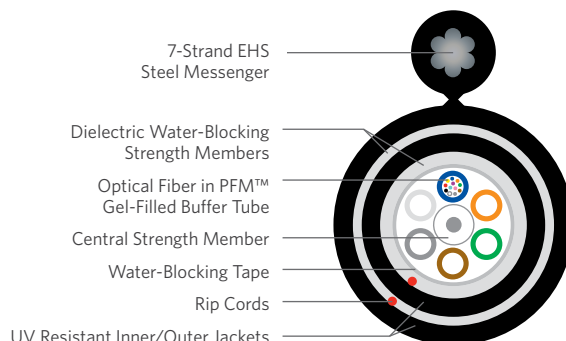

## SPECIFICATIONS

Fiber Count	Available in 6-fiber up to 120-fiber
Standards Compliance	Telcordia® GR-20-CORE RDUP PE-90 Designation MLT-8 ICEA S-87-640-2011 RoHS-compliant

Telcordia is a registered trademark of Ericsson Inc.

## PART NUMBER KEY

1	G	_	_	_	x	x	M	y
1	2	3	4	5	6	7	8	9
Product family	Fiber count (006-120)				Fiber type	Internal designator	Water block/markings (1-8)	

Contact Customer Service for availability of non-standard offerings.

## PART NUMBERS AND PHYSICAL CHARACTERISTICS

Part Number <sup>1</sup>	Fiber Count	Dimensions		Nominal Weight lbs/kft (kg/km)	Fiber Cable Component Maximum Tensile Loading		Support Messenger Breaking Strength lbs	Minimum Bend Radius	
		Minor in (mm)	Major in (mm)		Install lbs (N)	Long Term lbs (N)		Install in (mm)	Long Term in (mm)
1G006xxMy	6	0.50 (12.8)	0.99 (25.0)	242 (360)	600 (2,700)	200 (890)	6,650	10.0 (256)	5.0 (128)
1G012xxMy	12	0.50 (12.8)	0.99 (25.0)	242 (360)	600 (2,700)	200 (890)	6,650	10.0 (256)	5.0 (128)
1G024xxMy	24	0.50 (12.8)	0.99 (25.0)	242 (360)	600 (2,700)	200 (890)	6,650	10.0 (256)	5.0 (128)
1G036xxMy	36	0.50 (12.8)	0.99 (25.0)	242 (360)	600 (2,700)	200 (890)	6,650	10.0 (256)	5.0 (128)
1G048xxMy	48	0.50 (12.8)	0.99 (25.0)	242 (360)	600 (2,700)	200 (890)	6,650	10.0 (256)	5.0 (128)
1G072xxMy	72	0.53 (13.4)	1.03 (26.0)	257 (382)	600 (2,700)	200 (890)	6,650	10.6 (268)	5.3 (134)
1G096xxMy	96	0.59 (15.1)	1.10 (28.0)	279 (415)	600 (2,700)	200 (890)	6,650	11.8 (302)	5.9 (151)
1G120xxMy	120	0.66 (16.8)	1.26 (32.0)	343 (510)	600 (2,700)	200 (890)	6,650	13.2 (336)	6.6 (168)

## FIBER TYPES:

## SINGLE MODE

	Reduced Water Peak	Zero Water Peak	TeraFlex® Bend Resistant				
			G.657.A1	G.657.A2	G.657.B3	NZDS	LEAF
<sup>1</sup> For ≤ 36 fibers replace "xx" with:	3T	2T	KT	JT	LT	8T	ST
<sup>1</sup> For > 36 fibers replace "xx" with:	31	21	K1	J1	L1	81	S1

See "Optical Fiber Specifications" in the "Technical Info" section for detailed fiber type specifications.

## MULTIMODE

TeraGain®	TeraFlex Bend Resistant Laser Optimized 50/125			
	62.5/125	10G/150	10G/300	10G/550
6G	MG	NG	PG	

## WATER BLOCK AND JACKET PRINT CODES

	Dry core		Dry core special	
	Feet	Meters	Feet	Meters
<sup>1</sup> Replace "y" with:	1	2	5	6

# Loose Tube Single Jacket Single Armor Self Support

Series 12M

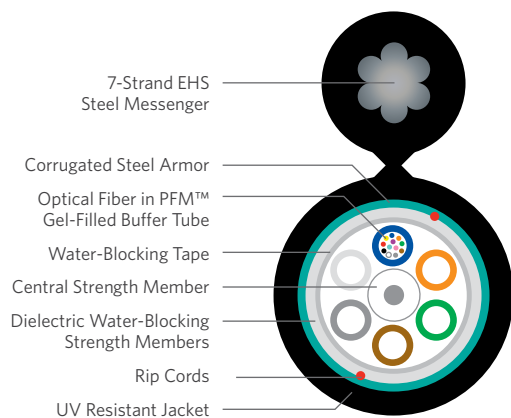
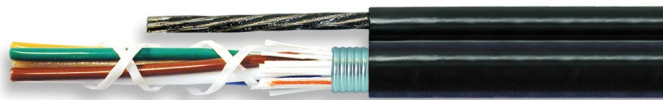

## PRODUCT DESCRIPTION

Loose tube cables are the product of choice as the backbone in Outside Plant (OSP) applications. Loose tube self support cables are designed for use in aerial applications as an alternative to lashing. These cables reduce installation time and costs. Superior Essex offers self support cables for spans up to 700 feet. The loose tube design offers reliable transmission performance over a broad temperature range. The durable loose tube design features optical fibers placed inside PFM™ gel-filled buffer tubes. The core is constructed by stranding the buffer tubes around a central member using a reverse oscillating lay (ROL) and wrapped with flexible strength members covered with a water-blocking tape. A corrugated steel armor is applied and then encased in a black jacket with an integrated EHS steel messenger. Rip cords are included under the armor for ease of entry.

## APPLICATIONS

- Aerial self support
- Trunk, distribution and feeder cable
- Local loop, metro, long-haul and broadband network

## FEATURES

- Available with up to 288-fiber
- Multiple fiber types including composites
- Dry (SAP) core standard
- Corrugated steel armor
- Utilizes standard pole attachment hardware
- PFM gel

## BENEFITS

- High fiber density
- Multiple network applications
- Reduces cable prep and installation time
- Improves compressive strength and rodent protection
- Standard installation practices
- Non-sticky gel speeds fiber access and clean-up

## SPECIFICATIONS

**Fiber Count** Available in 6-fiber up to 288-fiber

**Standards Compliance** Telcordia® GR-20-CORE  
RDUP PE-90 Designation MLT-8  
ICEA S-87-640-2011  
RoHS-compliant

Telcordia is a registered trademark of Ericsson Inc.

## PART NUMBER KEY

1	2	3	4	5	6	7	8	9
Product family	Fiber count (006-288)	Fiber type	Internal designator	Water block/ marking (1-8)				

Contact Customer Service for availability of non-standard offerings.

## ENVIRONMENTAL SPECIFICATIONS

<b>Operation/Storage</b>	-40°C to +70°C
<b>Installation</b>	-30°C to +70°C

## PART NUMBERS AND PHYSICAL CHARACTERISTICS

Part Number <sup>1</sup>	Fiber Count	Dimensions		Nominal Weight lbs/kft (kg/km)	Fiber Cable Component Maximum Tensile Loading		Support Messenger Breaking Strength lbs	Minimum Bend Radius	
		Minor in (mm)	Major in (mm)		Install lbs (N)	Long Term lbs (N)		Install in (mm)	Long Term in (mm)
12012xxMy	12	0.46 (11.7)	0.94 (23.9)	249 (371)	600 (2,700)	200 (890)	6,650	9.2 (234)	4.6 (117)
12024xxMy	24	0.46 (11.7)	0.94 (23.9)	249 (371)	600 (2,700)	200 (890)	6,650	9.2 (234)	4.6 (117)
12048xxMy	48	0.46 (11.7)	0.94 (23.9)	249 (371)	600 (2,700)	200 (890)	6,650	9.2 (234)	4.6 (117)
12072xxMy	72	0.49 (12.4)	0.99 (25.1)	266 (397)	600 (2,700)	200 (890)	6,650	9.8 (249)	4.9 (124)
12096xxMy	96	0.56 (14.2)	1.09 (27.7)	306 (456)	600 (2,700)	200 (890)	6,650	11.2 (284)	5.6 (142)
12144xxMy	144	0.69 (17.5)	1.19 (30.2)	348 (519)	600 (2,700)	200 (890)	6,650	13.8 (351)	6.9 (175)
12216xxMy	216	0.69 (17.5)	1.19 (30.2)	348 (519)	600 (2,700)	200 (890)	6,650	13.8 (351)	6.9 (175)
12288xxMy	288	0.80 (20.3)	1.30 (33.0)	394 (588)	600 (2,700)	200 (890)	6,650	16.0 (406)	8.0 (203)

## FIBER TYPES:

### SINGLE MODE

Reduced Water Peak    Zero Water Peak    TeraFlex® Bend Resistant

<sup>1</sup> For ≤ 36 fibers replace "xx" with:	3T	2T	KT	JT	LT	8T	ST
<sup>1</sup> For > 36 fibers replace "xx" with:	31	21	K1	J1	L1	81	S1

### MULTIMODE

TeraGain® 62.5/125	TeraFlex Bend Resistant Laser Optimized 50/125		
	10G/150	10G/300	10G/550
6G	MG	NG	PG

See "Optical Fiber Specifications" in the "Technical Info" section for detailed fiber type specifications.

## WATER BLOCK AND JACKET PRINT CODES

Dry core		Dry core special	
Feet	Meters	Feet	Meters
<sup>1</sup> Replace "y" with:	1	2	5
	2	5	6

# Loose Tube Double Jacket Single Armor Self Support

Series 1AM

## PRODUCT DESCRIPTION

Loose tube cables are the product of choice as the backbone in Outside Plant (OSP) applications. Loose tube self support cables are designed for use in aerial applications as an alternative to lashing. These cables reduce installation time and costs. Superior Essex offers self support cables for spans up to 700 feet. The loose tube design offers reliable transmission performance over a broad temperature range. Optical fibers are placed inside filled buffer tubes containing PFM™ gel. The core is constructed by stranding the buffer tubes around a central member using a reverse oscillating lay (ROL). The core is wrapped with flexible strength members covered with a water-blocking tape then encased with a black polyethylene inner jacket. Water-blocking yarns and a corrugated steel armor are applied and a black outer jacket with an integrated EHS steel messenger completes the cable construction. Rip cords are included under the armor and inner jacket for ease of entry.

## APPLICATIONS

- Aerial self support
- Trunk, distribution and feeder cable
- Local loop, metro, long-haul and broadband network

## FEATURES

- Available with up to 120-fiber
- Multiple fiber types including composites
- Dry (SAP) core standard
- Corrugated steel armor
- Utilizes standard pole attachment hardware
- PFM gel

## BENEFITS

- High fiber density
- Multiple network applications
- Reduces cable prep and installation time
- Improves compressive strength and rodent protection
- Standard installation practices
- Non-sticky gel speeds fiber access and clean-up

## ENVIRONMENTAL SPECIFICATIONS

Operation/Storage	-40°C to +70°C
Installation	-30°C to +70°C

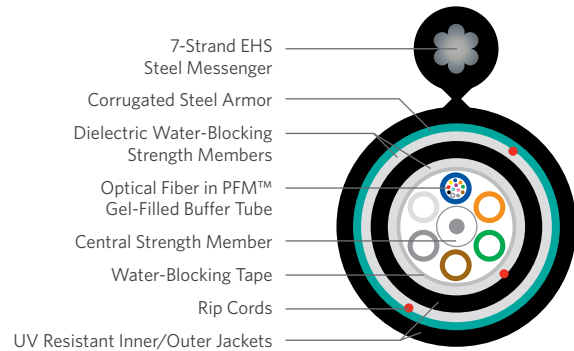

## SPECIFICATIONS

Fiber Count	Available in 6-fiber up to 120-fiber
Standards Compliance	Telcordia® GR-20-CORE RDUP PE-90 Designation MLT-8 ICEA S-87-640-2011 RoHS-compliant

Telcordia is a registered trademark of Ericsson Inc.

## PART NUMBER KEY

1	A	-	-	-	x	x	M	y
1	2	3	4	5	6	7	8	9
Product family	Fiber count (006-120)			Fiber type	Internal designator	Water block/ marking (1-8)		

Contact Customer Service for availability of non-standard offerings.

## PART NUMBERS AND PHYSICAL CHARACTERISTICS

Part Number <sup>1</sup>	Fiber Count	Dimensions		Nominal Weight lbs/kft (kg/km)	Fiber Cable Component Maximum Tensile Loading		Support Messenger Breaking Strength lbs	Minimum Bend Radius	
		Minor in (mm)	Major in (mm)		Install lbs (N)	Long Term lbs (N)		Install in (mm)	Long Term in (mm)
1A006xxMy	6	0.56 (14.1)	1.03 (26.0)	287 (427)	600 (2,700)	200 (890)	6,650	11.2 (282)	5.6 (141)
1A012xxMy	12	0.56 (14.1)	1.03 (26.0)	287 (427)	600 (2,700)	200 (890)	6,650	11.2 (282)	5.6 (141)
1A024xxMy	24	0.56 (14.1)	1.03 (26.0)	287 (427)	600 (2,700)	200 (890)	6,650	11.2 (282)	5.6 (141)
1A036xxMy	36	0.56 (14.1)	1.03 (26.0)	287 (427)	600 (2,700)	200 (890)	6,650	11.2 (282)	5.6 (141)
1A048xxMy	48	0.56 (14.1)	1.03 (26.0)	287 (427)	600 (2,700)	200 (890)	6,650	11.2 (282)	5.6 (141)
1A072xxMy	72	0.58 (14.9)	1.12 (28.0)	322 (479)	600 (2,700)	200 (890)	6,650	11.6 (298)	5.8 (149)
1A096xxMy	96	0.65 (16.6)	1.18 (30.0)	354 (527)	600 (2,700)	200 (890)	6,650	13.0 (332)	6.5 (166)
1A120xxMy	120	0.72 (18.3)	1.35 (34.0)	432 (643)	600 (2,700)	200 (890)	6,650	14.4 (376)	7.2 (183)

## FIBER TYPES:

### SINGLE MODE

Reduced Water Peak	Zero Water Peak	TeraFlex® Bend Resistant					NZDS	LEAF
		G.657.A1	G.657.A2	G.657.B3				
3T	2T	KT	JT	LT	8T	ST		
31	21	K1	J1	L1	81	S1		

<sup>1</sup>For ≤ 36 fibers replace "xx" with:

<sup>1</sup>For > 36 fibers replace "xx" with:

See "Optical Fiber Specifications" in the "Technical Info" section for detailed fiber type specifications.

### MULTIMODE

TeraGain® 62.5/125	TeraFlex Bend Resistant Laser Optimized 50/125			
	10G/150	10G/300	10G/550	
6G	MG	NG	PG	

## WATER BLOCK AND JACKET PRINT CODES

Dry core		Dry core special	
Feet	Meters	Feet	Meters
<sup>1</sup> Replace "y" with:	1	2	5
	2	5	6

# Dri-Lite® Loose Tube Single Jacket Long-Span Self Support

Series 11MLS

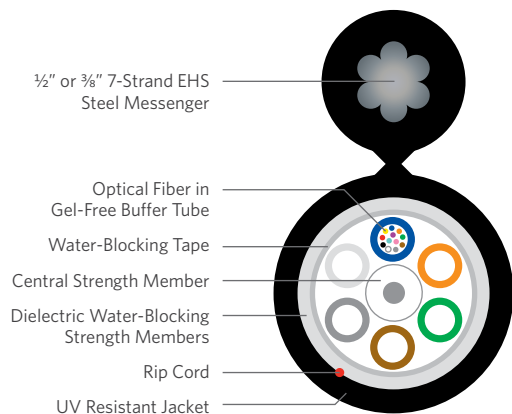
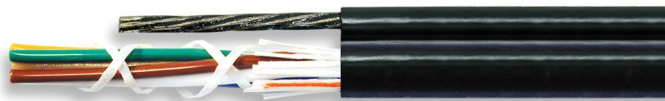

1/2" or 3/8" 7-Strand EHS Steel Messenger

Optical Fiber in Gel-Free Buffer Tube

Water-Blocking Tape

Central Strength Member

Dielectric Water-Blocking Strength Members

Rip Cord

UV Resistant Jacket

## SPECIFICATIONS

**Fiber Count** Available in 6-fiber up to 288-fiber

**Standards Compliance** Telcordia® GR-20-CORE  
RDUP PE-90 Designation MLT-8  
ICEA S-87-640-2011  
RoHS-compliant

Telcordia is a registered trademark of Ericsson Inc.

## PART NUMBER KEY

1	1	—	—	—	K or J	D	L or K	y
1	2	3	4	5	6	7	8	9
Product family	Fiber count (006-288)	Fiber type	Internal designator	Water block/marking (1-8)				

Contact Customer Service for availability of non-standard offerings.

## PART NUMBERS AND PHYSICAL CHARACTERISTICS

Part Number <sup>1</sup>	Fiber Count	Support Messenger Size in (mm)	Cable Dimensions		Nominal Weight lbs/kft (kg/km)	Fiber Cable Component Maximum Tensile Loading		Support Messenger Breaking Strength lbs	Minimum Bend Radius	
			Minor in (mm)	Major in (mm)		Install lbs (N)	Long Term lbs (N)		Install in (mm)	Long Term in (mm)
11012KDly	12	0.500 (12.7)	0.62 (15.7)	1.11 (28.3)	630 (940)	600 (2,700)	200 (890)	39,030	12.4 (314)	6.2 (157)
11060KDly	60	0.500 (12.7)	0.62 (15.7)	1.11 (28.3)	630 (940)	600 (2,700)	200 (890)	39,030	12.4 (314)	6.2 (157)
11072KDly	72	0.500 (12.7)	0.62 (15.7)	1.14 (29.0)	644 (961)	600 (2,700)	200 (890)	39,030	12.4 (314)	6.2 (157)
11096KDly	96	0.500 (12.7)	0.62 (15.7)	1.21 (30.7)	653 (974)	600 (2,700)	200 (890)	39,030	12.4 (314)	6.2 (157)
11144KDly	144	0.500 (12.7)	0.63 (16.0)	1.34 (34.0)	698 (1,041)	600 (2,700)	200 (890)	39,030	12.6 (320)	6.3 (160)
11216KDly	216	0.500 (12.7)	0.63 (16.0)	1.34 (34.0)	698 (1,041)	600 (2,700)	200 (890)	39,030	12.6 (320)	6.3 (160)
11288KDly	288	0.500 (12.7)	0.74 (18.9)	1.45 (36.9)	735 (1,097)	600 (2,700)	200 (890)	39,030	14.9 (378)	7.4 (189)
11012KDKy	12	0.375 (9.5)	0.48 (12.1)	0.95 (24.1)	353 (526)	600 (2,700)	200 (890)	15,400	9.5 (242)	4.8 (121)
11060KDKy	60	0.375 (9.5)	0.48 (12.1)	0.95 (24.1)	353 (526)	600 (2,700)	200 (890)	15,400	9.5 (242)	4.8 (121)
11072KDKy	72	0.375 (9.5)	0.48 (12.1)	1.00 (25.4)	367 (547)	600 (2,700)	200 (890)	15,400	9.5 (242)	4.8 (121)
11096KDKy	96	0.375 (9.5)	0.50 (12.7)	1.07 (27.1)	385 (574)	600 (2,700)	200 (890)	15,400	10.0 (254)	5.0 (127)
11144KDKy	144	0.375 (9.5)	0.63 (16.0)	1.21 (30.8)	430 (641)	600 (2,700)	200 (890)	15,400	12.6 (320)	6.3 (160)
11216KDKy	216	0.375 (9.5)	0.63 (16.0)	1.21 (30.8)	430 (641)	600 (2,700)	200 (890)	15,400	12.6 (320)	6.3 (160)
11288KDKy	288	0.375 (9.5)	0.74 (18.9)	1.31 (33.3)	460 (687)	600 (2,700)	200 (890)	15,400	14.9 (378)	7.4 (189)

## FIBER TYPES:

### SINGLE MODE

TeraFlex® Bend Resistant

G.657.A1 G.657.A2

<sup>1</sup>Replace "x" with:

K J

See "Optical Fiber Specifications" in the "Technical Info" section for detailed fiber type specifications.

## WATER BLOCK AND JACKET PRINT CODES

Dry core Dry core special

Feet Meters Feet Meters

<sup>1</sup>Replace "y" with:

1 2 5 6

## PRODUCT DESCRIPTION

Superior Essex now offers long-span Figure 8 optical fiber cables using a 1/2" or 3/8" messenger which can span lengths greater than 1,000 feet. Loose tube cables are the product of choice as the backbone in Outside Plant (OSP) applications. Loose tube self support cables are designed for use in aerial applications as an alternative to lashing. These cables reduce installation time and costs. The durable loose tube design features optical fibers placed inside gel-free buffer tubes. The core is constructed by stranding the buffer tubes around a central member using a reverse oscillating lay (ROL). The core is wrapped with flexible strength members, a water-blocking tape and then encased with a black jacket and an integrated EHS steel messenger. A rip cord is included under the jacket for ease of entry.

## APPLICATIONS

- Aerial self support
- Trunk, distribution and feeder cable
- Local loop, metro, long-haul and broadband network

## FEATURES

- Available with up to 288-fiber
- Dry (SAP) core standard
- Standard tube size for all fiber counts
- Conforms to standard pole attachment hardware
- Gel-free cable

## BENEFITS

- High fiber density
- Reduces cable prep and installation time
- Reduces the number of tools required
- Standard installation practices
- Speeds fiber access and clean-up

## ENVIRONMENTAL SPECIFICATIONS

**Operation/Storage** -40°C to +70°C

**Installation** -30°C to +70°C



## PRODUCT DESCRIPTION

EnduraSpan™ ADSS is an All Dielectric Self Supporting (ADSS) cable suitable for aerial applications with span lengths from 25 meters (82 feet) to 400 meters (1312 feet). This black, PE-jacketed cable is UV-stabilized and water blocked for outdoor aerial applications. The loose tube design provides stable and highly reliable transmission parameters for a variety of voice, data, video and imaging applications. The high modulus aramid yarns provide high tensile strength and long-term reliability. See ADSS product matrix below.

## APPLICATIONS

- Low-voltage transmission and distribution system (space potential ≤12 kV)
- Railways, power and telecommunications pole routes
- Suitable for all types of aerial lines

## FEATURES

- Available in any fiber count of 6 to 288 fibers
- Dry core standard all dielectric
- PFM™ Gel-filled tubes
- Lower cost than Figure 8
- Custom print available
- Custom lengths, fiber counts and fiber types available

## BENEFITS

- High fiber density
- Reduces cable prep time
- Reduced network cost
- Personalization

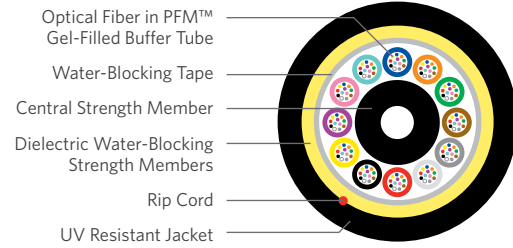

## SPECIFICATIONS

<b>Fiber Count</b>	Available in any fiber count 6 to 288 fibers
<b>Compressive Strength lbs/in (N/cm)</b>	Install: 125 (220) Long Term: 63 (110)
<b>Recommended Hardware</b>	FIBERLIGN® dead-end for ADSS Limited Tension
<b>Standards Design and Test</b>	ICEA S-87-640 IEEE 1222

FIBERLIGN is a registered trademark of Preformed Line Products (PLP).

## ENVIRONMENTAL SPECIFICATIONS

<b>Operation/Storage</b>	-40°C to +70°C
<b>Installation</b>	-30°C to +70°C

## ADSS PRODUCT MATRIX

Part Number	Fiber Count	Span ft (m)	Nominal Weight lbs/kft (kg/km)	Nominal Diameter in (mm)	MRCL lbs (N)	Initial Tension		
						Unloaded lbs (N)	Loaded sag %	Loaded lbs (N)
<b>LIGHT NESC Loading District</b>								
FE21-012U10-E991	12	82 (25)	47.37 (70.49)	0.41 (10.4)	225 (1,000)	32 (144)	0.7%	84 (375)
FE22-012U10-E991	12	164 (50)	47.37 (70.49)	0.41 (10.4)	225 (1,000)	65 (288)	0.7%	169 (750)
FE23-012U10-E991	12	246 (75)	47.63 (70.88)	0.41 (10.4)	261 (1,159)	98 (434)	0.7%	253 (1,126)
FE24-012U10-E991	12	328 (100)	48.15 (71.66)	0.41 (10.4)	333 (1,479)	132 (586)	0.7%	327 (1,454)
FE25-012U10-E991	12	410 (125)	48.94 (72.83)	0.41 (10.5)	440 (1,959)	167 (741)	0.7%	406 (1,805)
FE26-012U10-E991	12	492 (150)	49.47 (73.62)	0.41 (10.5)	512 (2,279)	203 (901)	0.7%	494 (2,198)
FE27-012U10-E991	12	574 (175)	49.99 (74.40)	0.42 (10.6)	584 (2,598)	238 (1,061)	0.8%	554 (2,462)
FE28-012U10-E991	12	656 (200)	50.52 (75.17)	0.42 (10.6)	656 (2,918)	276 (1,227)	0.8%	640 (2,849)
FE29-012U10-E991	12	738 (225)	51.30 (76.34)	0.42 (10.7)	764 (3,398)	314 (1,396)	0.8%	729 (3,245)
FE2A-012U10-E991	12	820 (250)	51.56 (76.73)	0.42 (10.7)	800 (3,558)	352 (1,565)	0.8%	782 (3,477)
FE2B-012U10-E991	12	902 (275)	51.86 (77.17)	0.42 (10.7)	902 (4,014)	388 (1,727)	0.8%	855 (3,803)
FE2C-012U10-E991	12	984 (300)	52.38 (77.95)	0.42 (10.7)	982 (4,367)	428 (1,904)	0.8%	940 (4,180)
FE2D-012U10-E991	12	1,066 (325)	52.91 (78.73)	0.42 (10.8)	1,061 (4,720)	468 (2,080)	0.8%	1,001 (4,455)
FE2E-012U10-E991	12	1,148 (350)	53.43 (79.51)	0.43 (10.8)	1,140 (5,073)	509 (2,264)	0.9%	1,086 (4,833)
FE2F-012U10-E991	12	1,230 (375)	53.95 (80.29)	0.43 (10.8)	1,220 (5,425)	551 (2,451)	0.9%	1,173 (5,216)
FE2G-012U10-E991	12	1,312 (400)	54.48 (81.07)	0.43 (10.9)	1,299 (5,778)	594 (2,642)	0.9%	1,260 (5,604)
FE21-024U10-E991	24	82 (25)	47.46 (70.63)	0.41 (10.4)	225 (1,000)	32 (144)	0.7%	84 (375)
FE22-024U10-E991	24	164 (50)	47.46 (70.63)	0.41 (10.4)	225 (1,000)	65 (289)	0.7%	169 (750)
FE23-024U10-E991	24	246 (75)	47.72 (71.02)	0.41 (10.4)	261 (1,159)	98 (435)	0.7%	253 (1,127)
FE24-024U10-E991	24	328 (100)	48.25 (71.80)	0.41 (10.4)	333 (1,479)	132 (587)	0.7%	327 (1,455)
FE25-024U10-E991	24	410 (125)	49.04 (72.97)	0.41 (10.5)	440 (1,959)	167 (743)	0.7%	406 (1,806)
FE26-024U10-E991	24	492 (150)	49.56 (73.75)	0.41 (10.5)	512 (2,279)	203 (903)	0.7%	495 (2,200)
FE27-024U10-E991	24	574 (175)	50.08 (74.53)	0.42 (10.6)	584 (2,598)	239 (1,063)	0.8%	554 (2,464)
FE28-024U10-E991	24	656 (200)	50.61 (75.31)	0.42 (10.6)	656 (2,918)	276 (1,230)	0.8%	641 (2,850)
FE29-024U10-E991	24	738 (225)	51.39 (76.48)	0.42 (10.7)	764 (3,398)	314 (1,399)	0.8%	730 (3,247)

# EnduraSpan™ ADSS

## ADSS PRODUCT MATRIX

Part Number	Fiber Count	Span ft (m)	Nominal Weight lbs/kft (kg/km)	Nominal Diameter in (mm)	MRCL lbs (N)	Initial Tension		
						Unloaded		Loaded
						lbs (N)	sag %	lbs (N)
<b>LIGHT NESC Loading District</b>								
FE2A-024U10-E991	24	820 (250)	51.65 (76.87)	0.42 (10.7)	800 (3,558)	353 (1,568)	0.8%	782 (3,479)
FE2B-024U10-E991	24	902 (275)	51.95 (77.31)	0.42 (10.7)	902 (4,014)	389 (1,730)	0.8%	856 (3,806)
FE2C-024U10-E991	24	984 (300)	52.47 (78.09)	0.42 (10.7)	982 (4,367)	429 (1,908)	0.8%	940 (4,183)
FE2D-024U10-E991	24	1,066 (325)	53.00 (78.87)	0.42 (10.8)	1,061 (4,720)	468 (2,084)	0.9%	1,002 (4,458)
FE2E-024U10-E991	24	1,148 (350)	53.52 (79.65)	0.43 (10.8)	1,140 (5,073)	510 (2,268)	0.9%	1,087 (4,836)
FE2F-024U10-E991	24	1,230 (375)	54.05 (80.43)	0.43 (10.8)	1,220 (5,425)	552 (2,455)	0.9%	1,173 (5,220)
FE2G-024U10-E991	24	1,312 (400)	54.57 (81.21)	0.43 (10.9)	1,299 (5,778)	595 (2,647)	0.9%	1,261 (5,608)
FE21-036U10-E991	36	82 (25)	47.55 (70.76)	0.41 (10.4)	225 (1,000)	33 (145)	0.6%	90 (398)
FE22-036U10-E991	36	164 (50)	47.55 (70.76)	0.41 (10.4)	225 (1,000)	65 (289)	0.6%	179 (797)
FE23-036U10-E991	36	246 (75)	47.81 (71.16)	0.41 (10.4)	261 (1,159)	98 (436)	0.7%	254 (1,128)
FE24-036U10-E991	36	328 (100)	48.34 (71.94)	0.41 (10.4)	333 (1,479)	132 (588)	0.7%	327 (1,456)
FE25-036U10-E991	36	410 (125)	49.13 (73.11)	0.41 (10.5)	440 (1,959)	167 (744)	0.7%	406 (1,807)
FE26-036U10-E991	36	492 (150)	49.65 (73.89)	0.41 (10.5)	512 (2,279)	203 (905)	0.7%	495 (2,201)
FE27-036U10-E991	36	574 (175)	50.18 (74.67)	0.42 (10.6)	584 (2,598)	239 (1,065)	0.8%	554 (2,465)
FE28-036U10-E991	36	656 (200)	50.70 (75.45)	0.42 (10.6)	656 (2,918)	277 (1,232)	0.8%	641 (2,852)
FE29-036U10-E991	36	738 (225)	51.49 (76.62)	0.42 (10.7)	764 (3,398)	315 (1,401)	0.8%	730 (3,249)
FE2A-036U10-E991	36	820 (250)	51.75 (77.01)	0.42 (10.7)	800 (3,558)	353 (1,571)	0.8%	783 (3,482)
FE2B-036U10-E991	36	902 (275)	52.04 (77.45)	0.42 (10.7)	902 (4,014)	390 (1,733)	0.8%	856 (3,808)
FE2C-036U10-E991	36	984 (300)	52.57 (78.23)	0.42 (10.7)	982 (4,367)	430 (1,911)	0.8%	941 (4,186)
FE2D-036U10-E991	36	1,066 (325)	53.09 (79.01)	0.42 (10.8)	1,061 (4,720)	469 (2,088)	0.9%	1,003 (4,461)
FE2E-036U10-E991	36	1,148 (350)	53.62 (79.79)	0.43 (10.8)	1,140 (5,073)	511 (2,272)	0.9%	1,088 (4,839)
FE2F-036U10-E991	36	1,230 (375)	54.14 (80.57)	0.43 (10.8)	1,220 (5,425)	553 (2,460)	0.9%	1,174 (5,223)
FE2G-036U10-E991	36	1,312 (400)	54.66 (81.35)	0.43 (10.9)	1,299 (5,778)	596 (2,651)	0.9%	1,262 (5,612)
FE21-072U10-E991	72	82 (25)	56.50 (84.08)	0.43 (11.0)	346 (1,538)	39 (172)	0.7%	95 (422)
FE22-072U10-E991	72	164 (50)	56.50 (84.08)	0.43 (11.0)	346 (1,538)	77 (344)	0.7%	190 (843)
FE23-072U10-E991	72	246 (75)	56.50 (84.08)	0.43 (11.0)	346 (1,538)	116 (516)	0.7%	284 (1,265)
FE24-072U10-E991	72	328 (100)	56.76 (84.46)	0.43 (11.0)	380 (1,690)	155 (689)	0.8%	354 (1,576)
FE25-072U10-E991	72	410 (125)	57.53 (85.62)	0.44 (11.1)	483 (2,147)	196 (871)	0.8%	454 (2,021)
FE26-072U10-E991	72	492 (150)	58.05 (86.39)	0.44 (11.1)	551 (2,451)	238 (1,059)	0.8%	545 (2,424)
FE27-072U10-E991	72	574 (175)	58.57 (87.15)	0.44 (11.2)	619 (2,755)	280 (1,247)	0.8%	614 (2,731)
FE28-072U10-E991	72	656 (200)	59.34 (88.31)	0.44 (11.2)	722 (3,212)	324 (1,441)	0.8%	703 (3,126)
FE29-072U10-E991	72	738 (225)	60.11 (89.46)	0.44 (11.3)	825 (3,668)	369 (1,641)	0.8%	793 (3,527)
FE2A-072U10-E991	72	820 (250)	60.63 (90.22)	0.44 (11.3)	893 (3,973)	413 (1,836)	0.9%	867 (3,858)
FE2B-072U10-E991	72	902 (275)	60.92 (90.65)	0.45 (11.3)	991 (4,407)	456 (2,029)	0.9%	940 (4,183)
FE2C-072U10-E991	72	984 (300)	61.43 (91.42)	0.45 (11.4)	1,066 (4,743)	503 (2,237)	0.9%	1,038 (4,617)
FE2D-072U10-E991	72	1,066 (325)	61.95 (92.19)	0.45 (11.4)	1,142 (5,079)	549 (2,443)	0.9%	1,110 (4,939)
FE2E-072U10-E991	72	1,148 (350)	62.47 (92.96)	0.45 (11.4)	1,217 (5,414)	598 (2,659)	0.9%	1,209 (5,377)
FE2F-072U10-E991	72	1,230 (375)	63.50 (94.50)	0.45 (11.5)	1,368 (6,086)	645 (2,871)	0.9%	1,311 (5,832)
FE2G-072U10-E991	72	1,312 (400)	64.01 (95.26)	0.45 (11.5)	1,444 (6,421)	697 (3,100)	0.9%	1,383 (6,153)
FE21-096U10-E991	96	82 (25)	74.88 (111.43)	0.50 (12.7)	395 (1,755)	51 (228)	0.8%	110 (491)
FE22-096U10-E991	96	164 (50)	74.88 (111.43)	0.50 (12.7)	395 (1,755)	102 (456)	0.8%	221 (982)
FE23-096U10-E991	96	246 (75)	74.88 (111.43)	0.50 (12.7)	395 (1,755)	154 (683)	0.8%	331 (1,473)
FE24-096U10-E991	96	328 (100)	75.13 (111.80)	0.50 (12.7)	434 (1,929)	205 (912)	0.9%	401 (1,782)
FE25-096U10-E991	96	410 (125)	75.88 (112.92)	0.50 (12.8)	551 (2,450)	258 (1,150)	0.9%	516 (2,295)
FE26-096U10-E991	96	492 (150)	76.38 (113.66)	0.50 (12.8)	629 (2,797)	313 (1,393)	0.9%	617 (2,743)
FE27-096U10-E991	96	574 (175)	76.88 (114.40)	0.51 (12.8)	707 (3,144)	368 (1,636)	0.9%	697 (3,099)
FE28-096U10-E991	96	656 (200)	77.62 (115.52)	0.51 (12.9)	824 (3,665)	424 (1,885)	0.9%	795 (3,534)
FE29-096U10-E991	96	738 (225)	78.37 (116.63)	0.51 (12.9)	941 (4,186)	481 (2,138)	0.9%	911 (4,054)
FE2A-096U10-E991	96	820 (250)	78.87 (117.37)	0.51 (12.9)	1,019 (4,533)	537 (2,390)	1.0%	984 (4,376)
FE2B-096U10-E991	96	902 (275)	79.15 (117.79)	0.51 (13.0)	1,131 (5,029)	593 (2,637)	1.0%	1,060 (4,717)
FE2C-096U10-E991	96	984 (300)	79.65 (118.54)	0.51 (13.0)	1,217 (5,412)	652 (2,900)	1.0%	1,171 (5,210)
FE2D-096U10-E991	96	1,066 (325)	80.15 (119.28)	0.51 (13.0)	1,303 (5,795)	711 (3,161)	1.0%	1,253 (5,574)
FE2E-096U10-E991	96	1,148 (350)	80.65 (120.03)	0.51 (13.0)	1,389 (6,178)	771 (3,430)	1.0%	1,365 (6,072)
FE2F-096U10-E991	96	1,230 (375)	81.66 (121.52)	0.52 (13.1)	1,561 (6,944)	831 (3,695)	1.0%	1,479 (6,581)
FE2G-096U10-E991	96	1,312 (400)	82.16 (122.26)	0.52 (13.1)	1,647 (7,327)	893 (3,972)	1.0%	1,595 (7,095)

**ADSS PRODUCT MATRIX**

Part Number	Fiber Count	Span ft (m)	Nominal Weight lbs/kft (kg/km)	Nominal Diameter in (mm)	MRCL lbs (N)	Initial Tension		
						Unloaded	Loaded	
						lbs (N)	sag %	lbs (N)
<b>LIGHT NESC Loading District</b>								
FE21-144U10-E991	144	82 (25)	123.95 (184.46)	0.63 (16.1)	660 (2,938)	85 (377)	0.9%	150 (667)
FE22-144U10-E991	144	164 (50)	123.95 (184.46)	0.63 (16.1)	660 (2,938)	170 (754)	0.9%	300 (1,335)
FE23-144U10-E991	144	246 (75)	123.95 (184.46)	0.63 (16.1)	660 (2,938)	254 (1,131)	0.9%	450 (2,002)
FE24-144U10-E991	144	328 (100)	123.95 (184.46)	0.63 (16.1)	660 (2,938)	339 (1,508)	1.0%	570 (2,537)
FE25-144U10-E991	144	410 (125)	124.19 (184.82)	0.63 (16.1)	701 (3,118)	425 (1,889)	1.0%	697 (3,099)
FE26-144U10-E991	144	492 (150)	125.15 (186.25)	0.64 (16.2)	863 (3,838)	513 (2,281)	1.0%	828 (3,684)
FE27-144U10-E991	144	574 (175)	125.87 (187.31)	0.64 (16.2)	984 (4,379)	601 (2,674)	1.1%	961 (4,273)
FE28-144U10-E991	144	656 (200)	126.59 (188.38)	0.64 (16.2)	1,106 (4,919)	692 (3,079)	1.1%	1,087 (4,834)
FE29-144U10-E991	144	738 (225)	127.54 (189.81)	0.64 (16.3)	1,268 (5,640)	783 (3,484)	1.1%	1,243 (5,528)
FE2A-144U10-E991	144	820 (250)	128.02 (190.52)	0.64 (16.3)	1,349 (6,000)	875 (3,893)	1.1%	1,339 (5,954)
FE2B-144U10-E991	144	902 (275)	128.54 (191.28)	0.64 (16.3)	1,513 (6,732)	965 (4,292)	1.1%	1,456 (6,475)
FE2C-144U10-E991	144	984 (300)	129.50 (192.71)	0.64 (16.4)	1,692 (7,527)	1,058 (4,705)	1.1%	1,634 (7,268)
FE2D-144U10-E991	144	1,066 (325)	129.98 (193.43)	0.64 (16.4)	1,781 (7,924)	1,153 (5,127)	1.2%	1,706 (7,589)
FE2E-144U10-E991	144	1,148 (350)	130.94 (194.86)	0.65 (16.4)	1,960 (8,719)	1,247 (5,547)	1.1%	1,885 (8,386)
FE2F-144U10-E991	144	1,230 (375)	131.42 (195.58)	0.65 (16.4)	2,050 (9,117)	1,346 (5,987)	1.1%	1,999 (8,893)
FE2G-144U10-E991	144	1,312 (400)	132.39 (197.01)	0.65 (16.5)	2,228 (9,912)	1,442 (6,416)	1.1%	2,184 (9,716)
FE21-288U10-E991	288	82 (25)	150.55 (224.05)	0.73 (18.5)	514 (2,287)	103 (458)	1.0%	174 (773)
FE22-288U10-E991	288	164 (50)	150.55 (224.05)	0.73 (18.5)	514 (2,287)	206 (916)	1.0%	347 (1,546)
FE23-288U10-E991	288	246 (75)	150.79 (224.40)	0.73 (18.5)	546 (2,427)	309 (1,376)	1.0%	533 (2,372)
FE24-288U10-E991	288	328 (100)	151.96 (226.15)	0.73 (18.6)	703 (3,128)	416 (1,849)	1.0%	693 (3,083)
FE25-288U10-E991	288	410 (125)	153.37 (228.25)	0.73 (18.6)	892 (3,970)	524 (2,330)	1.0%	866 (3,851)
FE26-288U10-E991	288	492 (150)	154.58 (230.04)	0.73 (18.7)	1,109 (4,931)	634 (2,818)	1.0%	1,058 (4,708)
FE27-288U10-E991	288	574 (175)	155.52 (231.45)	0.74 (18.7)	1,248 (5,550)	742 (3,300)	1.0%	1,205 (5,360)
FE28-288U10-E991	288	656 (200)	156.47 (232.85)	0.74 (18.7)	1,387 (6,169)	855 (3,805)	1.0%	1,362 (6,057)
FE29-288U10-E991	288	738 (225)	157.89 (234.97)	0.74 (18.8)	1,595 (7,097)	969 (4,310)	1.0%	1,566 (6,967)
FE2A-288U10-E991	288	820 (250)	158.83 (236.37)	0.74 (18.8)	1,735 (7,715)	1,082 (4,815)	1.1%	1,695 (7,542)
FE2B-288U10-E991	288	902 (275)	162.23 (241.42)	0.75 (19.0)	1,927 (8,572)	1,216 (5,408)	1.1%	1,840 (8,184)
FE2C-288U10-E991	288	984 (300)	163.41 (243.19)	0.75 (19.0)	2,071 (9,214)	1,340 (5,960)	1.1%	2,048 (9,109)
FE2D-288U10-E991	288	1,066 (325)	164.60 (244.96)	0.75 (19.0)	2,216 (9,857)	1,463 (6,508)	1.1%	2,207 (9,816)
FE2E-288U10-E991	288	1,148 (350)	166.98 (248.49)	0.75 (19.1)	2,505 (11,142)	1,585 (7,049)	1.1%	2,419 (10,760)
FE2F-288U10-E991	288	1,230 (375)	168.17 (250.26)	0.75 (19.2)	2,649 (11,785)	1,716 (7,634)	1.1%	2,530 (11,253)
FE2G-288U10-E991	288	1,312 (400)	169.35 (252.03)	0.76 (19.2)	2,794 (12,427)	1,850 (8,228)	1.1%	2,750 (12,233)

## PART NUMBERS AND PHYSICAL CHARACTERISTICS

Part Number	Fiber Count	Span ft (m)	Nominal Weight lbs/kft (kg/km)	Nominal Diameter in (mm)	MRCL lbs (N)	Initial Tension		
						Unloaded		Loaded
						lbs (N)	sag %	lbs (N)
<b>MEDIUM NESC Loading District</b>								
FE31-012U10-E991	12	82 (25)	47.37 (70.49)	0.41 (10.4)	225 (1,000)	32 (144)	2.3%	176 (785)
FE32-012U10-E991	12	164 (50)	47.89 (71.27)	0.41 (10.4)	297 (1,319)	65 (290)	3.1%	262 (1,165)
FE33-012U10-E991	12	246 (75)	48.68 (72.44)	0.41 (10.5)	404 (1,799)	100 (444)	3.1%	393 (1,748)
FE34-012U10-E991	12	328 (100)	49.73 (74.01)	0.42 (10.5)	548 (2,439)	136 (603)	3.2%	514 (2,288)
FE35-012U10-E991	12	410 (125)	50.52 (75.17)	0.42 (10.6)	656 (2,918)	173 (768)	3.2%	651 (2,895)
FE36-012U10-E991	12	492 (150)	51.56 (76.73)	0.42 (10.7)	800 (3,558)	211 (940)	3.2%	784 (3,488)
FE37-012U10-E991	12	574 (175)	51.86 (77.17)	0.42 (10.7)	902 (4,014)	248 (1,104)	3.3%	902 (4,011)
FE38-012U10-E991	12	656 (200)	52.91 (78.73)	0.42 (10.8)	1,061 (4,720)	289 (1,284)	3.3%	1,032 (4,590)
FE39-012U10-E991	12	738 (225)	53.95 (80.29)	0.43 (10.8)	1,220 (5,425)	330 (1,469)	3.3%	1,164 (5,177)
FE3A-012U10-E991	12	820 (250)	54.48 (81.07)	0.43 (10.9)	1,299 (5,778)	372 (1,655)	3.4%	1,285 (5,718)
FE3B-012U10-E991	12	902 (275)	55.52 (82.63)	0.43 (11.0)	1,458 (6,484)	416 (1,851)	3.4%	1,418 (6,307)
FE3C-012U10-E991	12	984 (300)	56.57 (84.18)	0.43 (11.0)	1,616 (7,189)	461 (2,053)	3.4%	1,552 (6,902)
FE3D-012U10-E991	12	1,066 (325)	60.30 (89.73)	0.44 (11.3)	1,836 (8,166)	528 (2,347)	3.5%	1,687 (7,506)
FE3E-012U10-E991	12	1,148 (350)	61.60 (91.67)	0.45 (11.4)	2,000 (8,898)	577 (2,565)	3.4%	1,855 (8,252)
FE3F-012U10-E991	12	1,230 (375)	61.60 (91.67)	0.45 (11.4)	2,000 (8,898)	631 (2,809)	3.4%	1,992 (8,860)
FE3G-012U10-E991	12	1,312 (400)	62.90 (93.60)	0.45 (11.5)	2,165 (9,631)	686 (3,052)	3.4%	2,135 (9,495)
FE31-024U10-E991	24	82 (25)	47.46 (70.63)	0.41 (10.4)	225 (1,000)	32 (144)	3.0%	136 (606)
FE32-024U10-E991	24	164 (50)	47.98 (71.41)	0.41 (10.4)	297 (1,319)	65 (290)	3.1%	262 (1,165)
FE33-024U10-E991	24	246 (75)	48.77 (72.58)	0.41 (10.5)	404 (1,799)	100 (445)	3.1%	393 (1,749)
FE34-024U10-E991	24	328 (100)	49.82 (74.14)	0.42 (10.5)	548 (2,439)	136 (604)	3.2%	515 (2,289)
FE35-024U10-E991	24	410 (125)	50.61 (75.31)	0.42 (10.6)	656 (2,918)	173 (769)	3.2%	651 (2,896)
FE36-024U10-E991	24	492 (150)	51.65 (76.87)	0.42 (10.7)	800 (3,558)	212 (941)	3.2%	784 (3,489)
FE37-024U10-E991	24	574 (175)	51.95 (77.31)	0.42 (10.7)	902 (4,014)	249 (1,106)	3.3%	902 (4,012)
FE38-024U10-E991	24	656 (200)	53.00 (78.87)	0.42 (10.8)	1,061 (4,720)	289 (1,286)	3.3%	1,032 (4,592)
FE39-024U10-E991	24	738 (225)	54.05 (80.43)	0.43 (10.8)	1,220 (5,425)	331 (1,472)	3.3%	1,164 (5,179)
FE3A-024U10-E991	24	820 (250)	54.57 (81.21)	0.43 (10.9)	1,299 (5,778)	373 (1,658)	3.4%	1,286 (5,721)
FE3B-024U10-E991	24	902 (275)	55.62 (82.77)	0.43 (11.0)	1,458 (6,484)	417 (1,854)	3.4%	1,418 (6,309)
FE3C-024U10-E991	24	984 (300)	56.66 (84.32)	0.43 (11.0)	1,616 (7,189)	462 (2,056)	3.4%	1,552 (6,905)
FE3D-024U10-E991	24	1,066 (325)	60.39 (89.87)	0.44 (11.3)	1,836 (8,166)	528 (2,351)	3.5%	1,688 (7,509)
FE3E-024U10-E991	24	1,148 (350)	61.69 (91.81)	0.45 (11.4)	2,000 (8,898)	577 (2,569)	3.4%	1,856 (8,256)
FE3F-024U10-E991	24	1,230 (375)	61.69 (91.81)	0.45 (11.4)	2,000 (8,898)	632 (2,813)	3.4%	1,993 (8,864)
FE3G-024U10-E991	24	1,312 (400)	62.99 (93.74)	0.45 (11.5)	2,165 (9,631)	687 (3,057)	3.4%	2,136 (9,500)
FE31-036U10-E991	36	82 (25)	47.55 (70.76)	0.41 (10.4)	225 (1,000)	33 (145)	3.0%	136 (606)
FE32-036U10-E991	36	164 (50)	48.08 (71.55)	0.41 (10.4)	297 (1,319)	65 (291)	3.1%	262 (1,166)
FE33-036U10-E991	36	246 (75)	48.87 (72.72)	0.41 (10.5)	404 (1,799)	100 (445)	3.1%	393 (1,750)
FE34-036U10-E991	36	328 (100)	49.92 (74.28)	0.42 (10.5)	548 (2,439)	136 (605)	3.2%	515 (2,290)
FE35-036U10-E991	36	410 (125)	50.70 (75.45)	0.42 (10.6)	656 (2,918)	173 (771)	3.2%	651 (2,897)
FE36-036U10-E991	36	492 (150)	51.75 (77.01)	0.42 (10.7)	800 (3,558)	212 (943)	3.2%	785 (3,490)
FE37-036U10-E991	36	574 (175)	52.57 (78.23)	0.42 (10.7)	982 (4,367)	249 (1,107)	3.3%	903 (4,018)
FE38-036U10-E991	36	656 (200)	53.09 (79.01)	0.42 (10.8)	1,061 (4,720)	290 (1,289)	3.3%	1,033 (4,594)
FE39-036U10-E991	36	738 (225)	54.14 (80.57)	0.43 (10.8)	1,220 (5,425)	331 (1,474)	3.3%	1,165 (5,181)
FE3A-036U10-E991	36	820 (250)	54.66 (81.35)	0.43 (10.9)	1,299 (5,778)	373 (1,661)	3.4%	1,287 (5,723)
FE3B-036U10-E991	36	902 (275)	55.71 (82.90)	0.43 (11.0)	1,458 (6,484)	418 (1,858)	3.4%	1,419 (6,312)
FE3C-036U10-E991	36	984 (300)	56.75 (84.46)	0.43 (11.0)	1,616 (7,189)	463 (2,060)	3.4%	1,553 (6,908)
FE3D-036U10-E991	36	1,066 (325)	60.48 (90.01)	0.44 (11.3)	1,836 (8,166)	529 (2,355)	3.5%	1,689 (7,512)
FE3E-036U10-E991	36	1,148 (350)	61.79 (91.95)	0.45 (11.4)	2,000 (8,898)	578 (2,573)	3.4%	1,857 (8,259)
FE3F-036U10-E991	36	1,230 (375)	61.79 (91.95)	0.45 (11.4)	2,000 (8,898)	633 (2,818)	3.4%	1,994 (8,868)
FE3G-036U10-E991	36	1,312 (400)	63.09 (93.88)	0.45 (11.5)	2,165 (9,631)	688 (3,062)	3.4%	2,137 (9,504)
FE31-072U10-E991	72	82 (25)	56.50 (84.08)	0.43 (11.0)	346 (1,538)	39 (172)	3.0%	140 (624)
FE32-072U10-E991	72	164 (50)	56.50 (84.08)	0.43 (11.0)	346 (1,538)	77 (344)	3.0%	281 (1,248)
FE33-072U10-E991	72	246 (75)	57.27 (85.23)	0.44 (11.1)	448 (1,995)	117 (521)	3.1%	416 (1,851)
FE34-072U10-E991	72	328 (100)	58.31 (86.77)	0.44 (11.1)	585 (2,603)	159 (706)	3.1%	553 (2,461)
FE35-072U10-E991	72	410 (125)	59.34 (88.31)	0.44 (11.2)	722 (3,212)	202 (900)	3.2%	691 (3,072)
FE36-072U10-E991	72	492 (150)	60.37 (89.84)	0.44 (11.3)	859 (3,821)	247 (1,099)	3.2%	835 (3,715)

**PART NUMBERS AND PHYSICAL CHARACTERISTICS**

Part Number	Fiber Count	Span ft (m)	Nominal Weight lbs/kft (kg/km)	Nominal Diameter in (mm)	MRCL lbs (N)	Initial Tension		
						Unloaded		Loaded
						lbs (N)	sag %	lbs (N)
<b>MEDIUM NESC Loading District</b>								
FE37-072U10-E991	72	574 (175)	60.92 (90.65)	0.45 (11.3)	991 (4,407)	291 (1,293)	3.3%	958 (4,263)
FE38-072U10-E991	72	656 (200)	61.95 (92.19)	0.45 (11.4)	1,142 (5,079)	338 (1,502)	3.3%	1,100 (4,895)
FE39-072U10-E991	72	738 (225)	62.98 (93.73)	0.45 (11.5)	1,293 (5,750)	386 (1,717)	3.3%	1,244 (5,533)
FE3A-072U10-E991	72	820 (250)	64.01 (95.26)	0.45 (11.5)	1,444 (6,421)	434 (1,931)	3.3%	1,379 (6,134)
FE3B-072U10-E991	72	902 (275)	65.04 (96.80)	0.46 (11.6)	1,594 (7,093)	485 (2,158)	3.3%	1,524 (6,777)
FE3C-072U10-E991	72	984 (300)	65.56 (97.56)	0.46 (11.6)	1,670 (7,428)	538 (2,393)	3.3%	1,668 (7,422)
FE3D-072U10-E991	72	1,066 (325)	69.24 (103.04)	0.47 (11.9)	1,879 (8,358)	612 (2,722)	3.4%	1,816 (8,077)
FE3E-072U10-E991	72	1,148 (350)	70.53 (104.96)	0.47 (11.9)	2,036 (9,055)	671 (2,984)	3.4%	1,968 (8,753)
FE3F-072U10-E991	72	1,230 (375)	71.81 (106.87)	0.47 (12.0)	2,192 (9,752)	732 (3,256)	3.4%	2,122 (9,440)
FE3G-072U10-E991	72	1,312 (400)	73.09 (108.78)	0.48 (12.1)	2,349 (10,449)	795 (3,535)	3.3%	2,279 (10,136)
FE31-096U10-E991	96	82 (25)	74.88 (111.43)	0.50 (12.7)	395 (1,755)	51 (228)	3.2%	150 (668)
FE32-096U10-E991	96	164 (50)	74.88 (111.43)	0.50 (12.7)	395 (1,755)	102 (456)	3.2%	300 (1,336)
FE33-096U10-E991	96	246 (75)	75.38 (112.17)	0.50 (12.7)	473 (2,102)	154 (686)	3.3%	437 (1,946)
FE34-096U10-E991	96	328 (100)	76.13 (113.29)	0.50 (12.8)	590 (2,623)	208 (926)	3.3%	582 (2,590)
FE35-096U10-E991	96	410 (125)	77.13 (114.77)	0.51 (12.8)	746 (3,318)	263 (1,172)	3.3%	730 (3,247)
FE36-096U10-E991	96	492 (150)	78.12 (116.26)	0.51 (12.9)	902 (4,012)	320 (1,424)	3.3%	879 (3,910)
FE37-096U10-E991	96	574 (175)	78.87 (117.37)	0.51 (12.9)	1,019 (4,533)	378 (1,679)	3.4%	1,017 (4,525)
FE38-096U10-E991	96	656 (200)	79.65 (118.54)	0.51 (13.0)	1,217 (5,412)	434 (1,931)	3.4%	1,154 (5,133)
FE39-096U10-E991	96	738 (225)	80.65 (120.03)	0.51 (13.0)	1,389 (6,178)	493 (2,194)	3.4%	1,321 (5,876)
FE3A-096U10-E991	96	820 (250)	81.16 (120.77)	0.51 (13.1)	1,475 (6,561)	554 (2,464)	3.5%	1,443 (6,419)
FE3B-096U10-E991	96	902 (275)	82.16 (122.26)	0.52 (13.1)	1,647 (7,327)	616 (2,740)	3.5%	1,590 (7,071)
FE3C-096U10-E991	96	984 (300)	83.16 (123.75)	0.52 (13.2)	1,819 (8,093)	679 (3,021)	3.5%	1,738 (7,730)
FE3D-096U10-E991	96	1,066 (325)	83.66 (124.49)	0.52 (13.2)	1,906 (8,476)	743 (3,306)	3.5%	1,893 (8,419)
FE3E-096U10-E991	96	1,148 (350)	87.24 (129.82)	0.53 (13.4)	2,144 (9,537)	830 (3,693)	3.5%	2,053 (9,130)
FE3F-096U10-E991	96	1,230 (375)	88.49 (131.69)	0.53 (13.5)	2,323 (10,332)	901 (4,007)	3.5%	2,207 (9,817)
FE3G-096U10-E991	96	1,312 (400)	89.74 (133.55)	0.53 (13.6)	2,502 (11,128)	973 (4,328)	3.5%	2,363 (10,513)
FE31-144U10-E991	144	82 (25)	123.95 (184.46)	0.63 (16.1)	660 (2,938)	85 (377)	3.2%	182 (812)
FE32-144U10-E991	144	164 (50)	123.95 (184.46)	0.63 (16.1)	660 (2,938)	170 (754)	3.2%	365 (1,623)
FE33-144U10-E991	144	246 (75)	123.95 (184.46)	0.63 (16.1)	660 (2,938)	254 (1,131)	3.2%	547 (2,435)
FE34-144U10-E991	144	328 (100)	124.43 (185.18)	0.64 (16.1)	741 (3,298)	340 (1,512)	3.3%	709 (3,153)
FE35-144U10-E991	144	410 (125)	125.39 (186.60)	0.64 (16.2)	903 (4,019)	429 (1,907)	3.2%	899 (4,001)
FE36-144U10-E991	144	492 (150)	126.59 (188.38)	0.64 (16.2)	1,106 (4,919)	519 (2,308)	3.3%	1,077 (4,792)
FE37-144U10-E991	144	574 (175)	127.54 (189.81)	0.64 (16.3)	1,268 (5,640)	610 (2,714)	3.3%	1,248 (5,549)
FE38-144U10-E991	144	656 (200)	128.54 (191.28)	0.64 (16.3)	1,513 (6,732)	700 (3,115)	3.3%	1,441 (6,409)
FE39-144U10-E991	144	738 (225)	129.50 (192.71)	0.64 (16.4)	1,692 (7,527)	794 (3,532)	3.3%	1,629 (7,247)
FE3A-144U10-E991	144	820 (250)	130.46 (194.15)	0.65 (16.4)	1,871 (8,322)	888 (3,951)	3.3%	1,792 (7,970)
FE3B-144U10-E991	144	902 (275)	131.42 (195.58)	0.65 (16.4)	2,050 (9,117)	985 (4,380)	3.3%	1,981 (8,813)
FE3C-144U10-E991	144	984 (300)	132.39 (197.01)	0.65 (16.5)	2,228 (9,912)	1,082 (4,815)	3.3%	2,173 (9,665)
FE3D-144U10-E991	144	1,066 (325)	135.83 (202.14)	0.65 (16.6)	2,476 (11,012)	1,199 (5,335)	3.4%	2,309 (10,273)
FE3E-144U10-E991	144	1,148 (350)	137.04 (203.94)	0.66 (16.7)	2,661 (11,837)	1,304 (5,799)	3.4%	2,505 (11,142)
FE3F-144U10-E991	144	1,230 (375)	138.25 (205.74)	0.66 (16.7)	2,847 (12,663)	1,410 (6,272)	3.4%	2,703 (12,023)
FE3G-144U10-E991	144	1,312 (400)	139.46 (207.54)	0.66 (16.8)	3,032 (13,488)	1,518 (6,753)	3.4%	2,904 (12,916)
FE31-288U10-E991	288	82 (25)	150.55 (224.05)	0.73 (18.5)	514 (2,287)	103 (458)	1.0%	174 (773)
FE32-288U10-E991	288	164 (50)	150.55 (224.05)	0.73 (18.5)	514 (2,287)	206 (916)	3.1%	413 (1,836)
FE33-288U10-E991	288	246 (75)	151.73 (225.80)	0.73 (18.6)	672 (2,988)	311 (1,384)	2.9%	655 (2,916)
FE34-288U10-E991	288	328 (100)	153.37 (228.25)	0.73 (18.6)	892 (3,970)	419 (1,864)	3.0%	864 (3,845)
FE35-288U10-E991	288	410 (125)	154.58 (230.04)	0.73 (18.7)	1,109 (4,931)	528 (2,350)	3.0%	1,089 (4,843)
FE36-288U10-E991	288	492 (150)	156.47 (232.85)	0.74 (18.7)	1,387 (6,169)	640 (2,845)	3.0%	1,320 (5,872)
FE37-288U10-E991	288	574 (175)	157.42 (234.26)	0.74 (18.8)	1,526 (6,787)	754 (3,352)	3.0%	1,525 (6,785)
FE38-288U10-E991	288	656 (200)	161.04 (239.65)	0.74 (18.9)	1,783 (7,929)	880 (3,914)	3.0%	1,754 (7,801)
FE39-288U10-E991	288	738 (225)	163.41 (243.19)	0.75 (19.0)	2,071 (9,214)	1,001 (4,453)	3.1%	1,964 (8,735)
FE3A-288U10-E991	288	820 (250)	164.60 (244.96)	0.75 (19.0)	2,216 (9,857)	1,125 (5,004)	3.1%	2,201 (9,788)
FE3B-288U10-E991	288	902 (275)	166.98 (248.49)	0.75 (19.1)	2,505 (11,142)	1,251 (5,566)	3.1%	2,413 (10,734)
FE3C-288U10-E991	288	984 (300)	169.35 (252.03)	0.76 (19.2)	2,794 (12,427)	1,379 (6,134)	3.0%	2,690 (11,967)

## EnduraSpan™ ADSS

## PART NUMBERS AND PHYSICAL CHARACTERISTICS

Part Number	Fiber Count	Span ft (m)	Nominal Weight lbs/kft (kg/km)	Nominal Diameter in (mm)	MRCL lbs (N)	Initial Tension		
						Unloaded	Loaded	
						lbs (N)	sag %	lbs (N)
<b>MEDIUM NESC Loading District</b>								
FE3D-288U10-E991	288	1,066 (325)	170.54 (253.79)	0.76 (19.3)	2,938 (13,070)	1,513 (6,730)	3.1%	2,888 (12,847)
FE3E-288U10-E991	288	1,148 (350)	176.84 (263.16)	0.77 (19.5)	3,292 (14,644)	1,680 (7,474)	3.1%	3,130 (13,922)
FE3F-288U10-E991	288	1,230 (375)	179.24 (266.74)	0.77 (19.6)	3,548 (15,781)	1,824 (8,114)	3.1%	3,378 (15,027)
FE3G-288U10-E991	288	1,312 (400)	181.64 (270.31)	0.77 (19.7)	3,803 (16,917)	1,972 (8,771)	3.1%	3,632 (16,155)

**PART NUMBERS AND PHYSICAL CHARACTERISTICS**

Part Number	Fiber Count	Span ft (m)	Nominal Weight lbs/kft (kg/km)	Nominal Diameter in (mm)	MRCL lbs (N)	Initial Tension		
						Unloaded		Loaded
						lbs (N)	sag %	lbs (N)
<b>HEAVY NESC Loading District</b>								
FE41-012U10-E991	12	82 (25)	47.37 (70.49)	0.41 (10.4)	225 (1,000)	32 (144)	4.0%	218 (972)
FE42-012U10-E991	12	164 (50)	49.21 (73.23)	0.41 (10.5)	476 (2,119)	67 (298)	4.0%	441 (1,960)
FE43-012U10-E991	12	246 (75)	50.78 (75.56)	0.42 (10.6)	692 (3,078)	104 (462)	4.0%	663 (2,950)
FE44-012U10-E991	12	328 (100)	51.86 (77.17)	0.42 (10.7)	902 (4,014)	141 (629)	4.1%	876 (3,899)
FE45-012U10-E991	12	410 (125)	53.43 (79.51)	0.43 (10.8)	1,140 (5,073)	182 (810)	4.1%	1,102 (4,900)
FE46-012U10-E991	12	492 (150)	55.00 (81.85)	0.43 (10.9)	1,378 (6,131)	225 (999)	4.1%	1,330 (5,914)
FE47-012U10-E991	12	574 (175)	56.57 (84.18)	0.43 (11.0)	1,616 (7,189)	269 (1,196)	4.2%	1,537 (6,839)
FE48-012U10-E991	12	656 (200)	60.30 (89.73)	0.44 (11.3)	1,836 (8,166)	328 (1,460)	4.2%	1,785 (7,942)
FE49-012U10-E991	12	738 (225)	62.90 (93.60)	0.45 (11.5)	2,165 (9,631)	381 (1,696)	4.2%	2,018 (8,975)
FE4A-012U10-E991	12	820 (250)	64.20 (95.54)	0.45 (11.5)	2,330 (10,364)	435 (1,935)	4.2%	2,237 (9,952)
FE4B-012U10-E991	12	902 (275)	65.49 (97.46)	0.46 (11.6)	2,495 (11,096)	492 (2,190)	4.2%	2,484 (11,050)
FE4C-012U10-E991	12	984 (300)	68.08 (101.31)	0.46 (11.8)	2,824 (12,561)	553 (2,462)	4.2%	2,723 (12,114)
FE4D-012U10-E991	12	1,066 (325)	69.37 (103.23)	0.47 (11.9)	2,989 (13,294)	615 (2,736)	4.2%	2,961 (13,170)
FE4E-012U10-E991	12	1,148 (350)	76.17 (113.36)	0.48 (12.3)	3,392 (15,090)	719 (3,199)	4.2%	3,248 (14,447)
FE4F-012U10-E991	12	1,230 (375)	78.76 (117.21)	0.49 (12.4)	3,683 (16,385)	795 (3,535)	4.2%	3,507 (15,599)
FE4G-012U10-E991	12	1,312 (400)	81.34 (121.05)	0.50 (12.6)	3,975 (17,680)	874 (3,886)	4.2%	3,770 (16,769)
FE41-024U10-E991	24	82 (25)	47.46 (70.63)	0.41 (10.4)	225 (1,000)	32 (144)	4.0%	218 (972)
FE42-024U10-E991	24	164 (50)	49.30 (73.36)	0.41 (10.5)	476 (2,119)	67 (298)	4.0%	441 (1,961)
FE43-024U10-E991	24	246 (75)	50.87 (75.70)	0.42 (10.6)	692 (3,078)	104 (463)	4.0%	663 (2,950)
FE44-024U10-E991	24	328 (100)	51.95 (77.31)	0.42 (10.7)	902 (4,014)	142 (631)	4.1%	877 (3,900)
FE45-024U10-E991	24	410 (125)	53.52 (79.65)	0.43 (10.8)	1,140 (5,073)	182 (811)	4.1%	1,102 (4,901)
FE46-024U10-E991	24	492 (150)	55.09 (81.99)	0.43 (10.9)	1,378 (6,131)	225 (1,001)	4.1%	1,330 (5,915)
FE47-024U10-E991	24	574 (175)	56.66 (84.32)	0.43 (11.0)	1,616 (7,189)	269 (1,198)	4.2%	1,538 (6,840)
FE48-024U10-E991	24	656 (200)	60.39 (89.87)	0.44 (11.3)	1,836 (8,166)	329 (1,462)	4.2%	1,786 (7,944)
FE49-024U10-E991	24	738 (225)	62.99 (93.74)	0.45 (11.5)	2,165 (9,631)	382 (1,699)	4.2%	2,018 (8,977)
FE4A-024U10-E991	24	820 (250)	64.29 (95.68)	0.45 (11.5)	2,330 (10,364)	436 (1,938)	4.2%	2,238 (9,955)
FE4B-024U10-E991	24	902 (275)	65.59 (97.60)	0.46 (11.6)	2,495 (11,096)	493 (2,193)	4.2%	2,485 (11,052)
FE4C-024U10-E991	24	984 (300)	68.17 (101.45)	0.46 (11.8)	2,824 (12,561)	554 (2,465)	4.2%	2,724 (12,117)
FE4D-024U10-E991	24	1,066 (325)	69.46 (103.37)	0.47 (11.9)	2,989 (13,294)	616 (2,740)	4.2%	2,961 (13,173)
FE4E-024U10-E991	24	1,148 (350)	76.27 (113.50)	0.48 (12.3)	3,392 (15,090)	720 (3,203)	4.2%	3,249 (14,450)
FE4F-024U10-E991	24	1,230 (375)	78.85 (117.35)	0.49 (12.4)	3,683 (16,385)	796 (3,539)	4.2%	3,508 (15,602)
FE4G-024U10-E991	24	1,312 (400)	81.43 (121.19)	0.50 (12.6)	3,975 (17,680)	875 (3,891)	4.2%	3,771 (16,773)
FE41-036U10-E991	36	82 (25)	47.55 (70.76)	0.41 (10.4)	225 (1,000)	32 (145)	4.0%	219 (972)
FE42-036U10-E991	36	164 (50)	49.39 (73.50)	0.41 (10.5)	476 (2,119)	67 (299)	4.0%	441 (1,961)
FE43-036U10-E991	36	246 (75)	50.96 (75.84)	0.42 (10.6)	692 (3,078)	104 (464)	4.0%	663 (2,951)
FE44-036U10-E991	36	328 (100)	52.04 (77.45)	0.42 (10.7)	902 (4,014)	142 (632)	4.1%	877 (3,901)
FE45-036U10-E991	36	410 (125)	53.62 (79.79)	0.43 (10.8)	1,140 (5,073)	183 (813)	4.1%	1,102 (4,902)
FE46-036U10-E991	36	492 (150)	55.19 (82.13)	0.43 (10.9)	1,378 (6,131)	225 (1,003)	4.1%	1,330 (5,917)
FE47-036U10-E991	36	574 (175)	56.75 (84.46)	0.43 (11.0)	1,616 (7,189)	270 (1,200)	4.2%	1,538 (6,842)
FE48-036U10-E991	36	656 (200)	60.48 (90.01)	0.44 (11.3)	1,836 (8,166)	329 (1,464)	4.2%	1,786 (7,945)
FE49-036U10-E991	36	738 (225)	63.09 (93.88)	0.45 (11.5)	2,165 (9,631)	383 (1,702)	4.2%	2,018 (8,979)
FE4A-036U10-E991	36	820 (250)	64.38 (95.81)	0.45 (11.5)	2,330 (10,364)	436 (1,941)	4.2%	2,238 (9,957)
FE4B-036U10-E991	36	902 (275)	65.68 (97.74)	0.46 (11.6)	2,495 (11,096)	494 (2,196)	4.2%	2,485 (11,055)
FE4C-036U10-E991	36	984 (300)	68.26 (101.59)	0.46 (11.8)	2,824 (12,561)	555 (2,469)	4.2%	2,725 (12,120)
FE4D-036U10-E991	36	1,066 (325)	69.55 (103.51)	0.47 (11.9)	2,989 (13,294)	617 (2,744)	4.2%	2,962 (13,176)
FE4E-036U10-E991	36	1,148 (350)	76.36 (113.64)	0.48 (12.3)	3,392 (15,090)	721 (3,207)	4.2%	3,249 (14,454)
FE4F-036U10-E991	36	1,230 (375)	78.95 (117.49)	0.49 (12.4)	3,683 (16,385)	797 (3,544)	4.2%	3,508 (15,606)
FE4G-036U10-E991	36	1,312 (400)	81.53 (121.32)	0.50 (12.6)	3,975 (17,680)	876 (3,896)	4.2%	3,772 (16,777)
FE41-072U10-E991	72	82 (25)	56.50 (84.08)	0.43 (11.0)	346 (1,538)	39 (172)	3.9%	233 (1,036)
FE42-072U10-E991	72	164 (50)	57.53 (85.62)	0.44 (11.1)	483 (2,147)	79 (349)	3.9%	462 (2,057)
FE43-072U10-E991	72	246 (75)	59.34 (88.31)	0.44 (11.2)	722 (3,212)	121 (540)	3.9%	699 (3,108)
FE44-072U10-E991	72	328 (100)	60.88 (90.60)	0.45 (11.3)	927 (4,125)	167 (741)	4.0%	927 (4,124)
FE45-072U10-E991	72	410 (125)	62.47 (92.96)	0.45 (11.4)	1,217 (5,414)	213 (945)	4.0%	1,160 (5,160)
FE46-072U10-E991	72	492 (150)	64.01 (95.26)	0.45 (11.5)	1,444 (6,421)	262 (1,164)	4.0%	1,402 (6,237)

# EnduraSpan™ ADSS

## PART NUMBERS AND PHYSICAL CHARACTERISTICS

Part Number	Fiber Count	Span ft (m)	Nominal Weight lbs/kft (kg/km)	Nominal Diameter in (mm)	MRCL lbs (N)	Initial Tension		
						Unloaded		Loaded
						lbs (N)	sag %	lbs (N)
<b>HEAVY NESC Loading District</b>								
FE47-072U10-E991	72	574 (175)	65.56 (97.56)	0.46 (11.6)	1,670 (7,428)	313 (1,391)	4.1%	1,624 (7,223)
FE48-072U10-E991	72	656 (200)	70.53 (104.96)	0.47 (11.9)	2,036 (9,055)	379 (1,684)	4.0%	1,891 (8,412)
FE49-072U10-E991	72	738 (225)	71.81 (106.87)	0.47 (12.0)	2,192 (9,752)	440 (1,955)	4.1%	2,134 (9,491)
FE4A-072U10-E991	72	820 (250)	74.38 (110.68)	0.48 (12.2)	2,506 (11,146)	502 (2,232)	4.1%	2,358 (10,487)
FE4B-072U10-E991	72	902 (275)	75.65 (112.59)	0.48 (12.3)	2,663 (11,843)	567 (2,522)	4.1%	2,621 (11,657)
FE4C-072U10-E991	72	984 (300)	78.21 (116.39)	0.49 (12.4)	2,976 (13,238)	636 (2,830)	4.1%	2,876 (12,792)
FE4D-072U10-E991	72	1,066 (325)	84.95 (126.42)	0.50 (12.8)	3,360 (14,946)	741 (3,297)	4.1%	3,155 (14,035)
FE4E-072U10-E991	72	1,148 (350)	87.51 (130.23)	0.51 (13.0)	3,637 (16,179)	822 (3,658)	4.1%	3,427 (15,245)
FE4F-072U10-E991	72	1,230 (375)	90.07 (134.04)	0.52 (13.1)	3,914 (17,412)	907 (4,036)	4.1%	3,704 (16,475)
FE4G-072U10-E991	72	1,312 (400)	92.62 (137.84)	0.52 (13.2)	4,191 (18,645)	996 (4,431)	4.1%	3,985 (17,727)
FE41-096U10-E991	96	82 (25)	74.88 (111.43)	0.50 (12.7)	395 (1,755)	51 (228)	4.1%	238 (1,059)
FE42-096U10-E991	96	164 (50)	75.63 (112.55)	0.50 (12.8)	512 (2,276)	103 (459)	4.1%	475 (2,112)
FE43-096U10-E991	96	246 (75)	77.13 (114.77)	0.51 (12.8)	746 (3,318)	158 (702)	4.1%	712 (3,167)
FE44-096U10-E991	96	328 (100)	78.62 (117.00)	0.51 (12.9)	980 (4,360)	215 (954)	4.2%	943 (4,193)
FE45-096U10-E991	96	410 (125)	79.65 (118.54)	0.51 (13.0)	1,217 (5,412)	272 (1,209)	4.2%	1,184 (5,266)
FE46-096U10-E991	96	492 (150)	81.16 (120.77)	0.51 (13.1)	1,475 (6,561)	332 (1,477)	4.2%	1,426 (6,345)
FE47-096U10-E991	96	574 (175)	82.66 (123.01)	0.52 (13.2)	1,733 (7,710)	394 (1,751)	4.3%	1,648 (7,333)
FE48-096U10-E991	96	656 (200)	83.66 (124.49)	0.52 (13.2)	1,906 (8,476)	458 (2,036)	4.2%	1,902 (8,463)
FE49-096U10-E991	96	738 (225)	88.49 (131.69)	0.53 (13.5)	2,323 (10,332)	538 (2,395)	4.3%	2,150 (9,562)
FE4A-096U10-E991	96	820 (250)	89.74 (133.55)	0.53 (13.6)	2,502 (11,128)	609 (2,709)	4.3%	2,386 (10,614)
FE4B-096U10-E991	96	902 (275)	90.99 (135.41)	0.54 (13.6)	2,680 (11,923)	683 (3,039)	4.3%	2,650 (11,787)
FE4C-096U10-E991	96	984 (300)	93.49 (139.13)	0.54 (13.8)	3,038 (13,514)	760 (3,382)	4.3%	2,896 (12,882)
FE4D-096U10-E991	96	1,066 (325)	94.74 (140.98)	0.54 (13.8)	3,217 (14,310)	839 (3,731)	4.3%	3,150 (14,011)
FE4E-096U10-E991	96	1,148 (350)	97.23 (144.69)	0.55 (14.0)	3,575 (15,901)	921 (4,097)	4.3%	3,401 (15,129)
FE4F-096U10-E991	96	1,230 (375)	102.58 (152.65)	0.56 (14.2)	3,834 (17,055)	1,044 (4,644)	4.3%	3,715 (16,525)
FE4G-096U10-E991	96	1,312 (400)	105.09 (156.39)	0.57 (14.4)	4,150 (18,462)	1,138 (5,061)	4.3%	3,985 (17,727)
FE41-144U10-E991	144	82 (25)	123.95 (184.46)	0.63 (16.1)	660 (2,938)	85 (377)	4.0%	276 (1,227)
FE42-144U10-E991	144	164 (50)	123.95 (184.46)	0.63 (16.1)	660 (2,938)	170 (754)	4.0%	552 (2,455)
FE43-144U10-E991	144	246 (75)	125.15 (186.25)	0.64 (16.2)	863 (3,838)	256 (1,140)	4.1%	828 (3,683)
FE44-144U10-E991	144	328 (100)	126.59 (188.38)	0.64 (16.2)	1,106 (4,919)	346 (1,540)	4.1%	1,093 (4,863)
FE45-144U10-E991	144	410 (125)	128.05 (190.56)	0.64 (16.3)	1,424 (6,335)	437 (1,944)	4.1%	1,364 (6,068)
FE46-144U10-E991	144	492 (150)	129.50 (192.71)	0.64 (16.4)	1,692 (7,527)	531 (2,360)	4.1%	1,648 (7,331)
FE47-144U10-E991	144	574 (175)	130.94 (194.86)	0.65 (16.4)	1,960 (8,719)	626 (2,784)	4.2%	1,910 (8,496)
FE48-144U10-E991	144	656 (200)	132.39 (197.01)	0.65 (16.5)	2,228 (9,912)	724 (3,218)	4.2%	2,196 (9,768)
FE49-144U10-E991	144	738 (225)	137.04 (203.94)	0.66 (16.7)	2,661 (11,837)	836 (3,718)	4.1%	2,509 (11,159)
FE4A-144U10-E991	144	820 (250)	138.25 (205.74)	0.66 (16.7)	2,847 (12,663)	942 (4,190)	4.2%	2,755 (12,253)
FE4B-144U10-E991	144	902 (275)	140.67 (209.34)	0.66 (16.8)	3,218 (14,314)	1,052 (4,680)	4.2%	3,033 (13,491)
FE4C-144U10-E991	144	984 (300)	141.87 (211.13)	0.67 (16.9)	3,403 (15,139)	1,162 (5,168)	4.2%	3,348 (14,893)
FE4D-144U10-E991	144	1,066 (325)	144.29 (214.72)	0.67 (17.0)	3,775 (16,790)	1,275 (5,670)	4.2%	3,614 (16,076)
FE4E-144U10-E991	144	1,148 (350)	145.49 (216.51)	0.67 (17.0)	3,960 (17,615)	1,392 (6,191)	4.2%	3,937 (17,514)
FE4F-144U10-E991	144	1,230 (375)	153.12 (227.86)	0.68 (17.4)	4,557 (20,272)	1,549 (6,889)	4.2%	4,230 (18,817)
FE4G-144U10-E991	144	1,312 (400)	155.55 (231.49)	0.69 (17.5)	4,886 (21,732)	1,674 (7,445)	4.2%	4,614 (20,526)
FE41-288U10-E991	288	82 (25)	150.55 (224.05)	0.73 (18.5)	514 (2,287)	103 (458)	3.8%	314 (1,398)
FE42-288U10-E991	288	164 (50)	151.73 (225.80)	0.73 (18.6)	672 (2,988)	207 (923)	3.7%	656 (2,916)
FE43-288U10-E991	288	246 (75)	154.31 (229.64)	0.73 (18.7)	1,019 (4,531)	316 (1,407)	3.7%	988 (4,394)
FE44-288U10-E991	288	328 (100)	156.00 (232.15)	0.74 (18.7)	1,317 (5,859)	427 (1,898)	3.7%	1,315 (5,849)
FE45-288U10-E991	288	410 (125)	158.36 (235.67)	0.74 (18.8)	1,665 (7,406)	541 (2,408)	3.7%	1,650 (7,341)
FE46-288U10-E991	288	492 (150)	163.41 (243.19)	0.75 (19.0)	2,071 (9,214)	668 (2,972)	3.7%	1,990 (8,853)
FE47-288U10-E991	288	574 (175)	165.79 (246.72)	0.75 (19.1)	2,360 (10,500)	792 (3,525)	3.7%	2,322 (10,328)
FE48-288U10-E991	288	656 (200)	169.35 (252.03)	0.76 (19.2)	2,794 (12,427)	921 (4,097)	3.8%	2,655 (11,811)
FE49-288U10-E991	288	738 (225)	171.73 (255.56)	0.76 (19.3)	3,083 (13,712)	1,054 (4,690)	3.7%	3,022 (13,441)
FE4A-288U10-E991	288	820 (250)	179.24 (266.74)	0.77 (19.6)	3,548 (15,781)	1,215 (5,405)	3.8%	3,360 (14,945)
FE4B-288U10-E991	288	902 (275)	181.64 (270.31)	0.77 (19.7)	3,803 (16,917)	1,363 (6,064)	3.7%	3,749 (16,678)
FE4C-288U10-E991	288	984 (300)	186.44 (277.45)	0.78 (19.8)	4,314 (19,189)	1,515 (6,739)	3.8%	4,093 (18,208)



**PART NUMBERS AND PHYSICAL CHARACTERISTICS**

Part Number	Fiber Count	Span ft (m)	Nominal Weight lbs/kft (kg/km)	Nominal Diameter in (mm)	MRCL lbs (N)	Initial Tension		
						Unloaded		Loaded
						lbs (N)	sag %	lbs (N)
<b>HEAVY NESC Loading District</b>								
FE4D-288U10-E991	288	1,066 (325)	188.84 (281.02)	0.78 (19.9)	4,569 (20,325)	1,672 (7,437)	3.8%	4,476 (19,910)
FE4E-288U10-E991	288	1,148 (350)	193.63 (288.15)	0.79 (20.1)	5,080 (22,598)	1,834 (8,157)	3.8%	4,831 (21,488)

# Single Loose Tube All Dielectric

Series 51

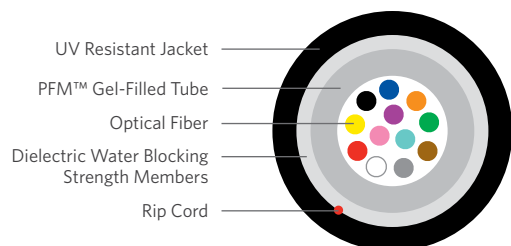

## PRODUCT DESCRIPTION

Loose tube cables are the product of choice as the backbone in Outside Plant (OSP) applications. Single Loose tube cables offer a low cost alternative to traditional stranded loose tube cables. The loose tube design offers reliable transmission performance over a broad temperature range. The durable single loose tube design features optical fibers placed inside a single PFM™ gel-filled tube. The core tube includes up to 8-fiber bundles, each containing up to 12 optical fibers bound within a color coded binder. The core tube is then helically wrapped with water-blocking strength members, then encased with a black jacket. A rip cord is included under the jacket to provide ease of access to the core tube.

## APPLICATIONS

- Underground duct and lashed aerial
- Trunk, distribution and feeder cable
- Local loop, metro, long-haul and broadband network

## FEATURES

- Available with up to 96-fiber
- Multiple fiber types
- Dielectric outer strength members
- Dry (SAP) core standard
- Highly flexible
- Small cable diameter
- Fewer cable components
- PFM gel

## BENEFITS

- High fiber density
- Multiple network applications
- Eliminates grounding or bonding problems
- Reduces cable prep and installation time
- Easy handling
- Installation of more fibers in less space
- Reduces cost
- Non-sticky gel speeds fiber access and clean-up

## SPECIFICATIONS

**Fiber Count** Available in 6-fiber up to 96-fiber

**Standards Compliance** Telcordia® GR-20-CORE  
RDUP PE-90 Designation SLT  
ICEA S-87-640-2011  
RoHS-compliant

Telcordia is a registered trademark of Ericsson Inc.

## ENVIRONMENTAL SPECIFICATIONS

**Operation/Storage** -40°C to +70°C

**Installation** -30°C to +70°C

## PART NUMBER KEY

5	1	—	—	—	x	x	0	y	
1	2	3	4	5	6	7	8	9	
Product family	Fiber count (006-096)	Fiber type	Internal designator	Water block/ marking (1-8)					

Contact Customer Service for availability of non-standard offerings.

## PART NUMBERS AND PHYSICAL CHARACTERISTICS

Part Number <sup>1</sup>	Fiber Count	Nominal Diameter in (mm)	Approx. Weight lbs/kft (kg/km)	Maximum Tensile Loading		Minimum Bend Radius	
				Install lbs (N)	Long Term lbs (N)	Install in (mm)	Long Term in (mm)
51006xx0y	6	0.31 (7.9)	36 (54)	600 (2,700)	200 (890)	6.2 (158)	3.1 (79)
51012xx0y	12	0.31 (7.9)	36 (54)	600 (2,700)	200 (890)	6.2 (158)	3.1 (79)
51024xx0y	24	0.39 (9.8)	51 (75)	600 (2,700)	200 (890)	7.8 (196)	3.9 (98)
51036xx0y	36	0.39 (9.8)	51 (75)	600 (2,700)	200 (890)	7.8 (196)	3.9 (98)
51048xx0y	48	0.39 (9.8)	51 (75)	600 (2,700)	200 (890)	7.8 (196)	3.9 (98)
51072xx0y	72	0.46 (11.6)	68 (102)	600 (2,700)	200 (890)	9.2 (232)	4.6 (116)
51096xx0y	96	0.46 (11.6)	68 (102)	600 (2,700)	200 (890)	9.2 (232)	4.6 (116)

## FIBER TYPES:

### SINGLE MODE

Reduced Water Peak	Zero Water Peak	TeraFlex® Bend Resistant			NZDS	LEAF
		G.657.A1	G.657.A2	G.657.B3		
<sup>1</sup> Replace "xx" with: 31	21	K1	J1	L1	81	S1

### MULTIMODE

TeraGain®	TeraFlex Bend Resistant Laser Optimized 50/125		
62.5/125	10G/150	10G/300	10G/550
6G	MG	NG	PG

See "Optical Fiber Specifications" in the "Technical Info" section for detailed fiber type specifications.

## WATER BLOCK AND JACKET PRINT CODES

Dry core		Dry core special	
Feet	Meters	Feet	Meters
<sup>1</sup> Replace "y" with: 1	2	5	6

# Single Loose Tube Single Armor

Series 52

## PRODUCT DESCRIPTION

Loose tube cables are the product of choice as the backbone in Outside Plant (OSP) applications. Single Loose tube cables offer a low cost alternative to traditional stranded loose tube cables. Armored cables are designed for improved mechanical and rodent protection in direct bury applications. The loose tube design offers reliable transmission performance over a broad temperature range. The durable single loose tube design features optical fibers placed inside a single PFM™ gel-filled tube. The core tube includes up to 8-fiber bundles, each containing up to 12 optical fibers bound with a color coded binder. The core is wrapped with flexible strength members and covered with a water-blocking tape. A corrugated steel armor is applied and then encased with a black jacket. Rip cords are included under the armor for ease of access to the core tube.

## APPLICATIONS

- Direct bury
- Trunk, distribution and feeder cable
- Local loop, metro, long-haul and broadband network

## FEATURES

- Available with up to 96-fiber
- Multiple fiber types
- Dry (SAP) core standard
- Highly flexible
- Fewer cable components
- Corrugated Armor
- PFM gel

## BENEFITS

- High fiber density
- Multiple network applications
- Reduces cable prep and installation time
- Easy handling
- Reduces cost
- Improves compressive strength and rodent protection
- Non-sticky gel speeds fiber access and clean-up

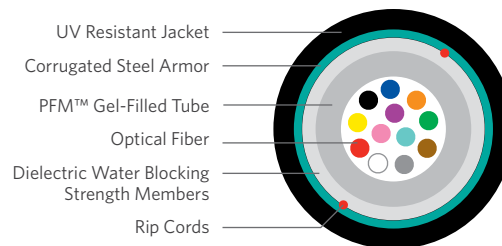
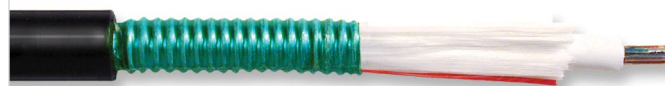

## SPECIFICATIONS

<b>Fiber Count</b>	Available in 6-fiber up to 96-fiber
<b>Standards Compliance</b>	Telcordia® GR-20-CORE RDUP PE-90 Designation SLT ICEA S-87-640-2011 RoHS-compliant

Telcordia is a registered trademark of Ericsson Inc.

## ENVIRONMENTAL SPECIFICATIONS

<b>Operation/Storage</b>	-40°C to +70°C
<b>Installation</b>	-30°C to +70°C

## PART NUMBER KEY

5	2	-	-	-	x	x	0	y
1	2	3	4	5	6	7	8	9
Product family	Fiber count (006-096)	Fiber type	Internal designator	Water block/ marking (1-8)				

Contact Customer Service for availability of non-standard offerings.

## PART NUMBERS AND PHYSICAL CHARACTERISTICS

Part Number <sup>1</sup>	Fiber Count	Nominal Diameter in (mm)	Approx. Weight lbs/kft (kg/km)	Maximum Tensile Loading		Minimum Bend Radius	
				Install lbs (N)	Long Term lbs (N)	Install in (mm)	Long Term in (mm)
52002xx0y	2	0.36 (9.1)	62 (92)	600 (2,700)	200 (890)	7.2 (183)	3.6 (91)
52004xx0y	4	0.36 (9.1)	62 (92)	600 (2,700)	200 (890)	7.2 (183)	3.6 (91)
52006xx0y	6	0.36 (9.1)	62 (92)	600 (2,700)	200 (890)	7.2 (183)	3.6 (91)
52012xx0y	12	0.36 (9.1)	62 (92)	600 (2,700)	200 (890)	7.2 (183)	3.6 (91)
52024xx0y	24	0.44 (11.0)	83 (124)	600 (2,700)	200 (890)	8.8 (224)	4.4 (112)
52036xx0y	36	0.44 (11.0)	83 (124)	600 (2,700)	200 (890)	8.8 (224)	4.4 (112)
52048xx0y	48	0.44 (11.0)	83 (124)	600 (2,700)	200 (890)	8.8 (224)	4.4 (112)
52072xx0y	72	0.50 (12.8)	111 (165)	600 (2,700)	200 (890)	10.0 (254)	5.0 (127)
52096xx0y	96	0.50 (12.8)	111 (165)	600 (2,700)	200 (890)	10.0 (254)	5.0 (127)

## FIBER TYPES:

### SINGLE MODE

Reduced Water Peak	Zero Water Peak	TeraFlex® Bend Resistant					
		G.657.A1	G.657.A2	G.657.B3	NZDS	LEAF	

<sup>1</sup>Replace "xx" with:

31	21	K1	J1	L1	81	S1
----	----	----	----	----	----	----

### MULTIMODE

TeraGain®	TeraFlex Bend Resistant Laser Optimized 50/125		
62.5/125	10G/150	10G/300	10G/550

6G	MG	NG	PG
----	----	----	----

See "Optical Fiber Specifications" in the "Technical Info" section for detailed fiber type specifications.

## WATER BLOCK AND JACKET PRINT CODES

Dry core		Dry core special	
Feet	Meters	Feet	Meters

<sup>1</sup>Replace "y" with:

1	2	5	6
---	---	---	---

# Single Flex Tube All Dielectric

Series F1

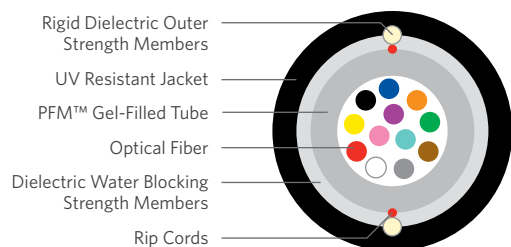

## PRODUCT DESCRIPTION

Loose tube cables are the product of choice as the backbone in Outside Plant (OSP) applications. Single Loose tube cables offer a low cost alternative to traditional stranded loose tube cables. The highly flexible single tube reduces installation problems. The loose tube design offers reliable transmission performance over a broad temperature range. The single flex tube design features optical fibers placed inside a single PFM™ gel-filled tube. The core tube includes up to 8-fiber bundles, each containing up to 12 optical fibers bound with a color coded binder. The core is wrapped with water-blocking tape and then encased with a black jacket containing rigid strength rods. A rip cord is included under the jacket for ease of access to the core tube.

## APPLICATIONS

- Underground duct and lashed aerial
- Trunk, distribution and feeder cable
- Local loop, metro, long-haul and broadband network

## SPECIFICATIONS

<b>Fiber Count</b>	Available in 6-fiber up to 96-fiber
<b>Standards Compliance</b>	Telcordia® GR-20-CORE RDUP PE-90 Designation SLT ICEA S-87-640-2011 RoHS-compliant

Telcordia is a registered trademark of Ericsson Inc.

## ENVIRONMENTAL SPECIFICATIONS

<b>Operation/Storage</b>	-40°C to +70°C
<b>Installation</b>	-30°C to +70°C

## PART NUMBER KEY

F	1	_	_	_	x	x	0	y
1	2	3	4	5	6	7	8	9
Product family	Fiber count (006-096)	Fiber type	Internal designator	Water block/ marking (1-8)				

Contact Customer Service for availability of non-standard offerings.

## FEATURES

- Available with up to 96-fiber
- Multiple fiber types
- Dielectric outer strength members
- Dry (SAP) core standard
- Highly flexible
- Small cable diameter
- Fewer cable components
- PFM gel

## BENEFITS

- High fiber density
- Multiple network applications
- Eliminates grounding or bonding problems
- Reduces cable prep and installation time
- Easy handling
- Installation of more fibers in less space
- Reduces cost
- Non-sticky gel speeds fiber access and clean-up

## PART NUMBERS AND PHYSICAL CHARACTERISTICS

Part Number <sup>1</sup>	Fiber Count	Nominal Diameter in (mm)	Approx. Weight lbs/kft (kg/km)	Maximum Tensile Loading		Minimum Bend Radius	
				Install lbs (N)	Long Term lbs (N)	Install in (mm)	Long Term in (mm)
F1006xx0y	6	0.47 (11.9)	75 (112)	600 (2,700)	200 (890)	9.4 (238)	4.7 (119)
F1012xx0y	12	0.47 (11.9)	75 (112)	600 (2,700)	200 (890)	9.4 (238)	4.7 (119)
F1024xx0y	24	0.47 (11.9)	75 (112)	600 (2,700)	200 (890)	9.4 (238)	4.7 (119)
F1036xx0y	36	0.47 (11.9)	75 (112)	600 (2,700)	200 (890)	9.4 (238)	4.7 (119)
F1048xx0y	48	0.47 (11.9)	75 (112)	600 (2,700)	200 (890)	9.4 (238)	4.7 (119)
F1072xx0y	72	0.55 (14.0)	101 (150)	600 (2,700)	200 (890)	11.0 (279)	5.5 (139)
F1096xx0y	96	0.55 (14.0)	101 (150)	600 (2,700)	200 (890)	11.0 (279)	5.5 (139)

## FIBER TYPES:

### SINGLE MODE

Reduced Water Peak    Zero Water Peak    TeraFlex® Bend Resistant  
G.657.A1    G.657.A2    G.657.B3    NZDS    LEAF

<sup>1</sup> For ≤ 12 fibers replace "xx" with:	36	26	K6	J6	L6	86	S6
<sup>1</sup> For > 12 fibers replace "xx" with:	31	21	K1	J1	L1	81	S1

### MULTIMODE

TeraGain®    TeraFlex Bend Resistant Laser Optimized 50/125  
62.5/125    10G/150    10G/300    10G/550

6G	MG	NG	PG
----	----	----	----

See "Optical Fiber Specifications" in the "Technical Info" section for detailed fiber type specifications.

## WATER BLOCK AND JACKET PRINT CODES

Dry core    Dry core special  
Feet    Meters    Feet    Meters

<sup>1</sup> Replace "y" with:	1	2	5	6
--------------------------------	---	---	---	---

# Single Flex Tube Single Armor

Series F2

## PRODUCT DESCRIPTION

Single loose tube cables offer a low cost alternative to traditional stranded loose tube cables and the armor provides additional protection for certain environments. The highly flexible single tube reduces installation problems. The loose tube design offers reliable transmission performance over a broad temperature range. The single flex tube design features optical fibers placed inside a single PFM™ gel-filled tube. The core tube includes up to 8-fiber bundles, each containing up to 12 optical fibers bound with a color coded binder. The core is wrapped with flexible strength members covered with a water-blocking tape, a corrugated steel armor is applied and then encased with a black jacket containing rigid steel rods. Rip cords are included under the armor for ease of access to the core tube.

## APPLICATIONS

- Direct bury, underground duct and lashed aerial
- Trunk, distribution and feeder cable
- Local loop, metro, long-haul and broadband network

## FEATURES

- Available with up to 96-fiber
- Multiple fiber types
- Metallic outer strength members
- Dry (SAP) core standard
- Highly flexible
- Small cable diameter
- Fewer cable components
- Corrugated Armor
- PFM gel

## BENEFITS

- High fiber density
- Multiple network applications
- Offers ease of location
- Reduces cable prep and installation time
- Easy handling
- Installation of more fibers in less space
- Reduces cost
- Improves compressive strength and rodent protection
- Non-sticky gel speeds fiber access and clean-up

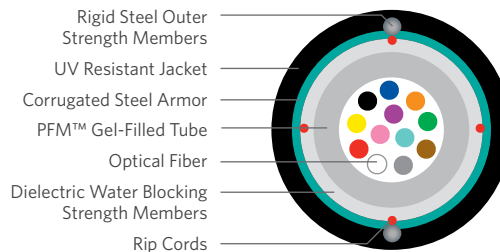

## SPECIFICATIONS

<b>Fiber Count</b>	Available in 6-fiber up to 96-fiber
<b>Standards Compliance</b>	Telcordia® GR-20-CORE RDUP PE-90 Designation SLT ICEA S-87-640-2011 RoHS-compliant

Telcordia is a registered trademark of Ericsson Inc.

## ENVIRONMENTAL SPECIFICATIONS

<b>Operation/Storage</b>	-40°C to +70°C
<b>Installation</b>	-30°C to +70°C

## PART NUMBER KEY

F	2	-	-	-	x	x	S	y
1	2	3	4	5	6	7	8	9
Product family	Fiber count (006-096)			Fiber type	Internal designator	Water block/ marking (1-8)		

Contact Customer Service for availability of non-standard offerings.

## PART NUMBERS AND PHYSICAL CHARACTERISTICS

Part Number <sup>1</sup>	Fiber Count	Nominal Diameter in (mm)	Approx. Weight lbs/kft (kg/km)	Maximum Tensile Loading		Minimum Bend Radius	
				Install lbs (N)	Long Term lbs (N)	Install in (mm)	Long Term in (mm)
F2006xxSy	6	0.51 (13.0)	117 (174)	600 (2,700)	200 (890)	10.2 (259)	5.1 (129)
F2012xxSy	12	0.51 (13.0)	117 (174)	600 (2,700)	200 (890)	10.2 (259)	5.1 (129)
F2024xxSy	24	0.51 (13.0)	117 (174)	600 (2,700)	200 (890)	10.2 (259)	5.1 (129)
F2036xxSy	36	0.51 (13.0)	117 (174)	600 (2,700)	200 (890)	10.2 (259)	5.1 (129)
F2048xxSy	48	0.51 (13.0)	117 (174)	600 (2,700)	200 (890)	10.2 (259)	5.1 (129)
F2072xxSy	72	0.58 (15.0)	150 (223)	600 (2,700)	200 (890)	11.6 (295)	5.8 (147)
F2096xxSy	96	0.58 (15.0)	150 (223)	600 (2,700)	200 (890)	11.6 (295)	5.8 (147)

## FIBER TYPES:

### SINGLE MODE

	Reduced Water Peak	Zero Water Peak	TeraFlex® Bend Resistant				
			G.657.A1	G.657.A2	G.657.B3	NZDS	LEAF
<sup>1</sup> For ≤ 12 fibers replace "xx" with:	36	26	K6	J6	L6	86	S6
<sup>1</sup> For > 12 fibers replace "xx" with:	31	21	K1	J1	L1	81	S1

### MULTIMODE

TeraGain®	TeraFlex Bend Resistant Laser Optimized 50/125		
62.5/125	10G/150	10G/300	10G/550
6G	MG	NG	PG

See "Optical Fiber Specifications" in the "Technical Info" section for detailed fiber type specifications.

## WATER BLOCK AND JACKET PRINT CODES

	Dry core		Dry core special	
	Feet	Meters	Feet	Meters
<sup>1</sup> Replace "y" with:	1	2	5	6

# Flex Tube Locate

Series FM

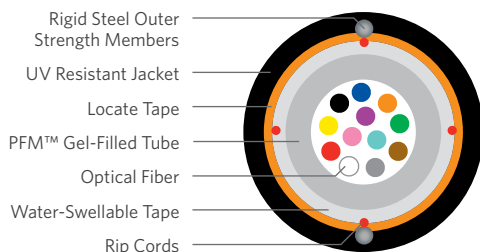

Rigid Steel Outer Strength Members  
UV Resistant Jacket  
Locate Tape  
PFM™ Gel-Filled Tube  
Optical Fiber  
Water-Swellable Tape  
Rip Cords

## SPECIFICATIONS

<b>Fiber Count</b>	Available in 6-fiber up to 96-fiber
<b>Standards Compliance</b>	Telcordia® GR-20-CORE ICEA S-87-640-2011 RoHS-compliant

Telcordia is a registered trademark of Ericsson Inc.

## ENVIRONMENTAL SPECIFICATIONS

<b>Operation/Storage</b>	-40°C to +70°C
<b>Installation</b>	-30°C to +70°C

## PART NUMBER KEY

F	M	-	-	-	x	1	S	y
1	2	3	4	5	6	7	8	9
Product family	Fiber count (006-096)			Fiber type	Internal designator	Water block/marking (1-8)		

Contact Customer Service for availability of non-standard offerings.

## PART NUMBERS AND PHYSICAL CHARACTERISTICS

Part Number <sup>1</sup>	Fiber Count	Nominal Diameter in (mm)	Approx. Weight lbs/kft (kg/km)	Maximum Tensile Loading		Minimum Bend Radius	
				Install lbs (N)	Long Term lbs (N)	Install in (mm)	Long Term in (mm)
FM006x1Sy	6	0.51 (12.9)	111 (165)	600 (2,700)	200 (890)	10.2 (258)	5.1 (129)
FM012x1Sy	12	0.51 (12.9)	111 (165)	600 (2,700)	200 (890)	10.2 (258)	5.1 (129)
FM024x1Sy	24	0.51 (12.9)	111 (165)	600 (2,700)	200 (890)	10.2 (258)	5.1 (129)
FM036x1Sy	36	0.51 (12.9)	111 (165)	600 (2,700)	200 (890)	10.2 (258)	5.1 (129)
FM048x1Sy	48	0.51 (12.9)	111 (165)	600 (2,700)	200 (890)	10.2 (258)	5.1 (129)
FM072x1Sy	72	0.59 (14.9)	131 (195)	600 (2,700)	200 (890)	11.8 (298)	5.9 (149)
FM096x1Sy	96	0.59 (14.9)	131 (195)	600 (2,700)	200 (890)	11.8 (298)	5.9 (149)

## FIBER TYPES:

### SINGLE MODE

Reduced Water Peak	Zero Water Peak	TeraFlex® Bend Resistant			NZDS	LEAF
		G.657.A1	G.657.A2	G.657.B3	8	S

<sup>1</sup>Replace "x" with:

3	2	K	J	L	8	S
---	---	---	---	---	---	---

### MULTIMODE

TeraGain®	TeraFlex Bend Resistant Laser Optimized 50/125		
62.5/125	10G/150	10G/300	10G/550

6	M	N	P
---	---	---	---

See "Optical Fiber Specifications" in the "Technical Info" section for detailed fiber type specifications.

## WATER BLOCK AND JACKET PRINT CODES

Dry core		Dry core special	
Feet	Meters	Feet	Meters

<sup>1</sup>Replace "y" with: 1 2 5 6

## PRODUCT DESCRIPTION

Flex Tube Locate cables are designed to offer low resistivity (less than 10 Ohms per mile) and are for use in long distance remote location systems. These cables make use of a highly flexible tube that contains up to 8 loose optical fiber bundles, each containing 12 optical fibers. PFM™ gel is used inside the tube to reduce the time needed to access the fibers. The core is wrapped with a water-swellable tape to block water flow. A copper metallic locatable tape is applied and then encased in a black, UV resistant outer jacket of HDPE. Ripcords are included under the tape for ease of access to the core tube.

## APPLICATIONS

- Direct bury, underground duct and lashed aerial
- Trunk, distribution and feeder cable
- Local loop, metro, long-haul and broadband network

## FEATURES

- Available with up to 96-fiber
- Multiple fiber types
- Metallic outer strength members
- Dry (SAP) core standard
- Highly flexible
- Small cable diameter
- Fewer cable components
- Less than 10 Ohms/mile resistivity
- PFM gel

## BENEFITS

- High fiber density
- Multiple network applications
- Offers ease of location
- Reduces cable prep and installation time
- Easy handling
- Installation of more fibers in less space
- Reduces cost
- Remote locate system
- Non-sticky gel speeds fiber access and clean-up

## PRODUCT DESCRIPTION

Ribbon Locate cables are designed to offer low resistivity (less than 10 Ohms per mile) and are for use in long distance remote location systems. These cables make use of a highly flexible tube that contains up to 18 ribbons, each containing 12 optical fibers. PFM™ gel is used in the tube to reduce the time needed to access the fibers. The core is wrapped with a water-swellaable yarns to block water flow. A copper metallic locatable tape is applied and then encased in a black UV resistant outer jacket of HDPE. Ripcords are included under the tape for ease of access to the core tube.

## APPLICATIONS

- Direct bury
- Broadband network
- Local loop
- Trunk, distribution and feeder cables

## FEATURES

- Available with up to 216-fiber
- Multiple fiber types available
- Metallic outer strength members
- Highly flexible tube
- Less than 10 Ohms/mile resistivity
- Ribbon fiber
- Meets or exceeds Telcordia® specifications
- PFM gel

## BENEFITS

- High fiber density
- Multiple network applications
- Metallic design offers easy location
- Easy handling and easy tube access
- Remote locate system
- Saves labor cost by offering mass fusion splicing
- Industry approved
- Non-sticky gel allows for easier and faster clean up

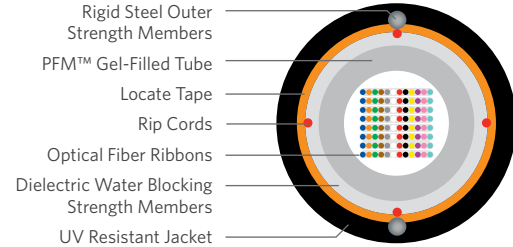

## SPECIFICATIONS

<b>Fiber Count</b>	Available in 60-fiber up to 216-fiber
<b>Standards Compliance</b>	Telcordia® GR-20-CORE ICEA S-87-640-2011 RoHS-compliant

Telcordia is a registered trademark of Ericsson Inc.

## ENVIRONMENTAL SPECIFICATIONS

<b>Operation/Storage</b>	-40°C to +70°C
<b>Installation</b>	-30°C to +70°C

## PART NUMBER KEY

R	M	-	-	-	x	1	S	y
1	2	3	4	5	6	7	8	9
Product family	Fiber count (060-216)				Fiber type	Internal designator	Water block/markings (1-8)	

Contact Customer Service for availability of non-standard offerings.

## PART NUMBERS AND PHYSICAL CHARACTERISTICS

Part Number <sup>1</sup>	Fiber Count	Nominal Diameter in (mm)	Nominal Weight lbs/kft (kg/km)	Maximum Tensile Loading		Minimum Bend Radius	
				Install lbs (N)	Long Term lbs (N)	Install in (mm)	Long Term in (mm)
RM060x1Sy	60	0.58 (15.0)	150 (223)	600 (2,700)	200 (890)	11.6 (295)	5.8 (147)
RM072x1Sy	72	0.58 (15.0)	150 (223)	600 (2,700)	200 (890)	11.6 (295)	5.8 (147)
RM096x1Sy	96	0.58 (15.0)	150 (223)	600 (2,700)	200 (890)	11.6 (295)	5.8 (147)
RM144x1Sy	144	0.66 (17.0)	187 (279)	600 (2,700)	200 (890)	13.2 (335)	6.0 (152)
RM192x1Sy	192	0.66 (17.0)	195 (290)	600 (2,700)	200 (890)	13.6 (345)	6.8 (173)
RM216x1Sy	216	0.66 (17.0)	195 (290)	600 (2,700)	200 (890)	13.6 (345)	6.8 (173)

## FIBER TYPES:

## SINGLE MODE

Reduced Water Peak	Zero Water Peak	TeraFlex® Bend Resistant G.657.A1	NZDS	LEAF
--------------------	-----------------	-----------------------------------	------	------

<sup>1</sup>Replace "x" with:

3	2	K	8	S
---	---	---	---	---

See "Optical Fiber Specifications" in the "Technical Info" section for detailed fiber type specifications.

## WATER BLOCK AND JACKET PRINT CODES

	Dry core		Dry core special	
	Feet	Meters	Feet	Meters
<sup>1</sup> Replace "y" with:	1	2	5	6

# Loose Tube Single Jacket All Dielectric Nylon

Series 1NY

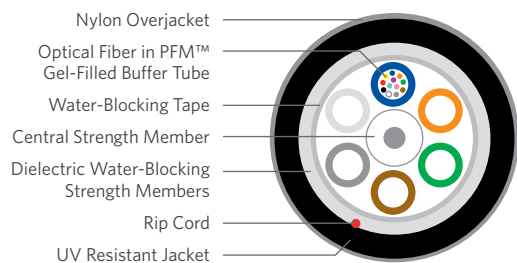

## PRODUCT DESCRIPTION

Loose tube cables are the product of choice as the backbone in Outside Plant (OSP) environments. The durable loose tube design offers reliable transmission performance over a broad temperature range. Optical fibers are placed inside filled buffer tubes containing PFM™ gel. The core is constructed by stranding the buffer tubes around a central member using a reverse oscillating lay (ROL). The core is wrapped with flexible strength members covered with a water-blocking tape, then encased with a black jacket. A rip cord is included under the jacket for ease of entry. The nylon overjacket completes the cable.

## APPLICATIONS

- Underground duct and lashed aerial
- Trunk, distribution and feeder cable
- Local loop, metro, long-haul and broadband network

## SPECIFICATIONS

<b>Fiber Count</b>	Available in 6-fiber up to 288-fiber
<b>Standards Compliance</b>	Telcordia® GR-20-CORE RDUP PE-90 Designation MLT ICEA S-87-640-2011 RoHS-compliant

Telcordia is a registered trademark of Ericsson Inc.

## ENVIRONMENTAL SPECIFICATIONS

<b>Operation/Storage</b>	-40°C to +70°C
<b>Installation</b>	-30°C to +70°C

## PART NUMBER KEY

1	2	-	-	-	x	N	0	y
1	2	3	4	5	6	7	8	9
Product family	Fiber count (006-288)			Fiber type	Internal designator	Water block/marking (1-8)		

Contact Customer Service for availability of non-standard offerings.

## PART NUMBERS AND PHYSICAL CHARACTERISTICS

Part Number <sup>1</sup>	Fiber Count	Nominal Diameter in (mm)	Approx. Weight lbs/kft (kg/km)	Maximum Tensile Loading		Minimum Bend Radius	
				Install lbs (N)	Long Term lbs (N)	Install in (mm)	Long Term in (mm)
11006xN0y	6	0.49 (12.4)	70 (105)	600 (2,700)	200 (890)	9.8 (248)	4.9 (124)
11012xN0y	12	0.49 (12.4)	70 (105)	600 (2,700)	200 (890)	9.8 (248)	4.9 (124)
11024xN0y	24	0.49 (12.4)	70 (105)	600 (2,700)	200 (890)	9.8 (248)	4.9 (124)
11036xN0y	36	0.49 (12.4)	70 (105)	600 (2,700)	200 (890)	9.8 (248)	4.9 (124)
11048xN0y	48	0.49 (12.4)	70 (105)	600 (2,700)	200 (890)	9.8 (248)	4.9 (124)
11072xN0y	72	0.53 (13.5)	86 (129)	600 (2,700)	200 (890)	10.6 (270)	5.3 (135)
11096xN0y	96	0.61 (15.4)	107 (160)	600 (2,700)	200 (890)	12.2 (308)	6.1 (154)
11144xN0y	144	0.75 (19.0)	162 (241)	600 (2,700)	200 (890)	15.0 (380)	7.5 (190)
11216xN0y	216	0.78 (19.8)	161 (239)	600 (2,700)	200 (890)	15.6 (396)	7.8 (198)
11288xN0y	288	0.87 (22.0)	203 (302)	600 (2,700)	200 (890)	17.4 (440)	8.7 (220)

## FIBER TYPES:

### SINGLE MODE

Reduced Water Peak		Zero Water Peak		TeraFlex® Bend Resistant			NZDS	LEAF
G.657.A1	G.657.A2	G.657.B3						
3	2	K	J	L		8	S	

<sup>1</sup>Replace "x" with:

### MULTIMODE

TeraGain®	TeraFlex Bend Resistant Laser Optimized 50/125		
62.5/125	10G/150	10G/300	10G/550
6	M	N	P

See "Optical Fiber Specifications" in the "Technical Info" section for detailed fiber type specifications.

## WATER BLOCK AND JACKET PRINT CODES

Dry core		Dry core special	
Feet	Meters	Feet	Meters
1	2	5	6

<sup>1</sup>Replace "y" with:



# Dri-Lite® Loose Tube Indoor/Outdoor

OFNR Series 13D

## PRODUCT DESCRIPTION

Loose tube riser cables are ideal for campus environments, private networks and local area networks. These dual purpose cables save money and installation time by allowing a direct transition from indoor to outdoor applications with a single cable. Because these cables are fully water blocked with dry elements, stripping and termination is faster. These cables comply with the standards for both Outside Plant (OSP) and indoor riser applications. The loose tube design offers reliable transmission performance over a broad temperature range. The durable loose tube design features optical fibers placed inside gel-free buffer tubes. The core is constructed by stranding the buffer tubes around a central member using a reverse oscillating lay (ROL). It is wrapped with flexible strength members, covered with a heat resistant, water-blocking tape and then encased with a black, flame and sunlight resistant jacket. A rip cord is included under the jacket for ease of entry.

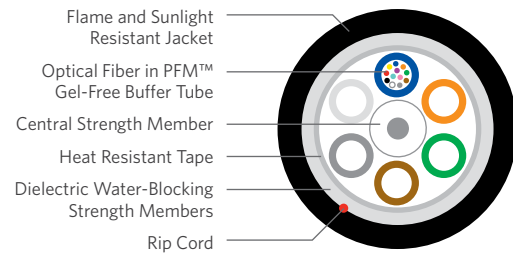

## APPLICATIONS

- Underground duct and lashed aerial
- Trunk, distribution and feeder cable
- Local loop, metro, long-haul and broadband network

## FEATURES

- Available with up to 288-fiber
- Multiple fiber types including composites
- UL Listed, sunlight resistant
- Dielectric outer strength members
- Dry (SAP) core standard
- Standard tube size for all fiber counts
- Transitions from indoor to outdoor to indoor with no termination
- Gel-free

## BENEFITS

- High fiber density
- Multiple network applications
- Longer cable life
- Eliminates grounding or bonding problems
- Reduces cable prep and installation time
- Reduces the number of tools required
- Reduces labor cost
- Speeds fiber access and clean-up

## SPECIFICATIONS

<b>Fiber Count</b>	Available in 2-fiber up to 288-fiber
<b>Performance Compliance</b>	Telcordia® GR-20-CORE, Issue 3 UL 1666 RoHS-compliant
<b>NRTL Programs</b>	UL, c(UL) Listed OFNR

Telcordia is a registered trademark of Ericsson Inc.

## ENVIRONMENTAL SPECIFICATIONS

<b>Operation/Storage</b>	-40°C to +70°C
<b>Installation</b>	-10°C to +70°C

## PART NUMBER KEY

1	3	_	_	_	x	x	0	y
1	2	3	4	5	6	7	8	9
Product family	Fiber count (006-288)				Fiber type	Internal designator	Water block/ marking (1-8)	

Contact Customer Service for availability of non-standard offerings.

## PART NUMBERS AND PHYSICAL CHARACTERISTICS

Listing	Part Number <sup>1</sup>	Fiber Count	Nominal Diameter in (mm)	Nominal Weight lbs/kft (kg/km)	Maximum Tensile Loading		Minimum Bend Radius	
					Install lbs (N)	Long Term lbs (N)	Install in (mm)	Long Term in (mm)
OFNR	13006xD0y	6	0.45 (11.4)	80 (119)	600 (2,700)	200 (890)	9.0 (228)	4.5 (114)
OFNR	13012xD0y	12	0.45 (11.4)	80 (119)	600 (2,700)	200 (890)	9.0 (228)	4.5 (114)
OFNR	13018xD0y	18	0.45 (11.4)	80 (119)	600 (2,700)	200 (890)	9.0 (228)	4.5 (114)
OFNR	13024xD0y	24	0.45 (11.4)	80 (119)	600 (2,700)	200 (890)	9.0 (228)	4.5 (114)
OFNR	13036xD0y	36	0.45 (11.4)	80 (119)	600 (2,700)	200 (890)	9.0 (228)	4.5 (114)
OFNR	13048xD0y	48	0.45 (11.4)	80 (119)	600 (2,700)	200 (890)	9.0 (228)	4.5 (114)
OFNR	13072xD0y	72	0.48 (12.0)	93 (138)	600 (2,700)	200 (890)	9.6 (240)	4.8 (120)
OFNR	13096xD0y	96	0.54 (13.8)	120 (179)	600 (2,700)	200 (890)	10.8 (276)	5.4 (138)
OFNR	13144xD0y	144	0.68 (17.1)	184 (275)	600 (2,700)	200 (890)	13.6 (342)	6.8 (171)
OFNR	13216xD0y	216	0.68 (17.1)	168 (251)	600 (2,700)	200 (890)	13.6 (342)	6.8 (171)
OFNR	13288xD0y	288	0.79 (20.0)	221 (330)	600 (2,700)	200 (890)	15.8 (400)	7.9 (200)

## FIBER TYPES:

### SINGLE MODE

Reduced Water Peak	Zero Water Peak	TeraFlex® Bend Resistant				
		G.657.A1	G.657.A2	G.657.B3	NZDS	LEAF
3	2	K	J	L	8	S

<sup>1</sup>Replace "x" with:

See "Optical Fiber Specifications" in the "Technical Info" section for detailed fiber type specifications.

### MULTIMODE

TeraGain®	TeraFlex Bend Resistant Laser Optimized 50/125		
62.5/125	10G/150	10G/300	10G/550
6	M	N	P

## WATER BLOCK AND JACKET PRINT CODES

	Dry core		Dry core special	
	Feet	Meters	Feet	Meters
<sup>1</sup> Replace "y" with:	1	2	5	6

# Loose Tube Indoor/Outdoor

OFNR Series 13

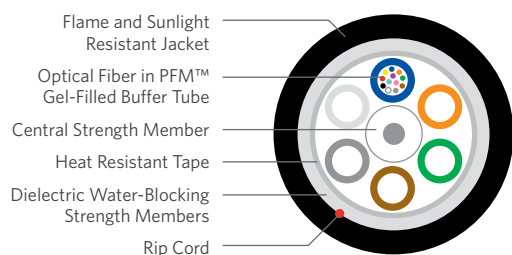

## PRODUCT DESCRIPTION

Loose tube riser cables are ideal for campus environments, private networks and local area networks. These dual purpose cables save money and installation time by allowing a direct transition from indoor to outdoor applications with a single cable. Because these cables are fully water blocked with dry elements, stripping and termination is faster. These cables comply with the standards for both Outside Plant (OSP) and indoor riser applications. The loose tube design offers reliable transmission performance over a broad temperature range. The durable loose tube design features optical fibers placed inside PFM™ gel-filled buffer tubes. The core is constructed by stranding the buffer tubes around a central member using a reverse oscillating lay (ROL). It is wrapped with flexible strength members, covered with a heat resistant, water-blocking tape and then encased with a black, flame and sunlight resistant jacket. A rip cord is included under the jacket for ease of entry.

## SPECIFICATIONS

<b>Fiber Count</b>	Available in 6-fiber up to 288-fiber
<b>Performance Compliance</b>	Telcordia® GR-20-CORE, Issue 3 UL® 1666 RoHS-compliant
<b>NRTL Programs</b>	UL, c(UL) Listed OFNR

Telcordia is a registered trademark of Ericsson Inc. UL is a registered trademark of UL LLC.

## ENVIRONMENTAL SPECIFICATIONS

<b>Operation/Storage</b>	-40°C to +70°C
<b>Installation</b>	-10°C to +70°C

## PART NUMBER KEY

1	3	—	—	—	x	x	0	y
1	2	3	4	5	6	7	8	9
Product family	Fiber count (006-288)	Fiber type	Internal designator	Water block/ marking (1-8)				

Contact Customer Service for availability of non-standard offerings.

## APPLICATIONS

- Underground duct and lashed aerial
- Trunk, distribution and feeder cable
- Local loop, metro, long-haul and broadband network

## FEATURES

- Available with up to 288-fiber
- Multiple fiber types including composites
- UL Listed, sunlight resistant
- Dielectric outer strength members
- Dry (SAP) core standard
- Standard tube size for all fiber counts
- Transitions from indoor to outdoor to indoor with no termination
- PFM gel

## BENEFITS

- High fiber density
- Multiple network applications
- Longer cable life
- Eliminates grounding or bonding problems
- Reduces cable prep and installation time
- Reduces the number of tools required
- Reduces labor cost
- Non-sticky gel speeds fiber access and clean-up

## PART NUMBERS AND PHYSICAL CHARACTERISTICS

Listing	Part Number <sup>1</sup>	Fiber Count	Nominal Diameter in (mm)	Nominal Weight lbs/kft (kg/km)	Maximum Tensile Loading		Minimum Bend Radius	
					Install lbs (N)	Long Term lbs (N)	Install in (mm)	Long Term in (mm)
OFNR	13006xx0y	6	0.45 (11.4)	80 (119)	600 (2,700)	200 (890)	9.0 (228)	4.5 (114)
OFNR	13012xx0y	12	0.45 (11.4)	80 (119)	600 (2,700)	200 (890)	9.0 (228)	4.5 (114)
OFNR	13024xx0y	24	0.45 (11.4)	80 (119)	600 (2,700)	200 (890)	9.0 (228)	4.5 (114)
OFNR	13036xx0y	36	0.45 (11.4)	80 (119)	600 (2,700)	200 (890)	9.0 (228)	4.5 (114)
OFNR	13048xx0y	48	0.45 (11.4)	80 (119)	600 (2,700)	200 (890)	9.0 (228)	4.5 (114)
OFNR	13072xx0y	72	0.48 (12.0)	93 (138)	600 (2,700)	200 (890)	9.6 (240)	4.8 (120)
OFNR	13096xx0y	96	0.54 (13.8)	120 (179)	600 (2,700)	200 (890)	10.8 (276)	5.4 (138)
OFNR	13144xx0y	144	0.68 (17.1)	184 (275)	600 (2,700)	200 (890)	13.6 (342)	6.8 (171)
OFNR	13216xx0y	216	0.68 (17.1)	168 (251)	600 (2,700)	200 (890)	13.6 (342)	6.8 (171)
OFNR	13288xx0y	288	0.79 (20.0)	221 (330)	600 (2,700)	200 (890)	15.8 (400)	7.9 (200)

## FIBER TYPES:

## SINGLE MODE

Reduced Water Peak	Zero Water Peak	TeraFlex® Bend Resistant			NZDS	LEAF	
		G.657.A1	G.657.A2	G.657.B3			
<sup>1</sup> For ≤ 36 fibers replace "xx" with:	3T	2T	KT	JT	LT	8T	ST
<sup>1</sup> For > 36 fibers replace "xx" with:	31	21	K1	J1	L1	81	S1

## MULTIMODE

TeraGain® 62.5/125	TeraFlex Bend Resistant Laser Optimized 50/125		
	10G/150	10G/300	10G/550
6G	MG	NG	PG

See "Optical Fiber Specifications" in the "Technical Info" section for detailed fiber type specifications.

## WATER BLOCK AND JACKET PRINT CODES

	Dry core		Dry core special	
	Feet	Meters	Feet	Meters
<sup>1</sup> Replace "y" with:	1	2	5	6

### PRODUCT DESCRIPTION

Interlock Armored Optical Fiber Cables provide for an extremely well protected cable package ideally suited for harsh environments. The armor is available in aluminum and comes with an OFCR (riser) rating. This design offers the system designer a product that can be installed in high traffic areas where added mechanical protection and security are required. The flexible interlock armored cable design is also popular for retrofit applications and eliminates the need to install rigid conduit while still meeting building code guidelines.

### APPLICATIONS

- Intrabuilding backbones
- Conduit pathways
- Service entrance to communication closets

### FEATURES

- Thick, flexible metallic armor
- Flame retardant, UL Listed designs
- Full line of Superior Essex cables available

### BENEFITS

- Reduce incidences of circuit disruption due to rodents or mechanically abusive applications
- Eliminates the need for multiple cables for installation
- Customized designs reduces cable inventory requirements

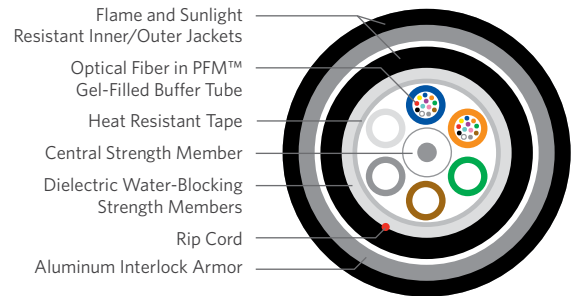

### SPECIFICATIONS

<b>Fiber Count</b>	Available in 6-fiber up to 144-fiber
<b>Core Configuration</b>	Loose Tube Indoor/Outdoor OFNR Series 13 cable
<b>Interlock Armored</b>	Flexible, heavy duty interlocking aluminum tape helically applied over the inner cable core; further protection is provided by an optional outer jacket
<b>Outer Jacket</b>	Black, flame retardant, chemical resistant and sunlight resistant PVC
<b>Performance Compliance</b>	UL® 1569 Telcordia® GR-20-CORE, Issue 2 UL 1666 RoHS-compliant
<b>NRTL Programs</b>	UL, c(UL) Listed OFCR

UL is a registered trademark of UL LLC. Telcordia is a registered trademark of Ericsson Inc.

### ENVIRONMENTAL SPECIFICATIONS

<b>Operation/Storage</b>	-40°C to +70°C
<b>Installation</b>	-10°C to +70°C

### PART NUMBER KEY

L	3	_	_	_	x	1	0	y
1	2	3	4	5	6	7	8	9
Product family	Fiber count (006-144)				Fiber type	Internal designator	Water block/markings (1-8)	

Contact Customer Service for availability of non-standard offerings.

### PART NUMBERS AND PHYSICAL CHARACTERISTICS

Listing	Part Number <sup>1</sup>	Fiber Count	Nominal Diameter in (mm)	Nominal Weight lbs/kft (kg/km)	Maximum Tensile Loading		Minimum Bend Radius	
					Install lbs (N)	Long Term lbs (N)	Install in (mm)	Long Term in (mm)
OFNR	L3006x10y	6	0.96 (24.3)	301 (448)	600 (2,700)	200 (890)	14.5 (367)	9.6 (243)
OFNR	L3012x10y	12	0.96 (24.3)	301 (448)	600 (2,700)	200 (890)	14.5 (367)	9.6 (243)
OFNR	L3024x10y	24	0.96 (24.3)	301 (448)	600 (2,700)	200 (890)	14.5 (367)	9.6 (243)
OFNR	L3048x10y	48	0.96 (24.3)	301 (448)	600 (2,700)	200 (890)	14.5 (367)	9.6 (243)
OFNR	L3072x10y	72	1.01 (25.5)	316 (470)	600 (2,700)	200 (890)	15.2 (383)	10.1 (255)
OFNR	L3096x10y	96	1.07 (27.1)	346 (515)	600 (2,700)	200 (890)	16.1 (406)	10.7 (271)
OFNR	L3144x10y	144	1.20 (30.8)	424 (631)	600 (2,700)	200 (890)	18.3 (463)	12.2 (308)

### FIBER TYPES:

#### SINGLE MODE

Reduced Water Peak		Zero Water Peak	TeraFlex® Bend Resistant				
3	2	K	J	L	8	S	
			G.657.A1	G.657.A2	G.657.B3	NZDS	LEAF

<sup>1</sup>Replace "x" with:

#### MULTIMODE

TeraGain® 62.5/125	TeraFlex Bend Resistant Laser Optimized 50/125		
6	M	N	P
	10G/150	10G/300	10G/550

See "Optical Fiber Specifications" in the "Technical Info" section for detailed fiber type specifications.

### WATER BLOCK AND JACKET PRINT CODES

	Dry core		Dry core special	
	Feet	Meters	Feet	Meters
<sup>1</sup> Replace "y" with:	1	2	5	6

# Dri-Lite® Loose Tube Single Jacket All Dielectric I/O LSZH

Series HZD

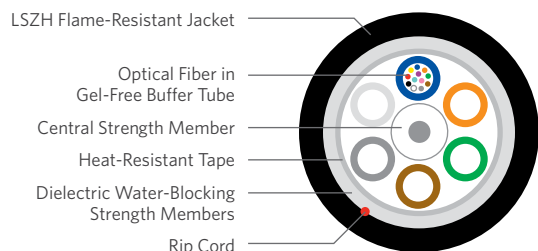

## PRODUCT DESCRIPTION

Low Smoke Zero Halogen cables are ideal for indoor/outdoor applications such as campus environments, tunnels and subway passages. Series HZD cables comply with NFPA-130, UL 1666 and are rated OFNR-LS. These dual purpose cables save money and installation time by allowing a direct transition from indoor to outdoor applications with a single cable. Because these cables are fully water blocked with dry elements, stripping and termination is faster. These cables comply with the standards for both Outside Plant (OSP) and indoor riser applications. The loose tube design offers reliable transmission performance over a broad temperature range. The durable, loose tube design features optical fibers placed inside gel-free buffer tubes which are stranded around a central member. The core is wrapped with flexible strength members, covered with a heat-resistant, water-blocking tape and then encased with a black, flame and sunlight-resistant jacket. A rip cord is included under the jacket for ease of entry.

## APPLICATIONS

- Underground duct and lashed aerial
- Campus environment
- Tunnels, subways, rapid rail

## FEATURES

- Available with up to 288-fiber
- Multiple fiber types including composites
- UL Listed, sunlight resistant
- Transitions from indoor to outdoor to indoor with no termination
- Gel free

## BENEFITS

- High fiber density
- Multiple network applications
- Longer cable life
- Reduces labor cost
- Speeds fiber access and cleanup

## SPECIFICATIONS

Fiber Count	Available in 6-fiber up to 288-fiber
Performance Compliance	Telcordia® GR-20-CORE NFPA-130 UL® 1666 UL 1685 RoHS-compliant
NRTL Programs	UL, c(UL) Listed OFNR

Telcordia is a registered trademark of Ericsson Inc. UL is a registered trademark of UL LLC.

## ENVIRONMENTAL SPECIFICATIONS

Operation/Storage	-40°C to +70°C
Installation	-30°C to +70°C

## PART NUMBER KEY

F	H	1	6	-	-	-	-	x	x	x	-	E	9	9	1 or 2	
1	2	3	4	5	6	7	8	9	10	11	12	13	14	15	16	
Fiber cable	Cable type			-	Fiber count (006-288)				Fiber type			-	Jacket color	Package		Jacket print

Contact Customer Service for availability of non-standard offerings.

## PART NUMBERS AND PHYSICAL CHARACTERISTICS

Listing	Part Number <sup>1</sup>	Fiber Count	Nominal Diameter in (mm)	Nominal Weight lbs/kft (kg/km)	Maximum Tensile Loading		Minimum Bend Radius	
					Install lbs (N)	Long Term lbs (N)	Install in (mm)	Long Term in (mm)
OFNR-LS	FH16-006xxx-E99y	6	0.47 (11.8)	92 (137)	600 (2,700)	200 (890)	9.4 (236)	4.7 (118)
OFNR-LS	FH16-012xxx-E99y	12	0.47 (11.8)	92 (137)	600 (2,700)	200 (890)	9.4 (236)	4.7 (118)
OFNR-LS	FH16-024xxx-E99y	24	0.47 (11.8)	92 (137)	600 (2,700)	200 (890)	9.4 (236)	4.7 (118)
OFNR-LS	FH16-036xxx-E99y	36	0.47 (11.8)	92 (137)	600 (2,700)	200 (890)	9.4 (236)	4.7 (118)
OFNR-LS	FH16-048xxx-E99y	48	0.47 (11.8)	92 (137)	600 (2,700)	200 (890)	9.4 (236)	4.7 (118)
OFNR-LS	FH16-060xxx-E99y	60	0.47 (11.8)	92 (137)	600 (2,700)	200 (890)	9.4 (236)	4.7 (118)
OFNR-LS	FH16-072xxx-E99y	72	0.49 (11.9)	106 (158)	600 (2,700)	200 (890)	9.8 (239)	4.9 (119)
OFNR-LS	FH16-096xxx-E99y	96	0.56 (12.4)	124 (185)	600 (2,700)	200 (890)	11.2 (249)	5.6 (124)
OFNR-LS	FH16-144xxx-E99y	144	0.69 (14.2)	169 (252)	600 (2,700)	200 (890)	13.8 (284)	6.9 (142)
OFNR-LS	FH16-216xxx-E99y	216	0.69 (14.2)	169 (252)	600 (2,700)	200 (890)	13.8 (284)	6.9 (142)
OFNR-LS	FH16-288xxx-E99y	288	0.97 (20.0)	207 (309)	600 (2,700)	200 (890)	19.4 (400)	9.7 (200)

## FIBER TYPES:

### SINGLE MODE

Reduced Water Peak	Corning® RWP	Zero Water Peak	TeraFlex® Bend Resistant				
			G.657.A1	G.657.A2	G.657.B3	NZDS	LEAF

<sup>1</sup>Replace "xxx" with:

U10	C10	U17	U13	U14	U15	U19	C19
-----	-----	-----	-----	-----	-----	-----	-----

### MULTIMODE

TeraFlex Bend Resistant Laser Optimized 50/125				
TeraGain®	62.5/125	10G/150	10G/300	10G/550

U23	U28	U30	U32
-----	-----	-----	-----

See "Optical Fiber Specifications" in the "Technical Info" section for detailed fiber type specifications.

## JACKET PRINT

Feet      Meters

<sup>1</sup>Replace "y" with:

1	2
---	---

# Dri-Lite® Loose Tube Single Jacket Single Armor I/O LSZH

Series HZA

## PRODUCT DESCRIPTION

Low Smoke Zero Halogen cables are ideal for indoor/outdoor applications such as campus environments, tunnels and subway passages. Series HZA cables comply with NFPA-130, UL 1666 and are rated OFCR-LS. These dual purpose cables save money and installation time by allowing a direct transition from indoor to outdoor applications with a single cable. Because these cables are fully water blocked with dry elements, stripping and termination is faster. These cables comply with the standards for both Outside Plant (OSP) and indoor riser applications. The loose tube design offers reliable transmission performance over a broad temperature range. The durable, loose tube design features optical fibers placed inside gel-free buffer tubes which are stranded around a central member. The core is wrapped with flexible strength members, covered with a heat-resistant, water-blocking tape, corrugated steel armor and then encased with a black, flame and sunlight-resistant jacket. A rip cord is included under the jacket for ease of entry.

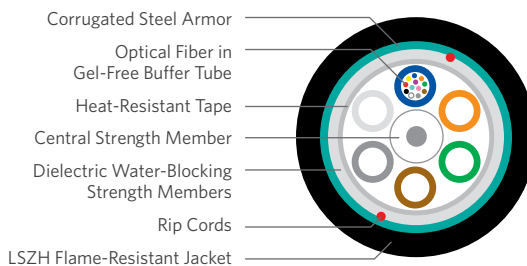

## APPLICATIONS

- Direct bury, underground duct and lashed aerial
- Campus environment
- Tunnels, subways, rapid rail

## FEATURES

- Available with up to 288-fiber
- Multiple fiber types including composites
- UL Listed, sunlight resistant
- Transitions from indoor to outdoor to indoor with no termination
- Gel free

## BENEFITS

- High fiber density
- Multiple network applications
- Longer cable life
- Reduces labor cost
- Speeds fiber access and cleanup

## SPECIFICATIONS

<b>Fiber Count</b>	Available in 6-fiber up to 288-fiber
<b>Performance Compliance</b>	Telcordia® GR-20-CORE NFPA-130 UL® 1666 UL 1685 RoHS-compliant
<b>NRTL Programs</b>	UL, c(UL) Listed OFNR

Telcordia is a registered trademark of Ericsson Inc. UL is a registered trademark of UL LLC. Corning is a registered trademark of Corning Incorporated.

## ENVIRONMENTAL SPECIFICATIONS

<b>Operation/Storage</b>	-40°C to +70°C
<b>Installation</b>	-30°C to +70°C

## PART NUMBER KEY

F	H	2	5	-	-	-	-	x	x	x	-	E	9	9	1 or 2	
1	2	3	4	5	6	7	8	9	10	11	12	13	14	15	16	
Fiber cable	Cable type			-	Fiber count (006-288)				Fiber type			-	Jacket color	Package		Jacket print

Contact Customer Service for availability of non-standard offerings.

## PART NUMBERS AND PHYSICAL CHARACTERISTICS

Listing	Part Number <sup>1</sup>	Fiber Count	Nominal Diameter in (mm)	Nominal Weight lbs/kft (kg/km)	Maximum Tensile Loading		Minimum Bend Radius	
					Install lbs (N)	Long Term lbs (N)	Install in (mm)	Long Term in (mm)
OFCR-LS	FH25-006xxx-E99y	6	0.52 (13.2)	129 (192)	600 (2,700)	200 (890)	10.4 (264)	5.2 (132)
OFCR-LS	FH25-012xxx-E99y	12	0.52 (13.2)	129 (192)	600 (2,700)	200 (890)	10.4 (264)	5.2 (132)
OFCR-LS	FH25-024xxx-E99y	24	0.52 (13.2)	129 (192)	600 (2,700)	200 (890)	10.4 (264)	5.2 (132)
OFCR-LS	FH25-036xxx-E99y	36	0.52 (13.2)	129 (192)	600 (2,700)	200 (890)	10.4 (264)	5.2 (132)
OFCR-LS	FH25-048xxx-E99y	48	0.52 (13.2)	129 (192)	600 (2,700)	200 (890)	10.4 (264)	5.2 (132)
OFCR-LS	FH25-060xxx-E99y	60	0.52 (13.2)	129 (192)	600 (2,700)	200 (890)	10.4 (264)	5.2 (132)
OFCR-LS	FH25-072xxx-E99y	72	0.55 (14.0)	129 (192)	600 (2,700)	200 (890)	11.0 (279)	5.5 (140)
OFCR-LS	FH25-096xxx-E99y	96	0.62 (15.7)	145 (216)	600 (2,700)	200 (890)	12.4 (315)	6.2 (157)
OFCR-LS	FH25-144xxx-E99y	144	0.75 (19.0)	170 (254)	600 (2,700)	200 (890)	15.0 (381)	7.5 (191)
OFCR-LS	FH25-216xxx-E99y	216	0.75 (19.0)	170 (254)	600 (2,700)	200 (890)	15.0 (381)	7.5 (191)
OFCR-LS	FH25-288xxx-E99y	288	0.87 (22.0)	288 (430)	600 (2,700)	200 (890)	17.4 (444)	8.7 (220)

## FIBER TYPES:

### SINGLE MODE

Reduced Water Peak	Corning® RWP	Zero Water Peak	TeraFlex® Bend Resistant				
			G.657.A1	G.657.A2	G.657.B3	NZDS	LEAF
U10	C10	U17	U13	U14	U15	U19	C19

<sup>1</sup>Replace "xxx" with:

See "Optical Fiber Specifications" in the "Technical Info" section for detailed fiber type specifications.

### MULTIMODE

TeraGain®	TeraFlex Bend Resistant Laser Optimized 50/125			
	62.5/125	10G/150	10G/300	10G/550
U23	U28	U30	U32	

## JACKET PRINT

Feet      Meters

<sup>1</sup>Replace "y" with:      1      2

# Loose Tube Single Jacket All Dielectric Indoor/Outdoor LSZH

Series HZD

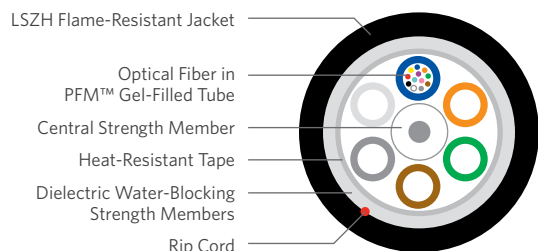

## PRODUCT DESCRIPTION

Low Smoke Zero Halogen cables are ideal for indoor/outdoor applications such as campus environments, tunnels and subway passages. Series HZD cables comply with NFPA-130, UL 1666 and are rated OFNR-LS. These dual purpose cables save money and installation time by allowing a direct transition from indoor to outdoor applications with a single cable. Because these cables are fully water blocked with PFM™ Gel, stripping and termination is faster. These cables comply with the standards for both Outside Plant (OSP) and indoor riser applications. The loose tube design offers reliable transmission performance over a broad temperature range. The durable, loose tube design features optical fibers placed inside PFM Gel-filled buffer tubes which are stranded around a central member. The core is wrapped with flexible strength members, covered with a heat-resistant, water-blocking tape and then encased with a black, flame and sunlight-resistant jacket. A rip cord is included under the jacket for ease of entry.

## SPECIFICATIONS

**Fiber Count** Available in 6-fiber up to 288-fiber

**Performance Compliance** Telcordia® GR-20-CORE  
NFPA-130  
UL® 1666  
UL 1685  
RoHS-compliant

**NRTL Programs** UL, c(UL) Listed OFNR

*Telcordia is a registered trademark of Ericsson Inc. UL is a registered trademark of UL LLC.*

## ENVIRONMENTAL SPECIFICATIONS

**Operation/Storage** -40°C to +70°C

**Installation** -30°C to +70°C

## APPLICATIONS

- Underground duct and lashed aerial
- Campus environment
- Tunnels, subways, rapid rail

## FEATURES

- Available with up to 288-fiber
- Multiple fiber types including composites
- UL Listed, sunlight resistant
- Transitions from indoor to outdoor to indoor with no termination

## BENEFITS

- High fiber density
- Multiple network applications
- Longer cable life
- Reduces labor cost

## PART NUMBER KEY

F	H	1	6	-	-	-	-	x	x	x	-	E	9	9	1 or 2	
1	2	3	4	5	6	7	8	9	10	11	12	13	14	15	16	
Fiber cable		Cable type			-	Fiber count (006-288)			Fiber type			-	Jacket color	Package		Jacket print

Contact Customer Service for availability of non-standard offerings.

## PART NUMBERS AND PHYSICAL CHARACTERISTICS

Listing	Part Number <sup>1</sup>	Fiber Count	Nominal Diameter in (mm)	Nominal Weight lbs/kft (kg/km)	Maximum Tensile Loading		Minimum Bend Radius	
					Install lbs (N)	Long Term lbs (N)	Install in (mm)	Long Term in (mm)
OFNR-LS	FH10-006xxx-E99y	6	0.47 (11.8)	88 (131)	600 (2,700)	200 (890)	9.4 (236)	4.7 (118)
OFNR-LS	FH10-012xxx-E99y	12	0.47 (11.8)	88 (131)	600 (2,700)	200 (890)	9.4 (236)	4.7 (118)
OFNR-LS	FH10-024xxx-E99y	24	0.47 (11.8)	88 (131)	600 (2,700)	200 (890)	9.4 (236)	4.7 (118)
OFNR-LS	FH10-036xxx-E99y	36	0.47 (11.8)	88 (131)	600 (2,700)	200 (890)	9.4 (236)	4.7 (118)
OFNR-LS	FH10-048xxx-E99y	48	0.47 (11.8)	89 (133)	600 (2,700)	200 (890)	9.4 (236)	4.7 (118)
OFNR-LS	FH10-060xxx-E99y	60	0.47 (11.8)	102 (152)	600 (2,700)	200 (890)	9.4 (236)	4.7 (118)
OFNR-LS	FH10-072xxx-E99y	72	0.49 (11.9)	104 (155)	600 (2,700)	200 (890)	9.8 (239)	4.9 (119)
OFNR-LS	FH10-096xxx-E99y	96	0.56 (12.4)	122 (182)	600 (2,700)	200 (890)	11.2 (249)	5.6 (124)
OFNR-LS	FH10-144xxx-E99y	144	0.69 (14.2)	166 (248)	600 (2,700)	200 (890)	13.8 (284)	6.9 (142)
OFNR-LS	FH10-216xxx-E99y	216	0.69 (14.2)	166 (248)	600 (2,700)	200 (890)	13.8 (284)	6.9 (142)
OFNR-LS	FH10-288xxx-E99y	288	0.97 (20.0)	204 (303)	600 (2,700)	200 (890)	19.4 (400)	9.7 (200)

## FIBER TYPES:

### SINGLE MODE

Reduced Water Peak	Corning® RWP	Zero Water Peak	TeraFlex® Bend Resistant			NZDS	LEAF
	U10	C10	U17	U13	U14	U15	U19

<sup>1</sup>Replace "xxx" with:

U10	C10	U17	U13	U14	U15	U19	C19
-----	-----	-----	-----	-----	-----	-----	-----

### MULTIMODE

TeraFlex Bend Resistant Laser Optimized 50/125			
TeraGain®	62.5/125	10G/150	10G/300
	U23	U28	U30

U32

See "Optical Fiber Specifications" in the "Technical Info" section for detailed fiber type specifications.

## JACKET PRINT

Feet Meters

<sup>1</sup>Replace "y" with:

1 2

# Loose Tube Single Jacket Single Armor Indoor/Outdoor LSZH

Series HZA

## PRODUCT DESCRIPTION

Low Smoke Zero Halogen cables are ideal for indoor/outdoor applications such as campus environments, tunnels and subway passages. Series HZA cables comply with NFPA-130, UL 1666 and are rated OFCR-LS. These dual purpose cables save money and installation time by allowing a direct transition from indoor to outdoor applications with a single cable. Because these cables are fully water blocked with PFM™ Gel, stripping and termination is faster. These cables comply with the standards for both Outside Plant (OSP) and indoor riser applications. The loose tube design offers reliable transmission performance over a broad temperature range. The durable, loose tube design features optical fibers placed inside PFM Gel-filled buffer tubes which are stranded around a central member. The core is wrapped with flexible strength members, covered with a heat-resistant, water-blocking tape, corrugated steel armor and then encased with a black, flame and sunlight-resistant jacket. A rip cord is included under the jacket for ease of entry.

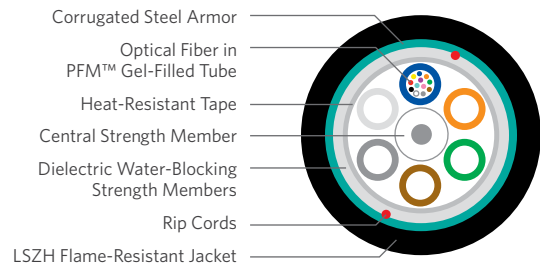

## APPLICATIONS

- Direct bury, underground duct and lashed aerial
- Campus environment
- Tunnels, subways, rapid rail

## FEATURES

- Available with up to 288-fiber
- Multiple fiber types including composites
- UL Listed, sunlight resistant
- Transitions from indoor to outdoor to indoor with no termination

## BENEFITS

- High fiber density
- Multiple network applications
- Longer cable life
- Reduces labor cost

## SPECIFICATIONS

<b>Fiber Count</b>	Available in 6-fiber up to 288-fiber
<b>Performance Compliance</b>	Telcordia® GR-20-CORE NFPA-130 UL® 1666 UL 1685 RoHS-compliant
<b>NRTL Programs</b>	UL, c(UL) Listed OFNR

Telcordia is a registered trademark of Ericsson Inc. UL is a registered trademark of UL LLC. Corning is a registered trademark of Corning Incorporated.

## ENVIRONMENTAL SPECIFICATIONS

<b>Operation/Storage</b>	-40°C to +70°C
<b>Installation</b>	-30°C to +70°C

## PART NUMBER KEY

F	H	2	5	-	-	-	-	x	x	x	-	E	9	9	1 or 2	
1	2	3	4	5	6	7	8	9	10	11	12	13	14	15	16	
Fiber cable	Cable type			-	Fiber count (006-288)				Fiber type			-	Jacket color	Package		Jacket print

Contact Customer Service for availability of non-standard offerings.

## PART NUMBERS AND PHYSICAL CHARACTERISTICS

Listing	Part Number <sup>1</sup>	Fiber Count	Nominal Diameter in (mm)	Nominal Weight lbs/kft (kg/km)	Maximum Tensile Loading		Minimum Bend Radius	
					Install lbs (N)	Long Term lbs (N)	Install in (mm)	Long Term in (mm)
OFCR-LS	FH26-006xxx-E99y	6	0.52 (13.2)	129 (192)	600 (2,700)	200 (890)	10.4 (264)	5.2 (132)
OFCR-LS	FH26-012xxx-E99y	12	0.52 (13.2)	129 (192)	600 (2,700)	200 (890)	10.4 (264)	5.2 (132)
OFCR-LS	FH26-024xxx-E99y	24	0.52 (13.2)	129 (192)	600 (2,700)	200 (890)	10.4 (264)	5.2 (132)
OFCR-LS	FH26-036xxx-E99y	36	0.52 (13.2)	129 (192)	600 (2,700)	200 (890)	10.4 (264)	5.2 (132)
OFCR-LS	FH26-048xxx-E99y	48	0.52 (13.2)	129 (192)	600 (2,700)	200 (890)	10.4 (264)	5.2 (132)
OFCR-LS	FH26-060xxx-E99y	60	0.52 (13.2)	170 (253)	600 (2,700)	200 (890)	10.4 (264)	5.2 (132)
OFCR-LS	FH26-072xxx-E99y	72	0.55 (14.0)	170 (253)	600 (2,700)	200 (890)	11.0 (279)	5.5 (140)
OFCR-LS	FH26-096xxx-E99y	96	0.62 (15.7)	145 (216)	600 (2,700)	200 (890)	12.4 (315)	6.2 (157)
OFCR-LS	FH26-144xxx-E99y	144	0.75 (19.0)	170 (253)	600 (2,700)	200 (890)	15.0 (381)	7.5 (191)
OFCR-LS	FH26-216xxx-E99y	216	0.75 (19.0)	170 (253)	600 (2,700)	200 (890)	15.0 (381)	7.5 (191)
OFCR-LS	FH26-288xxx-E99y	288	0.87 (22.0)	314 (467)	600 (2,700)	200 (890)	17.4 (444)	8.7 (220)

## FIBER TYPES:

### SINGLE MODE

Reduced Water Peak	Corning® RWP	Zero Water Peak	TeraFlex® Bend Resistant				
			G.657.A1	G.657.A2	G.657.B3	NZDS	LEAF
U10	C10	U17	U13	U14	U15	U19	C19

<sup>1</sup>Replace "xxx" with:

See "Optical Fiber Specifications" in the "Technical Info" section for detailed fiber type specifications.

### MULTIMODE

TeraFlex Bend Resistant Laser Optimized 50/125			
TeraGain®	10G/150	10G/300	10G/550
62.5/125	U23	U28	U30
			U32

## JACKET PRINT

	Feet	Meters
<sup>1</sup> Replace "y" with:	1	2

# Single Loose Tube Indoor/Outdoor

OFNR Series 53

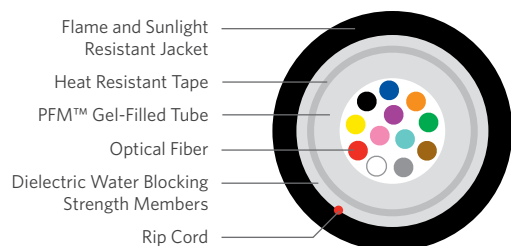

## PRODUCT DESCRIPTION

Loose tube riser cables are ideal for campus environments, private networks and local area networks. These dual purpose cables save money and installation time by allowing a direct transition from indoor to outdoor applications with a single cable. Loose tube cables are the product of choice as the backbone in Outside Plant (OSP) applications. Single Loose tube cables offer a low cost alternative to traditional stranded loose tube cables. The loose tube design offers reliable transmission performance over a broad temperature range. The durable single loose tube design features optical fibers placed inside a single PFM™ gel-filled tube. The core tube includes up to 8-fiber bundles, each containing up to 12 optical fibers bound with a color coded binder. The core tube is then helically wrapped with water-blocking strength members, then encased with a black, flame resistant jacket. A rip cord is included under the jacket to provide ease of access to the core tube.

## APPLICATIONS

- UL Listed sunlight resistant indoor/outdoor
- Lashed aerial, duct or riser
- Inter-building connection
- Campus environments

## FEATURES

- Available with up to 96-fiber
- Multiple fiber types
- UL Listed, sunlight resistant
- Dielectric outer strength members
- Dry (SAP) core standard
- Highly flexible
- Small cable diameter
- Fewer cable components
- Transitions from indoor to outdoor to indoor with no termination
- PFM gel

## BENEFITS

- High fiber density
- Multiple network applications
- Longer cable life
- Eliminates grounding or bonding problems
- Reduces cable prep and installation time
- Easy handling
- Installation of more fibers in less space
- Reduces cost
- Reduces labor cost
- Non-sticky gel speeds fiber access and clean-up

## SPECIFICATIONS

<b>Fiber Count</b>	Available in 6-fiber up to 96-fiber
<b>Performance Compliance</b>	Telcordia® GR-20-CORE, Issue 3 UL® 1666 RoHS-compliant
<b>NRTL Programs</b>	UL, c(UL) Listed OFNR

Telcordia is a registered trademark of Ericsson Inc. UL is a registered trademark of UL LLC.

## ENVIRONMENTAL SPECIFICATIONS

<b>Operation/Storage</b>	-40°C to +70°C
<b>Installation</b>	-10°C to +70°C

## PART NUMBER KEY

5	3	-	-	-	x	x	0	y
1	2	3	4	5	6	7	8	9
Product family	Fiber count (006-096)	Fiber type	Internal designator	Water block/marking (1-8)				

Contact Customer Service for availability of non-standard offerings.

## PART NUMBERS AND PHYSICAL CHARACTERISTICS

Listing	Part Number <sup>1</sup>	Fiber Count	Nominal Diameter in (mm)	Nominal Weight lbs/kft (kg/km)	Maximum Tensile Loading		Minimum Bend Radius	
					Install lbs (N)	Long Term lbs (N)	Install in (mm)	Long Term in (mm)
OFNR	53006xx0y	6	0.30 (7.5)	35 (53)	600 (2,700)	200 (890)	6.0 (150)	3.0 (75)
OFNR	53012xx0y	12	0.30 (7.5)	35 (53)	600 (2,700)	200 (890)	6.0 (150)	3.0 (75)
OFNR	53024xx0y	24	0.37 (9.5)	52 (77)	600 (2,700)	200 (890)	7.4 (190)	3.7 (95)
OFNR	53036xx0y	36	0.37 (9.5)	52 (77)	600 (2,700)	200 (890)	7.4 (190)	3.7 (95)
OFNR	53048xx0y	48	0.37 (9.5)	52 (77)	600 (2,700)	200 (890)	7.4 (190)	3.7 (95)
OFNR	53072xx0y	72	0.50 (12.8)	96 (143)	600 (2,700)	200 (890)	10.0 (256)	5.0 (128)
OFNR	53096xx0y	96	0.50 (12.8)	96 (143)	600 (2,700)	200 (890)	10.0 (256)	5.0 (128)

## FIBER TYPES:

### SINGLE MODE

Reduced Water Peak    Zero Water Peak    TeraFlex® Bend Resistant  
G.657.A1    G.657.A2    G.657.B3

<sup>1</sup>Replace "xx" with:

31    21    K1    J1    L1    81    S1

### MULTIMODE

TeraGain®    TeraFlex Bend Resistant Laser Optimized 50/125  
62.5/125    10G/150    10G/300    10G/550

6G    MG    NG    PG

See "Optical Fiber Specifications" in the "Technical Info" section for detailed fiber type specifications.

## WATER BLOCK AND JACKET PRINT CODES

Dry core    Dry core special  
Feet    Meters    Feet    Meters

<sup>1</sup>Replace "y" with:

1    2    5    6



# Heavy Duty Loose Tube

OFNR Series 1H

## PRODUCT DESCRIPTION

Heavy Duty Loose Tube OFNR Cables are ideally suited for harsh environment applications including mining, steel mills, refineries, lumber mills and many other situations requiring a durable cable construction. These cables have been specifically designed to have greater tensile, crush and impact ratings. With a dual layer of flexible strength members and a double layer of durable flame retardant and sunlight resistant jackets, this cable design possesses features ideal for environmentally demanding applications. The heavy duty loose tube design features optical fibers placed inside PFM™ gel-filled buffer tubes. The core is constructed by stranding the buffer tubes around a central member using reverse oscillating lay (ROL). The core is wrapped with flexible strength members and covered by a water-blocking tape, then encased in a black flame resistant jacket. A second layer of flexible strength members is applied and then encased in a black, flame and sunlight resistant jacket. Rip cords are included under each jacket for ease of entry.

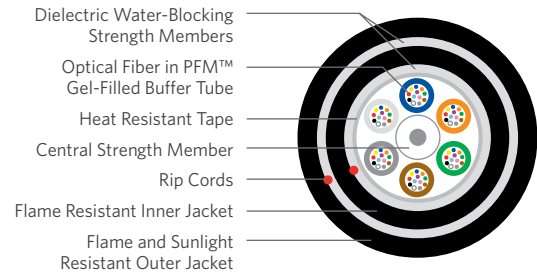
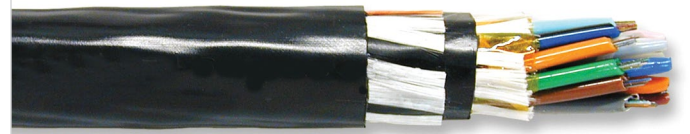

## APPLICATIONS

- IEEE networks from 10 Mbps to 10 Gbps
- Long vertical runs
- Cable trays
- Outdoor/indoor pathways

## FEATURES

- Multiple fiber types including composites
- UL Listed, sunlight resistant
- Transitions from indoor to outdoor
- Heavy duty design
- PFM gel

## BENEFITS

- Multiple network applications
- Longer cable life
- Reduces labor costs
- Allows for harsh environment application
- Non-sticky gel speeds fiber access and clean-up

## SPECIFICATIONS

<b>Fiber Count</b>	Available in 6-fiber up to 216-fiber
<b>Performance Compliance</b>	Telcordia® GR-20-CORE, Issue 3 UL® 1666 RoHS-compliant
<b>NRTL Programs</b>	UL, c(UL) Listed OFNR

Telcordia is a registered trademark of Ericsson Inc. UL is a registered trademark of UL LLC.

## ENVIRONMENTAL SPECIFICATIONS

<b>Operation/Storage</b>	-40°C to +70°C
<b>Installation</b>	-10°C to +70°C

## PART NUMBER KEY

1	H	-	-	-	x	x	0	y
1	2	3	4	5	6	7	8	9
Product family	Fiber count (006-216)				Fiber type	Internal designator	Water block/ marking (1-8)	

Contact Customer Service for availability of non-standard offerings.

## PART NUMBERS AND PHYSICAL CHARACTERISTICS

Listing	Part Number <sup>1</sup>	Fiber Count	Nominal Diameter in (mm)	Nominal Weight lbs/kft (kg/km)	Impact n*m	Maximum Tensile Loading		Minimum Bend Radius		Crush lbs/in (N/cm)	Vertical Rise ft (m)
						Install lbs (N)	Long Term lbs (N)	Install in (mm)	Long Term in (mm)		
OFNR	1H006xx0y	6	0.52 (13.1)	112 (167)	4.41	600 (2,700)	200 (890)	10.4 (262)	5.2 (131)	260 (450)	2,200 (671)
OFNR	1H012xx0y	12	0.52 (13.1)	112 (167)	4.41	600 (2,700)	200 (890)	10.4 (262)	5.2 (131)	260 (450)	2,200 (671)
OFNR	1H024xx0y	24	0.52 (13.1)	112 (167)	4.41	600 (2,700)	200 (890)	10.4 (262)	5.2 (131)	260 (450)	2,200 (671)
OFNR	1H036xx0y	36	0.52 (13.1)	112 (167)	4.41	600 (2,700)	200 (890)	10.4 (262)	5.2 (131)	260 (450)	2,200 (671)
OFNR	1H048xx0y	48	0.52 (13.1)	112 (167)	4.41	600 (2,700)	200 (890)	10.4 (262)	5.2 (131)	260 (450)	2,200 (671)
OFNR	1H072xx0y	72	0.54 (14.3)	125 (186)	5.15	600 (2,700)	200 (890)	10.8 (286)	5.4 (143)	260 (450)	1,840 (560)
OFNR	1H096xx0y	96	0.61 (16.0)	156 (231)	5.88	600 (2,700)	200 (890)	12.1 (320)	6.1 (160)	260 (450)	1,450 (443)
OFNR	1H144xx0y	144	0.74 (19.6)	221 (328)	6.62	600 (2,700)	200 (890)	14.8 (392)	7.4 (196)	260 (450)	1,050 (320)
OFNR	1H216xx0y	216	0.74 (19.6)	221 (328)	6.62	600 (2,700)	200 (890)	14.8 (392)	7.4 (196)	260 (450)	1,050 (320)

## FIBER TYPES:

## SINGLE MODE

Reduced Water Peak	Zero Water Peak	TeraFlex® Bend Resistant				
		G.657.A1	G.657.A2	G.657.B3	NZDS	LEAF
3T	2T	KT	JT	LT	8T	ST
31	21	K1	J1	L1	81	S1

<sup>1</sup>For ≤ 36 fibers replace "xx" with:

<sup>1</sup>For > 36 fibers replace "xx" with:

See "Optical Fiber Specifications" in the "Technical Info" section for detailed fiber type specifications.

## MULTIMODE

TeraGain®	TeraFlex Bend Resistant Laser Optimized 50/125			
	62.5/125	10G/150	10G/300	10G/550
6G	MG	NG	PG	

## WATER BLOCK AND JACKET PRINT CODES

	Dry core		Dry core special	
	Feet	Meters	Feet	Meters
<sup>1</sup> Replace "y" with:	1	2	5	6

# Telco Hybrid Loose Tube, Single 12 AWG Stranded Conductor

Series 1N

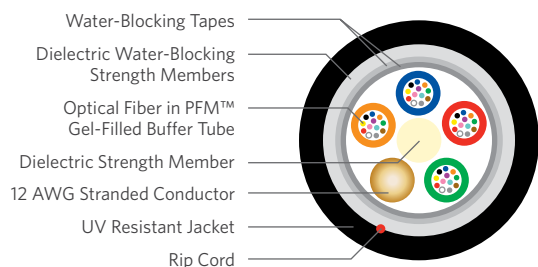

## PRODUCT DESCRIPTION

Series 1N is a stranded, single jacket, non-armored, gel-filled loose tube cable containing a 12 AWG stranded conductor, which provides long distance tone for location. A rip cord is included under the jacket to provide ease of entry.

## APPLICATIONS

- Underground duct and lashed aerial
- Broadband network

## FEATURES

- Available with up to 48-fiber
- Multiple fiber types
- PFM™ gel
- Dry (SAP) core standard
- Multiple fiber vendors
- 12 AWG stranded conductor

## BENEFITS

- High fiber density
- Multiple network applications
- Non-sticky gel speeds fiber access and clean-up
- Reduces cable prep and installation time
- Meets customer preferences
- Meets 10 Ohms/mile standard

## SPECIFICATIONS

**Fiber Count** Available in 12-fiber up to 48-fiber

**Standards Compliance** Telcordia® GR-20-CORE  
RoHS-compliant

*Telcordia is a registered trademark of Ericsson Inc.*

## ENVIRONMENTAL SPECIFICATIONS

**Operation/Storage** -40°C to +70°C

**Installation** -30°C to +70°C

## PART NUMBER KEY

1	N	_	_	_	x	x	0	y
1	2	3	4	5	6	7	8	9
Product family	Fiber count (012-048)				Fiber type	Internal designator	Water block/markings (1-8)	

Contact Customer Service for availability of non-standard offerings.

## PART NUMBERS AND PHYSICAL CHARACTERISTICS

Part Number <sup>1</sup>	Fiber Count	Nominal Diameter in (mm)	Approx. Weight lbs/kft (kg/km)	Maximum Tensile Loading		Minimum Bend Radius	
				Install lbs (N)	Long Term lbs (N)	Install in (mm)	Long Term in (mm)
1N012xx0y	12	0.41 (10.3)	76 (113)	600 (2,700)	200 (890)	8.2 (206)	4.1 (103)
1N024xx0y	24	0.41 (10.3)	76 (113)	600 (2,700)	200 (890)	8.2 (206)	4.1 (103)
1N036xx0y	36	0.41 (10.3)	76 (113)	600 (2,700)	200 (890)	8.2 (206)	4.1 (103)
1N048xx0y	48	0.41 (10.3)	76 (113)	600 (2,700)	200 (890)	8.2 (206)	4.1 (103)

## FIBER TYPES:

## SINGLE MODE

Reduced Water Peak	Zero Water Peak	TeraFlex® Bend Resistant					
		G.657.A1	G.657.A2	G.657.B3	NZDS	LEAF	
3T	2T	KT	JT	LT	8T	ST	
31	21	K1	J1	L1	81	S1	

<sup>1</sup>For ≤ 36 fibers replace "xx" with:

<sup>1</sup>For > 36 fibers replace "xx" with:

## MULTIMODE

TeraGain® 62.5/125	TeraFlex Bend Resistant Laser Optimized 50/125		
	10G/150	10G/300	10G/550
6G	MG	NG	PG

## WATER BLOCK AND JACKET PRINT CODES

Dry core		Dry core special	
Feet	Meters	Feet	Meters
1	2	5	6

<sup>1</sup>Replace "y" with:

## PRODUCT DESCRIPTION

UG FTTP are all dielectric cables designed for Outside Plant (OSP) applications, specifically as a drop cable. The reduced diameter maximizes duct space and offers the lowest installed cost. The loose tube design offers reliable transmission performance over a broad temperature range. The single loose tube design features optical fibers placed inside a single PFM™ gel-filled tube. The core tube is then helically wrapped with water-blocking strength members and encased with a black jacket. A rip cord is included to provide ease of access to the cable core.

## APPLICATIONS

- Drop cables
- Broadband network
- Local loop
- Fiber to the premise

## FEATURES

- Available with up to 12-fiber
- Multiple fiber types including TeraFlex® bend resistant
- Dielectric outer strength members
- Highly flexible
- Small cable diameter
- Dry (SAP) core design
- PFM gel

## BENEFITS

- High fiber density
- Multiple network applications
- Eliminates grounding or bonding problems
- Easy handling
- Installation of more fibers in less space, reduced cost
- Reduces cable prep and installation time
- Non-sticky gel allows for easier and faster clean up

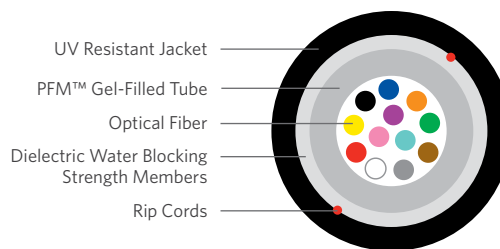

## SPECIFICATIONS

<b>Fiber Count</b>	Available in 2-fiber up to 12-fiber
<b>Standards Compliance</b>	Telcordia® GR-20-CORE RDUP PE-90 Designation 513 RoHS-compliant

Telcordia is a registered trademark of Ericsson Inc.

## ENVIRONMENTAL SPECIFICATIONS

<b>Operation/Storage</b>	-40°C to +70°C
<b>Installation</b>	-30°C to +70°C

## PART NUMBER KEY

5	1	_	_	_	x	x	0	y
1	2	3	4	5	6	7	8	9
Product family	Fiber count (002-012)				Fiber type	Internal designator	Water block/markings (1-8)	

Contact Customer Service for availability of non-standard offerings.

## PART NUMBERS AND PHYSICAL CHARACTERISTICS

Part Number <sup>1</sup>	Fiber Count	Nominal Diameter in (mm)	Approx. Weight lbs/kft (kg/km)	Maximum Tensile Loading		Minimum Bend Radius	
				Install lbs (N)	Long Term lbs (N)	Install in (mm)	Long Term in (mm)
51002xx0y	2	0.26 (6.7)	26 (38)	300 (1,335)	100 (445)	5.2 (132)	2.6 (66)
51004xx0y	4	0.26 (6.7)	26 (38)	300 (1,335)	100 (445)	5.2 (132)	2.6 (66)
51006xx0y	6	0.26 (6.7)	26 (38)	300 (1,335)	100 (445)	5.2 (132)	2.6 (66)
51008xx0y	8	0.26 (6.7)	26 (38)	300 (1,335)	100 (445)	5.2 (132)	2.6 (66)
51012xx0y	12	0.26 (6.7)	26 (38)	300 (1,335)	100 (445)	5.2 (132)	2.6 (66)

## FIBER TYPES:

### SINGLE MODE

Reduced Water Peak	Zero Water Peak	TeraFlex® Bend Resistant					
		G.657.A1	G.657.A2	G.657.B3	NZDS	LEAF	
<sup>1</sup> Replace "xx" with:	33	23	K3	J3	L3	83	S3

### MULTIMODE

TeraGain®	TeraFlex Bend Resistant Laser Optimized 50/125		
62.5/125	10G/150	10G/300	10G/550
6G	MG	NG	PG

See "Optical Fiber Specifications" in the "Technical Info" section for detailed fiber type specifications.

## WATER BLOCK AND JACKET PRINT CODES

Dry core		Dry core special	
Feet	Meters	Feet	Meters
<sup>1</sup> Replace "y" with:	1	2	5
			6

# Buried FTTP, Steel Armor

Series 52S

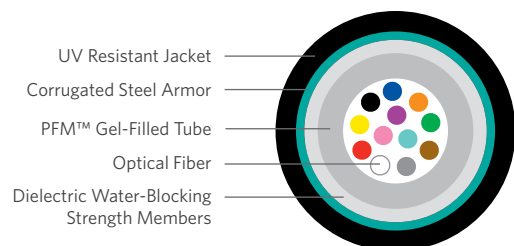

## PRODUCT DESCRIPTION

Buried FTTP cables are designed for Outside Plant (OSP) applications, specifically as a drop cable. The reduced diameter maximizes duct space and offers additional armoring protection. The loose tube design offers reliable transmission performance over a broad temperature range. The durable single loose tube design features optical fibers placed inside a single PFM™ gel-filled tube. The core tube contains up to 12 optical fibers. The core tube is then helically wrapped with water-blocking strength members. A corrugated steel armor is applied and encased with a black jacket.

## APPLICATIONS

- Drop cables
- Broadband network
- Local loop
- Fiber to the premise

## FEATURES

- Corrugated steel armor
- Multiple fiber types including TeraFlex® bend resistant
- Dielectric outer strength members
- Highly flexible
- Small cable diameter
- Color coded fibers
- Dry (SAP) core design
- PFM gel

## BENEFITS

- Additional compressive strength and rodent protection
- Multiple network applications
- Eliminates grounding or bonding problems
- Easy handling
- Installation of more fibers in less space, reduced cost
- Easy identification during installation
- Reduces cable prep and installation time
- Non-sticky gel allows for easier and faster clean up

## SPECIFICATIONS

**Fiber Count** Available in 2-fiber up to 12-fiber

**Standards Compliance** Telcordia® GR-20-CORE  
RDUP PE-90 Designation 52S  
RoHS-compliant

Telcordia is a registered trademark of Ericsson Inc.

## ENVIRONMENTAL SPECIFICATIONS

**Operation/Storage** -40°C to +70°C

**Installation** -30°C to +70°C

## PART NUMBER KEY

5	2	—	—	—	x	S	0	y
1	2	3	4	5	6	7	8	9
Product family	Fiber count (002-012)	Fiber type	Internal designator	Water block/ marking (1-8)				

Contact Customer Service for availability of non-standard offerings.

## PART NUMBERS AND PHYSICAL CHARACTERISTICS

Part Number <sup>1</sup>	Fiber Count	Nominal Diameter in (mm)	Nominal Weight lbs/kft (kg/km)	Maximum Tensile Loading		Minimum Bend Radius	
				Install lbs (N)	Long Term lbs (N)	Install in (mm)	Long Term in (mm)
52002xS0y	2	0.32 (8.2)	51 (77)	300 (1,335)	100 (445)	6.4 (163)	3.2 (8.2)
52004xS0y	4	0.32 (8.2)	51 (77)	300 (1,335)	100 (445)	6.4 (163)	3.2 (8.2)
52006xS0y	6	0.32 (8.2)	51 (77)	300 (1,335)	100 (445)	6.4 (163)	3.2 (8.2)
52008xS0y	8	0.32 (8.2)	51 (77)	300 (1,335)	100 (445)	6.4 (163)	3.2 (8.2)
52012xS0y	12	0.32 (8.2)	51 (77)	300 (1,335)	100 (445)	6.4 (163)	3.2 (8.2)

## FIBER TYPES:

### SINGLE MODE

Reduced Water Peak    Zero Water Peak    TeraFlex® Bend Resistant  
G.657.A1    G.657.A2    G.657.B3

<sup>1</sup>Replace "x" with:

3    2    K    J    L    8    S

### MULTIMODE

TeraGain®    TeraFlex Bend Resistant Laser Optimized 50/125  
62.5/125    10G/150    10G/300    10G/550

6    M    N    P

See "Optical Fiber Specifications" in the "Technical Info" section for detailed fiber type specifications.

## WATER BLOCK AND JACKET PRINT CODES

Dry core    Dry core special  
Feet    Meters    Feet    Meters

<sup>1</sup>Replace "y" with: 1    2    5    6

## PRODUCT DESCRIPTION

Buried FTTP cables are designed for Outside Plant (OSP) applications, specifically as a drop cable. The reduced diameter maximizes duct space and offers additional armoring protection. The loose tube design offers reliable transmission performance over a broad temperature range. The durable single loose tube design features optical fibers placed inside a single PFM™ gel-filled tube. The core tube contains up to 12 optical fibers. The core tube is then helically wrapped with water-blocking strength members. A corrugated steel armor is applied and encased with a black jacket. Rip cords are included to speed access to the fibers.

## APPLICATIONS

- Drop cables
- Broadband network
- Local loop
- Fiber to the premise

## FEATURES

- Corrugated steel armor
- Multiple fiber types including TeraFlex® bend resistant
- Dielectric outer strength members
- Highly flexible
- Small cable diameter
- Rip cords
- Dry (SAP) core design
- PFM gel

## BENEFITS

- Additional compressive strength and rodent protection
- Multiple network applications
- Eliminates grounding or bonding problems
- Easy handling
- Installation of more fibers in less space, reduced cost
- Easy access to fibers
- Reduces cable prep and installation time
- Non-sticky gel allows for easier and faster clean up

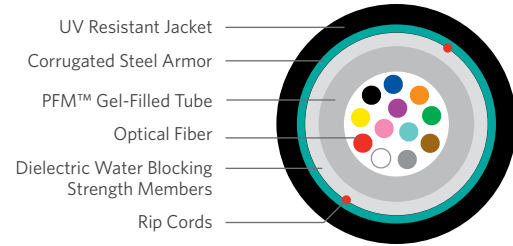

## SPECIFICATIONS

<b>Fiber Count</b>	Available in 2-fiber up to 12-fiber
<b>Standards Compliance</b>	Telcordia® GR-20-CORE RDUP PE-90 Designation 52S RoHS-compliant

Telcordia is a registered trademark of Ericsson Inc.

## ENVIRONMENTAL SPECIFICATIONS

<b>Operation/Storage</b>	-40°C to +70°C
<b>Installation</b>	-30°C to +70°C

## PART NUMBER KEY

5	2	-	-	-	x	U	0	y
1	2	3	4	5	6	7	8	9
Product family	Fiber count (002-012)				Fiber type	Internal designator	Water block/markings (1-8)	

Contact Customer Service for availability of non-standard offerings.

## PART NUMBERS AND PHYSICAL CHARACTERISTICS

Part Number <sup>1</sup>	Fiber Count	Nominal Diameter in (mm)	Nominal Weight lbs/kft (kg/km)	Maximum Tensile Loading		Minimum Bend Radius	
				Install lbs (N)	Long Term lbs (N)	Install in (mm)	Long Term in (mm)
52002xU0y	2	0.32 (8.2)	51 (77)	300 (1,335)	100 (445)	6.4 (163)	3.2 (8.2)
52004xU0y	4	0.32 (8.2)	51 (77)	300 (1,335)	100 (445)	6.4 (163)	3.2 (8.2)
52006xU0y	6	0.32 (8.2)	51 (77)	300 (1,335)	100 (445)	6.4 (163)	3.2 (8.2)
52008xU0y	8	0.32 (8.2)	51 (77)	300 (1,335)	100 (445)	6.4 (163)	3.2 (8.2)
52012xU0y	12	0.32 (8.2)	51 (77)	300 (1,335)	100 (445)	6.4 (163)	3.2 (8.2)

## FIBER TYPES:

### SINGLE MODE

Reduced Water Peak	Zero Water Peak	TeraFlex® Bend Resistant				
		G.657.A1	G.657.A2	G.657.B3	NZDS	LEAF
<sup>1</sup> Replace "x" with:	3	2	K	J	L	8 S

### MULTIMODE

TeraGain®	TeraFlex Bend Resistant Laser Optimized 50/125		
62.5/125	10G/150	10G/300	10G/550
6	M	N	P

See "Optical Fiber Specifications" in the "Technical Info" section for detailed fiber type specifications.

## WATER BLOCK AND JACKET PRINT CODES

	Dry core		Dry core special	
	Feet	Meters	Feet	Meters
<sup>1</sup> Replace "y" with:	1	2	5	6

# Figure 8 FTTP

Series 573Q

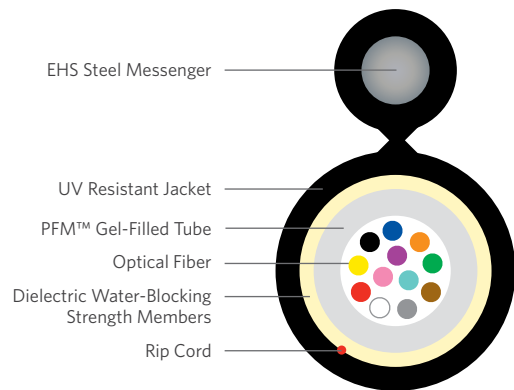

## SPECIFICATIONS

Fiber Count	Available in 1-fiber up to 12-fiber inside a PFM gel-filled loose buffer tube
Strength Members	2.1 mm solid steel wire
Jacket	Black, weather resistant PVC jacket
Standards Compliance	Telcordia® GR-20-CORE RDUP PE-90 Designation 573Q RoHS-compliant

Telcordia is a registered trademark of Ericsson Inc.

## ENVIRONMENTAL SPECIFICATIONS

Operation/Storage	-40°C to +70°C
Installation	-10°C to +70°C

## PART NUMBER KEY

5	7	_	_	_	x	2	3	Q
1	2	3	4	5	6	7	8	9
Product family	Fiber count (001-012)				Fiber type			Internal designator

Contact Customer Service for availability of non-standard offerings.

## PART NUMBERS AND PHYSICAL CHARACTERISTICS

Part Number <sup>1</sup>	Fiber Count	Nominal Dimensions		Nominal Weight lbs/kft (kg/km)	Maximum Tensile Loading		Minimum Bend Radius	
		Minor in (mm)	Major in (mm)		Install lbs (N)	Long Term lbs (N)	Install in (mm)	Long Term in (mm)
57001x23Q	1	0.18 (4.5)	0.35 (8.9)	34 (50)	300 (1,334)	90 (400)	3.6 (91)	1.8 (46)
57002x23Q	2	0.18 (4.5)	0.35 (8.9)	34 (50)	300 (1,334)	90 (400)	3.6 (91)	1.8 (46)
57004x23Q	4	0.18 (4.5)	0.35 (8.9)	34 (50)	300 (1,334)	90 (400)	3.6 (91)	1.8 (46)
57006x23Q	6	0.18 (4.5)	0.35 (8.9)	34 (50)	300 (1,334)	90 (400)	3.6 (91)	1.8 (46)
57008x23Q	8	0.18 (4.5)	0.35 (8.9)	34 (50)	300 (1,334)	90 (400)	3.6 (91)	1.8 (46)
57012x23Q	12	0.18 (4.5)	0.35 (8.9)	34 (50)	300 (1,334)	90 (400)	3.6 (91)	1.8 (46)

## FIBER TYPES:

### SINGLE MODE

Reduced Water Peak	Zero Water Peak	TeraFlex® Bend Resistant			NZDS	LEAF
		G.657.A1	G.657.A2	G.657.B3		
3	2	K	J	L	8	S

<sup>1</sup>Replace "x" with:

### MULTIMODE

TeraGain® 62.5/125	TeraFlex Bend Resistant Laser Optimized 50/125		
	10G/150	10G/300	10G/550
6	M	N	P

See "Optical Fiber Specifications" in the "Technical Info" section for detailed fiber type specifications.

## PRODUCT DESCRIPTION

Figure 8 FTTP offers an aerial solution for fiber to the premise applications. This small profile aerial cable incorporates a 2.1 mm solid steel wire supporting a single enhanced loose tube containing up to 12 optical fibers and PFM™ gel. The small profile reduces cost and problems associated with wind or ice load. This is a water-blocked design, using a "dry" water-absorbing thread to prevent the migration of moisture. A black, weather resistant jacket of PVC completes the cable construction.

## APPLICATIONS

- Aerial self support drop cables
- Broadband network
- Local loop
- Fiber to the premise

## FEATURES

- Available with 1-fiber up to 12-fiber
- Multiple fiber types including TeraFlex® bend resistant
- PFM gel
- Dry (SAP) core standard
- PVC jacket
- Steel messenger

## BENEFITS

- Offers the maximum bandwidth for FTTP business, etc.
- Multiple network applications
- Non-sticky gel reduces installation time and labor cost
- Reduces cable prep and installation time
- Improves flexibility
- Allows use of standard hardware

## RECOMMENDED HARDWARE

Aerial messenger hanger for this product is the MSI (Maclean Senior Industries) .062"-100" Wirewise part number 5056.

# Buried FTTP, Aluminum Armor

Series 523

## PRODUCT DESCRIPTION

Buried FTTP cables are designed for Outside Plant (OSP) applications, specifically as a drop cable. The reduced diameter maximizes duct space and offers additional armoring protection. The loose tube design offers reliable transmission performance over a broad temperature range. The durable single loose tube design features optical fibers placed inside a single PFM™ gel-filled tube. The core tube contains up to 12 optical fibers. The core tube is then helically wrapped with water-blocking strength members. A corrugated aluminum armor is applied and encased with a black jacket. Rip cords are included under the armor for ease of access to the core tube.

## APPLICATIONS

- Drop cables
- Broadband network
- Local loop
- Fiber to the premise

## FEATURES

- Corrugated aluminum armor
- Multiple fiber types including TeraFlex® bend resistant
- Dielectric outer strength members
- Highly flexible
- Small cable diameter
- Color coded fibers
- Dry (SAP) core design
- PFM gel

## BENEFITS

- Additional compressive strength and rodent protection
- Multiple network applications
- Eliminates grounding or bonding problems
- Easy handling
- Installation of more fibers in less space, reduced cost
- Easy identification during installation
- Reduces cable prep and installation time
- Non-sticky gel allows for easier and faster clean up

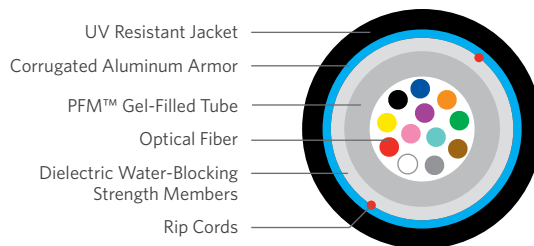
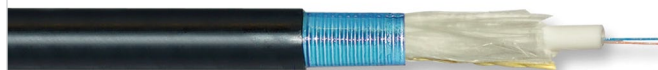

## SPECIFICATIONS

<b>Fiber Count</b>	Available in 2-fiber up to 12-fiber
<b>Standards Compliance</b>	Telcordia® GR-20-CORE RDUP PE-90 Designation 523 RoHS-compliant

Telcordia is a registered trademark of Ericsson Inc.

## ENVIRONMENTAL SPECIFICATIONS

<b>Operation/Storage</b>	-40°C to +70°C
<b>Installation</b>	-30°C to +70°C

## PART NUMBER KEY

5	2	-	-	-	x	x	0	y
1	2	3	4	5	6	7	8	9
Product family	Fiber count (002-012)				Fiber type	Internal designator	Water block/markings (1-8)	

Contact Customer Service for availability of non-standard offerings.

## PART NUMBERS AND PHYSICAL CHARACTERISTICS

Part Number <sup>1</sup>	Fiber Count	Nominal Diameter in (mm)	Nominal Weight lbs/kft (kg/km)	Maximum Tensile Loading		Minimum Bend Radius	
				Install lbs (N)	Long Term lbs (N)	Install in (mm)	Long Term in (mm)
52001xx0y	1	0.33 (8.4)	42 (62)	300 (1,335)	100 (445)	6.6 (168)	3.3 (8.4)
52002xx0y	2	0.33 (8.4)	42 (62)	300 (1,335)	100 (445)	6.6 (168)	3.3 (8.4)
52004xx0y	4	0.33 (8.4)	42 (62)	300 (1,335)	100 (445)	6.6 (168)	3.3 (8.4)
52006xx0y	6	0.33 (8.4)	42 (62)	300 (1,335)	100 (445)	6.6 (168)	3.3 (8.4)
52008xx0y	8	0.33 (8.4)	42 (62)	300 (1,335)	100 (445)	6.6 (168)	3.3 (8.4)
52012xx0y	12	0.33 (8.4)	42 (62)	300 (1,335)	100 (445)	6.6 (168)	3.3 (8.4)

## FIBER TYPES:

### SINGLE MODE

Reduced Water Peak	Zero Water Peak	TeraFlex® Bend Resistant			NZDS	LEAF
		G.657.A1	G.657.A2	G.657.B3		
33	23	K3	J3	L3	83	S3

### MULTIMODE

TeraGain® 62.5/125	TeraFlex Bend Resistant Laser Optimized 50/125		
	10G/150	10G/300	10G/550
6G	MG	NG	PG

<sup>1</sup>Replace "xx" with:

See "Optical Fiber Specifications" in the "Technical Info" section for detailed fiber type specifications.

## WATER BLOCK AND JACKET PRINT CODES

	Dry core		Dry core special	
	Feet	Meters	Feet	Meters
<sup>1</sup> Replace "y" with:	1	2	5	6

# Telco Hybrid Buried Drop, Aluminum Armor

Series 72

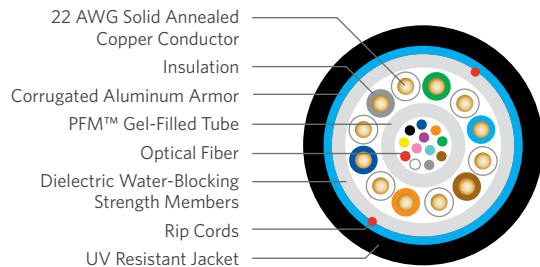

## PRODUCT DESCRIPTION

Series 72 is the underground cable solution for the situation that requires both optical fiber and twisted pairs. This product is available in fiber counts up to 12 with 2-pair, 3-pair or 6-pair 22 AWG copper pairs. Series 72 serves the need for communications or power over copper pairs with optical fiber available for the future. The core is constructed with a single tube containing up to 12 optical fibers and up to 6 copper pairs. A corrugated aluminum armor and longitudinal strength elements are applied over the core tube and encased within a black, weather resistant jacket. Rip cords are included under the armor for ease of access to the core.

## APPLICATIONS

- Fiber to the premise
- Broadband network
- Buried, underground

## FEATURES

- Hybrid fiber/copper design
- Round shape
- Corrugated aluminum armor
- Dry (SAP) core standard
- PFM™ gel
- Insulation of tip conductors are marked with a stripe of the mating ring's insulation color

## BENEFITS

- Multiple Network applications
- Conforms to standard practices and hardware
- Improves flexibility
- Reduces cable prep and installation time
- Non-sticky gel allows for easier and faster clean up
- Reduces the possibility of splitting pairs during installation

## SPECIFICATIONS

<b>Fiber Components</b>	Available in 2-fiber up to 12-fiber loose inside a PFM gel-filled buffer tube
<b>Copper Components</b>	Available with 2, 3 or 6-pair 22 AWG solid annealed copper conductors each insulated with solid polyolefin in distinctive colors
<b>Standards Compliance</b>	Telcordia® GR-20-CORE RDUP PE-90 Designation 72 RoHS-compliant

Telcordia is a registered trademark of Ericsson Inc.

## PART NUMBER KEY

7	2	-	-	-	x	x	2, 3, or 6	y
1	2	3	4	5	6	7	8	9
Product family	Fiber count (002-012)	Fiber type	Internal designator	Copper pairs	Water block/ marking (1-8)			

Contact Customer Service for availability of non-standard offerings.

## ENVIRONMENTAL SPECIFICATIONS

<b>Operation/Storage</b>	-40°C to +70°C
<b>Installation</b>	-30°C to +70°C

## ELECTRICAL SPECIFICATIONS

Conductor AWG (mm)	Conductor DC Resistance @ 68°F Maximum Individual Ohms/mile (Ohms/km)	Resistance Unbalance Maximum Individual Pair %	Minimum Dielectric Strength DC Potential Volts Conductor to Conductor
22 (0.64)	91.0 (56.4)	5.0	7,200

## PART NUMBERS AND PHYSICAL CHARACTERISTICS

Part Number <sup>1</sup>	Copper Pair Count	Fiber Count	Nominal Diameter in (mm)	Nominal Weight lbs/kft (kg/km)	Maximum Tensile Loading		Minimum Bend Radius		Copper Max. Amperage A	Copper Max. Voltage vDC	Package
					Install lbs (N)	Long Term lbs (N)	Install in (mm)	Long Term in (mm)			
72002xx2y	2	2	0.39 (9.8)	50 (74)	300 (1,335)	100 (445)	7.8 (198)	3.9 (99)	1.0	150	Reel
72004xx2y	2	4	0.39 (9.8)	50 (74)	300 (1,335)	100 (445)	7.8 (198)	3.9 (99)	1.0	150	Reel
72006xx2y	2	6	0.39 (9.8)	50 (74)	300 (1,335)	100 (445)	7.8 (198)	3.9 (99)	1.0	150	Reel
72002xx3y	3	2	0.40 (10.1)	52 (77)	300 (1,335)	100 (445)	8.0 (202)	4.0 (101)	1.0	150	Reel
72004xx3y	3	4	0.40 (10.1)	52 (77)	300 (1,335)	100 (445)	8.0 (202)	4.0 (101)	1.0	150	Reel
72006xx3y	3	6	0.40 (10.1)	52 (77)	300 (1,335)	100 (445)	8.0 (202)	4.0 (101)	1.0	150	Reel
72002xx6y	6	2	0.44 (11.1)	56 (83)	300 (1,335)	100 (445)	8.8 (222)	4.4 (111)	1.0	150	Reel
72004xx6y	6	4	0.44 (11.1)	56 (83)	300 (1,335)	100 (445)	8.8 (222)	4.4 (111)	1.0	150	Reel
72006xx6y	6	6	0.44 (11.1)	56 (83)	300 (1,335)	100 (445)	8.8 (222)	4.4 (111)	1.0	150	Reel
72012xx6y	6	12	0.44 (11.1)	56 (83)	300 (1,335)	100 (445)	8.8 (222)	4.4 (111)	1.0	150	Reel

## FIBER TYPES:

### SINGLE MODE

Reduced Water Peak	Zero Water Peak	TeraFlex® Bend Resistant					
		G.657.A1	G.657.A2	G.657.B3	NZDS	LEAF	
<sup>1</sup> Replace "xx" with:	33	23	K3	J3	L3	83	S3

### MULTIMODE

TeraGain®	TeraFlex Bend Resistant Laser Optimized 50/125			
62.5/125	10G/150	10G/300	10G/550	
6G	MG	NG	PG	

See "Optical Fiber Specifications" in the "Technical Info" section for detailed fiber type specifications.

## WATER BLOCK AND JACKET PRINT CODES

Dry core		Dry core special		
Feet	Meters	Feet	Meters	
<sup>1</sup> Replace "y" with:	1	2	5	6



# Telco Hybrid Buried Drop, Steel Armor

Series 72S

## PRODUCT DESCRIPTION

Series 72S is the underground cable solution for the situation that requires both optical fiber and twisted pairs. This product is available in fiber counts up to 12 with 2-pair, 3-pair or 6-pair 22 AWG copper pairs. Series 72S serves the need for communications or low voltage power over copper pairs with optical fiber available for the future. The core is constructed with a single tube containing up to 12 optical fibers and up to 6 copper pairs. A corrugated steel armor and longitudinal strength elements are applied over the core tube and encased within a black, weather resistant jacket. Rip cords are included under the armor for ease of access to the core.

## APPLICATIONS

- Fiber to the premise
- Broadband network
- Buried, underground

## FEATURES

- Hybrid fiber/copper design
- Round shape
- Corrugated steel armor
- Dry (SAP) core standard
- PFM™ gel
- Insulation of tip conductors are marked with a stripe of the mating ring's insulation color

## BENEFITS

- Multiple Network applications
- Conforms to standard practices and hardware
- Improves compressive strength and rodent protection
- Reduces cable prep and installation time
- Non-sticky gel allows for easier and faster clean up
- Reduces the possibility of splitting pairs during installation

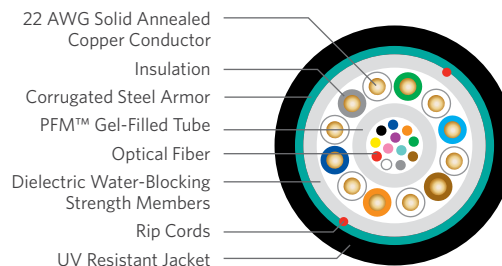
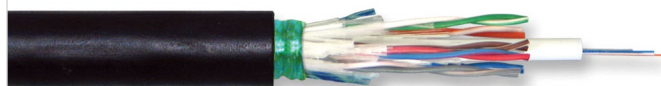

## SPECIFICATIONS

<b>Fiber Components</b>	Available in 2-fiber up to 12-fiber loose inside a PFM gel-filled buffer tube
<b>Copper Components</b>	Available with 2, 3 or 6-pair 22 AWG solid annealed copper conductors each insulated with solid polyolefin in distinctive colors
<b>Standards Compliance</b>	Telcordia® GR-20-CORE RDUP PE-90 Designation 72S RoHS-compliant

Telcordia is a registered trademark of Ericsson Inc.

## ENVIRONMENTAL SPECIFICATIONS

<b>Operation/Storage</b>	-40°C to +70°C
<b>Installation</b>	-30°C to +70°C

## PART NUMBER KEY

7	2	—	—	—	x	x	2, 3, or 6	S
1	2	3	4	5	6	7	8	9
Product family	Fiber count (002-012)				Fiber type	Internal designator	Copper pairs	Steel armor

Contact Customer Service for availability of non-standard offerings.

## ELECTRICAL SPECIFICATIONS

Conductor AWG (mm)	Conductor DC Resistance @ 68°F Maximum Individual Ohms/mile (Ohms/km)	Resistance Unbalance Maximum Individual Pair %	Minimum Dielectric Strength DC Potential Volts Conductor to Conductor
22 (0.64)	91.0 (56.4)	5.0	7,200

## PART NUMBERS AND PHYSICAL CHARACTERISTICS

Part Number <sup>1</sup>	Copper Pair Count	Fiber Count	Nominal Diameter in (mm)	Nominal Weight lbs/kft (kg/km)	Maximum Tensile Loading		Minimum Bend Radius		Copper Max. Amperage A	Copper Max. Voltage vDC	Package
					Install lbs (N)	Long Term lbs (N)	Install in (mm)	Long Term in (mm)			
72002xx2S	2	2	0.39 (9.8)	67 (100)	300 (1,335)	100 (445)	7.8 (198)	3.9 (99)	1.0	150	Reel
72004xx2S	2	4	0.39 (9.8)	67 (100)	300 (1,335)	100 (445)	7.8 (198)	3.9 (99)	1.0	150	Reel
72006xx2S	2	6	0.39 (9.8)	67 (100)	300 (1,335)	100 (445)	7.8 (198)	3.9 (99)	1.0	150	Reel
72002xx3S	3	2	0.40 (10.1)	71 (106)	300 (1,335)	100 (445)	8.0 (202)	4.0 (101)	1.0	150	Reel
72004xx3S	3	4	0.40 (10.1)	71 (106)	300 (1,335)	100 (445)	8.0 (202)	4.0 (101)	1.0	150	Reel
72006xx3S	3	6	0.40 (10.1)	71 (106)	300 (1,335)	100 (445)	8.0 (202)	4.0 (101)	1.0	150	Reel
72002xx6S	6	2	0.44 (11.1)	75 (111)	300 (1,335)	100 (445)	8.8 (222)	4.4 (111)	1.0	150	Reel
72004xx6S	6	4	0.44 (11.1)	75 (111)	300 (1,335)	100 (445)	8.8 (222)	4.4 (111)	1.0	150	Reel
72006xx6S	6	6	0.44 (11.1)	75 (111)	300 (1,335)	100 (445)	8.8 (222)	4.4 (111)	1.0	150	Reel
72012xx6S	6	12	0.44 (11.1)	75 (111)	300 (1,335)	100 (445)	8.8 (222)	4.4 (111)	1.0	150	Reel

FIBER TYPES:	SINGLE MODE							MULTIMODE			
	Reduced Water Peak	Zero Water Peak	TeraFlex® Bend Resistant				TeraGain®	TeraFlex Bend Resistant Laser Optimized 50/125			
			G.657.A1	G.657.A2	G.657.B3	NZDS	LEAF	62.5/125	10G/150	10G/300	10G/550
<sup>1</sup> Replace "xx" with:	33	23	K3	J3	L3	83	S3	6G	MG	NG	PG

See "Optical Fiber Specifications" in the "Technical Info" section for detailed fiber type specifications.

# Universal Drop FTTP

Series 6U

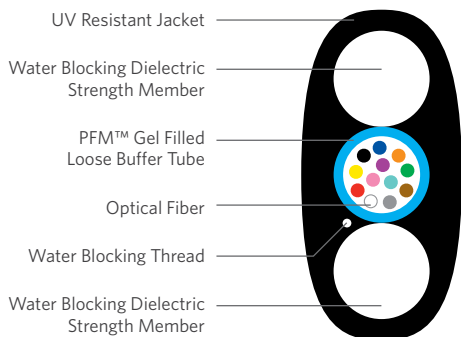

## PRODUCT DESCRIPTION

Universal Drop FTTP offers the most flexible solution for fiber to the premise applications. This all dielectric cable requires no grounding or bonding. The small profile reduces cost and increases both ease of use and access to small conduits. This durable design incorporates two dielectric rigid rods for tensile and crush protection, bracketing a single enhanced loose tube containing up to 24 optical fibers and PFM™ gel. A black, weather resistant jacket completes the cable construction.

## APPLICATIONS

- Drop cables
- Broadband network
- Local loop
- Fiber to the premise

## FEATURES

- Available with up to 24-fiber
- Universal design
- Dielectric
- PFM gel
- Dielectric Rods
- Length marks are printed in both sequential feet and meters

## BENEFITS

- Offers the maximum bandwidth for FTTP business, etc.
- Aerial or direct bury
- Eliminates bonding and grounding
- Non-sticky gel reduces installation time and labor cost
- Excellent crush resistance
- Eliminates need for length conversion

## SPECIFICATIONS

Fiber Count	Available with up to 24-fiber inside a PFM gel-filled loose buffer tube
Strength Members	Water-blocking dielectric strength members placed parallel to single loose tube, one on each side, to provide necessary longitudinal strength
Jacket	Black, UV resistant jacket
Maximum Span Length at 1% Sag ft (m)	Light Loading: 330 (101) Medium Loading: 225 (69) Heavy Loading: 150 (46)
Standards Compliance	Telcordia® GR-20-CORE RDUP PE-90 Designation 570Q RoHS-compliant

Telcordia is a registered trademark of Ericsson Inc.

## ENVIRONMENTAL SPECIFICATIONS

Operation/Storage	-40°C to +70°C
Installation	-30°C to +70°C

## PART NUMBER KEY

6	U	-	-	-	x	1	R, B or 0	G, B or 1
1	2	3	4	5	6	7	8	9
Product family	Fiber count (002-012)	Fiber type	Internal designator	Package type	Internal designator			

Contact Customer Service for availability of non-standard offerings. See "Optical Fiber Cable" options in the "Technical Info" section for flooding and jacket marking options.

## PART NUMBERS AND PHYSICAL CHARACTERISTICS

Part Number <sup>1</sup>	Fiber Count	Nominal Dimensions		Nominal Weight lbs/kft (kg/km)	Maximum Tensile Loading		Minor Dimension Bend Radius in (mm)	Package	Approx. Shipping Weight lbs (kg)
		Minor in (mm)	Major in (mm)		Install lbs (N)	Long Term lbs (N)			
6U001x101	1	0.17 (4.3)	0.32 (8.0)	24 (36)	300 (1,335)	90 (405)	3.15 (76)	Master reel	-
6U002x101	2	0.17 (4.3)	0.32 (8.0)	24 (36)	300 (1,335)	90 (405)	3.15 (76)	Master reel	-
6U002x1RG	2	0.17 (4.3)	0.32 (8.0)	24 (36)	300 (1,335)	90 (405)	3.15 (76)	2,500' Reel	132 (60)
6U002x1BB	2	0.17 (4.3)	0.32 (8.0)	24 (36)	300 (1,335)	90 (405)	3.15 (76)	1,000' Reel-in-a-Box	52 (24)
6U004x1RG	4	0.17 (4.3)	0.32 (8.0)	24 (36)	300 (1,335)	90 (405)	3.15 (76)	2,500' Reel	132 (60)
6U004x1BB	4	0.17 (4.3)	0.32 (8.0)	24 (36)	300 (1,335)	90 (405)	3.15 (76)	1,000' Reel-in-a-Box	52 (24)
6U006x1RG	6	0.17 (4.3)	0.32 (8.0)	24 (36)	300 (1,335)	90 (405)	3.15 (76)	2,500' Reel	132 (60)
6U006x1BB	6	0.17 (4.3)	0.32 (8.0)	24 (36)	300 (1,335)	90 (405)	3.15 (76)	1,000' Reel-in-a-Box	52 (24)
6U012x1RG	12	0.17 (4.3)	0.32 (8.0)	24 (36)	300 (1,335)	90 (405)	3.15 (76)	2,500' Reel	132 (60)
6U024x101	24	0.17 (4.3)	0.32 (8.0)	22 (33)	300 (1,335)	90 (405)	3.15 (76)	Master reel	-
6U024x1RG	24	0.17 (4.3)	0.32 (8.0)	22 (33)	300 (1,335)	90 (405)	3.15 (76)	2,500' Reel	121 (55)
6U024x1BB	24	0.17 (4.3)	0.32 (8.0)	22 (33)	300 (1,335)	90 (405)	3.15 (76)	1,000' Reel-in-a-Box	47 (21)

## FIBER TYPES:

### SINGLE MODE

Reduced Water Peak	Zero Water Peak	TeraFlex® Bend Resistant				
		G.657.A1	G.657.A2	G.657.B3	NZDS	LEAF

<sup>1</sup>Replace "x" with:

3	2	K	J	L	8	S
---	---	---	---	---	---	---

### MULTIMODE

TeraGain® 62.5/125	TeraFlex Bend Resistant Laser Optimized 50/125		
	10G/150	10G/300	10G/550

6	M	N	P
---	---	---	---

See "Optical Fiber Specifications" in the "Technical Info" section for detailed fiber type specifications.

## PRODUCT DESCRIPTION

Toneable Drop FTTP offers the most flexible solution for fiber to the premise applications. The toneable unit allows for easy location after installation. The small profile reduces cost and increases both ease of use and access to small conduits. This product is the low cost solution to the network's last 100 meters. The durable design incorporates two dielectric rigid rods for tensile and crush protection, bracketing a single enhanced loose tube containing up to 24 optical fibers and PFM™ gel.

## APPLICATIONS

- Drop cables
- Broadband network
- Local loop
- Fiber to the premise

## FEATURES

- Available with up to 24-fiber
- Universal design
- Toneable element
- PFM gel
- Dielectric rods
- Dry (SAP) core standard
- Length marks are printed in both sequential feet and meters

## BENEFITS

- Maximum bandwidth
- Aerial or direct bury
- Ease of location
- Non-sticky gel reduces installation time and labor cost
- Excellent crush resistance
- Reduces cable prep and installation time
- Eliminates need for length conversion

## ENVIRONMENTAL SPECIFICATIONS

Operation/Storage	-40°C to +70°C
Installation	-30°C to +70°C

## PART NUMBER KEY

6	T	-	-	-	x	1	R, B or 0	G, B or 1
1	2	3	4	5	6	7	8	9
Product family	Fiber count (002-012)	Fiber type	Internal designator	Package type	Internal designator			

Contact Customer Service for availability of non-standard offerings. See "Optical Fiber Cable" options in the "Technical Info" section for flooding and jacket marking options.

## PART NUMBERS AND PHYSICAL CHARACTERISTICS

Part Number <sup>1</sup>	Fiber Count	Nominal Dimensions		Nominal Weight lbs/kft (kg/km)	Maximum Tensile Loading		Minor Dimension Bend Radius in (mm)	Package	Approx. Shipping Weight lbs (kg)
		Minor in (mm)	Major in (mm)		Install lbs (N)	Long Term lbs (N)			
6T001x101	1	0.17 (4.3)	0.35 (9.0)	27 (40)	300 (1,335)	90 (405)	3.15 (76)	Master reel	-
6T002x101	2	0.17 (4.3)	0.35 (9.0)	27 (40)	300 (1,335)	90 (405)	3.15 (76)	Master reel	-
6T002x1RG	2	0.17 (4.3)	0.35 (9.0)	27 (40)	300 (1,335)	90 (405)	3.15 (76)	2,500' Reel	121 (55)
6T002x1BB	2	0.17 (4.3)	0.35 (9.0)	27 (40)	300 (1,335)	90 (405)	3.15 (76)	1,000' Reel-in-a-Box	47 (17)
6T004x1RG	4	0.17 (4.3)	0.35 (9.0)	27 (40)	300 (1,335)	90 (405)	3.15 (76)	2,500' Reel	121 (55)
6T004x1BB	4	0.17 (4.3)	0.35 (9.0)	27 (40)	300 (1,335)	90 (405)	3.15 (76)	1,000' Reel-in-a-Box	47 (17)
6T006x1RG	6	0.17 (4.3)	0.35 (9.0)	27 (40)	300 (1,335)	90 (405)	3.15 (76)	2,500' Reel	121 (55)
6T006x1BB	6	0.17 (4.3)	0.35 (9.0)	27 (40)	300 (1,335)	90 (405)	3.15 (76)	1,000' Reel-in-a-Box	47 (17)
6T012x1RG	12	0.17 (4.3)	0.35 (9.0)	27 (40)	300 (1,335)	90 (405)	3.15 (76)	2,500' Reel	121 (55)
6T012x1BB	12	0.17 (4.3)	0.35 (9.0)	27 (40)	300 (1,335)	90 (405)	3.15 (76)	1,000' Reel-in-a-Box	47 (17)
6T024x101	24	0.17 (4.3)	0.35 (9.0)	25 (37)	300 (1,335)	90 (405)	3.15 (76)	Master reel	-
6T024x1RG	24	0.17 (4.3)	0.35 (9.0)	25 (37)	300 (1,335)	90 (405)	3.15 (76)	2,500' Reel	112 (51)
6T024x1BB	24	0.17 (4.3)	0.35 (9.0)	25 (37)	300 (1,335)	90 (405)	3.15 (76)	1,000' Reel-in-a-Box	-

FIBER TYPES:	SINGLE MODE							MULTIMODE			
	Reduced Water Peak	Zero Water Peak	TeraFlex® Bend Resistant				TeraGain®	TeraFlex Bend Resistant Laser Optimized 50/125			
			G.657.A1	G.657.A2	G.657.B3	NZDS	LEAF	62.5/125	10G/150	10G/300	10G/550
<sup>1</sup> Replace "x" with:	3	2	K	J	L	8	S	6	M	N	P

See "Optical Fiber Specifications" in the "Technical Info" section for detailed fiber type specifications.

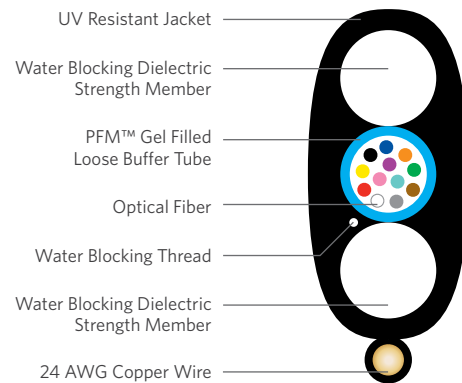

## SPECIFICATIONS

Fiber Count	Available with up to 24-fiber inside a PFM gel-filled loose buffer tube
Strength Members	Water-blocking dielectric strength members placed parallel to single loose tube, to provide necessary longitudinal strength
Toneable Element	24 AWG copper wire encased in jacket
Jacket	Black, UV resistant jacket
Maximum Span Length at 1% Sag ft (m)	Light Loading: 330 (101) Medium Loading: 225 (69) Heavy Loading: 150 (46)
Standards Compliance	Telcordia® GR-20-CORE RDUP PE-90 Designation 571Q RoHS-compliant

Telcordia is a registered trademark of Ericsson Inc.

# Universal FTTP Tight Buffered Indoor/Outdoor Drop

Series W7U

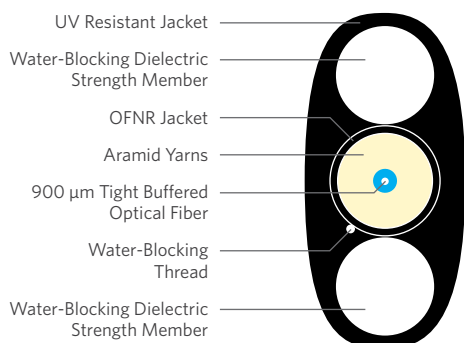

## PRODUCT DESCRIPTION

Series W7U FTTP is the first indoor/outdoor drop cable that is durable enough for outdoor environments and flexible enough for tight bends within residences. The patented design utilizes a fully functional 2.9 mm OFNR rated tight buffer cable as the core of a GR-20 OSP rated FTTP small flat cable. The key benefit of this cable is that it can be installed from the pedestal to the indoor ONT (Optical Network Terminal) with no intermediate termination. Significant installation savings can be realized by avoiding splicing or termination on the outside or inside wall of the residence. Further savings are realized by using an indoor ONT that does not require an electrician to install. This completely dry, flat drop cable is available in universal and toneable designs that are suitable for aerial, direct bury or conduit installation. A water-blocking thread is used to prevent water penetration.

## APPLICATIONS

- Drop cables for aerial, direct bury or conduit installations
- Fiber to the premise for single family residences

## FEATURES

- Universal design
- Dielectric rods
- Indoor/outdoor design
- Meets GR-20 specifications
- Cable in a cable
- TeraFlex® fiber in a flexible tight buffer cable design
- Length marks are printed in both sequential feet and meters

## BENEFITS

- Aerial, direct bury or conduit, all dielectric
- Excellent crush resistance
- Tight Buffered cable can be placed in a riser environment and is UL listed
- Industry accepted standard for OSP installations
- Eliminates splice at premises wall
- Inner cable can be wrapped around corners and stapled with no attenuation issues
- Eliminates need for length conversion

## SPECIFICATIONS

**Maximum Span Length at 1% Sag ft (m)**  
 Light Loading: 350 (101)  
 Medium Loading: 275 (84)  
 Heavy Loading: 150 (46)

**Standards Compliance**  
 Telcordia® GR-20-CORE  
 RoHS-compliant

Telcordia is a registered trademark of Ericsson Inc.

## MACRO BENDING PERFORMANCE

**10 Turns on 15 mm Radius Mandrel** ITU G.657.A1 TeraFlex SMF

Macro bending loss @ 1550 nm 0.25 dB Max. ≤ 0.20 dB

Macro bending loss @ 1625 nm 1.00 dB Max. ≤ 0.50 dB

**1 Turn on 10 mm Radius Mandrel** ITU G.657.A1 TeraFlex SMF

Macro bending loss @ 1550 nm 0.75 dB Max. ≤ 0.20 dB

Macro bending loss @ 1625 nm 1.50 dB Max. ≤ 0.20 dB

TeraFlex is an ITU G.657.A1 optical fiber that is completely compatible with ITU G.652.D optical fibers. TeraFlex exceeds the performance standards of ITU G.657.A1 as listed above.

## PART NUMBER KEY

W	7	0	0	1 or 2	x	U	0	y
1	2	3	4	5	6	7	8	9
Product family	Fiber count (001 or 002)			Fiber type	Universal	Internal designator	Water block/markings (1-8)	

Contact Customer Service for availability of non-standard offerings.

## ENVIRONMENTAL SPECIFICATIONS

**Operation/Storage** -40°C to +70°C

**Installation** -10°C to +70°C

Jonard is a registered trademark of Jonard Industries Corporation.

The Series W7 flat drop is designed for easy access using the FOD-2000 cable slitting tool from Jonard® Tools.

## PART NUMBERS AND PHYSICAL CHARACTERISTICS

Part Number <sup>1</sup>	Fiber Count	Nominal Dimensions			Nominal Weight lbs/kft (kg/km)	Cable Tensile Load		Cable Bend Radius		Fiber Component Bend Radius	
		Minor in (mm)	Major in (mm)	Fiber Component in (mm)		Install lbs (N)	Long Term lbs (N)	Install in (mm)	Long Term in (mm)	Install in (mm)	Long Term in (mm)
W7001xU0y	1	0.17 (4.4)	0.29 (7.4)	0.11 (2.9)	29 (44)	300 (1,350)	90 (405)	3.4 (90)	1.7 (46)	2.2 (56)	1.1 (28)
W7002xU0y	2	0.17 (4.4)	0.29 (7.4)	0.11 (2.9)	29 (44)	300 (1,350)	90 (405)	3.4 (90)	1.7 (46)	2.2 (56)	1.1 (28)

## WATER BLOCK AND JACKET PRINT CODES

Dry core		Dry core special	
Feet	Meters	Feet	Meters

<sup>1</sup>Replace "y" with: 1 2 5 6

## FIBER TYPES:

### SINGLE MODE

TeraFlex® Bend Resistant

G.657.A1 G.657.A2 G.657.B3

<sup>1</sup>Replace "x" with: K J L

See "Optical Fiber Specifications" in the "Technical Info" section for detailed fiber type specifications.

# Toneable FTTP Tight Buffered Indoor/Outdoor Drop

Series W7T

## PRODUCT DESCRIPTION

Series W7T FTTP is the first indoor/outdoor drop cable that is durable enough for outdoor environments and flexible enough for tight bends within residences. The patented design utilizes a fully functional 2.9 mm OFNR rated tight buffer cable as the core of a GR-20 OSP rated FTTP small flat cable. The key benefit of this cable is that it can be installed from the pedestal to the indoor ONT (Optical Network Terminal) with no intermediate termination. Significant installation savings can be realized by avoiding splicing or termination on the outside or inside wall of the residence. Further savings are realized by using an indoor ONT that does not require an electrician to install. This completely dry, flat drop cable is available in universal and toneable designs that are suitable for aerial, direct bury or conduit installation. A water-blocking thread is used to prevent water penetration.

## APPLICATIONS

- Drop cables for aerial, direct bury or conduit installations
- Fiber to the premise for single family residences

## FEATURES

- Toneable design
- Dielectric rods
- Indoor/outdoor design
- Meets GR-20 specifications
- Cable in a cable
- TeraFlex® fiber in a flexible tight buffer cable design
- Length marks are printed in both sequential feet and meters

## BENEFITS

- Copper element allows for toneable location
- Excellent crush resistance
- Tight Buffered cable can be placed in a riser environment and is UL listed
- Industry accepted standard for OSP installations
- Eliminates splice at premises wall
- Inner cable can be wrapped around corners and stapled with no attenuation issues
- Eliminates need for length conversion

The Series W7 flat drop is designed for easy access using the FOD-2000 cable slitting tool from Jonard® Tools.

## ENVIRONMENTAL SPECIFICATIONS

Operation/Storage	-40°C to +70°C
Installation	-10°C to +70°C

Jonard is a registered trademark of Jonard Industries Corporation.

## PART NUMBERS AND PHYSICAL CHARACTERISTICS

Part Number <sup>1</sup>	Fiber Count	Nominal Dimensions			Nominal Weight lbs/kft (kg/km)	Cable Tensile Load		Cable Bend Radius		Fiber Component Bend Radius	
		Minor in (mm)	Major in (mm)	Fiber Component in (mm)		Install lbs (N)	Long Term lbs (N)	Install in (mm)	Long Term in (mm)	Install in (mm)	Long Term in (mm)
W7001x10y	1	0.17 (4.4)	0.36 (9.2)	0.11 (2.9)	31 (47)	300 (1,350)	90 (405)	3.4 (90)	1.7 (45)	2.2 (56)	1.1 (28)
W7002x10y	2	0.17 (4.4)	0.36 (9.2)	0.11 (2.9)	31 (47)	300 (1,350)	90 (405)	3.4 (90)	1.7 (45)	2.2 (56)	1.1 (28)

## WATER BLOCK AND JACKET PRINT CODES

	Dry core		Dry core special	
	Feet	Meters	Feet	Meters
<sup>1</sup> Replace "y" with:	1	2	5	6

## FIBER TYPES:

### SINGLE MODE

TeraFlex® Bend Resistant

G.657.A1	G.657.A2	G.657.B3
----------	----------	----------

<sup>1</sup>Replace "x" with:

K	J	L
---	---	---

See "Optical Fiber Specifications" in the "Technical Info" section for detailed fiber type specifications.

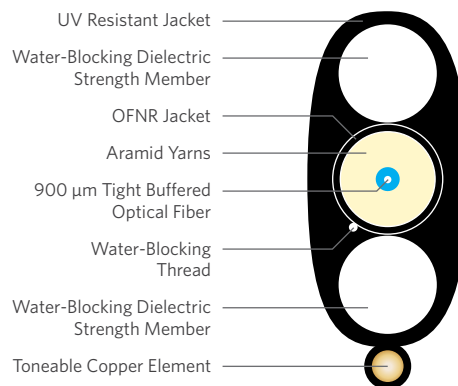
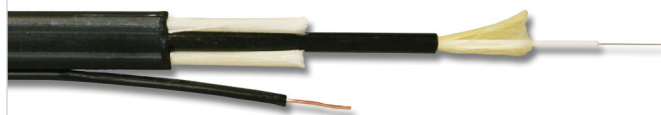

## SPECIFICATIONS

Maximum Span Length at 1% Sag ft (m)	Light Loading: 350 (101)
	Medium Loading: 275 (84)
	Heavy Loading: 150 (46)
Standards Compliance	Telcordia® GR-20-CORE RoHS-compliant

Telcordia is a registered trademark of Ericsson Inc.

## MACRO BENDING PERFORMANCE

10 Turns on 15 mm Radius Mandrel	ITU G.657.A1	TeraFlex SMF
Macro bending loss @ 1550 nm	0.25 dB Max.	≤ 0.20 dB
Macro bending loss @ 1625 nm	1.00 dB Max.	≤ 0.50 dB
1 Turn on 10 mm Radius Mandrel	ITU G.657.A1	TeraFlex SMF
Macro bending loss @ 1550 nm	0.75 dB Max.	≤ 0.20 dB
Macro bending loss @ 1625 nm	1.50 dB Max.	≤ 0.20 dB

TeraFlex is an ITU G.657.A1 optical fiber that is completely compatible with ITU G.652.D optical fibers. TeraFlex exceeds the performance standards of ITU G.657.A1 as listed above.

## PART NUMBER KEY

W	7	0	0	1 or 2	x	1	0	y
1	2	3	4	5	6	7	8	9
Product family	Fiber count (001 or 002)		Fiber type	Toneable	Internal designator	Water block/ marking (1-8)		

Contact Customer Service for availability of non-standard offerings.

# W7 Fiber Drop Assemblies

Series ADWSA

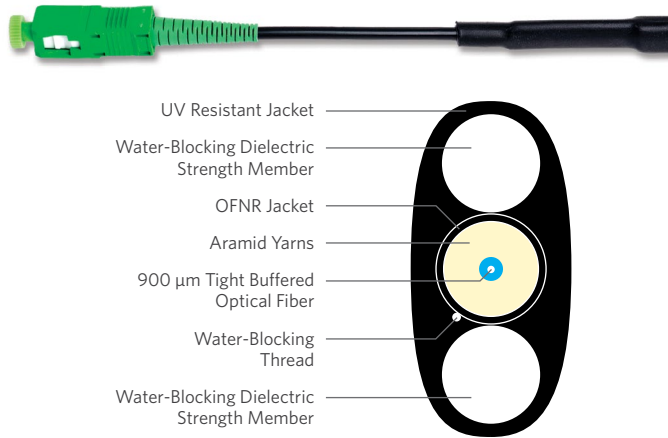

## PRODUCT DESCRIPTION

W7 Fiber Drop Assemblies incorporate a rugged drop cable design, providing a through-the-wall solution for indoor ONTs with the labor savings of a connectorized assembly. On one end of the cable, an SCAPC is attached with a 6" breakout protected with a heat shrink tube. The W7 cable offers unique flexibility that allows it to address aerial or underground installations, while also providing a through-the-wall Indoor/Outdoor OFNR-rated Simplex to address indoor ONTs. Removal of the outer jacket and rods leaves an Indoor/Outdoor OFNR Simplex (or Duplex) cable containing bend insensitive fibers that can be routed through the wall and the interior to the ONT. Since the Simplex cable component is the breakout, the transition from the fiber cable to the breakout is seamless. The connector is attached at the end of a 6" breakout, which is protected from water egress at the breakout by a heat shrink tube.

## APPLICATIONS

- Drop cables for aerial, direct bury or conduit installations
- Fiber to the premise for single family residences

## FEATURES

- Cable in a cable
- Teraflex fiber
- OFNR rating
- Connectorized 1 end
- Universal application
- Length marks are printed in both sequential feet and meters

## BENEFITS

- Eliminates termination at the premise wall
- Allows for tight bends
- Simplex cable can be routed indoors
- Allows for ease of connection
- Conduit, direct bury or aerial (fits in standard hardware)
- Eliminates need for length conversion

## SPECIFICATIONS

Maximum Span Length at 1% Sag ft (m)	Light Loading: 350 (101)
	Medium Loading: 275 (84)
	Heavy Loading: 150 (46)
Standards Compliance	Telcordia® GR-20-CORE RoHS-compliant

Telcordia is a registered trademark of Ericsson Inc.

## CONNECTOR SPECIFICATIONS

Type	SC
Ferrule	Ceramic
Polish Type	APC
Insertion Loss	Typical: 0.15 dB Max: 0.30 dB
Min Return Loss	0.55 dB

## MACRO BENDING PERFORMANCE

10 Turns on 15 mm Radius Mandrel	ITU G 657 A	TeraFlex SMF
Macro bending loss @ 1550 nm	0.25 dB Max.	≤ 0.20 dB
Macro bending loss @ 1625 nm	1.00 dB Max.	≤ 0.50 dB
1 Turn on 10 mm Radius Mandrel	ITU G 657 A	TeraFlex SMF
Macro bending loss @ 1550 nm	0.75 dB Max.	≤ 0.20 dB
Macro bending loss @ 1625 nm	1.50 dB Max.	≤ 0.20 dB

TeraFlex is an ITU G 657 A optical fiber that is completely compatible with ITU G 652 D optical fibers. TeraFlex exceeds the performance standards of ITU G 657 A as listed above.

## ENVIRONMENTAL SPECIFICATIONS

Operation/Storage	-40°C to +70°C
Installation	-10°C to +70°C

## PART NUMBERS AND PHYSICAL CHARACTERISTICS

Part Number <sup>1</sup>	Fiber Count	Cable Component	Connector Type	Length in (ft)	Cable Tensile Load		Cable Bend Radius		Fiber Component Bend Radius	
					Install lbs (N)	Long Term lbs (N)	Install in (mm)	Long Term in (mm)	Install in (mm)	Long Term in (mm)
FF1C-001U13-EC11	1	W7001K101	SCAPC	100	300 (1,350)	90 (405)	3.6 (91)	1.8 (46)	2.2 (56)	1.1 (28)
FF1C-001U13-EC51	1	W7001K101	SCAPC	200	300 (1,350)	90 (405)	3.6 (91)	1.8 (46)	2.2 (56)	1.1 (28)
FF1C-001U13-EBN1	1	W7001K101	SCAPC	300	300 (1,350)	90 (405)	3.6 (91)	1.8 (46)	2.2 (56)	1.1 (28)
FF1C-001U13-EC91	1	W7001K101	SCAPC	400	300 (1,350)	90 (405)	3.6 (91)	1.8 (46)	2.2 (56)	1.1 (28)
FF1C-001U13-ECD1	1	W7001K101	SCAPC	500	300 (1,350)	90 (405)	3.6 (91)	1.8 (46)	2.2 (56)	1.1 (28)
FF1C-001U13-ECH1	1	W7001K101	SCAPC	750	300 (1,350)	90 (405)	3.6 (91)	1.8 (46)	2.2 (56)	1.1 (28)
FF1C-001U13-EA71	1	W7001K101	SCAPC	1000	300 (1,350)	90 (405)	3.6 (91)	1.8 (46)	2.2 (56)	1.1 (28)

# FTTP Tight Buffered Indoor/Outdoor Round Drop

Series WR

## PRODUCT DESCRIPTION

Series WR FTTP is an indoor/outdoor round drop cable that is durable enough for outdoor environments and flexible enough for tight bends within residences. This design utilizes a fully functional 4.5 mm OFNR rated tight buffer cable as the core of a GR-20 OSP rated FTTP small round cable. The key benefit of this cable is that it can be installed from the pedestal to the indoor ONT (Optical Network Terminal) with no intermediate termination. Significant installation savings can be realized by avoiding splicing or termination on the outside or inside wall of the residence. Further savings are realized by using an indoor ONT that does not require an electrician to install. This cable is designed with no rigid strength elements, yet provides the rigidity needed to be pushed short distances into duct for typical FTTH installations. This completely dry, round drop cable is available in universal and toneable designs that are suitable for direct bury or conduit installation. A water-blocking thread is used to prevent water penetration.

## APPLICATIONS

- Drop cables for direct bury or conduit installations
- Fiber to the premise for single family residences

## FEATURES

- Versatile design can be buried or push/pulled through conduit
- No rigid strength rods or elements so cable has no preferential bend
- Indoor/outdoor design
- Meets GR-20 specifications
- Cable in a cable
- TeraFlex® fiber in a flexible tight buffer cable design

## BENEFITS

- Direct bury or conduit, all dielectric
- Excellent crush resistance
- Tight Buffered cable can be placed in a riser environment and is UL listed
- Industry accepted standard for OSP installations
- Eliminates splice at premises wall
- Inner cable can be wrapped around corners and stapled with no attenuation issues

The Series WR round drop is designed for easy access using the MS-26 cable slitting tool from Jonard® Tools.

## ENVIRONMENTAL SPECIFICATIONS

Operation/Storage	-40°C to +70°C
Installation	-20°C to +60°C

Jonard is a registered trademark of Jonard Industries Corporation.

## PART NUMBERS AND PHYSICAL CHARACTERISTICS

	Part Number <sup>1</sup>	Fiber Count	Nominal Diameter in (mm)	Nominal Weight lbs/kft (kg/km)	Cable Tensile Load		Cable Bend Radius		Fiber Component Bend Radius	
					Install lbs (N)	Long Term lbs (N)	Install in (mm)	Long Term in (mm)	Install in (mm)	Long Term in (mm)
Toneable Design (single fiber)	FF2T-001U15-E991	1	0.25 (6.5)	22.4 (33.3)	125 (555)	37 (165)	5 (12.7)	2.5 (64)	2.2 (56)	1.1 (28)
Toneable Design (2 fiber)	FF2T-002U15-E991	2	0.25 (6.5)	22.4 (33.3)	125 (555)	37 (165)	5 (12.7)	2.5 (64)	2.2 (56)	1.1 (28)

See "Optical Fiber Specifications" in the "Technical Info" section for detailed fiber type specifications.

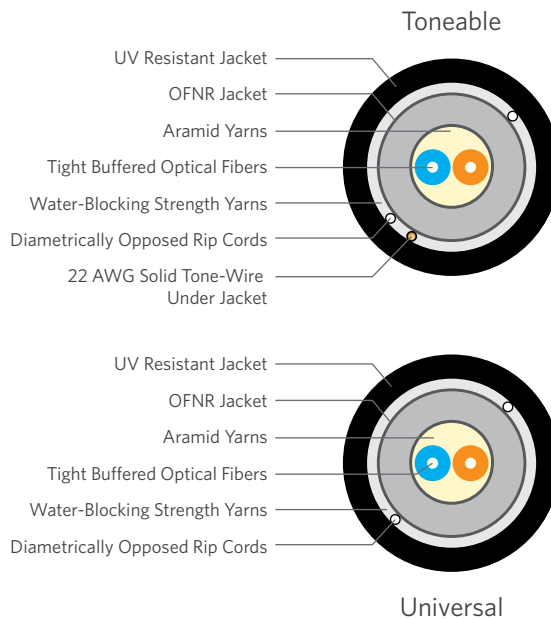

## SPECIFICATIONS

### Standards Compliance

Telcordia® GR-20-CORE  
ICEA S-110-717  
OFNR c(UL) Riser Subunit  
RoHS-compliant

Telcordia is a registered trademark of Ericsson Inc.

# Dri-Lite® Ribbon

Series R1D

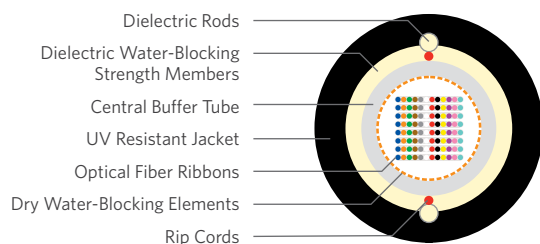

## SPECIFICATIONS

Fiber Count	Available in 12-fiber up to 864-fiber
Standards Compliance	Telcordia® GR-20-CORE RDUP PE-90 Designation R1D

Telcordia is a registered trademark of Ericsson Inc.

## ENVIRONMENTAL SPECIFICATIONS

Operation/Storage	-40°C to +70°C
Installation	-30°C to +70°C

## PART NUMBER KEY

R	1	_	_	_	x	D	0	y
1	2	3	4	5	6	7	8	9
Product family	Fiber count (012-864)	Fiber type	Internal designator	Water block/ marking (1-8)				

Contact Customer Service for availability of non-standard offerings.

## PART NUMBERS AND PHYSICAL CHARACTERISTICS

Part Number <sup>1</sup>	Fiber Count	Nominal Diameter in (mm)	Approx. Weight lbs/kft (kg/km)	Maximum Tensile Loading		Minimum Bend Radius	
				Install lbs (N)	Long Term lbs (N)	Install in (mm)	Long Term in (mm)
R1012xD0y	12	0.48 (12.2)	70 (104)	600 (2,700)	200 (890)	9.6 (244)	4.8 (122)
R1024xD0y	24	0.48 (12.2)	70 (104)	600 (2,700)	200 (890)	9.6 (244)	4.8 (122)
R1048xD0y	48	0.48 (12.2)	70 (104)	600 (2,700)	200 (890)	9.6 (244)	4.8 (122)
R1072xD0y	72	0.56 (14.2)	90 (134)	600 (2,700)	200 (890)	11.2 (284)	5.6 (142)
R1096xD0y	96	0.66 (16.8)	116 (172)	600 (2,700)	200 (890)	13.2 (336)	6.6 (168)
R1144xD0y	144	0.66 (16.8)	119 (177)	600 (2,700)	200 (890)	13.2 (336)	6.6 (168)
R1216xD0y	216	0.74 (18.8)	135 (201)	600 (2,700)	200 (890)	14.8 (376)	7.4 (188)
R1288xD0y	288	0.78 (19.8)	173 (258)	600 (2,700)	200 (890)	15.6 (396)	7.8 (198)
R1360xD0y	360	0.78 (19.8)	173 (258)	600 (2,700)	200 (890)	15.6 (396)	7.8 (198)
R1432xD0y	432	0.78 (19.8)	173 (258)	600 (2,700)	200 (890)	15.6 (396)	7.8 (198)
R1576xD0y	576	0.79 (20.0)	201 (300)	600 (2,700)	200 (890)	15.8 (400)	7.9 (200)
R1864xD0y	864	0.97 (24.7)	244 (367)	600 (2,700)	200 (890)	19.4 (492)	8.7 (221)

## FIBER TYPES:

### SINGLE MODE

	Reduced Water Peak	Zero Water Peak	TeraFlex® Bend Resistant G.657.A1	NZDS	LEAF
<sup>1</sup> Replace "x" with:	3	2	K	8	S

See "Optical Fiber Specifications" in the "Technical Info" section for detailed fiber type specifications.

## PRODUCT DESCRIPTION

Dri-Lite® Ribbon Cable is a totally gel-free cable. The cable is designed for Outside Plant (OSP) application, specifically lashed aerial and underground duct applications. Our industry leading optical ribbons are manufactured with high dimensional precision and low planarity, which equates to low losses during mass fusion splicing. The Dri-Lite Ribbon cable features optical ribbons inside a gel-free tube which contains dry water-blocking elements. The core tube contains up to twenty-four 12-fiber or 24-fiber ribbons. Each ribbon unit is discretely identified and captured in an easy peel matrix for ease of ribbon breakout and management. The core tube is wrapped with a water-blocking tape. Longitudinal strength elements are applied over the core tube and encased within a black jacket. A rip cord is included under the jacket for easy access to the core tube.

## APPLICATIONS

- Lashed aerial
- Underground duct
- Broadband network

## FEATURES

- Gel-free water-blocking technology
- Available with up to 864-fiber
- Multiple fiber types available
- Highly flexible tube
- Meets or exceeds Telcordia® and RDUP specifications
- Industry leading planarity

## BENEFITS

- Reduces preparation time and labor cost
- High fiber density
- Multiple network applications
- Easier handling and reduced loss
- Industry approved
- Excellent mass splicing results

## WATER BLOCK AND JACKET PRINT CODES

	Dry core		Dry core special	
<sup>1</sup> Replace "y" with:	Feet	Meters	Feet	Meters
	1	2	5	6



# Dri-Lite® Ribbon Single Armor

## Series R2D

### PRODUCT DESCRIPTION

Dri-Lite® Ribbon Single Armor Cable is a totally gel-free cable designed for Outside Plant (OSP) application, specifically direct buried, lashed aerial and underground duct applications. Our industry leading optical ribbons are manufactured with high dimensional precision and low planarity, which equates to low losses during mass fusion splicing. The cable features optical ribbons inside a gel-free tube which contains dry water-blocking elements. The core tube contains up to twenty-four 12-fiber or 24-fiber ribbons. Each ribbon unit is discretely identified and captured in an easy peel matrix for ease of ribbon breakout and management. The core tube is wrapped with a water-blocking tape. A corrugated steel armor and longitudinal strength elements are applied over the core tube and encased within a black jacket. Rip cords are included under the armor for easy access to the core tube.

### APPLICATIONS

- Direct bury
- Lashed aerial
- Underground duct
- Broadband network

### FEATURES

- Gel-free water-blocking technology
- Available with up to 576-fiber
- Multiple fiber types available
- Highly flexible tube
- Meets or exceeds Telcordia® and RDUP specifications
- Industry leading planarity

### BENEFITS

- Reduces preparation time and labor cost
- High fiber density
- Multiple network applications
- Easier handling and reduced loss
- Industry approved
- Excellent mass splicing results

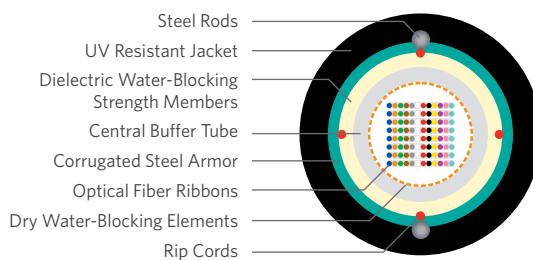
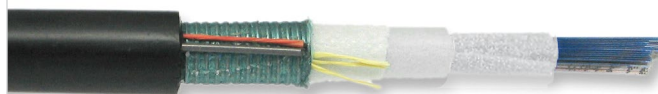

### SPECIFICATIONS

<b>Fiber Count</b>	Available in 12-fiber up to 864-fiber
<b>Standards Compliance</b>	Telcordia® GR-20-CORE RDUP PE-90 Designation R2D

Telcordia is a registered trademark of Ericsson Inc.

### ENVIRONMENTAL SPECIFICATIONS

<b>Operation/Storage</b>	-40°C to +70°C
<b>Installation</b>	-30°C to +70°C

### PART NUMBER KEY

R	2	-	-	-	x	D	S	y
1	2	3	4	5	6	7	8	9
Product family	Fiber count (012-864)	Fiber type	Internal designator	Water block/ marking (1-8)				

Contact Customer Service for availability of non-standard offerings.

### PART NUMBERS AND PHYSICAL CHARACTERISTICS

Part Number <sup>1</sup>	Fiber Count	Nominal Diameter in (mm)	Approx. Weight lbs/kft (kg/km)	Maximum Tensile Loading		Minimum Bend Radius	
				Install lbs (N)	Long Term lbs (N)	Install in (mm)	Long Term in (mm)
R2012xDSy	12	0.51 (13.0)	110 (164)	600 (2,700)	200 (890)	10.2 (260)	5.1 (130)
R2024xDSy	24	0.51 (13.0)	110 (164)	600 (2,700)	200 (890)	10.2 (260)	5.1 (130)
R2048xDSy	48	0.59 (15.0)	132 (197)	600 (2,700)	200 (890)	11.8 (300)	5.9 (150)
R2072xDSy	72	0.59 (15.0)	134 (199)	600 (2,700)	200 (890)	11.8 (300)	5.9 (150)
R2096xDSy	96	0.69 (17.4)	165 (251)	600 (2,700)	200 (890)	13.8 (348)	6.9 (174)
R2144xDSy	144	0.69 (17.4)	168 (251)	600 (2,700)	200 (890)	13.8 (348)	6.9 (174)
R2192xDSy	192	0.77 (19.6)	197 (292)	600 (2,700)	200 (890)	15.4 (392)	7.7 (196)
R2216xDSy	216	0.77 (19.6)	198 (295)	600 (2,700)	200 (890)	15.4 (392)	7.7 (196)
R2288xDSy	288	0.84 (21.3)	226 (337)	600 (2,700)	200 (890)	16.8 (437)	8.4 (219)
R2360xDSy	360	0.84 (21.3)	226 (337)	600 (2,700)	200 (890)	16.8 (437)	8.4 (219)
R2432xDSy	432	0.84 (21.3)	226 (337)	600 (2,700)	200 (890)	16.8 (437)	8.4 (219)
R2576xDSy	576	0.88 (22.4)	263 (392)	600 (2,700)	200 (890)	17.6 (448)	8.8 (224)
R2864xDSy	864	1.00 (25.4)	345 (515)	600 (2,700)	200 (890)	20.0 (508)	10.0 (254)

### FIBER TYPES:

### SINGLE MODE

Reduced Water Peak	Zero Water Peak	TeraFlex® Bend Resistant G.657.A1	NZDS	LEAF
--------------------	-----------------	-----------------------------------	------	------

<sup>1</sup>Replace "x" with:

3	2	K	8	S
---	---	---	---	---

See "Optical Fiber Specifications" in the "Technical Info" section for detailed fiber type specifications.

### WATER BLOCK AND JACKET PRINT CODES

	Dry core		Dry core special	
	Feet	Meters	Feet	Meters

<sup>1</sup>Replace "y" with: 1 2 5 6

# Stranded Loose Tube Ribbon Single Jacket All Dielectric

Series S1

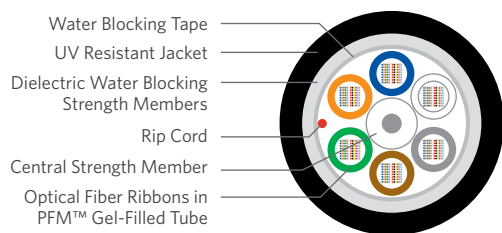

## PRODUCT DESCRIPTION

Stranded Loose Tube Ribbon Single Jacket Cable is designed for Outside Plant (OSP) applications for aerial and conduit installations. Our industry leading optical fiber ribbons are manufactured with high dimensional precision and low planarity which equates to low losses during mass fusion splicing. The stranded Loose tube design features optical fibers ribbons placed inside gel-filled tubes that are SZ stranded around a central strength member. Each tube contains up to 12 discretely identified, 12-fiber ribbons for maximum design load capacity of 864 optical fibers. The core is helically wrapped with water-blocking strength members. This design offers high-density fiber options in a flexible in a cable design.

## APPLICATIONS

- Aerial and conduit
- Broadband network
- Local loop
- Trunk, distribution and feeder cables

## FEATURES

- Available with up to 864-fiber
- Multiple fiber types available
- Multiple stranded tubes
- Ribbon fiber

## BENEFITS

- High fiber density
- Multiple network applications
- Individual tube access
- Saves labor cost by offering mass fusion splicing

## SPECIFICATIONS

Fiber Count	Available in 288-fiber up to 864-fiber
Standards Compliance	Telcordia® GR-20-CORE RDUP PE-90 Designation S2 RoHS-compliant

Telcordia is a registered trademark of Ericsson Inc. Corning is a registered trademark of Corning Incorporated.

## ENVIRONMENTAL SPECIFICATIONS

Operation/Storage	-40°C to +70°C
Installation	-30°C to +70°C

## PART NUMBERS AND PHYSICAL CHARACTERISTICS

Part Number <sup>1</sup>	Fiber Count	Nominal Diameter in (mm)	Nominal Weight lbs/kft (kg/km)	Maximum Tensile Loading		Minimum Bend Radius	
				Install lbs (N)	Long Term lbs (N)	Install in (mm)	Long Term in (mm)
S12883101	288	1.04 (26.5)	291.2 (434)	600 (2,700)	180 (800)	20.8 (530)	10.4 (265)
S14323101	432	1.04 (26.5)	291.2 (434)	600 (2,700)	180 (800)	20.8 (530)	10.4 (265)
S15763101	576	1.04 (26.5)	291.2 (434)	600 (2,700)	180 (800)	20.8 (530)	10.4 (265)
S17203101	720	1.04 (26.5)	291.2 (434)	600 (2,700)	180 (800)	20.8 (530)	10.4 (265)
S18643101	864	1.04 (26.5)	291.2 (434)	600 (2,700)	180 (800)	20.8 (530)	10.4 (265)



All information, content, data, specifications, packaging and part numbers detailed herein are subject to change. For the most up-to-date information, please visit [SuperiorEssexCommunications.com](http://SuperiorEssexCommunications.com). Purchase of this product is subject exclusively to the then current **Superior Essex International LP Terms and Conditions of Sale for Communications Cable, Wire and Connectivity Products**, which can be found on our website, [SuperiorEssexCommunications.com](http://SuperiorEssexCommunications.com), or provided to you upon request.

800.551.8948

[SuperiorEssexCommunications.com](http://SuperiorEssexCommunications.com)



# Stranded Loose Tube Ribbon Single Armor

Series S2

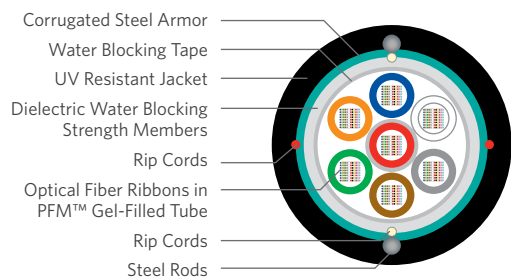

## PRODUCT DESCRIPTION

Stranded Tube Ribbon Single Armor Cable is designed for Outside Plant (OSP) applications specifically direct bury installations. Our industry leading optical fiber ribbons are manufactured with high dimensional precision and low planarity which equates to low losses during mass fusion splicing. The stranded tube design features optical fibers ribbons placed inside gel-filled tubes. Each tube contains up to 12 discretely identified, 12-fiber ribbons for maximum design load capacity of 1,008 optical fibers. The core is helically wrapped with water-blocking strength members. A corrugated steel armor is applied over the stranded core. Rigid steel rods encased in a outer jacket completes the construction. Rip cords are included under the armor for ease of entry.

## APPLICATIONS

- Direct bury
- Broadband network
- Local loop
- Trunk, distribution and feeder cables

## FEATURES

- Available with up to 1,008-fiber
- Multiple fiber types available
- Multiple stranded tubes
- Corrugated steel armor
- Ribbon fiber

## BENEFITS

- High fiber density
- Multiple network applications
- Individual tube access
- Compressive strength, rodent protection and ease of location
- Saves labor cost by offering mass fusion splicing

## SPECIFICATIONS

<b>Fiber Count</b>	Available in 360-fiber up to 1,008-fiber
<b>Standards Compliance</b>	Telcordia® GR-20-CORE RDUP PE-90 Designation S2 RoHS-compliant

Telcordia is a registered trademark of Ericsson Inc. Corning is a registered trademark of Corning Incorporated.

## ENVIRONMENTAL SPECIFICATIONS

<b>Operation/Storage</b>	-40°C to +70°C
<b>Installation</b>	-30°C to +70°C

## PART NUMBER KEY

S	2	-	-	-	x	1	0	y
1	2	3	4	5	6	7	8	9
Product family	Fiber count (360-1,008)	Fiber type	Internal designator	Water block/ marking (1-8)				

Contact Customer Service for availability of non-standard offerings.

## PART NUMBERS AND PHYSICAL CHARACTERISTICS

Part Number <sup>1</sup>	Fiber Count	Nominal Diameter in (mm)	Nominal Weight lbs/kft (kg/km)	Maximum Tensile Loading		Minimum Bend Radius	
				Install lbs (N)	Long Term lbs (N)	Install in (mm)	Long Term in (mm)
S2360x10y	360	1.27 (32.2)	536 (797)	600 (2,700)	180 (800)	25.4 (644)	12.7 (322)
S2432x10y	432	1.27 (32.2)	536 (797)	600 (2,700)	180 (800)	25.4 (644)	12.7 (322)
S2576x10y	576	1.27 (32.2)	536 (797)	600 (2,700)	180 (800)	25.4 (644)	12.7 (322)
S2720x10y	720	1.27 (32.2)	536 (797)	600 (2,700)	180 (800)	25.4 (644)	12.7 (322)
S2864x10y	864	1.27 (32.2)	536 (797)	600 (2,700)	180 (800)	25.4 (644)	12.7 (322)
S2A08x10y	1,008	1.27 (32.2)	536 (797)	600 (2,700)	180 (800)	25.4 (644)	12.7 (322)

## FIBER TYPES:

### SINGLE MODE

Reduced Water Peak	Zero Water Peak	TeraFlex® Bend Resistant G.657.A1	NZDS	LEAF	Corning® 28E+
--------------------	-----------------	-----------------------------------	------	------	---------------

<sup>1</sup>Replace "x" with:

3	2	K	8	S	R
---	---	---	---	---	---

See "Optical Fiber Specifications" in the "Technical Info" section for detailed fiber type specifications.

## WATER BLOCK AND JACKET PRINT CODES

Dry core	Dry core special		
Feet	Meters	Feet	Meters

<sup>1</sup>Replace "y" with:

1	2	5	6
---	---	---	---

## PRODUCT DESCRIPTION

Single Tube Ribbon Cable is designed for Outside Plant (OSP) applications, specifically lashed aerial and underground duct installations. Our industry leading optical ribbons are manufactured with high dimensional precision and low planarity, which equates to low losses during mass fusion splicing. The Single Tube Ribbon Cable features optical ribbons inside a single PFM™ gel-filled tube. The core tube includes up to twenty-four 12-fiber or 24-fiber ribbons. Each 12-fiber ribbon unit is discretely identified and captured in an easy peel matrix for ease of ribbon breakout and management. The core tube is wrapped with a water-blocking tape. Longitudinal strength elements are applied over the core tube and encased within a black jacket. A rip cord is included under the jacket for easy access to the core tube.

## APPLICATIONS

- Lashed aerial, underground duct
- Broadband network
- Local loop
- Trunk, distribution and feeder cables

## FEATURES

- Available with up to 576-fiber
- Multiple fiber types available
- Dielectric strength members
- Highly flexible tube
- Ribbon fiber
- Meets or exceeds Bellcore and RDUP specifications
- PFM gel

## BENEFITS

- High fiber density
- Multiple network applications
- Dielectric design eliminates grounding issues
- Easy handling and easy tube access
- Saves labor cost by offering mass fusion splicing
- Industry approved
- Non-sticky gel allows for easier and faster clean up

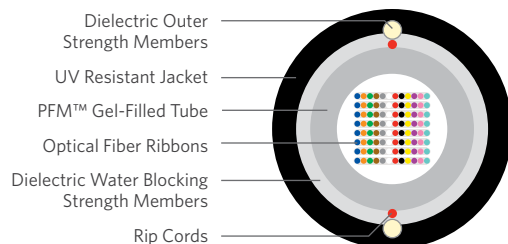

## SPECIFICATIONS

<b>Fiber Count</b>	Available in 12-fiber up to 576-fiber
<b>Standards Compliance</b>	Telcordia® GR-20-CORE RDUP PE-90 Designation SLT-R RoHS-compliant

Telcordia is a registered trademark of Ericsson Inc.

## ENVIRONMENTAL SPECIFICATIONS

<b>Operation/Storage</b>	-40°C to +70°C
<b>Installation</b>	-30°C to +70°C

## PART NUMBER KEY

R	1	—	—	—	x	1	0	y
1	2	3	4	5	6	7	8	9
Product family	Fiber count (012-432)				Fiber type	Internal designator	Water block/ marking (1-8)	

Contact Customer Service for availability of non-standard offerings.

## PART NUMBERS AND PHYSICAL CHARACTERISTICS

Part Number <sup>1</sup>	Fiber Count	Nominal Diameter in (mm)	Nominal Weight lbs/kft (kg/km)	Maximum Tensile Loading		Minimum Bend Radius	
				Install lbs (N)	Long Term lbs (N)	Install in (mm)	Long Term in (mm)
R1012x10y	12	0.47 (12.0)	71 (106)	600 (2,700)	200 (890)	9.4 (239)	4.7 (119)
R1048x10y	48	0.47 (11.9)	71 (106)	600 (2,700)	200 (890)	9.4 (239)	4.7 (119)
R1072x10y	72	0.57 (14.5)	96 (143)	600 (2,700)	200 (890)	11.4 (290)	5.7 (145)
R1096x10y	96	0.57 (14.5)	96 (143)	600 (2,700)	200 (890)	11.4 (290)	5.7 (145)
R1144x10y	144	0.63 (15.9)	120 (178)	600 (2,700)	200 (890)	12.6 (320)	6.3 (160)
R1216x10y	216	0.67 (17.0)	138 (206)	600 (2,700)	200 (890)	13.4 (340)	6.7 (170)
R1288x10y	288	0.79 (20.0)	180 (267)	600 (2,700)	200 (890)	15.8 (401)	7.9 (201)
R1432x10y	432	0.79 (20.0)	188 (280)	600 (2,700)	200 (890)	15.8 (401)	7.9 (201)
R1576x10y	576	0.79 (20.0)	237 (353)	600 (2,700)	200 (890)	18.4 (465)	7.9 (201)

## FIBER TYPES:

### SINGLE MODE

Reduced Water Peak	Zero Water Peak	TeraFlex® Bend Resistant G.657.A1	NZDS	LEAF
--------------------	-----------------	-----------------------------------	------	------

<sup>1</sup>Replace "x" with:

3	2	K	8	S
---	---	---	---	---

See "Optical Fiber Specifications" in the "Technical Info" section for detailed fiber type specifications.

## WATER BLOCK AND JACKET PRINT CODES

Dry core		Dry core special	
Feet	Meters	Feet	Meters

<sup>1</sup>Replace "y" with:

1	2	5	6
---	---	---	---

# Single Tube Ribbon Single Armor

Series R2

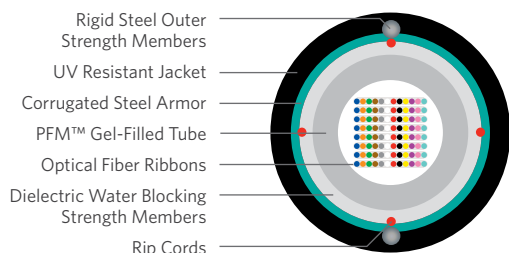
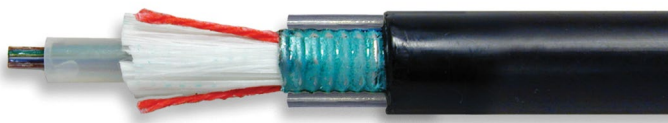

## PRODUCT DESCRIPTION

Single Tube Ribbon Single Armor Cable is designed for Outside Plant (OSP) applications, specifically direct buried, lashed aerial and underground duct applications. Our industry leading optical ribbons are manufactured with high dimensional precision and low planarity, which equates to low losses during mass fusion splicing. The Single Tube Ribbon Single Armor cable features optical ribbons inside a single PFM™ gel-filled tube. The core tube includes up to twenty-four 12-fiber or 24-fiber ribbons. Each 12-fiber ribbon unit is discretely identified and captured in an easy peel matrix for ease of ribbon breakout and management. The core tube is wrapped with a water-blocking tape. A corrugated steel armor and longitudinal strength elements are applied over the core tube and encased within a black jacket. Rip cords are included under the armor for easy access to the core tube.

## APPLICATIONS

- Direct bury
- Broadband network
- Local loop
- Trunk, distribution and feeder cables

## FEATURES

- Available with up to 576-fiber
- Multiple fiber types available
- Metallic outer strength members
- Highly flexible tube
- Corrugated steel armor
- Ribbon fiber
- Meets or exceeds Bellcore and RDUP specifications
- PFM gel

## BENEFITS

- High fiber density
- Multiple network applications
- Metallic design offers easy location
- Easy handling and easy tube access
- Compressive strength, rodent protection and ease of location
- Saves labor cost by offering mass fusion splicing
- Industry approved
- Non-sticky gel allows for easier and faster clean up

## SPECIFICATIONS

<b>Fiber Count</b>	Available in 12-fiber up to 576-fiber
<b>Standards Compliance</b>	Telcordia® GR-20-CORE RDUP PE-90 Designation SLT-R RoHS-compliant

Telcordia is a registered trademark of Ericsson Inc.

## ENVIRONMENTAL SPECIFICATIONS

<b>Operation/Storage</b>	-40°C to +70°C
<b>Installation</b>	-30°C to +70°C

## PART NUMBER KEY

R	2	_	_	_	x	1	S	y
1	2	3	4	5	6	7	8	9
Product family	Fiber count (012-576)	Fiber type	Internal designator	Water block/ marking (1-8)				

Contact Customer Service for availability of non-standard offerings.

## PART NUMBERS AND PHYSICAL CHARACTERISTICS

Part Number <sup>1</sup>	Fiber Count	Nominal Diameter in (mm)	Nominal Weight lbs/kft (kg/km)	Maximum Tensile Loading		Minimum Bend Radius	
				Install lbs (N)	Long Term lbs (N)	Install in (mm)	Long Term in (mm)
R2012x1Sy	12	0.51 (13.0)	118 (175)	600 (2,700)	200 (890)	10.2 (259)	5.1 (130)
R2024x1Sy	24	0.51 (13.0)	118 (175)	600 (2,700)	200 (890)	10.2 (259)	5.1 (130)
R2036x1Sy	36	0.51 (13.0)	118 (175)	600 (2,700)	200 (890)	10.2 (259)	5.1 (130)
R2048x1Sy	48	0.51 (13.0)	118 (175)	600 (2,700)	200 (890)	10.2 (259)	5.1 (130)
R2072x1Sy	72	0.58 (15.0)	150 (223)	600 (2,700)	200 (890)	11.6 (295)	5.8 (147)
R2096x1Sy	96	0.58 (15.0)	150 (223)	600 (2,700)	200 (890)	11.6 (295)	5.8 (147)
R2144x1Sy	144	0.66 (17.0)	187 (279)	600 (2,700)	200 (890)	13.2 (335)	6.0 (152)
R2192x1Sy	192	0.66 (17.0)	195 (290)	600 (2,700)	200 (890)	13.6 (345)	6.8 (173)
R2216x1Sy	216	0.66 (17.0)	195 (290)	600 (2,700)	200 (890)	13.6 (345)	6.8 (173)
R2288x1Sy	288	0.84 (21.0)	256 (381)	600 (2,700)	200 (890)	16.8 (420)	8.4 (210)
R2360x1Sy	360	0.84 (21.0)	256 (381)	600 (2,700)	200 (890)	16.8 (420)	8.4 (210)
R2432x1Sy	432	0.84 (21.0)	256 (381)	600 (2,700)	200 (890)	16.8 (420)	8.4 (210)
R2576x1Sy	576	0.93 (23.5)	288 (430)	600 (2,700)	200 (890)	18.6 (470)	9.3 (235)

## FIBER TYPES:

## SINGLE MODE

Reduced Water Peak	Zero Water Peak	TeraFlex® Bend Resistant G.657.A1	NZDS	LEAF
--------------------	-----------------	-----------------------------------	------	------

<sup>1</sup>Replace "x" with:

3	2	K	8	S
---	---	---	---	---

See "Optical Fiber Specifications" in the "Technical Info" section for detailed fiber type specifications.

## WATER BLOCK AND JACKET PRINT CODES

Dry core		Dry core special	
Feet	Meters	Feet	Meters

<sup>1</sup>Replace "y" with:

1	2	5	6
---	---	---	---

## PRODUCT DESCRIPTION

Compact micro loose tube fiber optic cables are designed for air-blown outside plant microduct installations. Optical fibers are placed inside filled buffer tubes containing PFM™ Gel. The core is a familiar stranded loose tube design with buffer tubes around a central member using a reverse oscillating lay (ROL). The core is wrapped with flexible, water-blocking strength members then encased with a black polyethylene jacket. A rip cord is included under the jacket for ease of entry.

## APPLICATIONS

- Air-blown OSP Installation

## FEATURES

- Available in 24-fiber up to 288-fiber
- Dry (SAP) core standard
- PFM™ Gel filled tubes

## BENEFITS

- High fiber density
- Reduces cable prep and installation time
- Eases cable prep

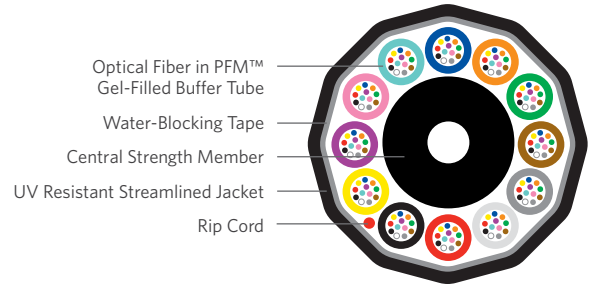

## SPECIFICATIONS

Fiber Count	Available in 12-fiber up to 288-fiber
Standards Compliance	Tested in Accordance with IEC 60794, GR-20, Issue 4 (6.9.5 Micro-Duct Cable)

## ENVIRONMENTAL SPECIFICATIONS

Operation	-40°C to +70°C
Storage/Shipping	-40°C to +70°C
Installation	-20°C to +70°C

## PART NUMBERS AND PHYSICAL CHARACTERISTICS

Part Number	Fiber Count	Nominal Outside Diameter in (mm)	Nominal Weight lbs/kft (kgm/km)	Maximum Compression N/100cm	Minimum Bend Radius in (mm)	Maximum Tensile Loading lbs (N)
FJ12-024U10-E991	24	0.23 (5.9)	19.82 (29.49)	50	2.3 (59)	135 (600)
FJ12-036U10-E991	36	0.23 (5.9)	19.82 (29.49)	50	2.3 (59)	135 (600)
FJ12-048U10-E991	48	0.23 (5.9)	19.82 (29.49)	50	2.3 (59)	135 (600)
FJ12-072U10-E991	72	0.23 (5.9)	19.82 (29.49)	50	2.3 (59)	135 (600)
FJ12-096U10-E991	96	0.27 (6.9)	20.50 (30.50)	50	2.7 (69)	135 (600)
FJ12-144U10-E991	144	0.32 (8.2)	43.93 (65.36)	50	3.2 (82)	300 (1334)
FJ12-216U10-E991	216	0.42 (10.6)	60.53 (90.10)	80	4.2 (106)	330 (1468)
FJ12-288U10-E991	288	0.42 (10.6)	60.53 (90.10)	80	4.2 (106)	330 (1468)

# Telco Hybrid Right of Way

Series MR

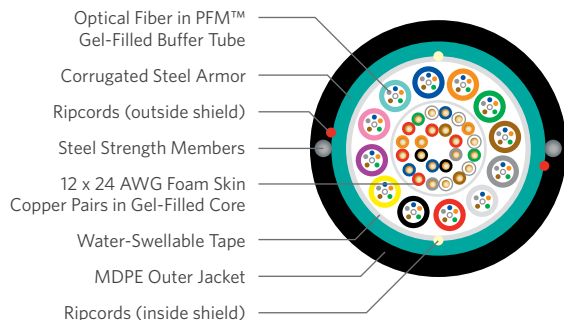

## PRODUCT DESCRIPTION

The Telco Hybrid Right of Way Series MR cable is designed to meet the network requirements for both twisted copper pair and optical fiber. The small 0.65 inch (16.6 mm) profile of this design easily fits into a 1-inch conduit. The cable operates within a temperature range of -40°C to +70°C, provides a maximum tensile strength of 600 lbs, and incorporates 12, 24 AWG twisted copper pairs and up to 72 strands of optical fiber. The core, 12 pairs of 24 AWG gel-filled copper, is surrounded by 12 gel-filled tubes each containing 6 optical fibers. The core is waterblocked with super absorbent polymers and then encased in a steel armor. Two steel rods for anti-buckling are included in the outer jacket.

## APPLICATIONS

- Small conduits

## FEATURES

- Fiber and twisted copper pair
- Single unit construction
- Available with up to 72-fiber
- Small nominal diameter

## BENEFITS

- Offers the maximum bandwidth for FTTP business, etc.
- Lower installation costs
- High capacity
- Suitable for small (1 inch) conduit applications

## OSP COPPER SPECIFICATIONS

Conductor	12-pair 24 AWG (0.51 mm) solid annealed copper
Core Filling	Thixotropic gel

## OPTICAL FIBER SPECIFICATIONS

Construction	Stranded loose tube design features optical fibers placed inside a PFM™ gel-filled tube
Fiber Count	Up to 72 optical fibers

## HYBRID SPECIFICATIONS

Construction	Copper pairs at center of cable surrounded by stranded loose tubes of optical fiber
Water Block	Super absorbent polymer tape
Shield	Corrugated steel armor
Strength Members	Two steel strength members embedded in jacket
Jacket	MDPE
Standards Compliance	Telcordia® GR-20-CORE ICEA S-84-608-2007

Telcordia is a registered trademark of Ericsson Inc.

## ENVIRONMENTAL SPECIFICATIONS

Operation/Storage	-40°C to +70°C
Installation	-30°C to +70°C

## PART NUMBERS AND PHYSICAL CHARACTERISTICS

Part Number	Fiber Count	Fiber Type	Nominal Diameter in (mm)	Approx. Weight lbs/kft (kg/km)	Install Bend Radius in (mm)	Maximum Tensile Load	
						Install lbs (N)	Long Term lbs (N)
MR0723011	72	RWP SMF	0.65 (16.6)	160 (237)	13 (332)	600 (2,700)	200 (890)

Part number listed are RWP single mode optical fiber only. Other fiber types are available. See "Optical Fiber Specifications" in the "Technical Info" section for detailed fiber type specifications.



# Telco Hybrid Line Powering

## Series MR

### PRODUCT DESCRIPTION

This Telco Hybrid Line Powering cable is designed to meet the new network requirements for providing data via optical fiber and line powering via the copper twisted pairs in the cable. The small 0.79 inch (20.3 mm) profile of this design easily fits into a 1-inch conduit. The cable operates within a temperature range of -40°C to +70°C, provides a maximum tensile strength of 600 lbs., and incorporates 25 pairs of 22 AWG twisted copper pairs and up to 192 optical fibers. The core, 25 pairs of 22 AWG gel filled copper, is surrounded by 16 gel filled buffer tubes each containing 12 optical fibers. The cable core is water blocked with super absorbent polymers and then encased in a steel armor. The outer jacket is sunlight resistant MDPE.

### APPLICATIONS

- Small Cells
- Remote DSLAM's
- Remote PON Cabinet

### FEATURES

- Single unit construction
- Fiber and copper under one jacket

### BENEFITS

- Lower installation costs for a single cable
- Optimized for Greenfield deployments

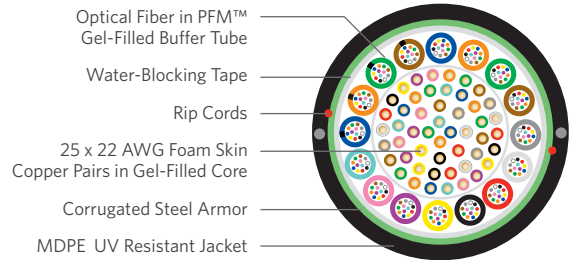

### HYBRID SPECIFICATIONS

Construction	Copper pairs at center of cable surrounded by stranded loose tubes of optical fiber
Water Block	Super absorbent polymer tape
Shield	Corrugated steel armor
Strength Members	Fiberglass yarn over the stranded core
Jacket	MDPE
Standards Compliance	Telcordia® GR-20-CORE ICEA S-84-608-2007

Telcordia is a registered trademark of Ericsson Inc.

### ENVIRONMENTAL SPECIFICATIONS

Operation/Storage	-40°C to +70°C
Installation	-30°C to +70°C

### OSP COPPER SPECIFICATIONS

Conductor	25-pair 22 AWG (0.64 mm) solid annealed copper
Core Filling	Thixotropic gel

### OPTICAL FIBER SPECIFICATIONS

Construction	Stranded loose tube design features optical fibers placed inside a PFM™ gel-filled tube
Fiber Count	Up to 192 optical fibers

### PART NUMBERS AND PHYSICAL CHARACTERISTICS

Part Number	Fiber Count	Fiber Type	Nominal Diameter in (mm)	Approx. Weight lbs/kft (kg/km)	Install Bend Radius in (mm)	Maximum Tensile Load	
						Install lbs (N)	Long Term lbs (N)
FG21-192U10-E991-C0F	192	RWP SMF	0.80 (20.3)	290 (132)	16 (406)	600 (2,700)	200 (890)

# Telco Hybrid Web Drop, Category 5e & OSP Fiber

Series 5F

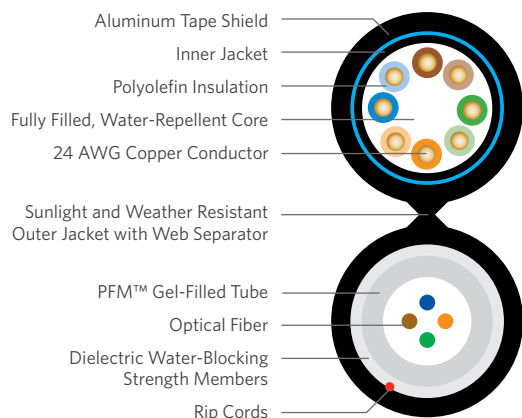
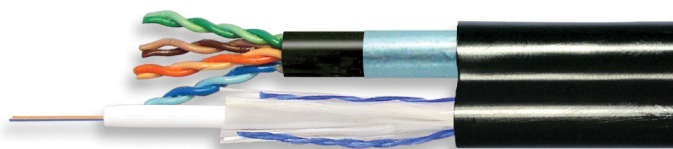

## PRODUCT DESCRIPTION

Series 5F combines the broadband performance of CAT 5e with the unlimited capacity of optical fiber. A BBDNe CAT 5e Outside Plant (OSP) cable and a Series 513 optical fiber cable are overjacketed into one cable in order to offer flexibility and ease of installation.

## APPLICATIONS

- Drop cables
- Broadband network
- Fiber to the premise

## FEATURES

- Fiber and CAT 5e
- Overjacket design
- Single unit construction
- Available with 1-fiber up to 12-fiber
- PFM™ gel

## BENEFITS

- Offers the maximum bandwidth for FTTP business, etc.
- Ease of use
- Lower installation costs
- High capacity
- Non-sticky gel reduces installation time and labor cost

## OSP COPPER SPECIFICATIONS

Conductor	CAT 5e 4-pair 24 AWG solid annealed copper
Core Filling	Thixotropic gel
Shield	Coated smooth aluminum tape
Water Block	Super absorbent polymer

## OPTICAL FIBER SPECIFICATIONS

Construction	Series 513 single loose tube design with optical fibers placed inside a PFM gel-filled tube
Fiber Count	Up to 12 optical fibers
Strength Members	Core is helically wrapped with dielectric water-blocking strength members
Water Block	Super absorbent polymer

## HYBRID SPECIFICATIONS

Single Jacket Design	Copper and fiber independent cables are jacketed into one cable in order to offer flexibility and ease of installation
Standards Compliance	Copper and fiber cables meet applicable Telcordia® and TIA standards

Telcordia is a registered trademark of Ericsson Inc.

## ENVIRONMENTAL SPECIFICATIONS

Operation/Storage	-40°C to +70°C
Installation	-30°C to +70°C

## PART NUMBERS AND PHYSICAL CHARACTERISTICS

Part Number	Fiber Count	Fiber Type	Nominal Diameter in (mm)	Approx. Weight lbs/kft (kg/km)	Bend Radius in (mm)	Maximum Tensile Load		Standard Quantity ft (m)
						Install lbs (N)	Long Term lbs (N)	
11-003-30	4	RWP SMF	0.63 (16) x 0.43 (10.9)	100 (148.8)	5.5 (139.7)	300 (136)	100 (45)	5,000 (1,524)

Part number listed are RWP single mode optical fiber only. Other fiber types are available. See "Optical Fiber Specifications" in the "Technical Info" section for detailed fiber type specifications.

# Telco Hybrid Web Drop, OSP Copper & Fiber

Series 5W

## PRODUCT DESCRIPTION

Series 5W combines fiber and copper technologies in a web design. The hybrid design provides a cost benefit compared to installing separate fiber and copper cables. The independent Series 513 optical fiber cable and the BSW Outside Plant (OSP) copper cable are combined in a single jacket design utilizing a web separator. This lightweight design is easy to access since the cables are easily separated at the web. In addition, each independent cable also contains a rip cord.

## APPLICATIONS

- Network power and FTTP
- Drop cables

## FEATURES

- Independent fiber and copper cables combined in a web design
- Web design
- Combined transport technologies in one cable
- Optical/electrical technology
- Multiple fiber types available
- PFM™ gel

## BENEFITS

- Reduces cost of cable and labor
- Easy separation of technologies
- Cost-effective installation
- Ideal for multiple projects, voice, video, data and powering
- Multiple applications
- Non-sticky gel reduces installation time and labor cost

## HYBRID SPECIFICATIONS

Single Jacket Design	Copper and fiber jackets joined by a web separator that can be split to direct the cables to separate locations
Standards Compliance	Copper and fiber cables meet applicable Telcordia®, RDUP and ICEA specifications RoHS-compliant

Telcordia is a registered trademark of Ericsson Inc.

## ENVIRONMENTAL SPECIFICATIONS

Operation/Storage	-40°C to +70°C
Installation	-30°C to +70°C

## PART NUMBERS AND PHYSICAL CHARACTERISTICS

Part Number	Copper Pair Count x AWG	Fiber Count	Fiber Type	Nominal Diameter		Approx. Weight lbs/kft (kg/km)	Package
				Copper Component in (mm)	Fiber Component in (mm)		
5W002302Q	2 x 19	2	RWP SMF	0.31 (7.9)	0.26 (6.7)	131 (195)	8,000' Reel
71-202-12	5 x 19	2	RWP SMF	0.36 (9.1)	0.26 (6.7)	179 (266)	8,000' Reel
5W002301Q	2 x 22	2	RWP SMF	0.27 (6.9)	0.26 (6.7)	114 (170)	8,000' Reel
5W002303Q	5 x 22	2	RWP SMF	0.32 (8.1)	0.26 (6.7)	136 (202)	8,000' Reel
5W004301Q	6 x 22	4	RWP SMF	0.36 (9.1)	0.26 (6.7)	149 (222)	8,000' Reel

Part numbers listed are RWP single mode optical fiber only. Other fiber types are available. See "Optical Fiber Specifications" in the "Technical Info" section for detailed fiber type specifications.

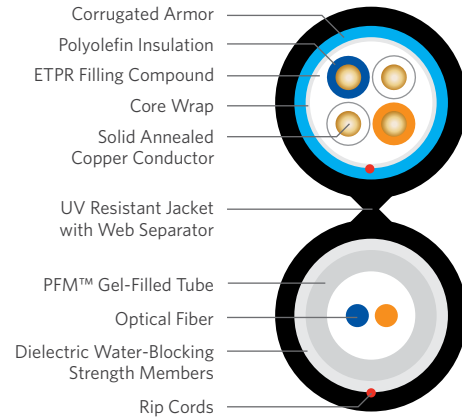

## BSW OSP COPPER SPECIFICATIONS

Conductor	Solid annealed copper
Insulation	Solid polyolefin
Core Wrap	Non-hygroscopic
Filling Compound	80°C ETPR compound for water-blocking protection
Shield	Corrugated armor

## OPTICAL FIBER SPECIFICATIONS

Construction	Series 513 single loose tube design features optical fibers placed inside a PFM gel-filled tube
Fiber Count	Up to 12 optical fibers
Strength Members	Core is helically wrapped with dielectric water-blocking strength members

# Telco Hybrid Overjacket Drop, OSP Copper & Fiber

Series 71 OJ

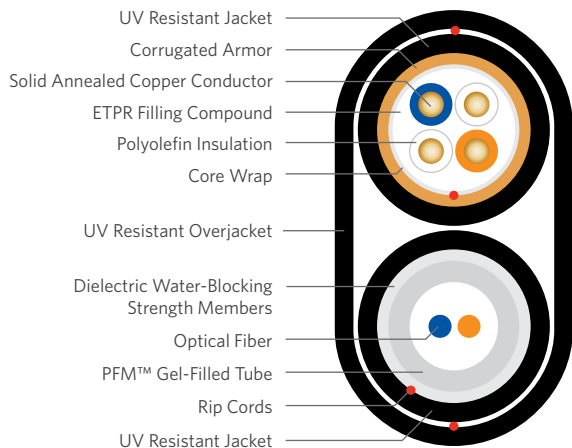
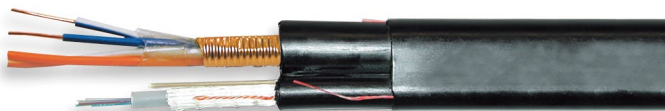

## PRODUCT DESCRIPTION

Series 71 OJ Hybrid Drop Cables combine fiber and copper technologies in an overjacket design. The independent Series 513 optical fiber cable and the BSW Outside Plant (OSP) copper cable are combined into one overjacketed cable. The hybrid design provides a cost benefit compared to installing separate fiber and copper cables.

This design allows great flexibility regarding the independent cables used in the overall construction. These independent cables are encased in an outer jacket with a rip cord included for ease of entry.

## APPLICATIONS

- Network power and FTTP
- Drop cables

## FEATURES

- Independent fiber and copper cables combined in a overjacket design
- Overjacket design
- Combined transport technologies in one cable
- Various combinations and multiple fiber types available
- PFM™ gel

## BENEFITS

- Lightweight, flexible construction
- Easy separation of technologies
- Cost-effective installation
- Ideal for multiple projects
- Non-sticky gel reduces installation time and labor cost

## BSW OSP COPPER SPECIFICATIONS

Conductor	Solid annealed copper
Insulation	Solid polyolefin
Core Wrap	Non-hygroscopic
Filling Compound	80°C ETPR compound for water-blocking protection
Shield	Corrugated armor

## OPTICAL FIBER SPECIFICATIONS

Construction	Series 513 single loose tube design features optical fibers placed inside a PFM gel-filled tube
Fiber Count	Up to 12 optical fibers
Strength Members	Core is helically wrapped with dielectric water-blocking strength members

## HYBRID SPECIFICATIONS

Single Jacket Design	Independent copper and fiber cables are encased in a outer jacket with a rip cord
Standards Compliance	Copper and fiber cables meet applicable Telcordia®, RDUP and ICEA specifications RoHS-compliant

Telcordia is a registered trademark of Ericsson Inc.

## ENVIRONMENTAL SPECIFICATIONS

Operation/Storage	-40°C to +70°C
Installation	-30°C to +70°C

## PART NUMBERS AND PHYSICAL CHARACTERISTICS

Part Number	Copper Pair Count x AWG	Fiber Count	Fiber Type	Nominal Diameter		Approx. Weight lbs/kft (kg/km)	Package
				Copper Component in (mm)	Fiber Component in (mm)		
71-055-02	2 x 22	2	RWP SMF	0.27 (6.9)	0.26 (6.7)	114 (170)	8,000' Reel
71-402-02	5 x 22	2	RWP SMF	0.32 (8.1)	0.26 (6.7)	136 (202)	8,000' Reel

Part numbers listed are RWP single mode optical fiber only. Other fiber types are available. See "Optical Fiber Specifications" in the "Technical Info" section for detailed fiber type specifications.

## PRODUCT DESCRIPTION

Series 5V Cables are designed for Outside Plant (OSP) broadband applications. These cables combine copper and optical fiber technologies into one hybrid cable and are suitable for voice, video and data communications. The copper cable offers the option of providing network power to eliminate the cost of local powering. The wide range of copper and fiber counts make this cable ideal for most projects.

The construction of this product combines an ANAW OSP copper cable and a Series 51 optical fiber cable. These independent cables are simultaneously jacketed in a polyethylene outer jacket with a rip cord included for ease of entry. The web connects the cables and can be easily split to direct the cables to different locations.

## APPLICATIONS

- Direct bury, conduit, lashed aerial

## FEATURES

- Independent fiber and copper cables under one jacket
- Web design
- Optical/electrical technology
- Web design
- PFM™ gel

## BENEFITS

- Reduces labor cost
- Easy separation to different locations
- Ideal for voice, video and data
- Lower cost
- Non-sticky gel reduces installation time and labor cost

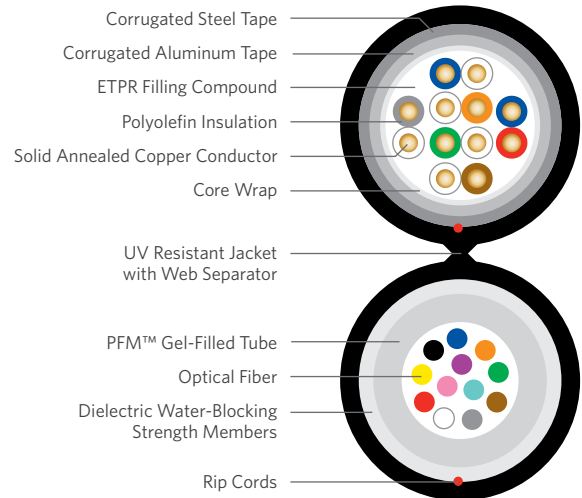
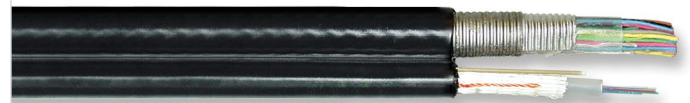

## HYBRID SPECIFICATIONS

### Single Jacket Design

Copper and fiber independent cables are simultaneously jacketed in a polyethylene outer jacket with a rip cord included for ease of entry. Web connects the cables and can be easily split to direct the cables to different locations.

### Standards Compliance

Copper and fiber cables meet applicable Telcordia® Specifications (GR-421-CORE, GR-20 Core)

Telcordia is a registered trademark of Ericsson Inc.

## ENVIRONMENTAL SPECIFICATIONS

Operation/Storage	-40°C to +70°C
Installation	-30°C to +70°C

## PART NUMBERS AND PHYSICAL CHARACTERISTICS

Part Number	Copper Pair Count	Fiber Count	Fiber Type	Nominal Diameter		Approx. Weight lbs/kft (kg/km)	Package
				Copper Component in (mm)	Fiber Component in (mm)		
5V0063061	6	6	RWP SMF	0.45 (11)	0.37 (9)	176 (262)	14,800' Reel
5V0063121	12	6	RWP SMF	0.56 (14)	0.37 (9)	234 (348)	14,800' Reel
5V0123121	12	12	RWP SMF	0.56 (14)	0.37 (9)	234 (348)	14,800' Reel
5V0183181	18	18	RWP SMF	0.61 (15)	0.37 (9)	285 (425)	14,800' Reel
5V0123251	25	12	RWP SMF	0.72 (18)	0.37 (9)	355 (528)	12,700' Reel
5V0243251	25	24	RWP SMF	0.72 (18)	0.37 (9)	355 (528)	12,700' Reel

Part numbers listed are RWP single mode optical fiber only. Other fiber types are available. See "Optical Fiber Specifications" in the "Technical Info" section for detailed fiber type specifications.

# Telco Hybrid Overjacket OSP

Series 70 OJ

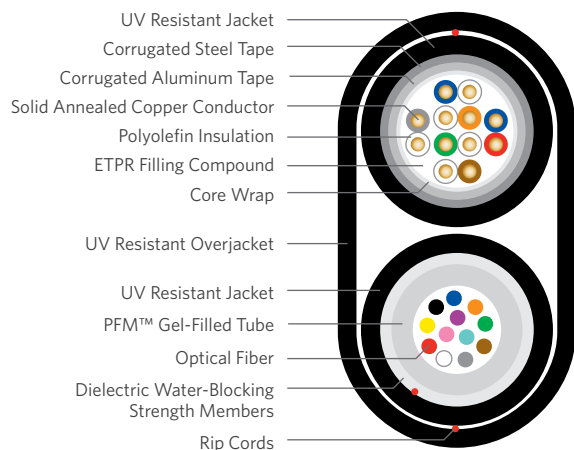

## PRODUCT DESCRIPTION

Series 70 OJ Cables are designed for Outside Plant (OSP) broadband applications. These cables combine copper and optical fiber technologies into one hybrid cable and are suitable for voice, video and data communications. The copper cable offers the option of providing network power to eliminate the cost of local powering. The wide range of copper and fiber counts make this cable ideal for most projects.

The construction of this product combines an ANAW OSP copper cable and a Series 51 optical fiber cable. These independent cables are encased in an outer jacket with a rip cord included for ease of use.

## APPLICATIONS

- Direct bury, conduit, lashed aerial

## FEATURES

- Independent fiber and copper cables under one jacket
- Overjacket design
- Optical/Electrical Technology
- PFM™ gel

## BENEFITS

- Reduces labor cost
- Easy separation to different locations
- Ideal for voice, video and data
- Non-sticky gel reduces installation time and labor cost

## ANAW OSP COPPER SPECIFICATIONS

Conductor	22 AWG solid annealed copper
Insulation	Inner layer of foamed, natural polyolefin covered by an outer layer of solid, colored polyolefin
Core Wrap	Non-hygroscopic
Filling Compound	80°C ETPR compound provides water-blocking protection
Shield	Corrugated 8 mil aluminum tape covered by a corrugated bare 6 mil steel tape; both inner and outer surfaces of the tapes are flooded to provide a moisture barrier and inhibit corrosion

## OPTICAL FIBER SPECIFICATIONS

Construction	Series 51 single loose tube design features optical fibers placed inside a PFM gel-filled tube
Fiber Count	Up to 8 optical fiber bundles, each containing up to 12-fiber within a color coded binder
Strength Members	Core is helically wrapped with dielectric water-blocking strength members

## HYBRID SPECIFICATIONS

Single Jacket Design	Copper and fiber independent cables are encased in an overjacket with a rip cord included for ease of use
Standards Compliance	Copper and fiber cables meet applicable Telcordia® Specifications (GR-421-CORE, GR-20 Core)

Telcordia is a registered trademark of Ericsson Inc.

## ENVIRONMENTAL SPECIFICATIONS

Operation/Storage	-40°C to +70°C
Installation	-30°C to +70°C

## PART NUMBERS AND PHYSICAL CHARACTERISTICS

Part Number	Copper Pair Count	Fiber Count	Fiber Type	Nominal Diameter		Approx. Weight lbs/kft (kg/km)	Package
				Copper Component in (mm)	Fiber Component in (mm)		
70-425-18	36	18	RWP SMF	0.76 (19)	0.37 (9)	443 (658)	11,100' Reel
70-425-36	36	36	RWP SMF	0.76 (19)	0.37 (9)	443 (658)	11,100' Reel
70-065-24	50	24	RWP SMF	0.88 (22)	0.37 (9)	546 (811)	8,900' Reel
70-065-48	50	48	RWP SMF	0.88 (22)	0.37 (9)	546 (811)	8,900' Reel
70-067-36	75	36	RWP SMF	1.00 (25)	0.37 (9)	724 (1,077)	6,000' Reel
70-067-72	75	72	RWP SMF	1.00 (25)	0.51 (13)	734 (1,092)	6,000' Reel
70-069-48	100	48	RWP SMF	1.15 (29)	0.37 (9)	895 (1,331)	6,000' Reel
70-069-72	100	72	RWP SMF	1.15 (29)	0.51 (13)	924 (1,374)	6,000' Reel
70-071-72	150	72	RWP SMF	1.34 (34)	0.51 (13)	1,260 (1,874)	3,000' Reel
70-071-96	150	96	RWP SMF	1.34 (34)	0.51 (13)	1,260 (1,874)	3,000' Reel
70-073-96	200	96	RWP SMF	1.50 (38)	0.51 (13)	1,615 (2,403)	2,500' Reel

Part numbers listed are RWP single mode optical fiber only. Other fiber types are available. See "Optical Fiber Specifications" in the "Technical Info" section for detailed fiber type specifications.

# Telco Hybrid Loose Tube, Stranded 24AWG Copper Pairs

Series L

## PRODUCT DESCRIPTION

Series L Cables combine the attributes of optical fiber and copper technologies in a single cable. Designed for Outside Plant (OSP) applications, these cables improve network flexibility by addressing the need to transmit electrical power while providing virtually unlimited bandwidth to the subscriber. Labor savings are also realized making this product ideal for various projects.

## FEATURES

- Fiber tubes and copper pairs in one jacket
- Wide range of copper and fiber counts
- Single mode, multimode and composite designs
- Copper twisted pairs
- Various cable designs
- PFM™ gel

## BENEFITS

- Reduced material cost and significant installation savings
- Sizes available for large and small projects
- Multiple network applications
- Capable of voice transmission, cable location and site powering
- Multiple applications
- Non-sticky gel reduces installation time and labor cost

## NOTE

- Special cable lengths are available upon request
- Please contact your Superior Essex sales professional with your application requirements

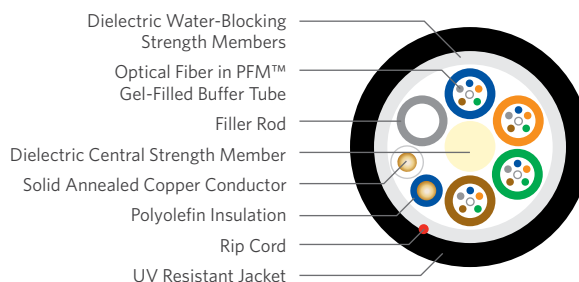

## SPECIFICATIONS

<b>Construction</b>	Loose tube, single jacket
<b>Standards Compliance</b>	Copper and fiber cables meet applicable Telcordia® and RDUP specifications RoHS-compliant

*Telcordia is a registered trademark of Ericsson Inc.*

## ELECTRICAL SPECIFICATIONS

Conductor Size AWG (mm)	Conductor DC Resistance @ 68°F Maximum Individual Ohms/mile (Ohms/km)	Resistance Unbalance Maximum Individual Pair %	Dielectric Strength DC Potential - Volts Minimum Conductor to Conductor	Maximum Voltage	Maximum Amperage/Conductor
22 (0.64)	91.0 (56.6)	5.0	5,000	150 vDC	1.0 A

## PART NUMBERS AND PHYSICAL CHARACTERISTICS

Part Number	Copper Pair Count	Fiber Count	Fiber Type	Optional Shield	Filling Compound	Length Marking	Nominal Diameter in (mm)	Approx. Weight lbs/kft (kg/km)	Maximum Tensile Load	
									Install lbs (N)	Long Term lbs (N)
11024C02Q	1	24	RWP SMF	-	Dry	Feet	0.43 (10.85)	58 (86)	600 (2,700)	200 (890)
11024D01Q	2	24	RWP SMF	-	Flood	Meters	0.43 (10.85)	69 (103)	600 (2,700)	200 (890)
12024D02Q	2	24	RWP SMF	Single Armor	Flood	Meters	0.48 (12.20)	107 (160)	600 (2,700)	200 (890)

Part number listed are RWP single mode optical fiber only. Other fiber types are available. See "Optical Fiber Specifications" in the "Technical Info" section for detailed fiber type specifications.

# PowerWise® Hybrid

Series DE

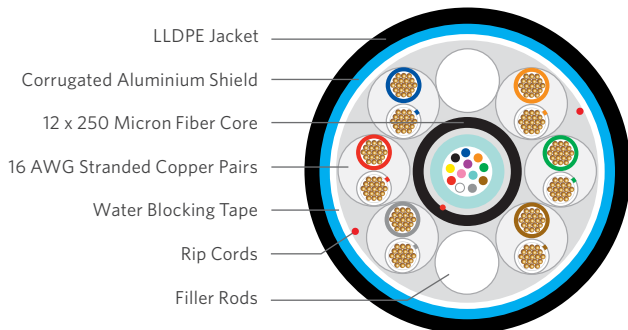

### OSP COPPER SPECIFICATIONS

Conductor	16 AWG, 19 x 0.017" stranded bare copper
Insulation	PVC
Number of Conductors	12
Conductor Configuration	6 Individual twisted Pairs

### OPTICAL FIBER SPECIFICATIONS

Fiber Type	Single Mode ITU-T G.652. D fibers
Wavelengths (nm)	1310/1383/1550
Typical Attenuation (dB/km)	0.33/0.33/0.19
Number of Fibers	12

### PRODUCT DESCRIPTION

The OSP PowerWise® Hybrid Series DE cable combines the current carrying capability of the stranded copper twisted pairs with the unlimited data capacity of optical fiber in a single cable. This round small 0.67 inch (17.00 mm) cable can be used in a 1 inch duct or lashed aerielly to provide power and data to next generation wireless devices used in today's heterogeneous networks.

Designed to support the transmission of digital electricity (DC pulses of power) over long distances safely. The cable makes use of stranded copper conductors twisted into individual pairs that are then stranded around a fiber cable core that makes use of dry water blocking technology to prevent water ingress. The core of the cable is wrapped with a corrugated Aluminum shield and jacketed with an OSP UV-rated PE jacket.

### APPLICATIONS

- Provide power by using digital electricity power pulses to Outdoor DAS Remotes, Small Cells and Outdoor Wi-Fi Access Points over the copper pairs and data over the fiber.

### FEATURES

- Single unit construction
- Strand design
- Low pair to pair mutual capacitance

### BENEFITS

- Lower Installation costs
- Provides cable flexibility
- Efficient transfer of pules power

### HYBRID SPECIFICATIONS

Construction	Fiber cable forms the core with six 16 AWG twisted pairs stranded around the core
Water Block	Super absorbent polymer tape
Shield	Coated corrugated aluminum
Rip Cords	2 diametrically opposed under the shield
Jacket	Polyethylene

### ENVIRONMENTAL SPECIFICATIONS

Operation/Storage	-40°C to +70°C
Installation	0°C to +70°C

### ELECTRICAL SPECIFICATIONS

Mutual Capacitance Nominal pF/ft (pF/m)	Conductor DC Resistance @ 68°F (20°C) Maximum Individual Ohms/kft (Ohms/km)	Max. Operating Voltage-UL	Max. Recommended Current
24.5 (80.4)	6.49 (21.29)	300 Volts RMS	3.5 Amps per conductor @25°C

### PART NUMBERS AND PHYSICAL CHARACTERISTICS

Part Number	Fiber Count	Nominal Diameter in (mm)	Approx. Weight lbs/kft (kg/km)	Minimum Bend Radius		Maximum Tensile Load	
				Install in (mm)	Long Term in (mm)	Install lbs (N)	Long Term lbs (N)
FG41-012C10-E991-CEC	12	0.67 (17.0)	213 (316.9)	13.4 (340)	6.7 (170)	300 (2,700)	100 (445)



## PRODUCT DESCRIPTION

POWERPIC™ Cables are designed exclusively for Telco Line Powering applications. The copper core makes use of our PFM™ Gel filling compound to ensure protection from moisture ingress. These cables can be used in low risk direct burial or duct applications. They may be used aerially, but must be attached to a support strand.

## APPLICATIONS

- Telco Class 2 Line Powering
- Low risk direct burial
- Underground conduit
- Lashed aerial

## FEATURES

- PFM™ Gel filled core
- Core wrap
- Fully flooded shield interfaces
- Black, polyethylene jacket

## BENEFITS

- Non-sticky gel speeds up conductor access and clean up without the need of solvents
- Provides thermal protection
- Inhibits corrosion and water migration
- Provides a tough, protective covering designed to withstand exposure to direct sunlight, atmospheric temperature changes and stresses expected in standard installations



## SPECIFICATIONS

<b>Conductor</b>	Solid annealed copper
<b>Insulation</b>	Dual insulation consisting of an inner layer of foamed, natural polyolefin over which is applied a solid (skin) layer of polyolefin colored in accordance with industry standards
<b>Twisted Pairs</b>	Individual insulated conductors; twisted into pairs with varying lay lengths; specific color combinations provide pair identification
<b>≤ 25-Pair Core</b>	Pairs are assembled into a cylindrical core
<b>&gt; 25-Pair Core</b>	Cables larger than 25-pair are assembled into units, which are then used to assemble the core; units are identifiable using color-coded binders
<b>Filling Compound</b>	PFM™ Gel
<b>Core Wrap</b>	Non-hygroscopic, dielectric tape applied over the core
<b>Shield</b>	Corrugated, copolymer coated, 8 mil aluminum tape applied longitudinally with an overlap; flooded shield interfaces
<b>Jacket</b>	Black, polyethylene
<b>Jacket Marking</b>	Identifying information includes a telephone handset, cable code, pair count, AWG, date of manufacture and sequential length markings at 2 foot intervals
<b>Standards Compliance</b>	ANSI/ICEA S-84-608-2011 RDUP 7 CFR 1755.890 RoHS-compliant

## ELECTRICAL SPECIFICATIONS

Conductor Size AWG (mm)	Minimum Insulation Resistance @ 68°F (20°C) gigohm-mile (gigohm-km)	Maximum Average Attenuation* 772 kHz @ 68°F (20°C) dB/kft (dB/km)	Maximum Conductor Resistance @ 68°F (20°C) Ohms/sheath mile (km)	DC Resistance Unbalance Maximum %		Dielectric Strength DC Potential - Volts	
				Average	Individual Pair	Conductor to Conductor	Conductor to Shield
22 (0.64)	1.0 (1.6)	4.5 (14.8)	91.0 (56.5)	1.5	5.0	3,600	10,000

## PART NUMBERS AND PHYSICAL CHARACTERISTICS

Part Number	Pair Count	AWG (mm)	Nominal Diameter in (mm)	Approx. Weight lbs/kft (kg/km)	Standard Length ft (m)	Approx. Shipping Weight lbs (kg)	Reel Size F x T x D in
30-400-02	4	22 (0.64)	0.39 (9.9)	70 (105)	5,000 (1,524)	415 (190)	36 x 18 x 14
30-404-02	8	22 (0.64)	0.40 (10.3)	92 (137)	5,000 (1,524)	625 (283)	46 x 25 x 20
30-062-02	25	22 (0.64)	0.60 (15)	200 (300)	5,000 (1,524)	1,165 (530)	46 x 25 x 20
30-065-02	50	22 (0.64)	0.77 (20)	350 (520)	5,000 (1,524)	1,955 (885)	52 x 25 x 20
30-069-02	100	22 (0.64)	1.02 (26)	650 (956)	5,000 (1,524)	3,540 (1,605)	62 x 30 x 24
30-073-02	200	22 (0.64)	1.38 (35)	1,225 (1,825)	2,500 (762)	3,350 (1,520)	62 x 30 x 24
30-075-02	300	22 (0.64)	1.65 (42)	1,800 (2,680)	1,250 (381)	2,495 (1,130)	58 x 25 x 20

# SEALPIC®



## SPECIFICATIONS

<b>Conductor</b>	Solid annealed copper
<b>Insulation</b>	Solid polyolefin; color coded in accordance with industry standards
<b>Twisted Pairs</b>	Individual insulated conductors are twisted into pairs with varying lay lengths; specific color combinations provide pair identification
<b>≤ 25-Pair Core</b>	Pairs are assembled into a cylindrical core
<b>&gt; 25-Pair Core</b>	Cables larger than 25-pair are assembled into units, which are then used to assemble the core; units are identifiable using color-coded binders
<b>Core Wrap</b>	Non-hygroscopic, dielectric tape
<b>Shield</b>	Corrugated, copolymer coated, 8 mil aluminum tape applied longitudinally with an overlap
<b>Jacket</b>	Black, polyethylene
<b>Jacket Marking</b>	Identifying information includes a telephone handset, cable code, pair count, AWG, date of manufacture and sequential length markings at 2 foot intervals
<b>Standards Compliance</b>	ANSI/ICEA S-85-625-2011 Formerly PE-22 RoHS-compliant

## PRODUCT DESCRIPTION

SEALPIC® Cables have an air core design and are suited for lashed aerial installations. If used in underground conduit, pressurization is recommended. SEALPIC cables are not recommended for direct burial installations.

## APPLICATIONS

- Lashed aerial
- Pressurized underground conduit

## FEATURES

- Twisted into pairs with varying lay lengths
- Core wrap
- Black, polyethylene jacket

## BENEFITS

- Minimizes crosstalk
- Provides thermal protection
- Provides a tough protective covering designed to withstand exposure to direct sunlight, atmospheric temperature changes and stresses expected in standard installations

## ELECTRICAL SPECIFICATIONS

Number of Pairs	Average Mutual Capacitance @ 1,000 Hz nF/mile (nF/km)	Capacitance Unbalance Pair to Pair @ 1 kHz		Capacitance Unbalance Pair to Ground @ 1 kHz	
		Maximum Individual pF @ 1 kft (pF @ 1 km)	Maximum RMS pF @ 1 kft (pF @ 1 km)	Maximum Individual pF @ 1 kft (pF @ 1 km)	Maximum Average pF @ 1 kft (pF @ 1 km)
12 or less	83 ± 7 (52 ± 4)	80 (145)	-	800 (2,625)	-
Over 12	83 ± 4 (52 ± 2)	80 (145)	25 (45)	800 (2,625)	175 (574)

Conductor Size AWG (mm)	Minimum Insulation Resistance @ 68°F (20°C) gigohm-mile (gigohm-km)	Maximum Average Attenuation* 772 kHz @ 68°F (20°C) dB/kft (dB/km)	Maximum Conductor Resistance @ 68°F (20°C) Ohms/sheath mile (km)	DC Resistance Unbalance Maximum %		Dielectric Strength DC Potential - Volts	
				Average	Individual Pair	Conductor to Conductor	Conductor to Shield
19 (0.90)	1.0 (1.6)	3.3 (10.8)	45.0 (28.0)	1.5	5.0	5,000	10,000
22 (0.64)	1.0 (1.6)	4.7 (15.4)	91.0 (56.5)	1.5	5.0	4,000	10,000
24 (0.51)	1.0 (1.6)	5.9 (19.4)	144.0 (89.5)	1.5	5.0	3,000	10,000

\*For cables with 12-pair or less, the maximum average attenuation may be increased by 10% over the values shown.

### Minimum Near End Crosstalk (NEXT) @ 772 kHz

PSWUNEXT Mean (dB)	47
PSWUNEXT Worst Pair (dB)	42

### Minimum Far End Crosstalk (FEXT) @ 772 kHz

Conductor Size (AWG)	19	22	24
PSELFEXT Mean (dB/kft)	51	49	49
PSELFEXT Worst Pair (dB/kft)	45	43	43

## PART NUMBERS AND PHYSICAL CHARACTERISTICS

Part Number	Pair Count	AWG (mm)	Nominal Diameter in (mm)	Approx. Weight lbs/kft (kg/km)	Standard Length ft (m)	Approx. Shipping Weight lbs (kg)	Reel Size F x T x D in
01-031-40	25	19 (0.90)	0.76 (19)	310 (460)	5,000 (1,524)	1,755 (795)	52 x 25 x 20
01-034-40	50	19 (0.90)	1.00 (25)	575 (855)	5,000 (1,524)	3,165 (1,435)	62 x 30 x 24
01-038-40	100	19 (0.90)	1.34 (34)	1,075 (1,600)	5,000 (1,524)	6,075 (2,755)	78 x 40 x 39
01-062-40	25	22 (0.64)	0.60 (15)	180 (270)	5,000 (1,524)	1,065 (485)	46 x 25 x 20
01-065-40	50	22 (0.64)	0.77 (20)	315 (470)	5,000 (1,524)	1,780 (805)	52 x 25 x 20
01-069-40	100	22 (0.64)	1.02 (26)	580 (865)	5,000 (1,524)	3,190 (1,445)	62 x 30 x 24
01-073-40	200	22 (0.64)	1.38 (35)	1,095 (1,630)	5,000 (1,524)	6,175 (2,800)	78 x 40 x 39
01-075-40	300	22 (0.64)	1.66 (42)	1,605 (2,390)	2,500 (762)	4,625 (2,100)	72 x 35 x 36
01-094-40	12	24 (0.51)	0.41 (10)	75 (110)	5,000 (1,524)	440 (200)	36 x 18 x 14
01-097-40	25	24 (0.51)	0.51 (13)	125 (185)	5,000 (1,524)	735 (330)	44 x 18 x 20
01-100-40	50	24 (0.51)	0.64 (16)	215 (320)	5,000 (1,524)	1,240 (560)	46 x 25 x 20
01-104-40	100	24 (0.51)	0.83 (21)	385 (575)	5,000 (1,524)	2,170 (985)	58 x 25 x 20
01-108-40	200	24 (0.51)	1.12 (28)	715 (1,065)	5,000 (1,524)	4,190 (1,900)	72 x 35 x 36
01-110-40	300	24 (0.51)	1.33 (34)	1,040 (1,550)	5,000 (1,524)	5,900 (2,675)	78 x 40 x 39
01-112-40	400	24 (0.51)	1.52 (39)	1,360 (2,025)	2,500 (762)	4,015 (1,820)	72 x 35 x 36
01-116-40	600	24 (0.51)	1.82 (46)	2,005 (2,985)	2,500 (762)	5,710 (2,590)	78 x 40 x 39
01-118-40	900	24 (0.51)	2.19 (56)	2,960 (4,405)	1,250 (381)	4,315 (1,955)	72 x 35 x 36
01-120-40	1,200	24 (0.51)	2.49 (63)	3,895 (5,795)	1,250 (381)	5,570 (2,525)	78 x 40 x 39
01-124-40	1,800	24 (0.51)	3.04 (77)	5,785 (8,610)	1,000 (305)	6,485 (2,940)	78 x 40 x 39

**FOR EXTREME RISK ENVIRONMENTS**

For extreme direct burial or lashed aerial installations, this cable is available with the +M feature. See the "Mechanical Protection (+M) for Extreme Risk Environments" in the "Technical Info" section for more information.

# SEALPIC®-84



## SPECIFICATIONS

<b>Conductor</b>	Solid annealed copper
<b>Insulation</b>	Solid polyolefin; color coded in accordance with industry standards
<b>Twisted Pairs</b>	Individual insulated conductors are twisted into pairs with varying lay lengths; specific color combinations provide pair identification
<b>≤ 25-Pair Core</b>	Pairs are assembled into a cylindrical core
<b>&gt; 25-Pair Core</b>	Cables larger than 25-pair are assembled into units, which are then used to assemble the core; units are identifiable using color-coded binders
<b>Core Wrap</b>	Non-hygroscopic, dielectric tape
<b>Shield</b>	Corrugated, copolymer coated, 8 mil aluminum tape applied longitudinally with an overlap
<b>Support Member</b>	0.25 inch, 7-strand Extra High Strength (EHS) galvanized steel messenger serves as support member and integral part of the sheath; messenger is flooded
<b>Jacket</b>	Black, polyethylene
<b>Jacket Marking</b>	Identifying information includes a telephone handset, cable code, pair count, AWG, date of manufacture and sequential length markings at 2 foot intervals
<b>Standards Compliance</b>	ANSI/ICEA S-85-625-2011 Formerly PE-38 RoHS-compliant

## PRODUCT DESCRIPTION

SEALPIC®-84 Cables have an air core design and are suited for aerial installations. The core and support member (messenger) lay parallel to each other forming a cross-sectional "figure 8." The support messenger is an integral part of the cable sheath, yet readily available for gripping, pulling and tensioning.

## APPLICATIONS

- Aerial

## FEATURES

- Twisted into pairs with varying lay lengths
- Core wrap
- Fully flooded steel support member
- Black, polyethylene jacket

## BENEFITS

- Minimizes crosstalk
- Provides thermal protection
- Inhibits corrosion
- Provides a tough, protective covering designed to withstand exposure to direct sunlight, atmospheric temperature changes and stresses expected in standard installations

## ELECTRICAL SPECIFICATIONS

Number of Pairs	Average Mutual Capacitance @ 1,000 Hz nF/mile (nF/km)	Capacitance Unbalance Pair to Pair @ 1 kHz		Capacitance Unbalance Pair to Ground @ 1 kHz	
		Maximum Individual pF @ 1 kft (pF @ 1 km)	Maximum RMS pF @ 1 kft (pF @ 1 km)	Maximum Individual pF @ 1 kft (pF @ 1 km)	Maximum Average pF @ 1 kft (pF @ 1 km)
12 or less	83 ± 7 (52 ± 4)	80 (145)	-	800 (2,625)	-
Over 12	83 ± 4 (52 ± 2)	80 (145)	25 (45)	800 (2,625)	175 (574)

Conductor Size AWG (mm)	Minimum Insulation Resistance @ 68°F (20°C) gigohm-mile (gigohm-km)	Maximum Average Attenuation* 772 kHz @ 68°F (20°C) dB/kft (dB/km)	Maximum Conductor Resistance @ 68°F (20°C) Ohms/sheath mile (km)	DC Resistance Unbalance Maximum %		Dielectric Strength DC Potential - Volts	
				Average	Individual Pair	Conductor to Conductor	Conductor to Shield
19 (0.90)	1.0 (1.6)	3.3 (10.8)	45.0 (28.0)	1.5	5.0	5,000	10,000
22 (0.64)	1.0 (1.6)	4.7 (15.4)	91.0 (56.5)	1.5	5.0	4,000	10,000
24 (0.51)	1.0 (1.6)	5.9 (19.4)	144.0 (89.5)	1.5	5.0	3,000	10,000

\*For cables with 12-pair or less, the maximum average attenuation may be increased by 10% over the values shown.

### Minimum Near End Crosstalk (NEXT) @ 772 kHz

PSWUNEXT Mean (dB)	47
PSWUNEXT Worst Pair (dB)	42

### Minimum Far End Crosstalk (FEXT) @ 772 kHz

Conductor Size (AWG)	19	22	24
PSELFEXT Mean (dB/kft)	51	49	49
PSELFEXT Worst Pair (dB/kft)	45	43	43

## PART NUMBERS AND PHYSICAL CHARACTERISTICS

Part Number	Pair Count	AWG (mm)	Nominal Diameter		Approx. Weight lbs/kft (kg/km)	Standard Length ft (m)	Approx. Shipping Weight lbs (kg)	Reel Size F x T x D in
			Cable only in (mm)	With Messenger in (mm)				
01-031-38	25	19 (0.90)	0.74 (19)	1.24 (31)	445 (660)	5,000 (1,524)	2,975 (1,349)	78 x 40 x 39
01-057-38	6	22 (0.64)	0.38 (9.7)	0.87 (22)	200 (300)	5,000 (1,524)	1,270 (576)	58 x 25 x 20
01-059-38	12	22 (0.64)	0.45 (11)	0.94 (24)	235 (350)	5,000 (1,524)	1,515 (687)	62 x 30 x 24
01-062-38	25	22 (0.64)	0.59 (15)	1.08 (27)	315 (470)	5,000 (1,524)	2,225 (1,009)	72 x 36 x 36
01-065-38	50	22 (0.64)	0.75 (19)	1.25 (32)	450 (670)	5,000 (1,524)	3,000 (1,361)	78 x 40 x 39
01-092-38	6	24 (0.51)	0.34 (8.6)	0.83 (21)	185 (275)	5,000 (1,524)	1,115 (506)	46 x 25 x 20
01-094-38	12	24 (0.51)	0.40 (10)	0.89 (23)	210 (315)	5,000 (1,524)	1,280 (580)	52 x 25 x 20
01-097-38	25	24 (0.51)	0.50 (13)	0.99 (25)	260 (385)	5,000 (1,524)	1,595 (723)	58 x 25 x 20
01-100-38	50	24 (0.51)	0.63 (16)	1.12 (28)	350 (520)	5,000 (1,524)	2,065 (937)	62 x 30 x 24
01-104-38	100	24 (0.51)	0.81 (21)	1.31 (33)	515 (765)	5,000 (1,524)	3,275 (1,485)	72 x 36 x 36
01-108-38	200	24 (0.51)	1.14 (29)	1.60 (41)	875 (1,300)	2,500 (762)	2,440 (1,107)	62 x 30 x 24

**TECHNICAL GUIDELINE**

*Sag and Tension Technical Guidelines are available for these products. Refer to the "Resources" section on our site for more information.*

# SEALPIC®-FSF-84



## SPECIFICATIONS

<b>Conductor</b>	Solid annealed copper
<b>Insulation</b>	Dual insulation consisting of an inner layer of foamed, natural polyolefin over which is applied a solid (skin) layer of polyolefin colored in accordance with industry standards
<b>Twisted Pairs</b>	Individual insulated conductors; twisted into pairs with varying lay lengths; specific color combinations provide pair identification
<b>≤ 25-Pair Core</b>	Pairs are assembled into a cylindrical core
<b>&gt; 25-Pair Core</b>	Cables larger than 25-pair are assembled into units, which are then used to assemble the core; units are identifiable using color-coded binders
<b>Filling Compound</b>	80°C ETPR compound, completely filling the interstices between the pairs and under the core wrap
<b>Core Wrap</b>	Non-hygroscopic, dielectric tape
<b>Shield</b>	Corrugated, copolymer coated, 8 mil aluminum tape applied longitudinally with an overlap; flooded shield interfaces
<b>Support Member</b>	0.25 inch, 7-strand Extra High Strength (EHS) galvanized steel messenger serves as support member and integral part of the sheath; messenger is flooded
<b>Jacket</b>	Black, polyethylene
<b>Jacket Marking</b>	Identifying information includes a telephone handset, cable code, pair count, AWG, date of manufacture and sequential length markings at 2 foot intervals
<b>Standards Compliance</b>	SEALPIC-FSF-84 cables meet the physical and electrical requirements of RDUP specification 7 CFR 1755.890 (PE-89), except that the figure 8 sheath shall meet the requirements of ANSI/ICEA S-85-625-2011 Option A RoHS-compliant

## PRODUCT DESCRIPTION

SEALPIC®-FSF-84 Cables are suited for aerial applications where a filled cable design is preferred. The core and support member (messenger) lay parallel to each other forming a cross-sectional "figure 8." The support messenger is an integral part of the cable sheath, yet readily available for gripping, pulling and tensioning.

## APPLICATIONS

- Aerial

## FEATURES

- Twisted into pairs with varying lay lengths
- Core wrap
- Filled core
- Fully flooded shield interfaces
- Fully flooded steel support member
- Black, polyethylene jacket

## BENEFITS

- Minimizes crosstalk
- Provides thermal protection
- Moisture resistant
- Inhibits corrosion and water migration
- Inhibits corrosion
- Provides a tough, protective covering designed to withstand exposure to direct sunlight, atmospheric temperature changes and stresses expected in standard installations

## ELECTRICAL SPECIFICATIONS

Number of Pairs	Average Mutual Capacitance @ 1,000 Hz nF/mile (nF/km)	Capacitance Unbalance Pair to Pair @ 1 kHz		Capacitance Unbalance Pair to Ground @ 1 kHz	
		Maximum Individual pF @ 1 kft (pF @ 1 km)	Maximum RMS pF @ 1 kft (pF @ 1 km)	Maximum Individual pF @ 1 kft (pF @ 1 km)	Maximum Average pF @ 1 kft (pF @ 1 km)
12 or less	83 ± 7 (52 ± 4)	80 (145)	-	800 (2,625)	-
Over 12	83 ± 4 (52 ± 2)	80 (145)	25 (45)	800 (2,625)	175 (574)

Conductor Size AWG (mm)	Minimum Insulation Resistance @ 68°F (20°C) gigohm-mile (gigohm-km)	Maximum Average Attenuation* 772 kHz @ 68°F (20°C) dB/kft (dB/km)*	Maximum Conductor Resistance @ 68°F (20°C) Ohms/sheath mile (km)	DC Resistance Unbalance Maximum %		Dielectric Strength DC Potential - Volts	
				Average	Individual Pair	Conductor to Conductor	Conductor to Shield
22 (0.64)	1.0 (1.6)	4.5 (14.8)	91.0 (56.5)	1.5	5.0	3,600	10,000
24 (0.51)	1.0 (1.6)	5.6 (18.4)	144.0 (89.5)	1.5	5.0	3,000	10,000

\*For cables with 12-pair or less, the maximum average attenuation may be increased by 10% over the values shown.

### Minimum Near End Crosstalk (NEXT) @ 772 kHz

PSWUNEXT Mean (dB)	47
PSWUNEXT Worst Pair (dB)	42

### Minimum Far End Crosstalk (FEXT) @ 772 kHz

Conductor Size (AWG)	22	24
PSELFEXT Mean (dB/kft)	49	49
PSELFEXT Worst Pair (dB/kft)	43	43

## PART NUMBERS AND PHYSICAL CHARACTERISTICS

Part Number	Pair Count	AWG (mm)	Nominal Diameter		Approx. Weight lbs/kft (kg/km)	Standard Length ft (m)	Approx. Shipping Weight lbs (kg)	Reel Size F x T x D in
			Cable only in (mm)	With Messenger in (mm)				
09-057-05	6	22 (0.64)	0.37 (9.4)	0.84 (22)	205 (305)	5,000 (1,524)	1,255 (569)	52 x 25 x 20
09-059-05	12	22 (0.64)	0.46 (12)	0.93 (24)	250 (370)	5,000 (1,524)	1,513 (687)	52 x 25 x 20
09-062-05	25	22 (0.64)	0.59 (15)	1.06 (27)	330 (490)	5,000 (1,524)	1,945 (882)	58 x 25 x 20
09-092-05	6	24 (0.51)	0.34 (8.6)	0.83 (21)	185 (275)	5,000 (1,524)	1,115 (506)	46 x 25 x 20
09-094-05	12	24 (0.51)	0.40 (10)	0.89 (23)	210 (315)	5,000 (1,524)	1,280 (580)	52 x 25 x 20
09-097-05	25	24 (0.51)	0.50 (13)	0.99 (25)	260 (385)	5,000 (1,524)	1,595 (723)	58 x 25 x 20
09-100-05	50	24 (0.51)	0.63 (16)	1.12 (28)	350 (520)	5,000 (1,524)	2,065 (937)	62 x 30 x 24
09-104-05	100	24 (0.51)	0.81 (21)	1.31 (33)	515 (765)	5,000 (1,524)	3,275 (1,485)	72 x 36 x 36
09-108-05	200	24 (0.51)	1.14 (29)	1.60 (41)	875 (1,300)	2,500 (762)	2,440 (1,107)	62 x 30 x 24
09-110-05	300	24 (0.51)	1.36 (35)	1.81 (46)	1,200 (1,785)	2,500 (762)	3,585 (1,626)	72 x 36 x 36

**TECHNICAL GUIDELINE**

Sag and Tension Technical Guidelines are available for these products.  
Refer to the "Resources" section on our site for more information.

# SEALPIC®-FSF

## RDUP PE-89

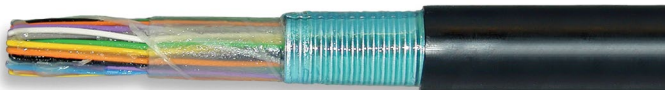

### SPECIFICATIONS

<b>Conductor</b>	Solid annealed copper
<b>Insulation</b>	Dual insulation consisting of an inner layer of foamed, natural polyolefin over which is applied a solid (skin) layer of polyolefin colored in accordance with industry standards
<b>Twisted Pairs</b>	Individual insulated conductors; twisted into pairs with varying lay lengths; specific color combinations provide pair identification
<b>≤ 25-Pair Core</b>	Pairs are assembled into a cylindrical core
<b>&gt; 25-Pair Core</b>	Cables larger than 25-pair are assembled into units, which are then used to assemble the core; units are identifiable using color-coded binders
<b>Filling Compound</b>	80°C ETPR compound, completely filling the interstices between the pairs and under the core wrap
<b>Core Wrap</b>	Non-hygroscopic, dielectric tape applied over the core
<b>Shield</b>	Corrugated, copolymer coated, 8 mil aluminum tape applied longitudinally with an overlap; flooded shield interfaces
<b>Jacket</b>	Black, polyethylene
<b>Jacket Marking</b>	Identifying information includes a telephone handset, cable code, pair count, AWG, date of manufacture and sequential length markings at 2 foot intervals
<b>Standards Compliance</b>	ANSI/ICEA S-84-608-2011 RDUP 7 CFR 1755.890 (PE-89) RoHS-compliant

### PRODUCT DESCRIPTION

SEALPIC®-FSF Cables are designed for low risk direct burial or duct applications where protection from moisture is required and aluminum shielding is desired. SEALPIC-FSF may be used aerially, but must be attached to a support strand.

### APPLICATIONS

- Low risk direct burial
- Underground conduit
- Lashed aerial

### FEATURES

- Twisted into pairs with varying lay lengths
- Core wrap
- Filled core
- Fully flooded shield interfaces
- Black, polyethylene jacket

### BENEFITS

- Minimizes crosstalk
- Provides thermal protection
- Moisture resistant
- Inhibits corrosion and water migration
- Provides a tough, protective covering designed to withstand exposure to direct sunlight, atmospheric temperature changes and stresses expected in standard installations

### ELECTRICAL SPECIFICATIONS

Number of Pairs	Average Mutual Capacitance @ 1,000 Hz nF/mile (nF/km)	Capacitance Unbalance Pair to Pair @ 1 kHz		Capacitance Unbalance Pair to Ground @ 1 kHz	
		Maximum Individual pF @ 1 kft (pF @ 1 km)	Maximum RMS pF @ 1 kft (pF @ 1 km)	Maximum Individual pF @ 1 kft (pF @ 1 km)	Maximum Average pF @ 1 kft (pF @ 1 km)
12 or less	83 ± 7 (52 ± 4)	80 (145)	-	800 (2,625)	-
Over 12	83 ± 4 (52 ± 2)	80 (145)	25 (45)	800 (2,625)	175 (574)

Conductor Size AWG (mm)	Minimum Insulation Resistance @ 68°F (20°C) gigohm-mile (gigohm-km)	Maximum Average Attenuation* 772 kHz @ 68°F (20°C) dB/kft (dB/km)	Maximum Conductor Resistance @ 68°F (20°C) Ohms/sheath mile (km)	DC Resistance Unbalance Maximum %		Dielectric Strength DC Potential - Volts	
				Average	Individual Pair	Conductor to Conductor	Conductor to Shield
19 (0.90)	1.0 (1.6)	3.2 (10.5)	45.0 (28.0)	1.5	5.0	4,500	10,000
22 (0.64)	1.0 (1.6)	4.5 (14.8)	91.0 (56.5)	1.5	5.0	3,600	10,000
24 (0.51)	1.0 (1.6)	5.6 (18.4)	144.0 (89.5)	1.5	5.0	3,000	10,000
26 (0.40)	1.0 (1.6)	7.0 (23.3)	232.0 (144.0)	1.5	5.0	2,400	10,000

\*For cables with 12-pair or less, the maximum average attenuation may be increased by 10% over the values shown.

#### Minimum Near End Crosstalk (NEXT) @ 772 kHz

PSWUNEXT Mean (dB)	47
PSWUNEXT Worst Pair (dB)	42

#### Minimum Far End Crosstalk (FEXT) @ 772 kHz

Conductor Size (AWG)	19	22	24	26
PSELFEXT Mean (dB/kft)	51	49	49	47
PSELFEXT Worst Pair (dB/kft)	45	43	43	43



## PART NUMBERS AND PHYSICAL CHARACTERISTICS

Part Number	Pair Count	AWG (mm)	Nominal Diameter in (mm)	Approx. Weight lbs/kft (kg/km)	Standard Length ft (m)	Approx. Shipping Weight lbs (kg)	Reel Size F x T x D in
09-026-02	6	19 (0.90)	0.49 (12)	120 (180)	5,000 (1,524)	710 (320)	44 x 18 x 20
09-028-02	12	19 (0.90)	0.59 (15)	190 (285)	5,000 (1,524)	1,115 (505)	46 x 25 x 20
09-031-02	25	19 (0.90)	0.78 (20)	355 (530)	5,000 (1,524)	1,980 (895)	52 x 25 x 20
09-034-02	50	19 (0.90)	1.03 (26)	655 (975)	5,000 (1,524)	3,565 (1,615)	62 x 30 x 24
09-038-02	100	19 (0.90)	1.37 (35)	1,225 (1,825)	2,500 (762)	3,430 (1,555)	65 x 30 x 32
09-057-02	6	22 (0.64)	0.39 (9.9)	70 (105)	5,000 (1,524)	415 (190)	36 x 18 x 14
09-059-02	12	22 (0.64)	0.47 (12)	115 (170)	5,000 (1,524)	685 (310)	44 x 18 x 20
09-062-02	25	22 (0.64)	0.60 (15)	200 (300)	5,000 (1,524)	1,165 (530)	46 x 25 x 20
09-065-02	50	22 (0.64)	0.77 (20)	350 (520)	5,000 (1,524)	1,955 (885)	52 x 25 x 20
09-069-02	100	22 (0.64)	1.02 (26)	650 (965)	5,000 (1,524)	3,540 (1,605)	62 x 30 x 24
09-073-02	200	22 (0.64)	1.38 (35)	1,225 (1,825)	2,500 (762)	3,350 (1,520)	62 x 30 x 24
09-075-02	300	22 (0.64)	1.65 (42)	1,800 (2,680)	1,250 (381)	2,495 (1,130)	58 x 25 x 20
09-077-02	400	22 (0.64)	1.88 (48)	2,365 (3,520)	1,250 (381)	3,245 (1,470)	62 x 30 x 24
09-081-02	600	22 (0.64)	2.28 (58)	3,505 (5,215)	1,250 (381)	4,995 (2,265)	72 x 35 x 36
09-083-02	900	22 (0.64)	2.76 (70)	5,195 (7,730)	1,250 (381)	7,290 (3,305)	84 x 40 x 42
09-085-02	1,200	22 (0.64)	3.14 (80)	6,845 (10,185)	1,250 (381)	9,730 (4,415)	96 x 40 x 48
09-092-02	6	24 (0.51)	0.36 (9.1)	55 (80)	5,000 (1,524)	320 (145)	36 x 18 x 14
09-094-02	12	24 (0.51)	0.42 (11)	85 (125)	5,000 (1,524)	490 (220)	36 x 18 x 14
09-097-02	25	24 (0.51)	0.52 (13)	140 (210)	5,000 (1,524)	810 (365)	44 x 18 x 20
09-100-02	50	24 (0.51)	0.66 (17)	240 (355)	5,000 (1,524)	1,365 (620)	46 x 25 x 20
09-104-02	100	24 (0.51)	0.85 (22)	430 (640)	5,000 (1,524)	2,395 (1,085)	58 x 25 x 20
09-108-02	200	24 (0.51)	1.14 (29)	810 (1,205)	5,000 (1,524)	4,665 (2,115)	72 x 35 x 36
09-110-02	300	24 (0.51)	1.37 (35)	1,180 (1,755)	2,500 (762)	3,320 (1,505)	65 x 30 x 32
09-112-02	400	24 (0.51)	1.55 (39)	1,545 (2,300)	2,500 (762)	4,475 (2,030)	72 x 35 x 36
09-116-02	600	24 (0.51)	1.88 (48)	2,285 (3,400)	1,250 (381)	3,145 (1,425)	62 x 30 x 24
09-118-02	900	24 (0.51)	2.25 (57)	3,350 (4,985)	1,300 (396)	4,800 (2,180)	72 x 35 x 36
09-120-02	1,200	24 (0.51)	2.57 (65)	4,420 (6,580)	1,250 (381)	6,225 (2,825)	78 x 40 x 39
09-121-02	1,500	24 (0.51)	2.86 (73)	5,490 (8,170)	1,000 (305)	6,190 (2,805)	84 x 40 x 42
09-124-02	1,800	24 (0.51)	3.12 (79)	6,560 (9,765)	1,000 (305)	7,355 (3,335)	84 x 40 x 42
09-125-02	2,100	24 (0.51)	3.40 (86)	7,690 (11,445)	1,000 (305)	8,865 (4,020)	96 x 40 x 48
09-126-02	2,400	24 (0.51)	3.59 (91)	8,695 (12,940)	1,000 (305)	9,870 (4,475)	96 x 40 x 48
09-153-02	900	26 (0.40)	1.78 (45)	2,120 (3,155)	1,250 (381)	3,020 (1,370)	65 x 30 x 32
09-155-02	1,200	26 (0.40)	2.03 (52)	2,785 (4,145)	1,250 (381)	4,095 (1,860)	72 x 35 x 36
09-157-02	1,800	26 (0.40)	2.48 (63)	4,150 (6,175)	1,250 (381)	5,885 (2,670)	78 x 40 x 39
09-159-02	2,400	26 (0.40)	2.86 (73)	5,515 (8,210)	1,250 (381)	8,070 (3,660)	96 x 40 x 48

**FOR EXTREME RISK ENVIRONMENTS**

For extreme direct burial or lashed aerial installations, this cable is available with the +M feature. See the "Mechanical Protection (+M) for Extreme Risk Environments" in the "Technical Info" section for more information.

# CASPIC® -FSF

## RDUP PE-89



### SPECIFICATIONS

<b>Conductor</b>	Solid Annealed Copper
<b>Insulation</b>	Dual insulation consisting of an inner layer of foamed, natural polyolefin over which is applied a solid (skin) layer of polyolefin colored in accordance with industry standards
<b>Twisted Pairs</b>	Individual insulated conductors; twisted into pairs with varying lay lengths; specific color combinations provide pair identification
<b>≤ 25-Pair Core</b>	Pairs are assembled into a cylindrical core
<b>&gt; 25-Pair Core</b>	Cables larger than 25-pair are assembled into units, which are then used to assemble the core; units are identifiable using color-coded binders
<b>Filling Compound</b>	80°C ETPR compound, completely filling the interstices between the pairs and under the core wrap
<b>Core Wrap</b>	Non-hygroscopic, dielectric tape applied over the core
<b>Inner Shield</b>	Corrugated, copolymer coated, 8 mil aluminum tape applied directly over the core wrap; does not butt or overlap at any point along the length of the cable; flooded shield interface
<b>Outer Shield</b>	Rodent resistant, corrugated, copolymer coated, 6 mil steel tape applied directly over the aluminum and overlaps; flooded shield interface
<b>Jacket</b>	Black, polyethylene
<b>Jacket Marking</b>	Identifying information includes a telephone handset, cable code, pair count, AWG, date of manufacture and sequential length markings at 2 foot intervals
<b>Standards Compliance</b>	ANSI/ICEA S-84-608-2011 RDUP 7 CFR 1755.890 (PE-89) RoHS-compliant

### PRODUCT DESCRIPTION

CASPIC®-FSF Cables are designed for direct burial applications. CASPIC-FSF cables are recommended for use in high-risk areas where additional mechanical or rodent protection is required. CASPIC-FSF may be used aerially, but must be attached to a support strand.

### APPLICATIONS

- Direct burial where additional mechanical protection is required or desired
- Lashed aerial where additional mechanical protection is required or desired

### FEATURES

- Twisted into pairs with varying lay lengths
- Core wrap
- Filled core
- Dual shield design
- Fully flooded shield interfaces
- Black, polyethylene jacket

### BENEFITS

- Minimizes crosstalk
- Provides thermal protection
- Moisture resistant
- Rodent resistant
- Inhibits corrosion and water migration
- Provides a tough, protective covering designed to withstand exposure to direct sunlight, atmospheric temperature changes and stresses expected in standard installations

### ELECTRICAL SPECIFICATIONS

Number of Pairs	Average Mutual Capacitance @ 1,000 Hz nF/mile (nF/km)	Capacitance Unbalance Pair to Pair @ 1 kHz		Capacitance Unbalance Pair to Ground @ 1 kHz	
		Maximum Individual pF @ 1 kft (pF @ 1 km)	Maximum RMS pF @ 1 kft (pF @ 1 km)	Maximum Individual pF @ 1 kft (pF @ 1 km)	Maximum Average pF @ 1 kft (pF @ 1 km)
12 or less	83 ± 7 (52 ± 4)	80 (145)	-	800 (2,625)	-
Over 12	83 ± 4 (52 ± 2)	80 (145)	25 (45)	800 (2,625)	175 (574)

Conductor Size AWG (mm)	Minimum Insulation Resistance @ 68°F (20°C) gigohm-mile (gigohm-km)	Maximum Average Attenuation* 772 kHz @ 68°F (20°C) dB/kft (dB/km)	Maximum Conductor Resistance @ 68°F (20°C) Ohms/sheath mile (km)	DC Resistance Unbalance Maximum %		Dielectric Strength DC Potential - Volts	
				Average	Individual Pair	Conductor to Conductor	Conductor to Shield
19 (0.90)	1.0 (1.6)	3.2 (10.5)	45.0 (28.0)	1.5	5.0	4,500	10,000
22 (0.64)	1.0 (1.6)	4.5 (14.8)	91.0 (56.5)	1.5	5.0	3,600	10,000
24 (0.51)	1.0 (1.6)	5.6 (18.4)	144.0 (89.5)	1.5	5.0	3,000	10,000

\*For cables with 12-pair or less, the maximum average attenuation may be increased by 10% over the values shown.

#### Minimum Near End Crosstalk (NEXT) @ 772 kHz

PSWUNEXT Mean (dB)	47
PSWUNEXT Worst Pair (dB)	42

#### Minimum Far End Crosstalk (FEXT) @ 772 kHz

Conductor Size (AWG)	19	22	24
PSELFEXT Mean (dB/kft)	51	49	49
PSELFEXT Worst Pair (dB/kft)	45	43	43

**PART NUMBERS AND PHYSICAL CHARACTERISTICS**

Part Number	Pair Count	AWG (mm)	Nominal Diameter in (mm)	Approx. Weight lbs/kft (kg/km)	Standard Length ft (m)	Approx. Shipping Weight lbs (kg)	Reel Size F x T x D in
09-031-92	25	19 (0.90)	0.81 (21)	415 (620)	5,000 (1,524)	2,320 (1,050)	58 x 25 x 20
09-057-92	6	22 (0.64)	0.42 (11)	95 (140)	5,000 (1,524)	540 (245)	36 x 18 x 14
09-059-92	12	22 (0.64)	0.50 (13)	150 (225)	5,000 (1,524)	860 (390)	44 x 18 x 20
09-062-92	25	22 (0.64)	0.63 (16)	245 (365)	5,000 (1,524)	1,390 (630)	46 x 25 x 20
09-065-92	50	22 (0.64)	0.80 (20)	410 (610)	5,000 (1,524)	2,295 (1,040)	58 x 25 x 20
09-069-92	100	22 (0.64)	1.05 (27)	730 (1,085)	5,000 (1,524)	4,265 (1,935)	72 x 35 x 36
09-073-92	200	22 (0.64)	1.42 (36)	1,345 (2,000)	2,500 (762)	3,650 (1,655)	62 x 30 x 24
09-075-92	300	22 (0.64)	1.70 (43)	1,945 (2,895)	1,250 (381)	2,720 (1,235)	62 x 30 x 24
09-092-92	6	24 (0.51)	0.39 (9.9)	80 (120)	5,000 (1,524)	465 (210)	36 x 18 x 14
09-094-92	12	24 (0.51)	0.45 (11)	110 (165)	5,000 (1,524)	615 (280)	36 x 18 x 14
09-097-92	25	24 (0.51)	0.55 (14)	180 (270)	5,000 (1,524)	1,065 (485)	46 x 25 x 20
09-100-92	50	24 (0.51)	0.69 (18)	290 (430)	5,000 (1,524)	1,615 (735)	46 x 25 x 20
09-104-92	100	24 (0.51)	0.88 (22)	500 (745)	5,000 (1,524)	2,745 (1,245)	58 x 25 x 20
09-108-92	200	24 (0.51)	1.18 (30)	905 (1,345)	2,500 (762)	2,510 (1,135)	58 x 25 x 20
09-110-92	300	24 (0.51)	1.41 (36)	1,300 (1,935)	2,500 (762)	3,540 (1,605)	62 x 30 x 24
09-112-92	400	24 (0.51)	1.59 (40)	1,680 (2,500)	2,500 (762)	4,815 (2,185)	72 x 35 x 36
09-116-92	600	24 (0.51)	1.92 (49)	2,450 (3,645)	1,250 (381)	3,350 (1,520)	62 x 30 x 24
09-118-92	900	24 (0.51)	2.29 (58)	3,555 (5,290)	1,300 (396)	5,060 (2,295)	72 x 35 x 36
09-120-92	1,200	24 (0.51)	2.62 (67)	4,660 (6,935)	1,250 (381)	6,525 (2,960)	78 x 40 x 39
09-121-92	1,500	24 (0.51)	2.91 (74)	5,755 (8,565)	1,000 (305)	6,455 (2,930)	78 x 40 x 39
09-124-92	1,800	24 (0.51)	3.17 (81)	6,855 (10,200)	1,000 (305)	7,650 (3,470)	84 x 40 x 42
09-125-92	2,100	24 (0.51)	3.45 (88)	8,015 (11,930)	1,000 (305)	9,190 (4,170)	96 x 40 x 48
09-126-92	2,400	24 (0.51)	3.64 (93)	9,035 (13,445)	750 (229)	7,950 (3,605)	96 x 40 x 48



**FOR EXTREME RISK ENVIRONMENTS**

For extreme direct burial or lashed aerial installations, this cable is available with the +M feature. See the "Mechanical Protection (+M) for Extreme Risk Environments" in the "Technical Info" section for more information.

# SEALPIC®-F

## RDUP PE-39



### SPECIFICATIONS

<b>Conductor</b>	Solid annealed copper
<b>Insulation</b>	Solid polyolefin; color coded in accordance with industry standards
<b>Twisted Pairs</b>	Individual insulated conductors; twisted into pairs with varying lay lengths; specific color combinations provide pair identification
<b>≤ 25-Pair Core</b>	Pairs are assembled into a cylindrical core
<b>&gt; 25-Pair Core</b>	Cables larger than 25-pair are assembled into units, which are then used to assemble the core; units are identifiable using color-coded binders
<b>Filling Compound</b>	80°C ETPR compound, completely filling the interstices between the pairs and under the core wrap
<b>Core Wrap</b>	Non-hygroscopic, dielectric tape applied over the core
<b>Shield</b>	Corrugated, copolymer coated, 8 mil aluminum tape applied longitudinally with an overlap; flooded shield interfaces
<b>Jacket</b>	Black, polyethylene
<b>Jacket Marking</b>	Identifying information includes a telephone handset, cable code, pair count, AWG, date of manufacture and sequential length markings at 2 foot intervals
<b>Standards Compliance</b>	ANSI/ICEA S-84-608-2011 RDUP 7 CFR 1755.390 (PE-39) RoHS-compliant

### PRODUCT DESCRIPTION

SEALPIC®-F Cables are designed for low risk direct burial or duct applications. SEALPIC-F may be used aerially, but must be attached to a support strand.

### APPLICATIONS

- Low risk direct burial
- Underground conduit
- Lashed aerial

### FEATURES

- Twisted into pairs with varying lay lengths
- Core wrap
- Filled core
- Fully flooded shield interfaces
- Black, polyethylene jacket

### BENEFITS

- Minimizes crosstalk
- Provides thermal protection
- Moisture resistant
- Inhibits corrosion and water migration
- Provides a tough, protective covering designed to withstand exposure to direct sunlight, atmospheric temperature changes and stresses expected in standard installations

### ELECTRICAL SPECIFICATIONS

Number of Pairs	Average Mutual Capacitance @ 1,000 Hz nF/mile (nF/km)	Capacitance Unbalance Pair to Pair @ 1 kHz		Capacitance Unbalance Pair to Ground @ 1 kHz	
		Maximum Individual pF @ 1 kft (pF @ 1 km)	Maximum RMS pF @ 1 kft (pF @ 1 km)	Maximum Individual pF @ 1 kft (pF @ 1 km)	Maximum Average pF @ 1 kft (pF @ 1 km)
12 or less	83 ± 7 (52 ± 4)	80 (145)	-	800 (2,625)	-
Over 12	83 ± 4 (52 ± 2)	80 (145)	25 (45)	800 (2,625)	175 (574)

Conductor Size AWG (mm)	Minimum Insulation Resistance @ 68°F (20°C) gigohm-mile (gigohm-km)	Maximum Average Attenuation* 772 kHz @ 68°F (20°C) dB/kft (dB/km)	Maximum Conductor Resistance @ 68°F (20°C) Ohms/sheath mile (km)	DC Resistance Unbalance Maximum %		Dielectric Strength DC Potential - Volts	
				Average	Individual Pair	Conductor to Conductor	Conductor to Shield
19 (0.90)	1.0 (1.6)	2.8 (9.2)	45.0 (28.0)	1.5	5.0	7,000	15,000
22 (0.64)	1.0 (1.6)	4.0 (13.1)	91.0 (56.5)	1.5	5.0	5,000	15,000
24 (0.51)	1.0 (1.6)	5.0 (16.4)	144.0 (89.5)	1.5	5.0	4,000	15,000

\*For cables of 12-pair or less, the maximum average attenuation may be increased by 10% over the values shown.

#### Minimum Near End Crosstalk (NEXT) @ 772 kHz

PSWUNEXT Mean (dB)	47
PSWUNEXT Worst Pair (dB)	42

#### Minimum Far End Crosstalk (FEXT) @ 772 kHz

Conductor Size (AWG)	19	22	24
PSELFEXT Mean (dB/kft)	51	49	49
PSELFEXT Worst Pair (dB/kft)	45	43	43

## PART NUMBERS AND PHYSICAL CHARACTERISTICS

Part Number	Pair Count	AWG (mm)	Nominal Diameter in (mm)	Approx. Weight lbs/kft (kg/km)	Standard Length ft (m)	Approx. Shipping Weight lbs (kg)	Reel Size F x T x D in
04-026-21	6	19 (0.90)	0.54 (14)	140 (210)	5,000 (1,524)	810 (365)	44 x 18 x 20
04-057-21	6	22 (0.64)	0.43 (11)	85 (125)	5,000 (1,524)	490 (220)	36 x 18 x 14
04-059-21	12	22 (0.64)	0.53 (14)	135 (200)	5,000 (1,524)	785 (355)	44 x 18 x 20
04-062-21	25	22 (0.64)	0.68 (17)	240 (355)	5,000 (1,524)	1,365 (620)	46 x 25 x 20
04-065-21	50	22 (0.64)	0.89 (23)	425 (630)	5,000 (1,524)	2,370 (1,075)	58 x 25 x 20
04-069-21	100	22 (0.64)	1.19 (30)	780 (1,160)	5,000 (1,524)	4,515 (2,050)	72 x 35 x 36
04-092-21	6	24 (0.51)	0.38 (9.7)	60 (90)	5,000 (1,524)	365 (165)	36 x 18 x 14
04-094-21	12	24 (0.51)	0.46 (12)	95 (140)	5,000 (1,524)	585 (265)	44 x 18 x 20
04-097-21	25	24 (0.51)	0.58 (15)	165 (245)	5,000 (1,524)	990 (450)	46 x 25 x 20
04-100-21	50	24 (0.51)	0.74 (19)	285 (425)	5,000 (1,524)	1,630 (740)	52 x 25 x 20
04-104-21	100	24 (0.51)	0.98 (25)	520 (775)	5,000 (1,524)	2,970 (1,345)	65 x 30 x 32
04-108-21	200	24 (0.51)	1.32 (34)	975 (1,450)	5,000 (1,524)	5,575 (2,530)	78 x 40 x 39
04-110-21	300	24 (0.51)	1.58 (40)	1,420 (2,115)	2,500 (762)	4,165 (1,890)	72 x 35 x 36
04-112-21	400	24 (0.51)	1.79 (46)	1,850 (2,755)	2,500 (762)	5,325 (2,415)	78 x 40 x 39
04-116-21	600	24 (0.51)	2.18 (55)	2,745 (4,085)	1,250 (381)	4,045 (1,835)	72 x 35 x 36
04-118-21	900	24 (0.51)	2.63 (67)	4,050 (6,025)	1,250 (381)	5,760 (2,615)	78 x 40 x 39
04-120-21	1,200	24 (0.51)	3.00 (76)	5,325 (7,925)	1,000 (305)	6,025 (2,730)	78 x 40 x 39

**FOR EXTREME RISK ENVIRONMENTS**

For extreme direct burial or lashed aerial installations, this cable is available with the +M feature. See the "Mechanical Protection (+M) for Extreme Risk Environments" in the "Technical Info" section for more information.

# CUPIC-F®

## RDUP PE-39

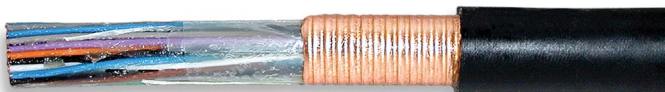

### SPECIFICATIONS

<b>Conductor</b>	Solid annealed copper
<b>Insulation</b>	Solid polyolefin; color coded in accordance with industry standards
<b>Twisted Pairs</b>	Individual insulated conductors; twisted into pairs with varying lay lengths; specific color combinations provide pair identification
<b>≤ 25-Pair Core</b>	Pairs are assembled into a cylindrical core
<b>&gt; 25-Pair Core</b>	Cables larger than 25-pair are assembled into units, which are then used to assemble the core; units are identifiable using color-coded binders
<b>Filling Compound</b>	80°C ETPR compound, completely filling the interstices between the pairs and under the core wrap
<b>Core Wrap</b>	Non-hygroscopic, dielectric tape applied over the core
<b>Shield</b>	Corrugated, 5 mil copper tape is applied longitudinally with an overlap; shield interfaces are flooded
<b>Jacket</b>	Black, polyethylene
<b>Jacket Marking</b>	Identifying information includes a telephone handset, cable code, pair count, AWG, date of manufacture and sequential length markings at 2 foot intervals
<b>Standards Compliance</b>	ANSI/ICEA S-84-608-2011 RDUP 7 CFR 1755.390 (PE-39) RoHS-compliant

### PRODUCT DESCRIPTION

CUPIC-F® Cables are designed for use in low risk duct or direct burial applications. CUPIC-F may be used aerially, but must be attached to a support strand.

### APPLICATIONS

- Low risk direct burial
- Underground conduit
- Lashed aerial

### FEATURES

- Twisted into pairs with varying lay lengths
- Core wrap
- Filled core
- Fully flooded shield interfaces
- Black, polyethylene jacket

### BENEFITS

- Minimizes crosstalk
- Provides thermal protection
- Moisture resistant
- Inhibits corrosion and water migration
- Provides a tough, protective covering designed to withstand exposure to direct sunlight, atmospheric temperature changes and stresses expected in standard installations

### ELECTRICAL SPECIFICATIONS

Number of Pairs	Average Mutual Capacitance @ 1,000 Hz nF/mile (nF/km)	Capacitance Unbalance Pair to Pair @ 1 kHz		Capacitance Unbalance Pair to Ground @ 1 kHz	
		Maximum Individual pF @ 1 kft (pF @ 1 km)	Maximum RMS pF @ 1 kft (pF @ 1 km)	Maximum Individual pF @ 1 kft (pF @ 1 km)	Maximum Average pF @ 1 kft (pF @ 1 km)
12 or less	83 ± 7 (52 ± 4)	80 (145)	-	800 (2,625)	-
Over 12	83 ± 4 (52 ± 2)	80 (145)	25 (45)	800 (2,625)	175 (574)

Conductor Size AWG (mm)	Minimum Insulation Resistance @ 68°F (20°C) gigohm-mile (gigohm-km)	Maximum Average Attenuation* 772 kHz @ 68°F (20°C) dB/kft (dB/km)	Maximum Conductor Resistance @ 68°F (20°C) Ohms/sheath mile (km)	DC Resistance Unbalance Maximum %		Dielectric Strength DC Potential - Volts	
				Average	Individual Pair	Conductor to Conductor	Conductor to Shield
19 (0.90)	1.0 (1.6)	2.8 (9.2)	45.0 (28.0)	1.5	5.0	7,000	15,000
22 (0.64)	1.0 (1.6)	4.0 (13.1)	91.0 (56.5)	1.5	5.0	5,000	15,000
24 (0.51)	1.0 (1.6)	5.0 (16.4)	144.0 (89.5)	1.5	5.0	4,000	15,000

\*For cables of 12-pair or less, the maximum average attenuation may be increased by 10% over the values shown.

#### Minimum Near End Crosstalk (NEXT) @ 772 kHz

PSWUNEXT Mean (dB)	47
PSWUNEXT Worst Pair (dB)	42

#### Minimum Far End Crosstalk (FEXT) @ 772 kHz

Conductor Size (AWG)	19	22	24
PSELFEXT Mean (dB/kft)	51	49	49
PSELFEXT Worst Pair (dB/kft)	45	43	43

## PART NUMBERS AND PHYSICAL CHARACTERISTICS

Part Number	Pair Count	AWG (mm)	Nominal Diameter in (mm)	Approx. Weight lbs/kft (kg/km)	Standard Length ft (m)	Approx. Shipping Weight lbs (kg)	Reel Size F x T x D in
04-028-04	12	19 (0.90)	0.69 (18)	255 (380)	5,000 (1,524)	1,440 (655)	46 x 25 x 20
04-031-04	25	19 (0.90)	0.92 (23)	470 (700)	5,000 (1,524)	2,720 (1,235)	65 x 30 x 32
04-034-04	50	19 (0.90)	1.22 (31)	845 (1,260)	5,000 (1,524)	4,925 (2,235)	78 x 40 x 39
04-057-04	6	22 (0.64)	0.43 (11)	95 (140)	5,000 (1,524)	540 (245)	36 x 18 x 14
04-059-04	12	22 (0.64)	0.53 (14)	145 (215)	5,000 (1,524)	835 (380)	44 x 18 x 20
04-062-04	25	22 (0.64)	0.68 (17)	255 (380)	5,000 (1,524)	1,440 (655)	46 x 25 x 20
04-065-04	50	22 (0.64)	0.89 (23)	450 (670)	5,000 (1,524)	2,495 (1,130)	58 x 25 x 20
04-069-04	100	22 (0.64)	1.19 (30)	815 (1,215)	5,000 (1,524)	4,690 (2,125)	72 x 35 x 36
04-073-04	200	22 (0.64)	1.63 (41)	1,550 (2,305)	2,500 (762)	4,490 (2,035)	72 x 35 x 36
04-075-04	300	22 (0.64)	1.97 (50)	2,270 (3,380)	2,500 (762)	6,375 (2,890)	78 x 40 x 39
04-077-04	400	22 (0.64)	2.23 (57)	2,960 (4,405)	1,250 (381)	4,315 (1,955)	72 x 35 x 36
04-092-04	6	24 (0.51)	0.38 (9.7)	70 (105)	5,000 (1,524)	415 (190)	36 x 18 x 14
04-094-04	12	24 (0.51)	0.46 (12)	110 (165)	5,000 (1,524)	660 (300)	44 x 18 x 20
04-097-04	25	24 (0.51)	0.58 (15)	180 (270)	5,000 (1,524)	1,065 (485)	46 x 25 x 20
04-100-04	50	24 (0.51)	0.74 (19)	305 (455)	5,000 (1,524)	1,730 (785)	52 x 25 x 20
04-104-04	100	24 (0.51)	0.98 (25)	550 (820)	5,000 (1,524)	3,120 (1,415)	65 x 30 x 32
04-108-04	200	24 (0.51)	1.32 (34)	1,015 (1,510)	5,000 (1,524)	5,775 (2,620)	78 x 40 x 39
04-110-04	300	24 (0.51)	1.59 (40)	1,470 (2,190)	2,500 (762)	4,290 (1,945)	72 x 35 x 36
04-112-04	400	24 (0.51)	1.79 (46)	1,905 (2,835)	2,500 (762)	5,460 (2,475)	78 x 40 x 39
04-116-04	600	24 (0.51)	2.18 (55)	2,815 (4,190)	1,250 (381)	4,135 (1,875)	72 x 35 x 36
04-118-04	900	24 (0.51)	2.63 (67)	4,135 (6,155)	1,250 (381)	5,870 (2,660)	78 x 40 x 39

**FOR EXTREME RISK ENVIRONMENTS**

For extreme direct burial or lashed aerial installations, this cable is available with the +M feature. See the "Mechanical Protection (+M) for Extreme Risk Environments" in the "Technical Info" section for more information.

# GOPIC®-F

## RDUP PE-39



### SPECIFICATIONS

<b>Conductor</b>	Solid annealed copper
<b>Insulation</b>	Solid polyolefin; color coded in accordance with industry standards
<b>Twisted Pairs</b>	Individual insulated conductors; twisted into pairs with varying lay lengths; specific color combinations provide pair identification
<b>≤ 25-Pair Core</b>	Pairs are assembled into a cylindrical core
<b>&gt; 25-Pair Core</b>	Cables larger than 25-pair are assembled into units, which are then used to assemble the core; units are identifiable using color-coded binders
<b>Filling Compound</b>	80°C ETPR compound, completely filling the interstices between the pairs and under the core wrap
<b>Core Wrap</b>	Non-hygroscopic, dielectric tape applied over the core
<b>Shield</b>	Corrugated, rodent resistant, copper bearing armor applied longitudinally with an overlap; flooded shield interfaces
<b>Jacket</b>	Black, polyethylene
<b>Jacket Marking</b>	Identifying information includes a telephone handset, cable code, pair count, AWG, date of manufacture and sequential length markings at 2 foot intervals
<b>Standards Compliance</b>	ANSI/ICEA S-84-608-2011 RDUP 7 CFR 1755.390 (PE-39) RoHS-compliant

### PRODUCT DESCRIPTION

GOPIC®-F Cables are designed for use in direct burial applications where additional mechanical or rodent protection is required. GOPIC-F may be used aerially, but must be attached to a support strand.

### APPLICATIONS

- Direct burial where additional mechanical protection is required or desired
- Lashed aerial where additional mechanical protection is required or desired

### FEATURES

- Twisted into pairs with varying lay lengths
- Core wrap
- Filled core
- Corrugated, copper bearing armor
- Fully flooded shield interfaces
- Black, polyethylene jacket

### BENEFITS

- Minimizes crosstalk
- Provides thermal protection
- Moisture resistant
- Rodent resistant
- Inhibits corrosion and water migration
- Provides a tough, protective covering designed to withstand exposure to direct sunlight, atmospheric temperature changes and stresses expected in standard installations

### ELECTRICAL SPECIFICATIONS

Number of Pairs	Average Mutual Capacitance @ 1,000 Hz nF/mile (nF/km)	Capacitance Unbalance Pair to Pair @ 1 kHz		Capacitance Unbalance Pair to Ground @ 1 kHz	
		Maximum Individual pF @ 1 kft (pF @ 1 km)	Maximum RMS pF @ 1 kft (pF @ 1 km)	Maximum Individual pF @ 1 kft (pF @ 1 km)	Maximum Average pF @ 1 kft (pF @ 1 km)
12 or less	83 ± 7 (52 ± 4)	80 (145)	-	800 (2,625)	-
Over 12	83 ± 4 (52 ± 2)	80 (145)	25 (45)	800 (2,625)	175 (574)

Conductor Size AWG (mm)	Minimum Insulation Resistance @ 68°F (20°C) gigohm-mile (gigohm-km)	Maximum Average Attenuation* 772 kHz @ 68°F (20°C) dB/kft (dB/km)	Maximum Conductor Resistance @ 68°F (20°C) Ohms/sheath mile (km)	DC Resistance Unbalance Maximum %		Dielectric Strength DC Potential - Volts	
				Average	Individual Pair	Conductor to Conductor	Conductor to Shield
19 (0.90)	1.0 (1.6)	2.8 (9.2)	45.0 (28.0)	1.5	5.0	7,000	15,000
22 (0.64)	1.0 (1.6)	4.0 (13.1)	91.0 (56.5)	1.5	5.0	5,000	15,000
24 (0.51)	1.0 (1.6)	5.0 (16.4)	144.0 (89.5)	1.5	5.0	4,000	15,000

\*For cables of 12-pair or less, the maximum average attenuation may be increased by 10% over the values shown.

#### Minimum Near End Crosstalk (NEXT) @ 772 kHz

PSWUNEXT Mean (dB)	47
PSWUNEXT Worst Pair (dB)	42

#### Minimum Far End Crosstalk (FEXT) @ 772 kHz

Conductor Size (AWG)	19	22	24
PSELFEXT Mean (dB/kft)	51	49	49
PSELFEXT Worst Pair (dB/kft)	45	43	43



## PART NUMBERS AND PHYSICAL CHARACTERISTICS

Part Number	Pair Count	AWG (mm)	Nominal Diameter in (mm)	Approx. Weight lbs/kft (kg/km)	Standard Length ft (m)	Approx. Shipping Weight lbs (kg)	Reel Size F x T x D in
04-026-27	6	19 (0.90)	0.54 (14)	155 (230)	5,000 (1,524)	885 (400)	44 x 18 x 20
04-028-27	12	19 (0.90)	0.69 (18)	255 (380)	5,000 (1,524)	1,440 (655)	46 x 25 x 20
04-031-27	25	19 (0.90)	0.92 (23)	470 (700)	5,000 (1,524)	2,720 (1,235)	65 x 30 x 32
04-034-27	50	19 (0.90)	1.22 (31)	850 (1,265)	5,000 (1,524)	4,950 (2,245)	78 x 40 x 39
04-038-27	100	19 (0.90)	1.69 (43)	1,620 (2,410)	2,500 (762)	4,665 (2,115)	72 x 35 x 36
04-057-27	6	22 (0.64)	0.43 (11)	95 (140)	5,000 (1,524)	540 (245)	36 x 18 x 14
04-059-27	12	22 (0.64)	0.53 (14)	150 (225)	5,000 (1,524)	860 (390)	44 x 18 x 20
04-062-27	25	22 (0.64)	0.68 (17)	260 (385)	5,000 (1,524)	1,465 (665)	46 x 25 x 20
04-065-27	50	22 (0.64)	0.89 (23)	450 (670)	5,000 (1,524)	2,495 (1,130)	58 x 25 x 20
04-069-27	100	22 (0.64)	1.19 (30)	820 (1,220)	5,000 (1,524)	4,715 (2,140)	72 x 35 x 36
04-073-27	200	22 (0.64)	1.63 (41)	1,555 (2,315)	2,500 (762)	4,500 (2,040)	72 x 35 x 36
04-092-27	6	24 (0.51)	0.38 (9.7)	70 (105)	5,000 (1,524)	415 (190)	36 x 18 x 14
04-094-27	12	24 (0.51)	0.46 (12)	110 (165)	5,000 (1,524)	660 (300)	44 x 18 x 20
04-097-27	25	24 (0.51)	0.58 (15)	180 (270)	5,000 (1,524)	1,065 (485)	46 x 25 x 20
04-100-27	50	24 (0.51)	0.74 (19)	310 (460)	5,000 (1,524)	1,755 (795)	52 x 25 x 20
04-104-27	100	24 (0.51)	0.98 (25)	550 (820)	5,000 (1,524)	3,120 (1,415)	65 x 30 x 32
04-108-27	200	24 (0.51)	1.32 (34)	1,020 (1,520)	5,000 (1,524)	5,800 (2,630)	78 x 40 x 39
04-110-27	300	24 (0.51)	1.58 (40)	1,475 (2,195)	2,500 (762)	4,300 (1,950)	72 x 35 x 36
04-112-27	400	24 (0.51)	1.79 (46)	1,910 (2,845)	2,500 (762)	5,475 (2,485)	78 x 40 x 39

**FOR EXTREME RISK ENVIRONMENTS**

For extreme direct burial or lashed aerial installations, this cable is available with the +M feature. See the "Mechanical Protection (+M) for Extreme Risk Environments" in the "Technical Info" section for more information.

# ALPETH

BHBA, BHAA, BKMA and BKTA



## SPECIFICATIONS

<b>Conductor</b>	Solid annealed copper
<b>Insulation</b>	Solid polyolefin in distinctive colors to facilitate pair identification
<b>≤ 25-Pair Core</b>	Pairs are combined into a cylindrical core
<b>&gt; 50-Pair Core</b>	Multiples of 25-pair groups are assembled to form the final cable core; each group is identified by color coded non-hygroscopic binders; for 1,200-pair and larger, the color code is a Mirror Image design
<b>Core Wrap</b>	Non-hygroscopic dielectric material protects the core and helps provide core-to-shield dielectric strength
<b>Shield</b>	Corrugated bare 8 mil aluminum tape is applied longitudinally over the core wrap
<b>Jacket</b>	Black polyethylene
<b>Shield/Jacket Options</b>	If extra mechanical protection is desired, an additional outer steel armor and polyethylene jacket (UM) can be requested
<b>Jacket Marking</b>	Manufacturer's identification, pair count, AWG, product identification, sequential footage and a telephone handset printed at 2 foot intervals
<b>Standards Compliance</b>	Telcordia® GR-421-CORE Issue 2 RoHS-compliant

Telcordia is a registered trademark of Ericsson Inc.

## PRODUCT DESCRIPTION

ALPETH Cable is a solid insulated, single jacket air core design intended for aerial installations. In this application, the cable must be attached to a support strand (messenger). ALPETH cable is not recommended for any buried or duct application, with or without air pressure.

## APPLICATIONS

- Lashed aerial

## FEATURES

- Tightly controlled individual conductor dimensions
- Specially designed pair twist lays
- Core wrap
- Bare aluminum tape shield
- Polyethylene jacket

## BENEFITS

- Limits resistance unbalance of paired conductors
- Minimizes crosstalk and meets the capacitance unbalance requirements
- Protects core and provides improved mechanical and electrical characteristics
- Assures good electrical contact with non-piercing bonding clamps
- Provides a tough, flexible, protective covering that withstands exposure to sunlight, atmospheric temperatures and stresses expected in standard installations

## ELECTRICAL SPECIFICATIONS

Number of Pairs	Average Mutual Capacitance @ 1,000 Hz nF/mile (nF/km)	Capacitance Unbalance Pair to Pair @ 1 kHz		Capacitance Unbalance Pair to Ground @ 1 kHz	
		Maximum Individual pF @ 1 kft (pF @ 1 km)	Maximum RMS pF @ 1 kft (pF @ 1 km)	Maximum Individual pF @ 1 kft (pF @ 1 km)	Maximum Average pF @ 1 kft (pF @ 1 km)
Over 12	83 ± 4 (52 ± 2)	80 (145)	25 (45)	800 (2,625)	175 (574)

Conductor Size AWG (mm)	Minimum Insulation Resistance @ 68°F (20°C) gigohm-mile (gigohm-km)	Maximum Average Attenuation 772 kHz @ 68°F (20°C) dB/kft (dB/km)	Maximum Conductor Resistance @ 68°F (20°C) Ohms/sheath mile (km)	DC Resistance Unbalance Maximum %		Dielectric Strength DC Potential - Volts	
				Average	Individual Pair	Conductor to Conductor	Conductor to Shield
19 (0.90)	1.0 (1.6)	3.3 (10.8)	45 (28.0)	1.5	5.0	5,000	10,000
22 (0.64)	1.0 (1.6)	4.7 (15.4)	91 (56.5)	1.5	5.0	4,000	10,000
24 (0.51)	1.0 (1.6)	5.9 (19.4)	144 (89.5)	1.5	5.0	3,000	10,000
26 (0.40)	1.0 (1.6)	7.4 (24.3)	232 (144.2)	1.5	5.0	2,400	10,000

### Minimum Near End Crosstalk (NEXT) @ 772 kHz

PSWUNEXT Mean (dB)	47
PSWUNEXT Worst Pair (dB)	42

### Minimum Far End Crosstalk (FEXT) @ 772 kHz

Conductor Size (AWG)	19	22	24	26
PSELFEXT Mean (dB/kft)	51	49	49	47
PSELFEXT Worst Pair (dB/kft)	45	43	43	43

## PART NUMBERS AND PHYSICAL CHARACTERISTICS

Part Number	Product Code	Pair Count	AWG (mm)	Nominal Diameter in (mm)	Approx. Weight lbs/kft (kg/km)	Standard Length ft (m)	Approx. Shipping Weight lbs (kg)	Steel Reel Size F x T x D in
20-031-42	BHBA	25	19 (0.90)	0.76 (19)	310 (460)	10,000 (3,048)	3,895 (1,765)	83 x 40 x 42
20-034-42	BHBA	50	19 (0.90)	1.00 (25)	570 (850)	10,000 (3,048)	6,495 (2,945)	83 x 40 x 42
20-038-42	BHBA	100	19 (0.90)	1.34 (34)	1,070 (1,590)	5,000 (1,524)	6,145 (2,785)	83 x 40 x 42
20-042-42	BHBA	200	19 (0.90)	1.85 (47)	2,075 (3,090)	2,500 (762)	5,985 (2,715)	83 x 40 x 42
20-044-42	BHBA	300	19 (0.90)	2.23 (57)	3,065 (4,560)	2,000 (610)	6,925 (3,140)	83 x 40 x 42
20-062-42	BHAA	25	22 (0.64)	0.60 (15)	180 (270)	15,000 (4,572)	3,495 (1,585)	83 x 40 x 42
20-065-42	BHAA	50	22 (0.64)	0.77 (20)	315 (470)	15,000 (4,572)	5,520 (2,505)	83 x 40 x 42
20-069-42	BHAA	100	22 (0.64)	1.02 (26)	580 (865)	10,000 (3,048)	6,595 (2,990)	83 x 40 x 42
20-073-42	BHAA	200	22 (0.64)	1.38 (35)	1,090 (1,620)	5,000 (1,524)	6,245 (2,835)	83 x 40 x 42
20-075-42	BHAA	300	22 (0.64)	1.66 (42)	1,600 (2,380)	3,300 (1,006)	6,075 (2,755)	83 x 40 x 42
20-077-42	BHAA	400	22 (0.64)	1.89 (48)	2,110 (3,140)	2,500 (762)	6,070 (2,755)	83 x 40 x 42
20-081-42	BHAA	600	22 (0.64)	2.28 (58)	3,115 (4,635)	2,000 (610)	7,025 (3,185)	83 x 40 x 42
20-083-42	BHAA	900	22 (0.64)	2.76 (70)	4,625 (6,885)	1,100 (335)	5,885 (2,670)	83 x 40 x 42
20-097-42	BKMA	25	24 (0.51)	0.51 (13)	125 (185)	20,000 (6,096)	3,295 (1,495)	83 x 40 x 42
20-100-42	BKMA	50	24 (0.51)	0.64 (16)	215 (320)	20,000 (6,096)	5,095 (2,310)	83 x 40 x 42
20-104-42	BKMA	100	24 (0.51)	0.83 (21)	380 (565)	13,300 (4,054)	5,850 (2,655)	83 x 40 x 42
20-108-42	BKMA	200	24 (0.51)	1.12 (28)	710 (1,055)	8,000 (2,438)	6,475 (2,935)	83 x 40 x 42
20-110-42	BKMA	300	24 (0.51)	1.33 (34)	1,035 (1,540)	5,700 (1,737)	6,695 (3,035)	83 x 40 x 42
20-112-42	BKMA	400	24 (0.51)	1.52 (39)	1,355 (2,015)	4,400 (1,341)	6,755 (3,065)	83 x 40 x 42
20-116-42	BKMA	600	24 (0.51)	1.82 (46)	1,995 (2,970)	2,500 (762)	6,980 (3,165)	83 x 40 x 42
20-118-42	BKMA	900	24 (0.51)	2.19 (56)	2,950 (4,390)	1,500 (458)	7,285 (3,305)	83 x 40 x 42
20-120-42	BKMA	1,200	24 (0.51)	2.50 (64)	3,905 (5,810)	1,600 (488)	7,045 (3,195)	83 x 40 x 42
20-121-42	BKMA	1,500	24 (0.51)	2.79 (71)	4,860 (7,235)	1,000 (305)	6,870 (3,115)	83 x 40 x 42
20-124-42	BKMA	1,800	24 (0.51)	3.05 (78)	5,810 (8,645)	1,140 (347)	7,420 (3,365)	83 x 40 x 42
20-145-42	BKTA	300	26 (0.40)	1.07 (27)	675 (1,005)	8,000 (2,438)	6,195 (2,810)	83 x 40 x 42
20-147-42	BKTA	400	26 (0.40)	1.23 (31)	875 (1,300)	6,600 (2,012)	6,570 (2,980)	83 x 40 x 42
20-151-42	BKTA	600	26 (0.40)	1.47 (37)	1,290 (1,920)	5,000 (1,524)	7,245 (3,285)	83 x 40 x 42
20-153-42	BKTA	900	26 (0.40)	1.75 (45)	1,890 (2,815)	3,300 (1,006)	7,030 (3,190)	83 x 40 x 42
20-155-42	BKTA	1,200	26 (0.40)	2.00 (51)	2,495 (3,715)	2,200 (671)	6,285 (2,850)	83 x 40 x 42
20-156-42	BKTA	1,500	26 (0.40)	2.25 (57)	3,100 (4,615)	2,000 (610)	6,995 (3,175)	83 x 40 x 42
20-157-42	BKTA	1,800	26 (0.40)	2.45 (62)	3,695 (5,500)	1,600 (488)	6,705 (3,040)	83 x 40 x 42
20-158-42	BKTA	2,100	26 (0.40)	2.65 (67)	4,305 (6,405)	1,140 (347)	5,705 (2,585)	83 x 40 x 42

# PASP

BHBH, BHAH, BKMH and BKTH



## PRODUCT DESCRIPTION

PASP Cable is a solid insulated, double jacket, armored air core design intended for use in outside cable plant where a greater risk of physical damage exists. The inner jacket provides protection to the cable core in the event of severe damage to the outer protective sheath.

## APPLICATIONS

- Pressurized direct buried installations in harsh environments

## FEATURES

- Tightly controlled individual conductor dimensions
- Specially designed pair twist lays
- Core wrap
- Inner polyethylene jacket
- Aluminum tape shield
- Steel tape armor bonded to outer jacket
- Polyethylene jacket

## BENEFITS

- Limits resistance unbalance of paired conductors
- Minimizes crosstalk and meets the capacitance unbalance requirements
- Protects the core and provides core-to-shield dielectric strength
- Provides additional protection against mechanical damage and prevents the ingress of moisture
- Assures good electrical contact with non-piercing bonding clamps
- Protects the core from mechanical damage and reduces the possibility of tape buckling during installation, ingress of water to the aluminum shield and of water along the cable between the armor and outer jacket
- Provides a tough, flexible, protective covering that withstands exposure to sunlight, atmospheric temperatures, ground chemicals and stresses expected in standard installations

## SPECIFICATIONS

<b>Conductor</b>	Solid annealed copper
<b>Insulation</b>	Conductors are insulated with solid polyolefin in distinctive colors to facilitate pair identification
<b>≤ 25-Pair Core</b>	Pairs are combined into a cylindrical core
<b>&gt; 50-Pair Core</b>	Multiples of 25-pair groups are assembled to form the final cable core; each group is identified by color coded non-hygroscopic binders; for 1,200-pair and larger, the color code is a Mirror Image design
<b>Core Wrap</b>	Non-hygroscopic dielectric material
<b>Inner Jacket</b>	Polyethylene
<b>Shield</b>	Corrugated bare 8 mil aluminum tape applied longitudinally over the inner jacket
<b>Armor</b>	Corrugated, copolymer coated, 6 mil steel tape applied over the aluminum shield; armor is bonded to the outer jacket
<b>Outer Jacket</b>	Black polyethylene
<b>Jacket Marking</b>	Manufacturer's identification, pair count, AWG, product identification, sequential footage and a telephone handset printed at 2 foot intervals
<b>Standards Compliance</b>	Telcordia® GR-421-CORE Issue 2 RoHS-compliant

Telcordia is a registered trademark of Ericsson Inc.

## ELECTRICAL SPECIFICATIONS

Number of Pairs	Average Mutual Capacitance @ 1,000 Hz nF/mile (nF/km)	Capacitance Unbalance Pair to Pair @ 1 kHz		Capacitance Unbalance Pair to Ground @ 1 kHz	
		Maximum Individual pF @ 1 kft (pF @ 1 km)	Maximum RMS pF @ 1 kft (pF @ 1 km)	Maximum Individual pF @ 1 kft (pF @ 1 km)	Maximum Average pF @ 1 kft (pF @ 1 km)
Over 12	83 ± 4 (52 ± 2)	80 (145)	25 (45)	800 (2,625)	175 (574)

Conductor Size AWG (mm)	Minimum Insulation Resistance @ 68°F (20°C) gigohm-mile (gigohm-km)	Maximum Average Attenuation 772 kHz @ 68°F (20°C) dB/kft (dB/km)	Maximum Conductor Resistance @ 68°F (20°C) Ohms/sheath mile (km)	DC Resistance Unbalance Maximum %		Dielectric Strength DC Potential - Volts	
				Average	Individual Pair	Conductor to Conductor	Conductor to Shield
19 (0.90)	1.0 (1.6)	3.3 (10.8)	45 (28.0)	1.5	5.0	5,000	20,000
22 (0.64)	1.0 (1.6)	4.7 (15.4)	91 (56.5)	1.5	5.0	4,000	20,000
24 (0.51)	1.0 (1.6)	5.9 (19.4)	144 (89.5)	1.5	5.0	3,000	20,000
26 (0.40)	1.0 (1.6)	7.4 (24.3)	232 (144.2)	1.5	5.0	2,400	20,000

### Minimum Near End Crosstalk (NEXT) @ 772 kHz

PSWUNEXT Mean (dB)	47
PSWUNEXT Worst Pair (dB)	42

### Minimum Far End Crosstalk (FEXT) @ 772 kHz

Conductor Size (AWG)	19	22	24	26
PSELFEXT Mean (dB/kft)	51	49	49	47
PSELFEXT Worst Pair (dB/kft)	45	43	43	43

**PART NUMBERS AND PHYSICAL CHARACTERISTICS**

Part Number	Product Code	Pair Count	AWG (mm)	Nominal Diameter in (mm)	Approx. Weight lbs/kft (kg/km)	Standard Length ft (m)	Approx. Shipping Weight lbs (kg)	Steel Reel Size F x T x D in
20-031-05	BHBH	25	19 (0.90)	0.89 (23)	415 (620)	10,000 (3,048)	4,945 (2,245)	83 x 40 x 42
20-034-05	BHBH	50	19 (0.90)	1.13 (29)	705 (1,050)	5,000 (1,524)	4,320 (1,960)	83 x 40 x 42
20-038-05	BHBH	100	19 (0.90)	1.50 (38)	1,280 (1,905)	3,300 (1,006)	5,020 (2,275)	83 x 40 x 42
20-062-05	BHAH	25	22 (0.64)	0.72 (18)	260 (385)	15,000 (4,572)	4,695 (2,130)	83 x 40 x 42
20-065-05	BHAH	50	22 (0.64)	0.90 (23)	425 (630)	10,000 (3,048)	5,045 (2,290)	83 x 40 x 42
20-069-05	BHAH	100	22 (0.64)	1.15 (29)	715 (1,065)	7,500 (2,286)	6,160 (2,795)	83 x 40 x 42
20-073-05	BHAH	200	22 (0.64)	1.54 (39)	1,300 (1,935)	3,750 (1,143)	5,670 (2,570)	83 x 40 x 42
20-075-05	BHAH	300	22 (0.64)	1.83 (47)	1,865 (2,775)	3,300 (1,006)	6,950 (3,150)	83 x 40 x 42
20-077-05	BHAH	400	22 (0.64)	2.05 (52)	2,405 (3,580)	2,000 (610)	5,605 (2,540)	83 x 40 x 42
20-081-05	BHAH	600	22 (0.64)	2.48 (63)	3,515 (5,230)	1,250 (381)	5,190 (2,355)	83 x 40 x 42
20-083-05	BHAH	900	22 (0.64)	2.96 (75)	5,110 (7,605)	1,100 (335)	6,415 (2,910)	83 x 40 x 42
20-097-05	BKMH	25	24 (0.51)	0.63 (16)	195 (290)	20,000 (6,096)	4,695 (2,130)	83 x 40 x 42
20-100-05	BKMH	50	24 (0.51)	0.76 (19)	300 (445)	13,300 (4,054)	4,785 (2,170)	83 x 40 x 42
20-104-05	BKMH	100	24 (0.51)	0.97 (25)	500 (745)	10,000 (3,048)	5,795 (2,630)	83 x 40 x 42
20-108-05	BKMH	200	24 (0.51)	1.24 (32)	860 (1,280)	6,600 (2,012)	6,470 (2,935)	83 x 40 x 42
20-110-05	BKMH	300	24 (0.51)	1.49 (38)	1,240 (1,845)	4,400 (1,341)	6,250 (2,835)	83 x 40 x 42
20-112-05	BKMH	400	24 (0.51)	1.68 (43)	1,595 (2,375)	3,300 (1,006)	6,060 (2,750)	83 x 40 x 42
20-116-05	BKMH	600	24 (0.51)	1.99 (51)	2,290 (3,410)	2,500 (762)	6,520 (2,955)	83 x 40 x 42
20-118-05	BKMH	900	24 (0.51)	2.38 (61)	3,335 (4,965)	1,600 (488)	6,130 (2,780)	83 x 40 x 42
20-120-05	BKMH	1,200	24 (0.51)	2.72 (69)	4,355 (6,480)	1,100 (335)	5,585 (2,535)	83 x 40 x 42
20-121-05	BKMH	1,500	24 (0.51)	2.99 (76)	5,350 (7,960)	1,100 (335)	6,680 (3,030)	83 x 40 x 42
20-124-05	BKMH	1,800	24 (0.51)	3.25 (83)	6,340 (9,435)	800 (244)	5,865 (2,660)	83 x 40 x 42
20-145-05	BKTH	300	26 (0.40)	1.20 (31)	820 (1,220)	6,600 (2,012)	6,205 (2,815)	83 x 40 x 42
20-147-05	BKTH	400	26 (0.40)	1.40 (36)	1,075 (1,600)	5,000 (1,524)	6,170 (2,800)	83 x 40 x 42
20-151-05	BKTH	600	26 (0.40)	1.64 (42)	1,520 (2,260)	3,300 (1,006)	5,810 (2,635)	83 x 40 x 42
20-153-05	BKTH	900	26 (0.40)	1.93 (49)	2,175 (3,235)	2,600 (792)	6,450 (2,925)	83 x 40 x 42
20-155-05	BKTH	1,200	26 (0.40)	2.20 (56)	2,845 (4,235)	2,200 (671)	7,055 (3,200)	83 x 40 x 42
20-156-05	BKTH	1,500	26 (0.40)	2.45 (62)	3,490 (5,195)	1,600 (488)	6,380 (2,895)	83 x 40 x 42
20-157-05	BKTH	1,800	26 (0.40)	2.66 (68)	4,135 (6,155)	1,300 (396)	6,170 (2,800)	83 x 40 x 42
20-158-05	BKTH	2,100	26 (0.40)	2.85 (72)	4,770 (7,100)	1,140 (347)	6,235 (2,825)	83 x 40 x 42
20-161-05	BKTH	2,700	26 (0.40)	3.18 (81)	6,015 (8,950)	1,140 (347)	7,650 (3,470)	83 x 40 x 42

# Self-Support

BHAS and BKMS



## PRODUCT DESCRIPTION

Self-Support Cable is a solid insulated, single jacket air core design with a built-in support member intended specifically for aerial applications. The undulated, shielded core is laid parallel to a flooded steel support member and jacketed in an integral extrusion to form a “figure 8” configuration. The supporting member is an integral part of the cable sheath yet readily available for gripping, pulling and tensioning. Installation is fast and easy using standard methods and hardware.

## APPLICATIONS

- Aerial

## FEATURES

- Tightly controlled individual conductor dimensions
- Specially designed pair twist lays
- Undulated core assembly
- Core wrap
- Fully flooded steel support member
- Polyethylene jacket

## BENEFITS

- Limits resistance unbalance of paired conductors
- Minimizes crosstalk and meets the capacitance unbalance requirements
- Eliminates strain on the conductors and provides sufficient slack during installation
- Protects the core and helps provide core-to-shield dielectric strength
- Provides corrosion protection
- Provides tough, flexible, protective covering that withstands exposure to sunlight, atmospheric temperatures and stresses expected in standard installations

## SPECIFICATIONS

<b>Conductor</b>	Solid annealed copper
<b>Insulation</b>	Solid polyolefin in distinctive colors to facilitate pair identification
<b>≤ 25-Pair Core</b>	Pairs are combined into a cylindrical core
<b>&gt; 50-Pair Core</b>	Multiples of 25-pair groups are assembled to form the final cable core; each group is identified by color coded non-hygroscopic binders
<b>Core Wrap</b>	Non-hygroscopic dielectric material
<b>Shield</b>	Corrugated, 8 mil coated aluminum tape applied longitudinally over the core wrap
<b>Support Member</b>	0.25 inch, 7-strand Extra High-Strength (EHS) galvanized steel member, fully flooded, serves as the support member and is an integral part of the sheath
<b>Jacket</b>	Black polyethylene
<b>Jacket Marking</b>	Manufacturer's identification, pair count, AWG, product identification, sequential footage and a telephone handset printed at 2 foot intervals
<b>Standards Compliance</b>	Telcordia® GR-421-CORE Issue 2 RoHS-compliant

Telcordia is a registered trademark of Ericsson Inc.

## ELECTRICAL SPECIFICATIONS

Number of Pairs	Average Mutual Capacitance @ 1,000 Hz nF/mile (nF/km)	Capacitance Unbalance Pair to Pair @ 1 kHz		Capacitance Unbalance Pair to Ground @ 1 kHz	
		Maximum Individual pF @ 1 kft (pF @ 1 km)	Maximum RMS pF @ 1 kft (pF @ 1 km)	Maximum Individual pF @ 1 kft (pF @ 1 km)	Maximum Average pF @ 1 kft (pF @ 1 km)
Over 12	83 + 4, - 5 (52 + 2, - 3)	80 (145)	25 (45)	800 (2,625)	175 (574)

Conductor Size AWG (mm)	Minimum Insulation Resistance @ 68°F (20°C) gigohm-mile (gigohm-km)	Maximum Average Attenuation 772 kHz @ 68°F (20°C) dB/kft (dB/km)	Maximum Conductor Resistance @ 68°F (20°C) Ohms/sheath mile (km)	DC Resistance Unbalance Maximum %		Dielectric Strength DC Potential - Volts	
				Average	Individual Pair	Conductor to Conductor	Conductor to Shield
22 (0.64)	1.0 (1.6)	4.7 (15.4)	91 (56.5)	1.5	5.0	4,000	10,000
24 (0.51)	1.0 (1.6)	5.9 (19.4)	144 (89.5)	1.5	5.0	3,000	10,000

Minimum Near End Crosstalk (NEXT) @ 772 kHz		Minimum Far End Crosstalk (FEXT) @ 772 kHz	
PSWUNEXT Mean (dB)	47	Conductor Size (AWG)	22      24
PSWUNEXT Worst Pair (dB)	42	PSELFEXT Mean (dB/kft)	49      49
		PSELFEXT Worst Pair (dB/kft)	43      43

## PART NUMBERS AND PHYSICAL CHARACTERISTICS

Part Number	Product Code	Pair Count	AWG (mm)	Nominal Diameter		Approx. Weight lbs/kft (kg/km)	Standard Length ft (m)	Approx. Shipping Weight lbs (kg)	Steel Reel Size F x T x D in
				Cable only in (mm)	W/Messenger in (mm)				
20-062-43	BHAS	25	22 (0.64)	0.58 (15)	1.05 (27)	310 (461)	10,000 (3,048)	3,895 (1,766)	83 x 40 x 42
20-065-43	BHAS	50	22 (0.64)	0.74 (19)	1.20 (31)	445 (662)	7,500 (2,286)	4,135 (1,875)	83 x 40 x 42
20-069-43	BHAS	100	22 (0.64)	1.00 (25)	1.47 (37)	705 (1,049)	6,000 (1,829)	5,025 (2,279)	83 x 40 x 42
20-097-43	BKMS	25	24 (0.51)	0.49 (12)	0.96 (24)	260 (387)	13,300 (4,054)	4,255 (1,930)	83 x 40 x 42
20-100-43	BKMS	50	24 (0.51)	0.62 (16)	1.09 (28)	345 (513)	13,300 (4,054)	5,385 (2,442)	83 x 40 x 42
20-104-43	BKMS	100	24 (0.51)	0.80 (20)	1.27 (32)	515 (766)	8,000 (2,438)	4,915 (2,229)	83 x 40 x 42

# Reinforced Self-Support

BHAP, BKMP and BKTP

## PRODUCT DESCRIPTION

Reinforced Self-Support Cable is a solid insulated, double jacket, armored, self-supporting air core design intended for aerial installations where hazards from squirrel attack, tree limb abrasion or lightning exist. The undulated, shielded, jacketed core is covered with a flooded steel armor, laid parallel to a flooded steel support member and jacketed in an integral extrusion to form a "figure 8" configuration. The steel strand member is readily available for gripping, pulling and tensioning using standard methods and hardware.

## APPLICATIONS

- Aerial installations in harsh environments

## FEATURES

- Tightly controlled individual conductor dimensions
- Specially designed pair twist lays
- Undulated core assembly
- Core wrap
- Inner polyethylene jacket
- Flooded steel support member
- Polyethylene jacket

## BENEFITS

- Limits resistance unbalance of paired conductors
- Minimizes crosstalk and meets the capacitance unbalance requirements
- Eliminates strain on the conductors and provides sufficient slack during installation
- Protects the core and helps provide core-to-shield dielectric strength
- Provides additional protection against mechanic damage and prevents the ingress of moisture
- Provides corrosion protection
- Provides tough, flexible, protective covering that withstands exposure to sunlight, atmospheric temperatures and stresses



## SPECIFICATIONS

<b>Conductor</b>	Solid annealed copper
<b>Insulation</b>	Solid polyolefin in distinctive colors to facilitate pair identification
<b>≤ 25-Pair Core</b>	Pairs are combined into a cylindrical core
<b>&gt; 50-Pair Core</b>	Multiples of 25-pair groups are assembled to form the final cable core; each group is identified by color coded non-hygroscopic binders
<b>Core Wrap</b>	Non-hygroscopic dielectric material
<b>Shield</b>	Corrugated, 8 mil aluminum tape is applied longitudinally over the core wrap
<b>Inner Jacket</b>	Polyethylene helps protect the core and shield against mechanical damage and ingress of moisture
<b>Armor</b>	Corrugated bare 6 mil steel tape is applied longitudinally over the inner jacket and the inner and outer surfaces of the steel are flooded
<b>Support Member</b>	0.25 inch, 7-strand Extra High-Strength (EHS) galvanized steel member, fully flooded, serves as the support member and is an integral part of the sheath
<b>Outer Jacket</b>	Black polyethylene
<b>Jacket Marking</b>	Manufacturer's identification, pair count, AWG, product identification, sequential footage and a telephone handset printed at 2 foot intervals
<b>Standards Compliance</b>	Telcordia® GR-421-CORE Issue 2 RoHS-compliant

Telcordia is a registered trademark of Ericsson Inc.

## ELECTRICAL SPECIFICATIONS

Number of Pairs	Average Mutual Capacitance @ 1,000 Hz nF/mile (nF/km)	Capacitance Unbalance Pair to Pair @ 1 kHz		Capacitance Unbalance Pair to Ground @ 1 kHz	
		Maximum Individual pF @ 1 kft (pF @ 1 km)	Maximum RMS pF @ 1 kft (pF @ 1 km)	Maximum Individual pF @ 1 kft (pF @ 1 km)	Maximum Average pF @ 1 kft (pF @ 1 km)
Over 12	83 + 4, - 5 (52 ± 2, - 3)	80 (145)	25 (45)	800 (2,625)	175 (574)

Conductor Size AWG (mm)	Minimum Insulation Resistance @ 68°F (20°C) gigohm-mile (gigohm-km)	Maximum Average Attenuation 772 kHz @ 68°F (20°C) dB/kft (dB/km)	Maximum Conductor Resistance @ 68°F (20°C) Ohms/sheath mile (km)	DC Resistance Unbalance Maximum %		Dielectric Strength DC Potential - Volts	
				Average	Individual Pair	Conductor to Conductor	Conductor to Shield
22 (0.64)	1.0 (1.6)	4.7 (15.4)	91 (56.5)	1.5	5.0	4,000	10,000
24 (0.51)	1.0 (1.6)	5.9 (19.4)	144 (89.5)	1.5	5.0	3,000	10,000
26 (0.40)	1.0 (1.6)	7.4 (24.3)	232 (144.2)	1.5	5.0	2,400	10,000

Minimum Near End Crosstalk (NEXT) @ 772 kHz		Minimum Far End Crosstalk (FEXT) @ 772 kHz		
PSWUNEXT Mean (dB)	47	Conductor Size (AWG)	22	26
PSWUNEXT Worst Pair (dB)	42	PSELFEXT Mean (dB/kft)	49	47
		PSELFEXT Worst Pair (dB/kft)	43	43

## PART NUMBERS AND PHYSICAL CHARACTERISTICS

Part Number	Product Code	Pair Count	AWG (mm)	Nominal Diameter		Approx. Weight lbs/kft (kg/km)	Standard Length ft (m)	Approx. Shipping Weight lbs (kg)	Steel Reel Size F x T x D in
				Cable only in (mm)	W/Messenger in (mm)				
20-062-20	BHAP	25	22 (0.64)	0.87 (22)	1.33 (34)	455 (675)	10,000 (3,048)	4,200 (1,905)	83 x 40 x 42
20-065-20	BHAP	50	22 (0.64)	1.05 (27)	1.51 (38)	625 (930)	7,500 (2,286)	4,465 (2,025)	83 x 40 x 42
20-069-20	BHAP	100	22 (0.64)	1.30 (33)	1.76 (45)	940 (1,400)	5,000 (1,524)	4,475 (2,029)	83 x 40 x 42
20-097-20	BKMP	25	24 (0.51)	0.83 (21)	1.29 (33)	400 (595)	10,000 (3,048)	4,345 (1,971)	83 x 40 x 42
20-100-20	BKMP	50	24 (0.51)	0.94 (24)	1.40 (36)	510 (760)	10,000 (3,048)	5,445 (2,469)	83 x 40 x 42
20-104-20	BKMP	100	24 (0.51)	1.13 (29)	1.59 (40)	715 (1,065)	5,000 (1,524)	4,145 (1,880)	83 x 40 x 42
20-108-20	BKMP	200	24 (0.51)	1.42 (36)	1.88 (48)	1,120 (1,665)	4,000 (1,220)	4,995 (2,265)	83 x 40 x 42
20-145-20	BKTP	300	26 (0.40)	1.35 (34)	1.81 (46)	1,045 (1,555)	3,300 (1,010)	4,110 (1,864)	83 x 40 x 42

# Bonded STALPETH

DCAZ, DCMZ and DCTZ



## PRODUCT DESCRIPTION

Bonded STALPETH Cable is a foam skin insulated, single jacket, armored air core design intended for use in ducts to provide more efficient duct utilization than standard PIC designs.

## APPLICATIONS

- Congested underground duct systems

## FEATURES

- Tightly controlled individual conductor dimensions
- Specially designed pair twist lays
- Core wrap
- Aluminum tape shield
- Steel tape armor bonded to outer jacket
- Polyethylene jacket

## BENEFITS

- Limits resistance unbalance of paired conductors
- Minimizes crosstalk and meets the capacitance unbalance requirements
- Protects the core and helps provide core-to-shield dielectric strength
- Assures good electrical contact with non-piercing bonding clamps
- Protects the core from mechanical damage and reduces the possibility of tape buckling during installation, ingress of water to the aluminum shield and of water along the cable between the armor and outer jacket
- Provides a tough, flexible, protective covering that withstands exposure to sunlight, atmospheric temperatures, ground chemicals and stresses expected in standard installations

## SPECIFICATIONS

<b>Conductor</b>	Solid annealed copper
<b>Insulation</b>	Conductors are dual insulated with an inner layer of foamed, natural polyolefin covered by an outer layer of solid, colored polyolefin; conductor insulation is color coded in accordance with industry standard
<b>≥ 50-Pair Core</b>	Multiples of 25-pair groups are assembled to form the final cable core; each group is identified by color coded non-hygroscopic binders; for 1,200-pair and larger, the color code is Mirror Image design
<b>Core Wrap</b>	Non-hygroscopic dielectric material
<b>Shield</b>	Corrugated bare 8 mil aluminum tape applied longitudinally over the core wrap
<b>Armor</b>	Corrugated, copolymer coated, 6 mil steel tape applied over the aluminum shield and bonded to the outer jacket
<b>Jacket</b>	Black polyethylene
<b>Jacket Marking</b>	Manufacturer's identification, pair count, AWG, product identification and a telephone handset printed at 2 foot intervals; sequential footage markings are printed at alternate 2 foot intervals
<b>Standards Compliance</b>	Telcordia® GR-421-CORE Issue 2 RoHS-compliant

Telcordia is a registered trademark of Ericsson Inc.

## ELECTRICAL SPECIFICATIONS

Number of Pairs	Average Mutual Capacitance @ 1,000 Hz nF/mile (nF/km)	Capacitance Unbalance Pair to Pair @ 1 kHz		Capacitance Unbalance Pair to Ground @ 1 kHz	
		Maximum Individual pF @ 1 kft (pF @ 1 km)	Maximum RMS pF @ 1 kft (pF @ 1 km)	Maximum Individual pF @ 1 kft (pF @ 1 km)	Maximum Average pF @ 1 kft (pF @ 1 km)
All pairs	83 ± 4 (52 ± 2)	80 (145)	25 (45)	800 (2,625)	175 (574)

Conductor Size AWG (mm)	Minimum Insulation Resistance @ 68°F (20°C) gigohm-mile (gigohm-km)	Maximum Average Attenuation 772 kHz @ 68°F (20°C) dB/kft (dB/km)	Maximum Conductor Resistance @ 68°F (20°C) Ohms/sheath mile (km)	DC Resistance Unbalance Maximum %		Dielectric Strength DC Potential - Volts	
				Average	Individual Pair	Conductor to Conductor	Conductor to Shield
22 (0.64)	1.0 (1.6)	5.0 (16.4)	91 (56.5)	1.5	5.0	1,400	5,000
24 (0.51)	1.0 (1.6)	6.3 (20.7)	144 (89.5)	1.5	5.0	1,200	5,000
26 (0.40)	1.0 (1.6)	7.9 (25.9)	232 (144.2)	1.5	5.0	1,000	5,000

### Minimum Near End Crosstalk (NEXT) @ 772 kHz

PSWUNEXT Mean (dB)	47
PSWUNEXT Worst Pair (dB)	42

### Minimum Far End Crosstalk (FEXT) @ 772 kHz

Conductor Size (AWG)	22	24	26
PSELFEXT Mean (dB/kft)	49	49	47
PSELFEXT Worst Pair (dB/kft)	43	43	43



**PART NUMBERS AND PHYSICAL CHARACTERISTICS**

Part Number	Product Code	Pair Count	AWG (mm)	Nominal Diameter in (mm)	Approx. Weight lbs/kft (kg/km)	Standard Length ft (m)	Approx. Shipping Weight lbs (kg)	Steel Reel Size F x T x D in
19-083-01	DCAZ	900	22 (0.64)	2.49 (63)	4,375 (6,510)	1,600 (488)	7,795 (3,535)	83 x 40 x 42
19-085-01	DCAZ	1,200	22 (0.64)	2.85 (72)	5,770 (8,585)	1,200 (366)	7,720 (3,500)	83 x 40 x 42
19-116-01	DCMZ	600	24 (0.51)	1.70 (43)	1,960 (2,915)	3,900 (1,189)	8,440 (3,830)	83 x 40 x 42
19-118-01	DCMZ	900	24 (0.51)	2.02 (51)	2,860 (4,255)	1,500 (458)	8,275 (3,755)	83 x 40 x 42
19-120-01	DCMZ	1,200	24 (0.51)	2.30 (58)	3,755 (5,590)	2,000 (610)	8,305 (3,765)	83 x 40 x 42
19-121-01	DCMZ	1,500	24 (0.51)	2.57 (65)	4,660 (6,935)	1,600 (488)	8,250 (3,745)	83 x 40 x 42
19-124-01	DCMZ	1,800	24 (0.51)	2.81 (71)	5,545 (8,250)	1,250 (381)	7,725 (3,505)	83 x 40 x 42
19-125-01	DCMZ	2,100	24 (0.51)	3.04 (77)	6,440 (9,585)	1,150 (351)	8,200 (3,720)	83 x 40 x 42
19-126-01	DCMZ	2,400	24 (0.51)	3.22 (82)	7,320 (10,895)	876 (267)	7,205 (3,270)	83 x 40 x 42
19-151-01	DCTZ	600	26 (0.40)	1.38 (35)	1,285 (1,910)	5,700 (1,737)	8,120 (3,685)	83 x 40 x 42
19-153-01	DCTZ	900	26 (0.40)	1.62 (41)	1,850 (2,755)	3,900 (1,189)	8,010 (3,635)	83 x 40 x 42
19-155-01	DCTZ	1,200	26 (0.40)	1.84 (47)	2,420 (3,600)	3,200 (975)	8,540 (3,875)	83 x 40 x 42
19-156-01	DCTZ	1,500	26 (0.40)	2.08 (53)	2,995 (4,455)	2,500 (762)	8,285 (3,755)	83 x 40 x 42
19-157-01	DCTZ	1,800	26 (0.40)	2.26 (57)	3,560 (5,300)	2,080 (634)	8,200 (3,720)	83 x 40 x 42
19-158-01	DCTZ	2,100	26 (0.40)	2.41 (61)	4,115 (6,125)	1,250 (381)	5,940 (2,695)	83 x 40 x 42
19-159-01	DCTZ	2,400	26 (0.40)	2.58 (66)	4,685 (6,970)	1,600 (488)	8,290 (3,760)	83 x 40 x 42
19-161-01	DCTZ	2,700	26 (0.40)	2.71 (69)	5,240 (7,800)	1,250 (381)	7,345 (3,330)	83 x 40 x 42
19-162-01	DCTZ	3,000	26 (0.40)	2.86 (73)	5,800 (8,630)	1,200 (366)	7,755 (3,520)	83 x 40 x 42
19-164-01	DCTZ	3,600	26 (0.40)	3.03 (77)	6,885 (10,245)	1,150 (351)	8,715 (3,950)	83 x 40 x 42
19-167-01	DCTZ	4,200	26 (0.40)	3.26 (83)	7,995 (11,900)	900 (274)	7,990 (3,625)	83 x 40 x 42

# STEAMPETH

DKTN



## PRODUCT DESCRIPTION

STEAMPETH Cable is a solid insulated, single jacket, armored air core design intended for use in underground systems where a high incidence of damage could occur if steam enters the duct. The cable is designed for application in high temperature environments up to 230°F (110°C).

## APPLICATIONS

- Steam tunnels

## FEATURES

- Solid polypropylene insulation
- Tightly controlled individual conductor dimensions
- Specially designed pair twist lays
- Core wrap
- Aluminum tape shield
- Steel armor bonded to the outer jacket
- Polyethylene jacket

## BENEFITS

- Provides higher temperature rating
- Limits resistance unbalance of paired conductors
- Minimizes crosstalk and meets the capacitance unbalance requirements
- Protects core and helps provide core-to-shield dielectric strength
- Assures good electrical contact with non-piercing bonding clamps
- Protects the core from mechanical damage and reduces possibility of tape buckling during installation, ingress of water to the shield and seepage of water along the cable between the armor and outer jacket
- Provides a tough, flexible, protective covering that withstands exposure to sunlight, above-normal temperatures, ground chemicals and stresses expected during installation

## SPECIFICATIONS

<b>Conductor</b>	Solid annealed copper
<b>Insulation</b>	Solid polypropylene insulation; standard color codes are used for pair identification
<b>Core Assembly</b>	Multiples of 25-pair groups are assembled to form the final cable core; each group is identified by color coded non-hygroscopic binders; for 1,200-pair and larger, color coding is Mirror Image
<b>Core Wrap</b>	Non-hygroscopic dielectric material
<b>Shield</b>	Corrugated bare 8 mil aluminum tape applied longitudinally over the core wrap
<b>Armor</b>	Corrugated, copolymer coated, 6 mil steel tape applied over the aluminum shield and bonded to the outer jacket
<b>Jacket</b>	Black, medium density polyethylene
<b>Jacket Marking</b>	Manufacturer's identification, pair count, AWG, product identification, a telephone handset and sequential footage markings are printed at 2 foot intervals.
<b>Standards Compliance</b>	Telcordia® GR-110-CORE

Telcordia is a registered trademark of Ericsson Inc.

## ELECTRICAL SPECIFICATIONS

Number of Pairs	Average Mutual Capacitance @ 1,000 Hz nF/mile (nF/km)	Capacitance Unbalance Pair to Pair @ 1 kHz		Capacitance Unbalance Pair to Ground @ 1 kHz	
		Maximum Individual pF @ 1 kft (pF @ 1 km)	Maximum RMS pF @ 1 kft (pF @ 1 km)	Maximum Individual pF @ 1 kft (pF @ 1 km)	Maximum Average pF @ 1 kft (pF @ 1 km)
All pairs	83 ± 4 (52 ± 2)	80 (145)	25 (45)	800 (2,625)	175 (574)

Conductor Size AWG (mm)	Minimum Insulation Resistance @ 68°F (20°C) gigohm-mile (gigohm-km)	Maximum Average Attenuation 772 kHz @ 68°F (20°C) dB/kft (dB/km)	Maximum Conductor Resistance @ 68°F (20°C) Ohms/sheath mile (km)	DC Resistance Unbalance Maximum %		Dielectric Strength DC Potential - Volts	
				Average	Individual Pair	Conductor to Conductor	Conductor to Shield
26 (0.40)	1.0 (1.6)	7.4 (24.3)	232 (144.2)	1.5	5.0	2,400	10,000

	Minimum Near End Crosstalk (NEXT)	
	@ 150 kHz	@ 772 kHz
PSWUNEXT Mean (dB)	58	47
PSWUNEXT Worst Pair (dB)	53	42

	Minimum Far End Crosstalk	
	@ 150 kHz	@ 772 kHz
PSELFEXT Mean (dB/kft)	61	47
PSELFEXT Worst Pair (dB/kft)	57	43

## PART NUMBERS AND PHYSICAL CHARACTERISTICS

Part Number	Product Code	Pair Count	AWG (mm)	Nominal Diameter in (mm)	Approx. Weight lbs/kft (kg/km)	Standard Length ft (m)	Approx. Shipping Weight lbs (kg)	Steel Reel Size F x T x D in
27-145-19	DKTN	300	26 (0.40)	1.11 (28)	750 (1,115)	8,600 (2,621)	7,245 (3,285)	83 x 40 x 42
27-151-19	DKTN	600	26 (0.40)	1.51 (38)	1,395 (2,075)	4,800 (1,463)	7,490 (3,400)	83 x 40 x 42
27-153-19	DKTN	900	26 (0.40)	1.79 (46)	2,015 (3,000)	3,300 (1,006)	7,445 (3,375)	83 x 40 x 42
27-155-19	DKTN	1,200	26 (0.40)	2.04 (52)	2,635 (3,920)	2,120 (646)	6,380 (2,895)	83 x 40 x 42
27-157-19	DKTN	1,800	26 (0.40)	2.50 (64)	3,885 (5,780)	1,650 (503)	7,205 (3,270)	83 x 40 x 42
27-159-19	DKTN	2,400	26 (0.40)	2.87 (73)	5,110 (7,605)	1,250 (381)	7,185 (3,260)	83 x 40 x 42

# Power Station High Potential Filled ASP

CMAW

## PRODUCT DESCRIPTION

High Potential Filled ASP Cable with solid insulation is a single jacket, filled, armored design intended for applications associated with power substations. This cable provides exceptional durability and resistance to moisture. The finished cable meets all standard electrical requirements plus a 20 kV high voltage test between the conductors and the shield.

## APPLICATIONS

- Power sub stations

## FEATURES

- Tightly controlled individual conductor dimensions
- Specially designed pair twist lays
- Core wrap
- Inner and outer surfaces of both aluminum tape and steel tape are flooded with an adhesive compound
- Polyethylene jacket

## BENEFITS

- Limits resistance unbalance of paired conductors
- Minimizes crosstalk and meets the capacitance unbalance requirements
- Protects core and provides improved mechanical and electrical characteristics
- Provides a moisture barrier and inhibits corrosion
- Provides a tough, flexible, protective covering that withstands exposure to sunlight, above-normal temperatures, ground chemicals and stresses expected during installation



## SPECIFICATIONS

<b>Conductor</b>	Solid annealed copper
<b>Insulation</b>	Color coded solid high dielectric insulation; standard color codes are used for pair identification.
<b>25-Pair Core</b>	Pairs are combined into a cylindrical core
<b>≥ 50-Pair Core</b>	Multiples of 25-pair groups are assembled to form the final cable core; each group is identified by color-coded non-hygroscopic binders
<b>Filling Compound</b>	Entire core assembly is filled with 80°C ETPR compound, filling the air space between the insulated conductors
<b>Core Wrap</b>	Dielectric tape applied over the core
<b>Shields</b>	Corrugated bare 8 mil aluminum tape covered by a corrugated bare 6 mil steel tape applied longitudinally over the core wrap
<b>Jacket</b>	Black polyethylene
<b>Jacket Marking</b>	Manufacturer's ID, pair count, AWG, product ID and telephone handset printed every 2 foot; sequential footage marking printed at 2 foot intervals
<b>Standards Compliance</b>	Telcordia® GR-421-CORE Issue 2 RoHS-compliant

Telcordia is a registered trademark of Ericsson Inc.

## ELECTRICAL SPECIFICATIONS

Number of Pairs	Average Mutual Capacitance @ 1,000 Hz nF/mile (nF/km)	Capacitance Unbalance Pair to Pair @ 1 kHz		Capacitance Unbalance Pair to Ground @ 1 kHz	
		Maximum Individual pF @ 1 kft (pF @ 1 km)	Maximum RMS pF @ 1 kft (pF @ 1 km)	Maximum Individual pF @ 1 kft (pF @ 1 km)	Maximum Average pF @ 1 kft (pF @ 1 km)
All pairs	83 ± 4 (52 ± 2)	80 (145)	25 (45)	800 (2,625)	175 (574)

Conductor Size AWG (mm)	Minimum Insulation Resistance @ 68°F (20°C) gigohm-mile (gigohm-km)	Maximum Average Attenuation 772 kHz @ 68°F (20°C) dB/kft (dB/km)	Maximum Conductor Resistance @ 68°F (20°C) Ohms/sheath mile (km)	DC Resistance Unbalance Maximum %		Dielectric Strength DC Potential - Volts	
				Average	Individual Pair	Conductor to Conductor	Conductor to Shield
22 (0.64)	1.0 (1.6)	4.0 (13.1)	91 (56.5)	1.5	5.0	5,000	20,000

Minimum Near End Crosstalk (NEXT) @ 772 kHz	
PSWUNEXT Mean (dB)	47
PSWUNEXT Worst Pair (dB)	42

Minimum Far End Crosstalk (FEXT) @ 772 kHz	
PSELFEXT Mean (dB/kft)	49
PSELFEXT Worst Pair (dB/kft)	43

## PART NUMBERS AND PHYSICAL CHARACTERISTICS

Part Number	Pair Count	Nominal Diameter in (mm)	Approx. Weight lbs/kft (kg/km)	Standard Length ft (m)	Approx. Shipping Weight lbs (kg)	Steel Reel Size F x T x D in
21-062-48	25	0.71 (18)	285 (425)	10,000 (3,048)	3,645 (1,655)	83 x 40 x 42
21-065-48	50	0.93 (24)	495 (735)	10,000 (3,048)	5,745 (2,605)	83 x 40 x 42

# Filled ALPETH

ANBA, ANAA, ANMA and ANTA



## SPECIFICATIONS

<b>Conductor</b>	Solid annealed copper
<b>Insulation</b>	Conductors are dual insulated with an inner layer of foamed, natural polyolefin covered by an outer layer of solid, colored polyolefin; conductor insulation is color coded in accordance with industry standard
<b>25-Pair Core</b>	Pairs are combined into a cylindrical core
<b>≥ 50-Pair Core</b>	Multiples of 25-pair groups are assembled to form the final cable core; each group is identified by color coded non-hygroscopic binders; for 1,200-pair and larger, the color code is a Mirror Image design
<b>Filling Compound</b>	Entire core assembly is filled with an 80°C ETPR compound, filling the air space between the insulated conductors
<b>Core Wrap</b>	Dielectric tape applied over the core
<b>Shield</b>	Corrugated bare 8 mil aluminum tape is applied longitudinally over the core wrap; inner and outer surfaces of the aluminum shield are flooded
<b>Jacket</b>	Black, polyethylene
<b>Jacket Marking</b>	Manufacturer's identification, pair count, AWG, product identification, sequential footage and a telephone handset printed at 2 foot intervals
<b>Standards Compliance</b>	Telcordia® GR-421-CORE Issue 2 RoHS-compliant

Telcordia is a registered trademark of Ericsson Inc.

## PRODUCT DESCRIPTION

Filled ALPETH Cable with foam skin insulation is a single jacket, filled design intended for direct burial application. An ETPR compound completely coats each insulated conductor and fills the air space between conductors. The shielding and jacketing combined with the filling and flooding compounds throughout the cable provide exceptional durability and resistance to moisture.

## APPLICATIONS

- Direct burial and underground conduit

## FEATURES

- Tightly controlled individual conductor dimensions
- Specially designed pair twist lays
- Core wrap
- Polyethylene jacket

## BENEFITS

- Limits resistance unbalance of paired conductors
- Minimizes crosstalk and meets the capacitance unbalance requirements
- Protects core and provides improved mechanical and electrical characteristics
- Provides a tough, flexible, protective covering that withstands exposure to sunlight, atmospheric temperatures, ground chemicals and stresses expected in standard installation

## ELECTRICAL SPECIFICATIONS

Number of Pairs	Average Mutual Capacitance @ 1,000 Hz nF/mile (nF/km)	Capacitance Unbalance Pair to Pair @ 1 kHz		Capacitance Unbalance Pair to Ground @ 1 kHz	
		Maximum Individual pF @ 1 kft (pF @ 1 km)	Maximum RMS pF @ 1 kft (pF @ 1 km)	Maximum Individual pF @ 1 kft (pF @ 1 km)	Maximum Average pF @ 1 kft (pF @ 1 km)
Over 12	83 ± 4 (52 ± 2)	80 (145)	25 (45)	800 (2,625)	175 (574)

Conductor Size AWG (mm)	Minimum Insulation Resistance @ 68°F (20°C) gigohm-mile (gigohm-km)	Maximum Average Attenuation 772 kHz @ 68°F (20°C) dB/kft (dB/km)	Maximum Conductor Resistance @ 68°F (20°C) Ohms/sheath mile (km)	DC Resistance Unbalance Maximum %		Dielectric Strength DC Potential - Volts	
				Average	Individual Pair	Conductor to Conductor	Conductor to Shield
19 (0.90)	1.0 (1.6)	3.2 (10.5)	45 (28.0)	1.5	5.0	4,500	10,000
22 (0.64)	1.0 (1.6)	4.5 (14.8)	91 (56.5)	1.5	5.0	3,600	10,000
24 (0.51)	1.0 (1.6)	5.6 (18.4)	144 (89.5)	1.5	5.0	3,000	10,000
26 (0.40)	1.0 (1.6)	7.0 (23.0)	232 (144.2)	1.5	5.0	2,400	10,000

### Minimum Near End Crosstalk (NEXT) @ 772 kHz

PSWUNEXT Mean (dB)	47
PSWUNEXT Worst Pair (dB)	42

### Minimum Far End Crosstalk (FEXT) @ 772 kHz

Conductor Size (AWG)	19	22	24	26
PSELFEXT Mean (dB/kft)	51	49	49	47
PSELFEXT Worst Pair (dB/kft)	45	43	43	43

**PART NUMBERS AND PHYSICAL CHARACTERISTICS**

Part Number	Product Code	Pair Count	AWG (mm)	Nominal Diameter in (mm)	Approx. Weight lbs/kft (kg/km)	Standard Length ft (m)	Approx. Shipping Weight lbs (kg)	Steel Reel Size F x T x D in
09-031-77	ANBA	25	19 (0.90)	0.78 (20)	355 (530)	10,000 (3,048)	4,345 (1,970)	83 x 40 x 42
09-034-77	ANBA	50	19 (0.90)	1.03 (26)	655 (975)	5,000 (1,524)	4,070 (1,845)	83 x 40 x 42
09-038-77	ANBA	100	19 (0.90)	1.37 (35)	1,225 (1,825)	3,300 (1,006)	4,840 (2,195)	83 x 40 x 42
09-062-77	ANAA	25	22 (0.64)	0.60 (15)	200 (300)	15,000 (4,572)	3,795 (1,720)	83 x 40 x 42
09-065-77	ANAA	50	22 (0.64)	0.77 (20)	350 (520)	15,000 (4,572)	6,045 (2,740)	83 x 40 x 42
09-069-77	ANAA	100	22 (0.64)	1.02 (26)	645 (960)	7,500 (2,286)	5,635 (2,555)	83 x 40 x 42
09-073-77	ANAA	200	22 (0.64)	1.38 (35)	1,225 (1,825)	5,000 (1,524)	6,920 (3,140)	83 x 40 x 42
09-075-77	ANAA	300	22 (0.64)	1.65 (42)	1,800 (2,680)	3,300 (1,006)	6,735 (3,055)	83 x 40 x 42
09-077-77	ANAA	400	22 (0.64)	1.88 (48)	2,365 (3,520)	2,500 (762)	6,710 (3,045)	83 x 40 x 42
09-081-77	ANAA	600	22 (0.64)	2.28 (58)	3,500 (5,210)	1,650 (503)	6,570 (2,980)	83 x 40 x 42
09-083-77	ANAA	900	22 (0.64)	2.76 (70)	5,190 (7,725)	1,000 (305)	5,985 (2,715)	83 x 40 x 42
09-097-77	ANMA	25	24 (0.51)	0.52 (13)	140 (210)	20,000 (6,096)	3,595 (1,630)	83 x 40 x 42
09-100-77	ANMA	50	24 (0.51)	0.66 (17)	240 (355)	20,000 (6,096)	5,595 (2,540)	83 x 40 x 42
09-104-77	ANMA	100	24 (0.51)	0.85 (22)	430 (640)	10,000 (3,048)	5,095 (2,310)	83 x 40 x 42
09-108-77	ANMA	200	24 (0.51)	1.14 (29)	810 (1,205)	5,000 (1,524)	4,845 (2,200)	83 x 40 x 42
09-110-77	ANMA	300	24 (0.51)	1.37 (35)	1,180 (1,755)	5,000 (1,524)	6,695 (3,035)	83 x 40 x 42
09-112-77	ANMA	400	24 (0.51)	1.55 (39)	1,545 (2,300)	4,000 (1,219)	6,975 (3,165)	83 x 40 x 42
09-116-77	ANMA	600	24 (0.51)	1.88 (48)	2,285 (3,400)	2,500 (762)	6,510 (2,950)	83 x 40 x 42
09-118-77	ANMA	900	24 (0.51)	2.25 (57)	3,345 (4,980)	1,650 (503)	6,315 (2,865)	83 x 40 x 42
09-120-77	ANMA	1,200	24 (0.51)	2.58 (66)	4,430 (6,595)	1,250 (381)	6,335 (2,870)	83 x 40 x 42
09-121-77	ANMA	1,500	24 (0.51)	2.87 (73)	5,510 (8,200)	1,000 (305)	6,305 (2,860)	83 x 40 x 42
09-124-77	ANMA	1,800	24 (0.51)	3.13 (80)	6,590 (9,805)	840 (256)	6,330 (2,870)	83 x 40 x 42
09-125-77	ANMA	2,100	24 (0.51)	3.40 (86)	7,725 (11,495)	750 (229)	6,590 (2,990)	83 x 40 x 42
09-145-77	ANTA	300	26 (0.40)	1.09 (28)	755 (1,125)	6,000 (1,829)	5,325 (2,415)	83 x 40 x 42
09-147-77	ANTA	400	26 (0.40)	1.25 (32)	995 (1,480)	5,000 (1,524)	5,770 (2,615)	83 x 40 x 42
09-151-77	ANTA	600	26 (0.40)	1.49 (38)	1,450 (2,160)	3,300 (1,006)	5,580 (2,530)	83 x 40 x 42
09-153-77	ANTA	900	26 (0.40)	1.78 (45)	2,120 (3,155)	2,500 (762)	6,095 (2,765)	83 x 40 x 42
09-155-77	ANTA	1,200	26 (0.40)	2.03 (52)	2,790 (4,150)	2,000 (610)	6,375 (2,890)	83 x 40 x 42
09-156-77	ANTA	1,500	26 (0.40)	2.28 (58)	3,490 (5,195)	1,300 (396)	5,330 (2,420)	83 x 40 x 42
09-157-77	ANTA	1,800	26 (0.40)	2.49 (63)	4,165 (6,200)	1,250 (381)	6,000 (2,720)	83 x 40 x 42
09-158-77	ANTA	2,100	26 (0.40)	2.69 (68)	4,870 (7,250)	1,200 (366)	6,640 (3,010)	83 x 40 x 42
09-159-77	ANTA	2,400	26 (0.40)	2.86 (73)	5,535 (8,235)	1,000 (305)	6,330 (2,870)	83 x 40 x 42

# Filled ASP

ANBW, ANAW, ANMW and ANTW



## SPECIFICATIONS

<b>Conductor</b>	Solid annealed copper
<b>Insulation</b>	Conductors are dual insulated with an inner layer of foamed, natural polyolefin covered by an outer layer of solid, colored polyolefin; conductor insulation is color coded in accordance with industry standard
<b>25-Pair Core</b>	Pairs are combined into a cylindrical core
<b>≥ 50-Pair Core</b>	Multiples of 25-pair groups are assembled to form the final cable core; each group is identified by color coded non-hygroscopic binders; for 1,200-pair and larger, the color code is a Mirror Image design
<b>Filling Compound</b>	Core assembly is completely filled with an 80°C ETPR compound, filling the air space between the insulated conductors
<b>Core Wrap</b>	Dielectric tape applied over the core
<b>Shields</b>	Corrugated bare 8 mil aluminum tape covered by a corrugated bare 6 mil steel tape applied longitudinally over the core wrap
<b>Jacket</b>	Black, polyethylene
<b>Jacket Marking</b>	Manufacturer's identification, pair count, AWG, product identification, sequential footage and a telephone handset printed at 2 foot intervals
<b>Standards Compliance</b>	Telcordia® GR-421-CORE Issue 2 RoHS-compliant

Telcordia is a registered trademark of Ericsson Inc.

## PRODUCT DESCRIPTION

FILLED ASP Cable with foam skin insulation is a single jacket, armored, filled design intended for direct burial applications in high risk areas. An ETPR compound completely coats each insulated conductor and fills the air space between conductors. The shielding, armoring and jacketing combined with the filling and flooding compounds throughout the cable, provide exceptional durability and resistance to moisture.

## APPLICATIONS

- Direct burial

## FEATURES

- Tightly controlled individual conductor dimensions
- Specially designed pair twist lays
- Inner and outer surfaces of both aluminum tape and steel tape are flooded
- Core wrap
- Polyethylene jacket

## BENEFITS

- Limits resistance unbalance of paired conductors
- Minimizes crosstalk and meets the capacitance unbalance requirements
- Provides a barrier to moisture and inhibits corrosion
- Protects core and provides improved mechanical and electrical characteristics
- Provides a tough, flexible, protective covering that withstands exposure to sunlight, atmospheric temperatures, ground chemicals and stresses expected in standard installation

## ELECTRICAL SPECIFICATIONS

Number of Pairs	Average Mutual Capacitance @ 1,000 Hz nF/mile (nF/km)	Capacitance Unbalance Pair to Pair @ 1 kHz		Capacitance Unbalance Pair to Ground @ 1 kHz	
		Maximum Individual pF @ 1 kft (pF @ 1 km)	Maximum RMS pF @ 1 kft (pF @ 1 km)	Maximum Individual pF @ 1 kft (pF @ 1 km)	Maximum Average pF @ 1 kft (pF @ 1 km)
Over 12	83 ± 4 (52 ± 2)	80 (145)	25 (45)	800 (2,625)	175 (574)

Conductor Size AWG (mm)	Minimum Insulation Resistance @ 68°F (20°C) gigohm-mile (gigohm-km)	Maximum Average Attenuation 772 kHz @ 68°F (20°C) dB/kft (dB/km)	Maximum Conductor Resistance @ 68°F (20°C) Ohms/sheath mile (km)	DC Resistance Unbalance Maximum %		Dielectric Strength DC Potential - Volts	
				Average	Individual Pair	Conductor to Conductor	Conductor to Shield
19 (0.90)	1.0 (1.6)	3.2 (10.5)	45 (28.0)	1.5	5.0	4,500	10,000
22 (0.64)	1.0 (1.6)	4.5 (14.8)	91 (56.5)	1.5	5.0	3,600	10,000
24 (0.51)	1.0 (1.6)	5.6 (18.4)	144 (89.5)	1.5	5.0	3,000	10,000
26 (0.40)	1.0 (1.6)	7.0 (23.0)	232 (144.2)	1.5	5.0	2,400	10,000

### Minimum Near End Crosstalk (NEXT) @ 772 kHz

PSWUNEXT Mean (dB)	47
PSWUNEXT Worst Pair (dB)	42

### Minimum Far End Crosstalk (FEXT) @ 772 kHz

Conductor Size (AWG)	19	22	24	26
PSELFEXT Mean (dB/kft)	51	49	49	47
PSELFEXT Worst Pair (dB/kft)	45	43	43	43

**PART NUMBERS AND PHYSICAL CHARACTERISTICS**

Part Number	Product Code	Pair Count	AWG (mm)	Nominal Diameter in (mm)	Approx. Weight lbs/kft (kg/km)	Standard Length ft (m)	Approx. Shipping Weight lbs (kg)	Steel Reel Size F x T x D in
22-031-83	ANBW	25	19 (0.90)	0.81 (21)	410 (610)	10,000 (3,048)	4,895 (2,220)	83 x 40 x 42
22-034-83	ANBW	50	19 (0.90)	1.07 (27)	735 (1,095)	5,000 (1,524)	4,470 (2,030)	83 x 40 x 42
22-038-83	ANBW	100	19 (0.90)	1.41 (36)	1,340 (1,995)	5,000 (1,524)	7,495 (3,400)	83 x 40 x 42
22-042-83	ANBW	200	19 (0.90)	1.96 (50)	2,570 (3,825)	2,000 (610)	5,935 (2,690)	83 x 40 x 42
22-044-83	ANBW	300	19 (0.90)	2.35 (60)	3,740 (5,565)	1,650 (503)	6,965 (3,160)	83 x 40 x 42
22-062-83	ANAW	25	22 (0.64)	0.63 (16)	240 (355)	18,000 (5,486)	5,115 (2,320)	83 x 40 x 42
22-065-83	ANAW	50	22 (0.64)	0.80 (20)	405 (605)	15,000 (4,572)	6,870 (3,115)	83 x 40 x 42
22-069-83	ANAW	100	22 (0.64)	1.05 (27)	730 (1,085)	7,500 (2,286)	6,270 (2,845)	83 x 40 x 42
22-073-83	ANAW	200	22 (0.64)	1.42 (36)	1,340 (1,995)	5,000 (1,524)	7,495 (3,400)	83 x 40 x 42
22-075-83	ANAW	300	22 (0.64)	1.69 (43)	1,940 (2,885)	3,300 (1,006)	7,195 (3,265)	83 x 40 x 42
22-077-83	ANAW	400	22 (0.64)	1.92 (49)	2,530 (3,765)	2,500 (762)	7,120 (3,230)	83 x 40 x 42
22-081-83	ANAW	600	22 (0.64)	2.32 (59)	3,705 (5,515)	1,650 (503)	6,910 (3,135)	83 x 40 x 42
22-083-83	ANAW	900	22 (0.64)	2.81 (71)	5,445 (8,105)	1,100 (335)	6,785 (3,075)	83 x 40 x 42
22-085-83	ANAW	1,200	22 (0.64)	3.20 (81)	7,160 (10,655)	834 (254)	6,765 (3,070)	83 x 40 x 42
22-097-83	ANMW	25	24 (0.51)	0.55 (14)	175 (260)	20,000 (6,096)	4,295 (1,950)	83 x 40 x 42
22-100-83	ANMW	50	24 (0.51)	0.69 (18)	290 (430)	20,000 (6,096)	6,595 (2,990)	83 x 40 x 42
22-104-83	ANMW	100	24 (0.51)	0.88 (22)	500 (745)	13,300 (4,054)	7,445 (3,375)	83 x 40 x 42
22-108-83	ANMW	200	24 (0.51)	1.18 (30)	900 (1,340)	6,600 (2,012)	6,735 (3,055)	83 x 40 x 42
22-110-83	ANMW	300	24 (0.51)	1.41 (36)	1,295 (1,925)	5,000 (1,524)	7,270 (3,300)	83 x 40 x 42
22-112-83	ANMW	400	24 (0.51)	1.59 (40)	1,680 (2,500)	4,000 (1,219)	7,515 (3,410)	83 x 40 x 42
22-116-83	ANMW	600	24 (0.51)	1.92 (49)	2,445 (3,640)	2,500 (762)	6,910 (3,135)	83 x 40 x 42
22-118-83	ANMW	900	24 (0.51)	2.29 (58)	3,545 (5,275)	2,000 (610)	7,885 (3,575)	83 x 40 x 42
22-120-83	ANMW	1,200	24 (0.51)	2.63 (67)	4,670 (6,950)	1,250 (381)	6,635 (3,010)	83 x 40 x 42
22-121-83	ANMW	1,500	24 (0.51)	2.92 (74)	5,775 (8,595)	1,000 (305)	6,570 (2,980)	83 x 40 x 42
22-124-83	ANMW	1,800	24 (0.51)	3.18 (81)	6,880 (10,240)	950 (290)	7,330 (3,325)	83 x 40 x 42
22-125-83	ANMW	2,100	24 (0.51)	3.45 (88)	8,045 (11,975)	940 (287)	8,960 (4,065)	83 x 40 x 42
22-145-83	ANTW	300	26 (0.40)	1.13 (29)	840 (1,250)	6,000 (1,829)	5,835 (2,645)	83 x 40 x 42
22-147-83	ANTW	400	26 (0.40)	1.29 (33)	1,100 (1,635)	6,000 (1,829)	7,395 (3,355)	83 x 40 x 42
22-151-83	ANTW	600	26 (0.40)	1.53 (39)	1,580 (2,350)	4,000 (1,219)	7,115 (3,225)	83 x 40 x 42
22-153-83	ANTW	900	26 (0.40)	1.83 (47)	2,275 (3,385)	2,500 (762)	6,485 (2,940)	83 x 40 x 42
22-155-83	ANTW	1,200	26 (0.40)	2.07 (53)	2,965 (4,415)	2,000 (610)	6,725 (3,050)	83 x 40 x 42
22-156-83	ANTW	1,500	26 (0.40)	2.33 (59)	3,695 (5,500)	1,600 (488)	6,705 (3,040)	83 x 40 x 42
22-157-83	ANTW	1,800	26 (0.40)	2.54 (65)	4,400 (6,550)	1,250 (381)	6,295 (2,855)	83 x 40 x 42
22-158-83	ANTW	2,100	26 (0.40)	2.74 (70)	5,120 (7,620)	1,200 (366)	6,940 (3,150)	83 x 40 x 42
22-159-83	ANTW	2,400	26 (0.40)	2.91 (74)	5,805 (8,640)	1,000 (305)	6,600 (2,995)	83 x 40 x 42
22-161-83	ANTW	2,700	26 (0.40)	3.08 (78)	6,485 (9,650)	740 (226)	5,595 (2,535)	83 x 40 x 42
22-162-83	ANTW	3,000	26 (0.40)	3.24 (82)	7,185 (10,695)	750 (229)	6,185 (2,805)	83 x 40 x 42

Your Strategic Partner for **Communication** Product Needs



**10Gain® XP**  
**CAT 6A**  
*CMR/CMP*



**2 mm**  
**Microarray**  
**Breakout**  
*OFNP*



COMMUNICATION  
**PRODUCT**  
**HIGHLIGHTS**

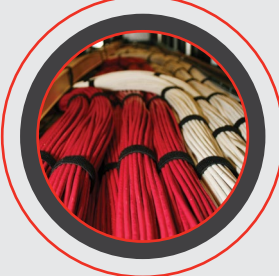

**FTTA Hybrid**  
**Assemblies**



**DAS Hybrid**  
*Fiber + Copper*



**MARKETS**

Commercial | Education | Government | Healthcare  
Industrial/Manufacturing | Technology | Transportation | Utility



800.551.8948

[SuperiorEssexCommunications.com](http://SuperiorEssexCommunications.com)

All information, content, data, specifications, packaging and part numbers detailed herein are subject to change. For the most up-to-date information, please visit [SuperiorEssexCommunications.com](http://SuperiorEssexCommunications.com). Purchase of this product is subject exclusively to the then current Superior Essex International LP Terms and Conditions of Sale for Communications Cable, Wire and Connectivity Products, which can be found on our website, [SuperiorEssexCommunications.com](http://SuperiorEssexCommunications.com), or provided to you upon request.



## PRODUCT DESCRIPTION

T-SCREEN® Filled ASP Cable with foam skin insulation is a single jacket, armored, filled design intended for direct burial applications in high risk areas. An ETPR compound completely coats each insulated conductor and fills the air space between conductors. An internal separator screen provides two core compartments for use in TIC PCM applications. The shielding, armor and jacketing combined with the filling and flooding compounds throughout the cable, provide exceptional durability and resistance to moisture.

## APPLICATIONS

- Bidirectional, T Carrier digital systems in direct buried installations

## FEATURES

- Core wrap
- Internal screen
- Flooded inner and outer surfaces of both tape shields
- Polyethylene jacket

## BENEFITS

- Protects core and provides improved mechanical and electrical characteristics
- Separates bidirectional conductors to transmit and receive T1 pairs
- Provides a moisture barrier and inhibits corrosion
- Provides a tough, flexible, protective covering that withstands exposure to sunlight, atmospheric temperatures, ground chemicals and stresses of standard installations



## SPECIFICATIONS

<b>Conductor</b>	Solid annealed copper
<b>Insulation</b>	Conductors are dual insulated with an inner layer of foamed, natural polyolefin covered by an outer coating of solid, colored polyolefin; conductor insulation is color coded in accordance with industry standard
<b>Core Assembly</b>	Twisted pairs assembled and equally placed on either side of the T-SCREEN, dividing the core into two electrically isolated compartments
<b>Core Wrap</b>	Dielectric tape applied over the core
<b>Screen</b>	Coated 4-mil aluminum tape to separate the cable into two halves
<b>Shields</b>	Corrugated bare 8-mil aluminum tape covered by a corrugated bare 6 mil steel tape applied longitudinally over the core wrap; inner and outer surfaces of the aluminum shield and steel tape are flooded
<b>Jacket</b>	Black polyethylene
<b>Jacket Marking</b>	Manufacturer's ID, pair count, AWG, product ID, sequential footage and a telephone handset printed at 2-foot intervals
<b>Standards Compliance</b>	Telcordia® GR-421-CORE Issue 2 RoHS-compliant

Telcordia is a registered trademark of Ericsson Inc.

## ELECTRICAL SPECIFICATIONS

Number of Pairs	Average Mutual Capacitance @ 1,000 Hz nF/mile (nF/km)	Capacitance Unbalance Pair to Pair @ 1 kHz		Capacitance Unbalance Pair to Ground @ 1 kHz	
		Maximum Individual pF @ 1 kft (pF @ 1 km)	Maximum RMS pF @ 1 kft (pF @ 1 km)	Maximum Individual pF @ 1 kft (pF @ 1 km)	Maximum Average pF @ 1 kft (pF @ 1 km)
All pairs	83 ± 4 (52 ± 2)	80 (145)	25 (45)	800 (2,625)	175 (574)

Conductor Size AWG (mm)	Minimum Insulation Resistance @ 68°F (20°C) gigohm-mile (gigohm-km)	Maximum Average Attenuation 772 kHz @ 68°F (20°C) dB/kft (dB/km)	Maximum Conductor Resistance @ 68°F (20°C) Ohms/sheath mile (km)	DC Resistance Unbalance Maximum %		Dielectric Strength DC Potential - Volts		
				Average	Individual Pair	Conductor to Conductor	Conductor to Shield	Conductor to Screen
22 (0.64)	1.0 (1.6)	4.5 (14.8)	91 (56.5)	1.5	5.0	3,600	10,000	5,000

	Minimum Near End Crosstalk (NEXT) @ 772 kHz		@ 1,600 kHz
	PSWUNEXT Mean (dB)	47	
PSWUNEXT Worst Pair (dB)	42	-	
PSNEXT Between Compartments (dB)	-	78	

	Minimum Far End Crosstalk (FEXT) @ 772 kHz	
	Conductor Size (AWG)	22
PSELFEXT Mean (dB/kft)	49	
PSELFEXT Worst Pair (dB/kft)	43	

## PART NUMBERS AND PHYSICAL CHARACTERISTICS

Part Number	Product Code	Pair Count	AWG (mm)	Nominal Diameter in (mm)	Approx. Weight lbs/kft (kg/km)	Standard Length ft (m)	Approx. Shipping Weight lbs (kg)	Steel Reel Size F x T x D in
24-417-83	KNAW	28	22 (0.64)	0.69 (18)	280 (415)	10,000 (3,048)	3,595 (1,630)	83 x 40 x 42
24-440-83	KNAW	54	22 (0.64)	0.95 (24)	510 (760)	10,000 (3,048)	5,895 (2,675)	83 x 40 x 42
24-456-83	KNAW	106	22 (0.64)	1.10 (28)	785 (1,170)	7,500 (2,286)	6,685 (3,030)	83 x 40 x 42
24-440-05	KHAH (T-SCREEN Air Core Design)	54	22 (0.64)	0.98 (25)	475 (705)	7,500 (2,286)	4,360 (1,975)	83 x 40 x 42
24-456-05	KHAH (T-SCREEN Air Core Design)	106	22 (0.64)	1.20 (31)	780 (1,160)	5,000 (1,524)	4,695 (2,130)	83 x 40 x 42
24-493-05	KHAH (T-SCREEN Air Core Design)	210	22 (0.64)	1.60 (41)	1,395 (2,075)	3,300 (1,006)	5,400 (2,450)	83 x 40 x 42
24-564-05	KHAH (T-SCREEN Air Core Design)	418	22 (0.64)	2.12 (54)	2,550 (3,795)	2,000 (610)	5,895 (2,675)	83 x 40 x 42

# CELFIL

BJBB, BJAB, BJMB and BJTB



## SPECIFICATIONS

<b>Conductor</b>	Solid annealed copper
<b>Insulation</b>	Dual-extruded cellular inner layer and color coded solid polyolefin skin
<b>Twisted Pairs</b>	Insulated conductors twisted to form pairs with varying lays
<b>≤ 25-Pair Core</b>	Assembled in concentric layers to form a cylindrical core
<b>≥ 50-Pair Core</b>	Assembled from concentrically formed units with 25-pair per unit; these may be stranded into 50-pair or 100-pair groups, which are then cabled to form the complete cylindrical core assembly
<b>≥ 1,200-Pair Core</b>	Color code is Mirror Image design
<b>Filling Compound</b>	PEPJ compound applied to cable core which completely coats each insulated conductor and fills interstices between pairs and units
<b>Core</b>	Non-hygroscopic core wrap applied over assembled core
<b>Flooding Compound</b>	Applied to fill all voids under shield
<b>Shield</b>	Electrically continuous 8 mil flat aluminum shielding tape, with polyolefin film fused and chemically bonded to both sides, applied longitudinally over the core and bonded to the outer jacket
<b>Rip cord</b>	Placed parallel to core
<b>Jacket</b>	Black, medium-density polyethylene
<b>Jacket Marking</b>	Manufacturer's identification, date of jacketing, gauge, pair count, sequential length and cable type marked at 1 meter intervals
<b>Standards Compliance</b>	RoHS-compliant

## PRODUCT DESCRIPTION

Superior Essex CELFIL Cable with foam skin insulation is a single jacketed design for use in duct or direct burial installations.

## FEATURES

- Twisted pairs with varying lays
- Non-hygroscopic core wrap applied over assembled core
- Rip cord placed parallel to core
- Black, medium-density polyethylene jacket

## BENEFITS

- Minimizes crosstalk and meets capacitance unbalance limitations
- Furnishes mechanical as well as high dielectric protection between shielding and individual conductors
- Facilitates easy jacket removal
- Provides a tough, flexible protective covering that withstands exposure to sunlight, atmospheric temperatures, ground chemicals and stresses expected in standard installations

## ELECTRICAL SPECIFICATIONS

Number of Pairs	Average Mutual Capacitance @ 1,000 Hz nF/mile (nF/km)	Capacitance Unbalance Pair to Pair @ 1 kHz		Capacitance Unbalance Pair to Ground @ 1 kHz	
		Maximum Individual pF @ 1 kft (pF @ 1 km)	Maximum RMS pF @ 1 kft (pF @ 1 km)	Maximum Individual pF @ 1 kft (pF @ 1 km)	Maximum Average pF @ 1 kft (pF @ 1 km)
12 or less	83 ± 7 (52 ± 4)	80 (145)	-	800 (2,625)	-
Over 12	83 ± 4 (52 ± 2)	80 (145)	25 (45)	800 (2,625)	175 (574)

Conductor Size AWG (mm)	Minimum Insulation Resistance 68°F (20°C) gigohm-mile (gigohm-km)	Maximum Average Attenuation 772 kHz @ 68°F (20°C) dB/kft (dB/km)	Maximum Conductor Resistance @ 68°F (20°C) Ohms/sheath kft (km)	DC Resistance Unbalance Maximum %		Dielectric Strength DC Potential - Volts Minimum	
				Average	Individual Pair	Conductor to Conductor	Conductor to Shield
19 (0.90)	1.0 (1.6)	3.2 (10.5)	8.5 (28.0)	1.5	5.0	4,500	10,000
22 (0.64)	1.0 (1.6)	4.5 (14.8)	17.3 (56.6)	1.5	5.0	3,600	10,000
24 (0.51)	1.0 (1.6)	5.6 (18.4)	26.1 (85.5)	1.5	5.0	3,000	10,000
26 (0.40)	1.0 (1.6)	7.0 (23.0)	44.0 (144.2)	1.5	5.0	2,400	10,000

	Minimum Near End Crosstalk (NEXT) dB/kft (dB/km)	
	@ 150 kHz	@ 772 kHz
PSWUNEXT Mean	58 (190)	47 (154)
PSWUNEXT Worst Pair	53 (174)	42 (138)

Conductor Size AWG (mm)	Minimum Far End Crosstalk dB/kft (dB/km)			
	PSELFEXT @ 150 kHz		PSELFEXT @ 772 kHz	
	Mean	Worst Pair	Mean	Worst Pair
19 (0.90)	65 (213)	59 (194)	51 (167)	45 (148)
22 (0.64)	63 (207)	57 (187)	49 (161)	43 (141)
24 (0.51)	63 (207)	57 (187)	49 (161)	43 (141)
26 (0.40)	61 (200)	57 (187)	47 (154)	43 (141)

**PART NUMBERS AND PHYSICAL CHARACTERISTICS**

Part Number	Product Code	Pair Count	AWG (mm)	Nominal Diameter in (mm)	Approx. Weight lbs/kft (kg/km)	Standard Length ft (m)	Approx. Shipping Weight lbs (kg)	Reel Size F x T x D in
85-026-13	BJBB	6	19 (0.90)	0.49 (12)	120 (180)	4,593 (1,400)	660 (300)	44 x 18 x 20
85-028-13	BJBB	12	19 (0.90)	0.58 (15)	190 (285)	4,593 (1,400)	1,040 (470)	46 x 25 x 20
85-031-13	BJBB	25	19 (0.90)	0.77 (20)	355 (530)	7,924 (2,415)	3,100 (1,410)	62 x 30 x 24
85-034-13	BJBB	50	19 (0.90)	1.03 (26)	655 (975)	4,593 (1,400)	3,295(1,500)	62 x 30 x 24
85-038-13	BJBB	100	19 (0.90)	1.37 (35)	1,225 (1,825)	3,002 (915)	3,965 (1,800)	62 x 30 x 24
85-042-13	BJBB	200	19 (0.90)	1.92 (49)	2,420 (3,600)	1,558 (475)	4,385 (1,990)	72 x 35 x 36
85-057-13	BJAB	6	22 (0.64)	0.38 (9.7)	70 (105)	9,186 (2,800)	750 (340)	44 x 18 x 20
85-059-13	BJAB	12	22 (0.64)	0.47 (12)	115 (170)	9,186 (2,800)	1,220 (555)	46 x 25 x 20
85-062-13	BJAB	25	22 (0.64)	0.60 (15)	200 (300)	9,186 (2,800)	2,080 (945)	58 x 25 x 20
85-065-13	BJAB	50	22 (0.64)	0.76 (19)	350 (520)	6,004 (1,830)	2,345 (1,065)	58 x 25 x 20
85-069-13	BJAB	100	22 (0.64)	1.02 (26)	650 (965)	4,593 (1,400)	3,275 (1,485)	62 x 30 x 24
85-073-13	BJAB	200	22 (0.64)	1.37 (35)	1,225 (1,825)	2,608 (795)	3,565 (1,615)	65 x 30 x 32
85-075-13	BJAB	300	22 (0.64)	1.66 (42)	1,815 (2,700)	2,182 (665)	4,575 (2,075)	72 x 35 x 36
85-077-13	BJAB	400	22 (0.64)	1.88 (48)	2,375 (3,535)	1,952 (595)	5,335 (2,420)	78 x 40 x 39
85-081-13	BJAB	600	22 (0.64)	2.29 (58)	3,545 (5,275)	1,542 (470)	6,165 (2,795)	78 x 40 x 39
85-083-13	BJAB	900	22 (0.64)	2.75 (70)	5,225 (7,775)	854 (260)	5,075 (2,305)	72 x 35 x 36
85-092-13	BJMB	6	24 (0.51)	0.35 (8.9)	60 (90)	4,593 (1,400)	320 (145)	30 x 18 x 12
85-094-13	BJMB	12	24 (0.51)	0.41 (10)	85 (125)	4,593 (1,400)	455 (205)	36 x 18 x 14
85-097-13	BJMB	25	24 (0.51)	0.52 (13)	140 (210)	4,593 (1,400)	750 (340)	44 x 18 x 20
85-100-13	BJMB	50	24 (0.51)	0.65 (17)	240 (355)	8,792 (2,680)	2,355 (1,070)	58 x 25 x 20
85-104-13	BJMB	100	24 (0.51)	0.84 (21)	430 (640)	6,578 (2,005)	3,115 (1,415)	62 x 30 x 24
85-108-13	BJMB	200	24 (0.51)	1.14 (29)	810 (1,205)	5,232 (1,595)	4,850 (2,205)	72 x 35 x 36
85-110-13	BJMB	300	24 (0.51)	1.36 (35)	1,180 (1,755)	3,724 (1,135)	5,010 (2,270)	72 x 35 x 36
85-112-13	BJMB	400	24 (0.51)	1.55 (39)	1,555 (2,315)	2,888 (880)	5,105 (2,320)	72 x 35 x 36
85-116-13	BJMB	600	24 (0.51)	1.88 (48)	2,305 (3,430)	1,838 (560)	4,850 (2,205)	72 x 35 x 36
85-118-13	BJMB	900	24 (0.51)	2.26 (57)	3,385 (5,040)	1,280 (390)	4,945 (2,250)	72 x 35 x 36
85-120-13	BJMB	1,200	24 (0.51)	2.57 (65)	4,450 (6,625)	1,280 (390)	6,395 (2,905)	78 x 40 x 39
85-121-13	BJMB	1,500	24 (0.51)	2.85 (72)	5,515 (8,210)	1,050 (320)	6,490 (2,950)	78 x 40 x 39
85-124-13	BJMB	1,800	24 (0.51)	3.11 (79)	6,575 (9,785)	688 (210)	5,225 (2,370)	78 x 40 x 39
85-145-13	BJTB	300	26 (0.40)	1.09 (28)	755 (1,125)	2,624 (800)	2,225 (1,010)	58 x 25 x 20
85-147-13	BJTB	400	26 (0.40)	1.25 (32)	995 (1,480)	2,624 (800)	2,855 (1,295)	58 x 25 x 20
85-151-13	BJTB	600	26 (0.40)	1.50 (38)	1,465 (2,180)	1,738 (530)	2,835 (1,285)	62 x 30 x 24
85-153-13	BJTB	900	26 (0.40)	1.79 (46)	2,145 (3,190)	1,722 (525)	3,980 (1,805)	62 x 30 x 24
85-155-13	BJTB	1,200	26 (0.40)	2.03 (52)	2,805 (4,175)	1,264 (385)	4,160 (1,885)	72 x 35 x 36
85-156-13	BJTB	1,500	26 (0.40)	2.29 (58)	3,515 (5,230)	1,246 (380)	4,995 (2,265)	72 x 35 x 36
85-157-13	BJTB	1,800	26 (0.40)	2.50 (64)	4,200 (6,250)	1,214 (370)	5,800 (2,630)	78 x 40 x 39
85-158-13	BJTB	2,100	26 (0.40)	2.69 (68)	4,885 (7,270)	1,182 (360)	6,475 (2,935)	78 x 40 x 39

# Canadian ALPETH

BHBB, BHAB, BKMB and BKTB



## SPECIFICATIONS

Conductor	Solid annealed copper
Insulation	Color coded solid polyolefin
Twisted Pairs	Insulated conductors twisted to pairs with varying lays
≤ 25-Pair Core	Assembled in concentric layers to form a cylindrical core
≥ 50-Pair Core	Assembled from concentrically formed units with 25-pair per unit; these may be stranded into 50-pair or 100-pair groups, which are then cabled to form the complete cylindrical core assembly
≥ 1,200-Pair Core	Color code is Mirror Image design
Core Covering	Non-hygroscopic core wrap applied over assembled core
Shield	Electrically continuous 8 mil flat aluminum shielding tape with polyolefin film fused and chemically bonded to both sides; applied longitudinally over the core and bonded to the outer jacket
Jacket	Black, medium-density polyethylene
Jacket Marking	Manufacturer's identification, date of jacketing, gauge, pair count, sequential length and cable type marked at 1 meter intervals
Standards Compliance	RoHS-compliant

## PRODUCT DESCRIPTION

Superior Essex ALPETH Cables are designed primarily for aerial use. In this application, the cable must be attached to a support strand (messenger). If the cable is to be placed in a duct, the cable must be pressurized.

## FEATURES

- Twisted pairs with varying lays
- Non-hygroscopic core wrap applied over assembled core
- Black, medium-density polyethylene jacket

## BENEFITS

- Minimizes crosstalk and meets capacitance unbalance limitations
- Furnishes mechanical as well as high dielectric protection between shielding and individual conductors
- Provides a tough, flexible protective covering that withstands exposure to sunlight, atmospheric temperatures, ground chemicals and stresses expected in standard installations

## ELECTRICAL SPECIFICATIONS

Number of Pairs	Average Mutual Capacitance @ 1,000 Hz nF/mile (nF/km)	Capacitance Unbalance Pair to Pair @ 1 kHz		Capacitance Unbalance Pair to Ground @ 1 kHz	
		Maximum Individual pF @ 1 kft (pF @ 1 km)	Maximum RMS pF @ 1 kft (pF @ 1 km)	Maximum Individual pF @ 1 kft (pF @ 1 km)	Maximum Average pF @ 1 kft (pF @ 1 km)
12 or less	83 ± 7 (52 ± 4)	80 (145)	-	800 (2,625)	-
Over 12	83 ± 4 (52 ± 2)	80 (145)	25 (45)	800 (2,625)	175 (574)

Conductor Size AWG (mm)	Minimum Insulation Resistance @ 68°F (20°C) gigohm-mile (gigohm-km)	Maximum Average Attenuation 772 kHz @ 68°F (20°C) dB/kft (dB/km)	Maximum Conductor Resistance @ 68°F (20°C) Ohms/sheath kft (km)	DC Resistance Unbalance Maximum %		Dielectric Strength DC Potential - Volts Minimum	
				Average	Individual Pair	Conductor to Conductor	Conductor to Shield
19 (0.90)	1.0 (1.6)	3.3 (10.8)	8.5 (28.0)	1.5	5.0	5,000	10,000
22 (0.64)	1.0 (1.6)	4.7 (15.4)	17.3 (56.6)	1.5	5.0	4,000	10,000
24 (0.51)	1.0 (1.6)	5.9 (19.4)	26.1 (85.5)	1.5	5.0	3,000	10,000
26 (0.40)	1.0 (1.6)	7.4 (24.3)	44.0 (144.2)	1.5	5.0	2,400	10,000

### Minimum Near End Crosstalk (NEXT) dB/kft (dB/km)

	@ 150 kHz		@ 772 kHz	
	Mean	Worst Pair	Mean	Worst Pair
PSWUNEXT Mean	58 (190)		47 (154)	
PSWUNEXT Worst Pair	53 (174)		42 (138)	

### Minimum Far End Crosstalk dB/kft (dB/km)

Conductor Size AWG (mm)	PSELFEXT @ 150 kHz		PSELFEXT @ 772 kHz	
	Mean	Worst Pair	Mean	Worst Pair
19 (0.90)	65 (213)	59 (194)	51 (167)	45 (148)
22 (0.64)	63 (207)	57 (187)	49 (161)	43 (141)
24 (0.51)	63 (207)	57 (187)	49 (161)	43 (141)
26 (0.40)	61 (200)	57 (187)	47 (154)	43 (141)

**PART NUMBERS AND PHYSICAL CHARACTERISTICS**

Part Number	Product Code	Pair Count	AWG (mm)	Nominal Diameter in (mm)	Approx. Weight lbs/kft (kg/km)	Standard Length ft (m)	Approx. Shipping Weight lbs (kg)	Reel Size F x T x D in
85-031-01	BHBB	25	19 (0.90)	0.74 (19)	310 (460)	4,593 (1,400)	1,625 (740)	52 x 25 x 20
85-034-01	BHBB	50	19 (0.90)	0.98 (25)	565 (840)	4,593 (1,400)	2,965 (1,345)	65 x 30 x 32
85-038-01	BHBB	100	19 (0.90)	1.31 (33)	1,060 (1,580)	3,002 (915)	3,470 (1,575)	62 x 30 x 24
85-042-01	BHBB	200	19 (0.90)	1.84 (47)	2,075 (3,090)	1,492 (455)	3,385 (1,535)	62 x 30 x 24
85-062-01	BHAB	25	22 (0.64)	0.59 (15)	180 (270)	5,724 (1,745)	1,195 (540)	46 x 25 x 20
85-065-01	BHAB	50	22 (0.64)	0.75 (19)	310 (460)	5,724 (1,745)	2,020 (915)	58 x 25 x 20
85-069-01	BHAB	100	22 (0.64)	1.00 (25)	570 (850)	4,593 (1,400)	2,905 (1,320)	62 x 30 x 24
85-073-01	BHAB	200	22 (0.64)	1.35 (34)	1,080 (1,605)	3,412 (1,040)	4,300 (1,950)	72 x 35 x 36
85-075-01	BHAB	300	22 (0.64)	1.64 (42)	1,595 (2,375)	2,182 (665)	4,095 (1,855)	72 x 35 x 36
85-077-01	BHAB	400	22 (0.64)	1.86 (47)	2,105 (3,135)	2,132 (650)	5,100 (2,315)	72 x 35 x 36
85-081-01	BHAB	600	22 (0.64)	2.27 (58)	3,135 (4,665)	1,410 (430)	5,035 (2,285)	72 x 35 x 36
85-097-01	BKMB	25	24 (0.51)	0.50 (13)	125 (185)	4,593 (1,400)	680 (310)	44 x 18 x 20
85-100-01	BKMB	50	24 (0.51)	0.63 (16)	215 (320)	4,593 (1,400)	1,155 (525)	46 x 25 x 20
85-104-01	BKMB	100	24 (0.51)	0.81 (21)	380 (565)	4,593 (1,400)	1,950 (885)	52 x 25 x 20
85-108-01	BKMB	200	24 (0.51)	1.09 (28)	705 (1,050)	4,593 (1,400)	3,605 (1,635)	65 x 30 x 32
85-110-01	BKMB	300	24 (0.51)	1.30 (33)	1,025 (1,525)	1,838 (560)	2,085 (945)	52 x 25 x 20
85-112-01	BKMB	400	24 (0.51)	1.50 (38)	1,355 (2,015)	1,492 (455)	2,265 (1,030)	58 x 25 x 20
85-116-01	BKMB	600	24 (0.51)	1.81 (46)	2,010 (2,990)	1,264 (385)	2,830 (1,285)	62 x 30 x 24
85-118-01	BKMB	900	24 (0.51)	2.17 (55)	2,970 (4,420)	1,182 (360)	4,125 (1,870)	72 x 35 x 36
85-120-01	BKMB	1,200	24 (0.51)	2.49 (63)	3,915 (5,825)	952 (290)	4,340 (1,970)	72 x 35 x 36
85-147-01	BKTB	400	26 (0.40)	1.21 (31)	870 (1,295)	2,624 (800)	2,530 (1,145)	58 x 25 x 20
85-151-01	BKTB	600	26 (0.40)	1.45 (37)	1,290 (1,920)	2,394 (730)	3,455 (1,570)	65 x 30 x 32
85-153-01	BKTB	900	26 (0.40)	1.74 (44)	1,900 (2,830)	1,526 (465)	3,270 (1,485)	65 x 30 x 32
85-157-01	BKTB	1,800	26 (0.40)	2.43 (62)	3,705 (5,515)	1,312 (400)	5,560 (2,520)	78 x 40 x 39

# SEALPAP

BHBF, BHAf, BKMF and BKTF



## SPECIFICATIONS

<b>Conductor</b>	Solid annealed copper
<b>Insulation</b>	Conductors are insulated with solid polyolefin in distinctive colors to facilitate pair identification
<b>Twisted Pairs</b>	Insulated conductors twisted to pairs with varying lays
<b>≤ 25-Pair Core</b>	Pairs are combined into a cylindrical core
<b>≥ 50-Pair Core</b>	Multiples of 25-pair groups are assembled to form the final cable core; each group is identified by color coded non-hygroscopic binders
<b>≥ 1,200-Pair Core</b>	Color code is Mirror Image design
<b>Core Wrap</b>	Non-hygroscopic dielectric material
<b>Inner Jacket</b>	Polyethylene
<b>Rip cords</b>	Placed between the core wrap and the inner jacket and between the inner jacket and shield
<b>Shield</b>	Electrically continuous 8 mil flat aluminum shielding tape, with polyolefin film fused and chemically bonded to both sides, applied longitudinally over the core and bonded to the outer jacket
<b>Outer Jacket</b>	Black, medium-density polyethylene
<b>Jacket Marking</b>	Manufacturer's identification, plant location, date of jacketing, pair count, AWG, product identification, sequential length markings in meters and telephone handset
<b>Standards Compliance</b>	Telcordia® GR-421-CORE ANSI/ICEA S-85-625-2011 RoHS-compliant

Telcordia is a registered trademark of Ericsson Inc.

## PRODUCT DESCRIPTION

Double jacketed air core cable, commonly called "SEALPAP," is a solid-insulated design intended for use in Outside Plant (OSP) where a greater risk of physical damage exists. The inner jacket provides protection to the cable core in the event of severe damage to the outer protective sheath.

## FEATURES

- Twisted pairs with varying lays
- Core wrap
- Inner jacket
- Outer jacket bonded to shield

## BENEFITS

- Minimizes crosstalk and meets capacitance unbalance limitations
- Protects core and helps provide core-to-shield dielectric strength
- Provides protection against mechanical damage and helps prevent the ingress of moisture
- Provides a tough, flexible protective covering that withstands exposure to sunlight, atmospheric temperatures, and stresses expected in standard installations
- Bonding provides additional moisture resistance

## ELECTRICAL SPECIFICATIONS

Number of Pairs	Average Mutual Capacitance @ 1,000 Hz nF/mile (nF/km)	Capacitance Unbalance Pair to Pair @ 1 kHz		Capacitance Unbalance Pair to Ground @ 1 kHz	
		Maximum Individual pF @ 1 kft (pF @ 1 km)	Maximum RMS pF @ 1 kft (pF @ 1 km)	Maximum Individual pF @ 1 kft (pF @ 1 km)	Maximum Average pF @ 1 kft (pF @ 1 km)
12 or less	83 ± 4 (52 ± 2)	80 (145)	-	800 (2,625)	-
Over 12	83 ± 4 (52 ± 2)	80 (145)	25 (45)	800 (2,625)	175 (574)

Conductor Size AWG (mm)	Minimum Insulation Resistance @ 68°F (20°C) gigohm-mile (gigohm-km)	Maximum Average Attenuation 772 kHz @ 68°F (20°C) dB/kft (dB/km)	Maximum Conductor Resistance @ 68°F (20°C) Ohms/sheath kft (km)	DC Resistance Unbalance Maximum %		Dielectric Strength DC Potential - Volts Minimum	
				Average	Individual Pair	Conductor to Conductor	Conductor to Shield
19 (0.90)	1.0 (1.6)	3.3 (10.8)	45 (28.0)	1.5	5.0	5,000	20,000
22 (0.64)	1.0 (1.6)	4.7 (15.4)	91 (56.6)	1.5	5.0	4,000	20,000
24 (0.51)	1.0 (1.6)	5.9 (19.4)	144 (89.5)	1.5	5.0	3,000	20,000
26 (0.40)	1.0 (1.6)	7.4 (24.3)	232 (144.2)	1.5	5.0	2,400	20,000

	Minimum Near End Crosstalk (NEXT) dB/kft (dB/km)	
	@ 150 kHz	@ 772 kHz
PSWUNEXT Mean	58 (190)	47 (154)
PSWUNEXT Worst Pair	53 (174)	42 (138)

Conductor Size AWG (mm)	Minimum Far End Crosstalk dB/kft (dB/km)			
	PSELFEXT @ 150 kHz		PSELFEXT @ 772 kHz	
	Mean	Worst Pair	Mean	Worst Pair
19 (0.90)	65 (213)	59 (194)	51 (167)	45 (148)
22 (0.64)	63 (207)	57 (187)	49 (161)	43 (141)
24 (0.51)	63 (207)	57 (187)	49 (161)	43 (141)
26 (0.40)	61 (200)	57 (187)	47 (154)	43 (141)

## PART NUMBERS AND PHYSICAL CHARACTERISTICS

Part Number	Product Code	Pair Count	AWG (mm)	Nominal Diameter in (mm)	Approx. Weight lbs/kft (kg/km)	Standard Length ft (m)	Approx. Shipping Weight lbs (kg)	Steel Reel Size F x T x D in
85-031-41	BHBF	25	19 (0.90)	0.84 (21)	355 (530)	9,006 (2,745)	3,990 (1,810)	83 x 40 x 42
85-034-41	BHBF	50	19 (0.90)	1.07 (27)	625 (930)	4,512 (1,375)	3,615 (1,640)	83 x 40 x 42
85-038-41	BHBF	100	19 (0.90)	1.43 (36)	1,170 (1,740)	2,986 (910)	4,290 (1,945)	83 x 40 x 42
85-042-41	BHBF	200	19 (0.90)	1.96 (50)	2,230 (3,320)	2,230 (680)	5,770 (2,615)	83 x 40 x 42
85-062-41	BHAF	25	22 (0.64)	0.68 (17)	215 (320)	5,724 (1,745)	2,025 (920)	83 x 40 x 42
85-065-41	BHAF	50	22 (0.64)	0.85 (22)	360 (535)	5,724 (1,745)	2,855 (1,295)	83 x 40 x 42
85-069-41	BHAF	100	22 (0.64)	1.09 (28)	635 (945)	4,282 (1,305)	3,515 (1,595)	83 x 40 x 42
85-073-41	BHAF	200	22 (0.64)	1.47 (37)	1,190 (1,770)	3,412 (1,040)	4,855 (2,200)	83 x 40 x 42
85-077-41	BHAF	400	22 (0.64)	1.99 (51)	2,260 (3,365)	2,132 (650)	5,615 (2,545)	83 x 40 x 42
85-081-41	BHAF	600	22 (0.64)	2.42 (62)	3,370 (5,015)	1,410 (430)	5,545 (2,515)	83 x 40 x 42
85-100-41	BKMF	50	24 (0.51)	0.72 (18)	255 (380)	6,316 (1,925)	2,405 (1,090)	83 x 40 x 42
85-104-41	BKMF	100	24 (0.51)	0.91 (23)	430 (640)	6,004 (1,830)	3,375 (1,530)	83 x 40 x 42
85-108-41	BKMF	200	24 (0.51)	1.18 (30)	770 (1,145)	2,116 (645)	2,425 (1,100)	83 x 40 x 42
85-110-41	BKMF	300	24 (0.51)	1.43 (36)	1,130 (1,680)	2,280 (695)	3,370 (1,530)	83 x 40 x 42
85-112-41	BKMF	400	24 (0.51)	1.62 (41)	1,475 (2,195)	2,280 (695)	4,160 (1,885)	83 x 40 x 42
85-116-41	BKMF	600	24 (0.51)	1.94 (49)	2,160 (3,215)	1,312 (400)	3,630 (1,645)	83 x 40 x 42
85-118-41	BKMF	900	24 (0.51)	2.33 (59)	3,190 (4,745)	1,050 (320)	4,145 (1,880)	83 x 40 x 42
85-120-41	BKMF	1,200	24 (0.51)	2.64 (67)	4,165 (6,200)	1,312 (400)	6,260 (2,840)	83 x 40 x 42
85-143-41	BKTF	200	26 (0.40)	1.00 (25)	525 (780)	4,822 (1,470)	3,325 (1,510)	83 x 40 x 42
85-147-41	BKTF	400	26 (0.40)	1.33 (34)	970 (1,445)	2,394 (730)	3,115 (1,415)	83 x 40 x 42
85-151-41	BKTF	600	26 (0.40)	1.58 (40)	1,410 (2,100)	2,394 (730)	4,170 (1,890)	83 x 40 x 42
85-153-41	BKTF	900	26 (0.40)	1.87 (48)	2,045 (3,045)	1,510 (460)	3,885 (1,760)	83 x 40 x 42
85-155-41	BKTF	1,200	26 (0.40)	2.13 (54)	2,695 (4,010)	1,526 (465)	4,910 (2,225)	83 x 40 x 42

# Canadian Bonded STALPETH

DCAZ, DCMZ and DCTZ



## PRODUCT DESCRIPTION

Canadian Bonded STALPETH Cable is a foam-skin insulated, single jacketed, armored air core design intended for use in ducts to provide more efficient duct utilization than standard PIC designs.

## APPLICATIONS

- Congested underground duct systems

## FEATURES

- Tightly controlled individual conductor dimensions
- Specially designed pair twist lays
- Core wrap
- Aluminum tape shield
- Steel tape armor bonded to outer jacket
- Polyethylene jacket

## BENEFITS

- Limits resistance unbalance of paired conductors
- Minimizes crosstalk and meets the capacitance unbalance requirements
- Protects the core and helps provide core-to-shield dielectric strength
- Assures good electrical contact with non-piercing bonding clamps
- Protects the core from mechanical damage and reduces the possibility of tape buckling during installation, ingress of water to the aluminum shield and of water along the cable between the armor and outer jacket
- Provides a tough, flexible, protective covering that withstands exposure to sunlight, atmospheric temperatures, ground chemicals and stresses expected in standard installations

## SPECIFICATIONS

<b>Conductor</b>	Solid annealed copper
<b>Insulation</b>	Conductors are dual insulated with an inner layer of foamed, natural polyolefin covered by an outer layer of solid, colored polyolefin; conductor insulation is color coded in accordance with industry standard
<b>≥ 50-Pair Core</b>	Multiples of 25-pair groups are assembled to form the final cable core; each group is identified by color coded non-hygroscopic binders; for 1,200-pair and larger, the color code is Mirror Image design
<b>Core Wrap</b>	Non-hygroscopic dielectric material
<b>Shield</b>	Corrugated bare 8 mil aluminum tape applied longitudinally over the core wrap
<b>Armor</b>	Corrugated, copolymer coated, 6 mil steel tape applied over the aluminum shield and bonded to the outer jacket
<b>Jacket</b>	Black polyethylene
<b>Jacket Marking</b>	Manufacturer's identification, pair count, AWG, product identification and a telephone handset printed at 2 foot intervals; sequential footage markings are printed at alternate 2 foot intervals
<b>Standards Compliance</b>	Telcordia® GR-421-CORE Issue 2 RoHS-compliant

Telcordia is a registered trademark of Ericsson Inc.

## ELECTRICAL SPECIFICATIONS

Number of Pairs	Average Mutual Capacitance @ 1,000 Hz nF/mile (nF/km)	Capacitance Unbalance Pair to Pair @ 1 kHz		Capacitance Unbalance Pair to Ground @ 1 kHz	
		Maximum Individual pF @ 1 kft (pF @ 1 km)	Maximum RMS pF @ 1 kft (pF @ 1 km)	Maximum Individual pF @ 1 kft (pF @ 1 km)	Maximum Average pF @ 1 kft (pF @ 1 km)
All pairs	83 ± 4 (52 ± 2)	80 (145)	25 (45)	800 (2,625)	175 (574)

Conductor Size AWG (mm)	Minimum Insulation Resistance @ 68°F (20°C) gigohm-mile (gigohm-km)	Maximum Average Attenuation 772 kHz @ 68°F (20°C) dB/kft (dB/km)	Maximum Conductor Resistance @ 68°F (20°C) Ohms/sheath mile (km)	DC Resistance Unbalance Maximum %		Dielectric Strength DC Potential - Volts	
				Average	Individual Pair	Conductor to Conductor	Conductor to Shield
22 (0.64)	1.0 (1.6)	5.0 (16.4)	91 (56.5)	1.5	5.0	1,400	5,000
24 (0.51)	1.0 (1.6)	6.3 (20.7)	144 (89.5)	1.5	5.0	1,200	5,000
26 (0.40)	1.0 (1.6)	7.9 (25.9)	232 (144.2)	1.5	5.0	1,000	5,000

### Minimum Near End Crosstalk (NEXT) @ 772 kHz dB/kft (dB/km)

PSWUNEXT Mean	47 (154)
PSWUNEXT Worst Pair	42 (138)

### Minimum Far End Crosstalk PSELFEXT @ 772 kHz dB/kft (dB/km)

Conductor Size AWG (mm)	Mean	Worst Pair
22 (0.64)	49 (161)	43 (141)
24 (0.51)	49 (161)	43 (141)
26 (0.40)	47 (154)	43 (141)



**PART NUMBERS AND PHYSICAL CHARACTERISTICS**

Part Number	Product Code	Pair Count	AWG (mm)	Nominal Diameter in (mm)	Approx. Weight lbs/kft (kg/km)	Standard Length ft (m)	Approx. Shipping Weight lbs (kg)	Steel Reel Size F x T x D in
07-021-76	DCAZ	900	22 (0.64)	2.49 (63)	4,375 (6,510)	1,600 (488)	7,795 (3,535)	83 x 40 x 42
07-021-77	DCAZ	1,200	22 (0.64)	2.85 (72)	5,770 (8,585)	1,200 (366)	7,720 (3,500)	83 x 40 x 42
19-116-01	DCMZ	600	24 (0.51)	1.70 (43)	19,60 (2,915)	3,900 (1,189)	8,440 (3,830)	83 x 40 x 42
07-021-99	DCMZ	900	24 (0.51)	2.02 (51)	2,860 (4,255)	2,616 (797)	8,275 (3,755)	83 x 40 x 42
07-021-68	DCMZ	1,200	24 (0.51)	2.30 (58)	3,755 (5,590)	2,000 (610)	8,305 (3,765)	83 x 40 x 42
07-022-12	DCMZ	1,500	24 (0.51)	2.57 (65)	4,660 (6,935)	1,600 (488)	8,250 (3,745)	83 x 40 x 42
07-021-69	DCMZ	1,800	24 (0.51)	2.81 (71)	5,545 (8,250)	1,250 (381)	7,725 (3,505)	83 x 40 x 42
07-021-75	DCMZ	2,100	24 (0.51)	3.04 (77)	6,440 (9,585)	1,148 (350)	8,200 (3,720)	83 x 40 x 42
07-021-98	DCMZ	2,400	24 (0.51)	3.22 (82)	7,320 (10,895)	876 (267)	7,205 (3,270)	83 x 40 x 42
07-022-11	DCTZ	900	26 (0.40)	1.62 (41)	1,850 (2,755)	3,904 (1,190)	8,010 (3,635)	83 x 40 x 42
07-021-70	DCTZ	1,200	26 (0.40)	1.84 (47)	2,420 (3,600)	3,200 (975)	8,540 (3,875)	83 x 40 x 42
07-022-08	DCTZ	1,500	26 (0.40)	2.08 (53)	2,995 (4,455)	2,500 (762)	8,285 (3,755)	83 x 40 x 42
07-021-71	DCTZ	1,800	26 (0.40)	2.26 (57)	3,560 (5,300)	2,080 (634)	8,200 (3,720)	83 x 40 x 42
07-021-72	DCTZ	2,400	26 (0.40)	2.58 (66)	4,685 (6,970)	1,600 (488)	8,290 (3,760)	83 x 40 x 42
07-021-73	DCTZ	3,000	26 (0.40)	2.86 (73)	5,800 (8,630)	1,200 (366)	7,755 (3,520)	83 x 40 x 42
07-021-74	DCTZ	3,600	26 (0.40)	3.03 (77)	6,885 (10,245)	1,150 (351)	8,715 (3,950)	83 x 40 x 42

# Canadian Integrated Messenger Wire

IM/F, IM/H and IM/G



## PRODUCT DESCRIPTION

IM/F, IM/H and IM/G Aerial Service Wire in 2, 3, 6 and 12-pair is self supporting. The conductors are laid parallel to a solid extra-strength steel support wire. Both the conductors and support wire are jacketed in an integral "figure 8" configuration. This product permits fast, economical installation from aerial distribution cable terminals to building entrance protectors or network interface units on the subscriber's premises. The fully color coded core expedites splicing and terminating procedures.

## SPECIFICATIONS

<b>Conductor</b>	Solid annealed copper
<b>Insulation</b>	Solid polyolefin in distinctive colors; standard color codes are used for pair identification with compounds chosen for electrical balance and permanency
<b>Core Assembly</b>	Tightly controlled individual conductor dimensions; in multi-pair constructions, pair twist lays are varied; twisted pairs are formed into a firm, round core
<b>Support Member</b>	Available in 0.083 inch (F), 0.109 inch (H), or 0.095 inch (G) solid extra-strength steel support wire
<b>Jacket</b>	Black, fire retardant, polyvinyl chloride jacket; steel support wire is jacketed in an integral extrusion with the core
<b>Performance Compliance</b>	Telcordia® GR-3163-CORE ANSI/ICEA S-89-648-2011 RoHS-compliant
<b>NRTL Programs</b>	UL® Listed

Telcordia is a registered trademark of Ericsson Inc. UL is a registered trademark of UL LLC.

## FEATURES

- Tightly controlled individual conductor dimensions
- Varied pair twist lays
- Polyvinyl chloride jacket

## BENEFITS

- Limits resistance unbalance of the twisted pairs
- Minimizes crosstalk and meets capacitance limits
- Provides a tough flexible protective covering that withstands exposure to sunlight, atmospheric temperatures and stresses encountered in standard installations



## TECHNICAL GUIDELINE

Sag and Tension Technical Guidelines are available for these products. Refer to the "Resources" section on our site for more information.

## ELECTRICAL SPECIFICATIONS

Average Mutual Capacitance @ 1,000 Hz		Capacitance Unbalance @ 1 kHz Maximum Individual		Minimum Near End Crosstalk (NEXT) @ 772 kHz dB/kft (dB/km)
Maximum Individual nF/mile (nF/km)	Wire Average nF/mile (nF/km)	Pair to Pair pF @ 1 kft (pF @ 1 km)	Pair to Ground pF @ 1 kft (pF @ 1 km)	
94 (58)	83 ± 7 (52 ± 4)	80 (145)	800 (2,625)	44 (144)

Conductor Size AWG (mm)	Minimum Insulation Resistance megohm-kft (megohm-km)	Maximum Average Attenuation 772 kHz @ 68°F (20°C) dB/kft (dB/km)	DC Conductor Resistance @ 68°F (20°C) Maximum Individual Ohms/mile (Ohms/km)	Resistance Unbalance Maximum % Individual Pair	Conductor to Conductor Dielectric Strength Minimum Volts DC 3 secs, no breakdown
19 (0.90)	5,000 (1,600)	3.3 (11)	45 (28.0)	5.0	5,000
22 (0.64)	5,000 (1,600)	5.1 (17)	91 (56.5)	5.0	4,000

## PART NUMBERS AND PHYSICAL CHARACTERISTICS

Part Number	Support Size in	Pair Count	AWG (mm)	Dimensions		Approx. Weight lbs/kft (kg/km)	Standard Length ft (m)	Package
				Minor in (mm)	Major in (mm)			
10-921-38	IM/G 0.095	2	19 (0.90)	0.27 (6.8)	0.51 (12.9)	73 (109)	656 (200)	Coil
10-923-38	IM/G 0.095	2	19 (0.90)	0.27 (6.8)	0.51 (12.9)	73 (109)	4,921 (1,500)	Reel
10-002-34	IM/F 0.083	2	22 (0.64)	0.22 (5.7)	0.46 (11.7)	55 (82)	600 (183)	Coil
10-503-34	IM/F 0.083	3	22 (0.64)	0.24 (6.2)	0.48 (12.3)	72 (107)	600 (183)	Coil
10-106-34	IM/F 0.083	6	22 (0.64)	0.30 (7.6)	0.53 (13.6)	80 (119)	3,500 (1,067)	Reel
10-206-34	IM/F 0.083	6	22 (0.64)	0.30 (7.6)	0.53 (13.6)	80 (119)	1,000 (305)	Reel
10-261-38	IM/G 0.095	6	22 (0.64)	0.30 (7.6)	0.55 (13.9)	80 (119)	492 (150)	Coil
10-262-38	IM/G 0.095	6	22 (0.64)	0.30 (7.6)	0.55 (13.9)	80 (119)	2,461 (750)	Reel
10-281-38	IM/G 0.095	12	22 (0.64)	0.38 (7.6)	0.65 (16.6)	114 (170)	410 (125)	Coil
10-284-38	IM/G 0.095	12	22 (0.64)	0.38 (7.6)	0.65 (16.6)	114 (170)	2,460 (750)	Reel
10-285-38	IM/G 0.095	12	22 (0.64)	0.38 (7.6)	0.65 (16.6)	114 (170)	8,202 (2,500)	Reel
10-102-35	IM/H 0.109	12	22 (0.64)	0.38 (7.6)	0.66 (16.7)	130 (193)	1,000 (305)	Reel
10-012-35	IM/H 0.109	12	22 (0.64)	0.38 (7.6)	0.66 (16.7)	130 (193)	250 (76)	Coil
10-212-35	IM/H 0.109	12	22 (0.64)	0.38 (7.6)	0.66 (16.7)	130 (193)	5,000 (1,524)	Reel

Contact Superior Essex for additional configurations and AWG sizes.

## PRODUCT DESCRIPTION

ADP NMS is a PVC-jacketed aerial service wire with QuickCount® in meters. It is available in 2-pair and 6-pair designs. ADP NMS printed in meters is designed for use in extending telephone service to subscriber premises from the distribution cable or cable terminal. Major features include small size and light weight coupled with abrasion resistant jacket. Standard hardware and installation procedures are directly applicable to this product.



## FEATURES

- Insulation of the tip conductor is marked with a stripe of the mating ring insulation color
- Tightly controlled individual conductor dimensions
- Fiberglass yarns
- Rip cord
- Weather resistant, polyvinyl chloride jacket bonded to the fiberglass strength members

## BENEFITS

- Reduces the possibility of splitting pairs during installation
- Limits resistance unbalance of the twisted pairs
- Provides necessary longitudinal strength
- Facilitates jacket removal
- Protects the core from mechanical damage, degradation by sunlight and ingress of moisture
- Provides the required strength characteristics

## SPECIFICATIONS

<b>Conductor</b>	Solid annealed copper
<b>Insulation</b>	Solid polyolefin; insulation of the tip conductor is marked with a stripe of the mating ring insulation color
<b>Core Assembly</b>	Individual conductors are carefully twisted into pairs
<b>Strength Members</b>	Fiberglass yarns placed parallel to the core
<b>Rip cord</b>	Placed parallel to the core
<b>Jacket</b>	Black, weather resistant, polyvinyl chloride jacket extruded over the yarns and rip cord and bonded to the fiberglass strength members
<b>Performance Compliance</b>	Telcordia® GR-3163-CORE RDUP PE-7 ANSI/ICEA S-89-648-2011 RoHS-compliant
<b>NRTL Programs</b>	UL® Listed

Telcordia is a registered trademark of Ericsson Inc. UL is a registered trademark of UL LLC.

## ELECTRICAL SPECIFICATIONS

Average Mutual Capacitance @ 1,000 Hz			Capacitance Unbalance @ 1 kHz		Minimum Near End Crosstalk (NEXT) @ 772 kHz dB/kft (dB/km)
Maximum Individual nF/mile (nF/km)	Wire Average nF/mile (nF/km)	Maximum Individual Pair to Pair pF @ 1 kft (pF @ 1 km)	Minimum	Maximum	
94 (58)	83 ± 7 (52 ± 4)	80 (145)			48 (157)

Conductor Size AWG (mm)	Minimum Insulation Resistance megohm-mile (megohm-km)	Maximum Average Attenuation 772 kHz @ 68°F (20°C) dB/kft (dB/km)	DC Conductor Resistance @ 68°F (20°C) Maximum Individual Ohms/mile (Ohms/km)	Resistance Unbalance Maximum % Individual Pair	Conductor to Conductor Dielectric Strength Minimum Volts DC 3 secs, no breakdown
22 (0.64)	1,000 (1,600)	5.1 (17)	91 (56.5)	5.0	4,000

## PART NUMBERS AND PHYSICAL CHARACTERISTICS

Part Number	Pair Count	AWG (mm)	Dimensions		Approx. Weight lbs/kft (kg/km)	Standard Length m	Package
			Minor in (mm)	Major in (mm)			
12-015-08	2	22 (0.64)	0.18 (4.8)	0.36 (9.1)	35 (50)	150	ReelSaver™ coil
12-014-08	2	22 (0.64)	0.18 (4.8)	0.36 (9.1)	35 (50)	228	POP™ box
12-013-08	2	22 (0.64)	0.18 (4.8)	0.36 (9.1)	35 (50)	300	Coil
11-003-66	6	22 (0.64)	0.27 (7.0)	0.48 (12)	70 (105)	305	Reel
11-003-65	6	22 (0.64)	0.27 (7.0)	0.48 (12)	70 (105)	122	Coil



## TECHNICAL GUIDELINE

Sag and Tension Technical Guidelines are available for these products. Refer to the "Resources" section on our site for more information.

# Aerial Drop Wire

ADW



## SPECIFICATIONS

Conductor	Solid annealed copper
Insulation	Individual conductors insulated with solid polyolefin in distinctive colors; 2-pair color code is Blue/White and Orange/Red and 4-pair color code is Blue/White, Orange/Red, Black/Green and Yellow/Brown
Core Assembly	Individual conductors twisted into pairs
Strength Members	Fiberglass strength members placed in the jacket parallel to the core assembly
Rip cord	Placed parallel to the core
Jacket	Sky blue grey weather-resistant PVC jacket extruded over the strength members and bonded to the fiberglass strength members
Standards Compliance	RoHS-compliant

## PRODUCT DESCRIPTION

ADW is a PVC jacketed 2-pair or 4-pair aerial service wire designed for use in extending telephone service to subscriber premises from the distribution cable or cable terminal. Major features include small size and light weight coupled with abrasion resistant jacket. Standard hardware and installations procedures are directly applicable to this product.

## FEATURES

- Twisted pairs with varying lays
- Fiberglass strength members
- Rip cord
- Weather-resistant PVC jacket extruded over the strength members and bonded to the fiberglass strength members

## BENEFITS

- Minimizes resistance unbalance
- Provides the necessary longitudinal strength
- Facilitates jacket removal
- Protects the core from mechanical damage, degradation by sunlight and the ingress of moisture
- Provides the required strength characteristics

## ELECTRICAL SPECIFICATIONS

Conductor Size AWG (mm)	Average Mutual Capacitance @ 1,000 Hz nF/mile (nF/km)	Insulation Resistance @ 60°F (16°C) megohm-mile (megohm-km)	Capacitance Unbalance @ 1 kHz Pair to Pair Maximum pF @ 1 kft (pF @ 1 km)	Conductor DC Resistance @ 20°F (-7°C) Maximum Individual Ohms/kft (Ohms/km)	Resistance Unbalance Maximum Individual Pair %	Dielectric Strength DC Potential - Volts Minimum Conductor to Conductor
22 (0.64)	113 (70)	380 (610)	80 (145)	16.8 (55)	5.0	4,000

## PART NUMBERS AND PHYSICAL CHARACTERISTICS

Part Number	Pair Count	AWG (mm)	Nominal Diameter in (mm)	Approx. Weight lbs/kft (kg/km)	Standard Length ft (m)	Package
12-022-09	2	22 (0.64)	0.26 (6.6)	30 (45)	1,476 (450)	Coil
12-021-09	2	22 (0.64)	0.26 (6.6)	30 (45)	656 (200)	POP™ Box
12-041-09	4	22 (0.64)	0.33 (8.4)	55 (80)	820 (250)	Coil
12-043-09	4	22 (0.64)	0.33 (8.4)	55 (80)	328 (100)	POP Box



### TECHNICAL GUIDELINE

Sag and Tension Technical Guidelines are available for these products. Refer to the "Resources" section on our site for more information.

# Buried Distribution Wire

BCBD

## PRODUCT DESCRIPTION

BCBD Wire with foam skin insulation is a single jacketed design for use in subscriber distribution.



## FEATURES

- Varied pair twist lays
- Core wrap
- Polyethylene jacket

## BENEFITS

- Minimizes crosstalk and meets capacitance unbalance limitations
- Furnishes mechanical and high dielectric protection between shielding and individual conductors
- Provides a tough, flexible protective covering that withstands exposure to sunlight, atmospheric temperatures, ground chemicals and stresses expected in standard installations

## SPECIFICATIONS

<b>Conductor</b>	Solid annealed copper
<b>AWG (mm)</b>	22 (0.64)
<b>Insulation</b>	Dual-extruded cellular inner layer and a color coded solid outer layer of polyolefin
<b>Core Assembly</b>	Insulated conductors are twisted to form pairs with varying lays
<b>Filling Compound</b>	PEPJ compound applied to the wire core which completely coats each insulated conductor and fills the interstices between pairs
<b>Core Wrap</b>	Non-hygroscopic core wrap applied over the core
<b>Flooding Compound</b>	Applied to fill all the voids under the shield
<b>Shield</b>	Electrically-continuous 8 mil flat aluminum tape shield with a polyolefin film fused and chemically bonded to both sides; applied longitudinally over the core and bonded to the outer jacket
<b>Jacket</b>	Black medium-density polyethylene
<b>Standards Compliance</b>	RoHS-compliant

## ELECTRICAL SPECIFICATIONS

Average Mutual Capacitance @ 1,000 Hz nF/mile (nF/km)	Capacitance Unbalance Maximum Individual	
	Pair to Pair pF @ 1 kft (pF @ 1 km)	Pair to Ground pF @ 1 kft (pF @ 1 km)
90 (56)	80 (145)	800 (2,625)

Conductor Size AWG (mm)	Minimum Insulation Resistance @ 60°F (16°C) gigohm-mile (gigohm-km)	Maximum Average Attenuation 772 kHz @ 68°F (20°C) dB/kft (dB/km)	Maximum Conductor Resistance @ 68°F (20°C) Ohms/sheath kft (km)	Resistance Unbalance Maximum % Individual Pair	Dielectric Strength DC Potential - Volts Minimum	
					Conductor to Conductor	Conductor to Shield
22 (0.64)	1.0 (1.6)	4.5 (14.8)	17.3 (56.6)	5.0	3,600	10,000

## PART NUMBERS AND PHYSICAL CHARACTERISTICS

Part Number	Pair Count	AWG (mm)	Nominal Diameter in (mm)	Approx. Weight lbs/kft (kg/km)	Standard Length ft (m)	Package
85-233-06	4	22 (0.64)	0.30 (7.6)	45 (65)	4,593 (1,400)	Reel

# C-Rural Wire



## PRODUCT DESCRIPTION

C-Rural Wire is quickly and easily installed, utilizing standard hardware and installation procedures for single circuit aerial distribution rural networks.

## SPECIFICATIONS

Conductor	Solid 30% conductivity copper-covered steel
Insulation	Black polyolefin compound extruded over the two conductors in parallel to form an integrated oval configuration
Standards Compliance	Telcordia® TA-TSY-000125 RoHS-compliant

*Telcordia is a registered trademark of Ericsson Inc.*

## PART NUMBERS AND PHYSICAL CHARACTERISTICS

Part Number	AWG (mm)	Dimensions		Approx. Weight lbs/kft (kg/km)	Standard Length ft (m)	Package
		Minor in (mm)	Major in (mm)			
10-026-06	14 (1.63)	0.15 (3.8)	0.28 (7.1)	36 (54)	1,000 (305)	Coil
10-016-06	14 (1.63)	0.15 (3.8)	0.28 (7.1)	36 (54)	5,500 (1,676)	Wooden reel
10-116-06	14 (1.63)	0.15 (3.8)	0.28 (7.1)	36 (54)	22,000 (6,705)	Four 5,500' reels on a pallet



### TECHNICAL GUIDELINE

*Sag and Tension Technical Guidelines are available for these products. Refer to the "Resources" section on our site for more information.*

## PRODUCT DESCRIPTION

Multi-pair, self-supporting IMRDW Wire is used for subscriber lines in exchange plant; single-pair is often used for lateral runs from aerial plant. In both single and multi-pair types, the wire core is laid parallel to a solid steel support wire and jacketed in an integral extrusion to form a “figure 8” configuration utilizing a 0.109 inch solid, extra-high strength steel support member. The IM construction permits fast, economical installation and facilitates removal and re-use of wire.



## SPECIFICATIONS

<b>Conductor</b>	Solid bare copper
<b>Insulation</b>	Polyolefin
<b>Core Assembly</b>	Twisted into pairs to minimize resistance unbalance; in multi-pair constructions, pair twist lays vary to minimize crosstalk and meet capacitance unbalance requirements; twisted pairs are formed into firm, round core
<b>Core Wrap</b>	Non-hygroscopic, dielectric wrap
<b>Jacket</b>	Black polyethylene
<b>Support Wire</b>	Single 0.109 inch solid, extra-high strength steel, jacketed in an integral extrusion with the core
<b>Standards Compliance</b>	RDUP PE-27 and PE-28 deactivated by RDUP ICEA S-89-648 as applicable RoHS-compliant

## ELECTRICAL SPECIFICATIONS

Number of Pairs		Average Mutual Capacitance @ 1,000 Hz nF/mile (nF/km)
Maximum Individual		94 (58)
12 or less		83 ± 7 (52 ± 4)
Over 12		83 ± 4 (52 ± 2)

Conductor Size AWG (mm)	Minimum Insulation Resistance @ 68°F (20°C) megohm-mile (megohm-km)	Maximum Average Attenuation 772 kHz @ 68°F (20°C) dB/kft (dB/km)	Maximum Conductor Resistance @ 68°F (20°C) Ohms/mile (Ohms/km)	DC Resistance Unbalance Maximum % Individual Pair	Dielectric Strength Minimum Volts DC
22 (0.64)	1,000 (1,600)	5.1 (16.7)	91 (56.4)	5.0	7,200
24 (0.51)	1,000 (1,600)	6.5 (21.3)	144 (89.5)	5.0	7,200

Capacitance Unbalance @ 1,000 Hz pF @ 1 kft (pF @ 1 km)	
Maximum Pair to Pair	80 (145)

## PART NUMBERS AND PHYSICAL CHARACTERISTICS

Part Number	Pair Count	AWG (mm)	Dimensions		Approx. Weight lbs/kft (kg/km)	Standard Length ft (m)	Package
			Minor in (mm)	Major in (mm)			
10-002-17	2	22 (0.64)	0.20 (5.1)	0.48 (12.2)	60 (90)	5,000 (1,524)	Reel
10-006-17	6	22 (0.64)	0.29 (7.5)	0.58 (14.8)	85 (125)	5,000 (1,524)	Reel
10-012-17	12	22 (0.64)	0.36 (9.2)	0.65 (16.5)	115 (170)	5,000 (1,524)	Reel
10-012-19	12	24 (0.51)	0.32 (8.2)	0.61 (15.4)	95 (140)	5,000 (1,524)	Reel



### TECHNICAL GUIDELINE

Sag and Tension Technical Guidelines are available for these products. Refer to the “Resources” section on our site for more information.

# IMRDWS

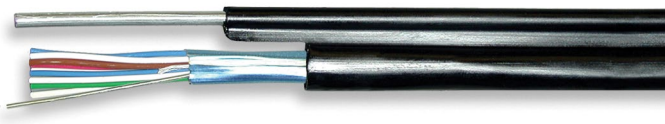

## PRODUCT DESCRIPTION

IMRDWS is an aerial wire designed for use in extending communications service (voice, data, and/or video) to a subscriber premises from the distribution point. This product has additional capabilities over the standard IMRDW product because it contains a shielding screen. The conductors are wrapped within a metallic aluminum shield to insulate them from interference and thus provide high-quality digital transmission. In addition, a drain wire runs longitudinally the length of the wire to drain off Electromagnetic Interference (EMI) and Radio Frequency Interference (RFI). Without shielding and a drain wire, noise can be introduced into circuits from high voltage AC power lines, machinery with motors, x-ray systems, TV sets and AM radio stations. Shielding also lessens the chance that DSL or other high frequency transmission protocols will interfere with other signals on adjacent cables.

## SPECIFICATIONS

Conductor	Solid bare copper
Insulation	Polyolefin
Core Assembly	Individual conductors carefully twisted into pairs to minimize resistance unbalance and cross-talk
Shield	3 mil foil shield with drain wire
Jacket	Black polyethylene
Rip cord	Placed parallel to the core
Support Wire	"Figure 8" configuration utilizing a 0.109 inch, solid, extra high strength, steel support wire
Standards Compliance	ICEA S-89-648 as applicable RoHS-compliant

## FEATURES

- 3 mil foil shield with drain wire
- Black, polyethylene jacket
- Rip cord

## BENEFITS

- Provides high-quality digital transmission medium for xDSL technologies and, when properly grounded, removes spectrum interferences
- Provides tough, flexible protective covering that withstands exposure to sunlight, atmospheric temperatures and stresses encountered in standard installations
- Facilitates jacket removal

## ELECTRICAL SPECIFICATIONS

All Pairs	Average Mutual Capacitance @ 1,000 Hz nF/mile (nF/km)
Maximum Individual	94 (58)
Wire Average	83 ± 7 (52 ± 4)

Conductor Size AWG (mm)	Minimum Insulation Resistance @ 68°F (20°C) megohm-mile (megohm-km)	Maximum Average Attenuation 772 kHz @ 68°F (20°C) dB/kft (dB/km)	Maximum Conductor Resistance @ 68°F (20°C) Ohms/mile (Ohms/km)	DC Resistance Unbalance Maximum % Individual Pair	Dielectric Strength Minimum Volts DC	
					Conductor to Conductor	Conductor to Shield
22 (0.64)	1,000 (1,600)	5.1 (16.7)	91 (56.4)	5.0	7,200	3,600

Crosstalk Loss dB/kft (dB/km)		Capacitance Unbalance @ 1,000 Hz pF @ 1 kft (pF @ 1 km)	
Minimum FEXT @ 150 kHz	63 (207)	Maximum Individual Pair to Pair	80 (145)
Minimum NEXT @ 722 kHz	44 (144)	Maximum Individual Pair to Ground	800 (2,625)

## PART NUMBERS AND PHYSICAL CHARACTERISTICS

Part Number	Pair Count	AWG (mm)	Dimensions		Approx. Weight lbs/kft (kg/km)	Standard Length ft (m)	Package
			Minor in (mm)	Major in (mm)			
10-061-29	6	22 (0.64)	0.32 (8.1)	0.60 (15.3)	95 (142)	2,133 (650)	Reel
10-040-29	6	22 (0.64)	0.32 (8.1)	0.60 (15.3)	95 (142)	5,000 (1,524)	Reel



### TECHNICAL GUIDELINE

Sag and Tension Technical Guidelines are available for these products. Refer to the "Resources" section on our site for more information.



## PRODUCT DESCRIPTION

ADP NMS is a PVC-jacketed Aerial Service Wire offered in 1, 2, 3, 5 or 6-pair. It is designed for use in extending telephone service to subscriber premises from the distribution cable or cable terminal. Major features include small size and light weight coupled with abrasion resistant jacket. Standard hardware and installation procedures are directly applicable to this product. The insulation of the tip conductor is marked with a stripe of the mating ring insulation color to reduce the possibility of splitting pairs during installation. A black, weather resistant, polyvinyl chloride jacket is extruded over the strength members and rip cord to protect the core from mechanical damage, degradation by sunlight and ingress of moisture. The jacket bonds to the strength members to provide the required strength characteristics.

### FEATURES

- Non-metallic or fiberglass strength members
- Rip cord

### BENEFITS

- Provide necessary longitudinal strength
- Facilitates jacket removal



## SPECIFICATIONS

<b>Conductor</b>	Solid annealed copper
<b>Insulation</b>	Polyolefin
<b>Core Assembly</b>	Individual conductors are carefully twisted into pairs in a manner designed to minimize resistance unbalance
<b>Strength Members</b>	Non-metallic or fiberglass strength members placed in jacket parallel to core assembly
<b>Rip cord</b>	Placed parallel to the core
<b>Jacket</b>	Weather-resistant PVC
<b>Performance Compliance</b>	Telcordia® GR-3163-CORE RDUP PE 7 ANSI/ICEA S-89-648-2011 RoHS-compliant
<b>NRTL Programs</b>	UL® Listed

Telcordia is a registered trademark of Ericsson Inc. UL is a registered trademark of UL LLC.

## ELECTRICAL SPECIFICATIONS

Number of Pairs		Average Mutual Capacitance @ 1,000 Hz nF/mile (nF/km)			
Maximum Pair		94 (58)			
Maximum Average		90 (56)			

Conductor Size AWG (mm)	Minimum Insulation Resistance @ 68°F (20°C) megohm-mile (megohm-km)	Maximum Average Attenuation 772 kHz @ 68°F (20°C) dB/kft (dB/km)	Maximum Conductor Resistance @ 68°F (20°C) Ohms/mile (Ohms/km)	DC Resistance Unbalance Maximum % Individual Pair	Conductor to Conductor Dielectric Strength Volts DC 3 secs, no breakdown
22 (0.64)	1,000 (1,600)	5.1 (17)	91 (56.5)	5.0	4,000

Crosstalk Loss dB/kft (dB/km)		Capacitance Unbalance @ 1,000 Hz pF @ 1 kft (pF @ 1 km)	
Minimum NEXT @ 722 kHz		Maximum Individual Pair	
44 (144)		80 (145)	

## PART NUMBERS AND PHYSICAL CHARACTERISTICS

Part Number	Pair Count	AWG (mm)	Dimensions		Approx. Weight lbs/kft (kg/km)	Standard Length ft (m)	Package
			Minor in (mm)	Major in (mm)			
12-031-08	1	22 (0.64)	0.18 (4.8)	0.36 (9.1)	34 (51)	750 (229)	POP™ box
12-004-08	2	22 (0.64)	0.18 (4.8)	0.36 (9.1)	39 (58)	750 (229)	POP box
12-010-08	2	22 (0.64)	0.18 (4.8)	0.36 (9.1)	39 (58)	1,000 (305)	Coil
12-023-08	2	22 (0.64)	0.18 (4.8)	0.36 (9.1)	39 (58)	5,000 (1,524)	Reel
12-019-08	3	22 (0.64)	0.21 (5.3)	0.39 (9.9)	45 (67)	600 (183)	POP box
12-022-08	3	22 (0.64)	0.21 (5.3)	0.39 (9.9)	45 (67)	750 (229)	Coil
12-519-08	5	22 (0.64)	0.27 (7.0)	0.48 (12.0)	76 (113)	400 (122)	POP box
12-024-08	5	22 (0.64)	0.27 (7.0)	0.48 (12.0)	76 (113)	2,500 (762)	Reel
12-025-08	5	22 (0.64)	0.27 (7.0)	0.48 (12.0)	76 (113)	1,000 (305)	Reel
12-026-08	5	22 (0.64)	0.27 (7.0)	0.48 (12.0)	76 (113)	700 (213)	IPL coil
12-006-08	6	22 (0.64)	0.27 (7.0)	0.48 (12.0)	80 (119)	400 (122)	Coil
12-007-08	6	22 (0.64)	0.27 (7.0)	0.48 (12.0)	80 (119)	2,500 (762)	Reel
12-008-08	6	22 (0.64)	0.27 (7.0)	0.48 (12.0)	80 (119)	3,500 (1,068)	Reel
12-009-08	6	22 (0.64)	0.27 (7.0)	0.48 (12.0)	80 (119)	1,000 (305)	Reel



### TECHNICAL GUIDELINE

Sag and Tension Technical Guidelines are available for these products. Refer to the "Resources" section on our site for more information.

# ADP NMS Compact Design

6 x 24



## SPECIFICATIONS

<b>Conductor</b>	Solid annealed copper
<b>Insulation</b>	Polyolefin
<b>Core Assembly</b>	Individual conductors are carefully twisted into pairs in a manner designed to minimize resistance unbalance
<b>Strength Members</b>	Non-metallic or fiberglass strength members placed in jacket parallel to core assembly
<b>Rip cord</b>	Placed parallel to the core
<b>Jacket</b>	Weather-resistant PVC
<b>Performance Compliance</b>	GR-3163-CORE as applicable ANSI/ICEA S-89-648-2011 RoHS-compliant
<b>NRTL Programs</b>	UL® Listed

UL is a registered trademark of UL LLC.

## ELECTRICAL SPECIFICATIONS

Number of Pairs		Average Mutual Capacitance @ 1,000 Hz nF/mile (nF/km)		
Maximum Individual		94 (58)		
Wire Average		83 ± 7 (52 ± 4)		

Conductor Size AWG (mm)	Minimum Insulation Resistance @ 68°F (20°C) megohm-mile (megohm-km)	Maximum Average Attenuation 772 kHz @ 68°F (20°C) dB/kft (dB/km)	Maximum Conductor Resistance @ 68°F (20°C) Ohms/mile (Ohms/km)	DC Resistance Unbalance Maximum % Individual Pair
24 (0.51)	1,000 (1,600)	5.8 (19.0)	144 (89.5)	5.0

Crosstalk Loss dB/kft (dB/km)		Capacitance Unbalance @ 1,000 Hz pF @ 1 kft (pF @ 1 km)
Minimum FEXT @ 150 kHz	63 (207)	Maximum Individual Pair 80 (145)
Minimum NEXT @ 722 kHz	44 (144)	

## PRODUCT DESCRIPTION

The ADP NMS 6 x 24 Compact Design features a black abrasion resistant PVC-jacket and is used to extend telephone service to subscriber premises from the distribution cable or cable terminal. The product features four fiberglass yarns that provide all the longitudinal strength necessary. Simple access procedures allow for quick and easy installation with the small standard off the shelf industry hardware. This product offers 6-pair in the size and shape of the traditional 3-pair product. Each conductor is insulated with solid polyolefin in distinctive colors. The insulation of the tip conductor is marked with a stripe of the mating ring insulation color to reduce the possibility of splitting pairs during installation. A black, weather resistant, polyvinyl chloride jacket is extruded over the strength members and rip cord to protect the core from mechanical damage. The jacket bonds to the fiber glass strength members to provide the required strength characteristics.

## FEATURES

- Non-metallic or fiberglass strength members
- Rip cord

## BENEFITS

- Provide necessary longitudinal strength
- Facilitates jacket removal

## PART NUMBERS AND PHYSICAL CHARACTERISTICS

Part Number	Pair Count	AWG (mm)	Dimensions		Approx. Weight lbs/kft (kg/km)	Standard Length ft (m)	Package
			Minor in (mm)	Major in (mm)			
12-801-08	6	24 (0.51)	0.21 (5.3)	0.38 (9.7)	50 (74)	600 (183)	POP™ box



### TECHNICAL GUIDELINE

Sag and Tension Technical Guidelines are available for these products. Refer to the "Resources" section on our site for more information.



**PRODUCT DESCRIPTION**

ADP S is a PVC-jacketed, aerial service wire designed for use in extending communications service (voice, data and/or video) to a subscriber premises from the distribution cable terminal. This product has additional capabilities over the standard ADP NMS product because it contains a shielding screen. The core is wrapped within a metallic foil to provide shielding from interference and thus provide high-quality digital transmission. In addition, a drain wire runs longitudinally the length of the wire to drain off Electromagnetic Interference (EMI) and Radio Frequency Interference (RFI). Without shielding and a drain wire, noise can be introduced into circuits from high voltage AC power lines, machinery with motors, x-ray systems, TV sets and AM radio stations. Shielding also lessens the chance that DSL or other high frequency transmission protocols will interfere with other signals on adjacent cables. Each conductor is insulated with solid polyolefin in distinctive colors. The insulation of the tip conductor is marked with a stripe of the mating ring insulation color to reduce the possibility of splitting pairs during installation. A black, weather resistant, polyvinyl chloride jacket is extruded over the yarns and rip cord to protect the core from mechanical damage, degradation by sunlight and ingress of moisture. The jacket bonds to the fiberglass strength members to provide the required strength characteristics.

**FEATURES**

- 3 mil metallic foil shield with drain wire
- Non-metallic or fiberglass strength members
- Rip cord

**BENEFITS**

- Provides high-quality digital transmission medium for xDSL technologies and, when properly grounded, removes spectrum interferences
- Provide necessary longitudinal strength
- Facilitates jacket removal

**SPECIFICATIONS**

<b>Conductor</b>	Solid annealed copper
<b>Insulation</b>	Polyolefin
<b>Core Assembly</b>	Individual conductors are carefully twisted into pairs in a manner designed to minimize resistance unbalance
<b>Shield</b>	3 mil metallic foil shield with drain wire
<b>Strength Members</b>	Non-metallic or fiberglass strength members placed in jacket parallel to core assembly
<b>Rip cord</b>	Placed parallel to the core
<b>Jacket</b>	Weather-resistant PVC
<b>Performance Compliance</b>	Applicable sections of both GR-3163-CORE and ANSI/ICEA S-89-648-2011 RoHS-compliant
<b>NRTL Programs</b>	UL® Listed

UL is a registered trademark of UL LLC.

**ELECTRICAL SPECIFICATIONS**

Number of Pairs		Average Mutual Capacitance @ 1,000 Hz nF/mile (nF/km)			
Maximum Pair		94 (58)			
Maximum Average		90 (56)			
Conductor Size AWG (mm)	Minimum Insulation Resistance @ 68°F (20°C) megohm-mile (megohm-km)	Maximum Average Attenuation 772 kHz @ 68°F (20°C) dB/kft (dB/km)	Maximum Conductor Resistance @ 68°F (20°C) Ohms/mile (Ohms/km)	DC Resistance Unbalance Maximum % Individual Pair	Conductor to Conductor Dielectric Strength Volts DC 3 secs, no breakdown
22 (0.64)	1,000 (1,600)	5.1 (17)	91 (56.5)	5.0	4,000
Crosstalk Loss dB/kft (dB/km)		Capacitance Unbalance @ 1,000 Hz pF @ 1 kft (pF @ 1 km)			
Minimum NEXT @ 722 kHz		44 (144)		Maximum Individual Pair 80 (145)	

**PART NUMBERS AND PHYSICAL CHARACTERISTICS**

Part Number	Pair Count	AWG (mm)	Dimensions		Approx. Weight lbs/kft (kg/km)	Standard Length ft (m)	Package
			Minor in (mm)	Major in (mm)			
12-101-07	1	22 (0.64)	0.21 (5.3)	0.39 (9.9)	37 (49)	1,000 (305)	Reel
12-301-07	3	22 (0.64)	0.27 (6.8)	0.45 (11.4)	55 (82)	1,000 (305)	Reel
12-302-07	3	22 (0.64)	0.27 (6.8)	0.45 (11.4)	55 (82)	400 (122)	POP™ box
12-303-07	3	22 (0.64)	0.27 (6.8)	0.45 (11.4)	55 (82)	750 (229)	Reel
12-305-07	3	22 (0.64)	0.27 (6.8)	0.45 (11.4)	55 (82)	500 (152)	Reel-in-a-Box



**TECHNICAL GUIDELINE**

Sag and Tension Technical Guidelines are available for these products. Refer to the "Resources" section on our site for more information.

# Integrated Messenger Wire

IM/F, IM/H and IM/G



## SPECIFICATIONS

Conductor	Solid annealed copper
Insulation	Polyolefin
Core Assembly	Individual conductor dimensions are tightly controlled to limit resistance unbalance of the twisted pairs; in multi-pair constructions, pair twist lays are varied to minimize crosstalk and meet capacitance limits; twisted pairs are formed into a firm, round core
Jacket	Fire retardant PVC
Performance Compliance	Telcordia® GR-3163-CORE ANSI/ICEA S-89-648-2011 RoHS-compliant
NRTL Programs	UL® Listed

Telcordia is a registered trademark of Ericsson Inc. UL is a registered trademark of UL LLC.

## PRODUCT DESCRIPTION

IM/F, IM/H and IM/G aerial service wire in 2, 3, 6 and 12-pair is self supporting. The conductors are laid parallel to an (F) 0.083 inch, (H) 0.109 inch, or (G) 0.095 inch solid extra-strength steel support wire. Both the conductors and support wire are jacketed in an integral "figure 8" configuration. This product permits fast, economical installation from aerial distribution cable terminals to building entrance protectors or network interface units on the subscriber's premises. The fully color coded core expedites splicing and terminating procedures. A black, fire retardant, polyvinyl chloride jacket provides a tough flexible protective covering that withstands exposure to sunlight, atmospheric temperatures and stresses encountered in standard installations. The steel support wire is jacketed in an integral extrusion with the core.



## TECHNICAL GUIDELINE

Sag and Tension Technical Guidelines are available for these products. Refer to the "Resources" section on our site for more information.

## ELECTRICAL SPECIFICATIONS

Number of Pairs		Average Mutual Capacitance @ 1,000 Hz nF/mile (nF/km)			
Maximum Pair		94 (58)			
Maximum Average		90 (56)			
Conductor Size AWG (mm)	Minimum Insulation Resistance @ 68°F (20°C) megohm-mile (megohm-km)	Maximum Average Attenuation 772 kHz @ 68°F (20°C) dB/kft (dB/km)	Maximum Conductor Resistance @ 68°F (20°C) Ohms/mile (Ohms/km)	DC Resistance Unbalance Maximum % Individual Pair	Conductor to Conductor Dielectric Strength Minimum Volts DC 3 secs, no breakdown
19 (0.90)	1,000 (1,600)	3.6 (11.8)	45 (28.0)	5.0	-
22 (0.64)	1,000 (1,600)	5.1 (17.0)	91 (56.5)	5.0	4,000
Crosstalk Loss dB/kft (dB/km)		Capacitance Unbalance @ 1,000 Hz pF @ 1 kft (pF @ 1 km)			
Minimum NEXT @ 722 kHz		44 (144)			
		Maximum Individual Pair to Pair 80 (145)			
		Maximum Individual Pair to Ground 800 (2,625)			

## PART NUMBERS AND PHYSICAL CHARACTERISTICS

Part Number	Support Size	Pair Count	AWG (mm)	Dimensions		Approx. Weight lbs/kft (kg/km)	Standard Length ft (m)	Package
				Minor in (mm)	Major in (mm)			
10-921-38	IM/G 0.095	2	19 (0.90)	0.27 (6.8)	0.51 (12.9)	73 (109)	656 (200)	Coil
10-923-38	IM/G 0.095	2	19 (0.90)	0.27 (6.8)	0.51 (12.9)	73 (109)	4,921 (1,500)	Reel
10-002-34	IM/F 0.083	2	22 (0.64)	0.22 (5.7)	0.46 (11.7)	55 (82)	600 (183)	Coil
10-503-34	IM/F 0.083	3	22 (0.64)	0.24 (6.2)	0.48 (12.3)	72 (107)	1,000 (305)	Coil
10-106-34	IM/F 0.083	6	22 (0.64)	0.30 (7.6)	0.53 (13.6)	80 (119)	3,500 (1,067)	Reel
10-206-34	IM/F 0.083	6	22 (0.64)	0.30 (7.6)	0.53 (13.6)	80 (119)	1,000 (305)	Reel
10-261-38	IM/G 0.095	6	22 (0.64)	0.30 (7.6)	0.55 (13.9)	80 (119)	492 (150)	Coil
10-262-38	IM/G 0.095	6	22 (0.64)	0.30 (7.6)	0.55 (13.9)	80 (119)	2,461 (750)	Reel
10-281-38	IM/G 0.095	12	22 (0.64)	0.38 (7.6)	0.65 (16.6)	114 (170)	410 (125)	Coil
10-284-38	IM/G 0.095	12	22 (0.64)	0.38 (7.6)	0.65 (16.6)	114 (170)	2,460 (750)	Reel
10-285-38	IM/G 0.095	12	22 (0.64)	0.38 (7.6)	0.65 (16.6)	114 (170)	8,202 (2,500)	Reel
10-102-35	IM/H 0.109	12	22 (0.64)	0.38 (7.6)	0.66 (16.7)	130 (193)	1,000 (305)	Reel
10-012-35	IM/H 0.109	12	22 (0.64)	0.38 (7.6)	0.66 (16.7)	130 (193)	250 (76)	Coil
10-212-35	IM/H 0.109	12	22 (0.64)	0.38 (7.6)	0.66 (16.7)	130 (193)	5,000 (1,524)	Reel

Contact Superior Essex for additional configurations and AWG sizes.

## PRODUCT DESCRIPTION

BDW A is a filled, double-jacketed buried wire intended for direct burial applications. Applications include distribution circuits and service entrance wires. BDW A is designed to withstand installation stresses. BDW A is filled with an ETPR compound, which completely coats each insulated conductor and fills the air space between conductors. BDW A is recommended for non-gopher areas. Each conductor is insulated with solid polyolefin in distinctive colors. The insulation of the tip conductor is marked with a stripe of the mating ring insulation color to reduce the possibility of splitting pairs during installation.

## APPLICATIONS

- Direct burial
- Distribution circuits and service entrance wires

## FEATURES

- Polyethylene inner jacket
- Polyethylene outer jacket
- Dual rip cords

## BENEFITS

- Provides additional mechanical and moisture protection
- Provides tough, flexible, protective covering that withstands exposure to sunlight, atmospheric temperatures, ground chemicals and stresses expected in standard installations
- Facilitates jacket removal

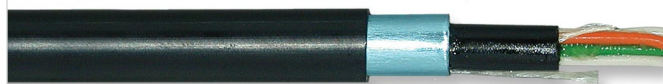

## SPECIFICATIONS

<b>Conductor</b>	Solid annealed copper
<b>Insulation</b>	Polyolefin
<b>Core Assembly</b>	Individual conductor dimensions are tightly controlled to limit resistance unbalance of twisted pairs; pair twist lays are varied to minimize crosstalk and meet capacitance unbalance limits
<b>Filling Compound</b>	Wire core is completely filled with 80°C ETPR compound, filling the air spaces between insulated conductors
<b>Inner Jacket</b>	Polyethylene
<b>Shield</b>	Smooth, copolymer-coated, 8 mil aluminum tape applied longitudinally over inner jacket and bonded to outer jacket; space under the tape is flooded to eliminate all air space
<b>Outer Jacket</b>	Black, polyethylene
<b>Standards Compliance</b>	ANSI/ICEA S-86-634-2011 RoHS-compliant

## ELECTRICAL SPECIFICATIONS

All Pairs	Average Mutual Capacitance @ 1,000 Hz nF/mile (nF/km)
Maximum Individual	94 (58)
Wire Average	83 ± 7 (52 ± 4)

Conductor Size AWG (mm)	Minimum Insulation Resistance @ 68°F (20°C) megohm-mile (megohm-km)	Maximum Average Attenuation 772 kHz @ 68°F (20°C) dB/kft (dB/km)	Maximum Conductor Resistance @ 68°F (20°C) Ohms/mile (Ohms/km)	DC Resistance Unbalance Maximum % Individual Pair	Dielectric Strength Minimum Volts DC	
					Conductor to Conductor	Conductor to Shield
19 (0.90)	1,000 (1,600)	3.1 (10.2)	45 (28.0)	5.0	7,000	20,000
22 (0.64)	1,000 (1,600)	4.4 (14.4)	91 (56.4)	5.0	5,000	20,000
24 (0.51)	1,000 (1,600)	5.5 (18.0)	144 (89.5)	5.0	4,000	20,000

Minimum NEXT @ 722 kHz	Crosstalk Loss dB/kft (dB/km)	Capacitance Unbalance @ 1,000 Hz pF @ 1 kft (pF @ 1 km)	
		Maximum Individual Pair to Pair	Maximum Individual Pair to Ground
	44 (144)	80 (145)	800 (2,625)

## PART NUMBERS AND PHYSICAL CHARACTERISTICS

Part Number	Pair Count	AWG (mm)	Nominal Diameter in (mm)	Approx. Weight lbs/kft (kg/km)	Standard Length ft (m)	Package
04-052-84	2	22 (0.64)	0.32 (8.1)	45 (65)	1,000 (305)	Reel
04-053-84	2	22 (0.64)	0.32 (8.1)	45 (65)	2,500 (762)	Reel
04-055-84	2	22 (0.64)	0.32 (8.1)	45 (65)	5,000 (1,524)	Reel
04-056-84	3	22 (0.64)	0.33 (8.4)	50 (75)	1,000 (305)	Reel
04-062-84	3	22 (0.64)	0.33 (8.4)	50 (75)	2,500 (762)	Reel
04-058-84	3	22 (0.64)	0.33 (8.4)	50 (75)	5,000 (1,524)	Reel
04-061-85	6	22 (0.64)	0.41 (10)	80 (120)	1,000 (305)	Reel
04-058-85	6	22 (0.64)	0.41 (10)	80 (120)	2,500 (762)	Reel
04-089-85	2	24 (0.51)	0.27 (6.9)	30 (45)	2,500 (762)	Reel
04-103-85	3	24 (0.51)	0.29 (7.4)	40 (60)	2,500 (762)	Reel
04-097-85	6	24 (0.51)	0.35 (8.9)	55 (80)	5,000 (1,524)	Reel

# BDW G



## SPECIFICATIONS

Conductor	Solid annealed copper
Insulation	Polyolefin
Core Assembly	Individual conductor dimensions are tightly controlled to limit resistance unbalance of twisted pairs; pair twist lays are varied to minimize crosstalk and meet capacitance unbalance limits
Filling Compound	Wire core is completely filled with 80°C ETPR compound, filling the air spaces between insulated conductors
Inner Jacket	Polyethylene
Shield	Corrugated, 5 mil gopher resistant armor applied longitudinally over the inner jacket and flooded
Outer Jacket	Black polyethylene
Standards Compliance	*RDUP 7 CFR 1755.860 (PE-86) ANSI/ICEA S-86-634-2011 RoHS-compliant

## PRODUCT DESCRIPTION

BDW G is a filled, double-jacketed buried wire intended for direct burial applications. Applications include distribution circuits and service entrance wires. All types are designed to withstand installation stresses. They are filled with an ETPR compound, which completely coats each insulated conductor and fills the air space between conductors. BDW G also provides protection from rodents or harsh environments. Each conductor is insulated with solid polyolefin in distinctive colors. The insulation of the tip conductor is marked with a stripe of the mating ring insulation color to reduce the possibility of splitting pairs during installation.

## FEATURES

- Polyethylene inner jacket
- Corrugated armor
- Polyethylene outer jacket

## BENEFITS

- Provides additional mechanical and moisture protection
- Gopher resistant
- Provides excellent mechanical protection
- Provides tough, flexible, protective covering that withstands exposure to sunlight, atmospheric temperatures, ground chemicals and stresses expected in standard installations

## ELECTRICAL SPECIFICATIONS

All Pairs		Average Mutual Capacitance @ 1,000 Hz nF/mile (nF/km)				
Maximum Individual		94 (58)				
Wire Average		83 ± 7 (52 ± 4)				

Conductor Size AWG (mm)	Minimum Insulation Resistance @ 68°F (20°C) megohm-mile (megohm-km)	Maximum Average Attenuation 772 kHz @ 68°F (20°C) dB/kft (dB/km)	Maximum Conductor Resistance @ 68°F (20°C) Ohms/mile (Ohms/km)	DC Resistance Unbalance Maximum % Individual Pair	Dielectric Strength Minimum Volts DC	
					Conductor to Conductor	Conductor to Shield
22 (0.64)	1,000 (1,600)	4.4 (14.4)	91 (56.4)	5.0	5,000	20,000
24 (0.51)	1,000 (1,600)	5.5 (18.0)	144 (89.5)	5.0	4,000	20,000

Minimum NEXT @ 722 kHz	Crosstalk Loss dB/kft (dB/km)	Capacitance Unbalance @ 1,000 Hz pF @ 1 kft (pF @ 1 km)	
		44 (144)	Maximum Individual Pair to Pair
		Maximum Individual Pair to Ground	800 (2,625)

## PART NUMBERS AND PHYSICAL CHARACTERISTICS

Part Number	Pair Count	AWG (mm)	Nominal Diameter in (mm)	Approx. Weight lbs/kft (kg/km)	Standard Length ft (m)	Package
04-052-17	2	22 (0.64)	0.32 (8.1)	55 (80)	1,000 (305)	Reel
04-053-17	2	22 (0.64)	0.32 (8.1)	55 (80)	2,500 (762)	Reel
04-055-17	2	22 (0.64)	0.32 (8.1)	55 (80)	5,000 (1,524)	Reel
04-056-17	3	22 (0.64)	0.33 (8.4)	60 (90)	1,000 (305)	Reel
04-057-17	3	22 (0.64)	0.33 (8.4)	60 (90)	2,500 (762)	Reel
04-058-17	3	22 (0.64)	0.33 (8.4)	60 (90)	5,000 (1,524)	Reel
04-067-16*	6	22 (0.64)	0.40 (10)	90 (135)	1,000 (305)	Reel
04-062-16*	6	22 (0.64)	0.40 (10)	90 (135)	2,500 (762)	Reel
04-057-16*	6	22 (0.64)	0.40 (10)	90 (135)	5,000 (1,524)	Reel
04-091-16	3	24 (0.51)	0.29 (7.4)	45 (65)	5,000 (1,524)	Reel

## PRODUCT DESCRIPTION

BW GDJ, available in 2, 3, 5 and 6-pair sizes, is intended for direct burial applications and is well-suited to withstand installation stresses. It is filled with an ETPR compound, which is chemically and electrically compatible with all other materials in the wire. The compound completely coats each insulated conductor and fills the air space between conductors. BW GDJ effectively combats attacks by rodents. It can be used for distribution circuits and service entrance wires. Each conductor is insulated with solid polyolefin distinctive colors. The insulation of the tip conductor is marked with a stripe of the mating ring insulation color to reduce the possibility of splitting pairs during installation. A black, polyvinyl chloride jacket is extruded over the armor to protect the core from minor mechanical damage, degradation by sunlight and the ingress of moisture.

### FEATURES

- Polyethylene inner jacket
- Corrugated armor
- Armor's inner and outer surfaces are flooded
- Rip cord

### BENEFITS

- Provides additional mechanical and moisture protection
- Gopher resistant
- Prevents water flow between the shield and outer jacket
- Facilitates jacket removal



## SPECIFICATIONS

<b>Conductor</b>	Solid annealed copper
<b>Insulation</b>	Polyolefin
<b>Core Assembly</b>	Conductors are twisted into pairs in a manner designed to minimize resistance unbalance; pair twist lays are varied to minimize crosstalk
<b>Filling Compound</b>	Wire core is completely filled with 80°C ETPR compound, filling the air spaces between insulated conductors
<b>Inner Jacket</b>	Polyethylene inner jacket; outer surface flooded
<b>Armor</b>	Corrugated armor applied longitudinally over the inner jacket; inner and outer surfaces of the armor are flooded
<b>Rip cord</b>	Rip cord is applied beneath the inner jacket; a second rip cord can also be applied under the outer jacket
<b>Jacket</b>	Weather resistant PVC
<b>Standards Compliance</b>	Telcordia® GR-3163-CORE ANSI/ICEA S-86-634-2011 RoHS-compliant

Telcordia is a registered trademark of Ericsson Inc.

## ELECTRICAL SPECIFICATIONS

All Pairs		Average Mutual Capacitance @ 1,000 Hz nF/mile (nF/km)					
Maximum Pair		94 (58)					
Maximum Average		90 (56)					
Conductor Size AWG (mm)	Minimum Insulation Resistance @ 68°F (20°C) megohm-mile (megohm-km)	Maximum Average Attenuation 772 kHz @ 68°F (20°C) dB/kft (dB/km)	Maximum Conductor Resistance @ 68°F (20°C) Ohms/mile (Ohms/km)	DC Resistance Unbalance Maximum % Individual Pair	Dielectric Strength Minimum Volts DC		
					Conductor to Conductor	Conductor to Shield	
19 (0.90)	1,000 (1,600)	3.1 (11)	45 (28.0)	5.0	7,000	20,000	
22 (0.64)	1,000 (1,600)	4.4 (14)	91 (56.5)	5.0	5,000	20,000	

Crosstalk Loss dB/kft (dB/km)		Capacitance Unbalance @ 1,000 Hz pF @ 1 kft (pF @ 1 km)	
Minimum NEXT @ 722 kHz	44 (144)	Maximum Individual Pair to Pair	80 (145)
		Maximum Individual Pair to Ground	800 (2,625)

## PART NUMBERS AND PHYSICAL CHARACTERISTICS

Part Number	Pair Count	AWG (mm)	Nominal Diameter in (mm)	Approx. Weight lbs/kft (kg/km)	Standard Length ft (m)	Package
25-020-79	2	19 (0.90)	0.37 (9.4)	80 (119)	900 (275)	Reel
25-021-79	2	19 (0.90)	0.37 (9.4)	80 (119)	7,000 (2,135)	Reel
25-063-79	2	22 (0.64)	0.37 (9.4)	80 (119)	600 (183)	Coil
25-064-79	2	22 (0.64)	0.37 (9.4)	80 (119)	5,000 (1,524)	Reel
25-355-79	3	22 (0.64)	0.33 (8.4)	70 (104)	600 (183)	Reel
25-360-79	3	22 (0.64)	0.33 (8.4)	70 (104)	1,200 (366)	Reel
25-354-79	3	22 (0.64)	0.33 (8.4)	70 (104)	3,000 (915)	Reel
25-552-79	5	22 (0.64)	0.38 (9.0)	90 (134)	500 (152)	Coil
25-555-79	5	22 (0.64)	0.38 (9.0)	90 (134)	1,000 (305)	Reel
25-547-79	5	22 (0.64)	0.38 (9.0)	90 (134)	2,000 (610)	Reel
25-553-79	5	22 (0.64)	0.38 (9.0)	90 (134)	5,000 (1,524)	Reel
25-681-79	6	22 (0.64)	0.40 (10.0)	100 (149)	800 (244)	Reel
25-654-79	6	22 (0.64)	0.40 (10.0)	100 (149)	350 (107)	Coil
25-662-79	6	22 (0.64)	0.40 (10.0)	100 (149)	1,000 (305)	Reel
25-663-79	6	22 (0.64)	0.40 (10.0)	100 (149)	2,000 (610)	Reel
25-653-79	6	22 (0.64)	0.40 (10.0)	100 (149)	3,000 (915)	Reel



# Off The Reel

SUPERIOR ESSEX BI-MONTHLY E-NEWSLETTER

Sign up for the Superior Essex e-newsletter and receive a comprehensive bi-monthly snapshot of the latest news from Superior Essex and around the industry, all delivered to your e-mail.

Register online today at  
**[SuperiorEssexCommunications.com/News/Newsletters](http://SuperiorEssexCommunications.com/News/Newsletters)**



800.551.8948

[SuperiorEssexCommunications.com](http://SuperiorEssexCommunications.com)

All information, content, data, specifications, packaging and part numbers detailed herein are subject to change. For the most up-to-date information, please visit [SuperiorEssexCommunications.com](http://SuperiorEssexCommunications.com). Purchase of this product is subject exclusively to the then current Superior Essex International LP Terms and Conditions of Sale for Communications Cable, Wire and Connectivity Products, which can be found on our website, [SuperiorEssexCommunications.com](http://SuperiorEssexCommunications.com), or provided to you upon request.



## PRODUCT DESCRIPTION

The Buried Wire Aluminum Filled (BW AF) cable is designed for direct burial applications and is available in 2, 3, 5 and 6 pair sizes. It is filled with an ETPR compound which is chemically and electrically compatible with all other materials in the wire. The compound completely coats each insulated conductor and fills the space between conductors. BW AF can also be used for distribution circuits and service entrance wires. Each conductor is insulated with solid polyolefin in distinctive colors. The insulation of the tip conductor is marked with a stripe of the mating ring insulation color to reduce the possibility of splitting pairs during installation. A black, weather-resistant polyvinyl chloride jacket is extruded over the shield and rip cord to protect the core from minor mechanical damage, degradation by sunlight and ingress of moisture and water.

### FEATURES

- Non-hygroscopic core wrap
- Adhesive compound floods shield's outer surface
- Rip cord

### BENEFITS

- Protects the core and provides improved mechanical and electrical characteristics
- Provides a moisture barrier and inhibits corrosion
- Facilitates jacket removal



## SPECIFICATIONS

<b>Conductor</b>	Solid annealed copper
<b>Insulation</b>	Polyolefin
<b>Core Assembly</b>	Individual conductor dimensions are tightly controlled to limit resistance unbalance of twisted pairs; pair twist lays are varied to minimize crosstalk and meet capacitance unbalance limits
<b>Core Covering</b>	Non-hygroscopic core wrap
<b>Filling Compound</b>	Wire core is completely filled with 80°C ETPR compound, filling the spaces between insulated conductors
<b>Shield</b>	Corrugated 6-mil (2-pair/3-pair) or 8 mil (5-pair/6-pair) bare aluminum tape longitudinally applied over the core wrap
<b>Rip cord</b>	Rip cord applied over shield and beneath jacket
<b>Jacket</b>	Weather-resistant PVC
<b>Standards Compliance</b>	Telcordia® GR-3163-CORE ANSI/ICEA S-86-634-2011 RoHS-compliant

Telcordia is a registered trademark of Ericsson Inc.

## ELECTRICAL SPECIFICATIONS

Conductor Size AWG (mm)	Minimum Insulation Resistance @ 68°F (20°C) megohm-mile (megohm-km)	Maximum Average Attenuation 772 kHz @ 68°F (20°C) dB/kft (dB/km)	Maximum Conductor Resistance @ 68°F (20°C) Ohms/mile (Ohms/km)	DC Resistance Unbalance Maximum % Individual Pair	Dielectric Strength Minimum Volts DC	
					Conductor to Conductor	Conductor to Shield
22 (0.64)	1,000 (1,600)	4.4 (14)	91 (56.5)	5.0	5,000	15,000
All Pairs		Average Mutual Capacitance @ 1,000 Hz nF/mile (nF/km)	Crosstalk Loss dB/kft (dB/km)		Capacitance Unbalance @ 1,000 Hz pF @ 1 kft (pF @ 1 km)	
Maximum Pair	94 (58)		Minimum NEXT @ 722 kHz	44 (144)	Maximum Individual Pair to Pair	80 (145)
Maximum Average	90 (56)			Maximum Individual Pair to Ground	800 (2,625)	

## PART NUMBERS AND PHYSICAL CHARACTERISTICS

Part Number	Pair Count	AWG (mm)	Nominal Diameter in (mm)	Approx. Weight lbs/kft (kg/km)	Standard Length ft (m)	Package
25-063-86	2	22 (0.64)	0.27 (6.9)	43 (64)	250 (76)	Coil
25-062-86	2	22 (0.64)	0.27 (6.9)	43 (64)	700 (214)	Coil
25-257-86	2	22 (0.64)	0.27 (6.9)	43 (64)	1,250 (381)	Coil (IPL)
25-069-86	2	22 (0.64)	0.27 (6.9)	43 (64)	1,300 (396)	Reel
25-061-86	2	22 (0.64)	0.27 (6.9)	43 (64)	1,500 (457)	Reel
25-064-86	2	22 (0.64)	0.27 (6.9)	43 (64)	3,000 (915)	Reel
25-078-86	2	22 (0.64)	0.27 (6.9)	43 (64)	8,250 (2,154)	Reel
25-351-86	3	22 (0.64)	0.30 (7.6)	53 (79)	500 (152)	Coil
25-360-86	3	22 (0.64)	0.30 (7.6)	53 (79)	1,200 (366)	Reel
25-353-86	3	22 (0.64)	0.30 (7.6)	53 (79)	3,000 (914)	Reel
25-154-86	5	22 (0.64)	0.33 (8.4)	67 (100)	500 (152)	Coil
25-554-86	5	22 (0.64)	0.33 (8.4)	67 (100)	925 (282)	Coil (IPL)
25-530-86	5	22 (0.64)	0.33 (8.4)	67 (100)	300 (92)	Reel
25-527-86	5	22 (0.64)	0.33 (8.4)	67 (100)	900 (274)	Reel
25-525-86	5	22 (0.64)	0.33 (8.4)	67 (100)	925 (282)	Reel
25-549-86	5	22 (0.64)	0.33 (8.4)	67 (100)	5,500 (1,676)	Reel
25-667-86	6	22 (0.64)	0.37 (9.4)	81 (120)	600 (182)	Coil
25-680-86	6	22 (0.64)	0.37 (9.4)	81 (120)	700 (213)	Reel
25-685-86	6	22 (0.64)	0.37 (9.4)	81 (120)	1,200 (366)	Reel
25-654-86	6	22 (0.64)	0.37 (9.4)	81 (120)	2,500 (762)	Reel
25-682-86	6	22 (0.64)	0.37 (9.4)	81 (120)	4,000 (1,219)	Reel

# Non-Jacketed Tight Twist Cable Core



## PRODUCT DESCRIPTION

This Non-jacketed Cable Core is designed for use on the back side of cross connect and terminal blocks located in a cross connect cabinet adjacent to the remote terminal. Without a jacket this product must always be utilized in a cabinet, enclosure or indoors. These products offer enhanced crosstalk performance in a 100 Ohm design for supporting digital subscriber line (xDSL) technologies and higher IPTV data speeds.

## FEATURES

- 24 AWG solid copper conductors
- Polyolefin insulation
- Pairing tight twist (CAT 5 like twists)
- Standard telephony solid colors
- No outer jacket
- Binder strings

## BENEFITS

- Ideal for terminal block stubs
- Greater crush resistance and improved transmission characteristics
- Enhanced capabilities for xDSL signals
- Easy conductor identification
- Easy routing
- Holds pair groups together

## SPECIFICATIONS

Standards Compliance	RoHS-compliant
----------------------	----------------

## PART NUMBERS AND PHYSICAL CHARACTERISTICS

Part Number	Pair Count	AWG (mm)	Nominal Diameter in (mm)	Approx. Weight lbs/kft (kg/km)	Standard Length ft (m)	Package
11-003-53	25	24 (0.51)	0.41 (10)	82 (122)	5,000 (1,524)	Reel
11-003-45	50	24 (0.51)	0.57 (14)	164 (244)	5,000 (1,524)	Reel
11-003-46	100	24 (0.51)	0.82 (21)	328 (488)	5,000 (1,524)	Reel

# Air Pipe



## PRODUCT DESCRIPTION

Air Pipe is used for supplying air pressure to underground pressurized cable systems. Air pressure is distributed off the air pipe at regular intervals and applied to pressurized cables to supplement and boost air pressure along the cable route. It is normally placed in ducts. The laminated aluminum and polyethylene construction assures water vapor will not penetrate to the pipe interior.

## SPECIFICATIONS

Shield	4 mil aluminum tape formed longitudinally with bonded overlap
Jacket	Black, medium density polyethylene jacket extruded over and laminated to the aluminum shield
Fitting Size in (mm)	½ (12.7)
Standards Compliance	RoHS-compliant

## PART NUMBERS AND PHYSICAL CHARACTERISTICS

Part Number	Outer Nominal Diameter in (mm)	Inner Nominal Diameter in (mm)	Approx. Weight lbs/kft (kg/km)	Package
85-019-25	0.71 (18)	0.59 (15)	56 (83)	1,980 m Reel
85-018-25	0.71 (18)	0.59 (15)	56 (83)	6,500' Reel

# Bridle Wire

## PRODUCT DESCRIPTION

Bridle Wire is used to extend the telephone circuit from aerial distribution cable terminals to building entrance protectors or network interface units on subscriber premises. This wire has a black PVC jacket with a rip cord for easy access to conductors.

## FEATURES

- PVC jacket

## BENEFITS

- Provides a tough flexible protective covering that withstands exposure to sunlight and stresses encountered in standard installations



## SPECIFICATIONS

Conductor	Solid annealed copper
Insulation	Color coded, solid, polyolefin tip conductors are striped with mating color for positive identification
Jacket	PVC
Standards Compliance	RoHS-compliant

## PART NUMBERS AND PHYSICAL CHARACTERISTICS

Part Number	Pair Count	AWG (mm)	Nominal Diameter in (mm)	Approx. Weight lbs/kft (kg/km)	Package
12-262-01	2	22 (0.64)	0.19 (4.8)	19 (28)	600' POP™ box
12-642-01	6	22 (0.64)	0.27 (6.9)	42 (63)	450' Coil
12-842-01	12	22 (0.64)	0.33 (8.4)	73 (109)	250' Coil

# Temporary Drop Wire

TDW

## PRODUCT DESCRIPTION

Safety orange colored Temporary Non-shielded Drop Wire intended to temporarily extend or replace service.



## SPECIFICATIONS

Conductor	Solid bare copper
Insulation	Polyolefin
Jacket	PVC
Jacket Color	Bright Orange
Standards Compliance	RoHS-compliant

## PART NUMBERS AND PHYSICAL CHARACTERISTICS

Part Number	Pair Count	AWG (mm)	Wire Color	Nominal Diameter in (mm)	Approx. Weight lbs/kft (kg/km)	Package
12-311-36	2	22 (0.64)	Red/Green, Black/Yellow	0.14 (3.6)	13 (19)	1,000' POP™ box
12-331-36	1	24 (0.51)	Red/Green	0.13 (3.3)	7 (10)	2,000' POP box
12-322-36	2*	24 (0.51)	Red/Green	0.13 (3.3)	7 (10)	2,000' POP box

\*Note: 2 conductors, not a pair.

# E-Block Wire

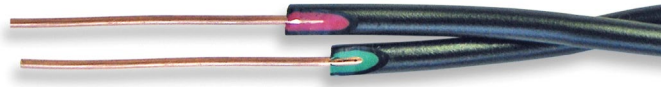

## SPECIFICATIONS

Conductor	Copper covered steel
Dual Insulation	Inner layer: color coded PVC Outer layer: black PVC
Standards Compliance	TR-TSY-000127 UL® 83 VW1 RoHS-compliant

UL is a registered trademark of UL LLC.

## PRODUCT DESCRIPTION

E-Block Wire is used for "ring wiring" of buildings and as a fusible link for aerial distribution. E-Block Wire is available in twisted pair and quad forms. It consists of copper clad steel conductors. Each conductor is dual insulated with a color coded inner layer of PVC and a black outer layer of PVC.

## PART NUMBERS AND PHYSICAL CHARACTERISTICS

Part Number	Style	AWG (mm)	Nominal Diameter in (mm)	Approx. Weight lbs/kft (kg/km)	Standard Length ft (m)	Package
12-140-03	Pair	20 (0.13)	0.20 (5.1)	14 (20)	400 (122)	Knock-out box
12-220-03	Quad	20 (0.13)	0.24 (6.1)	32 (47)	250 (76)	Knock-out box

# Ground Wire

Bare or Jacketed

## PRODUCT DESCRIPTION

Ground Wire is used specifically to ground electrical devices and to maintain shield continuity at cable splices.

The wire is intended for use in accordance with Article 800.100, of the National Electrical Code.



## SPECIFICATIONS

Conductor	Solid annealed copper
Insulation	Weather-resistant PVC
Performance Compliance	General Use - 300 Volt Communication RoHS-compliant
NRTL Programs	UL® Listed

## PART NUMBERS AND PHYSICAL CHARACTERISTICS

Part Number	AWG	Jacket Color	Nominal Diameter in (mm)	Approx. Weight lbs/kft (kg/km)	Package
12-001-04	6	Black	0.22 (5.6)	91 (135)	500' Plywood spool
12-101-04	6	Gray	0.22 (5.6)	91 (135)	200' Boxed coil
12-102-04	6	Gray	0.22 (5.6)	91 (135)	200' Coil
12-103-04	6	Gray	0.22 (5.6)	91 (135)	200' Plastic spool
12-106-04	6	Gray	0.22 (5.6)	91 (135)	500' Boxed coil
12-107-04	6	Gray	0.22 (5.6)	91 (135)	600' Coil
12-104-04	6	Gray	0.22 (5.6)	91 (135)	4,000' Reel
12-018-04	6	Green	0.22 (5.6)	91 (135)	500' Reel
12-905-04	6	Bare	0.16 (4.1)	79 (118)	600' Plastic spool
12-901-04	6	Bare	0.16 (4.1)	79 (118)	200' Boxed coil
12-906-04	6	Bare	0.16 (4.1)	79 (118)	200' Coil
12-903-04	6	Bare	0.16 (4.1)	79 (118)	300' Plastic spool
12-910-04	6	Bare	0.16 (4.1)	79 (118)	315' Plastic spool
12-904-04	6	Bare	0.16 (4.1)	79 (118)	4,000' Reel
12-111-04	10	Gray	0.14 (3.6)	37 (55)	200' Boxed coil
12-112-04	10	Gray	0.14 (3.6)	37 (55)	500' Boxed coil
12-011-04	10	Black	0.14 (3.6)	37 (55)	500' Knock-out box
12-012-04	10	Black	0.14 (3.6)	37 (55)	500' Spool
12-016-04	10	Green	0.14 (3.6)	37 (55)	500' Plastic spool
12-121-04	12	Gray	0.12 (3.0)	25 (37)	200' Boxed coil
12-122-04	12	Gray	0.12 (3.0)	25 (37)	300' Boxed coil

## SPECIFICATIONS

Conductor	30% Copper and steel
Insulation	Weather-resistant PVC
Performance Compliance	General Use - 300 Volt Communication RoHS-compliant

## PART NUMBERS AND PHYSICAL CHARACTERISTICS

Part Number	AWG	Jacket Color	Nominal Diameter in (mm)	Approx. Weight lbs/kft (kg/km)	Package
12-607-0B	17	Black	0.091 (2.3)	8.7 (12.99)	500' Plastic spool

# Cross-Connect Category 5 Wire

XCW



## PRODUCT DESCRIPTION

Cross-Connect Category 5 Wire is designed with a tighter twist to support higher data speeds and is intended for connections in cross connect cabinets.

## SPECIFICATIONS

Conductor	Solid bare copper
Insulation	Flame retardant PVC insulated conductor each identified by a solid color
Performance Compliance	UL® 444 CSA C22.2 No. 214-08 RoHS-compliant
NRTL Programs	UL, c(UL) Listed CM

UL is a registered trademark of UL LLC.

## PART NUMBERS AND PHYSICAL CHARACTERISTICS

Part Number	Pair Count	AWG (mm)	Wire Color	Nominal Diameter in (mm)	Approx. Weight lbs/kft (kg/km)	Package
02-360-23	1	22 (0.64)	White/Red	0.07 (1.8)	5 (7)	400' Spool
02-361-23	1	22 (0.64)	White/Violet	0.07 (1.8)	5 (7)	400' Spool
02-362-23	1	22 (0.64)	Violet/Blue	0.07 (1.8)	5 (7)	400' Spool
02-011-23	1	24 (0.51)	White/Blue	0.08 (2.0)	5 (7)	1,000' Spool
02-010-23	1	24 (0.51)	White/Green	0.08 (2.0)	5 (7)	1,000' Spool
02-031-23	1	24 (0.51)	Yellow/Red	0.08 (2.0)	5 (7)	1,000' Spool
02-032-23	1	24 (0.51)	Violet/Blue	0.08 (2.0)	5 (7)	1,000' Spool
02-111-23	1	24 (0.51)	White/Blue	0.08 (2.0)	5 (7)	6,000' Spool
02-131-23	1	24 (0.51)	Yellow/Red	0.08 (2.0)	5 (7)	6,000' Spool
02-050-23	1	24 (0.51)	White/Orange	0.08 (2.0)	5 (7)	1,000' Spool
02-006-23	1	24 (0.51)	White/Red	0.08 (2.0)	5 (7)	1,000' Spool
02-211-23	1	24 (0.51)	White/Blue	0.08 (2.0)	5 (7)	6,000' Spool
02-033-23	1	24 (0.51)	Yellow/Blue	0.08 (2.0)	5 (7)	1,000' Spool
02-110-23	1	24 (0.51)	White/Green	0.08 (2.0)	5 (7)	6,000' Spool
02-132-23	1	24 (0.51)	Violet/Blue	0.08 (2.0)	5 (7)	6,000' Spool
11-005-90	1	24 (0.51)	Violet/Blue	0.08 (2.0)	5 (7)	500' Spool
02-350-23	1	24 (0.51)	White/Orange	0.08 (2.0)	5 (7)	400' Spool
02-311-23	1	24 (0.51)	White/Blue	0.08 (2.0)	5 (7)	500' Spool
02-020-23	2	24 (0.51)	White/Blue, White/Orange	0.12 (3.0)	5 (7)	1,000' Spool
02-021-23	2	24 (0.51)	Red/Blue, Red/Orange	0.12 (3.0)	5 (7)	1,000' Spool
02-022-23	2	24 (0.51)	White/Orange, White/Green	0.12 (3.0)	5 (7)	1,000' Spool
02-024-23	2	24 (0.51)	Violet/Blue, Violet/Orange	0.12 (3.0)	5 (7)	1,000' Spool

# Indoor/Outdoor Cross-Connect Wire

XCW

## PRODUCT DESCRIPTION

Indoor/Outdoor Cross-Connect Wire is intended for cross-connecting points in building entrance enclosures at subscriber's premises and/or in Outside Plant (OSP) enclosures. Each insulated conductor is identified by a combination of solid insulation color, except as noted.

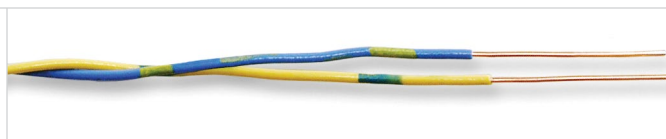

## SPECIFICATIONS

<b>Conductor</b>	Solid bare copper
<b>Insulation</b>	Semi-rigid PVC
<b>Standards Compliance</b>	UL® 444 CSA C22.2 No. 214-08 RoHS-compliant
<b>NRTL Programs</b>	UL, c(UL) Listed CM

UL is a registered trademark of UL LLC.

## PART NUMBERS AND PHYSICAL CHARACTERISTICS

Part Number	Pair Count	AWG (mm)	Wire Color	Individual Nominal Diameter in (mm)	Overall Nominal Diameter in (mm)	Approx. Weight lbs/kft (kg/km)	Standard Length ft (m)	Package
02-111-13	1	22 (0.64)	White/Blue	0.036 (0.9)	0.07 (1.8)	4 (9)	1,000 (305)	Spool
02-102-13	1	22 (0.64)	Yellow/Blue	0.036 (0.9)	0.07 (1.8)	4 (9)	1,000 (305)	Spool
02-113-13	1	22 (0.64)	White/Red	0.036 (0.9)	0.07 (1.8)	4 (9)	1,000 (305)	Spool
02-114-13	1	22 (0.64)	White/Black	0.036 (0.9)	0.07 (1.8)	4 (9)	1,000 (305)	Spool
02-513-13*	1	22 (0.64)	White/Red	0.036 (0.9)	0.07 (1.8)	4 (9)	1,000 (305)	Spool
02-514-13*	1	22 (0.64)	White/Black	0.036 (0.9)	0.07 (1.8)	4 (9)	1,000 (305)	Spool
02-120-13	2	22 (0.64)	White/Blue, White/Orange	0.036 (0.9)	0.11 (2.8)	9 (20)	1,000 (305)	Spool
02-H12-13	1	22 (0.64)	White/Violet	0.036 (0.9)	0.07 (1.8)	3 (7)	400 (122)	Spool
02-G11-13	1	22 (0.64)	White/Blue	0.036 (0.9)	0.07 (1.8)	3 (7)	400 (122)	Spool
02-G50-13	1	22 (0.64)	White/Orange	0.036 (0.9)	0.07 (1.8)	3 (7)	400 (122)	Spool
02-H13-13	1	22 (0.64)	Red/White	0.036 (0.9)	0.07 (1.8)	3 (7)	400 (122)	Spool
02-G16-13	1	22 (0.64)	Violet/Blue	0.036 (0.9)	0.07 (1.8)	3 (7)	400 (122)	Spool
02-706-13*	1	24 (0.51)	White/Red	0.036 (0.9)	0.07 (1.8)	3 (7)	1,000 (305)	Spool
02-001-13	1	24 (0.51)	White/Blue	0.036 (0.9)	0.07 (1.8)	3 (7)	1,000 (305)	Spool
02-050-13	1	24 (0.51)	White/Orange	0.036 (0.9)	0.07 (1.8)	3 (7)	1,000 (305)	Spool
02-E12-13	1	24 (0.51)	White/Orange	0.036 (0.9)	0.07 (1.8)	3 (7)	1,000 (305)	Spool
02-006-13	1	24 (0.51)	White/Red	0.036 (0.9)	0.07 (1.8)	3 (7)	1,000 (305)	Spool
02-D06-13	1	24 (0.51)	White/Red	0.036 (0.9)	0.07 (1.8)	3 (7)	600 (183)	Spool
02-053-13	1	24 (0.51)	Red/Blue	0.036 (0.9)	0.07 (1.8)	3 (7)	1,000 (305)	Spool
02-004-13	1	24 (0.51)	Red/Green	0.036 (0.9)	0.07 (1.8)	3 (7)	1,000 (305)	Spool
02-005-13	1	24 (0.51)	Red/Slate	0.036 (0.9)	0.07 (1.8)	3 (7)	1,000 (305)	Spool
02-054-13	1	24 (0.51)	Red/Black	0.036 (0.9)	0.07 (1.8)	3 (7)	1,000 (305)	Spool
02-702-13*	1	24 (0.51)	Red/Black	0.036 (0.9)	0.07 (1.8)	3 (7)	1,000 (305)	Spool
02-002-13	1	24 (0.51)	Yellow/Blue	0.036 (0.9)	0.07 (1.8)	3 (7)	1,000 (305)	Spool
02-409-13	1	24 (0.51)	Blue/Black	0.036 (0.9)	0.07 (1.8)	3 (7)	3,000 (915)	Spool
02-401-13	1	24 (0.51)	White/Blue	0.036 (0.9)	0.07 (1.8)	3 (7)	3,000 (915)	Spool
02-450-13	1	24 (0.51)	White/Orange	0.036 (0.9)	0.07 (1.8)	3 (7)	3,000 (915)	Spool
02-051-13	1	24 (0.51)	White/Green	0.036 (0.9)	0.07 (1.8)	3 (7)	1,000 (305)	Spool
02-052-13	1	24 (0.51)	White/Black	0.036 (0.9)	0.07 (1.8)	3 (7)	1,000 (305)	Spool
02-006-13	1	24 (0.51)	White/Red	0.036 (0.9)	0.07 (1.8)	3 (7)	1,000 (305)	Spool
02-D02-13	1	24 (0.51)	Yellow/Blue	0.036 (0.9)	0.07 (1.8)	3 (7)	600 (183)	Spool
02-222-13	2	24 (0.51)	White/Blue, White/Orange	0.036 (0.9)	0.10 (2.5)	6 (13)	1,000 (305)	Spool
02-221-13	2	24 (0.51)	Red/Blue, Red/Orange	0.036 (0.9)	0.10 (2.5)	6 (13)	1,000 (305)	Spool
02-224-13	2	24 (0.51)	Yellow/Blue, Yellow/Orange	0.036 (0.9)	0.10 (2.5)	6 (13)	1,000 (305)	Spool
02-223-13	2	24 (0.51)	White/Orange, White/Green	0.036 (0.9)	0.10 (2.5)	6 (13)	1,000 (305)	Spool
02-032-13	3	24 (0.51)	White/Blue, White/Orange, White/Green	0.036 (0.9)	0.12 (3.0)	9 (20)	1,000 (305)	Spool
02-D30-13	3	24 (0.51)	White/Blue, White/Orange, White/Green	0.036 (0.9)	0.12 (3.0)	9 (20)	600 (183)	Spool
02-041-13	4	24 (0.51)	White/Blue, White/Orange, White/Green, White/Brown	0.036 (0.9)	0.15 (3.8)	13 (29)	1,000 (305)	Spool

\*Solid color (not band marked)



800.551.8948

[SuperiorEssexCommunications.com](http://SuperiorEssexCommunications.com)

All information, content, data, specifications, packaging and part numbers detailed herein are subject to change. For the most up-to-date information, please visit [SuperiorEssexCommunications.com](http://SuperiorEssexCommunications.com). Purchase of this product is subject exclusively to the then current **Superior Essex International LP Terms and Conditions of Sale for Communications Cable, Wire and Connectivity Products**, which can be found on our website, [SuperiorEssexCommunications.com](http://SuperiorEssexCommunications.com), or provided to you upon request.



## RF FEEDER CABLE AND JUMPERS

LHF Series Low Loss High Flexible Foam Dielectric Feeder	D-2
LHF Series (Ultimate High Performance)	
Ultimate Low Loss High Flexible Foam Dielectric Feeder	D-4
HFSC Series Super Flexible Foam Dielectric Feeder	D-5
Fiber-to-the-Antenna (FTTA)	D-6
RF Jumper Cable	D-7

## RF CONNECTORS

DIN Series for LHF	D-8
DIN Series for HFSC	D-9
N Series for LHF	D-10
N Series for HFSC	D-11

## IN-BUILDING WIRELESS CABLE AND JUMPERS

DAS Hybrid Fiber + Copper	D-12
DAS Hybrid, Interlock Armored Fiber + Copper	D-13
LHF Riser Low Loss High Flexible Foam Dielectric Feeder	D-14
LHF Plenum Low Loss High Flexible Air Dielectric Feeder	D-15
HFSC Riser Super Flexible Foam Dielectric Feeder	D-16
HFSC Plenum Super Flexible Air Dielectric Feeder	D-17
HFAC Riser Low Loss High Flexible Foam Dielectric Feeder	D-18
HFAC Plenum Low Loss High Flexible Air Dielectric Feeder	D-19
DAS Riser Jumper Cable	D-20
DAS Plenum Jumper Cable	D-21

## IN-BUILDING WIRELESS CONNECTORS

DIN Series for LHF	D-22
DIN Series for HFSC	D-23
DIN Series for HFAC	D-24
N Series for LHF	D-25
N Series for HFSC	D-26
N Series for HFAC	D-27

## WIRELESS ACCESSORIES

Cable Preparation Tools	D-28
Cushion and Boot Assembly Kit	D-29
Universal Weatherproofing Kit	D-30
Hoisting Grip Lace-Up and Pre-Laced	D-31
Clip-On Grounding Kit	D-32
Universal Snap-in Hanger Kit	D-33
Stackable Snap-in Hanger Kit	D-34
Standard Hanger Kit	D-35
$\lambda/4$ Wave Surge Arrestor	D-36
Gas Tube Surge Arrestor	D-37
Round Adapter Kit	D-38
Stand-Off Adapter Kit	D-39
Three-Way Stand-Off Adapter Kit	D-40
Angle Adapter Kit	D-40
Ground Bus Bar Kit	D-41
Weather Proofing Shell	D-42
Anti-Theft Hardware Kit	D-43

# LHF Series

Low Loss High Flexible Foam Dielectric Feeder



LHF-12D



LHF-33D

## PRODUCT DESCRIPTION

LHF Series cables are low loss 50 Ohm cables featuring a foamed polyethylene dielectric, annularly corrugated copper shield and polyethylene jacket.

## FEATURES

- Low attenuation
- Low passive intermodulation
- Easy connectorization
- Factory tested and inspected
- Rugged and durable

## BENEFITS

- Suitable for long cable runs
- Outperforms the industry requirements for low passive intermodulation
- Full line of high-quality low intermodulation DIN and N connectors and cable preparation tools minimize installation time and expenses
- 100% of all RF cables are inspected and tested to meet or exceed industry specifications including passive intermodulation
- High-quality materials result in rugged cables that are able to withstand extreme environments without corrosion

## SPECIFICATIONS

Inner Conductor	LHF-12D: Copper-clad aluminum wire LHF-33D: Smooth copper tube
Dielectric	Foamed polyethylene
Outer Conductor	Annularly corrugated copper tube
Jacket	Black polyethylene
Recommended Operating Temperature °F (°C)	-40 to +185 (-40 to +80)

## PART NUMBERS AND PHYSICAL CHARACTERISTICS

Part Number	Cable Size in (mm)	Nominal Diameter in (mm)				Minimum Bend Radius in (mm)	Approx. Weight lbs/kft (kg/km)	Flat Plate Crush Resistance lbs/in (kg/mm)	Maximum Pulling Force lbs (kg)
		Inner Conductor	Dielectric	Outer Conductor	Jacket				
LHF-12D	½ (12)	0.20 (5.0)	0.49 (12.5)	0.56 (14.2)	0.65 (16.4)	4.92 (125)	163 (244)	112 (2.0)	249 (113)
LHF-33D	1¼ (33)	0.54 (13.7)	1.32 (33.6)	1.43 (36.4)	1.55 (39.4)	14.96 (380)	613 (915)	134 (2.4)	572 (260)

## ELECTRICAL SPECIFICATIONS

Part Number	Cable Size in (mm)	Conductor DC Resistance Ohms/kft (Ohms/km)		Insulation Resistance mΩ km	Dielectric Strength for 1 minute DC Potential - Volts	Velocity of Propagation %	Peak Power Rating kW	Maximum Operating Frequency GHz	Characteristic Impedance Ohms	Typical Return Loss dB
		Inner	Outer							
LHF-12D	½ (12)	0.5 (1.6)	0.6 (1.9)	10,000	4,000	89	40	8.8	50	28
LHF-33D	1¼ (33)	0.3 (1.1)	0.3 (1.0)	10,000	10,000	89	200	3.3	50 ± 1	28

Frequency MHz	Attenuation at 20°C dB/100 ft (dB/100 m)		Average Power Rating at Ambient 40°C Inner Conductor 100°C kW	
	LHF-12D	LHF-33D	LHF-12D	LHF-33D
30	0.35 (1.14)	0.13 (0.42)	6.10	21.30
100	0.65 (2.12)	0.24 (0.49)	3.32	11.50
150	0.79 (2.60)	0.30 (0.98)	2.71	9.32
450	1.40 (4.58)	0.54 (1.77)	1.55	5.23
824	1.92 (6.31)	0.76 (2.49)	1.13	3.78
894	2.00 (6.55)	0.80 (2.61)	1.09	3.61
960	2.08 (6.84)	0.83 (2.72)	1.05	3.48
1,000	2.13 (7.00)	0.85 (2.79)	1.03	3.40
1,700	2.84 (9.32)	1.17 (3.84)	0.78	2.53
1,800	2.93 (9.61)	1.21 (3.97)	0.76	2.45
2,000	3.11 (10.19)	1.30 (4.25)	0.71	2.31
2,400	3.38 (11.10)	1.44 (4.73)	0.65	2.09
2,700	3.81 (12.53)	1.56 (5.11)	0.61	1.95
3,000	3.95 (12.96)	1.66 (5.43)	0.58	1.84

Frequency MHz	VSWR	
	LHF-12D	LHF-33D
800-960	1.15	1.15
1,700-2,200	1.15	1.15

Standard Conditions: VSWR 1.0,  
Ambient Temperature 20°C/Attenuation is typical value.

# Multiple Coax Solutions for a High Performing DAS

Three coaxial cable solutions for Distributed Antenna Systems

**LHF**  
Copper Shielded  
Lowest Loss  
**Performance**

**HFSC**  
Copper Shielded  
Highest Flexibility  
**Flexibility**

**HFAC**  
Aluminum Shielded  
Lowest Cost  
**Value**

**PLENUM**  
ETL UL 910 RATED CMP

LHF-12DP

HFSC-12DP

HFAC-12DP

**RISER**  
ETL UL 1666 RATED CMR

LHF-12DR

HFSC-12DR

HFAC-12DR

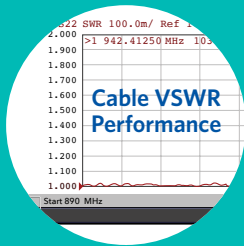

## Industry-Leading Electricals

- Low attenuation across 30 MHz to 4,000 MHz
- Low Voltage Standing Wave Ratio (VSWR) <1.25 dB guaranteed across frequency bands (<1.1 dB typical)
- Low Passive Intermodulation (PIM) < -155 dBc



## Superior Construction

- Precision-welded, solid annular outer conductor eliminates intermodulation
- Continuous dielectric spine provides homogenous support of outer conductor and maintains electrical performance in tight bends



## Industry's Highest Safety Ratings

- Industry's highest rating of UL<sup>®</sup> 444 for in-building fire safety
- Plenum cables are ETL certified CMP using UL 910
- Riser cable is ETL certified CMR using UL1666

UL is a registered trademark of UL LLC.

# LHF Series (Ultimate High Performance)

Ultimate Low Loss High Flexible Foam Dielectric Feeder

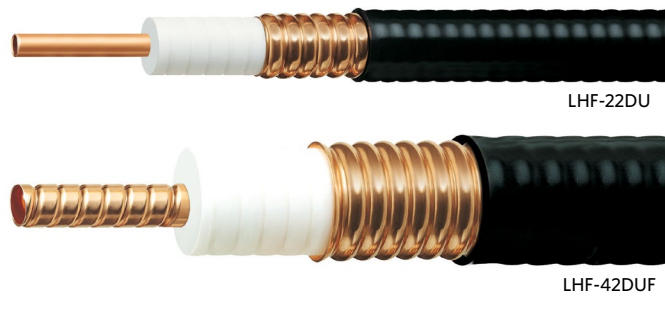

## PRODUCT DESCRIPTION

LHF Ultimate High Performance Series cables are low loss 50 Ohm cables featuring a copper tube center conductor, foamed polyethylene dielectric and annularly corrugated copper metallic shield. Ultimate High Performance cables are designed to offer the low attenuation and high propagation velocity required by modern 3G and 4G networks.

## FEATURES

- Low attenuation and high propagation velocity
- Low passive intermodulation
- Easy connectorization
- Factory tested and inspected
- Rugged and durable

## BENEFITS

- Highly efficient signal transfer over long cable runs
- Outperforms the industry requirements for low passive intermodulation
- Full line of high-quality low intermodulation DIN and N connectors and cable preparation tools minimize installation time and expenses
- 100% of all RF cables are inspected and tested to meet or exceed industry specifications including passive intermodulation
- High-quality materials result in rugged cables that are able to withstand extreme environments without corrosion

## SPECIFICATIONS

Inner Conductor	LHF-22DU: Smooth copper tube LHF-42DU: Corrugated copper tube
Dielectric	Foamed polyethylene
Outer Conductor	Annularly corrugated copper tube
Jacket	Black polyethylene
Recommended Operating Temperature °F (°C)	-40 to +185 (-40 to +80)

## PART NUMBERS AND PHYSICAL CHARACTERISTICS

Part Number	Cable Size in (mm)	Nominal Diameter in (mm)				Minimum Bend Radius in (mm)	Approx. Weight lbs/kft (kg/km)	Flat Plate Crush Resistance lbs/in (kg/mm)	Maximum Pulling Force lbs (kg)
		Inner Conductor	Dielectric	Outer Conductor	Jacket				
LHF-22DU	7/8 (22)	0.37 (9.5)	0.91 (23.1)	1.00 (25.3)	1.11 (28.2)	9.84 (250)	316 (470)	100 (1.8)	323 (147)
LHF-42DUF	1 1/8 (42)	0.71 (18.1)	1.72 (43.6)	1.83 (46.6)	1.97 (50.0)	19.69 (500)	710 (1,059)	90 (1.6)	398 (181)

## ELECTRICAL SPECIFICATIONS

Part Number	Cable Size in (mm)	Conductor DC Resistance Ohms/kft (Ohms/km)		Insulation Resistance mΩ km	Dielectric Strength for 1 minute DC Potential - Volts	Velocity of Propagation %	Peak Power Rating kW	Maximum Operating Frequency GHz	Characteristic Impedance Ohms	Typical Return Loss dB
		Inner	Outer							
LHF-22DU	7/8 (22)	0.6 (1.9)	0.6 (1.9)	10,000	6,000	91 ± 3	0.92	5.0	50 ± 1	28
LHF-42DUF	1 1/8 (42)	0.4 (1.6)	0.2 (0.7)	10,000	11,000	92 ± 3	2.77	2.5	50 ± 1	28

Frequency MHz	Attenuation at 20°C dB/100 ft (dB/100 m)		Average Power Rating at Ambient 40°C Inner Conductor 100°C kW	
	LHF-22D	LHF-42D	LHF-22DU	LHF-42DUF
450	0.73 (2.42)	0.43 (1.43)	-	-
700	0.93 (3.06)	0.55 (1.82)	-	-
824	1.02 (3.35)	0.61 (2.00)	2.49	3.60
894	1.07 (3.50)	0.64 (2.09)	2.38	3.44
960	1.11 (3.64)	0.66 (2.18)	-	-
1,700	1.52 (4.99)	0.92 (3.02)	1.67	2.38
1,800	-	-	1.61	2.30
2,000	1.66 (5.47)	1.01 (3.33)	1.54	2.16
2,400	1.85 (6.07)	1.13 (3.71)	-	-
3,000	2.10 (6.89)	-	-	-

Frequency MHz	VSWR	
	LHF-22DU	LHF-42DU
800-960	1.13	1.13
1,700-2,200	1.13	1.13

Standard Conditions: VSWR 1.0,  
Ambient Temperature 20°C/Attenuation is typical value.

## PRODUCT DESCRIPTION

HFSC Series cables are super flexible lightweight coaxial cables featuring a copper clad aluminum conductor, foamed polyethylene dielectric and corrugated copper metallic shield. This helically corrugated cable has the highest number of corrugations per inch and the lowest minimum bending radius, making it well-suited for jumper cable and installations where bending and tight spaces require a more flexible cable.

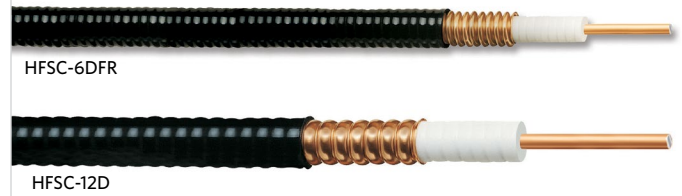

## FEATURES

- Light weight and flexible
- Low passive intermodulation
- Easy connectorization
- Factory tested and inspected
- Rugged and durable
- Flame retardant zero halogen

## BENEFITS

- Easy to transport and install
- Outperforms the industry requirements for low passive intermodulation
- Full line of high-quality low intermodulation DIN and N connectors and cable preparation tools minimize installation time and expense
- 100% of all RF cables are inspected and tested to meet or exceed industry specifications including passive intermodulation
- High-quality materials result in rugged cables that are able to withstand extreme environments without corrosion
- Standard ¼ inch cable meets IEC 754-1, 332, 383 and ASTM E 662

## SPECIFICATIONS

Inner Conductor	Copper-clad aluminum wire
Dielectric	Foamed polyethylene
Outer Conductor	Helically corrugated copper tube
Jacket	HFSC-6DFR: Flame Retardant, Low Smoke Zero Halogen (LSZH) HFSC-12D: Black polyethylene
Recommended Operating Temperature °F (°C)	HFSC-6DFR: -22 to +176 (-30 to +80) HFSC-12D: -40 to +185 (-40 to +80)

## PART NUMBERS AND PHYSICAL CHARACTERISTICS

Part Number	Cable Size in (mm)	Nominal Diameter in (mm)				Minimum Bend Radius in (mm)	Approx. Weight lbs/kft (kg/km)	Flat Plate Crush Resistance lbs/in (kg/mm)	Maximum Pulling Force lbs (kg)
		Inner Conductor	Dielectric	Outer Conductor	Jacket				
HFSC-6DFR	¼ (6)	0.07 (1.9)	0.19 (4.7)	0.25 (6.4)	0.31 (8.0)	0.98 (25)	54 (80)	161.44 (1.86)	150 (68)
HFSC-12D	½ (12)	0.14 (3.6)	0.35 (8.9)	0.48 (12.2)	0.54 (13.6)	1.26 (32)	135 (201)	147.60 (1.7)	143 (65)

## ELECTRICAL SPECIFICATIONS

Part Number	Cable Size in (mm)	Conductor DC Resistance Ohms/kft (Ohms/km)		Insulation Resistance mΩ km	Dielectric Strength for 1 minute DC Potential - Volts	Velocity of Propagation %	Peak Power Rating kW	Maximum Operating Frequency GHz	Characteristic Impedance Ohms	Typical Return Loss dB
		Inner	Outer							
HFSC-6DFR	¼ (6)	2.99 (9.80)	1.98 (6.50)	10,000	1,600	81	6.4	20.4	50	28
HFSC-12D	½ (12)	0.87 (2.85)	0.99 (3.25)	10,000	2,500	81	15.6	10.0	50	28

Frequency MHz	Attenuation at 20°C dB/100 ft (dB/100 m)		Average Power Rating at Ambient 40°C Inner Conductor 100°C kW	
	HFSC-6DFR	HFSC-12D	HFSC-6DFR	HFSC-12D
30	0.96 (3.15)	0.55 (1.80)	2.08	4.87
100	1.77 (5.82)	1.01 (3.33)	1.13	2.62
150	2.19 (7.17)	1.25 (4.10)	0.92	2.12
450	3.87 (12.70)	2.22 (7.29)	0.52	1.19
824	5.36 (17.60)	3.08 (10.10)	0.38	0.85
894	5.61 (18.40)	3.20 (10.50)	0.36	0.82
960	5.82 (19.10)	3.35 (11.00)	0.35	0.79
1,000	5.94 (19.50)	3.41 (11.20)	0.34	0.77
1,700	7.96 (26.10)	4.57 (15.00)	0.26	0.57
1,800	8.20 (26.90)	4.72 (15.50)	0.25	0.55
2,000	8.69 (28.50)	5.00 (16.40)	0.24	0.52
2,400	9.63 (31.60)	5.55 (18.20)	0.22	0.47
3,000	10.91 (35.80)	6.31 (20.70)	0.19	0.41
4,000	12.86 (42.20)	7.44 (24.40)	0.16	0.35
6,000	16.28 (53.40)	9.45 (31.00)	0.13	0.27
10,000	22.13 (72.60)	12.89 (42.30)	0.10	0.20

Frequency MHz	VSWR	
	HFSC-6DFR	HFSC-12D
800-960	1.15	1.15
1,700-2,200	1.15	1.15

Standard Conditions: VSWR 1.0, Ambient Temperature 20°C/Attenuation is typical value.

# Fiber-to-the-Antenna (FTTA)

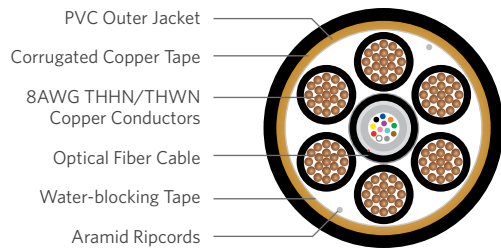

## PRODUCT DESCRIPTION

Fiber-to-the-Antenna (FTFA) cables are designed to address the movement of electronics from the ground hut to the cell tower, allowing significant improvement in available bandwidth. Superior Essex offers two types of cable for this application: optical fiber and hybrid (containing both optical fibers and copper power conductors). Optical fiber cables are available with PFM™ gel; hybrid cables are available with either PFM gel components or tight buffered components. Each of the options provide a solution to the challenges of temperature changes, wind shear and vertical applications. The hybrid offering also has a copper shield option for lightning protection and a PVC jacket to increase the coefficient friction between the outer jacket and tower clamps.

## APPLICATIONS

- Fiber-to-the-Antenna
- Fiber-to-the-Remote Radio Head

## FEATURES

- PFM gel or tight buffer
- Hybrid designs
- Shield options
- Jacketing options
- Range of fibers
- Optional signaling component available

## BENEFITS

- Proven performance in tower applications
- Reduces required number of cables
- Customer preference for lightning protection
- Customer preference for jacketing material
- Addresses multiple provider/capacity requirements
- Offers system feedback

## FIBER COMPONENT SPECIFICATIONS

<b>Tight Buffer</b>	Tight Buffered Low Smoke Zero Halogen (LSZH), Riser Available in 2-fiber up to 12-fiber
<b>Loose Tube</b>	Stranded Loose Tube Indoor/Outdoor OFNR, Series 13 Available in 12-fiber up to 288-fiber
<b>Central Tube</b>	Single Loose Tube Indoor/Outdoor OFNR, Series 53 Available in 2-fiber up to 96-fiber
<b>Performance Compliance</b>	Telcordia® GR-20-CORE

Telcordia is a registered trademark of Ericsson Inc.

## POWER COMPONENT SPECIFICATIONS

<b>Conductor</b>	Annealed stranded copper (19 strands)
<b>AWG</b>	Available in 8 AWG
<b>Insulation</b>	Polyvinyl Chloride (PVC) covered with colored Nylon (THHN/THWN-2)
<b>Temperature Ratings</b>	Rated at 90°C for dry locations Rated at 75°C for wet locations
<b>Performance Compliance</b>	ASTM B8 or ASTM B-787 UL® 83
<b>Other Compliance</b>	Sunlight Resistant RoHS-compliant

## ENVIRONMENTAL SPECIFICATIONS

<b>Operation/Storage</b>	-40°C to +70°C
<b>Installation</b>	-10°C to +65°C

## PART NUMBERS AND PHYSICAL CHARACTERISTICS

Previous Part Number	Current Part Number	Conductor Count	AWG (mm)	Fiber Component	Fiber Count	Nominal Diameter in (mm)	Approx. Weight lbs/kft (kg/km)	Maximum Tensile Load		Minimum Bend Radius	
								Install lbs (N)	Long Term lbs (N)	Install in (mm)	Long Term in (mm)
	53012K01Q	-	-	Central tube	12	0.37 (9.5)	52 (78)	600 (2,700)	200 (890)	7.4 (188)	3.7 (94)
	53024K01Q	-	-	Central tube	24	0.37 (9.5)	53 (79)	600 (2,700)	200 (890)	7.4 (188)	3.7 (94)
	53048J01Q	-	-	Central tube	48	0.37 (9.5)	54 (80)	600 (2,700)	200 (890)	7.4 (188)	3.7 (94)
GM012K221	FHG3-012-U13-E991	6	8 (3.26)	Tight buffer	12	0.86 (21.8)	568 (847)	600 (2,700)	200 (890)	17.2 (236)	8.6 (218)
GM012K111	FHG2-012-U13-E991	6	8 (3.26)	Central tube	12	0.87 (22.0)	568 (847)	600 (2,700)	200 (890)	17.4 (440)	8.7 (220)
GM012K011	FHG1-012-U13-E991	6	8 (3.26)	Loose tube	12	0.95 (24.1)	614 (915)	600 (2,700)	200 (890)	19.0 (482)	9.5 (241)

Part numbers listed are TeraFlex® Bend Resistant single mode optical fiber only. Other fiber types available. See "Optical Fiber Specifications" in the "Technical Info" section for detailed fiber type specifications.

## PRODUCT DESCRIPTION

Jumper cables offer outstanding electrical performance along with high durability for tight routing and superior environmental sealing for long life reliability.

Available in 3/8 inch and 1/2 inch diameters, jumper cables are used in areas that require extremely small bending radius, such as between main feeders and antennas or between main feeders and RF equipment.

## FEATURES/BENEFITS

- High pull-off strength
- Excellent VSWR performance
- Low and stable intermodulation
- Weatherproof



## SPECIFICATIONS

Compatible Cable Type	HFSC-12D
Compatible Cable Size in (mm)	1/2 (12)
Minimum Bend Radius in (mm)	1.26 (32)
Typical VSWR	1.08 over Cellular, PCS and 3G-band
Intermodulation (PIM) dBc	< -158
Recommended Operating Temperature °F (°C)	-40 to +185 (-40 to +80)

## PART NUMBERS AND PHYSICAL CHARACTERISTICS

Part Number	Interface Type		Standard Length ft (m)	Unit of Measure
	End 1	End 2		
J12-1DMDM	DIN Male, Straight	DIN Male, Straight	3.3 (1)	Each
J12-1NMNM	N Male, Straight	N Male, Straight	3.3 (1)	Each
J12-2DMDM	DIN Male, Straight	DIN Male, Straight	6.6 (2)	Each
J12-2NMNM	N Male, Straight	N Male, Straight	6.6 (2)	Each
J12-3DMDM	DIN Male, Straight	DIN Male, Straight	9.8 (3)	Each
J12-3NMNM	N Male, Straight	N Male, Straight	9.8 (3)	Each
J12-3NMNMR	N Male, Straight	N Male, Right Angle	9.8 (3)	Each
J12-4DMDM	DIN Male, Straight	DIN Male, Straight	13.1 (4)	Each
J12-4NMNM	N Male, Straight	N Male, Straight	13.1 (4)	Each
J12-5DMDM	DIN Male, Straight	DIN Male, Straight	16.4 (5)	Each
J12-5DMDMDF	DIN Male, Straight	DIN Female, Straight	16.4 (5)	Each
J12-5NMNM	N Male, Straight	N Male, Straight	16.4 (5)	Each
J12-6NMNMR	N Male, Straight	N Male, Right Angle	19.7 (6)	Each

## EXPLANATION OF PART NUMBERS

**J12-2DMDMR**

Product Category	Compatible Cable Size	Jumper Length	Connector for End 1	Connector for End 2
J = Jumper Cable	12 = 1/2 inch (12 mm)	1 = 1 meter 2 = 2 meters 3 = 3 meters 4 = 4 meters 5 = 5 meters 6 = 6 meters	DM = DIN Male straight DMR = DIN Male Right angle DF = DIN Female straight DFR = DIN Female Right angle NM = N Male straight NMR = N Male Right angle NF = N Female NFR = N Female Right angle	DM = DIN Male straight DMR = DIN Male Right angle DF = DIN Female straight DFR = DIN Female Right angle NM = N Male straight NMR = N Male Right angle NF = N Female NFR = N Female Right angle

# DIN Series for LHF



½ inch (12 mm)



¾ inch (22 mm)



1¼ inch (33 mm)



1½ inch (42 mm)

## SPECIFICATIONS

Bodies, Cap (Coupling Nut) Material	Brass/silver plated or Su Co (Alloy of Cu/Sn/Zn) plated
Back Nut Material	Brass/nickel plated
Pin Material	Male: Brass/silver plated or Su Co (Alloy of Cu/Sn/Zn) plated Female: Beryllium - copper/silver plated or Su Co (Alloy of Cu/Sn/Zn) plated
Insulator Material	Plated PTFE (Teflon®)
Gasket Material	Silicon rubber
Recommended Coupling Nut Torque Nm	25-30
Coupling Nut Retention Force Nm	1,000
Contact Captivation N	200
Mating Durability	500 times

Teflon is a registered trademark of E. I. du Pont de Nemours and Company or its affiliates.

## PRODUCT DESCRIPTION

This DIN Series is compatible with the LHF Feeder Series. The connectors are manufactured from an alloy material of copper, tin and zinc to produce a highly polished, precise, and strong connector. This alloy combination allows a better operating temperature range and improved environmental performance.

## FEATURES/BENEFITS

- Two-piece design is the industry standard
- Simple 6-step user friendly installation process
- Ordinary tools needed; available in a common installers tool bag
- Connector can be disassembled and re-used
- Offers stable connections

## ELECTRICAL SPECIFICATIONS

Impedance Ω	50
Maximum Frequency Range GHz	7.5
VSWR (Mating) straight (right angle)	1 GHz: 1.08 (1.12) 2 GHz: 1.10 (1.15)
Maximum Insertion Loss dB @ 3 GHz	0.2
Intermodulation (PIM) dBc	< -155
Dielectric Withstanding Voltage kV rms @ 50 Hz	4.0
Working Voltage kV rms @ 50 Hz	2.7
Insulation Resistance GΩ	10
Contact Resistance mΩ	Inner: 0.4 Outer: 1.5

## ENVIRONMENTAL SPECIFICATIONS

Temperature Range °F (°C)	-49 to +185 (-45 to +85)
Corrosion (Salt Spray Test)	IEC-68-2-11-Ka
Vibration	CECC 22000 Part 4.6.3
Waterproof	IP68

## PART NUMBERS AND PHYSICAL CHARACTERISTICS

Part Number	DIN Interface Type		Compatible Cable Size in (mm)	Length in (mm)	Diameter in (mm)	Weight oz (g)
	Gender	Straight or Angle				
CLH-12DF	Female	Straight	½ (12)	2.65 (67.4)	0.86 (21.8)	5.3 (150)
CLH-12DFR	Female	Right Angle	½ (12)	-	-	-
CLH-12DM	Male	Straight	½ (12)	2.57 (65.4)	0.86 (21.8)	6.5 (183)
CLH-12DMR	Male	Right Angle	½ (12)	-	-	-
CLH-22DF	Female	Straight	¾ (22)	2.62 (66.5)	1.39 (35.2)	7.4 (210)
CLH-22DM	Male	Straight	¾ (22)	2.81 (71.5)	1.39 (35.2)	8.1 (230)
CLH-33DF	Female	Straight	1¼ (33)	3.50 (88.9)	1.87 (47.6)	19.8 (560)
CLH-33DM	Male	Straight	1¼ (33)	3.76 (95.4)	1.87 (47.6)	19.8 (560)
CLH-42DF	Female	Straight	1½ (42)	3.92 (99.5)	2.35 (59.6)	35.3 (1,000)
CLH-42DM	Male	Straight	1½ (42)	4.21 (107.0)	2.35 (59.6)	37.7 (1,070)



### TECHNICAL GUIDELINE

Installation guidelines are available for these connectors. Refer to the "Resources" section on our site for the Technical Guideline, "DIN Connectors and N Connectors Installation Guidelines," for more information.



## PRODUCT DESCRIPTION

This DIN Series is compatible with the HFSC Feeder Series. The connectors are manufactured from an alloy material of copper, tin and zinc to produce a highly polished, precise, and strong connector. This alloy combination allows a better operating temperature range and improved environmental performance.

## FEATURES/BENEFITS

- Two-piece design is the industry standard
- Connector can be disassembled and re-used
- Excellent VSWR
- Low PIMD
- Fast and easy to install
- Waterproof (IP68)
- RoHS-compliant



1/2 inch (12 mm)

## ELECTRICAL SPECIFICATIONS

Impedance Ω	50
Maximum Frequency Range GHz	7.5
VSWR (Mating) straight (right angle)	1 GHz: 1.08 (1.12) 2 GHz: 1.10 (1.15)
Maximum Insertion Loss dB @ 3 GHz	0.2
Intermodulation (PIM) dBc	< -155
Dielectric Withstanding Voltage kV rms @ 50 Hz	4.0
Working Voltage kV rms @ 50 Hz	2.7
Insulation Resistance GΩ	10
Contact Resistance mΩ	Inner: 0.4 Outer: 1.5

## ENVIRONMENTAL SPECIFICATIONS

Temperature Range °F (°C)	-49 to +185 (-45 to +85)
Corrosion (Salt Spray Test)	IEC-68-2-11-Ka
Vibration	CECC 22000 Part 4.6.3
Waterproof	IP68

## SPECIFICATIONS

Bodies, Cap (Coupling Nut) Material	Brass/silver plated or Su Co (Alloy of Cu/Sn/Zn) plated
Back Nut Material	Brass/nickel plated
Pin Material	Male: Brass/silver plated or Su Co (Alloy of Cu/Sn/Zn) plated Female: Beryllium - copper/silver plated or Su Co (Alloy of Cu/Sn/Zn) plated
Insulator Material	Plated PTFE (Teflon®)
Gasket Material	Silicon rubber
Recommended Coupling Nut Torque Nm	25-30
Coupling Nut Retention Force Nm	1,000
Contact Captivation N	200
Mating Durability	500 times

Teflon is a registered trademark of E. I. du Pont de Nemours and Company or its affiliates.

## PART NUMBERS AND PHYSICAL CHARACTERISTICS

Part Number	DIN Interface Type		Compatible Cable Size in (mm)	Length in (mm)	Diameter in (mm)	Weight oz (g)
	Gender	Straight or Angle				
CHFS-6DF	Female	Straight	1/4 (6)	2.00 (50.9)	0.72 (18.5)	4.23 (120)
CHFS-6DM	Male	Straight	1/4 (6)	2.02 (51.3)	0.72 (18.5)	4.59 (130)
CHFS-6DMR	Male	Right Angle	1/4 (6)	2.21 (56.2)	0.72 (18.5)	7.05 (200)
CHFS-12DF	Female	Straight	1/2 (12)	2.65 (67.4)	0.86 (21.8)	5.3 (150)
CHFS12DFR	Female	Right Angle	1/2 (12)	-	-	-
CHFS-12DM	Male	Straight	1/2 (12)	2.57 (65.4)	0.86 (21.8)	6.5 (183)
CHFS12DMR	Male	Right Angle	1/2 (12)	-	-	-



## TECHNICAL GUIDELINE

Installation guidelines are available for these connectors. Refer to the "Resources" section on our site for the Technical Guideline, "DIN Connectors and N Connectors Installation Guidelines," for more information.

# N Series for LHF



½ inch (12 mm)



¾ inch (22 mm)



1¼ inch (33 mm)



1½ inch (42 mm)

## SPECIFICATIONS

Bodies, Cap (Coupling Nut) Material	Brass/silver plated or Su Co (Alloy of Cu/Sn/Zn) plated
Back Nut Material	Brass/nickel plated
Pin Material	Male: Brass/silver plated or Su Co (Alloy of Cu/Sn/Zn) plated Female: Beryllium - copper/silver plated or Su Co (Alloy of Cu/Sn/Zn) plated
Insulator Material	Plated PTFE (Teflon®)
Gasket Material	Silicon rubber
Recommended Coupling Nut Torque Nm	25-30
Coupling Nut Retention Force Nm	1,000
Contact Captivation N	200
Mating Durability	500 times

Teflon is a registered trademark of E. I. du Pont de Nemours and Company or its affiliates.

## PRODUCT DESCRIPTION

This N Series is compatible with the LHF Feeder Series. The connectors are manufactured from an alloy material of copper, tin and zinc to produce a highly polished, precise, and strong connector. This alloy combination allows a better operating temperature range and improved environmental performance.

## FEATURES/BENEFITS

- Two-piece design is the industry standard
- Simple 6-step user friendly installation process
- Ordinary tools needed; available in a common installers tool bag
- Connector can be disassembled and re-used
- Offers stable connections

## ELECTRICAL SPECIFICATIONS

Impedance Ω	50
Maximum Frequency Range GHz	7.5
VSWR (Mating) straight (right angle)	1 GHz: 1.08 (1.12) 2 GHz: 1.10 (1.15)
Maximum Insertion Loss dB @ 3 GHz	0.2
Intermodulation (PIM) dBc	< -155
Dielectric Withstanding Voltage kV rms @ 50 Hz	4.0
Working Voltage kV rms @ 50 Hz	2.7
Insulation Resistance GΩ	10
Contact Resistance mΩ	Inner: 0.4 Outer: 1.5

## ENVIRONMENTAL SPECIFICATIONS

Temperature Range °F (°C)	-40 to +185 (-40 to +85)
Corrosion (Salt Spray Test)	IEC-68-2-11-Ka
Vibration	CECC 22000 Part 4.6.3
Waterproof	IP68

## PART NUMBERS AND PHYSICAL CHARACTERISTICS

Part Number	N Interface Type		Compatible Cable Size in (mm)	Length in (mm)	Diameter in (mm)	Weight oz (g)
	Gender	Straight or Angle				
CLH-12NF	Female	Straight	½ (12)	2.75 (69.8)	0.86 (21.8)	4.1 (115)
CLH-12NFR	Female	Right Angle	½ (12)	-	-	-
CLH-12NM	Male	Straight	½ (12)	2.75 (69.8)	0.86 (21.8)	4.2 (120)
CLH-12NMR	Male	Right Angle	½ (12)	-	-	-
CLH-22NF	Female	Straight	¾ (22)	2.75 (69.9)	1.39 (35.2)	7.6 (215)
CLH-22NM	Male	Straight	¾ (22)	2.86 (72.7)	1.39 (35.2)	7.6 (215)
CLH-33NF	Female	Straight	1¼ (33)	3.76 (95.5)	1.87 (47.6)	19.8 (560)
CLH-33NM	Male	Straight	1¼ (33)	3.86 (98.0)	1.87 (47.6)	19.8 (560)
CLH-42NF	Female	Straight	1½ (42)	41.3 (105.0)	2.35 (59.6)	35.3 (1,000)
CLH-42NM	Male	Straight	1½ (42)	4.25 (108.0)	2.35 (59.6)	37.7 (1,070)



## TECHNICAL GUIDELINE

Installation guidelines are available for these connectors. Refer to the "Resources" section on our site for the Technical Guideline, "DIN Connectors and N Connectors Installation Guidelines," for more information.

# N Series for HFSC

## PRODUCT DESCRIPTION

This N Series is compatible with the HFSC Feeder Series. The connectors are manufactured from an alloy material of copper, tin and zinc to produce a highly polished, precise, and strong connector. This alloy combination allows a better operating temperature range and improved environmental performance.

## FEATURES/BENEFITS

- Two-piece design is the industry standard
- Connector can be disassembled and re-used
- Excellent VSWR
- Low PIMD
- Fast and easy to install
- Waterproof (IP68)
- RoHS-compliant



½ inch (12 mm)

## ELECTRICAL SPECIFICATIONS

Impedance Ω	50
Maximum Frequency Range GHz	7.5
VSWR (Mating) straight (right angle)	1 GHz: 1.08 (1.12) 2 GHz: 1.10 (1.15)
Maximum Insertion Loss dB @ 3 GHz	0.2
Intermodulation (PIM) dBc	< -155
Dielectric Withstanding Voltage kV rms @ 50 Hz	4.0
Working Voltage kV rms @ 50 Hz	2.7
Insulation Resistance GΩ	10
Contact Resistance mΩ	Inner: 0.4 Outer: 1.5

## ENVIRONMENTAL SPECIFICATIONS

Temperature Range °F (°C)	-40 to +185 (-40 to +85)
Corrosion (Salt Spray Test)	IEC-68-2-11-Ka
Vibration	CECC 22000 Part 4.6.3
Waterproof	IP68

## SPECIFICATIONS

Bodies, Cap (Coupling Nut) Material	Brass/silver plated or Su Co (Alloy of Cu/Sn/Zn) plated
Back Nut Material	Brass/nickel plated
Pin Material	Male: Brass/silver plated or Su Co (Alloy of Cu/Sn/Zn) plated Female: Beryllium - copper/silver plated or Su Co (Alloy of Cu/Sn/Zn) plated
Insulator Material	Plated PTFE (Teflon®)
Gasket Material	Silicon rubber
Recommended Coupling Nut Torque Nm	25-30
Coupling Nut Retention Force Nm	1,000
Contact Captivation N	200
Mating Durability	500 times

Teflon is a registered trademark of E. I. du Pont de Nemours and Company or its affiliates.

## PART NUMBERS AND PHYSICAL CHARACTERISTICS

Part Number	N Interface Type		Compatible Cable Size in (mm)	Length in (mm)	Diameter in (mm)	Weight oz (g)
	Gender	Straight or Angle				
CHFS-6NF	Female	Straight	¼ (6)	2.16 (54.9)	0.72 (18.5)	3.35 (95)
CHFS-6NM	Male	Straight	¼ (6)	2.20 (56.0)	0.72 (18.5)	3.52 (100)
CHFS-6NMR	Male	Right Angle	¼ (6)	2.21 (56.2)	0.72 (18.5)	7.05 (200)
CHFS-12NF	Female	Straight	½ (12)	2.75 (69.8)	0.86 (21.8)	4.1 (115)
CHFS12NFR	Female	Right Angle	½ (12)	-	-	-
CHFS-12NM	Male	Straight	½ (12)	2.75 (69.8)	0.86 (21.8)	4.2 (120)
CHFS12NMR	Male	Right Angle	½ (12)	-	-	-



## TECHNICAL GUIDELINE

Installation guidelines are available for these connectors. Refer to the "Resources" section on our site for the Technical Guideline, "DIN Connectors and N Connectors Installation Guidelines," for more information.

# DAS Hybrid

Fiber + Copper

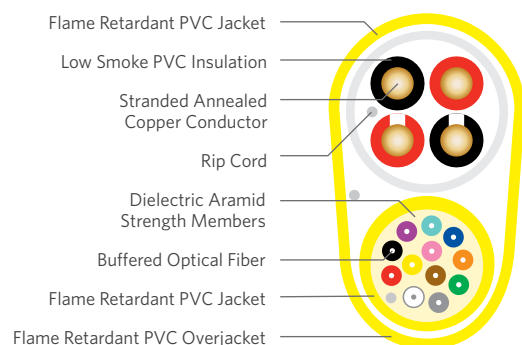

## PRODUCT DESCRIPTION

A jacketed multi-strand optical fiber cable and a jacketed multi-conductor copper cable are covered with an overjacket to form a single hybrid cable. The optical fiber cable contains 12 flexible 900  $\mu\text{m}$  tight buffered single mode fibers for voice and data communications. The non-shielded copper cable contains four 12 AWG conductors ideal for carrying power, control signals and video.

Hybrid cables are intended for applications that utilize centralized DC power and comply with NEC Article 725 for Class 2 power limited circuits. A hybrid cable reduces installation time and labor by allowing both fiber and copper cables to be pulled as a single cable, eliminating the need for two separate pulls. Labor costs are further minimized because the cable can be pulled by a telecom installer instead of an electrician.

## APPLICATIONS

- Distributed Antenna Systems (DAS)
- CCTV
- Wi-Fi

## FEATURES

- Two cables covered with an overjacket to form a single cable
- Overjacket design plus rip cord
- NEC Class 2 power limited circuit
- UL® 13 CL2P plenum rated
- 900  $\mu\text{m}$  tight buffered
- Large 12 AWG copper wires
- QuickCount® marking system in feet and meters

## BENEFITS

- One pull eliminates the time and labor cost for a second pull
- Easy to separate and route fiber and copper to different termination points
- Installation doesn't have to be done by an electrician
- Cable can be installed throughout a building, including air carrying plenum space, without being enclosed in a raceway
- Easy connectorization in the field
- For long cable runs
- Provides remaining length of cable on reel, resulting in less scrap

## COPPER COMPONENT SPECIFICATIONS

Configuration	Stranded bare copper with uniquely colored insulation, jacketed, non-shielded
Conductor Count	4 conductors
Conductor	Fully annealed, stranded bare copper
Conductor Type	19 x 0.185"
AWG (mm)	12 (2.05)
Insulation	Low smoke PVC
Insulation Colors	Conductor 1: Black Conductor 2: Red Conductor 3: Black with white stripe Conductor 4: Red with white stripe
Jacket	White, Flame Retardant (FR) PVC
Performance Compliance	NEC Article 725 NEC Article 800 NFPA 262
NRTL Programs	UL Listed CL3P

## OPTICAL FIBER COMPONENT SPECIFICATIONS

Configuration	Flexible 900 $\mu\text{m}$ tight buffered fibers, dielectric aramid yarns and overall jacket
Fiber Count	12
Fiber Type	Single mode TeraFlex® Bend Resistant G.657.A1
Maximum Tensile Loading lbs (N)	Install: 100 (400) Long Term: 30 (130)
Jacket	Yellow, FR PVC
Performance Compliance	UL 1651 CSA C22.2 No. 232 NFPA 262 Telcordia® GR-409-CORE, Issue 2 ANSI/ICEA S-83-596 ANSI/TIA-568.3-D
NRTL Programs	UL, c(UL) Listed OFNP

Telcordia is a registered trademark of Ericsson Inc. UL is a registered trademark of UL LLC.

## COMPOSITE SPECIFICATIONS

Jacket	Yellow, FR PVC
Performance Compliance	NEC Article 725 ANSI/ICEA S-83-596 RoHS-compliant (RoHS 2 Directive 2011/65/EU)
NRTL Programs	UL Listed CL2P

## ENVIRONMENTAL SPECIFICATIONS

Storage/Shipping	-40°C to +65°C
Operation	0°C to +75°C

## PART NUMBERS AND PHYSICAL CHARACTERISTICS

Part Number	Copper Component Nominal Diameter in (mm)	Fiber Component Nominal Diameter in (mm)	Overall Nominal Diameter in (mm)		Approx. Weight lbs/kft	Maximum Tensile Loading		Minimum Bend Radius	
			Minor in (mm)	Major in (mm)		Install lbs	Long Term lbs	Install in (mm)	Long Term in (mm)
F4C2-012U13-6991-CE5	0.29 (7.31)	0.24 (6.2)	0.38 (9.66)	0.62 (15.76)	160	150	45	7.6 (193)	3.8 (96)

# DAS Hybrid, Interlock Armored

Fiber + Copper

## PRODUCT DESCRIPTION

A jacketed multi-strand optical fiber cable and a jacketed multi-conductor copper cable are covered with an overjacket to form a single hybrid cable. The optical fiber cable contains 12 flexible 900  $\mu\text{m}$  tight buffered single mode fibers for voice and data communications. The non-shielded copper cable contains four 12 AWG conductors ideal for carrying power, control signals and video.

Hybrid cables are intended for applications that utilize centralized DC power and comply with NEC Article 725 for Class 2 power limited circuits. A hybrid cable reduces installation time and labor by allowing both fiber and copper cables to be pulled as a single cable, eliminating the need for two separate pulls. Labor costs are further minimized because the cable can be pulled by a telecom installer instead of an electrician.

## APPLICATIONS

- Distributed Antenna Systems (DAS)
- CCTV
- Wi-Fi

## FEATURES

- Two cables covered with an overjacket to form a single cable
- Overjacket design plus rip cord
- NEC Class 2 power limited circuit
- UL® 13 CL2P plenum rated
- 900  $\mu\text{m}$  tight buffered
- Large 12 AWG copper wires
- QuickCount® marking system in feet and meters

## BENEFITS

- One pull eliminates the time and labor cost for a second pull
- Easy to separate and route fiber and copper to different termination points
- Installation doesn't have to be done by an electrician
- Cable can be installed throughout a building, including air carrying plenum space, without being enclosed in a raceway
- Easy connectorization in the field
- For long cable runs
- Provides remaining length of cable on reel, resulting in less scrap

## COMPOSITE SPECIFICATIONS

Jacket	Yellow, FR PVC
Armor	Flexible heavy duty interlocking aluminum tape helically applied over the jacketed fiber and copper cables
Performance Compliance	NEC Article 725 ANSI/ICEA S-83-596 RoHS-compliant (RoHS 2 Directive 2011/65/EU)
NRTL Programs	UL Listed CL2P

## ENVIRONMENTAL SPECIFICATIONS

Storage/Shipping	-40°C to +70°C
Operation	0°C to +70°C
Installation	0°C to +60°C

## PART NUMBERS AND PHYSICAL CHARACTERISTICS

Part Number	Copper Component Nominal Diameter in (mm)	Fiber Component Nominal Diameter in (mm)	Overall Nominal Diameter in (mm)	Approx. Weight lbs/kft	Maximum Tensile Loading		Minimum Bend Radius	
					Install lbs	Long Term lbs	Install in (mm)	Long Term in (mm)
F2C2-012U13-6991-CE5	0.29 (7.31)	0.24 (6.2)	0.87 (22.0)	315	150	45	17.3 (440)	8.7 (220)

UL is a registered trademark of UL LLC. Telcordia is a registered trademark of Ericsson Inc.

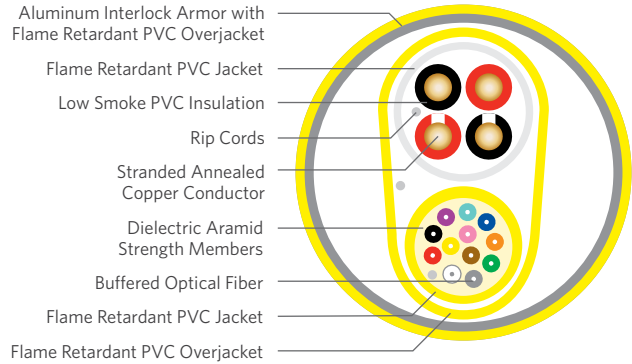

## COPPER COMPONENT SPECIFICATIONS

Configuration	Stranded bare copper with uniquely colored insulation, jacketed, non-shielded
Conductor Count	4 conductors
Conductor	Fully annealed, stranded bare copper
Conductor Type	19 x 0.185"
AWG (mm)	12 (2.05)
Insulation	Low smoke PVC
Insulation Colors	Conductor 1: Black Conductor 2: Red Conductor 3: Black with white stripe Conductor 4: Red with white stripe
Jacket	White, Flame Retardant (FR) PVC
Performance Compliance	NEC Article 725 NEC Article 800 NFPA 262
NRTL Programs	UL Listed CL3P

## OPTICAL FIBER COMPONENT SPECIFICATIONS

Configuration	Flexible 900 $\mu\text{m}$ tight buffered fibers, dielectric aramid yarns and overall jacket
Fiber Count	12
Fiber Type	Single mode TeraFlex® Bend Resistant G.657.A1
Maximum Tensile Loading lbs (N)	Install: 100 (400) Long Term: 30 (130)
Jacket	Yellow, FR PVC
Performance Compliance	UL 1651 CSA C22.2 No. 232 NFPA 262 Telcordia® GR-409-CORE, Issue 2 ANSI/ICEA S-83-596 ANSI/TIA-568.3-D
NRTL Programs	UL, c(UL) Listed OFNP

Telcordia is a registered trademark of Ericsson Inc. UL is a registered trademark of UL LLC.

# LHF Riser

Low Loss High Flexible Foam Dielectric Feeder

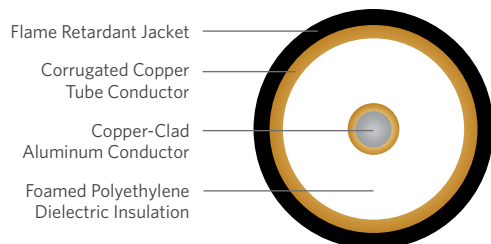

Flame Retardant Jacket  
Corrugated Copper Tube Conductor  
Copper-Clad Aluminum Conductor  
Foamed Polyethylene Dielectric Insulation

## PRODUCT DESCRIPTION

LHF-12DR is a ½ inch, 50 Ohm Riser Rated RF coaxial cable that enables mobile communications inside buildings. Installed to eliminate dead zones and spotty coverage, this cable functions as the backbone cable of in-building DAS wireless systems. With its riser (CMR) rating, this coaxial cable offers flexibility and high crush resistance in a ½ inch size. Designed for high performance, its copper clad aluminum inner conductor, foamed PE dielectric insulation, corrugated copper outer conductor, and its black outer riser rated jacket exceed the requirements of all in-building DAS active systems.

## APPLICATIONS

- In-building Wireless
- Distributed Antenna System (DAS)

## FEATURES

- Lowest attenuation
- Low passive intermodulation
- Non-halogenated, fire retardant, black polyethylene jacket
- ETL Certified CMR (UL® 1666)/CATVR (UL 1581)
- Full range of easy to install connectors and an automated cable prep tool

## BENEFITS

- Highly efficient signal transfer
- Outperforms the industry requirements for low PIM
- Rugged and durable jacket slows the spread of flame without releasing toxic smoke
- Suitable for vertical cable runs in a shaft or that penetrate more than one floor within a building
- Shortens installation time and expenses

## RELATED PRODUCTS

- Connectors CLH-12xx
- Cable prep tool T-LHF12DR

## SPECIFICATIONS

Inner Conductor Material	Copper-clad aluminum
Dielectric Material	Foamed polyethylene
Outer Conductor Material	Corrugated copper tube
Jacket Material	Black, flame retardant PE
Recommended Operating Temperature °F (°C)	-22 to +167 (-30 to +75)

## PART NUMBERS AND PHYSICAL CHARACTERISTICS

Part Number	Cable Size in (mm)	Nominal Diameter in (mm)				Minimum Bend Radius in (mm)	Approx. Weight lbs/kft (kg/km)	Flat Plate Crush Resistance lbs/in (kg/mm)	Maximum Pulling Force lbs (kg)
		Inner Conductor	Dielectric	Outer Conductor	Jacket				
LHF-12DR	½ (12)	0.19 (5.0)	0.49 (12.5)	0.55 (14.1)	0.64 (16.3)	4.90 (125)	165 (256)	112 (2.0)	249 (113)

## ELECTRICAL SPECIFICATIONS

Part Number	Cable Size in (mm)	Conductor DC Resistance Ohms/kft (Ohms/km)		Minimum Insulation Resistance mΩ km	Dielectric Strength for 1 minute DC Potential - Volts	Velocity of Propagation %	Peak Power Rating kW	Maximum Operating Frequency GHz	Characteristic Impedance Ohms	Typical Return Loss dB
		Inner	Outer							
LHF-12DR	½ (12)	0.50 (1.6)	0.85 (2.8)	10,000	4,000	89	40	8.8	50 ± 1	23

Frequency MHz	Nominal Attenuation* dB/100 ft (dB/100 m)	Average Power Rating at Ambient 40°C Inner Conductor 100°C kW
30	0.35 (1.14)	6.10
100	0.65 (2.12)	3.32
150	0.79 (2.60)	2.71
450	1.40 (4.58)	1.55
824	1.92 (6.31)	1.13
890	2.00 (6.55)	1.09
960	2.08 (6.84)	1.05
1,000	2.13 (7.00)	1.03
1,700	2.84 (9.32)	0.78
1,800	2.93 (9.61)	0.76
2,000	3.11 (10.19)	0.71
2,400	3.38 (11.10)	0.65
3,000	3.95 (12.96)	0.58
4,000	-	0.50

Frequency MHz	VSWR
806-960	≤ 1.15
1,700-2,155	≤ 1.15

\*The attenuation may rise by 0.2%/°C with rising temperature. Maximum attenuation shall not exceed 105% of nominal value. Standard Conditions: VSWR 1.0, Ambient Temperature 20°C/Attenuation is typical value. UL is a registered trademark of UL LLC.

# LHF Plenum

Low Loss High Flexible Air Dielectric Feeder

## PRODUCT DESCRIPTION

LHF-12DP is a ½ inch, low loss 50 Ohm Plenum Rated RF coaxial cable that is installed in the plenum space of a building as part of an in-building DAS system to eliminate dead zones and spotty coverage. Designed with a copper clad aluminum center conductor, air dielectric center structure, helically corrugated copper tube outer conductor, and Plenum Rated outer jacket, the LHF-12DP is a high performing cable with low loss attenuation.

## APPLICATIONS

- In-building Wireless
- Distributed Antenna System (DAS)

## FEATURES

- Lowest attenuation
- Low passive intermodulation
- High-quality, white PVDF jacket
- ETL Certified CMP (UL® 444)
- Full range of easy to install connectors and an automated cable prep tool

## BENEFITS

- Highly efficient signal transfer
- Outperforms the industry requirements for low PIM
- Flame retardant and low smoke; blends with background for optimal building aesthetics
- Safe to use throughout a building, including air carrying plenum space
- Shortens installation time and expenses

## RELATED PRODUCTS

- Connectors CLHP-12xx
- Cable prep tool T-LHFA12DP

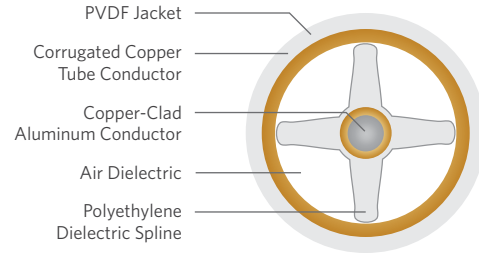

## SPECIFICATIONS

Inner Conductor Material	Copper-clad aluminum
Dielectric Material	Polyethylene
Outer Conductor Material	Corrugated copper tube
Jacket Material	White, PVDF
Recommended Operating Temperature °F (°C)	-4 to +167 (-20 to +75)

## PART NUMBERS AND PHYSICAL CHARACTERISTICS

Part Number	Cable Size in (mm)	Nominal Diameter in (mm)				Minimum Bend Radius in (mm)	Approx. Weight lbs/kft (kg/km)	Flat Plate Crush Resistance lbs/in (kg/mm)	Maximum Pulling Force lbs (kg)
		Inner Conductor	Dielectric	Outer Conductor	Jacket				
LHF-12DP	½ (12)	0.19 (4.8)	0.47 (12.0)	0.54 (13.8)	0.58 (14.8)	5.91 (150)	139 (207)	58 (1.05)	249 (113)

## ELECTRICAL SPECIFICATIONS

Part Number	Cable Size in (mm)	Conductor DC Resistance Ohms/kft (Ohms/km)		Minimum Insulation Resistance mΩ km	Dielectric Strength for 1 minute DC Potential - Volts	Velocity of Propagation %	Peak Power Rating kW	Maximum Operating Frequency GHz	Characteristic Impedance Ohms	Typical Return Loss dB
		Inner	Outer							
LHF-12DP	½ (12)	0.50 (1.6)	0.85 (2.8)	10,000	4,000	88	40	8.8	50 ± 2	19

Frequency MHz	Nominal Attenuation* dB/100 ft (dB/100 m)	Average Power Rating at Ambient 40 °C Inner Conductor 100 °C
		kW
30	0.35 (1.15)	4.70
100	0.65 (2.14)	2.54
150	0.80 (2.64)	2.06
450	1.43 (4.68)	1.15
824	1.97 (6.46)	0.83
890	2.05 (6.73)	0.80
960	2.14 (7.02)	0.77
1,000	2.18 (7.17)	0.75
1,700	2.92 (9.58)	0.56
1,800	3.01 (9.89)	0.54
2,000	3.19 (10.48)	0.51
2,400	3.53 (11.60)	0.46
3,000	4.07 (13.37)	0.40

Frequency MHz	VSWR
806-960	≤ 1.25
1,700-2,155	≤ 1.25

\*The attenuation may rise by 0.2%/°C with rising temperature.  
Maximum attenuation shall not exceed 105% of nominal value.  
Standard Conditions: VSWR 1.0, Ambient Temperature 20°C/Attenuation is typical value.  
UL is a registered trademark of UL LLC.

# HFSC Riser

Super Flexible Foam Dielectric Feeder

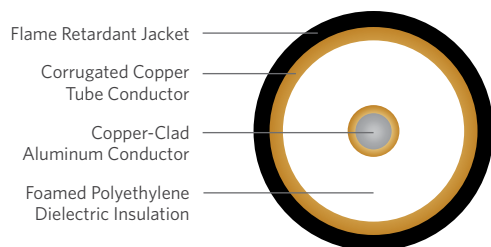

Flame Retardant Jacket  
Corrugated Copper Tube Conductor  
Copper-Clad Aluminum Conductor  
Foamed Polyethylene Dielectric Insulation

## PRODUCT DESCRIPTION

HFSC-12DR is a ½ inch, 50 Ohm Riser Rated RF coaxial cable that enables mobile communications inside buildings. Installed to eliminate dead zones and spotty coverage, this cable functions as the backbone cable of in-building DAS wireless systems. With its riser (CMR) rating, this coaxial cable offers flexibility and high crush resistance in a ½ inch size. Designed for high performance, its copper clad aluminum inner conductor, foamed PE dielectric insulation, corrugated copper outer conductor and its black outer riser rated jacket exceed the requirements of all in-building DAS active systems.

## APPLICATIONS

- In-building Wireless
- Distributed Antenna System (DAS)

## FEATURES

- Low minimum bending radius and bending moment
- Low attenuation
- Low passive intermodulation
- Non-halogenated, fire retardant, black polyethylene jacket
- ETL Certified CMR (UL® 1666)/CATVR (UL 1581)
- Full range of easy to install connectors and an automated cable prep tool

## BENEFITS

- Super flexible cable is ideally suited for installations where multiple bends are required
- Highly efficient signal transfer
- Outperforms the industry requirements for low PIM
- Rugged and durable jacket slows the spread of flame without releasing toxic smoke
- Suitable for vertical cable runs in a shaft or that penetrate more than one floor within a building
- Shortens installation time and expenses

## RELATED PRODUCTS

- Connectors CHFS-12xx
- Cable prep tool T-HFSC12DR
- Jumpers JRI2xxxxx

## SPECIFICATIONS

Inner Conductor Material	Copper-clad aluminum
Dielectric Material	Foamed polyethylene
Outer Conductor Material	Corrugated copper tube
Jacket Material	Black, flame retardant PE
Recommended Operating Temperature °F (°C)	-22 to +167 (-30 to +75)

## PART NUMBERS AND PHYSICAL CHARACTERISTICS

Part Number	Cable Size in (mm)	Nominal Diameter in (mm)				Minimum Bend Radius in (mm)	Approx. Weight lbs/kft (kg/km)	Flat Plate Crush Resistance lbs/in (kg/mm)	Maximum Pulling Force lbs (kg)
		Inner Conductor	Dielectric	Outer Conductor	Jacket				
HFSC-12DR	½ (12)	0.14 (3.6)	0.35 (8.9)	0.48 (12.2)	0.55 (13.9)	1.26 (32)	137 (204)	95 (1.7)	143 (65)

## ELECTRICAL SPECIFICATIONS

Part Number	Cable Size in (mm)	Conductor DC Resistance Ohms/kft (Ohms/km)		Minimum Insulation Resistance mΩ km	Dielectric Strength for 1 minute DC Potential - Volts	Velocity of Propagation %	Peak Power Rating kW	Maximum Operating Frequency GHz	Characteristic Impedance Ohms	Typical Return Loss dB
		Inner	Outer							
HFSC-12DR	½ (12)	0.87 (2.85)	1.14 (3.75)	10,000	2,500	81	15.6	10.0	50 ± 2	23

Frequency MHz	Nominal Attenuation* dB/100 ft (dB/100 m)	Average Power Rating at Ambient 40°C Inner Conductor 100°C kW
30	0.55 (1.80)	4.87
100	1.02 (3.33)	2.62
150	1.25 (4.10)	2.12
450	2.20 (7.29)	1.19
824	3.08 (10.10)	0.85
890	3.20 (10.50)	0.82
960	3.35 (11.00)	0.79
1,000	3.41 (11.20)	0.77
1,700	4.57 (15.00)	0.57
1,800	4.72 (15.50)	0.55
2,000	5.00 (16.40)	0.52
2,400	5.55 (18.20)	0.47
3,000	6.31 (20.70)	0.41

Frequency MHz	VSWR
806-960	≤ 1.15
1,700-2,155	≤ 1.15

\*The attenuation may rise by 0.2%/°C with rising temperature. Maximum attenuation shall not exceed 105% of nominal value. Standard Conditions: VSWR 1.0, Ambient Temperature 20°C/Attenuation is typical value. UL is a registered trademark of UL LLC.



# HFSC Plenum

## Super Flexible Air Dielectric Feeder

### PRODUCT DESCRIPTION

HFSC-12DP is a ½ inch, 50 ohm Plenum Rated RF coaxial cable that enables mobile communications inside buildings. Installed to eliminate dead zones and spotty coverage, this cable is normally installed in the plenum space on runs to ceiling antennas spaced through DAS wireless systems. With its Plenum (CMP) rating, this coaxial cable offers crush resistance in a ½ inch Super Flexible construction. Designed for high performance, its copper clad aluminum inner conductor, air dielectric center support, helically corrugated copper tube outer conductor and its white outer plenum rated jacket exceeds the RF requirements of all in-building DAS active systems.

### APPLICATIONS

- In-building Wireless
- Distributed Antenna System (DAS)

### FEATURES

- Low minimum bending radius and bending moment
- Low attenuation
- Low passive intermodulation
- High-quality, white PVDF jacket
- ETL Certified CMP (UL® 444)
- Full range of easy to install connectors and an automated cable prep tool

### BENEFITS

- Super flexible cable is ideally suited for installations where multiple bends are required
- Highly efficient signal transfer
- Outperforms the industry requirements for low PIM
- Flame retardant and low smoke; blends with background for optimal building aesthetics
- Safe to use throughout a building including air carrying plenum space
- Shortens installation time and expenses

### RELATED PRODUCTS

- Connectors CHFSP12xx
- Cable prep tool T-HFSC12DP
- Jumpers JP12xxxxx

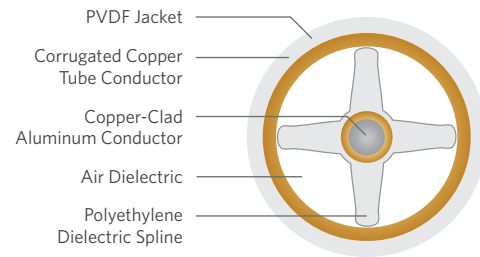

### SPECIFICATIONS

Inner Conductor Material	Copper-clad aluminum
Dielectric Material	Polyethylene
Outer Conductor Material	Corrugated copper tube
Jacket Material	White, PVDF
Recommended Operating Temperature °F (°C)	-4 to +167 (-20 to +75)

### PART NUMBERS AND PHYSICAL CHARACTERISTICS

Part Number	Cable Size in (mm)	Nominal Diameter in (mm)				Minimum Bend Radius in (mm)	Approx. Weight lbs/kft (kg/km)	Flat Plate Crush Resistance lbs/in (kg/mm)	Maximum Pulling Force (kg)
		Inner Conductor	Dielectric	Outer Conductor	Jacket				
HFSC-12DP	½ (12)	0.14 (3.6)	0.35 (8.9)	0.48 (12.2)	0.52 (13.2)	1.26 (32)	131 (195)	95 (1.7)	143 (65)

### ELECTRICAL SPECIFICATIONS

Part Number	Cable Size in (mm)	Conductor DC Resistance Ohms/kft (Ohms/km)		Insulation Resistance mΩ km	Dielectric Strength for 1 minute DC Potential - Volts	Velocity of Propagation %	Peak Power Rating kW	Maximum Operating Frequency GHz	Characteristic Impedance Ohms	Typical Return Loss dB
		Inner	Outer							
HFSC-12DP	½ (12)	0.86 (2.85)	1.14 (3.75)	10,000	2,500	81	15.6	10.0	50 ± 2	23

Frequency MHz	Attenuation at 20 °C dB/100 ft (dB/100 m)		Average Power Rating at Ambient 40 °C Inner Conductor 100 °C kW	
	HFSC-12DP	HFSC-12DP	HFSC-12DP	HFSC-12DP
30	0.55 (1.80)	3.23		
100	1.01 (3.33)	1.73		
150	1.25 (4.10)	1.40		
450	2.22 (7.29)	0.78		
824	3.08 (10.10)	0.56		
894	3.20 (10.50)	0.54		
960	3.35 (11.00)	0.51		
1,000	3.41 (11.20)	0.50		
1,700	4.57 (15.00)	0.37		
1,800	4.72 (15.50)	0.36		
2,000	5.00 (16.40)	0.34		
2,400	5.55 (18.20)	0.30		
3,000	6.31 (20.70)	0.27		

Frequency MHz	VSWR
806-960	≤ 1.25
1,700-2,155	≤ 1.25

Standard Conditions: VSWR 1.0, Ambient Temperature 20°C/Attenuation is typical value. UL is a registered trademark of UL LLC.

# HFAC Riser

Low Loss High Flexible Foam Dielectric Feeder

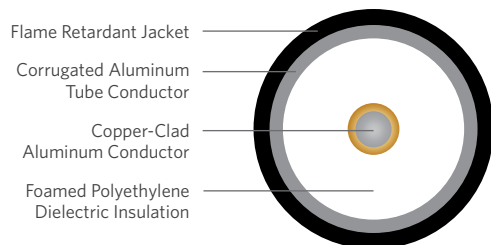

Flame Retardant Jacket  
Corrugated Aluminum Tube Conductor  
Copper-Clad Aluminum Conductor  
Foamed Polyethylene Dielectric Insulation

## PRODUCT DESCRIPTION

HFAC-12DR is a ½ inch, 50 Ohm Riser Rated RF Coaxial Cable that enables mobile communications inside buildings. Installed to eliminate dead zones and spotty coverage, this cable functions as the backbone cable of in-building, DAS wireless systems. With its riser (CMR) rating, this coaxial cable offers flexibility and high crush resistance in a ½ inch size. Designed for high performance, its copper clad aluminum inner conductor, foamed PE dielectric insulation, corrugated aluminum outer conductor and its black outer riser rated jacket exceed the requirements of all in-building DAS active systems.

## APPLICATIONS

- In-building Wireless
- Distributed Antenna System (DAS)

## FEATURES

- Low attenuation
- Low passive intermodulation
- Non-halogenated, fire retardant, black polyethylene Jacket
- ETL Certified CMR(UL® 1666)/CATVR (UL 1581)
- Full range of easy to install connectors and an automated cable prep tool

## BENEFITS

- Highly efficient signal transfer
- Outperforms the industry requirements for low PIM
- Rugged and durable jacket slows the spread of flame without releasing toxic smoke
- Suitable for vertical cable runs in a shaft or that penetrate more than one floor within a building
- Shortens installation time and expenses

## RELATED PRODUCTS

- Connectors CHFA-12xx
- Cable prep tool T-HFA12DR

## SPECIFICATIONS

Inner Conductor Material	Copper-clad aluminum
Dielectric Material	Foamed polyethylene
Outer Conductor Material	Corrugated aluminum tube
Jacket Material	Black, flame retardant PE
Recommended Operating Temperature °F (°C)	-22 to +167 (-30 to +75)

## PART NUMBERS AND PHYSICAL CHARACTERISTICS

Part Number	Cable Size in (mm)	Nominal Diameter in (mm)				Minimum Bend Radius in (mm)	Approx. Weight lbs/kft (kg/km)	Flat Plate Crush Resistance lbs/in (kg/mm)	Maximum Pulling Force lbs (kg)
		Inner Conductor	Dielectric	Outer Conductor	Jacket				
HFAC-12DR	½ (12)	0.19 (4.8)	0.47 (12.0)	0.54 (13.8)	0.63 (15.9)	4.92 (125)	60 (198)	84 (1.5)	174 (79)

## ELECTRICAL SPECIFICATIONS

Part Number	Cable Size in (mm)	Conductor DC Resistance Ohms/kft (Ohms/km)		Minimum Insulation Resistance mΩ km	Dielectric Strength for 1 minute DC Potential - Volts	Velocity of Propagation %	Peak Power Rating kW	Maximum Operating Frequency GHz	Characteristic Impedance Ohms	Typical Return Loss dB
		Inner	Outer							
HFAC-12DR	½ (12)	0.50 (1.6)	0.67 (2.2)	10,000	4,000	88	40	8.8	50 ± 1	21

Frequency MHz	Nominal Attenuation* dB/100 ft (dB/100 m)	Average Power Rating at Ambient 40°C Inner Conductor 100°C kW	
		Inner	Outer
30	0.39 (1.29)	5.95	3.24
100	0.72 (2.37)	3.24	2.63
150	0.89 (2.92)	2.63	1.50
450	1.57 (5.14)	1.50	1.09
824	2.15 (7.06)	1.09	1.05
890	2.24 (7.35)	1.05	1.01
960	2.33 (7.65)	1.01	0.99
1,000	2.38 (7.82)	0.99	0.75
1,700	3.16 (10.38)	0.75	0.73
1,800	3.26 (10.70)	0.73	0.69
2,000	3.45 (11.33)	0.69	0.62
2,400	3.81 (12.51)	0.62	0.55
3,000	4.32 (14.17)	0.55	

Frequency MHz	VSWR
806-960	≤ 1.20
1,700-2,155	≤ 1.20

\*The attenuation may rise by 0.2%/°C with rising temperature. Maximum attenuation shall not exceed 110% of nominal value. Standard Conditions: VSWR 1.0, Ambient Temperature 20°C/Attenuation is typical value. UL is a registered trademark of UL LLC.

# HFAC Plenum

Low Loss High Flexible Air Dielectric Feeder

## PRODUCT DESCRIPTION

HFAC-12DP is a ½ inch, low loss 50 Ohm Plenum Rated RF coaxial cable that is installed in the plenum space of a building as part of an in-building DAS system to eliminate dead zones and spotty coverage. Designed with a copper clad aluminum center conductor, air dielectric center structure, helically corrugated aluminum tube outer conductor, and Plenum Rated outer jacket, the HFAC-12DP is a high performing cable with low loss attenuation.

## APPLICATIONS

- In-building Wireless
- Distributed Antenna System (DAS)

## FEATURES

- Low attenuation
- Low passive intermodulation
- High-quality, white PVDF jacket
- ETL Certified CMP (UL® 444)
- Full range of easy to install connectors and an automated cable prep tool

## BENEFITS

- Highly efficient signal transfer
- Outperforms the industry requirements for low PIM
- Flame retardant and low smoke; blends with background for optimal building aesthetics
- Safe to use throughout a building including air carrying plenum space
- Shortens installation time and expenses

## RELATED PRODUCTS

- Connectors CHFAP-12xx
- Cable prep tool T-LHFA12DP

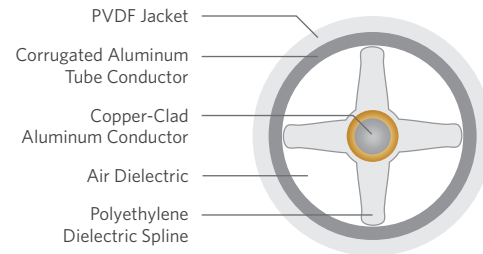

## SPECIFICATIONS

Inner Conductor Material	Copper-clad aluminum
Dielectric Material	Polyethylene
Outer Conductor Material	Corrugated aluminum tube
Jacket Material	White, PVDF
Recommended Operating Temperature °F (°C)	-4 to +167 (-20 to +75)

## PART NUMBERS AND PHYSICAL CHARACTERISTICS

Part Number	Cable Size in (mm)	Nominal Diameter in (mm)				Minimum Bend Radius in (mm)	Approx. Weight lbs/kft (kg/km)	Flat Plate Crush Resistance lbs/in (kg/mm)	Maximum Pulling Force lbs (kg)
		Inner Conductor	Dielectric	Outer Conductor	Jacket				
HFAC-12DP	½ (12)	0.19 (4.8)	0.47 (12.0)	0.54 (13.8)	0.58 (14.8)	5.91 (150)	111 (166)	39 (0.7)	174 (79)

## ELECTRICAL SPECIFICATIONS

Part Number	Cable Size in (mm)	Conductor DC Resistance Ohms/kft (Ohms/km)		Minimum Insulation Resistance mΩ km	Dielectric Strength for 1 minute DC Potential - Volts	Velocity of Propagation %	Peak Power Rating kW	Maximum Operating Frequency GHz	Characteristic Impedance Ohms	Typical Return Loss dB
		Inner	Outer							
HFAC-12DP	½ (12)	0.50 (1.6)	0.67 (2.2)	10,000	4,000	88	40	8.8	50 ± 2	19

Frequency MHz	Nominal Attenuation* dB/100 ft (dB/100 m)	Average Power Rating at Ambient 40 °C Inner Conductor 100 °C kW
30	0.40 (1.32)	4.46
100	0.73 (2.41)	2.41
150	0.90 (2.97)	1.95
450	1.59 (5.22)	1.10
824	2.19 (7.19)	0.79
890	2.28 (7.49)	0.76
960	2.38 (7.81)	0.73
1,000	2.43 (7.98)	0.71
1,700	3.25 (10.66)	0.53
1,800	3.36 (11.03)	0.52
2,000	3.63 (11.90)	0.49
2,400	3.93 (12.90)	0.44
3,000	4.44 (14.57)	0.39

Frequency MHz	VSWR
806-960	≤ 1.25
1,700-2,155	≤ 1.25

\*The attenuation may rise by 0.2%/°C with rising temperature.  
Maximum attenuation shall not exceed 110% of nominal value.  
Standard Conditions: VSWR 1.0, Ambient Temperature 20°C/Attenuation is typical value.  
UL is a registered trademark of UL LLC.

# DAS Riser Jumper Cable



## PRODUCT DESCRIPTION

Jumper cables offer outstanding electrical performance and reliability, high durability for tight routing, and superior environmental sealing for sustained longevity.

Available in ½ inch diameters, jumper cables are used in areas that require an extremely small bending radius between main feeders and antennas or between main feeders and RF equipment.

## FEATURES/BENEFITS

- High pull-off strength
- Excellent VSWR performance
- Low and stable passive intermodulation
- Weatherproof

## SPECIFICATIONS

Compatible Cable Type	HFSC-12DR
Compatible Cable Size in (mm)	½ (12)
Minimum Bend Radius in (mm)	1.38 (35)
Typical VSWR	1.08 over Cellular, PCS and 3G-band
Intermodulation (PIM) dBc	< -158

## PART NUMBERS AND PHYSICAL CHARACTERISTICS

Part Number	Interface Type		Standard Length ft (m)	Unit of Measure
	End 1	End 2		
JR121NMNM	N Male Straight	N Male Straight	3.2 (1)	Each
JR122NMNM	N Male Straight	N Male Straight	6.6 (2)	Each
JR123NMNM	N Male Straight	N Male Straight	9.8 (3)	Each
JR121NMNF	N Male Straight	N Female Straight	3.2 (1)	Each
JR122NMNF	N Male Straight	N Female Straight	6.6 (2)	Each
JR123NMNF	N Male Straight	N Female Straight	9.8 (3)	Each
JR121NMFN	N Female Straight	N Female Straight	3.2 (1)	Each
JR122NMFN	N Female Straight	N Female Straight	6.6 (2)	Each
JR123NMFN	N Female Straight	N Female Straight	9.8 (3)	Each
JR121NMRF	N Male Straight	N Male Right Angle	3.2 (1)	Each
JR122NMRF	N Male Straight	N Male Right Angle	6.6 (2)	Each
JR123NMRF	N Male Straight	N Male Right Angle	9.8 (3)	Each
JR121NMFN	N Male Straight	N Female Right Angle	3.2 (1)	Each
JR122NMFN	N Male Straight	N Female Right Angle	6.6 (2)	Each
JR123NMFN	N Male Straight	N Female Right Angle	9.8 (3)	Each
JR121NFRF	N Female Straight	N Female Right Angle	3.2 (1)	Each
JR122NFRF	N Female Straight	N Female Right Angle	6.6 (2)	Each
JR123NFRF	N Female Straight	N Female Right Angle	9.8 (3)	Each

## EXPLANATION OF PART NUMBERS

### JR122NMNM

Product Category	Fire Safety Listing	Compatible Cable Size	Jumper Length	Connector for End 1	Connector for End 2
J = Jumper Cable	R = Riser Rating P = Plenum Rating	12 = ½ inch (12 mm)	1 = 1 meter 2 = 2 meters 3 = 3 meters	NM = N Male straight RM = N Right angle Male NF = N Female RF = N Right angle Female	NM = N Male straight RM = N Right angle Male NF = N Female RF = N Right angle Female

# DAS Plenum Jumper Cable

## PRODUCT DESCRIPTION

Jumper cables offer outstanding electrical performance and reliability, high durability for tight routing, and superior environmental sealing for sustained longevity.

Available in ½ inch diameters, jumper cables are used in areas that require an extremely small bending radius between main feeders and antennas or between main feeders and RF equipment.

## FEATURES/BENEFITS

- High pull-off strength
- Excellent VSWR performance
- Low and stable passive intermodulation
- Weatherproof



## SPECIFICATIONS

Compatible Cable Type	HFSC-12DP
Compatible Cable Size in (mm)	½ (12)
Minimum Bend Radius in (mm)	1.38 (35)
Typical VSWR	1.08 over Cellular, PCS and 3G-band
Intermodulation (PIM) dBc	< -158

## PART NUMBERS AND PHYSICAL CHARACTERISTICS

Part Number	Interface Type		Standard Length ft (m)	Unit of Measure
	End 1	End 2		
JP121NMNM	N Male Straight	N Male Straight	3.2 (1)	Each
JP122NMNM	N Male Straight	N Male Straight	6.6 (2)	Each
JP123NMNM	N Male Straight	N Male Straight	9.8 (3)	Each
JP121NMNF	N Male Straight	N Female Straight	3.2 (1)	Each
JP122NMNF	N Male Straight	N Female Straight	6.6 (2)	Each
JP123NMNF	N Male Straight	N Female Straight	9.8 (3)	Each
JP121NFNF	N Female Straight	N Female Straight	3.2 (1)	Each
JP122NFNF	N Female Straight	N Female Straight	6.6 (2)	Each
JP123NFNF	N Female Straight	N Female Straight	9.8 (3)	Each
JP121NMRRM	N Male Straight	N Male Right Angle	3.2 (1)	Each
JP122NMRRM	N Male Straight	N Male Right Angle	6.6 (2)	Each
JP123NMRRM	N Male Straight	N Male Right Angle	9.8 (3)	Each
JP121NMRF	N Male Straight	N Female Right Angle	3.2 (1)	Each
JP122NMRF	N Male Straight	N Female Right Angle	6.6 (2)	Each
JP123NMRF	N Male Straight	N Female Right Angle	9.8 (3)	Each
JP121NFRF	N Female Straight	N Female Right Angle	3.2 (1)	Each
JP122NFRF	N Female Straight	N Female Right Angle	6.6 (2)	Each
JP123NFRF	N Female Straight	N Female Right Angle	9.8 (3)	Each

## EXPLANATION OF PART NUMBERS

### JR122NMNM

Product Category	Fire Safety Listing	Compatible Cable Size	Jumper Length	Connector for End 1	Connector for End 2
J = Jumper Cable	R = Riser Rating P = Plenum Rating	12 = ½ inch (12 mm)	1 = 1 meter 2 = 2 meters 3 = 3 meters	NM = N Male straight RM = N Right angle Male NF = N Female RF = N Right angle Female	NM = N Male straight RM = N Right angle Male NF = N Female RF = N Right angle Female

# DIN Series for LHF



## SPECIFICATIONS

Bodies, Cap (Coupling Nut) Material	Brass/silver plated or Su Co (Alloy of Cu/Sn/Zn) plated
Back Nut Material	Brass/nickel plated
Pin Material	Male: Brass/silver plated or Su Co (Alloy of Cu/Sn/Zn) plated Female: Beryllium - copper/silver plated or Su Co (Alloy of Cu/Sn/Zn) plated
Insulator Material	Plated PTFE (Teflon®)
Gasket Material	Silicon rubber

Teflon is a registered trademark of E. I. du Pont de Nemours and Company or its affiliates.

## ELECTRICAL SPECIFICATIONS

Impedance Ω	50
Maximum Frequency Range GHz	7.5
VSWR (Mating) straight (right angle)	1 GHz: 1.08 (1.12) 2 GHz: 1.10 (1.15)
Maximum Insertion Loss dB @ 3 GHz	-0.2
Intermodulation (PIM) dBc	< -155
Dielectric Withstanding Voltage kV rms @ 50 Hz	4.0
Working Voltage kV rms @ 50 Hz	2.7
Insulation Resistance GΩ	10
Contact Resistance mΩ	Inner: ≤ 1.5 Outer: ≤ 1.5

## PRODUCT DESCRIPTION

This DIN Series is compatible with the LHF In-Building Series. The connectors are manufactured from an alloy material of copper, tin and zinc to produce a highly polished, precise, and strong connector. This alloy combination allows a better operating temperature range and improved environmental performance.

## FEATURES/BENEFITS

- Two-piece design is the industry standard
- Simple, user-friendly installation process
- Connector can be disassembled and re-used
- Offers stable, low PIM connections

## ENVIRONMENTAL SPECIFICATIONS

Temperature Range °F (°C)	-49 to +185 (-45 to +85)
Corrosion (Salt Spray Test)	IEC-68-2-11-Ka
Vibration	CECC 22000 Part 4.6.3
Waterproof	IP68

## PART NUMBERS AND PHYSICAL CHARACTERISTICS

Part Number	Compatible Cable Type	Compatible Cable Size in (mm)	DIN Interface Type		Length in (mm)	Diameter in (mm)	Weight oz (g)
			Gender	Straight or Angle			
CLH-12DF	LHF Riser	½ (12)	Female	Straight	2.65 (67.4)	0.86 (21.8)	5.3 (150)
CLH-12DM	LHF Riser	½ (12)	Male	Straight	2.57 (65.4)	0.86 (21.8)	6.5 (183)
CLH-12DMR	LHF Riser	½ (12)	Male	Right Angle	-	-	-
CLHP-12DF	LHF Plenum	½ (12)	Female	Straight	2.26 (57.4)	0.86 (21.8)	5.3 (150)
CLHP-12DM	LHF Plenum	½ (12)	Male	Straight	2.18 (55.4)	0.86 (21.8)	5.3 (150)
CLHP12DMR	LHF Plenum	½ (12)	Male	Right Angle	-	-	-



### TECHNICAL GUIDELINE

Installation guidelines are available for these connectors. Refer to the "Resources" section on our site for the Technical Guideline, "DIN Connectors and N Connectors Installation Guidelines," for more information.

## PRODUCT DESCRIPTION

This DIN Series is compatible with the HFSC In-Building Series. The connectors are manufactured from an alloy material of copper, tin and zinc to produce a highly polished, precise, and strong connector. This alloy combination allows a better operating temperature range and improved environmental performance.

## FEATURES/BENEFITS

- Two-piece design is the industry standard
- Simple, user-friendly installation process
- Ordinary tools needed; available in a common installers tool bag
- Connector can be disassembled and re-used
- Offers stable, low PIM connections



## SPECIFICATIONS

<b>Bodies, Cap (Coupling Nut) Material</b>	Brass/silver plated or Su Co (Alloy of Cu/Sn/Zn) plated
<b>Back Nut Material</b>	Brass/nickel plated
<b>Pin Material</b>	Male: Brass/silver plated or Su Co (Alloy of Cu/Sn/Zn) plated Female: Beryllium - copper/silver plated or Su Co (Alloy of Cu/Sn/Zn) plated
<b>Insulator Material</b>	Plated PTFE (Teflon®)
<b>Gasket Material</b>	Silicon rubber

Teflon is a registered trademark of E. I. du Pont de Nemours and Company or its affiliates.

## ELECTRICAL SPECIFICATIONS

<b>Impedance</b> Ω	50
<b>Maximum Frequency Range</b> GHz	7.5
<b>VSWR (Mating)</b> straight (right angle)	1 GHz: 1.08 (1.12) 2 GHz: 1.10 (1.15)
<b>Maximum Insertion Loss</b> dB @ 3 GHz	-0.2
<b>Intermodulation (PIM)</b> dBc	< -155
<b>Dielectric Withstanding Voltage</b> kV rms @ 50 Hz	4.0
<b>Working Voltage</b> kV rms @ 50 Hz	2.7
<b>Insulation Resistance</b> GΩ	10
<b>Contact Resistance</b> mΩ	Inner: 0.4 Outer: 1.5

## ENVIRONMENTAL SPECIFICATIONS

<b>Temperature Range</b> °F (°C)	-49 to +185 (-45 to +85)
<b>Corrosion (Salt Spray Test)</b>	IEC-68-2-11-Ka
<b>Vibration</b>	CECC 22000 Part 4.6.3
<b>Waterproof</b>	IP68

## PART NUMBERS AND PHYSICAL CHARACTERISTICS

Part Number	Compatible Cable Type	Compatible Cable Size in (mm)	DIN Interface Type		Length in (mm)	Diameter in (mm)	Weight oz (g)
			Gender	Straight or Angle			
CHFS-12DF	HFSC Riser	½ (12)	Female	Straight	2.65 (67.4)	0.86 (21.8)	5.3 (150)
CHFS-12DM	HFSC Riser	½ (12)	Male	Straight	2.57 (65.4)	0.86 (21.8)	6.5 (183)
CHFS12DMR	HFSC Riser	½ (12)	Male	Right Angle	-	-	-
CHFSP12DF	HFSC Plenum	½ (12)	Female	Straight	2.21 (56.2)	0.92 (23.4)	5.3 (150)
CHFSP12DM	HFSC Plenum	½ (12)	Male	Straight	2.25 (57.3)	0.92 (23.4)	6.5 (183)
CHFSP12DMR	HFSC Plenum	½ (12)	Male	Right Angle	-	-	-



## TECHNICAL GUIDELINE

Installation guidelines are available for these connectors. Refer to the "Resources" section on our site for the Technical Guideline, "DIN Connectors and N Connectors Installation Guidelines," for more information.

# DIN Series for HFAC



## SPECIFICATIONS

Bodies, Cap (Coupling Nut) Material	Brass/silver plated or Su Co (Alloy of Cu/Sn/Zn) plated
Back Nut Material	Brass/nickel plated
Pin Material	Male: Brass/silver plated or Su Co (Alloy of Cu/Sn/Zn) plated Female: Beryllium - copper/silver plated or Su Co (Alloy of Cu/Sn/Zn) plated
Insulator Material	Plated PTFE (Teflon®)
Gasket Material	Silicon rubber

Teflon is a registered trademark of E. I. du Pont de Nemours and Company or its affiliates.

## ELECTRICAL SPECIFICATIONS

Impedance Ω	50
Maximum Frequency Range GHz	7.5
VSWR (Mating) straight (right angle)	1 GHz: 1.08 (1.12) 2 GHz: 1.10 (1.15)
Maximum Insertion Loss dB @ 3 GHz	-0.2
Intermodulation (PIM) dBc	< -155
Dielectric Withstanding Voltage kV rms @ 50 Hz	4.0
Working Voltage kV rms @ 50 Hz	2.7
Insulation Resistance GΩ	10
Contact Resistance mΩ	Inner: 0.4 Outer: 1.5

## PRODUCT DESCRIPTION

This DIN Series is compatible with the HFAC In-Building Series. The connectors are manufactured from an alloy material of copper, tin and zinc to produce a highly polished, precise, and strong connector. This alloy combination allows a better operating temperature range and improved environmental performance.

## FEATURES/BENEFITS

- Two-piece design is the industry standard
- Simple, user-friendly installation process
- Ordinary tools needed; available in a common installers tool bag
- Connector can be disassembled and re-used
- Offers stable, low PIM connections

## ENVIRONMENTAL SPECIFICATIONS

Temperature Range °F (°C)	-49 to +185 (-45 to +85)
Corrosion (Salt Spray Test)	IEC-68-2-11-Ka
Vibration	CECC 22000 Part 4.6.3
Waterproof	IP68

## PART NUMBERS AND PHYSICAL CHARACTERISTICS

Part Number	Compatible Cable Type	Compatible Cable Size in (mm)	DIN Interface Type		Length in (mm)	Diameter in (mm)	Weight oz (g)
			Gender	Straight or Angle			
CHFA-12DF	HFAC Riser	½ (12)	Female	Straight	2.65 (67.4)	0.86 (21.8)	5.3 (150)
CHFA-12DM	HFAC Riser	½ (12)	Male	Straight	2.57 (65.4)	0.86 (21.8)	6.5 (183)
CHFA12DMR	HFAC Riser	½ (12)	Male	Right Angle	-	-	-
CHFAP12DF	HFAC Plenum	½ (12)	Female	Straight	2.26 (57.4)	0.86 (21.8)	5.3 (150)
CHFAP12DM	HFAC Plenum	½ (12)	Male	Straight	2.18 (55.4)	0.86 (21.8)	5.3 (150)
CHFAP12DMR	HFAC Plenum	½ (12)	Male	Right Angle	-	-	-



### TECHNICAL GUIDELINE

Installation guidelines are available for these connectors. Refer to the "Resources" section on our site for the Technical Guideline, "DIN Connectors and N Connectors Installation Guidelines," for more information.



## PRODUCT DESCRIPTION

This N Series connector is compatible with the LHF Series In-building Cable. The connectors are manufactured from an alloy material of copper, tin and zinc to produce a highly polished, strong connector. This alloy combination allows for a better operating temperature range and improved environmental performance.

## FEATURES/BENEFITS

- Two-piece design is the industry standard
- Simple user friendly installation process
- Connector can be disassembled and re-used
- Offers stable, low PIM connections

## ELECTRICAL SPECIFICATIONS

Impedance Ω	50
Maximum Frequency Range GHz	7.5
VSWR @ 700-2,200 MHz straight (right angle)	1.08 (1.15)
Maximum Insertion Loss dB @ 700-2,200 MHz straight (right angle)	0.1 (0.15)
Intermodulation (PIM) dBc	-155
Dielectric Withstanding Voltage kV rms @ 50 Hz	4.0
Working Voltage kV rms @ 50 Hz	2.7
Peak Power kW	10
Insulation Resistance MΩ	≥ 5,000
Contact Resistance mΩ	Inner: ≤ 1.0 Outer: ≤ 1.0

## ENVIRONMENTAL SPECIFICATIONS

Temperature Range °F (°C)	-40 to +185 (-40 to +85)
Corrosion (Salt Spray Test)	IEC-68-2-11-Ka
Vibration	CECC 22000 Part 4.6.3
Waterproof	IP68



## SPECIFICATIONS

Bodies, Cap (Coupling Nut) Material	Brass/silver plated or Su Co (Alloy of Cu/Sn/Zn) plated
Back Nut Material	Brass/nickel plated
Pin Material	Male: Brass/silver plated or Su Co (Alloy of Cu/Sn/Zn) plated Female: Beryllium - copper/silver plated or Su Co (Alloy of Cu/Sn/Zn) plated
Insulator Material	Plated PTFE (Teflon®)
Gasket Material	Silicon rubber
Recommended Coupling Nut Torque Nm	0.68-1.13
Coupling Nut Retention Force Nm	1,000
Contact Captivation N	200
Mating Durability	500 times

Teflon is a registered trademark of E. I. du Pont de Nemours and Company or its affiliates.

## PART NUMBERS AND PHYSICAL CHARACTERISTICS

Part Number	Compatible Cable Type	Compatible Cable Size in (mm)	N Interface Type		Length in (mm)	Diameter in (mm)	Weight oz (g)
			Gender	Straight or Angle			
CLH-12NF	LHF Riser	½ (12)	Female	Straight	2.75 (69.8)	0.86 (21.8)	4.1 (115)
CLH-12NFR	LHF Riser	½ (12)	Female	Right Angle	-	-	-
CLH-12NM	LHF Riser	½ (12)	Male	Straight	2.75 (69.8)	0.86 (21.8)	4.2 (120)
CLH-12NMR	LHF Riser	½ (12)	Male	Right Angle	-	-	-
CLHP-12NF	LHF Plenum	½ (12)	Female	Straight	2.75 (69.8)	0.86 (21.8)	4.1 (115)
CLHP12NFR	LHF Plenum	½ (12)	Female	Right Angle	-	-	-
CLHP12NM	LHF Plenum	½ (12)	Male	Straight	2.75 (69.8)	0.86 (21.8)	4.2 (120)
CLHP12NMR	LHF Plenum	½ (12)	Male	Right Angle	-	-	-



## TECHNICAL GUIDELINE

Installation guidelines are available for these connectors. Refer to the "Resources" section on our site for an instructional video or the Technical Guideline, "DIN Connectors and N Connectors Installation Guidelines," for more information.

# N Series for HFSC



## PRODUCT DESCRIPTION

This N Series connector is compatible with the HFSC Series In-building Cable. The connectors are manufactured from an alloy material of copper, tin and zinc to produce a highly polished, strong connector. This alloy combination allows for a better operating temperature range and improved environmental performance.

## FEATURES/BENEFITS

- Two-piece design is the industry standard
- Simple user-friendly installation process
- Connector can be disassembled and re-used
- Offers stable, low PIM connections

## ELECTRICAL SPECIFICATIONS

Impedance $\Omega$	50
Maximum Frequency Range GHz	7.5
VSWR @ 700–2,200 MHz straight (right angle)	1.08 (1.10)
Maximum Insertion Loss dB @ @ 700–2,200 MHz straight (right angle)	0.1 (0.15)
Intermodulation (PIM) dBc	-155
Dielectric Withstanding Voltage kV rms @ 50 Hz	4.0
Working Voltage kV rms @ 50 Hz	2.7
Peak Power kW	10
Insulation Resistance M $\Omega$	$\geq 5,000$
Contact Resistance m $\Omega$	Inner: 1.0 Outer: 1.0

## ENVIRONMENTAL SPECIFICATIONS

Temperature Range °F (°C)	-40 to +185 (-40 to +85)
Corrosion (Salt Spray Test)	IEC-68-2-11-Ka
Vibration	CECC 22000 Part 4.6.3
Waterproof	IP68

## SPECIFICATIONS

Bodies, Cap (Coupling Nut) Material	Brass/silver plated or Su Co (Alloy of Cu/Sn/Zn) plated
Back Nut Material	Brass/nickel plated
Pin Material	Male: Brass/silver plated or Su Co (Alloy of Cu/Sn/Zn) plated Female: Beryllium - copper/silver plated or Su Co (Alloy of Cu/Sn/Zn) plated
Insulator Material	Plated PTFE (Teflon®)
Gasket Material	Silicon rubber
Recommended Coupling Nut Torque Nm	25–30
Coupling Nut Retention Force Nm	1,000
Contact Captivation N	200
Mating Durability	500 times

Teflon is a registered trademark of E. I. du Pont de Nemours and Company or its affiliates.

## PART NUMBERS AND PHYSICAL CHARACTERISTICS

Part Number	Compatible Cable Type	Compatible Cable Size in (mm)	N Interface Type		Length in (mm)	Diameter in (mm)	Weight oz (g)
			Gender	Straight or Angle			
CHFS-12NF	HFSC Riser	½ (12)	Female	Straight	2.75 (69.8)	0.86 (21.8)	4.1 (115)
CHFS12NFR	HFSC Riser	½ (12)	Female	Right Angle	-	-	-
CHFS-12NM	HFSC Riser	½ (12)	Male	Straight	2.75 (69.8)	0.86 (21.8)	4.2 (120)
CHFS12NMR	HFSC Riser	½ (12)	Male	Right Angle	-	-	-
CHFSP12NF	HFSC Plenum	½ (12)	Female	Straight	2.75 (69.8)	0.86 (21.8)	4.1 (115)
CHFSP12NFR	HFSC Plenum	½ (12)	Female	Right Angle	-	-	-
CHFSP12NM	HFSC Plenum	½ (12)	Male	Straight	2.75 (69.8)	0.86 (21.8)	4.2 (120)
CHFSP12NMR	HFSC Plenum	½ (12)	Male	Right Angle	-	-	-



### TECHNICAL GUIDELINE

Installation guidelines are available for these connectors. Refer to the "Resources" section on our site for an instructional video or the Technical Guideline, "DIN Connectors and N Connectors Installation Guidelines," for more information.

## PRODUCT DESCRIPTION

This N Series connector is compatible with the HFAC Series In-building Cable. The connectors are manufactured from an alloy material of copper, tin and zinc to produce a highly polished, strong connector. This alloy combination allows for a better operating temperature range and improved environmental performance.

## FEATURES/BENEFITS

- Two-piece design is the industry standard
- Simple user-friendly installation process
- Connector can be disassembled and re-used
- Offers stable, low PIM connections



## ELECTRICAL SPECIFICATIONS

Impedance Ω	50
Maximum Frequency Range GHz	7.5
VSWR @ 700-2,200 MHz straight (right angle)	1.08 (1.10)
Maximum Insertion Loss dB @ 700-2,200 MHz straight (right angle)	0.1 (0.15)
Intermodulation (PIM) dBc	-155
Dielectric Withstanding Voltage kV rms @ 50 Hz	4.0
Working Voltage kV rms @ 50 Hz	2.7
Peak Power kW	10
Insulation Resistance GΩ	≥ 5,000
Contact Resistance mΩ	Inner: ≤ 1.0 Outer: ≤ 1.0

## ENVIRONMENTAL SPECIFICATIONS

Temperature Range °F (°C)	-40 to +185 (-40 to +85)
Corrosion (Salt Spray Test)	IEC-68-2-11-Ka
Vibration	CECC 22000 Part 4.6.3
Waterproof	IP68

## SPECIFICATIONS

Bodies, Cap (Coupling Nut) Material	Brass/silver plated or Su Co (Alloy of Cu/Sn/Zn) plated
Back Nut Material	Brass/nickel plated
Pin Material	Male: Brass/silver plated or Su Co (Alloy of Cu/Sn/Zn) plated Female: Beryllium - copper/silver plated or Su Co (Alloy of Cu/Sn/Zn) plated
Insulator Material	Plated PTFE (Teflon®)
Gasket Material	Silicon rubber
Recommended Coupling Nut Torque Nm	0.68-1.13
Coupling Nut Retention Force Nm	1,000
Contact Captivation N	200
Mating Durability	500 times

Teflon is a registered trademark of E. I. du Pont de Nemours and Company or its affiliates.

## PART NUMBERS AND PHYSICAL CHARACTERISTICS

Part Number	Compatible Cable Type	Compatible Cable Size in (mm)	N Interface Type		Length in (mm)	Diameter in (mm)	Weight oz (g)
			Gender	Straight or Angle			
CHFA-12NF	HFAC Riser	½ (12)	Female	Straight	2.75 (69.8)	0.86 (21.8)	4.1 (115)
CHFA12NFR	HFAC Riser	½ (12)	Female	Right Angle	-	-	-
CHFA-12NM	HFAC Riser	½ (12)	Male	Straight	2.75 (69.8)	0.86 (21.8)	4.2 (120)
CHFA12NMR	HFAC Riser	½ (12)	Male	Right Angle	-	-	-
CHFAP12NF	HFAC Plenum	½ (12)	Female	Straight	2.75 (69.8)	0.86 (21.8)	4.1 (115)
CHFAP12NFR	HFAC Plenum	½ (12)	Female	Right Angle	-	-	-
CHFAP12NM	HFAC Plenum	½ (12)	Male	Straight	2.75 (69.8)	0.86 (21.8)	4.2 (120)
CHAP12NMR	HFAC Plenum	½ (12)	Male	Right Angle	-	-	-



## TECHNICAL GUIDELINE

Installation guidelines are available for these connectors. Refer to the "Resources" section on our site for an instructional video or the Technical Guideline, "DIN Connectors and N Connectors Installation Guidelines," for more information.

# Cable Preparation Tools



Manual Cutting Tools



Automated Cutting Tool

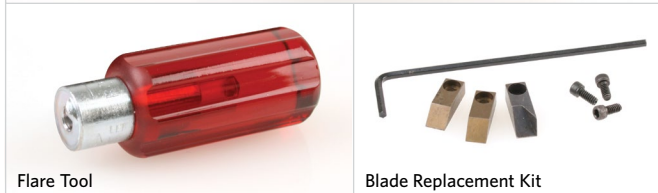

Flare Tool

Blade Replacement Kit

## PRODUCT DESCRIPTION

Connector termination is one of the most important factors affecting Radio Frequency (RF) transmission line operation. Cable cutting tools are offered in sizes ranging from ½ to 1½ inches (12 to 42 mm). These precision tools are designed to cut the jacket and outer conductor quickly and easily.

Cutting tools make accurate cuts in the cable at exact distance requirements for easy connector assembly. The automated cable cutting tools fit standard cordless 18V drills. Blade replacement kits are available to extend the useful life of the automated cutting tools.

The foam separator and flare tool removes foam dielectric from riser cable and flares the top of the outer conductor over top of riser and plenum connectors.

## FEATURES/BENEFITS

- Accurate termination
- Easy handling

## CUTTING TOOLS

Part Number	Tool Type	Capability	Compatible Cable Size in (mm)	Compatible Cable Type	Unit of Measure
L-CT-12D	Manual	Cuts jacket and outer conductor	½ (12)	LHF Feeder, HFAC Feeder	Each
L-CT-12DS	Manual	Cuts inner/outer jackets	½ (12)	HFSC Feeder	Each
L-CT-22D	Manual	Cuts jacket, inner/outer conductors and dielectric	7⁄8 (22)	LHF Feeder	Each
T-LHFA12DP	Automated	Cuts jacket, outer conductor and dielectric	½ (12)	LHF-12DP, HFAC-12DP	Each
T-HFSC12DP	Automated	Cuts jacket, outer conductor and dielectric	½ (12)	HFSC-12DP	Each
T-LHF12DR	Automated	Cuts jacket, outer conductor and dielectric	½ (12)	LHF-12DR	Each
T-HFAC12DR	Automated	Cuts jacket, outer conductor and dielectric	½ (12)	HFAC-12DR	Each
T-HFSC12DR	Automated	Cuts jacket, outer conductor and dielectric	½ (12)	HFSC-12DR	Each

## FLARE TOOLS

Part Number	Description	Compatible Cable Size in (mm)	Compatible Cable Type	Unit of Measure
TF-LHFA12	Foam separator and flare tool	½ (12)	LHF-12DP, LHF-12DR, HFAC-12DP, HFAC-12DR	Each
TF-HFSC12	Foam separator and flare tool	½ (12)	HFSC-12DP, HFSC-12DR	Each
L-FT-42D	T-handle flare tool	1½ (42)	LHF-42D, LHF-42DU, LHF-42DUF	Each

## BLADE REPLACEMENT KITS

Part Number	Description	Compatible Tools	Each Kit Includes	Unit of Measure
TBK-HFSC12	Blade replacement kit for HFSC automated tools	T-HFSC12DP, T-HFSC12DR	<ul style="list-style-type: none"> <li>• Three (3) replacement blades</li> <li>• Three (3) set screws</li> <li>• One (1) Allen wrench</li> </ul>	Kit
TBK-LHFA12	Blade replacement kit for LHF and HFAC automated tools	T-LHFA12DP, T-LHF12DR, T-HFAC12DR	<ul style="list-style-type: none"> <li>• Four (4) replacement blades</li> <li>• Four (4) set screws</li> <li>• One (1) Allen wrench</li> </ul>	Kit

# Cushion and Boot Assembly Kit

## PRODUCT DESCRIPTION

These innovative boot assembly kits feature a boot assembly and standard cushion insert in one convenient package. The unique boot assembly features a split, one-piece design that dramatically reduces installation time and difficulty. Boot assembly kits are designed to be fitted onto EP-series entry panels in wall/roof feed-thru applications.

## APPLICATION

- Entry solutions

## FEATURES/BENEFITS

- One-piece design simplifies installation



## SPECIFICATIONS

<b>Size</b>	Versions for coax
<b>Design</b>	Compression boot kit for aluminum entry panels
<b>Mounts to</b>	4 inch (102 mm) entry panels
<b>Material</b>	EPDM rubber
<b>Each Kit Includes</b>	<ul style="list-style-type: none"> <li>One (1), 4 inch (101.6 mm) pre-molded grooved boot</li> <li>One (1) cushion insert with appropriately sized hole(s) for corrugated coax or flexible coax</li> <li>One (1), #80 round member hose clamp</li> <li>One (1), #64 round member hose clamp</li> <li>One (1) installation instruction sheet</li> </ul>
<b>Not Included (Order Separately)</b>	4 inch (102 mm) entry panel

## PART NUMBERS AND PHYSICAL CHARACTERISTICS

Part Number	Compatible Cable Size in (mm)	Compatible Cable Type	Number of Holes	Weight lbs (kg)	Unit of Measure
LBA-12-1A	½ (12)	Corrugated Coax	1	1.6 (0.7)	Kit
LBA-12-2A	½ (12)	Corrugated Coax	2	1.6 (0.7)	Kit
LBA-12-3A	½ (12)	Corrugated Coax	3	1.6 (0.7)	Kit
LBA-12-4A	½ (12)	Corrugated Coax	4	1.6 (0.7)	Kit
LBA-12-5A	½ (12)	Corrugated Coax	5	1.6 (0.7)	Kit
LBA-22-1A	⅞ (22)	Corrugated Coax	1	1.6 (0.7)	Kit
LBA-22-2A	⅞ (22)	Corrugated Coax	2	1.6 (0.7)	Kit
LBA-22-3A	⅞ (22)	Corrugated Coax	3	1.6 (0.7)	Kit
LBA-22-4A	⅞ (22)	Corrugated Coax	4	1.6 (0.7)	Kit
LBA-33-1A	1¼ (33)	Corrugated Coax	1	1.6 (0.7)	Kit
LBA-42-1A	1⅝ (42)	Corrugated Coax	1	1.6 (0.7)	Kit
LBA-57-1A	2¼ (57)	Corrugated Coax	1	1.6 (0.7)	Kit

# Universal Weatherproofing Kit



## PRODUCT DESCRIPTION

Universal weatherproofing kits include mastic and electrical tapes to provide a multi-layer, long-term environmental seal over multiple connections.

## APPLICATION

- Coax protection

## FEATURES/BENEFITS

- Multi-connection protection
- Tape kit for multi-layer wrap

## SPECIFICATIONS

Material	Butyl and vinyl tape
Each Kit Includes	<ul style="list-style-type: none"> <li>▪ Five (5) rolls of butyl mastic tape 3.75 inches x 2 feet (95 mm x 0.6 m)</li> <li>▪ Two (2) rolls of electrical tape 0.75 inch x 44 feet (19 mm x 13 m)</li> <li>▪ One (1) roll of electrical tape 2 inch x 20 feet (51 mm x 6 m)</li> <li>▪ One (1) installation instruction sheet</li> </ul>

## PART NUMBERS AND PHYSICAL CHARACTERISTICS

Part Number	Weight lbs (kg)	Unit of Measure
L-WK-U	3.4 (1.5)	Kit

## PRODUCT DESCRIPTION

Hoisting grips provide an effective means for hoisting coax and elliptical waveguide into position. Grips can be used to provide additional support once in place. The lace-up design allows the hoisting grip to be attached even when the run has been connectorized, and it facilitates easy positioning at 200 feet (61 m) increments on long coax runs.

Pre-laced hoisting grips feature a closed-mesh design which simplifies installation over traditional split, lace-up style grips. The unique design allows the pre-laced hoisting grip to slip over an unterminated end of a coax cable. The grip securely tightens when pulled, providing an effective means to hoist coax into position, while providing additional support for the coax once in place.

Hoisting grip kits include a self-locking clip and sealing tape, giving additional support both during and after installation.

## APPLICATION

- Coax
- Coax support

## FEATURES/BENEFITS

- Lace-up installation at any point on coax
- Pre-laced to simplify installation
- Mesh grip with single eye support

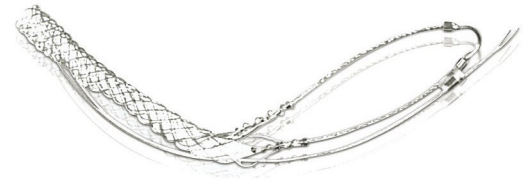

## SPECIFICATIONS

<b>Compatible Cable Type</b>	Corrugated coax
<b>Compatible Cable Size in (mm)</b>	Fits ½ (12) to 1½ (42) corrugated coax
<b>Material</b>	Tinned bronze
<b>Each Includes</b>	<ul style="list-style-type: none"> <li>• One (1) mesh grip</li> <li>• One (1) self-locking clip</li> <li>• Installation instructions</li> </ul>

## PART NUMBERS AND PHYSICAL CHARACTERISTICS

Part Number	Hoisting Grip Model	Compatible Cable Size in (mm)	Weight lbs (kg)	Unit of Measure
L-HG-12	Lace-Up	½ (12)	0.3 (0.1)	Each
L-HG-22	Lace-Up	¾ (22)	0.6 (0.3)	Each
L-HG-33	Lace-Up	1¼ (33)	0.6 (0.3)	Each
L-HG-42	Lace-Up	1½ (42)	1.3 (0.6)	Each
L-HG-12L	Pre-Laced	½ (12)	0.4 (0.2)	Each
L-HG-22L	Pre-Laced	¾ (22)	0.5 (0.2)	Each
L-HG-33L	Pre-Laced	1¼ (33)	0.5 (0.2)	Each
L-HG-42L	Pre-Laced	1½ (42)	0.5 (0.2)	Each

# Clip-On Grounding Kit



## SPECIFICATIONS

<b>Compatible Cable Type</b>	Corrugated coax
<b>Compatible Cable Size in (mm)</b>	Fits ½ (12) to 1¾ (42)
<b>Mounts to</b>	Coax outer conductor
<b>Material</b>	Copper strap
<b>Each Kit Includes</b>	<ul style="list-style-type: none"> <li>• One (1) 6 AWG, 7-strand copper ground lead measuring 4.92 feet (1.5 m) long</li> <li>• One (1) roll of electrical tape 2 inch x 20 feet (51 mm x 6 m)</li> <li>• One (1) roll of butyl mastic tape 3.75 inch x 2 feet (95 mm x 0.6 m)</li> <li>• Necessary hardware for ground bar attachment</li> <li>• One (1) 2-hole universal lug compatible with ½ inch (12 mm) coax</li> </ul>

## PRODUCT DESCRIPTION

Clip-on ground kits, as part of an advanced coax grounding solution, provide easy installation coupled with dependable protection of your coaxial cable system. The unique clip design and pre-formed strap allows the clip-on ground kits to slip easily over the outer conductor of the coax and firmly latch into place. The latch mechanism has been optimized to provide a secure fit, maximizing performance by ensuring proper contact surface area and pressure. The innovative design of the clip-on ground kits greatly simplifies installation, and minimizes installation time over traditional coiled and bolt-on grounding kits. This design also eliminates the danger of over tightening, which reduces the chance of costly errors in the field. The clip-on ground kits comply with MIL-STD-188-124A, protecting coax from the damaging effects of lightning current in excess of 200 kA. Each kit includes a 6 AWG 7-strand copper ground lead. All bus bar attachment hardware is included along with required mastic and electric tape for weatherproofing each kit.

## APPLICATION

- Coax protection

## FEATURES/BENEFITS

- Easy-to-install clip design
- One-piece style with three lead/lug options

## PART NUMBERS AND PHYSICAL CHARACTERISTICS

Part Number	Compatible Cable Size in (mm)	Weight lbs (kg)	Unit of Measure
L-GK-C12	½ (12)	1.4 (0.6)	Kit
L-GK-C22	⅞ (22)	1.4 (0.6)	Kit
L-GK-C33	1¼ (33)	1.4 (0.6)	Kit
L-GK-C42	1¾ (42)	1.5 (0.7)	Kit

\*Note: 0.375 inch (10 mm) two-hole lugs are universal to accommodate 0.75 inch to 1 inch (19 mm to 25 mm) spacing requirements. Versions of these kits are available with 0.25 inch (6 mm) two-hole lugs or with your choice of lug pre-attached.



# Universal Snap-in Hanger Kit

## PRODUCT DESCRIPTION

The next-generation Universal Snap-in Hangers incorporate numerous innovative design features that ensure secure, dependable support and simplified installation for your coaxial cable system. The unique internal coax fingers securely grip the coax, yet float freely within the hanger to ensure flexibility during installation. The tension and thickness of steel has been optimized to minimize stiffness and allow easy insertion into a 3/4 inch (19 mm) mounting hole. The advanced snap-in fingers are specifically designed to eliminate inadvertent pop-out. The unique curved finger-tips provide a powerful barrier to pop-out and offer additional security when faced with excessive galvanizing or rounded edges. The Universal Snap-in Hangers internal ribbing and dog-eared internal fingers provide a firm grip to resist coax slippage. The stainless steel construction guarantees exceptional integrity in highly corrosive environments and extreme weather conditions.

## APPLICATION

- Coax support

## FEATURES

- One-piece hanger solution

## BENEFITS

- Simplified coax installation



## SPECIFICATIONS

Compatible Cable Type	Corrugated coax
Compatible Cable Size in (mm)	½ (12) to 2¼ (58)
Mounts to in (mm)	¾ (19) holes
Material	Stainless steel
Each Kit Includes	<ul style="list-style-type: none"> <li>10 appropriately sized snap-in hangers</li> <li>One (1) installation instruction sheet</li> </ul>
Not Included (Order Separately)	Brackets

## PART NUMBERS AND PHYSICAL CHARACTERISTICS

Part Number	Compatible Cable Size in (mm)	Weight lbs (kg)	Unit of Measure
L-SH-U12	½ (12)	0.7 (0.3)	Kit
L-SH-U22	¾ (22)	1.2 (0.5)	Kit
L-SH-U33	1¼ (33)	1.3 (0.6)	Kit
L-SH-U42	1½ (42)	1.5 (0.7)	Kit

# Stackable Snap-in Hanger Kit

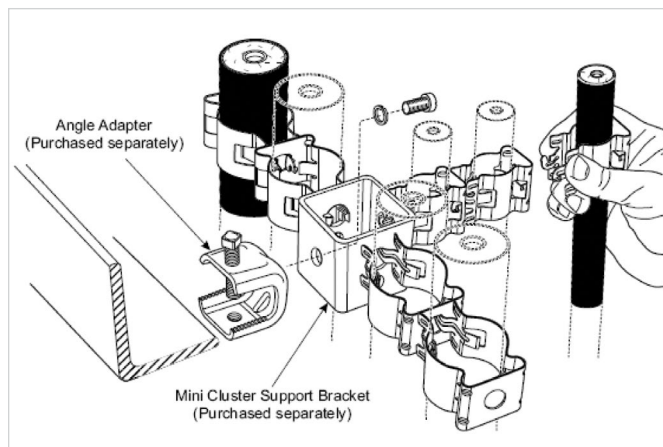

## SPECIFICATIONS

Compatible Cable Type	Corrugated coax
Compatible Cable Size in (mm)	$\frac{3}{8}$ (9.5) to 1 $\frac{1}{2}$ (42)
Material	Stainless steel
Each Kit Includes	<ul style="list-style-type: none"> <li>10 appropriately sized stackable snap-in hangers</li> <li>One (1) installation instruction sheet</li> </ul>
Not Included (Order Separately)	Brackets

## PART NUMBERS AND PHYSICAL CHARACTERISTICS

Part Number	Compatible Cable Size in (mm)	Stack Height	Weight lbs (kg)	Unit of Measure
SSHAK3812*	$\frac{3}{8}$ (9.5)	3 Runs	3.1 (1.4)	Kit
L-SH-S12	$\frac{1}{2}$ (12)	3 Runs	0.7 (0.3)	Kit
L-SH-S22	$\frac{7}{8}$ (22)	3 Runs	1.2 (0.5)	Kit
L-SH-S33	1 $\frac{1}{4}$ (33)	2 Runs	1.3 (0.6)	Kit
L-SH-S42	1 $\frac{1}{2}$ (42)	2 Runs	1.5 (0.7)	Kit

\*Includes grommet.

## PRODUCT DESCRIPTION

The self contained design of the Stackable Snap-in Hanger eliminates the need for mounting hardware, while also providing a compact solution for supporting coaxial cable. The hanger can be stacked up to three runs high when using  $\frac{3}{8}$ ",  $\frac{1}{2}$ " and  $\frac{7}{8}$ " coaxial cable, or two runs high when using 1 $\frac{1}{4}$ " and 1 $\frac{1}{2}$ " coaxial cable.

Each hanger accommodates one run of coaxial cable. The advanced design of the retention tabs gives the hanger the ability to absorb vibration, making the hanger resistant to pop-out. This unique design also reduces movement in the runs of coaxial cable, therefore reducing stress on the connections. Manufactured from stainless steel, this product ensures long term integrity in extreme environments including mountain tops, coastal and industrial applications.

## APPLICATION

- Coax support

## FEATURES

- One-piece hanger solution

## BENEFITS

- Eliminates the need for mounting hardware for a simplified coax installation

# Standard Hanger Kit

## PRODUCT DESCRIPTION

The Standard Hangers provide a dependable solution for supporting single runs of coaxial cable in wireless systems. The pre-formed design greatly simplifies installation, allowing the coax to be quickly slipped into the Standard Hanger and then secured using the included captivated bolt. Corrosion-resistant stainless steel construction ensures long term integrity in extreme weather applications. Integrated cable grippers bite into the coax jacketing, to provide additional support in heavy wind and ice-loading conditions.

## APPLICATION

- Coax support

## FEATURES

- Pre-formed bolt-on single run hanger

## BENEFITS

- Reduces installation time



## SPECIFICATIONS

<b>Compatible Cable Type</b>	Corrugated coax
<b>Compatible Cable Size in (mm)</b>	Fits ½ (12) to 1½ (42)
<b>Mounts to in (mm)</b>	¾ (9.5) hardware
<b>Material</b>	Stainless steel
<b>Each Kit Includes</b>	<ul style="list-style-type: none"> <li>10 appropriately sized stainless steel hangers without hardware</li> <li>10 captive ¼ inch (6.4 mm) slotted hex head bolts</li> <li>One (1) installation instruction sheet</li> </ul>
<b>Not Included (Order Separately)</b>	Brackets

## PART NUMBERS AND PHYSICAL CHARACTERISTICS

Part Number	Compatible Cable Size in (mm)	Weight lbs (kg)	Unit of Measure
LBHS12NH	½ (12)	0.8 (0.4)	Kit
LBHS22NH	¾ (22)	1.1 (0.5)	Kit
LBHS33NH	1¼ (33)	1.3 (0.6)	Kit
LBHS42NH	1½ (42)	1.8 (0.8)	Kit

# $\lambda/4$ Wave Surge Arrestor



## PRODUCT DESCRIPTION

Surge arrestors provide excellent lightning protection and outstanding RF performance. All designs have low return loss, low insertion loss and low intermodulation.

## FEATURES/BENEFITS

- Outstanding RF performance
- Completely weatherproof
- Available with Type N or DIN interface
- Maintenance-free operation ( $\lambda/4$  wave shorting stubs)

## SPECIFICATIONS

Outer Conductor Material	Brass/silver or Su Co plated
Inner Conductor Material	Be Cu (Female)/silver or Su Co plated
Other Metal Parts Materials	Brass/nickel plated
Temperature Range °C	-40 to +100
Moisture Resistance	Waterproof
Frequency Band MHz	700-2,700

## ELECTRICAL SPECIFICATIONS

Impedance (Nominal) $\Omega$	50
VSWR	< 1.1
Insertion Loss dB	< 0.1
Intermodulation (PIM) dBc	-155
Max. Impulse Spark-Over Voltage	> 600

## PART NUMBERS AND PHYSICAL CHARACTERISTICS

Part Number	Surge Arrestor Model	Frequency Band MHz	Interface Type	Unit of Measure
ATNMNF700	$\lambda/4$ wave	700-2,700	N Male/N Female	Each
ATDMDF700	$\lambda/4$ wave	700-2,700	DIN Male/DIN Female	Each
AT-NMNF-W	$\lambda/4$ wave	800-2,700	N Male/N Female	Each
AT-DMDF-W	$\lambda/4$ wave	800-2,700	DIN Male/DIN Female	Each

# Gas Tube Surge Arrestor

## PRODUCT DESCRIPTION

A surge arrester is a gas discharge tube type for lightning strike protection, used most widely with  $\lambda/4$  stub type systems. The surge arrester allows for replaceable gas discharge tubes between the internal and outer conductor. When activated, this unit discharges electron pulse energy instantaneously.

## FEATURES/BENEFITS

- Outstanding Broadband RF performance (up to 2,700 MHz)
- DC pass capability
- High tensional internal conductor structure
- Waterproof
- Available with 0.4375 in (11.1 mm) DIN type

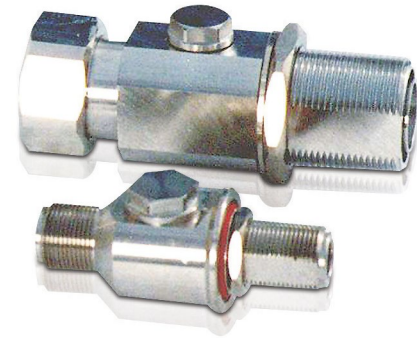

## SPECIFICATIONS

Outer Conductor Material	Brass / Silver or Su Co Plated
Inner Conductor Material	Be Cu (Female) / Silver or Su Co Plated
Other Metal Parts Materials	Brass / Nickel Plated
Temperature Range °C	-40 to +100
Moisture Resistance	Waterproof
Maximum Frequency Range MHz	2,700

## ELECTRICAL SPECIFICATIONS

Impedance (Nominal) $\Omega$	50
VSWR	< 1.1
Insertion Loss dB	< 0.1
Max. Impulse Spark-Over Voltage	> 600

## PART NUMBERS AND PHYSICAL CHARACTERISTICS

Part Number	Surge Arrester Model	Interface Type	Unit of Measure
AGDMDF02	Gas Tube	DIN Male/DIN Female	Each
AG-NFNF	Gas Tube	N Female/N Female	Each

# Round Adapter Kit



## PRODUCT DESCRIPTION

The Round Adapter Kit provides an easy method for supporting transmission lines to small diameter pipes or poles. The round adapter kit contains ten adjustable hose clamps.

## APPLICATION

- Coax hanger support

## SPECIFICATIONS

Compatible Pipe/Pole Diameter in (mm)	Fits 1 (25.4) to 4 (101.6)
Material	Stainless steel
Each Kit Includes	<ul style="list-style-type: none"> <li>10 adjustable hose clamps</li> <li>One (1) installation instruction sheet</li> </ul>
Not Included (Order Separately)	Hanger Kits Brackets

## PART NUMBERS AND PHYSICAL CHARACTERISTICS

Part Number	Adjustable Diameter in (mm)	Height in (mm)	Weight lbs (kg)	Unit of Measure
RM-A100	1 to 2 (25.4 to 50.8)	0.5 (12.7)	0.8 (0.4)	Kit
RM-A300	3 to 4 (76.2 to 101.6)	0.5 (12.7)	1.2 (0.5)	Kit

# Stand-Off Adapter Kit

## PRODUCT DESCRIPTION

Stand-Off Adapter Kits enable hangers to be mounted to 1.5 inch (31.8 mm) or larger round adapters. The stand-off adapter is available in stainless steel to provide excellent corrosion resistance and ensure long term integrity in extreme weather applications.

## APPLICATION

- Coax hanger support

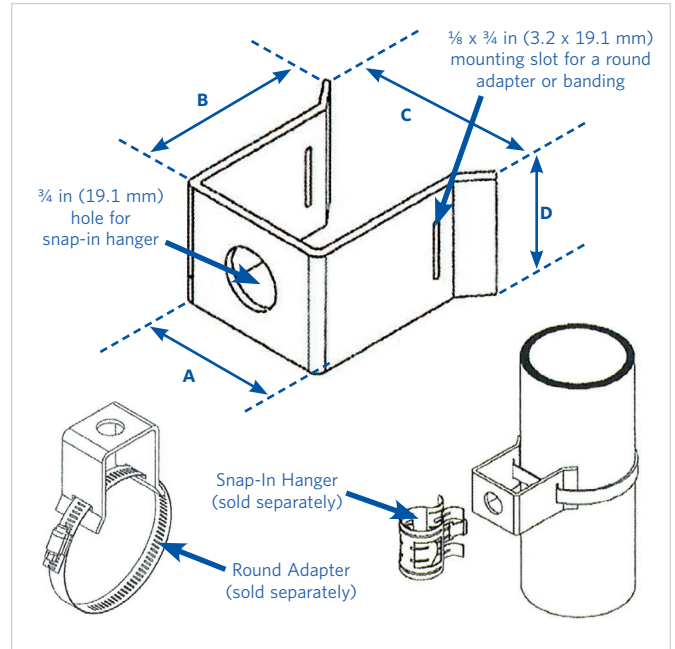

## SPECIFICATIONS

<b>Size in (mm)</b>	A = 1.75 (44.5) B = 2.25 (57.2) C = 2.375 (60.3) D = 1.50 (38.1)
<b>Mounts to</b>	Round adapters 1.5 to 4.5 inch (38.1 to 114.3 mm)
<b>Material</b>	Stainless steel
<b>Each Kit Includes</b>	<ul style="list-style-type: none"> <li>10 stand-off adapters</li> <li>One (1) installation instruction sheet</li> </ul>
<b>Not Included (Order Separately)</b>	Round Adapter Kit Snap-In Hanger Kit

## PART NUMBERS AND PHYSICAL CHARACTERISTICS

Part Number	Compatible Round Adapter Size in (mm)	Unit of Measure
SA-SS200	1.5 to 3.5 (38.1 to 88.9)	Kit
SA-SS300	2 to 4.5 (50.8 to 114.3)	Kit

## Three-Way Stand-Off Adapter Kit

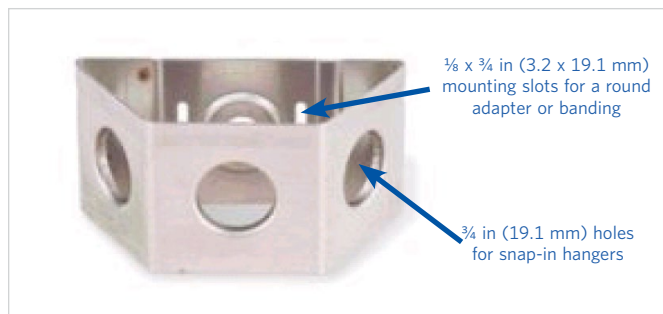

### PRODUCT DESCRIPTION

The Three-Way Stand-Off Adapter Kit enables hangers to be mounted to round adapters. Each adapter accommodates up to three (3) snap-in hangers for supporting coaxial cable runs. The three-way stand-off adapter is available in stainless steel to provide excellent corrosion resistance and ensure long term integrity in extreme weather applications.

### APPLICATION

- Coax hanger support

### SPECIFICATIONS

Mounts to	Round adapters
Material	Stainless steel
Each Kit Includes	<ul style="list-style-type: none"> <li>10 three-way stand-off adapters</li> <li>One (1) installation instruction sheet</li> </ul>
Not Included (Order Separately)	Round Adapter Kit Snap-In Hanger Kit

### PART NUMBERS AND PHYSICAL CHARACTERISTICS

Part Number	Outside Length in (mm)	Outside Width in (mm)	Unit of Measure
L-SA-38	7.6 (19.3)	3.8 (98.0)	Kit

## Angle Adapter Kit



### PRODUCT DESCRIPTION

The Angle Adapter Kit allows the installer to easily secure hangers to solid angle members or in areas where mounting holes are not easily accessible. The stainless steel bolt locks the angle adapter to standard tower members or to mounting surfaces less than 7/8 inch (22.2 mm) thick. The toothed jaw effectively secures large volumes of coax in heavy wind and ice-loading conditions.

Three (3), 3/8 inch (9.5 mm) tapped holes enable the angle adapter to accommodate hanger types which utilize 3/8 inch (9.5 mm) mounting hardware. Angle adapter kits include 10 angle adapters and 10 set bolts.

### APPLICATION

- Coax hanger support

### SPECIFICATIONS

Compatible Solid Angle Member Thickness in (mm)	Fits up to 7/8 inch (22.2 mm)
Material	Stainless steel
Each Kit Includes	<ul style="list-style-type: none"> <li>10 stainless steel angle adapters</li> <li>10 captive 3/8 inch (9.5 mm) set bolts</li> <li>One (1) installation instruction sheet</li> </ul>
Not Included (Order Separately)	Hanger Kits

### PART NUMBERS AND PHYSICAL CHARACTERISTICS

Part Number	Unit of Measure
AA-SL	Kit



# Ground Bus Bar Kit

## PRODUCT DESCRIPTION

The Ground Bus Bar Kit provides a single, versatile solution to create a central ground point at your site. The ground bus bars are manufactured from ¼ inch (6.3 mm) thick solid, tinned copper, and they incorporate 26 pairs of 7/16 inch (11.1 mm) holes and 26 pairs of ¼ inch (6.4 mm) holes. By slotting one hole in each pair of 7/16 inch holes, the ground bus bar accommodates any lug hole spacing from ¾ inch (19.1 mm) to 1 inch (25.4 mm). Six (6) pairs of 7/16 inch holes are incorporated for lug connections to the ground system.

## APPLICATION

- Coax protection

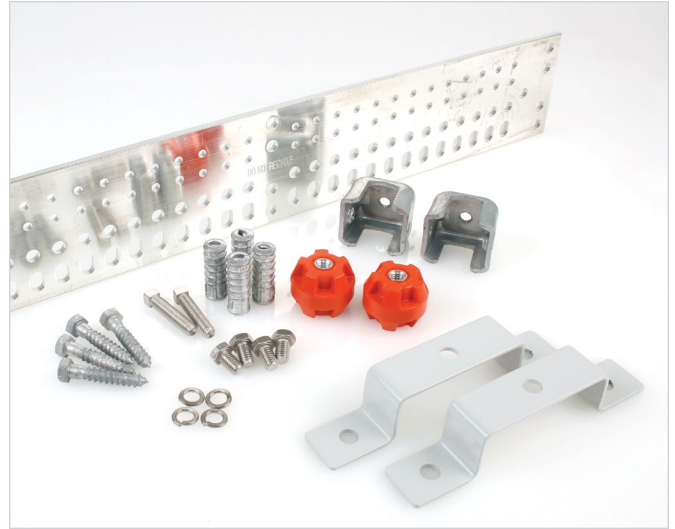

## SPECIFICATIONS

### Material

Bus bar: solid, tinned copper  
 Mounting hardware: stainless steel  
 Mounting brackets: galvanized steel

### Each Kit Includes

- One (1) universal ground bar  
 ¼ inch x 24 inch (6.4 mm x 0.6 m)
- One (1) mounting hardware set
- One (1) mounting bracket set
- One (1) installation instruction sheet

## PART NUMBERS AND PHYSICAL CHARACTERISTICS

Part Number	Thickness in (mm)	Height in (mm)	Width in (mm)	Weight lbs (kg)	Unit of Measure
GB0424TU	0.25 (6.3)	4 (102)	24 (610)	8 (3.6)	Kit

# Weather Proofing Shell



## PRODUCT DESCRIPTION

The Weather Proofing Shell seals and protects connector joints from the environment. The shell also provides easy and fast installation of weather proofing on connector joints. The weather proofing shell is reusable.

## APPLICATION

- Coax/connector protection

## SPECIFICATIONS

Material	Long glass PP and silicon rubber
Temperature Range °F (°C)	-40 to +140 (-40 to +60)
Standards Compliance	UV Resistant UL® and CL IP 68 IEC60529 ANSI C91191 RoHS-compliant

UL is a registered trademark of UL LLC.

## PART NUMBERS AND PHYSICAL CHARACTERISTICS

Part Number	Connector Joint Compatibility	Unit of Measure
WPSANT12D	Antenna to ½ inch (12 mm) DIN Connector	Each
WPS12158D	½ inch (12 mm) to 1½ inch (42 mm) DIN Connector	Each

# Anti-Theft Hardware Kit

**PRODUCT DESCRIPTION**

The Anti-Theft Hardware Kit is used to prevent removal of parts easily when bolted. The kit includes four (4) anti-theft bolts and a star head allen key.

**APPLICATION**

- Coax protection



**SPECIFICATIONS**

<b>Bolt Material</b>	Stainless steel
<b>Each Kit Includes</b>	<ul style="list-style-type: none"> <li>• Four (4) anti-theft bolts measuring 3/4 inch x 1 inch (19.1 mm x 25.4 mm)</li> <li>• One (1) star head allen key</li> <li>• One (1) installation instruction sheet</li> </ul>

**PART NUMBERS AND PHYSICAL CHARACTERISTICS**

Part Number	Unit of Measure
WATS-38	Kit



800.551.8948

[SuperiorEssexCommunications.com](http://SuperiorEssexCommunications.com)

All information, content, data, specifications, packaging and part numbers detailed herein are subject to change. For the most up-to-date information, please visit [SuperiorEssexCommunications.com](http://SuperiorEssexCommunications.com). Purchase of this product is subject exclusively to the then current **Superior Essex International LP Terms and Conditions of Sale for Communications Cable, Wire and Connectivity Products**, which can be found on our website, [SuperiorEssexCommunications.com](http://SuperiorEssexCommunications.com), or provided to you upon request.

Metric Conversions .....	X-2
American Wire Gauge Sizes .....	X-2
Optical Fiber Types .....	X-3
Optical Fiber Specifications .....	X-4
Optical Fiber Cable .....	X-6
Canadian Central Office Cable .....	X-6
OSP Copper Cable .....	X-7
Mechanical Protection (+M) for Extreme Risk Environments .....	X-8
Copper Wire and Cable .....	X-9
Fire Alarm/Security Control Cable .....	X-10
Premises Cable Conduit Fill Quick Reference .....	X-11
Packaging .....	X-12
Terms and Conditions of Sale .....	X-18
Part Number Index .....	X-19

# Metric Conversions

Superior Essex uses the U.S. customary system of weights and measures as well as the metric equivalents. If you need help calculating these figures, please consult the conversion charts below.

INTO METRIC CONVERSIONS			
	If You Know	Multiply By	To Get
Length	milli-inch (mil)	25.40	microns ( $\mu\text{m}$ )
	inches (in)	25.40	millimeters (mm)
	inches (in)	2.54	centimeters (cm)
	feet (ft)	304.8	meters (m)
	yards (yd)	0.91	meters (m)
	miles (mi)	1.61	kilometers (km)
Area	sq. inches ( $\text{in}^2$ )	6.45	sq. centimeters ( $\text{cm}^2$ )
	sq. feet ( $\text{ft}^2$ )	0.09	sq. meters ( $\text{m}^2$ )
	sq. yards ( $\text{yd}^2$ )	0.84	sq. meters ( $\text{m}^2$ )
	sq. miles ( $\text{mi}^2$ )	2.59	sq. kilometers ( $\text{km}^2$ )
	acres	0.40	hectares (ha)
Mass (Weight)	ounces (oz)	28.35	grams (g)
	pounds (lbs)	0.45	kilograms (kg)
	short tons	0.91	tons (t)
Temperature	Fahrenheit ( $^{\circ}\text{F}$ )	Subtract 32, then multiply by 0.56	Celsius ( $^{\circ}\text{C}$ )
Mass per Length	pounds per 1,000 feet (lbs/kft)	1.49	kilograms per kilometers (kg/km)
Force	pounds force (lbf)	4.45	newtons (N)
	foot-pounds (ft-lbs)	1.36	newtons-meters (N-m)
	pounds force per inches (lbf/in)	1.75	newtons per centimeters (N/cm)
	pounds per sq. inches (PSI)	6.89	kiloPascals (kPa)

OUT OF METRIC CONVERSIONS			
	If You Know	Multiply By	To Get
Length	microns ( $\mu\text{m}$ )	0.04	milli-inch (mil)
	millimeters (mm)	0.04	inches (in)
	centimeters (cm)	0.39	inches (in)
	meters (m)	3.28	feet (ft)
	meters (m)	1.09	yards (yd)
	kilometers (km)	3,280.84	feet (ft)
	kilometers (km)	0.62	miles (mi)
Area	sq. centimeters ( $\text{cm}^2$ )	0.16	sq. inches ( $\text{in}^2$ )
	sq. meters ( $\text{m}^2$ )	1.20	sq. yards ( $\text{yd}^2$ )
	sq. kilometers ( $\text{km}^2$ )	0.39	sq. miles ( $\text{mi}^2$ )
	hectares (ha)	2.47	acres
Weight	grams (g)	0.04	ounces (oz)
	kilograms (kg)	2.20	pounds (lbs)
	tons (t)	1.10	short tons
Temperature	Celsius ( $^{\circ}\text{C}$ )	Multiply by 1.80, then add 32	Fahrenheit ( $^{\circ}\text{F}$ )
Weight per Unit Length	pounds per 1,000 feet (lbs/kft)	1.48816	kilograms per kilometers (kg/km)
Force	newtons (N)	0.22	pounds force (lbf)
	newtons-meters (N-m)	0.74	foot-pounds (ft-lbs)
	newtons per centimeters (N/cm)	0.57	pounds force per inches (lbf/in)
	kilo Pascals (kPa)	0.15	pounds per sq. inches (PSI)

# American Wire Gauge Sizes

The table below shows various data for copper and aluminum stranded conductors.

AMERICAN WIRE GAUGE (AWG) SIZES								
AWG/ kcmil	Stranding <sup>2</sup>	Diameter		Copper DC Resistance @ 20°C		Aluminum DC Resistance @ 20°C		
		in	mm	( $\Omega/\text{kft}$ )	( $\Omega/\text{km}$ )	( $\Omega/\text{kft}$ )	( $\Omega/\text{km}$ )	
1,000	61	1.117	28.372	0.0106	0.0348	0.0173	0.0568	
750	61	0.968	24.587	0.0141	0.0462	0.0231	0.0758	
600	61	0.866	21.996	0.0177	0.0581	0.0289	0.0948	
500	37	0.789	20.041	0.0212	0.0695	0.0035	0.1140	
400	37	0.706	17.932	0.0264	0.0866	0.0434	0.1420	
350	37	0.661	16.789	0.0302	0.0991	0.0495	0.1620	
300	37	0.611	15.519	0.0353	0.1160	0.0578	0.1870	
250	19	0.558	14.173	0.0423	0.1390	0.0694	0.2280	
0000 (4/0)	19	0.512	13.005	0.0500	0.1640	0.0820	0.2690	
000 (3/0)	19	0.456	11.582	0.0630	0.2070	0.1030	0.3380	
00 (2/0)	19	0.405	10.287	0.0795	0.2610	0.1300	0.4270	
0 (1/0)	19	0.362	9.195	0.1000	0.3280	0.1640	0.5380	
1	7	0.322	8.179	0.1270	0.5220	0.2070	0.6790	
2	7	0.283	7.188	0.1590	0.6590	0.2610	0.8560	
4	7	0.225	5.715	0.2530	1.0500	0.4160	1.3600	
6	19	0.178	4.521	0.4030	1.3200	0.6610	2.1700	
8 <sup>1</sup>	7	0.142	3.607	0.6400	2.1000	1.0500	3.4400	
10	7	0.126	3.200	1.0200	3.3500	1.6700	5.4800	
12	7	0.113	2.870	1.6300	5.3500	2.6700	8.7600	
14	7	0.071	1.803	2.5800	8.4600	4.2200	13.8000	
16	7	0.0576	1.463	4.1000	13.4000	6.7100	22.0000	
18	7	0.0456	1.158	6.5400	21.4000	10.7000	35.1000	
20	7	0.0363	0.922	10.3000	33.8000	16.9000	55.4000	
22	7	0.0288	0.732	16.4000	53.8000	-	-	
24	-	0.0228	0.579	26.1000	85.6000	-	-	
25	-	0.0179	0.455	106.2000	32.3700	-	-	
26	-	0.0159	0.405	133.9000	40.8100	-	-	
27	-	0.0142	0.361	168.9000	51.4700	-	-	
28	-	0.0126	0.321	212.9000	64.9000	-	-	

<sup>1</sup>8AWG, Combination Unilay-Stranded, Per ASTM B787

<sup>2</sup>24AWG through 1000kcmil, Reverse Concentric Compressed Class B, ASTM B8

## SINGLE MODE OPTICAL FIBER

Single mode fiber (SMF) is used primarily for intermediate and long distance Outside Plant (OSP) applications that have distances between connections of up to 80 km (50 mi). It is the exceptional information carrying capacity and low-loss properties of this fiber that make it ideal for these demanding applications. More recently, it is being used in massive data centers where port density and space are an issue.

The core, or light-carrying region of the fiber, is approximately 8.3 μm in diameter. This narrows the transmission pathway allowing for only a single “path,” or mode, for each pulse of light traveling down the core of the fiber. The light transmission technology is laser-based for all single mode communications applications.

Wavelength division multiplexing is a method used to increase bandwidth where multiple wavelengths are transmitted simultaneously within a fiber. By combining the extremely high bandwidth properties of SMF with high precision laser-based transceivers, equipment and network systems designers can create networks capable of sending simultaneous voice and data transmission well beyond hundreds of gigabits per second over many miles.

Superior Essex offers many types of single mode optical fibers for communications applications. Based on the application, Superior Essex can recommend the following SMF types.

Reduced Water Peak (RWP) SMF offered by Superior Essex is an excellent choice for patch cords, local area network (LAN), wide area network (WAN) and metropolitan area networks (MAN). This fiber has operating wavelengths from 1310 nm to 1550 nm.

RWP SMF is designed to have low attenuation at 1383 nm and is becoming the most commonly recommended optical fiber for all types of network applications. Legacy SMF displays an attenuation increase at around 1383 nm. This wavelength is known as the water-peak region and is where light is strongly absorbed by naturally occurring water-like end groups in the glass, causing high attenuation or signal loss. Specifically, hydroxyl end groups, which make up half of a water molecule, are always present at some level within the glass core and cause increased attenuation over this wavelength region. Superior Essex RWP SMF has no water peak and allows all the wavelengths between 1300 nm and 1550 nm to be usable. This optical fiber is therefore, not only an excellent choice for traditional applications, but also for more advanced systems such as coarse wavelength division multiplexing (CWDM) and dense wavelength division multiplexing (DWDM) technologies. RWP SMF is the standard single mode optical fiber for all Superior Essex premises cables.

Refer to the table on page X-4 for performance information.

Reduced Water Peak (RWP) SMF, which has been designed to have low attenuation at 1383 nm, is becoming the most commonly recommended optical fiber for all types of network applications. Standard optical fiber displays an attenuation increase at or about 1383 nm. This wavelength is known as the water-peak region and is where light is strongly absorbed by naturally occurring water-like end groups in the glass, causing high attenuation or signal loss. Specifically, hydroxyl end groups, which make up half of a water molecule, are always present at some level within the glass core and cause increased attenuation over this wavelength region. Superior Essex RWP SMF reduces this effect and allows all the wavelengths between 1300 nm and 1550 nm to be usable. This optical fiber is therefore, not only an excellent choice for traditional applications, but also for more advanced systems such as coarse wavelength division multiplexing (CWDM) and dense wavelength division multiplexing (DWDM) technologies. RWP SMF is the standard single mode optical fiber for all Superior Essex premises cables. Refer to the table on page X-4 for performance information.

Non-Zero Dispersion Shifted (NZDS) fiber is used for very high data rates over very long distances (> 30 km). Because of core/cladding modifications, this fiber is more expensive than standard SMF. The advantage of NZDS is that it allows for longer distances between repeaters and therefore lowers the overall system cost for long distance networks. Refer to the table on page X-4 for performance information.

TeraFlex® bend resistant optical fiber is a SMF that complies with ITU-T G.652.D and G.657.A1, A2 or B3. The bend sensitivity of the A1 optical fiber has been improved so that it can be coiled into a 20 mm diameter loop with ≤ 0.5 dB incurred loss at 1625 nm and ≤ 0.2 dB incurred loss at 1550 nm – five times better bending performance than leading RWP optical fibers. TeraFlex offers excellent Polarized Mode Dispersion (PMD) of ≤ 0.1 ps/√km per individual fiber. TeraFlex is an ideal choice for FTTP applications where small enclosures are normal and space is at a premium.

## MULTIMODE OPTICAL FIBER

Multimode fiber (MMF) is identified by the physical size of the core as measured in microns (μm) and the applications for which it is typically used. MMF, the most common types having 62.5/125 μm and 50/125 μm core/ cladding dimensions, are used for data communications links with the local area network (LAN). The term

“multimode” refers to the way the light travels down the optical fiber. For each pulse of light launched into the optical fiber by light source (transceiver), the light signal energy travels within the optical fiber core along multiple “paths,” or modes. These modes travel at different speeds, resulting in the pulse of light spreading out. This effect limits the bandwidth and distances that can be supported by MMF. For this reason, MMF is used in short distance LAN applications usually less than 2 km (6,560 ft) between connections. Typical network applications include Data Centers, building-to-building and communications closet-to-closet backbones, and fiber-to-the-desk. MMF is the choice for these short distance applications cables because of the large core size, which allows for inexpensive connectivity, greater durability and the use of low-cost light sources.

Formerly, light emitting diodes (LED), operating at a nominal wavelength of 850 nm, were used as the light source for MMF cable applications. The use of these LED-based transceivers, MMF cables and inexpensive MMF connector systems provided network designers with a relatively low-cost, high-bandwidth technology for campus-like networks. Today vertical cavity surface emitting lasers, or VCSELs (pronounced “vicsels”) are used since LEDs are unable to be modulated (turned off and on) at speeds greater than 1 Gb/s.

The use of VCSEL transceivers, when compared to traditional LED-based transmission systems, allows for greater distances for traditional applications such as 100 Mbps and for higher bandwidth applications from 1 Gigabit Ethernet (1 GbE) up to 400 Gigabit Ethernet (400 GbE). The VCSEL source transmits light through the center region of the optical fiber core. This has created the requirement for laser-optimized MMF. One of the most popular emerging applications for VCSEL-based LAN application is 100 GbE. By using laser-optimized optical fibers, network engineers can improve transmission performance over greater distances.

TeraGain® optical fibers is available in the 62.5/125 μm type. This optical fiber has been designed to provide greater data rate and distance support compared to other manufacturers’ optical fiber cables. In particular, the bandwidths of 62.5 μm TeraGain optical fiber is greater than the standard 62.5 μm offered by other manufacturers and exceed the requirements specified in TIA-568. TeraGain optical fibers can be used with either LED or laser (VCSEL) transmission equipment. Refer to the table on page X-5 for specific performance information.

TeraFlex 10G 50/125 OM3, OM4 and OM5 bend-resistant 50 μm MMFs are optimized for 850 nm lasers (or VCSELs) and, in the case of OM5 MMF, lasers that operate between 850 nm and 950 nm. These optical fibers exceed industry specifications for both bandwidth and for differential modal dispersion. TeraFlex 10G multimode fibers also have the added benefit of macrobend resistance. These optical fibers exceed industry specifications for minimum bend radii allowing use where tight bend radii are encountered, for example, in Data Centers. This is especially important for applications, like 40, 100, 200 and 400 GbE, where channel margins are tight. These ranges allow engineers to cost effectively design the right optical fiber for their application requirements. Superior Essex offers TeraFlex all three grades: OM3, OM4 and OM5. Refer to the table on page X-5 for specific performance information.

# Optical Fiber Specifications

## Single Mode

Single Mode Fiber Types		Reduced Water		TeraFlex® Bend Resistant		
		Peak	G.657.A1	G.657.A2	G.657.B3	NZDS
9-Digit Part Number Designator		3	K	J	L	8
16-Digit Part Number Designator		10	13	14	15	19

Cable Performance	Parameter	Test Method/Standard	Units	Wavelength	Cable Type									
	Maximum Attenuation	ANSI/TIA-455-78-B-2002	dB/km		1310 nm	Tight Buffer	0.70	0.70	0.70	0.70	-			
Loose Tube						0.35	0.35	0.35	0.35	-				
1383 nm					Tight Buffer	0.70	0.70	0.70	0.70	-				
					Loose Tube	0.35	0.35	0.35	0.35	-				
1490 nm					Tight Buffer	0.70	0.70	0.70	0.70	0.70				
					Loose Tube	0.25	0.25	0.25	0.25	0.30				
1550 nm					Tight Buffer	0.70	0.70	0.70	0.70	0.70				
					Loose Tube	0.25	0.25	0.25	0.25	0.30				
1625 nm					Tight Buffer	0.70	0.70	0.70	0.70	0.70				
					Loose Tube	0.25	0.25	0.25	0.25	0.25				
Typical Attenuation					ANSI/TIA-455-78-B-2002	dB/km		1310 nm	Tight Buffer	0.41	0.41	0.41	0.41	-
									Loose Tube	0.34	0.34	0.34	0.34	-
	1383 nm	Tight Buffer	0.41	0.41				0.41	0.41	-				
		Loose Tube	0.33	0.31				0.31	0.31	-				
	1550 nm	Tight Buffer	0.41	0.41				0.41	0.41	0.41				
		Loose Tube	0.19	0.19				0.19	0.19	0.25				

Fiber Performance	Parameter	Test Method/Standard	Units	Conditions					
	Nominal Group Refractive Index	-	-	-	1310 nm	1.467	1.467	1.467	1.467
1550 nm					1.468	1.468	1.468	1.468	1.468
Maximum Individual Fiber Polarization Mode Dispersion	ANSI/TIA/EIA-455-113-96	ps/√km	-	-	0.2	0.2	0.2	0.2	0.2
Cable Cutoff Wavelength	ANSI/TIA-455-80-C-2003	nm	-	-	1260	1260	1260	1260	1260
Zero Chromatic Dispersion Wavelength	ANSI/TIA-455-175-B-2003	nm	-	-	1300-1324	1300-1324	1304-1324	1304-1324	N/A
Typical Chromatic Dispersion Slope	ANSI/TIA-455-175-B-2003	ps/nm <sup>2</sup> -km	-	-	0.087	0.087	0.087	0.087	0.047
Proof Strength	ANSI/TIA/EIA-455-31-C-2005	kpsi	-	On-line	100	100	100	100	100
				GPa	0.69	0.69	0.69	0.69	0.69
Mode Field Diameter	ANSI/TIA-455-191-B-2003	μm	-	1310 nm	8.8-9.6	8.8-9.6	8.2-9.2	8.2-9.2	N/A
				1550 nm	9.9-10.9	9.9-10.9	9.1-10.1	9.1-10.1	7.8-10.0
Maximum Macrobend Attenuation Increase	ANSI/TIA-455-62-B-2003	dB	-	1310 nm	0.05	0.01	0.01	0.01	0.05
				100 turns on 50 mm mandrel	-	-	0.03	0.01	-
				1550 nm	-	-	0.20	0.03	-
				1 turn on 15 mm mandrel	-	-	0.20	0.03	-
Cladding Diameter	ANSI/TIA-455-176-A-2003	μm	-	-	125.0 ± 0.9	125.0 ± 0.7	125.0 ± 0.7	125.0 ± 0.7	125.0 ± 0.7
				micron	250 ± 10	250 ± 10	250 ± 10	250 ± 10	250 ± 10
Coating Diameter	ANSI/TIA-455-176-A-2003	μm	-	-	0.5	0.5	0.5	0.5	0.5
Maximum Core/Clad Concentricity Error	ANSI/TIA-455-176-A-2003	%	-	-	1	1	0.7	0.7	0.7
Max. Cladding Non-Circularity	ANSI/TIA-455-176-A-2003	%	-	-	1	1	0.7	0.7	0.7
Maximum Coating/Cladding Concentricity Error	ANSI/TIA-455-176-A-2003	μm	-	-	12	12	12	12	12

Guaranteed Supportable Ethernet Distances	Data Rate	Protocol	Units	Wavelength	Maximum Transmission Distances				
	10 Gbps		10GBASE-LR	km	1310 nm	25	25	25	25
10GBASE-ER			km	1550 nm	40	40	40	40	40
10GBASE-ZR			km	1550 nm	80	80	80	80	80
40 Gbps		40GBASE-LR4	km	1550 nm	10	10	10	10	10
		100 Gbps		100GBASE-LR4	km	1550 nm	10	10	10
	100GBASE-ER4	km		1550 nm	40	40	40	40	40

Fiber Channel Link Distances	Throughput Per Direction	Speed Name	Units	Wavelength	Maximum Link Distance				
	800 MBps	8GFC	meters	1310 nm	10,000	10,000	10,000	10,000	10,000
1200 MBps	10GFC	meters	1310 nm	10,000	10,000	10,000	10,000	10,000	
1600 MBps	16GFC	meters	1310 nm	2,000	2,000	2,000	2,000	2,000	

Standards	ISO/IEC	Tight Buffer	11801: OS1a	11801: OS1a	11801: OS1a	11801: OS1a	-
		Loose Tube	24702: OS2	24702: OS2	24702: OS2	24702: OS2	-
		Telcordia	GR-20-CORE				
		ITU-T	G.652.D	G.652.D	G.652.D	G.652.D	G.655.C, E
				G.657.A1	G.657.A2	G.657.B3	G.656
		TIA-492	CAAB	CAAB	CAAB	CAAB	N/A
		IEC 60793-2-50 Type	B1.3	B1.3/B6_a	B1.3/B6_a	B1.3	-
		ANSI/ICEA	Tight Buffer	S-83-596, S-104-696			
		Loose Tube	S-87-640				
	RUS	Loose Tube	PE-90				



# Optical Fiber Specifications

Multimode

TABLE OF CONTENTS

PREMISES CABLE

OSP CABLE

WIRELESS

TECHNICAL INFO

PART NUMBER INDEX

		TeraGain®		TeraFlex® Bend Resistant Laser Optimized 50/125		
Multimode Fiber Types		62.5/125	OM3	OM4	OM5	
9-Digit Part Number Designator		6	N	P	-	
16-Digit Part Number Designator		23	30	32	36	

Cable Performance	Parameter	Test Method/Standard	Units	Wavelength	Cable Type				
	Maximum Attenuation		TIA/EIA-455-78	dB/km	850 nm	Tight Buffer/Loose Tube	3.0	3.0	3.0
		TIA/EIA-455-78	dB/km	1300 nm	Tight Buffer/Loose Tube	1.5	1.5	1.5	1.5
Typical Attenuation		TIA/EIA-455-78	dB/km	850 nm	Tight Buffer	2.5	2.5	2.5	2.5
					Loose Tube	1.8	1.8	1.8	1.8
		TIA/EIA-455-78	dB/km	1300 nm	Tight Buffer	1.0	1.0	1.0	1.0
					Loose Tube	0.6	0.5	0.5	0.5

Fiber Performance	Parameter	Test Method/Standard	Units	Conditions					
	Numerical Aperture	ANSI/TIA-455-177-B-2003	-	-	-	0.275 ± 0.015	0.200 ± 0.015	0.200 ± 0.015	0.200 ± 0.010
Nominal Group Refractive Index	OTDR	-	-	850 nm	1.496	1.483	1.483	1.483	
				1300 nm	1.491	1.479	1.479	1.479	
Macrobend Attenuation Change	ANSI/TIA-455-62-B-2003	dB	100 turns on 75 mm Mandrel	850 nm	≤ 0.5	≤ 0.5	≤ 0.5	≤ 0.5	
				1300 nm	≤ 0.5	≤ 0.5	≤ 0.5	≤ 0.5	
				2 turns on 30 mm Mandrel	850 nm	-	≤ 0.1	≤ 0.1	≤ 0.1
				1300 nm	-	≤ 0.3	≤ 0.3	≤ 0.3	
			2 turns on 15 mm Mandrel	850 nm	-	≤ 0.2	≤ 0.2	≤ 0.2	
				1300 nm	-	≤ 0.5	≤ 0.5	≤ 0.5	
Proof Strength	TIA/EIA-455-31	kpsi	GPa	On-line	100	100	100	100	
				On-line	0.69	0.69	0.69	0.69	
Cladding Diameter	ANSI/TIA-455-176-A-2003	micron	-	-	125 ± 1	125 ± 1	125 ± 1	125 ± 0.08	
Coating Diameter	ANSI/TIA-455-176-A-2003	micron	-	-	242 ± 5	242 ± 5	242 ± 5	242 ± 5	
Core/Clad Concentricity Error	ANSI/TIA-455-176-A-2003	microns	-	-	1.0	1.0	1.0	1.0	
Cladding Non-Circularity	ANSI/TIA-455-176-A-2003	%	-	-	0.7%	0.7%	0.7%	0.7%	
Coating/Clad Concentricity Error	ANSI/TIA-455-176-A-2003	microns	-	-	8 μm	8 μm	8 μm	8 μm	
Minimum Bandwidth: Overfilled Launch	TIA/EIA-455-124-2000	MHz-km	-	850 nm	220	1,500	3,500	3,500	
				1300 nm	600	500	500	500	
Minimum Bandwidth: Laser Effective Modal Bandwidth	TIA-455-220-A	MHz-km	-	850 nm	N/A	2,000	4,700	4,700	
				953 nm	-	-	-	2,470	
				1300 nm	N/A	500	500	500	

Guaranteed Supportable Ethernet Distances	Data Rate	Protocol	Units	Wavelength	Maximum Transmission Distances			
	1 Gbps		100GBASE-SX	meters	850 nm	300	1,000	1,040
100GBASE-LX			meters	1300 nm	600*	600	600	600
10 Gbps		10GBASE-SR	meters	850 nm	35	300	550	550
		10GBASE-LRM	meters	1300 nm	300	300	300	300
40 Gbps		40GBASE-SR4	meters	850 nm	-	100	125	125
100 Gbps		100GBASE-SR10	meters	850 nm	-	100	125	125
		100GBASE-SR4	meters	850 nm	-	100	125	125
200 Gbps		200GBASE-SR4	meters	850 nm	-	80	100	100
400 Gbps		400GBASE-SR16	meters	850 nm	-	70	100	100

\*Mode conditioning patch cord required

Fiber Channel Link Distances	Throughput Per Direction	Speed Name	Units	Wavelength	Maximum Link Distance			
	800 MBps	8GFC	meters	850 nm	21	150	190	190
	1200 MBps	10GFC	meters	850 nm	33	300	300	300
	1600 MBps	16GFC	meters	850 nm	15	100	125	125

Standards	ISO/IEC 11801	OM1	OM3	OM4	OM5
	Telcordia	GR-20-CORE			
	TIA-492	AAAA-A	AAAC-B	AAAD	AAAE
	IEC 60793-2-10 Type	A1b	A1a.2b	A1a.3b	A1a.4b
	ANSI/ICEA	Tight Buffer	S-83-596, S-104-696		
Loose Tube	S-87-640				

# Optical Fiber Cable

## ANSI/TIA/EIA-598-B STANDARD COLORS

Fiber/Unit Number	Fiber Color
1	Blue
2	Orange
3	Green
4	Brown
5	Slate
6	White
7	Red
8	Black
9	Yellow
10	Violet
11	Rose
12	Aqua
13 and higher	The color code is repeated, Black stripe or dash is added, according to the ANSI/TIA/EIA-598-B specifications

## STANDARD JACKET COLORS

Cable Type	Standard Jacket Color
Single Mode Premises	Yellow
Standard Multimode Premises	Orange
Laser-Optimized 50 µm Premises	Aqua
Indoor/Outdoor	Black
Composite Standard Multimode Premises	Orange
Composite Laser-Optimized 50 µm Premises	Aqua
Outside Plant (OSP)	Black*

Custom jacket colors also available

\*One extruded color stripe is available. Standard stripe colors are Orange, Green, Yellow and Blue (other colors available upon request).

## OSP FLOODING COMPOUND AND JACKET MARKING OPTIONS

	Flooding Compound	Jacket Marking	Part No. Designator (Last Digit in Part No.)
Standard	Dry (SAP) Block	Feet	1
	Dry (SAP) Block	Meters	2
Options	Special Print Dry (SAP) Block	Feet	5
	Special Print Dry (SAP) Block	Meters	6
	Special Print Flooding Compound	Feet	7
	Special Print Flooding Compound	Meters	8

## OSP CENTRAL MEMBERS/STRENGTH MEMBERS OPTIONS

	Central Member/Strength Member
Standard	Dielectric / Dielectric
Options	Standard loose tube cables are available with a steel center member
	Single tube cables are available with steel strength members embedded in the outer jacket

## ADDITIONAL OSP OPTIONS

- Special protection jacket
- Rodent and fuel protection
- Nylon outer jacket

Contact your Superior Essex sales representative for further information.

# Canadian Central Office Cable

The distinctive Canadian insulation color-coding utilizes colored ink in a systematic pattern of dots/dashes/bands. These marks provide positive identification of each conductor and each pair within a unit. Cable cores may contain both pairs and single conductors. And, some cables may contain "spare" pairs. Each insulated conductor shall be marked with 1 or 2 dots/dashes/bands in accordance with the table below.

## INSULATION COLOR CODES

Pair Number	Conductor #1		Conductor #2	
	Solid Color	Single Band Color	Solid Color	Double Band Color
1	Blue	White	Blue	White
2	Orange	White	Orange	White
3	Green	White	Green	White
4	Brown	White	Brown	White
5	Slate	White	Slate	White
6	Blue	Red	Blue	Red
7	Orange	Red	Orange	Red
8	Green	Red	Green	Red
9	Brown	Red	Brown	Red
10	Slate	Red	Slate	Red
11	Blue	Black	Blue	Black
12	Orange	Black	Orange	Black
13	Green	Black	Green	Black
14	Brown	Black	Brown	Black
15	Slate	Black	Slate	Black
16	Blue	Yellow	Blue	Yellow
17	Orange	Yellow	Orange	Yellow
18	Green	Yellow	Green	Yellow
19	Brown	Yellow	Brown	Yellow
20	Slate	Yellow	Slate	Yellow
21	Blue	Violet	Blue	Violet
22	Orange	Violet	Orange	Violet
23	Green	Violet	Green	Violet
24	Brown	Violet	Brown	Violet
25	Slate	Violet	Slate	Violet

## SPARE PAIR INSULATION COLOR CODES

Spare Pair Number	Conductor #1		Conductor #2	
	Solid Color	Single Band Color	Solid Color	Double Band Color
1	White	Black	White	Black
2	White	Yellow	White	Yellow
3	Red	White	Red	White
4	Red	Yellow	Red	Yellow
5	Red	Black	Red	Black

## SPARE SINGLE INSULATION COLOR CODES

Spare Single Number	Single Conductor	
	Solid Color	Triple Band Color
1	White	Black
2	White	Yellow
3	Red	White
4	Red	Yellow

For pairs numbering 1 through 25, the pair identification colors are outlined below. In cable constructions containing more than 25-pair, the colors are repeated as necessary. Color coded binders are used to identify 25-pair groups of color coded pairs.

PAIR IDENTIFICATION COLORS		
Pair Number	Tip Color	Ring Color
1	White	Blue
2	White	Orange
3	White	Green
4	White	Brown
5	White	Slate
6	Red	Blue
7	Red	Orange
8	Red	Green
9	Red	Brown
10	Red	Slate
11	Black	Blue
12	Black	Orange
13	Black	Green
14	Black	Brown
15	Black	Slate
16	Yellow	Blue
17	Yellow	Orange
18	Yellow	Green
19	Yellow	Brown
20	Yellow	Slate
21	Violet	Blue
22	Violet	Orange
23	Violet	Green
24	Violet	Brown
25	Violet	Slate

For cables through 600-pair, 25-pair groups are identified by their binder colors in the same sequence as the pair identification is accomplished. Group 1 has White-Blue binders, Group 2 has White-Orange binders, etc. In this manner, each pair is uniquely identified. In cables having 25-pair or less, binders are normally not used. However, if specified, the binders will be Group 1, White-Blue. For cables of 100-pair or less, the use of the White binder is optional.

GROUPS OF PAIRS BINDER IDENTIFICATION COLORS			
Group Number	Group Pair Counts	Binder Colors	
1	1-25	White	Blue
2	26-50	White	Orange
3	51-75	White	Green
4	76-100	White	Brown
5	100-125	White	Slate
6	126-150	Red	Blue
7	151-175	Red	Orange
8	176-200	Red	Green
9	201-225	Red	Brown
10	226-250	Red	Slate
11	251-275	Black	Blue
12	276-300	Black	Orange
13	301-325	Black	Green
14	326-350	Black	Brown
15	351-375	Black	Slate
16	376-400	Yellow	Blue
17	401-425	Yellow	Orange
18	426-450	Yellow	Green
19	451-475	Yellow	Brown
20	476-500	Yellow	Slate
21	501-525	Violet	Blue
22	526-550	Violet	Orange
23	551-575	Violet	Green
24	576-600	Violet	Brown

It is desirable for manufacturing purposes to combine four 25-pair groups into "super units" when cables have 900-pair or more.

SUPER-UNITS BINDER IDENTIFICATION COLORS		
Pair Number	Group Number	Binder Color
1-600	1-24	White
601-1,200*	25-48	Red
1,201-1,800*	49-72	Black
1,801-2,400*	73-96	Yellow
2,401-3,000*	97-120	Violet
3,001-3,600*	121-144	Blue
3,601-4,200*	145-168	Orange

\*The above information is based on the Full Count binder color coding used in RDUP copper cable designs having 1,200-pair or more.



### TECHNICAL GUIDELINE

Binder color coding information and core lay-up diagrams are available on our site. Refer to the "Resources" section on our site for the Technical Guideline, "OSP Copper Core Lay-up Diagrams: Full Count or Mirror Image," for more information.

# Mechanical Protection (+M) for Extreme Risk Environments

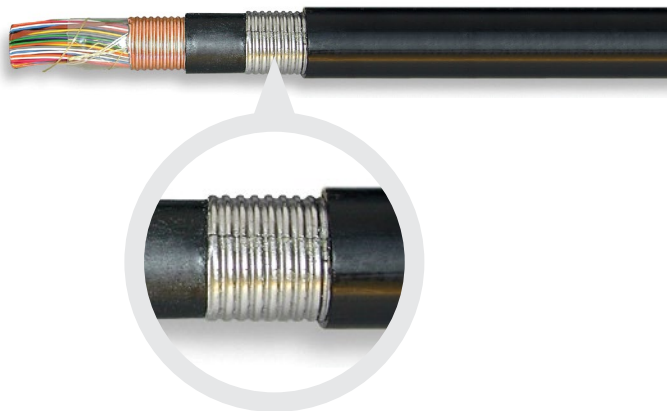

## PRODUCT DESCRIPTION

Superior Essex standard OSP cable offering with the +M feature is designed for extreme direct burial or lashed aerial installations. Extreme environments can include locations difficult to access, those with rocky or unstable terrain, rodent infested locations and shallow water crossings. Mechanical protection (+M) armoring is suitable for environments where additional mechanical protection is warranted or desired.

Weight and diameters are increased when +M is added to protect standard cables. Approximate weights and diameters can be provided by contacting your Superior Essex Inside or Outside Sales Representative (please specify the standard OSP cable desired).

In most instances, +M protected cables will be supplied in standard ship lengths corresponding to the standard OSP cable selected. Special lengths require Superior Essex approval before manufacturing. Also, reel sizes can be provided upon request.

## SPECIFICATIONS

<b>Basic Cable</b>	Mechanical Protection (+M) may be applied over any OSP Air core or Filled core copper cable
<b>+M Armor</b>	An electrically continuous 0.006 inch corrugated steel armor is applied directly over a basic cable providing additional mechanical protection in extreme environments; the sheath interfaces are fully flooded as the steel armor is applied longitudinally with an overlap, encasing the basic cable
<b>Overall Jacket</b>	A black, polyethylene jacket designed to provide a tough protective covering is applied overall; the polyethylene contains antioxidant(s) for long-term stability and furnace black to prevent damage from ultraviolet exposure
<b>Jacket Marking</b>	Identifying information includes a telephone handset, cable code, pair count, AWG, date of manufacture and sequential length markings at 2 foot intervals
<b>Temperature Rating</b>	See temperature rating for underlying cable

## APPLICATIONS

- Direct burial where additional mechanical protection is required or desired
- Lashed aerial where additional mechanical protection is required or desired
- GOPIC®-F+M and CASPIC®-F+M cable designs can be used for submersion under water in short shallow rivers, ponds or lakes not exceeding 30 feet deep

## NEC FIRE RESISTANCE RATINGS

Article 800 of the National Electrical Code (NEC), also known as NFPA 70, covers requirements for low-voltage communications cables. The NEC requires that cables used in premises, both commercial and residential, be “listed for the purpose” by a Nationally Recognized Test Laboratory (NRTL, pronounced “nurtle”). Other countries have similar requirements. UL (Underwriters Laboratories Inc.) is the most recognized listing agency in the US. UL 444 is the overall specification used to identify the requirements for listed communications cables.

Many of the fire resistance test procedures called out in UL 444 are written by UL. However, other laboratories, such as ITS (Intertek Testing Services) and CSA (Canadian Standards Association), can also provide listing compliance to the NEC.

Five levels of fire resistance are specified. These are outlined below, from most stringent to least. The ratings are hierarchical, i.e., from a fire resistance standpoint, a higher rating can be substituted for any lower rating, but not vice versa.

NEC Designation	CSA Equivalent	Common Term	Test	Comments
CMP	FT6	Communications Plenum	NFPA 262	<ul style="list-style-type: none"> <li>Cable must have resistance to flame spread and reduced smoke generating properties</li> <li>Cable is approved for placement in air handling ducts and chambers (plenums) without the use of fireproof conduit</li> <li>Purpose of the rating is to lessen the transmission of fire and visible smoke to unaffected parts of the building</li> <li>Toxic or corrosive elements of the smoke are not measured</li> <li>Equivalent to Canadian FT6 rating</li> </ul>
CMR	N/A	Communications Riser	UL 1666	<ul style="list-style-type: none"> <li>Cable must not transmit flame from one floor to another when placed vertically in a building shaft (riser)</li> <li>Equivalent to Canadian FT4 rating</li> </ul>
CMG	FT4	Communications General Use	CSA C22.2 No. 0.3-M (Vertical Tray)	<ul style="list-style-type: none"> <li>Cable may not transmit flame for more than 4 feet, 11 inches</li> <li>Cable shall not penetrate floors or ceilings (i.e. cable may only be used within a single floor)</li> <li>Designation was added as a part of the harmonization efforts between U.S. and Canadian standards</li> </ul>
CM	N/A	Communications General Purpose	UL 1581 (Vertical Tray)	<ul style="list-style-type: none"> <li>Cable may not transmit flame for more than 4 feet, 11 inches</li> <li>Cable shall not penetrate floors or ceilings (i.e. cable may only be used within a single floor)</li> </ul>
CMX	FT1	Communications Limited Purpose	UL 1581 VW-1 (Vertical Wire)	<ul style="list-style-type: none"> <li>Cable meets the least stringent flame spread requirements of all ratings</li> <li>For residential use, but can only be installed in one and two-family (duplex) housing units</li> <li>Often rated with optional UL requirements for outdoor use*</li> </ul>

\*These “outdoor” requirements are limited to some cold temperature properties and UV resistance. They do not qualify a cable to be substituted for an Outside Plant (OSP) cable. For example, they have no protection against the intrusion of water, which can destroy a cable’s transmission properties and physically degrade a cable as well. The purpose of the “outdoor” rating is to ensure the cable can withstand outdoor exposure in the short run between the Network Interface Unit and the point of entry into the interior of the home.

## BALANCED TWISTED PAIR TRANSMISSION CATEGORIES

In response to growing demand for data applications, premises cable performance has evolved such that several categories of transmission performance for balanced twisted pair cables have been developed. These

categories are detailed below. The categories are hierarchical, i.e., a higher category can be substituted for any lower category, but not vice versa.

Category	Maximum Bandwidth	Common Applications	Specifications	Comments
CAT 6A	500 MHz	10GBASE-T (IEEE 802.3an)	ANSI/TIA-568.2-D ANSI/ICEA S-90-661	<ul style="list-style-type: none"> <li>Designed for reduced alien crosstalk</li> </ul>
CAT 6	250 MHz	1000BASE-T		<ul style="list-style-type: none"> <li>Doubles the bandwidth of CAT 5e and vastly improves signal-to-noise margins</li> </ul>
CAT 5e	100 MHz	1000BASE-T		<ul style="list-style-type: none"> <li>Characterized by tightly twisted pairs to reduce crosstalk loss</li> <li>Proposed FCC minimum category requirement effective 2020</li> </ul>
CAT 5	100 MHz	100BASE-T 100 Mbps TPDDI 622 Mbps ATM		<ul style="list-style-type: none"> <li>No longer recognized as an appropriate medium for commercial networking installations (replaced by CAT 5e or higher)</li> </ul>
CAT 3	16 MHz	10BASE-T Analog Voice Telecom Closet Wiring		<ul style="list-style-type: none"> <li>Minimum allowed by the FCC for horizontal cable in commercial and residential voice and data applications</li> <li>Market trend is to abandon CAT 3 in favor of installing CAT 5e or higher for both data and voice</li> </ul>

# Fire Alarm/Security Control Cable

## DISTANCE THE CABLE WILL RUN

Voltage drop should be calculated or refer to equipment manufacturer's recommendations. Knowing the cable run will help identify the right gauge size cable to select. A larger gauge size is suitable for longer runs.

## NON-POWER LIMITED OR POWER LIMITED

The difference between power limited cables and non-power limited cables are specified in specific sections of the NEC.

- **Non-Power Limited Cable** is a fire alarm circuit powered by a source that complies with NEC sections 760-21 and 760-23. Non-power limited fire alarm cables have been designed for installations where fire alarm cables are permitted to occupy the same enclosure, or race way as other Class 1 Circuits, or 600V cables.
- **Power Limited Cable** is a fire alarm circuit powered by a source that complies with section 760-41. Power limited fire alarm cables are rated for 300V. Superior Essex offers only power limited fire alarm and power limited security control cables.

## SHIELDED OR NON-SHIELDED

Is the system microprocessor based and therefore sensitive to EMI and RFI? If the system is computer based, a **shielded** cable will protect the circuits from this outside interference and keep the signal constant. If interference is not a concern, then a **non-shielded** cable is a cost effective solution.

- **EMI** (Electro Magnetic Interference): EMI can come from electrostatic sparks or spiking from motors, neon or fluorescent lighting ballasts or any other sources that cause noise. Shielded cables should be considered for installations in areas near dimmer panels and light switches, in parallel runs, near neon or fluorescent lights and near power cables.
- **RFI** (Radio Frequency Interference): Some frequencies used for radio communications can become coupled onto conductors to produce RFI.

## SIMPLIFYING PRODUCT SELECTION

Superior Essex designed its Fire Alarm and Security Control cables to have multiple NEC and UL listings. A single cable design satisfies several listing categories and can be deployed if one listing category is called out by the customer. As an example, the Fire Alarm cable jacket is marked with three listings: FPLR, CL3R and CMR. This covers UL 1424 for the FPLR rating, UL 13 for the CL3R rating and UL 444 for the CMR rating.

When the customer specification calls for any one of the three specifications, this product is properly listed for that application. This simplifies product selection and helps with ordering stock and installation. Superior Essex has combined General Use (FPL) and Riser (FPLR) into one category called Riser.

Superior Essex Category	NEC/UL Listing	Suitable Applications	Substitutions
Non-Plenum or Riser	FPLR and FPL	Vertical runs in a shaft or from floor to floor and general purpose use	CM, CMR, CL3R
Plenum	FPLP	Ducts, plenums and other space used for environmental air	CMP, CL3P

Power Limited Cable Type	Listing	Bare Copper Standards			NEC and UL Standards				Miscellaneous Standards		
		ASTM B-3 (Solid Copper)	ASTM B-3 and B-8 (Stranded Copper)	UL 1424 Fire Alarm NEC Article 760	UL 13 Security NEC Article 725 (150 Volts)	UL 444 NEC Article 800 (300 Volts)	UL 1666 NFPA 262	California State Fire Marshall	Sunlight Resistant	RoHS-Compliant	
Fire Alarm, Non-Shielded and Shielded	Riser	✓		✓	✓	✓	✓	✓	✓	✓	
	Plenum	✓		✓	✓	✓	✓	✓		✓	
Security Control, Non-Shielded and Shielded	Riser	✓	✓	✓	✓	✓	✓	✓	✓	✓	
	Plenum	✓	✓	✓	✓	✓	✓	✓	✓	✓	

## INSULATION COLORS

Fire Alarm Conductor Number	Insulation Color
1	Black
2	Red
3	Brown
4	Blue
5	Orange
6	Yellow
7	Violet
8	Gray

Security Control Conductor Number	Insulation Color
1	Black
2	Red
3	White
4	Green
5	Brown
6	Blue
7	Orange
8	Yellow
9	Violet
10	Gray
11	Pink
12	Tan

## CABLE SELECTION FOR VIDEO APPLICATIONS

Closed circuit security cameras use baseband frequencies, typically under 5 MHz. These applications are best suited for the bare copper center conductors of the Superior Essex RG-59 coaxial cable, which also features 95% copper braiding. RG-59 coaxial cable is specifically designed for applications operating below 1 GHz, but will also support higher frequency applications at shorter distances than RG-6 coaxial cable.

Many video and RF applications use frequencies above 1 GHz. RG-6 coaxial cable is often the preferred cable choice for applications such as CATV transmission. In such cases, the decision is whether to use 60% or 80% braid/shield or a quad shield design. The quad shield design is slightly more expensive than the 60% and 80% shield designs, but offers superior interference protection than the 60% and 80% braid versions.

It is becoming more common however, for copper category (CAT) twisted pair cables, like CAT 5e and 6, to be used for Closed Circuit over Twisted Pair (CCTP) systems. Digitally formatted signals provide dramatically better pictures and better sound quality. Digital Signal Processed (DSP) cameras fed by copper twisted CAT 5e and 6 cables, typically have more control setting options, plus digital video recorders (DVRs) options. Both DSP cameras and DVRs can typically be connected with coax products, but you should consult the camera manufacturer for its recommendation before making a cable selection.

# Premises Cable Conduit Fill Quick Reference

This information is intended as a guideline. Because conduit sizes may vary by manufacturer, please verify all dimensions prior to using this reference chart. This guideline is based on National Electrical Code (USA) recommendations for conduit fill of runs with no more than two 90°

bends. For assistance in calculating conduit fill, refer to the "Resources" area of our site for the Technical Guideline, "How to Calculate Conduit Fill." Use only approved lubricants.

Conduit Trade Size Designator* English (Metric)	½ (16)	¾ (21)	1 (27)	1¼ (35)	1½ (41)	2 (53)	2½ (63)	3 (78)	3½ (91)	4 (103)	5 (129)
Conduit Internal Diameter in (mm)	0.62 (15.7)	0.82 (20.9)	1.05 (26.6)	1.38 (35.1)	1.61 (40.9)	2.07 (52.5)	2.47 (62.7)	3.07 (77.9)	3.55 (90.1)	4.03 (102.3)	5.05 (128.2)
Conduit Cross-Sectional Area in² (mm²)	0.30 (195)	0.53 (345)	0.87 (559)	1.51 (973)	2.05 (1,322)	3.39 (2,177)	482 (3,106)	745 (4,794)	996 (6,413)	12.83 (8,268)	20.15 (12,984)
Cable Nominal Diameter in (mm)	Number of Cables at Maximum Recommended Conduit Fill (1 Cable @ 53% Maximum, 2 Cables @ 31% Maximum, 3 or More Cables @ 40% Maximum)										
	0.10 (2.5)	15	26	44	76	103	171	262	376	504	649
0.13 (3.3)	9	15	26	45	61	101	155	223	298	384	603
0.15 (3.8)	6	11	19	33	46	76	116	167	224	288	453
0.18 (4.6)	4	8	13	23	32	52	80	116	155	200	314
0.20 (5.1)	3	6	11	19	25	42	65	94	126	162	255
0.21 (5.3)	3	6	10	17	23	38	59	85	114	147	231
0.22 (5.6)	3	5	9	15	21	35	54	77	104	134	210
0.23 (5.8)	2	5	8	14	19	32	49	71	95	122	192
0.24 (6.1)	2	4	7	13	18	29	45	65	87	112	177
0.25 (6.4)	1	4	7	12	16	27	41	60	80	103	163
0.26 (6.6)	1	3	6	11	15	25	38	55	74	96	150
0.27 (6.9)	1	3	6	10	14	23	35	51	69	89	139
0.28 (7.1)	1	3	5	9	13	21	33	48	64	82	130
0.29 (7.4)	1	3	5	9	12	20	31	44	59	77	121
0.30 (7.6)	1	2	4	8	11	19	29	41	56	72	113
0.31 (7.9)	1	2	4	7	10	17	27	39	52	67	106
0.32 (8.1)	1	2	4	7	10	16	25	36	49	63	99
0.33 (8.4)	1	1	4	6	9	15	24	34	46	59	93
0.34 (8.6)	1	1	3	6	8	14	22	32	43	56	88
0.35 (8.9)	1	1	3	6	8	13	21	30	41	53	83
0.40 (10.2)	1	1	2	4	6	10	16	23	31	40	63
0.45 (11.4)	1	1	1	3	5	8	12	18	24	32	50
0.50 (12.7)	0	1	1	3	4	6	10	15	20	25	40
0.55 (14.0)	0	1	1	1	3	5	8	12	16	21	33
0.60 (15.2)	0	0	1	1	2	4	7	10	14	18	28
0.65 (16.5)	0	0	1	1	1	4	6	8	11	15	24
0.70 (17.8)	0	0	1	1	1	3	5	7	10	13	20
0.75 (19.1)	0	0	1	1	1	3	4	6	8	11	18
0.80 (20.3)	0	0	0	1	1	2	4	5	7	10	15
0.85 (21.6)	0	0	0	1	1	1	3	5	6	8	14
0.90 (22.9)	0	0	0	1	1	1	3	4	6	8	12
0.95 (24.1)	0	0	0	1	1	1	2	4	5	7	11
1.00 (25.4)	0	0	0	1	1	1	2	3	5	6	10

\*Identifier only; not an actual dimension

# Packaging

## Descriptions



### Steel Reel

Long lengths of cable are placed onto Steel Reels. An advantage of this reel is that it is environmentally-friendly and recycled for years of service.



### BrakeBox® Dual Brake System

This package is dual purpose. In this design the cable is placed onto a plastic spool, which is placed into a box. The brake allows for back-tension and over-spin control. The spool may be taken from the box for installation or may be left in the box where the cable pays out through a slotted opening.



### Wood/Plywood Reel

Reels may be made of plywood or wood. Superior Essex wooden reels can be recycled an average of five times before retirement (see Web site for further details).



### POP™ Box

In this package, the cable is coiled into a box. The product pays out through a tube opening in the box. This design does not allow for the cable to be removed as a unit from the box.



### Spool

Wire is wound onto a spool. The spool is placed inside a box for protection during shipment. Spools are smaller than wood or steel reels.



### Reel-in-a-Box

This package is dual purpose. In this design the cable is placed onto a plastic spool, which is placed into a box. The spool may be taken from the box for installation or may be left in the box where the cable pays out through a slotted opening.



### Ribbed Spool

Cable is wound onto a black, ribbed, plastic recyclable spool. The spool is robust and easy to handle. Spools are smaller than wood or steel reels.



### Knock-out Box

Cable is coiled and fastened within a box. Knock out boxes can be identified by a perforated "knock-out" that is removed, allowing access to the cable.



### Parallel Cone

This package is designed to fit into the General Machine Products (GMP) cast aluminum wire dispensing system (GMP units 80470 or 80471). When placed onto the GMP dispenser, the jumper or distribution frame wire pays out smoothly. GMP dispensers are most common in central offices.



### Coils

Coils refer to lengths of cable wrapped into a shape (usually a circle) and fastened with one or more ties. Coils can be protected by a shrink wrap. Multiple coils may be placed inside a box or on a pallet for shipping, and may be secured by stretch-wrap. Coils can be custom configured to fit a customer's unique cable and wire feeding systems.



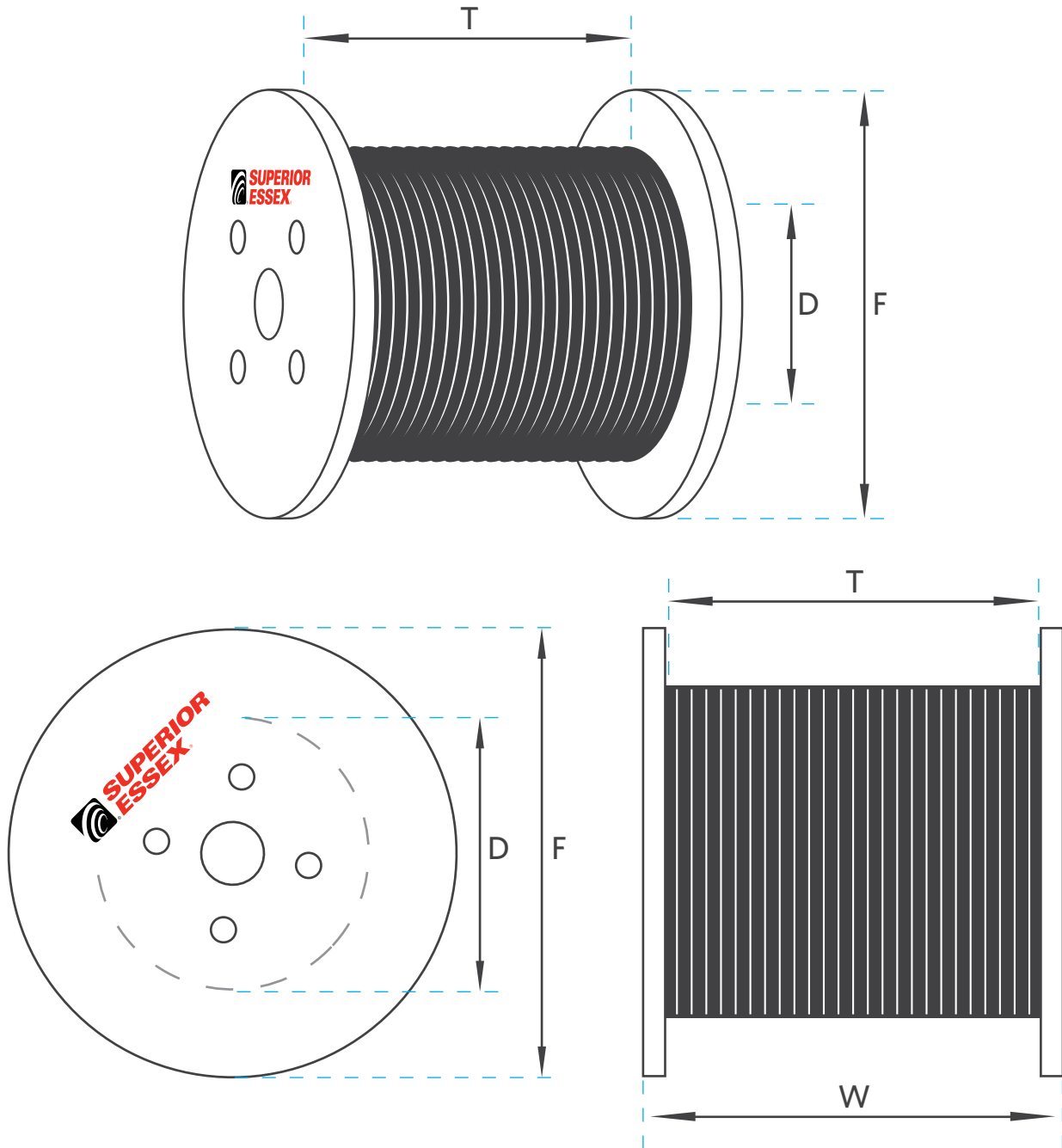

## Flange x Traverse x Drum (F x T x D)

F = Flange Diameter

T = Traverse (inside width between flanges)

D = Drum Diameter

W = Overall Width (includes flanges)

# Packaging

## Premises Fiber Reels

PREMISES FIBER REEL DIMENSIONS						
Reel Type	Plastic			Plywood		
Flange (F) in	12	12	14	16	24	30
Traverse (T) in	6	9	9	15	18	18
Drum (D) in	5	5	5	8	12	12
Overall Width (W) in	7.125	10.125	10.375	15.75	19.375	19.375
Reel Weight lbs	2	2	2	5	17	28
PREMISES FIBER REEL CAPACITIES						
Cable Nominal Diameter in (mm)	Cable Length ft (m)			Cable Length ft (m)		
0.075 (1.91)	2,561 (781)	3,856 (1,175)	7,319 (2,231)	12,836 (3,912)		
0.100 (2.54)	1,441 (439)	2,169 (661)	4,172 (1,272)	7,434 (2,266)	28,571 (8,709)	
0.125 (3.18)	917 (280)	1,383 (422)	2,665 (812)	4,753 (1,449)	18,270 (5,569)	37,970 (11,573)
0.150 (3.81)	637 (194)	961 (293)	1,749 (533)	3,198 (975)	12,283 (3,744)	25,836 (7,875)
0.175 (4.45)	429 (131)	646 (197)	1,321 (403)	2,314 (705)	8,874 (2,705)	19,346 (5,897)
0.200 (5.08)	329 (100)	495 (151)	982 (299)	1,853 (565)	7,123 (2,171)	14,802 (4,512)
0.225 (5.72)	247 (75)	374 (114)	807 (246)	1,290 (393)	5,318 (1,621)	11,630 (3,545)
0.250 (6.35)	227 (69)	343 (105)	661 (202)	1,183 (361)	4,551 (1,387)	9,459 (2,883)
0.275 (6.99)	169 (51)**	255 (77)**	539 (164)**	934 (285)	3,584 (1,093)	7,623 (2,323)
0.300 (7.62)	157 (47)**	238 (72)**	434 (132)**	723 (220)	3,058 (932)	6,433 (1,961)
0.325 (8.26)	112 (34)**	170 (51)**	344 (104)**	678 (207)	2,604 (794)	5,396 (1,645)
0.350 (8.89)	105 (32)**	160 (48)**	327 (99)**	513 (156)	2,208 (673)	4,813 (1,467)
0.375 (9.53)	100 (30)**	151 (46)**	254 (77)**	485 (148)	1,861 (567)	3,987 (1,215)
0.400 (10.16)	67 (20)**	101 (30)**	242 (73)**	460 (140)	1,770 (540)	3,537 (1,078)
0.425 (10.80)	64 (19)**	96 (29)**	183 (55)**	336 (102)**	1,482 (452)	3,131 (954)
0.450 (11.43)	61 (18)**	92 (28)**	176 (53)**	320 (97)**	1,226 (374)	2,763 (842)
0.475 (12.07)	58 (17)**	88 (26)**	169 (51)**	306 (93)**	1,175 (358)	2,428 (740)
0.500 (12.70)	56 (17)**	85 (25)**	163 (49)**	293 (89)**	1,130 (344)	2,348 (716)
0.525 (13.34)	*	*	*	200 (60)**	922 (281)	2,056 (627)
0.550 (13.97)	*	*	*	193 (58)**	889 (271)	1,789 (545)
0.575 (14.61)	*	*	*	186 (56)**	710 (216)	1,737 (530)
0.600 (15.24)	*	*	*	179 (54)**	687 (209)	1,501 (458)
0.625 (15.88)	*	*	*	173 (52)**	665 (203)	1,461 (445)
0.650 (16.51)	*	*	*	168 (51)**	645 (196)**	1,251 (381)**
0.675 (17.15)	*	*	*	*	500 (152)**	1,220 (371)**
0.700 (17.78)	*	*	*	*	486 (148)**	1,191 (363)**
0.725 (18.42)	*	*	*	*	473 (144)**	1,009 (307)**
0.750 (19.05)	*	*	*	*	460 (140)**	986 (300)**
0.775 (19.69)	*	*	*	*	449 (136)**	965 (294)**
0.800 (20.32)	*	*	*	*	438 (133)**	805 (245)**
0.825 (20.96)	*	*	*	*	324 (98)**	789 (240)**
0.850 (21.59)	*	*	*	*	317 (96)**	773 (235)**
0.875 (22.23)	*	*	*	*	309 (94)**	759 (231)**
0.900 (22.86)	*	*	*	*	303 (92)**	621 (189)**
0.925 (23.50)	*	*	*	*	296 (90)**	610 (185)**
0.950 (24.13)	*	*	*	*	290 (88)**	599 (182)**
0.975 (24.77)	*	*	*	*	284 (86)**	589 (179)**
1.000 (25.40)	*	*	*	*	279 (85)**	579 (176)**

\*Drum diameter is less than 10 times cable diameter (minimum bend radius). \*\*Drum diameter is less than 20 times cable diameter (recommended bend radius). This chart pertains to round cable only, and may be further limited by the design of the cable.

OSP FIBER WOOD REEL DIMENSIONS							
Flange (F) in	30	36	48	60	72	84	96
Traverse (T) in	18	30	32	36	36	42	42
Drum (D) in	12	17	23	29.5	37.5	42	48
Overall Width (W) in	20	32	34	39	39	45	45
Reel Weight lbs	59	104	184	416	596	900	1,100

OSP FIBER WOOD REEL CAPACITIES							
Cable Nominal Diameter in (mm)	Cable Length ft (m)						
0.35 (8.89)	5,015 (1,529)	11,293 (3,442)	23,685 (7,219)	41,668 (12,700)			
0.40 (10.16)	3,686 (1,123)	8,411 (2,564)	17,893 (5,454)	32,687 (9,963)	46,454 (14,159)		
0.45 (11.43)	2,879 (878)	6,640 (2,024)	14,038 (4,279)	25,425 (7,750)	35,596 (10,850)		
0.50 (12.70)	2,447 (746)	5,667 (1,727)	11,578 (3,529)	20,477 (6,241)	29,187 (8,896)		
0.55 (13.97)	1,864 (568)	4,397 (1,340)	9,501 (2,896)	17,252 (5,259)	23,795 (7,253)	40,579 (12,369)	
0.60 (15.24)	1,564 (477)	3,726 (1,136)	7,728 (2,356)	14,487 (4,416)	20,240 (6,169)	33,839 (10,314)	45,134 (13,757)
0.65 (16.51)	1,304 (397)**	3,143 (958)	6,749 (2,057)	12,091 (3,685)	17,160 (5,230)	29,324 (8,938)	38,085 (11,608)
0.70 (17.78)	1,242 (378)**	2,635 (803)	5,889 (1,795)	10,003 (3,049)	14,469 (4,410)	25,357 (7,729)	33,321 (10,156)
0.75 (19.05)	1,028 (313)**	2,508 (764)	5,126 (1,562)	8,842 (2,695)	12,927 (3,940)	21,847 (6,659)	29,096 (8,869)
0.80 (20.32)	839 (255)**	2,089 (637)	4,445 (1,355)	7,806 (2,379)	11,549 (3,520)	18,723 (5,707)	25,327 (7,720)
0.85 (21.59)	806 (245)**	1,717 (523)	3,836 (1,169)	6,875 (2,095)	9,580 (2,920)	16,929 (5,160)	21,947 (6,689)
0.90 (22.86)	647 (197)**	1,647 (502)**	3,288 (1,002)	6,034 (1,839)	8,501 (2,591)	15,303 (4,664)	19,987 (6,092)
0.95 (24.13)	624 (190)**	1,333 (406)**	3,165 (965)	5,273 (1,607)	8,172 (2,491)	13,821 (4,213)	18,201 (5,548)
1.00 (25.40)	603 (183)**	1,284 (391)**	2,694 (821)	5,083 (1,549)	7,246 (2,208)	12,466 (3,800)	16,564 (5,049)
1.05 (26.67)	474 (144)**	1,240 (377)**	2,603 (793)	4,424 (1,348)	6,399 (1,951)	11,223 (3,421)	14,128 (4,306)
1.10 (27.94)	459 (139)**	983 (299)**	2,194 (669)	4,280 (1,305)	5,625 (1,714)	10,078 (3,072)	13,673 (4,168)
1.15 (29.21)	445 (135)**	951 (289)**	2,126 (648)	3,702 (1,128)	5,444 (1,659)	9,022 (2,750)	12,390 (3,777)
1.20 (30.48)	338 (103)**	922 (281)**	1,769 (539)**	3,591 (1,095)	4,762 (1,451)	8,048 (2,453)	11,202 (3,414)
1.25 (31.75)	*	895 (272)**	1,717 (523)**	3,081 (939)	4,621 (1,408)	7,818 (2,383)	10,100 (3,078)
1.30 (33.02)	*	688 (209)**	1,670 (509)**	2,995 (913)	4,016 (1,224)	6,948 (2,118)	9,075 (2,766)
1.35 (34.29)	*	669 (203)**	1,366 (416)**	2,542 (775)	3,905 (1,190)	6,764 (2,062)	8,835 (2,693)
1.40 (35.56)	*	651 (198)**	1,330 (405)**	2,476 (755)	3,366 (1,026)	5,984 (1,824)	7,913 (2,412)
1.45 (36.83)	*	634 (193)**	1,297 (395)**	2,415 (736)	3,279 (999)	5,836 (1,779)	7,719 (2,353)
1.50 (38.10)	*	619 (188)**	1,266 (385)**	2,022 (616)**	3,198 (975)	5,132 (1,564)	6,885 (2,099)

\*Drum diameter is less than 10 times cable diameter (minimum bend radius). \*\*Drum diameter is less than 20 times cable diameter (recommended bend radius). This chart pertains to round cable only, and may be further limited by the design of the cable.

# Packaging

## OSP Fiber/Copper Steel Reels

### OSP FIBER/COPPER STEEL REEL DIMENSIONS

Reel Number	413	414	415	416	417	419	420	487
Flange (F) in	48	50	56	66	78	78	83	96
Traverse (T) in	18	25.4	25.4	25.4	25.4	30	39.8	44.5
Drum (D) in	30	30	30	36	42	42	42	42
Overall Width (W) in	24	31.375	31.375	31.625	32.375	37	46.75	52.875
Reel Weight lbs	216	250	282	360	566	610	782	1,400

### OSP FIBER/COPPER STEEL REEL CAPACITIES

Cable Nominal Diameter in (mm)	Cable Length ft (m)							
0.35 (8.89)	9,866 (3,007)	15,649 (4,770)	23,894 (7,283)	27,367 (8,341)				
0.40 (10.16)	7,288 (2,221)	12,535 (3,821)	18,169 (5,538)	25,756 (7,850)	38,265 (11,663)			
0.45 (11.43)	5,701 (1,733)	9,374 (2,857)	14,342 (4,371)	19,931 (6,075)	29,604 (9,023)	35,013 (10,672)		
0.50 (12.70)	4,814 (1,467)	8,006 (2,440)	11,878 (3,620)	16,777 (5,114)	24,441 (7,450)	28,911 (8,812)		
0.55 (13.97)	3,706 (1,130)	6,312 (1,924)	9,807 (2,989)	13,382 (4,079)	20,099 (6,126)	23,778 (7,248)	37,297 (11,368)	
0.60 (15.24)	3,109 (948)	5,382 (1,640)	8,043 (2,452)	11,178 (3,407)	16,402 (4,999)	19,408 (5,916)	30,984 (9,444)	
0.65 (16.51)	2,598 (792)	4,581 (1,396)	6,528 (1,990)	9,897 (3,017)	13,961 (4,255)	16,523 (5,036)	26,766 (8,158)	
0.70 (17.78)	2,442 (744)	3,885 (1,184)	5,691 (1,735)	8,196 (2,498)	11,831 (3,606)	14,003 (4,268)	23,064 (7,030)	38,432 (11,714)
0.75 (19.05)	2,035 (620)	3,276 (999)	4,953 (1,510)	7,293 (2,223)	10,594 (3,229)	12,541 (3,822)	19,792 (6,033)	33,928 (10,341)
0.80 (20.32)	1,677 (511)	3,109 (948)	4,297 (1,310)	6,388 (1,947)	9,490 (2,893)	11,236 (3,425)	17,889 (5,453)	29,885 (9,109)
0.85 (21.59)	1,594 (486)	2,607 (795)	3,711 (1,131)	5,625 (1,715)	7,934 (2,418)	9,395 (2,864)	15,223 (4,640)	26,239 (7,998)
0.90 (22.86)	1,297 (395)	2,160 (658)	3,553 (1,083)	4,938 (1,505)	7,070 (2,155)	8,373 (2,552)	13,718 (4,181)	22,938 (6,992)
0.95 (24.13)	1,239 (378)	2,066 (630)	3,056 (931)	4,317 (1,316)	6,286 (1,916)	7,446 (2,270)	12,349 (3,764)	21,040 (6,413)
1.00 (25.40)	1,187 (362)	1,982 (604)	2,940 (896)	4,152 (1,266)	6,049 (1,844)	7,167 (2,185)	11,098 (3,383)	19,295 (5,881)
1.05 (26.67)	949 (289)	1,622 (494)	2,512 (766)	3,617 (1,102)	5,373 (1,638)	6,366 (1,931)	9,951 (3,033)	16,682 (5,085)
1.10 (27.94)	912 (278)	1,561 (476)	2,425 (739)	3,129 (954)	4,753 (1,449)	5,633 (1,717)	8,897 (2,712)	15,234 (4,643)
1.15 (29.21)	878 (268)	1,251 (381)	2,052 (625)	3,024 (922)	4,184 (1,275)	4,959 (1,512)	8,619 (2,627)	13,891 (4,234)
1.20 (30.48)	683 (208)	1,208 (368)	1,987 (606)	2,597 (792)	4,051 (1,235)	4,803 (1,464)	7,687 (2,343)	12,642 (3,853)
1.25 (31.75)	660 (201)	1,167 (356)	1,660 (506)	2,517 (767)	3,549 (1,082)	4,208 (1,283)	6,826 (2,081)	12,314 (3,753)
1.30 (33.02)	638 (194)	1,130 (344)	1,611 (491)	2,442 (744)	3,445 (1,050)	4,085 (1,245)	6,636 (2,023)	11,191 (3,411)
1.35 (34.29)	617 (188)	881 (269)	1,565 (477)	2,078 (633)	2,998 (914)	3,556 (1,084)	5,866 (1,788)	10,142 (3,091)
1.40 (35.56)	598 (182)	854 (260)	1,287 (392)	2,020 (616)	2,916 (889)	3,460 (1,055)	5,715 (1,742)	9,162 (2,793)
1.45 (36.83)	447 (136)	830 (253)	1,252 (382)	1,697 (517)	2,840 (866)	3,369 (1,027)	5,022 (1,531)	8,955 (2,729)
1.50 (38.10)	434 (132)	807 (246)	1,220 (372)	1,652 (504)	2,452 (747)	2,910 (887)	4,901 (1,494)	8,063 (2,458)
1.55 (39.37)	421 (128)	785 (239)	1,189 (362)	1,610 (491)	2,392 (729)	2,838 (865)	4,276 (1,303)	7,893 (2,406)
1.60 (40.64)	410 (125)	765 (233)	956 (292)	1,571 (479)	2,335 (712)	2,771 (845)	4,178 (1,273)	7,079 (2,158)
1.65 (41.91)	399 (122)	571 (174)	933 (284)	1,298 (396)	1,995 (608)	2,368 (722)	4,086 (1,245)	6,938 (2,115)
1.70 (43.18)	389 (119)	557 (170)	912 (278)	1,268 (386)	1,950 (594)	2,315 (706)	3,534 (1,077)	6,192 (1,887)
1.75 (44.45)	379 (116)	543 (166)	892 (272)	1,239 (378)	1,907 (581)	2,265 (690)	3,460 (1,055)	6,076 (1,852)
1.80 (45.72)	264 (80)	530 (162)	872 (266)	1,212 (369)	1,608 (490)	1,910 (582)	3,390 (1,033)	5,391 (1,643)
1.85 (46.99)	258 (79)	518 (158)	680 (207)	1,187 (362)	1,574 (480)	1,870 (570)	3,324 (1,013)	5,295 (1,614)
1.90 (48.26)	252 (77)	507 (155)	665 (203)	958 (292)	1,542 (470)	1,832 (558)	2,844 (867)	5,203 (1,586)
1.95 (49.53)	246 (75)	496 (151)	652 (199)	939 (286)	1,511 (461)	1,796 (547)	2,790 (850)	4,586 (1,398)
2.00 (50.80)	240 (73)	485 (148)	639 (195)	920 (280)	1,482 (452)	1,761 (537)	2,739 (835)	4,510 (1,375)
2.05 (52.07)	235 (72)	338 (103)	626 (191)	902 (275)	1,228 (374)	1,460 (445)	2,691 (820)	4,437 (1,352)
2.10 (53.34)	230 (70)	331 (101)	615 (187)	885 (270)	1,205 (367)	1,432 (436)	2,269 (692)	3,879 (1,182)
2.15 (54.61)	225 (69)	324 (99)	604 (184)	869 (265)	1,183 (361)	1,407 (429)	2,230 (680)	3,819 (1,164)
2.20 (55.88)	221 (67)	318 (97)	593 (181)	859 (261)	1,162 (354)	1,382 (421)	2,193 (668)	3,761 (1,146)
2.25 (57.15)	216 (66)	311 (95)	441 (134)	685 (209)	1,142 (348)	1,358 (414)	2,160 (658)	3,706 (1,129)
2.30 (58.42)	212 (65)	306 (93)	433 (132)	656 (200)	924 (282)	1,099 (335)	2,123 (647)	3,207 (977)
2.35 (59.69)	130 (40)	300 (91)	425 (130)	644 (196)	908 (277)	1,081 (329)	1,758 (536)	3,161 (963)
2.40 (60.96)	128 (39)	295 (90)	418 (127)	634 (193)	893 (272)	1,063 (324)	1,731 (528)	3,117 (950)
2.45 (62.23)	125 (38)	289 (88)	411 (125)	623 (190)	879 (268)	1,046 (319)	1,705 (520)	3,075 (937)
2.50 (63.50)	123 (37)	285 (87)	405 (123)	613 (187)	865 (264)	1,030 (314)	1,679 (512)	3,035 (925)
2.55 (64.77)	*	*	*	604 (184)	852 (260)	1,014 (309)	1,655 (504)	2,594 (791)
2.60 (66.04)	*	*	*	595 (181)	839 (256)	999 (304)	1,632 (497)	2,560 (780)
2.65 (67.31)	*	*	*	443 (135)	826 (252)	984 (300)	1,319 (402)	2,528 (771)
2.70 (68.58)	*	*	*	437 (133)	647 (197)	771 (235)	1,300 (396)	2,497 (761)
2.75 (69.85)	*	*	*	430 (131)	638 (194)	760 (232)	1,282 (391)	2,466 (752)
2.80 (71.12)	*	*	*	424 (129)	628 (191)	749 (228)	1,265 (386)	2,076 (633)
2.85 (72.39)	*	*	*	418 (127)	619 (189)	738 (225)	1,248 (380)	2,051 (625)
2.90 (73.66)	*	*	*	412 (126)	611 (186)	728 (222)	1,232 (376)	2,027 (618)
2.95 (74.93)	*	*	*	406 (124)	602 (183)	718 (219)	1,217 (371)	2,004 (611)
3.00 (76.20)	*	*	*	400 (122)	594 (181)	709 (216)	1,202 (366)	1,981 (604)
3.05 (77.47)	*	*	*	*	587 (179)	700 (213)	1,187 (362)	1,959 (597)
3.10 (78.74)	*	*	*	*	579 (176)	691 (211)	927 (283)	1,938 (591)
3.15 (80.01)	*	*	*	*	572 (174)	682 (208)	916 (279)	1,600 (488)
3.20 (81.28)	*	*	*	*	565 (172)	674 (205)	905 (276)	1,582 (482)
3.25 (82.55)	*	*	*	*	421 (128)	503 (153)	894 (272)	1,565 (477)
3.30 (83.82)	*	*	*	*	416 (127)	497 (151)	884 (269)	1,549 (472)
3.35 (85.09)	*	*	*	*	411 (125)	491 (150)	874 (266)	1,533 (467)
3.40 (86.36)	*	*	*	*	406 (124)	485 (148)	864 (263)	1,518 (463)
3.45 (87.63)	*	*	*	*	401 (122)	479 (146)	855 (261)	1,503 (458)
3.50 (88.90)	*	*	*	*	396 (121)	473 (144)	846 (258)	1,489 (454)

\*Drum diameter is less than 12 times the cable diameter (minimum bend radius).  
 This chart applies to round cable only. Chart shows maximum calculated capacity. Actual available cable lengths may be less than capacity. Capacity is based on 2 inch clearance.

OSP COPPER WOOD REEL DIMENSIONS												
Flange (F) in	30	36	44	46	52	58	62	65	72	78	84	96
Traverse (T) in	18	18	18	25	25	25	30	30	36	40	40	40
Drum (D) in	12	14	20	20	20	20	24	32	36	39	42	48
Overall Width (W) in	21	21	21	28	29	29	34	35	41	45	46	46
Reel Weight lbs	46	64	108	165	203	245	288	368	614	699	797	1,175

Cable O.D. in (mm)	Cable Length ft (m)											
	30	36	44	46	52	58	62	65	72	78	84	96
0.40 (10.16)	3,723 (1,135)	5,844 (1,781)	8,738 (2,663)	13,498 (4,114)	19,316 (5,888)	25,088 (7,647)	33,422 (10,187)	32,580 (9,930)				
0.45 (11.43)	2,908 (886)	4,757 (1,450)	6,802 (2,073)	10,654 (3,247)	15,170 (4,624)	19,545 (5,957)	26,054 (7,941)	25,720 (7,839)	37,698 (11,490)			
0.50 (12.70)	2,472 (753)	3,848 (1,173)	5,576 (1,700)	8,838 (2,694)	12,337 (3,760)	16,303 (4,969)	21,714 (6,618)	21,006 (6,403)	31,148 (9,494)			
0.55 (13.97)	1,883 (574)	3,078 (938)	4,541 (1,384)	7,297 (2,224)	9,930 (3,027)	12,887 (3,928)	17,191 (5,240)	17,033 (5,192)	25,619 (7,809)	32,856 (10,015)	39,025 (11,895)	
0.60 (15.24)	1,580 (482)	2,664 (812)	3,658 (1,115)	5,975 (1,821)	8,378 (2,554)	11,105 (3,385)	14,804 (4,512)	14,431 (4,399)	20,898 (6,370)	28,333 (8,636)	32,542 (9,919)	
0.65 (16.51)	1,317 (401)	2,078 (633)	3,177 (968)	4,834 (1,473)	7,023 (2,141)	9,535 (2,906)	12,710 (3,874)	12,174 (3,711)	17,794 (5,424)	23,225 (7,079)	28,199 (8,595)	36,623 (11,163)
0.70 (17.78)	1,254 (382)	1,774 (541)	2,754 (839)	4,218 (1,286)	6,269 (1,911)	8,142 (2,482)	10,858 (3,310)	10,202 (3,110)	15,077 (4,595)	20,946 (6,384)	24,383 (7,432)	32,041 (9,766)
0.75 (19.05)	1,038 (316)	1,698 (518)	2,379 (725)	3,670 (1,119)	5,183 (1,580)	6,902 (2,104)	9,214 (2,808)	9,087 (2,770)	13,514 (4,119)	17,895 (5,454)	21,007 (6,403)	27,978 (8,528)
0.80 (20.32)	847 (258)**	1,445 (440)	2,046 (624)	3,181 (970)	4,598 (1,401)	6,221 (1,896)	8,299 (2,530)	8,090 (2,466)	12,116 (3,693)	15,185 (4,628)	18,003 (5,487)	24,353 (7,423)
0.85 (21.59)	814 (248)**	1,218 (371)	1,748 (533)	2,743 (836)	4,069 (1,240)	5,601 (1,707)	7,469 (2,277)	7,193 (2,192)	10,118 (3,084)	13,652 (4,161)	16,277 (4,961)	21,102 (6,432)
0.90 (22.86)	654 (199)**	1,174 (358)**	1,679 (512)	2,639 (804)	3,589 (1,094)	4,653 (1,418)	6,220 (1,896)	6,381 (1,945)	9,018 (2,749)	12,263 (3,738)	14,713 (4,485)	19,217 (5,857)
0.95 (24.13)	630 (192)**	980 (299)**	1,425 (434)	2,264 (690)	3,151 (960)	4,153 (1,266)	5,554 (1,693)	5,645 (1,721)	8,020 (2,444)	10,999 (3,352)	13,289 (4,050)	17,499 (5,334)
1.00 (25.40)	609 (186)**	948 (289)**	1,374 (419)	2,187 (667)	3,053 (931)	4,034 (1,230)	5,383 (1,641)	4,974 (1,516)	7,733 (2,357)	9,845 (3,001)	11,985 (3,653)	15,925 (4,854)
1.05 (26.67)	*	781 (238)**	1,155 (352)	1,861 (567)	2,670 (814)	3,593 (1,095)	4,797 (1,462)	4,361 (1,329)	6,866 (2,093)	8,787 (2,678)	10,789 (3,288)	13,583 (4,140)
1.10 (27.94)	*	758 (231)**	1,118 (341)	1,804 (550)	2,318 (707)	3,186 (971)	4,258 (1,298)	4,219 (1,286)	6,071 (1,850)	7,816 (2,382)	9,689 (2,953)	13,145 (4,007)
1.15 (29.21)	*	612 (187)**	927 (283)	1,519 (463)	2,255 (687)	2,810 (856)	3,761 (1,146)	3,682 (1,122)	5,342 (1,628)	7,573 (2,308)	8,674 (2,644)	11,911 (3,630)
1.20 (30.48)	*	*	899 (274)	1,476 (450)	1,944 (593)	2,743 (836)	3,664 (1,117)	3,571 (1,088)	5,181 (1,579)	6,715 (2,047)	7,736 (2,358)	10,769 (3,282)
1.25 (31.75)	*	*	873 (266)	1,225 (373)	1,895 (578)	2,406 (733)	3,219 (981)	3,096 (944)	4,534 (1,382)	6,523 (1,988)	7,515 (2,291)	9,708 (2,959)
1.30 (33.02)	*	*	712 (217)	1,193 (364)	1,618 (493)	2,352 (717)	3,143 (958)	3,010 (917)	4,408 (1,344)	5,759 (1,755)	6,679 (2,036)	8,723 (2,659)
1.35 (34.29)	*	*	693 (211)**	1,162 (354)**	1,580 (482)**	2,049 (625)**	2,743 (836)	2,588 (789)	3,832 (1,168)	5,052 (1,540)	6,502 (1,982)	8,492 (2,588)
1.40 (35.56)	*	*	675 (206)**	948 (289)**	1,545 (471)**	2,007 (612)**	2,683 (818)	2,520 (768)	3,732 (1,138)	4,921 (1,500)	5,751 (1,753)	7,606 (2,318)
1.45 (36.83)	*	*	537 (164)**	925 (282)**	1,304 (397)**	1,733 (528)**	2,323 (708)	2,458 (749)	3,640 (1,109)	4,799 (1,463)	5,609 (1,710)	7,419 (2,261)
1.50 (38.10)	*	*	524 (160)**	904 (276)**	1,276 (389)**	1,699 (518)**	2,274 (693)	2,091 (637)	3,138 (956)	4,182 (1,275)	4,932 (1,503)	6,618 (2,017)
1.55 (39.37)	*	*	511 (156)**	884 (269)**	1,250 (381)**	1,453 (443)**	1,950 (594)	2,041 (622)	3,064 (934)	4,085 (1,245)	4,818 (1,469)	6,465 (1,971)
1.60 (40.64)	*	*	500 (152)**	703 (214)**	1,039 (317)**	1,426 (435)**	1,911 (582)	1,995 (608)	2,995 (913)	3,528 (1,075)	4,205 (1,282)	5,737 (1,749)
1.65 (41.91)	*	*	489 (149)**	688 (210)**	1,019 (311)**	1,400 (427)**	1,875 (572)**	1,674 (510)	2,554 (778)	3,450 (1,052)	4,113 (1,254)	5,612 (1,711)
1.70 (43.18)	*	*	*	*	*	*	1,841 (561)**	1,638 (499)	2,499 (762)	3,376 (1,029)	4,026 (1,227)	4,949 (1,508)
1.75 (44.45)	*	*	*	*	*	*	1,559 (475)**	1,603 (489)	2,447 (746)	3,307 (1,008)	3,483 (1,062)	4,846 (1,477)
1.80 (45.72)	*	*	*	*	*	*	1,531 (467)**	1,571 (479)	2,058 (627)	2,825 (861)	3,412 (1,040)	4,750 (1,448)
1.85 (46.99)	*	*	*	*	*	*	1,505 (459)**	1,295 (395)	2,017 (615)	2,770 (844)	3,345 (1,020)	4,157 (1,267)
1.90 (48.26)	*	*	*	*	*	*	1,255 (383)**	1,269 (387)	1,978 (603)	2,717 (828)	3,282 (1,000)	4,078 (1,243)
1.95 (49.53)	*	*	*	*	*	*	1,235 (376)**	1,245 (379)	1,941 (592)	2,289 (698)	2,808 (856)	4,003 (1,220)
2.00 (50.80)	*	*	*	*	*	*	1,215 (370)**	1,222 (372)	1,906 (581)	2,246 (685)	2,757 (840)	3,931 (1,198)
2.05 (52.07)	*	*	*	*	*	*	*	1,201 (366)	1,574 (480)	2,206 (672)	2,708 (825)	3,410 (1,039)
2.10 (53.34)	*	*	*	*	*	*	*	966 (294)	1,546 (471)	2,168 (661)	2,661 (811)	3,350 (1,021)
2.15 (54.61)	*	*	*	*	*	*	*	949 (289)**	1,520 (463)	2,131 (650)	2,245 (684)	3,294 (1,004)
2.20 (55.88)	*	*	*	*	*	*	*	933 (284)**	1,494 (455)	1,763 (537)	2,207 (673)	3,240 (988)
2.25 (57.15)	*	*	*	*	*	*	*	917 (280)**	1,470 (448)	1,734 (529)	2,171 (662)	2,778 (847)
2.30 (58.42)	*	*	*	*	*	*	*	902 (275)**	1,185 (361)	1,706 (520)	2,137 (651)	2,734 (833)
2.35 (59.69)	*	*	*	*	*	*	*	888 (271)**	1,166 (355)	1,679 (512)	2,104 (641)	2,692 (821)
2.40 (60.96)	*	*	*	*	*	*	*	875 (267)**	1,148 (350)	1,653 (504)	1,742 (531)	2,651 (808)
2.45 (62.23)	*	*	*	*	*	*	*	680 (207)**	1,130 (344)**	1,629 (497)	1,716 (523)	2,241 (683)
2.50 (63.50)	*	*	*	*	*	*	*	670 (204)**	1,114 (340)**	1,605 (489)	1,690 (515)	2,207 (673)
2.55 (64.77)	*	*	*	*	*	*	*	660 (201)**	1,097 (334)**	1,295 (395)	1,666 (508)	2,176 (663)
2.60 (66.04)	*	*	*	*	*	*	*	650 (198)**	1,082 (330)**	1,277 (389)	1,642 (500)	2,145 (654)
2.65 (67.31)	*	*	*	*	*	*	*	641 (195)**	1,067 (325)**	1,259 (384)**	1,619 (493)	2,115 (645)
2.70 (68.58)	*	*	*	*	*	*	*	*	832 (254)**	1,241 (378)**	1,598 (487)	2,087 (636)
2.75 (69.85)	*	*	*	*	*	*	*	*	820 (250)**	1,224 (373)**	1,291 (393)	2,059 (628)
2.80 (71.12)	*	*	*	*	*	*	*	*	809 (247)**	1,208 (368)**	1,273 (388)	1,708 (521)
2.85 (72.39)	*	*	*	*	*	*	*	*	798 (243)**	1,193 (364)**	1,257 (383)**	1,685 (514)
2.90 (73.66)	*	*	*	*	*	*	*	*	788 (240)**	1,178 (359)**	1,240 (378)**	1,664 (507)
2.95 (74.93)	*	*	*	*	*	*	*	*	777 (237)**	919 (280)**	1,225 (373)**	1,643 (501)
3.00 (76.20)	*	*	*	*	*	*	*	*	768 (234)**	907 (276)**	1,210 (369)**	1,623 (495)
3.05 (77.47)	*	*	*	*	*	*	*	*	*	896 (273)**	1,195 (364)**	1,603 (489)
3.10 (78.74)	*	*	*	*	*	*	*	*	*	885 (270)**	1,181 (360)**	1,584 (483)
3.15 (80.01)	*	*	*	*	*	*	*	*	*	874 (266)**	1,167 (356)**	1,282 (391)
3.20 (81.28)	*	*	*	*	*	*	*	*	*	864 (263)**	911 (278)**	1,267 (386)
3.25 (82.55)	*	*	*	*	*	*	*	*	*	854 (260)**	900 (274)**	1,252 (382)**
3.30 (83.82)	*	*	*	*	*	*	*	*	*	*	890 (271)**	1,238 (377)**
3.35 (85.09)	*	*	*	*	*	*	*	*	*	*	880 (268)**	1,224 (373)**
3.40 (86.36)	*	*	*	*	*	*	*	*	*	*	870 (265)**	1,210 (369)**
3.45 (87.63)	*	*	*	*	*	*	*	*	*	*	860 (262)**	1,197 (365)**
3.50 (88.90)	*	*	*	*	*	*	*	*	*	*	851 (259)**	1,184 (361)**
3.55 (90.17)	*	*	*	*	*	*	*	*	*	*	*	1,172 (357)**
3.60 (91.44)	*	*	*	*	*	*	*	*	*	*	*	1,160 (354)**
3.65 (92.71)	*	*	*	*	*	*	*	*	*	*	*	1,148 (350)**

\*Drum diameter is less than 12 times the cable diameter (minimum bend radius). \*\*Drum diameter is less than 15 times the cable diameter (recommended bend radius).  
This chart applies to round cable only. Chart shows maximum calculated capacity. Actual available cable lengths may be less than capacity. Capacity is based on 2 inch clearance.

# Terms and Conditions of Sale

## For Communication Cable, Wire and Connectivity Products

### 1. GENERAL

These Terms and Conditions of Sale (the "Terms") govern Buyer's purchase of any communication cable, wire and connectivity products (the "Products") from Superior Essex International LP ("Seller"). Buyer's purchase of the Products is limited to the terms and conditions contained herein. If these Terms are first tendered to Buyer before Buyer tenders a purchase order or similar document to Seller, these Terms are in lieu of any terms later submitted by Buyer and Seller rejects all additional or different terms and conditions of Buyer, whether confirmatory or otherwise. If Seller tenders these terms after the tender by Buyer of other terms, whether as part of a purchase order or otherwise, then Seller's acceptance of any offer by Buyer associated with Buyer's terms is expressly conditioned upon Buyer's acceptance of these Terms exclusively and to the exclusion of any proffered Buyer terms or conditions, regardless of whether these Terms contain any terms additional to, or different from, any terms proffered by Buyer. Buyer's performance, or acceptance of, or payment for, any products from Seller will constitute Buyer's acceptance of these Terms exclusively. If there is an executed written sales agreement or quotation in effect between the parties (a "Sales Agreement"), these Terms form a part thereof. Waiver by Seller of any breach, remedy or provision of these Terms shall not be construed to be a waiver of any succeeding breach or any other provision or legal remedy of Seller. The section headings of these Terms are for ease of reference only and shall not be admissible in any action to alter, modify or interpret the contents of any section hereof. The International Convention on the Sale of Goods shall have no application to any sales of Products hereunder.

### 2. PRICE, CHARGES AND PAYMENT

Orders are not binding upon Seller until accepted by Seller in its sole discretion. No order submitted by Buyer shall be deemed accepted by Seller unless and until either confirmed in writing by Seller or by delivery of the Product specified in the order, and then only on these Terms. Seller may modify Buyer's order where necessary as follows: (a) substituting the latest or correct part number or part description for the part number or part description set forth on the order; (b) substituting Seller's prices in effect as applicable to the order; (c) substituting an estimated delivery schedule which is reasonable (considering Seller's stock availability and lead time); and (d) correcting any stenographical or typographical error. The price of any Product sold to Buyer shall be Seller's price in effect at time of order entry. Seller's current ancillary charges apply as applicable to the order such as parallel, cut, wood lagging, gas pressure, pulling eye and lift gate charges.

Fees for relating to the Products are subject to adjustment in the event there are cost increases created by circumstances such as, but not limited to, changes in government energy policies, fuel and energy increases, metal premium or metal processing charges, chemical or material price increases, material and supply shortages, transportation and shipping costs. Any accepted order requiring special manufacturing processes, inspection, specified weight, packaging, test results, certification, etc. is subject to additional charges.

Unless otherwise agreed to by Seller in writing, Buyer agrees to pay all amounts due to Seller within thirty (30) days from the date of invoice. Overdue payments shall bear interest and service charges from the due date until paid at a rate of 1.5% (015) per month or the maximum legal rate, whichever is less, and any collection costs of Seller. FAILURE TO PAY ANY AMOUNT WHEN DUE VOIDS ALL WARRANTIES.

Credit is extended at the sole discretion of Seller. If credit has been extended, the amount of credit may be changed or credit withdrawn by Seller at any time, in its sole discretion. If a cash discount is stipulated, it is subject to Buyer's entire account being current. Any discounts given to Buyer by Seller in relation to the price of the Products are conditional upon payment for the Products being made strictly in accordance with the Sales Agreement and these Terms and to Buyer's entire account for all products purchased from Seller being current.

### 3. DELIVERY, TITLE, RISK OF LOSS, AND SHIPPING OF PRODUCTS

Title to and risk of loss of the Products shall pass to Buyer upon tender of such Products to Buyer at Seller's factory or a common carrier. Unless otherwise agreed by Seller in writing, shipping terms shall be Ex Works (Incoterms 2010) Seller's factory or warehouse. Seller's weights shall govern provisional and final settlement. Any shipping date provided by Seller is the Seller's best estimate and will not operate to bind Seller to ship or make deliveries on such date. All shipments shall be subject to Seller's then current shipment terms, including its Freight Policies, Freight Damage Policies, and minimum order values.

Buyer must thoroughly inspect the Products at the time of receipt for signs of damage, discrepancies or a shortage. Inspections of the Products at the time of delivery shall be commenced in the presence of the carrier's driver and Buyer shall note on the freight bill any shortages, discrepancies or damages of any Product received on the carrier's receipt. If concealed loss or damage is discovered, Buyer must report it to the carrier within 15 days from the date of receipt.

### 4. LIMITED WARRANTIES AND DISCLAIMERS

Seller warrants to Buyer that at the time of delivery the Products will conform substantially to Seller's specifications identified in the applicable Product Data Sheets ("Specifications"). As Buyer's sole and exclusive remedy and Seller's entire liability for any breach of the foregoing warranty, Seller will, at its sole option and expense, either refund the purchase price paid, repair or replace the Product which fails to meet this warranty upon return of the nonconforming Product; provided, Buyer notifies Seller of noncompliance in writing:

- (i) for Fiber to the Premises Closure Products ("FTTP"), within ten (10) years of delivery for external plastic and metal parts of the closure and within one (1) year of delivery for internal fiber splice, attachment and management components; and
- (ii) for all other Products, within one (1) year of delivery of such Product.

Transportation charges to and from Seller's location for the return of all nonconforming Products to Seller and their re-shipment to Buyer and the risk of loss thereof will be borne by Seller. Buyer shall use Seller's designated carrier for all re-shipments. These warranties do not apply to any Product that was not properly stored or handled by the Buyer, that was repaired or altered or was otherwise subject to abuse, neglect or improper use by Buyer or a third party, or that has any stage of processing performed on it which causes the defect. EXCEPT WITH RESPECT TO THE SPECIFIC WARRANTIES SET FORTH IN THIS SECTION 4 OF THESE TERMS, SELLER MAKES NO OTHER WARRANTIES WHATSOEVER, EXPRESS OR IMPLIED, REGARDING THE PRODUCTS OR PERFORMANCE OF ITS OBLIGATIONS HEREUNDER, AND SPECIFICALLY DISCLAIMS ANY WARRANTIES OF MERCHANTABILITY OR FITNESS FOR A PARTICULAR PURPOSE. Without limitation, under no circumstances shall Seller be liable for any costs associated with reworking, re-manufacturing or scrapping goods in which defective Product supplied by Seller was incorporated, for any costs associated with production stoppages, machinery breakdown or recall campaigns, or for any troubleshooting, administrative or engineering charges.

### 5. CLAIMS OF PATENT INFRINGEMENT

Seller shall conduct, at its own expense, the entire defense of any claim, suit, action or other proceedings ("Claim") brought against Buyer by a third party alleging that any Product manufactured by Seller infringes upon any United States patent of any third party; provided, however: (i) Seller receives prompt written notice of the Claim; (ii) Seller has full control of the defense and all related settlement negotiations; (iii) the Products are made according to a specification or design furnished by Seller, or if a process patent is involved, the process performed by the Products are recommended in writing by Seller; and (iv) Buyer provides Seller with all necessary assistance, information and authority to perform the defense and negotiate settlement thereof. Provided all four of the foregoing conditions are met, Seller shall, at its own expense, either settle said Claim or shall pay all damages (excluding incidental, consequential, statutory, or punitive damages) and costs awarded by the court therein. If the use or resale of such Products is finally enjoined, Seller shall, at Seller's option, procure for Buyer the right to use or resell the Products, replace them with equivalent non-infringing Products, modify them so they become non-infringing but equivalent, or remove them and refund the purchase price (less a reasonable allowance for use, damage or obsolescence). Buyer shall indemnify and hold Seller harmless from all Claims based upon (i) the use of a Product customized for Buyer based on Buyer's ideas, specifications or designs, (ii) the performance of a process performed by the Products not recommended in writing by Seller, or (iii) the use or sale of the Products delivered hereunder in combination with other products not delivered to Buyer by Seller.

### 6. EXCUSABLE PERFORMANCE

Seller is excused from performing any of its obligations under these Terms, any order or Sales Agreement if its performance is prevented, hindered or delayed by delays of suppliers, acts of God, nature, governments or their agencies, terrorism, war or sabotage, compliance in good faith with any applicable foreign or domestic governmental regulation or order (whether or not it proves to be invalid), fires, riots, inability to supply or obtain, products, materials, raw materials, supplies, fuel or utilities from normal sources of supply, labor disputes, work stoppages, lockouts, delays in transportation, earthquakes, floods, storms or other severe weather conditions, power shortages or power failures or any other events or circumstances beyond Seller's

reasonable control (an "Event"). To the extent an Event delays Seller's performance, such performance shall be extended for as many days beyond the due date until the delay concludes; provided, however, if Seller is unable to perform any of its obligations under any order due to an Event for more than thirty (30) days, it may in its sole option terminate, without liability or penalty, any Sales Agreement, order or obligation in whole or in part. It is expressly understood that the Seller has available a limited source for the materials used by Seller in the manufacture of the Products. If there is an interference, limitation or cessation of any material from Seller's source of supply for any reason, Buyer agrees to relieve the Seller temporarily, proportionately, or permanently of liability under these Terms or any Sales Agreement or order, depending upon whether the interruption of the source of supply is a temporary interruption, a reduced delivery of materials, or a permanent cessation of supply. In the event there is a Product shortage pursuant to this section, Seller may ration and distribute such Products as it deems appropriate.

### 7. TAXES AND EXPORTS

Any and all taxes (not including any U.S. income or excess profit taxes attributable to Seller) which may be imposed by any taxing authority, arising from the sale, delivery or use of the Products and for which Seller may be held responsible for collection or payment, either on its own behalf or that of Buyer, shall be paid by Buyer to Seller upon Seller's demand. Export orders are subject to applicable export regulations and requirements. Buyer disclaims in favor of Seller any right or interest in, the drawback of duty, taxes or surcharges paid on imported material contained in the Products.

### 8. FINANCIAL RESPONSIBILITY OF BUYER

Buyer's solvency is a condition of Seller's performance and Seller may, at any time, in its sole discretion for credit reasons (including a good faith belief that a current or future payment is or may be impaired) or because of Buyer's breach of this or any other agreement with Seller, suspend or change credit terms, fix a limit on credit, require progress payments, demand payment in full of any outstanding balance, withhold shipments, demand COD or request other assurances of payment, cancel or terminate any order or agreement or repossess all Products previously delivered, which Products shall become the absolute property of Seller subject to credit therefor. Buyer grants to Seller a security interest in Products delivered hereunder to secure Buyer's obligations under these Terms and any Sales Agreement and grants to Seller the right to execute, deliver, and/or file any financing statement or do any other thing reasonably necessary to perfect Seller's security interest. Notwithstanding any other provision of these Terms, Seller reserves the right in its absolute discretion from time to time to require payment in full of the price of the Products before delivery of all or any of the Products.

Seller may terminate any order or Sales Agreement by written notice to Buyer if (i) a receiver or trustee is appointed for any of Buyer's property; (ii) Buyer is adjudicated or voluntarily becomes bankrupt or a debtor under any bankruptcy, dissolution or reorganization laws or similar law; (iii) Buyer becomes insolvent or makes an assignment for the benefit of creditors; (iv) an execution is issued pursuant to a judgment rendered against Buyer; or (v) Buyer is unable or refuses to make payment to Seller. If any order or Sales Agreement is terminated by Seller pursuant to this section, Seller shall be relieved of any further obligation to Buyer and Buyer shall reimburse Seller for its termination costs and expenses and a reasonable allowance for profit.

In addition to any right of set off or recoupment provided by law, Buyer agrees that all its accounts with Seller will be administered on a net settlement basis and that Seller may set off debits and credits, including Seller's attorney fees and costs of enforcement, against any of Buyer's accounts regardless of the basis for such debits and credits and without advance notice. In this section, "Seller" includes Seller's parent, subsidiaries and affiliates, and "Buyer" includes Buyer's parent, subsidiaries and affiliates.

### 9. CANCELLATIONS AND RETURNS

All orders accepted by Seller are non-cancelable unless (i) such order is cancelled in writing thirty (30) days prior to the scheduled ship date and (ii) the Products ordered were not manufactured as special or customized items. A cancellation fee of 10% of the quoted price shall apply. If paid for, cancelled Products may be returned for credit only. Return of any Product must be authorized by Seller. Seller will provide Buyer a Return Material Authorization number for all authorized returns which must be shown on the returned Product and associated shipping documents. Standard stock items are returnable at invoice price less a 20% restocking charge, freight prepaid by Buyer to the plant of manufacture or Seller's designated location. Non-stock items, special items and/or custom length cut reels of cables are final sales and not subject to return. All material must be returned to Seller undamaged and in the original packaging.

### 10. CHANGES — PROCESS, MATERIAL AND PRODUCT DESIGN

Seller continually develops and uses new processes, materials and product designs in an effort to improve its Products, while maintaining conformity to the Specifications. If Buyer's applications of the Products rely upon any performance, dimensional or constant criteria other than as required by the applicable Specifications, Buyer must conduct regular testing or evaluation of those specific Products. Seller makes no warranty or representation of any nature that any material shipped conforms to any material of like product description as may have previously been delivered to Buyer.

### 11. LIMITATION OF LIABILITY

IN NO EVENT WILL SELLER BE LIABLE TO BUYER FOR ANY INDIRECT, INCIDENTAL, SPECIAL, PUNITIVE, DELAY, OR CONSEQUENTIAL DAMAGES, INCLUDING WITHOUT LIMITATION, LOSS OF DIRECT OR INDIRECT PROFITS, REVENUE, OR USE, WHETHER ARISING IN CONTRACT, TORT, OR OTHERWISE, EVEN IF BUYER OR ANY OTHER PARTY HAS BEEN ADVISED OF THE POSSIBILITY OF SUCH DAMAGES. IN NO EVENT WILL SELLER'S AGGREGATE LIABILITY TO BUYER EXCEED ALL AMOUNTS ACTUALLY PAID BY BUYER TO SELLER. THESE LIMITATIONS SHALL APPLY NOTWITHSTANDING ANY FAILURE OF ESSENTIAL PURPOSE OF THE LIMITED REMEDY SET FORTH IN SECTION 4.

### 12. CONFIDENTIALITY

Buyer will not disclose to third persons any proprietary or confidential information of Seller concerning its business and operations, including without limitation, pricing information, for a period of five (5) years from the date such confidential information was learned or for confidential information meeting the definition of "trade secret" under applicable law, until such information is no longer a "trade secret." The obligations of confidentiality in this Section 12 do not apply to Confidential Information to the extent that the Confidential Information becomes readily ascertainable by proper means by the public other than through breach of this Section 12 by Buyer.

### 13. CHOICE OF LAW

These Terms and all accepted orders shall be construed in accordance with the laws of the State of Georgia, United States of America without regard to its conflict of law principles. Buyer agrees that any and all disputes with Seller, including contract and tort claims, shall be resolved in the state and federal courts situated in Georgia, and that these courts shall have the exclusive jurisdiction over all such disputes and Buyer consents to the personal jurisdiction in these courts. Any action brought by Buyer against Seller shall be within one (1) year after the cause of action arises or it shall be deemed forever waived.

### 14. ADDITIONAL TERMS

The provisions of these Terms and the Sales Agreement, if any, constitute the entire agreement between Buyer and Seller with respect to the matter contained herein and supersedes any prior oral or written communications, understanding, representations, proposals or agreements with respect to such subject matter. Seller may revise these Terms from time to time. These Terms may not be amended or modified by the Buyer except upon the execution of a written agreement signed by both parties indicating an intent to modify these Terms. Neither Buyer nor Seller may assign any of its rights or obligations hereunder or under any order; provided, however, that Seller shall be permitted to assign any of its rights or obligations under these Terms, Sales Agreement or any order in connection with the sale or transfer of all or substantially all of its business, whether by merger, reorganization, consolidation, transfer of assets, transfer of equity interests, or otherwise. If any provision of these Terms or a Sales Agreement is invalid, unenforceable or in conflict with any law, such provision shall be deemed severed from these Terms and/or the Sales Agreement and the validity of the remainder of these Terms and/or the Sales Agreement shall not be affected thereby. The provisions of these Terms that by their nature are reasonably intended by the parties to survive the expiration or termination of the Terms or any accepted order, including without limitation sections 4, 5, 11, 12, 13 and this section 14, shall survive the expiration or termination of the Terms or any accepted order.

# Part Number Index

Part Number	Page	Part Number	Page	Part Number	Page	Part Number	Page
01-031-38	B-83	02-120-13	B-141	04-069-04	B-93	09-065-92	B-89
01-031-40	B-81	02-121-03	A-128	04-069-21	B-91	09-069-02	B-87
01-034-40	B-81	02-124-03	A-128	04-069-27	B-95	09-069-77	B-107
01-038-40	B-81	02-125-03	A-128	04-073-04	B-93	09-069-92	B-89
01-057-38	B-83	02-126-03	A-128	04-073-27	B-95	09-073-02	B-87
01-059-38	B-83	02-131-23	B-140	04-075-04	B-93	09-073-77	B-107
01-062-38	B-83	02-132-23	B-140	04-077-04	B-93	09-073-92	B-89
01-062-40	B-81	02-211-23	B-140	04-089-85	B-131	09-075-02	B-87
01-065-38	B-83	02-221-13	B-141	04-091-16	B-132	09-075-77	B-107
01-065-40	B-81	02-222-13	B-141	04-092-04	B-93	09-075-92	B-89
01-069-40	B-81	02-223-13	B-141	04-092-21	B-91	09-077-02	B-87
01-073-40	B-81	02-224-13	B-141	04-092-27	B-95	09-077-77	B-107
01-075-40	B-81	02-311-23	B-140	04-094-04	B-93	09-081-02	B-87
01-092-38	B-83	02-350-23	B-140	04-094-21	B-91	09-081-77	B-107
01-094-38	B-83	02-360-23	B-140	04-094-27	B-95	09-083-02	B-87
01-094-40	B-81	02-361-23	B-140	04-094-31	A-123	09-083-77	B-107
01-097-38	B-83	02-362-23	B-140	04-097-04	B-93	09-085-02	B-87
01-097-40	B-81	02-401-13	B-141	04-097-21	B-91	09-092-02	B-87
01-100-38	B-83	02-409-13	B-141	04-097-27	B-95	09-092-05	B-85
01-100-40	B-81	02-431-10	A-166	04-097-31	A-123	09-092-92	B-89
01-104-38	B-83	02-450-13	B-141	04-097-37	A-123	09-094-02	B-87
01-104-40	B-81	02-513-13*	B-141	04-097-85	B-131	09-094-05	B-85
01-108-38	B-83	02-514-13*	B-141	04-100-04	B-93	09-094-92	B-89
01-108-40	B-81	02-702-13*	B-141	04-100-21	B-91	09-097-02	B-87
01-110-40	B-81	02-706-13*	B-141	04-100-27	B-95	09-097-05	B-85
01-112-40	B-81	02-813-10	A-166	04-100-31	A-123	09-097-77	B-107
01-116-40	B-81	02-815-10	A-166	04-100-37	A-123	09-097-92	B-89
01-118-40	B-81	02-820-10	A-166	04-103-85	B-131	09-100-02	B-87
01-120-40	B-81	02-832-10	A-166	04-104-04	B-93	09-100-05	B-85
01-124-40	B-81	02-840-10	A-166	04-104-21	B-91	09-100-77	B-107
02-D02-13	B-141	02-841-10	A-166	04-104-27	B-95	09-100-92	B-89
02-D06-13	B-141	04-A01-55	A-122	04-104-31	A-123	09-104-02	B-87
02-D30-13	B-141	04-001-54	A-117	04-104-37	A-123	09-104-05	B-85
02-E12-13	B-141	04-001-55	A-118	04-108-04	B-93	09-104-77	B-107
02-G11-13	B-141	04-001-58	A-116	04-108-21	B-91	09-104-92	B-89
02-G16-13	B-141	04-001-62	A-120	04-108-27	B-95	09-108-02	B-87
02-G50-13	B-141	04-001-63	A-121	04-110-04	B-93	09-108-05	B-85
02-H12-13	B-141	04-001-64	A-117	04-110-21	B-91	09-108-77	B-107
02-H13-13	B-141	04-001-65	A-118	04-110-27	B-95	09-108-92	B-89
02-001-13	B-141	04-001-68	A-116	04-112-04	B-93	09-110-02	B-87
02-002-13	B-141	04-001-A2	A-120	04-112-21	B-91	09-110-05	B-85
02-004-13	B-141	04-001-A3	A-121	04-112-27	B-95	09-110-77	B-107
02-005-13	B-141	04-001-A4	A-117	04-116-04	B-93	09-110-92	B-89
02-006-13	B-141	04-001-A5	A-118	04-116-21	B-91	09-112-02	B-87
02-006-13	B-141	04-001-A8	A-116	04-118-04	B-93	09-112-77	B-107
02-006-23	B-140	04-026-21	B-91	04-118-21	B-91	09-112-92	B-89
02-010-23	B-140	04-026-27	B-95	04-120-21	B-91	09-116-02	B-87
02-011-23	B-140	04-028-04	B-93	07-021-68	B-119	09-116-77	B-107
02-020-23	B-140	04-028-27	B-95	07-021-69	B-119	09-116-92	B-89
02-021-23	B-140	04-031-04	B-93	07-021-70	B-119	09-118-02	B-87
02-022-23	B-140	04-031-27	B-95	07-021-71	B-119	09-118-77	B-107
02-024-23	B-140	04-034-04	B-93	07-021-72	B-119	09-118-92	B-89
02-031-23	B-140	04-034-27	B-95	07-021-73	B-119	09-120-02	B-87
02-032-13	B-141	04-038-27	B-95	07-021-74	B-119	09-120-77	B-107
02-032-23	B-140	04-052-17	B-132	07-021-75	B-119	09-120-92	B-89
02-033-23	B-140	04-052-84	B-131	07-021-76	B-119	09-121-02	B-87
02-041-13	B-141	04-053-17	B-132	07-021-77	B-119	09-121-77	B-107
02-050-13	B-141	04-053-84	B-131	07-021-98	B-119	09-121-92	B-89
02-050-23	B-140	04-055-17	B-132	07-021-99	B-119	09-124-02	B-87
02-051-13	B-141	04-055-84	B-131	07-022-08	B-119	09-124-77	B-107
02-052-13	B-141	04-056-17	B-132	07-022-11	B-119	09-124-92	B-89
02-053-13	B-141	04-056-84	B-131	07-022-12	B-119	09-125-02	B-87
02-054-13	B-141	04-057-04	B-93	09-026-02	B-87	09-125-77	B-107
02-097-03	A-128	04-057-16*	B-132	09-028-02	B-87	09-125-92	B-89
02-097-61	A-166	04-057-17	B-132	09-031-02	B-87	09-126-02	B-87
02-098-61	A-166	04-057-21	B-91	09-031-77	B-107	09-126-92	B-89
02-100-03	A-128	04-057-27	B-95	09-031-92	B-89	09-145-77	B-107
02-100-61	A-166	04-058-17	B-132	09-034-02	B-87	09-147-77	B-107
02-102-13	B-141	04-058-84	B-131	09-034-77	B-107	09-151-77	B-107
02-104-03	A-128	04-058-85	B-131	09-038-02	B-87	09-153-02	B-87
02-104-61	A-166	04-059-04	B-93	09-038-77	B-107	09-153-77	B-107
02-106-03	A-128	04-059-21	B-91	09-057-02	B-87	09-155-02	B-87
02-108-03	A-128	04-059-27	B-95	09-057-05	B-85	09-155-77	B-107
02-110-03	A-128	04-061-85	B-131	09-057-92	B-89	09-156-77	B-107
02-110-23	B-140	04-062-04	B-93	09-059-02	B-87	09-157-02	B-87
02-111-13	B-141	04-062-16*	B-132	09-059-05	B-85	09-157-77	B-107
02-111-23	B-140	04-062-21	B-91	09-059-92	B-89	09-158-77	B-107
02-112-03	A-128	04-062-27	B-95	09-062-02	B-87	09-159-02	B-87
02-113-13	B-141	04-062-84	B-131	09-062-05	B-85	09-159-77	B-107
02-114-13	B-141	04-065-04	B-93	09-062-77	B-107	10-002-17	B-125
02-116-03	A-128	04-065-21	B-91	09-062-92	B-89	10-002-34	B-120
02-118-03	A-128	04-065-27	B-95	09-065-02	B-87	10-002-34	B-130
02-120-03	A-128	04-067-16*	B-132	09-065-77	B-107	10-006-17	B-125

All information, content, data, specifications, packaging and part numbers detailed herein are subject to change. For the most up-to-date information, please visit [SuperiorEssexCommunications.com](http://SuperiorEssexCommunications.com). Purchase of this product is subject exclusively to the then current Superior Essex International LP Terms and Conditions of Sale for Communications Cable, Wire and Connectivity Products, which can be found on our website, [SuperiorEssexCommunications.com](http://SuperiorEssexCommunications.com), or provided to you upon request.

800.551.8948  
SuperiorEssexCommunications.com



TABLE OF CONTENTS  
PREMISES CABLE  
OSP CABLE  
WIRELESS  
TECHNICAL INFO

PART NUMBER INDEX

## Part Number Index

Part Number	Page	Part Number	Page	Part Number	Page	Part Number	Page
10-012-17	B-125	12-034-13	A-167	12-901-04	B-139	20-062-05	B-99
10-012-19	B-125	12-035-13	A-167	12-903-04	B-139	20-062-20	B-101
10-012-35	B-120	12-041-09	B-122	12-904-04	B-139	20-062-42	B-97
10-012-35	B-130	12-043-09	B-122	12-905-04	B-139	20-062-43	B-100
10-016-06	B-124	12-101-04	B-139	12-906-04	B-139	20-065-05	B-99
10-026-06	B-124	12-101-07	B-129	12-910-04	B-139	20-065-20	B-101
10-040-29	B-126	12-101-13	A-167	18-A99-33	A-125	20-065-42	B-97
10-061-29	B-126	12-102-04	B-139	18-A99-36	A-125	20-065-43	B-100
10-102-35	B-120	12-102-13	A-167	18-B99-33	A-125	20-069-05	B-99
10-102-35	B-130	12-103-04	B-139	18-B99-36	A-125	20-069-20	B-101
10-106-34	B-120	12-103-13	A-167	18-B99-46	A-125	20-069-42	B-97
10-106-34	B-130	12-104-04	B-139	18-C99-33	A-125	20-069-43	B-100
10-116-06	B-124	12-104-13	A-167	18-C99-36	A-125	20-073-05	B-99
10-206-34	B-120	12-105-13	A-167	18-D99-33	A-125	20-073-42	B-97
10-206-34	B-130	12-106-04	B-139	18-041-36	A-125	20-075-05	B-99
10-212-35	B-120	12-106-13	A-167	18-042-13	A-125	20-075-42	B-97
10-212-35	B-130	12-107-04	B-139	18-042-33	A-125	20-077-05	B-99
10-261-38	B-120	12-107-13	A-167	18-141-13	A-125	20-077-42	B-97
10-261-38	B-130	12-108-13	A-167	18-141-33	A-125	20-081-05	B-99
10-262-38	B-120	12-109-13	A-167	18-141-36	A-125	20-081-42	B-97
10-262-38	B-130	12-111-04	B-139	18-241-13	A-125	20-083-05	B-99
10-281-38	B-120	12-112-04	B-139	18-241-23	A-125	20-083-42	B-97
10-281-38	B-130	12-112-13	A-167	18-241-26	A-125	20-097-05	B-99
10-284-38	B-120	12-121-04	B-139	18-241-33	A-125	20-097-20	B-101
10-284-38	B-130	12-122-04	B-139	18-241-36	A-125	20-097-42	B-97
10-285-38	B-120	12-140-03	B-138	18-241-43	A-125	20-097-43	B-100
10-285-38	B-130	12-201-15	A-168	18-241-46	A-125	20-100-05	B-99
10-503-34	B-120	12-202-15	A-168	18-241-56	A-125	20-100-20	B-101
10-503-34	B-130	12-202-37 <sup>1</sup>	A-127	18-341-13	A-125	20-100-42	B-97
10-921-38	B-120	12-203-15	A-168	18-341-33	A-125	20-100-43	B-100
10-921-38	B-130	12-203-37 <sup>1</sup>	A-127	18-341-36	A-125	20-104-05	B-99
10-923-38	B-120	12-204-15	A-168	18-341-46	A-125	20-104-20	B-101
10-923-38	B-130	12-204-37 <sup>1</sup>	A-127	18-475-13	A-125	20-104-42	B-97
11-002-87 <sup>3</sup>	A-127	12-205-15	A-168	18-475-33	A-125	20-104-43	B-100
11-002-88 <sup>3</sup>	A-127	12-206-15	A-168	18-475-36	A-125	20-108-05	B-99
11-002-89 <sup>3</sup>	A-127	12-206-32 <sup>2</sup>	A-127	18-475-46	A-125	20-108-20	B-101
11-003-12 <sup>3</sup>	A-127	12-207-15	A-168	18-499-13	A-125	20-108-42	B-97
11-003-13 <sup>3</sup>	A-127	12-208-15	A-168	18-499-33	A-125	20-110-05	B-99
11-003-30	B-72	12-209-15	A-168	18-499-36	A-125	20-110-42	B-97
11-003-45	B-136	12-210-15	A-168	18-499-46	A-125	20-112-05	B-99
11-003-46	B-136	12-211-15	A-168	18-579-13	A-125	20-112-42	B-97
11-003-53	B-136	12-212-32 <sup>2</sup>	A-127	18-579-33	A-125	20-116-05	B-99
11-003-65	B-121	12-213-32 <sup>2</sup>	A-127	18-579-36	A-125	20-116-42	B-97
11-003-66	B-121	12-214-37 <sup>1</sup>	A-127	18-599-13	A-125	20-118-05	B-99
11-003-91 <sup>3</sup>	A-127	12-216-15	A-168	18-599-33	A-125	20-118-42	B-97
11-003-92 <sup>3</sup>	A-127	12-217-T5	A-169	18-599-36	A-125	20-120-05	B-99
11-005-90	B-140	12-218-T5	A-169	18-599-46	A-125	20-120-42	B-97
12-001-04	B-139	12-220-03	B-138	18-789-13	A-125	20-121-05	B-99
12-001-11	A-167	12-262-01	B-137	18-789-33	A-125	20-121-42	B-97
12-001-12	A-167	12-301-07	B-129	18-799-36	A-125	20-124-05	B-99
12-001-13	A-167	12-302-07	B-129	18-799-46	A-125	20-124-42	B-97
12-002-11	A-167	12-303-07	B-129	18-872-13	A-125	20-145-05	B-99
12-003-12	A-167	12-303-13	A-167	18-872-33	A-125	20-145-20	B-101
12-003-13	A-167	12-303-62 <sup>3*</sup>	A-127	18-872-46	A-125	20-145-42	B-97
12-004-08	B-127	12-304-13	A-167	19-083-01	B-103	20-147-05	B-99
12-004-11	A-167	12-305-07	B-129	19-085-01	B-103	20-147-42	B-97
12-004-12	A-167	12-305-13	A-167	19-116-01	B-103	20-151-05	B-99
12-005-12	A-167	12-311-13	A-167	19-116-01	B-119	20-151-42	B-97
12-005-13	A-167	12-311-36	B-137	19-118-01	B-103	20-153-05	B-99
12-006-08	B-127	12-313-13	A-167	19-120-01	B-103	20-153-42	B-97
12-007-08	B-127	12-318-13	A-167	19-121-01	B-103	20-155-05	B-99
12-008-08	B-127	12-322-36	B-137	19-124-01	B-103	20-155-42	B-97
12-009-08	B-127	12-331-36	B-137	19-125-01	B-103	20-156-05	B-99
12-010-08	B-127	12-401-15	A-168	19-126-01	B-103	20-156-42	B-97
12-011-04	B-139	12-402-15	A-168	19-151-01	B-103	20-157-05	B-99
12-012-04	B-139	12-402-37 <sup>1</sup>	A-127	19-153-01	B-103	20-157-42	B-97
12-013-08	B-121	12-403-13	A-167	19-155-01	B-103	20-158-05	B-99
12-014-08	B-121	12-403-37 <sup>1</sup>	A-127	19-156-01	B-103	20-158-42	B-97
12-015-08	B-121	12-404-37 <sup>1</sup>	A-127	19-157-01	B-103	20-161-05	B-99
12-016-04	B-139	12-406-13	A-167	19-158-01	B-103	21-062-48	B-105
12-018-04	B-139	12-412-32 <sup>2</sup>	A-127	19-159-01	B-103	21-065-48	B-105
12-019-08	B-127	12-414-32 <sup>2</sup>	A-127	19-161-01	B-103	22-031-83	B-109
12-021-09	B-122	12-414-52 <sup>4</sup>	A-127	19-162-01	B-103	22-034-83	B-109
12-022-08	B-127	12-415-52 <sup>4</sup>	A-127	19-164-01	B-103	22-038-83	B-109
12-022-09	B-122	12-416-52 <sup>4</sup>	A-127	19-167-01	B-103	22-042-83	B-109
12-023-08	B-127	12-417-52 <sup>4</sup>	A-127	20-031-05	B-99	22-044-83	B-109
12-024-08	B-127	12-501-13	A-167	20-031-42	B-97	22-062-83	B-109
12-025-08	B-127	12-519-08	B-127	20-034-05	B-99	22-065-83	B-109
12-026-08	B-127	12-607-08	B-139	20-034-42	B-97	22-069-83	B-109
12-031-08	B-127	12-642-01	B-137	20-038-05	B-99	22-073-83	B-109
12-031-12	A-167	12-801-08	B-128	20-038-42	B-97	22-075-83	B-109
12-032-13	A-167	12-805-62 <sup>3*</sup>	A-127	20-042-42	B-97	22-077-83	B-109
12-033-13	A-167	12-842-01	B-137	20-044-42	B-97	22-081-83	B-109



Part Number	Page	Part Number	Page	Part Number	Page	Part Number	Page
22-083-83	B-109	51-xxx-y8	A-96	55-599-47	A-164	78-147-9P	A-134
22-085-83	B-109	51-240-E1	A-102	55-699-23	A-163	78-148-91	A-134
22-097-83	B-109	51-240-x1	A-104	55-699-38	A-159	78-348-91	A-130
22-100-83	B-109	51-240-xG	A-101	55-699-43	A-165	78-558-91	A-140
22-104-83	B-109	51-243-yP	A-98	55-699-46	A-164	78-10C-91	A-138
22-108-83	B-109	51-347-x5	A-110	55-779-19	A-160	78-10C-9P	A-138
22-110-83	B-109	51-372-x5	A-110	55-789-19	A-160	78-10G-9P	A-138
22-112-83	B-109	51-478-45	A-111	55-799-19	A-160	78-11A-9R	A-137
22-116-83	B-109	51-478-48	A-111	55-799-20	A-157	78-14C-91	A-134
22-118-83	B-109	51-499-EL	A-112	55-799-21*	A-158	78-14C-9P	A-134
22-120-83	B-109	52-200-x5	A-86	55-799-23	A-163	78-34C-91	A-130
22-121-83	B-109	52-200-x8	A-86	55-799-24	A-156	78-55C-91	A-140
22-124-83	B-109	52-240-x5	A-86	55-799-26	A-163	78-65C-91	A-136
22-125-83	B-109	52-241-x8	A-86	55-799-38	A-159	78-65C-9P	A-136
22-145-83	B-109	54-246-xA	A-66	55-799-43	A-165	78-75C-91	A-132
22-147-83	B-109	54-246-xB	A-66	55-899-20	A-157	79-107-91	A-138
22-151-83	B-109	54-272-xA	A-66	55-899-21*	A-158	79-107-9P	A-138
22-153-83	B-109	54-272-xB	A-66	55-899-23	A-163	79-147-91	A-134
22-155-83	B-109	55-A99-20	A-157	55-899-38	A-159	79-147-9P	A-134
22-156-83	B-109	55-A99-21*	A-158	55-899-43	A-165	79-148-91	A-134
22-157-83	B-109	55-A99-23	A-163	55-999-20	A-157	79-348-91	A-130
22-158-83	B-109	55-A99-25	A-156	55-999-25	A-156	79-558-91	A-140
22-159-83	B-109	55-A99-26	A-163	55-999-38	A-159	79-658-91	A-136
22-161-83	B-109	55-A99-38	A-159	55-999-43	A-165	79-758-91	A-132
22-162-83	B-109	55-A99-43	A-165	56-201-55	A-115	79-10C-9P	A-138
24-417-83	B-111	55-A99-47	A-164	56-201-58	A-115	79-10G-9P	A-138
24-440-05	B-111	55-B99-20	A-157	56-201-65	A-115	79-11A-9R	A-137
24-440-83	B-111	55-B99-21*	A-158	56-201-68	A-115	79-11B-9R	A-137
24-456-05	B-111	55-B99-23	A-163	56-201-75	A-115	79-14C-91	A-134
24-456-83	B-111	55-B99-24	A-156	56-201-78	A-115	85-018-25	B-136
24-493-05	B-111	55-B99-25	A-156	56-201-5A	A-114	85-019-25	B-136
24-564-05	B-111	55-B99-26	A-163	56-201-5B	A-114	85-026-13	B-113
25-020-79	B-133	55-B99-38	A-159	56-201-6A	A-114	85-028-13	B-113
25-021-79	B-133	55-D99-25	A-156	56-201-6B	A-114	85-031-01	B-115
25-061-86	B-135	55-E99-20	A-157	56-201-7A	A-114	85-031-13	B-113
25-062-86	B-135	55-E99-21*	A-158	56-201-7B	A-114	85-031-41	B-117
25-063-79	B-133	55-E99-23	A-163	56-202-25	A-115	85-034-01	B-115
25-063-86	B-135	55-E99-24	A-156	56-202-28	A-115	85-034-13	B-113
25-064-79	B-133	55-E99-25	A-156	56-202-35	A-115	85-034-41	B-117
25-064-86	B-135	55-E99-26	A-163	56-202-38	A-115	85-038-01	B-115
25-069-86	B-135	55-E99-46	A-164	56-202-45	A-115	85-038-13	B-113
25-078-86	B-135	55-E99-47	A-164	56-202-48	A-115	85-038-41	B-117
25-154-86	B-135	55-F31-23	A-163	56-202-2A	A-114	85-042-01	B-115
25-257-86	B-135	55-F99-21	A-158	56-202-2B	A-114	85-042-13	B-113
25-351-86	B-135	55-F99-26	A-163	56-202-3A	A-114	85-042-41	B-117
25-353-86	B-135	55-F99-43	A-165	56-202-3B	A-114	85-057-13	B-113
25-354-79	B-133	55-G99-23	A-163	56-202-4A	A-114	85-059-13	B-113
25-355-79	B-133	55-G99-26	A-163	56-202-4B	A-114	85-062-01	B-115
25-360-79	B-133	55-H99-26	A-163	66-240-xA	A-69	85-062-13	B-113
25-360-86	B-135	55-H99-47	A-164	66-240-xB	A-69	85-062-41	B-117
25-525-86	B-135	55-K99-26	A-163	66-246-xA	A-69	85-065-01	B-115
25-527-86	B-135	55-L99-26	A-163	66-246-xB	A-69	85-065-13	B-113
25-530-86	B-135	55-N99-46	A-164	66-246-xM	A-70	85-065-41	B-117
25-547-79	B-133	55-N99-47	A-164	66-246-xP	A-78	85-069-01	B-115
25-549-86	B-135	55-P99-23	A-163	66-272-xA	A-69	85-069-13	B-113
25-552-79	B-133	55-P99-26	A-163	66-272-xB	A-69	85-069-41	B-117
25-553-79	B-133	55-P99-46	A-164	66-272-xP	A-78	85-073-01	B-115
25-554-86	B-135	55-Q99-26	A-163	70-065-24	B-76	85-073-13	B-113
25-555-79	B-133	55-R99-26	A-163	70-065-48	B-76	85-073-41	B-117
25-653-79	B-133	55-R99-47	A-164	70-067-36	B-76	85-075-01	B-115
25-654-79	B-133	55-S99-23	A-163	70-067-72	B-76	85-075-13	B-113
25-654-86	B-135	55-U99-23	A-163	70-069-48	B-76	85-077-01	B-115
25-662-79	B-133	55-V99-24	A-156	70-069-72	B-76	85-077-13	B-113
25-663-79	B-133	55-W99-24	A-156	70-071-72	B-76	85-077-41	B-117
25-667-86	B-135	55-Y99-47	A-164	70-071-96	B-76	85-081-01	B-115
25-680-86	B-135	55-021-23	A-163	70-073-96	B-76	85-081-13	B-113
25-681-79	B-133	55-241-23	A-163	70-425-18	B-76	85-081-41	B-117
25-682-86	B-135	55-341-23	A-163	70-425-36	B-76	85-083-13	B-113
25-685-86	B-135	55-399-25	A-156	71-055-02	B-74	85-092-13	B-113
27-145-19	B-104	55-399-26	A-163	71-202-12	B-73	85-094-13	B-113
27-151-19	B-104	55-399-38	A-159	71-402-02	B-74	85-097-01	B-115
27-153-19	B-104	55-399-43	A-165	72-312-01	A-51	85-097-13	B-113
27-155-19	B-104	55-399-46	A-164	72-421-03	A-51	85-100-01	B-115
27-157-19	B-104	55-499-20	A-157	72-512-01	A-50	85-100-13	B-113
27-159-19	B-104	55-499-23	A-163	72-621-03	A-50	85-100-41	B-117
30-062-02	B-79	55-499-25	A-156	77-xxx-yA	A-74	85-104-01	B-115
30-065-02	B-79	55-499-38	A-159	77-xxx-yB	A-74	85-104-13	B-113
30-069-02	B-79	55-499-43	A-165	77-246-E1	A-80	85-104-41	B-117
30-073-02	B-79	55-599-21*	A-158	77-246-x1	A-82	85-108-01	B-115
30-075-02	B-79	55-599-23	A-163	77-272-xG	A-76	85-108-13	B-113
30-400-02	B-79	55-599-25	A-156	78-107-91	A-138	85-108-41	B-117
30-404-02	B-79	55-599-38	A-159	78-107-9P	A-138	85-110-01	B-115
51-xxx-y5	A-96	55-599-43	A-165	78-147-91	A-134	85-110-13	B-113

## Part Number Index

Part Number	Page	Part Number	Page	Part Number	Page	Part Number	Page
85-110-41	B-117	11144xDMy	B-14	13288xx0y	B-40	1G036xxMy	B-19
85-112-01	B-115	11144xN0y	B-38	1A006xDMy	B-17	1G048xD0y	B-3
85-112-13	B-113	11144xx0y	B-8	1A006xx0y	B-11	1G048xDMy	B-15
85-112-41	B-117	11144xxMy	B-18	1A006xxMy	B-21	1G048xx0y	B-9
85-116-01	B-115	11192xD0y	B-2	1A012xD0y	B-5	1G048xxMy	B-19
85-116-13	B-113	11216KDKy	B-22	1A012xDMy	B-17	1G072xD0y	B-3
85-116-41	B-117	11216KDLy	B-22	1A012xx0y	B-11	1G072xDMy	B-15
85-118-01	B-115	11216xD0y	B-2	1A012xxMy	B-21	1G072xx0y	B-9
85-118-13	B-113	11216xDMy	B-14	1A024xD0y	B-5	1G072xxMy	B-19
85-118-41	B-117	11216xN0y	B-38	1A024xDMy	B-17	1G096xD0y	B-3
85-120-01	B-115	11216xx0y	B-8	1A024xx0y	B-11	1G096xDMy	B-15
85-120-13	B-113	11216xxMy	B-18	1A024xxMy	B-21	1G096xx0y	B-9
85-120-41	B-117	11288KDKy	B-22	1A036xD0y	B-5	1G096xxMy	B-19
85-121-13	B-113	11288KDLy	B-22	1A036xDMy	B-17	1G120xDMy	B-15
85-124-13	B-113	11288xD0y	B-2	1A036xx0y	B-11	1G120xxMy	B-19
85-143-41	B-117	11288xDMy	B-14	1A036xxMy	B-21	1G144xD0y	B-3
85-145-13	B-113	11288xN0y	B-38	1A048xD0y	B-5	1G144xx0y	B-9
85-147-01	B-115	11288xx0y	B-8	1A048xDMy	B-17	1G216xD0y	B-3
85-147-13	B-113	11288xxMy	B-18	1A048xx0y	B-11	1G216xx0y	B-9
85-147-41	B-117	11432xD0y	B-2	1A048xxMy	B-21	1G288xD0y	B-3
85-151-01	B-115	11432xx0y	B-8	1A072xD0y	B-5	1G288xx0y	B-9
85-151-13	B-113	12006xD0y	B-4	1A072xDMy	B-17	1H006xx0y	B-47
85-151-41	B-117	12006xx0y	B-10	1A072xx0y	B-11	1H012xx0y	B-47
85-153-01	B-115	12012xD0y	B-4	1A072xxMy	B-21	1H024xx0y	B-47
85-153-13	B-113	12012xDMy	B-16	1A096xD0y	B-5	1H036xx0y	B-47
85-153-41	B-117	12012xx0y	B-10	1A096xDMy	B-17	1H048xx0y	B-47
85-155-13	B-113	12012xxMy	B-20	1A096xx0y	B-11	1H072xx0y	B-47
85-155-41	B-117	12018xx0y	B-10	1A096xxMy	B-21	1H096xx0y	B-47
85-156-13	B-113	12024D02Q	B-77	1A120xDMy	B-17	1H144xx0y	B-47
85-157-01	B-115	12024xD0y	B-4	1A120xxMy	B-21	1H216xx0y	B-47
85-157-13	B-113	12024xDMy	B-16	1A144xD0y	B-5	1N012xx0y	B-48
85-158-13	B-113	12024xx0y	B-10	1A144xx0y	B-11	1N024xx0y	B-48
85-233-06	B-123	12024xxMy	B-20	1A216xD0y	B-5	1N036xx0y	B-48
86-578-A1	A-142	12036xD0y	B-4	1A216xx0y	B-11	1N048xx0y	B-48
86-57D-A1	A-142	12036xx0y	B-10	1A288xD0y	B-5	2F-A1x-31	A-151
89-578-A1	A-142	12048xD0y	B-4	1A288xx0y	B-11	2F-A1x-32	A-153
11006xD0y	B-2	12048xDMy	B-16	1C006xx0y	B-13	2F-A1x-43	A-151
11006xN0y	B-38	12048xx0y	B-10	1C012xD0y	B-7	2F-A1x-44	A-153
11006xx0y	B-8	12048xxMy	B-20	1C012xx0y	B-13	2F-A2x-31	A-151
11012KDKy	B-22	12072xD0y	B-4	1C024xD0y	B-7	2F-A2x-32	A-153
11012KDLy	B-22	12072xDMy	B-16	1C024xx0y	B-13	2F-A2x-43	A-151
11012xD0y	B-2	12072xx0y	B-10	1C036xD0y	B-7	2F-A2x-44	A-153
11012xDMy	B-14	12072xxMy	B-20	1C036xx0y	B-13	2F-A3x-31	A-151
11012xN0y	B-38	12096xD0y	B-4	1C048xD0y	B-7	2F-A3x-32	A-153
11012xx0y	B-8	12096xDMy	B-16	1C048xx0y	B-13	2F-A3x-43	A-151
11012xxMy	B-18	12096xx0y	B-10	1C072xD0y	B-7	2F-A3x-44	A-153
11018xx0y	B-8	12096xxMy	B-20	1C072xx0y	B-13	2F-A4x-31	A-151
11024C02Q	B-77	12144xD0y	B-4	1C096xD0y	B-7	2F-A4x-32	A-153
11024D01Q	B-77	12144xDMy	B-16	1C096xx0y	B-13	2F-A4x-43	A-151
11024xD0y	B-2	12144xx0y	B-10	1C144xD0y	B-7	2F-A4x-44	A-153
11024xDMy	B-14	12144xxMy	B-20	1C144xx0y	B-13	2F-A5x-31	A-151
11024xN0y	B-38	12192xD0y	B-4	1D006xx0y	B-12	2F-A5x-32	A-153
11024xx0y	B-8	12192xx0y	B-10	1D012xx0y	B-12	2F-A5x-43	A-151
11024xxMy	B-18	12216xD0y	B-4	1D024xD0y	B-6	2F-A5x-44	A-153
11036xD0y	B-2	12216xDMy	B-16	1D024xx0y	B-12	2F-A6x-31	A-151
11036xN0y	B-38	12216xx0y	B-10	1D036xD0y	B-6	2F-A6x-32	A-153
11036xx0y	B-8	12216xxMy	B-20	1D036xx0y	B-12	2F-A6x-43	A-151
11048xD0y	B-2	12288xD0y	B-4	1D048xD0y	B-6	2F-A6x-44	A-153
11048xDMy	B-14	12288xDMy	B-16	1D048xx0y	B-12	2F-A7x-31	A-151
11048xN0y	B-38	12288xx0y	B-10	1D072xD0y	B-6	2F-A7x-32	A-153
11048xx0y	B-8	12288xxMy	B-20	1D072xx0y	B-12	2F-A7x-43	A-151
11048xxMy	B-18	12432xD0y	B-4	1D096xD0y	B-6	2F-A7x-44	A-153
11060KDKy	B-22	12432xx0y	B-10	1D096xx0y	B-12	2F-B1x-31	A-151
11060KDLy	B-22	13006xD0y	B-39	1D0y2xD0y	B-6	2F-B1x-32	A-153
11060xD0y	B-2	13006xx0y	B-40	1D144xD0y	B-6	2F-B1x-43	A-151
11060xx0y	B-8	13012xD0y	B-39	1D144xx0y	B-12	2F-B1x-44	A-153
11072KDKy	B-22	13012xx0y	B-40	1D216xD0y	B-6	2F-B2x-31	A-151
11072KDLy	B-22	13018xD0y	B-39	1D216xx0y	B-12	2F-B2x-32	A-153
11072xD0y	B-2	13024xD0y	B-39	1D288xx0y	B-12	2F-B2x-43	A-151
11072xDMy	B-14	13024xx0y	B-40	1G006xDMy	B-15	2F-B2x-44	A-153
11072xN0y	B-38	13036xD0y	B-39	1G006xx0y	B-9	2F-B3x-31	A-151
11072xx0y	B-8	13036xx0y	B-40	1G006xxMy	B-19	2F-B3x-32	A-153
11072xxMy	B-18	13048xD0y	B-39	1G012xD0y	B-3	2F-B3x-43	A-151
11096KDKy	B-22	13048xx0y	B-40	1G012xDMy	B-15	2F-B3x-44	A-153
11096KDLy	B-22	13072xD0y	B-39	1G012xx0y	B-9	2F-C1x-31	A-151
11096xD0y	B-2	13072xx0y	B-40	1G012xxMy	B-19	2F-C1x-32	A-153
11096xDMy	B-14	13096xD0y	B-39	1G024xD0y	B-3	2F-C1x-43	A-151
11096xN0y	B-38	13096xx0y	B-40	1G024xDMy	B-15	2F-C1x-44	A-153
11096xx0y	B-8	13144xD0y	B-39	1G024xx0y	B-9	2F-C2x-31	A-151
11096xxMy	B-18	13144xx0y	B-40	1G024xxMy	B-19	2F-C2x-32	A-153
11144KDKy	B-22	13216xD0y	B-39	1G036xD0y	B-3	2F-C2x-43	A-151
11144KDLy	B-22	13216xx0y	B-40	1G036xDMy	B-15	2F-C2x-44	A-153
11144xD0y	B-2	13288xD0y	B-39	1G036xx0y	B-9	2F-C3x-31	A-151

Part Number	Page	Part Number	Page	Part Number	Page	Part Number	Page
2F-C3x-32	A-153	2F-32x-94	A-147	51024xx0y	B-32	6T002x1RG	B-57
2F-C3x-43	A-151	2F-33x-91	A-145	51036xx0y	B-32	6T004x1BB	B-57
2F-C3x-44	A-153	2F-33x-92	A-147	51048xx0y	B-32	6T004x1RG	B-57
2F-C4x-31	A-151	2F-33x-93	A-145	51072xx0y	B-32	6T006x1BB	B-57
2F-C4x-32	A-153	2F-33x-94	A-147	51096xx0y	B-32	6T006x1RG	B-57
2F-C4x-43	A-151	2F-41x-91	A-145	52001xx0y	B-53	6T012x1BB	B-57
2F-C4x-44	A-153	2F-41x-92	A-147	52002xS0y	B-50	6T012x1RG	B-57
2F-C5x-31	A-151	2F-41x-93	A-145	52002xU0y	B-51	6T024x101	B-57
2F-C5x-32	A-153	2F-41x-94	A-147	52002xx0y	B-33	6T024x1BB	B-57
2F-C5x-43	A-151	2F-42x-91	A-145	52002xx0y	B-53	6T024x1RG	B-57
2F-C5x-44	A-153	2F-42x-94	A-147	52004xS0y	B-50	6T-246-xA	A-72
2F-C6x-32	A-153	2F-51x-31	A-151	52004xU0y	B-51	6T-246-xB	A-72
2F-C7x-31	A-151	2F-51x-32	A-153	52004xx0y	B-33	6T-272-xA	A-72
2F-C7x-32	A-153	2F-51x-43	A-151	52004xx0y	B-53	6T-272-xB	A-72
2F-C7x-43	A-151	2F-51x-44	A-153	52006xS0y	B-50	6U001x101	B-56
2F-C7x-44	A-153	2F-51x-91	A-145	52006xU0y	B-51	6U002x101	B-56
2F-D1x-31	A-151	2F-51x-92	A-147	52006xx0y	B-33	6U002x1BB	B-56
2F-D1x-32	A-153	2F-51x-93	A-145	52006xx0y	B-53	6U002x1RG	B-56
2F-D1x-43	A-151	2F-51x-94	A-147	52008xS0y	B-50	6U004x1BB	B-56
2F-D1x-44	A-153	2F-52x-31	A-151	52008xU0y	B-51	6U004x1RG	B-56
2F-D2x-31	A-151	2F-52x-32	A-153	52008xx0y	B-53	6U006x1BB	B-56
2F-D2x-32	A-153	2F-52x-43	A-151	52012xS0y	B-50	6U006x1RG	B-56
2F-D2x-43	A-151	2F-52x-44	A-153	52012xU0y	B-51	6U012x1RG	B-56
2F-D2x-44	A-153	2F-52x-91	A-145	52012xx0y	B-33	6U024x101	B-56
2F-D3x-31	A-151	2F-52x-92	A-147	52012xx0y	B-53	6U024x1BB	B-56
2F-D3x-32	A-153	2F-52x-93	A-145	52024xx0y	B-33	6U024x1RG	B-56
2F-D3x-43	A-151	2F-52x-94	A-147	52036xx0y	B-33	72002xx2S	B-55
2F-D3x-44	A-153	2F-53x-31	A-151	52048xx0y	B-33	72002xx2y	B-54
2F-E1x-31	A-151	2F-53x-43	A-151	52072xx0y	B-33	72002xx3S	B-55
2F-E1x-32	A-153	2F-53x-91	A-145	52096xx0y	B-33	72002xx3y	B-54
2F-E1x-43	A-151	2F-53x-92	A-147	53006xx0y	B-46	72002xx6S	B-55
2F-E1x-44	A-153	2F-53x-93	A-145	53012K01Q	D-6	72002xx6y	B-54
2F-E2x-31	A-151	2F-53x-94	A-147	53012xx0y	B-46	72004xx2S	B-55
2F-E2x-32	A-153	33001x101	A-3	53024K01Q	D-6	72004xx2y	B-54
2F-E2x-43	A-151	33001yG01	A-3	53024xx0y	B-46	72004xx3S	B-55
2F-E2x-44	A-153	33002x1zz	A-3	53036xx0y	B-46	72004xx3y	B-54
2F-E3x-31	A-151	33002yGzz	A-3	53048J01Q	D-6	72004xx6S	B-55
2F-E3x-32	A-153	33004x1zz	A-3	53048xx0y	B-46	72004xx6y	B-54
2F-E3x-43	A-151	33004yGzz	A-3	53072xx0y	B-46	72006xx2S	B-55
2F-E3x-44	A-153	34001x101	A-3	53096xx0y	B-46	72006xx2y	B-54
2F-F1x-31	A-151	34001yG01	A-3	57001x23Q	B-52	72006xx3S	B-55
2F-F1x-32	A-153	34002x1zz	A-3	57002x23Q	B-52	72006xx3y	B-54
2F-F1x-43	A-151	34002yGzz	A-3	57004x23Q	B-52	72006xx6S	B-55
2F-F1x-44	A-153	34004x1zz	A-3	57006x23Q	B-52	72006xx6y	B-54
2F-F2x-31	A-151	34004yGzz	A-3	57008x23Q	B-52	72012xx6S	B-55
2F-F2x-43	A-151	43006x1zz	A-23	57012x23Q	B-52	72012xx6y	B-54
2F-F2x-44	A-153	43006yGzz	A-23	5F-220-E1	A-106	7A-421-03	A-51
2F-11x-91	A-145	43008x1zz	A-23	5F-220-x1	A-108	7A-621-03	A-50
2F-11x-92	A-147	43008yGzz	A-23	5F-220-x5	A-88	A3001x101	A-3
2F-11x-93	A-145	43012x1zz	A-23	5F-220-x8	A-88	A3001yG01	A-3
2F-11x-94	A-147	43012yGzz	A-23	5V0063061	B-75	A4001x101	A-3
2F-12x-91	A-145	43018xK01*	A-23	5V0063121	B-75	A4001yG01	A-3
2F-12x-92	A-147	43018yK01	A-23	5V0123121	B-75	AA-SL	D-40
2F-12x-93	A-145	43024xK01*	A-23	5V0123251	B-75	AC-A1x-55	A-155
2F-12x-94	A-147	43024yK01	A-23	5V0183181	B-75	AC-A1x-68	A-155
2F-13x-91	A-145	43048xx101	A-25	5V0243251	B-75	AC-A2x-55	A-155
2F-13x-92	A-147	43060xx101	A-25	5W002301Q	B-73	AC-A2x-68	A-155
2F-13x-93	A-145	43072xx101	A-25	5W002302Q	B-73	AGDMDF02	D-37
2F-13x-94	A-147	43084xx101	A-25	5W002303Q	B-73	AG-NFNF	D-37
2F-14x-91	A-145	43096xx101	A-25	5W004301Q	B-73	ATDMDF700	D-36
2F-14x-92	A-147	43144xx101	A-25	6A-246-xB	A-58	AT-DMDF-W	D-36
2F-14x-93	A-145	44006x1zz	A-23	6A-272-xA	A-58	ATNMNF700	D-36
2F-14x-94	A-147	44006yGzz	A-23	6A-272-xB	A-58	AT-NMNF-W	D-36
2F-15x-93	A-145	44008x1zz	A-23	6B-246-xA	A-54	B3002x101	A-3
2F-21x-91	A-145	44008yGzz	A-23	6B-246-xB	A-54	B3002yG01	A-3
2F-21x-92	A-147	44012x1zz	A-23	6B-272-xA	A-54	B4002x101	A-3
2F-21x-93	A-145	44012yGzz	A-23	6B-272-xB	A-54	B4002yG01	A-3
2F-21x-94	A-147	44018xK01*	A-23	6F-246-xA	A-64	C3002x101	A-3
2F-22x-91	A-145	44018yK01	A-23	6F-246-xB	A-64	C3002yG01	A-3
2F-22x-92	A-147	44024xK01	A-23	6F-272-xA	A-64	C4002x101	A-3
2F-22x-93	A-145	44024yK01	A-23	6F-272-xB	A-64	C4002yG01	A-3
2F-22x-94	A-147	44048xx101	A-25	6F-273-xA	A-64	CHAP12NMR	D-27
2F-23x-91	A-145	44060xx101	A-25	6F-273-xB	A-64	CHFA12DMR	D-24
2F-23x-92	A-147	44072xx101	A-25	6H-246-xA	A-52	CHFA12NFR	D-27
2F-23x-93	A-145	44096xx101	A-25	6H-246-xB	A-52	CHFA12NMR	D-27
2F-23x-94	A-147	44144xx101	A-25	6H-272-xA	A-52	CHFAP12DF	D-24
2F-31x-91	A-145	51002xx0y	B-49	6H-272-xB	A-52	CHFAP12DM	D-24
2F-31x-92	A-147	51004xx0y	B-49	6S-220-xA	A-60	CHFAP12DMR	D-24
2F-31x-93	A-145	51006xx0y	B-32	6S-220-xB	A-60	CHFAP12NF	D-27
2F-31x-94	A-147	51006xx0y	B-49	6S-220-xP	A-62	CHFAP12NFR	D-27
2F-32x-91	A-145	51008xx0y	B-49	6T001x101	B-57	CHFAP12NM	D-27
2F-32x-92	A-147	51012xx0y	B-32	6T002x101	B-57	CHFA-12DF	D-24
2F-32x-93	A-145	51012xx0y	B-49	6T002x1BB	B-57	CHFA-12DM	D-24

Part Number Index

Part Number	Page	Part Number	Page	Part Number	Page	Part Number	Page
CHFA-12NF	D-27	D3-B169SA	A-48	F349-032Uxx-t991	A-13	F4C5-012Uxx-6991-CEC	A-43
CHFA-12NM	D-27	D3-D009SA	A-48	F349-048Uxx-t991	A-13	FE21-012U10-E991	B-23
CHFS12DFR	D-9	D3-E169SA	A-48	F349-064Uxx-t991	A-13	FE21-024U10-E991	B-23
CHFS12DMR	D-9	D3-J009SA	A-48	F349-096Uxx-t991	A-13	FE21-036U10-E991	B-24
CHFS12DMR	D-23	D3-K169SA	A-48	F356-012Uxx-y991	A-29	FE21-072U10-E991	B-24
CHFS12NFR	D-11	D3-M009SA	A-48	F356-024Uxx-y991	A-29	FE21-096U10-E991	B-24
CHFS12NFR	D-26	D3-N169SA	A-48	F356-048Uxx-y991	A-29	FE21-144U10-E991	B-25
CHFS12NMR	D-11	D3-S009SA	A-48	F356-060Uxx-y991	A-29	FE21-288U10-E991	B-25
CHFS12NMR	D-26	D3-T169SA	A-48	F356-072Uxx-y991	A-29	FE22-012U10-E991	B-23
CHFS12DF	D-23	D3-V009SA	A-48	F356-084Uxx-y991	A-29	FE22-024U10-E991	B-23
CHFS12DM	D-23	D3-2009SA	A-48	F356-096Uxx-y991	A-29	FE22-036U10-E991	B-24
CHFS12DMR	D-23	D3-5009SA	A-48	F356-144Uxx-y991	A-29	FE22-072U10-E991	B-24
CHFS12NF	D-26	D5001L5yy	A-31	F356-216Uxx-y991	A-29	FE22-096U10-E991	B-24
CHFS12NFR	D-26	F1006xx0y	B-34	F356-288Uxx-y991	A-29	FE22-144U10-E991	B-25
CHFS12NMR	D-26	F1012xx0y	B-34	F360-002Uxx-Eyy1	A-17	FE22-288U10-E991	B-25
CHFS12NMR	D-26	F1024xx0y	B-34	F360-004Uxx-Eyy1	A-17	FE23-012U10-E991	B-23
CHFS-12DF	D-9	F1036xx0y	B-34	F360-006Uxx-Eyy1	A-17	FE23-024U10-E991	B-23
CHFS-12DF	D-23	F1048xx0y	B-34	F360-008Uxx-Eyy1	A-17	FE23-024U10-E991	B-24
CHFS-12DM	D-9	F1072xx0y	B-34	F360-012Uxx-Eyy1	A-17	FE23-072U10-E991	B-24
CHFS-12DM	D-23	F108-002Uyy-E991	A-37	F3C3-002Uxx-y991-CE9	A-41	FE23-096U10-E991	B-24
CHFS-12NF	D-11	F108-004Uyy-E991	A-37	F3C4-002Uxx-E991-CE9	A-45	FE23-144U10-E991	B-25
CHFS-12NF	D-26	F108-006Uyy-E991	A-37	F3C4-002Uxx-E991-CED	A-45	FE23-288U10-E991	B-25
CHFS-12NM	D-11	F108-008Uyy-E991	A-37	F403-006Uxx-y991-zzz	A-39	FE24-012U10-E991	B-23
CHFS-12NM	D-26	F108-012Uyy-E991	A-37	F403-008Uxx-y991-zzz	A-39	FE24-024U10-E991	B-23
CHFS-6DF	D-9	F108-024Uyy-E991	A-37	F403-012Uxx-y991-zzz	A-39	FE24-036U10-E991	B-24
CHFS-6DM	D-9	F1096xx0y	B-34	F403-024Uxx-y991-zzz	A-39	FE24-072U10-E991	B-24
CHFS-6DMR	D-9	F160-002Uxx-E991	A-19	F404-048Uxx-y991-zzz	A-39	FE24-096U10-E991	B-24
CHFS-6NF	D-11	F160-004Uxx-E991	A-19	F404-072Uxx-y991-zzz	A-39	FE24-144U10-E991	B-25
CHFS-6NM	D-11	F160-006Uxx-E991	A-19	F404-096Uxx-y991-zzz	A-39	FE24-288U10-E991	B-25
CHFS-6NMR	D-11	F160-008Uxx-E991	A-19	F404-144Uxx-y991-zzz	A-39	FE25-012U10-E991	B-23
CLHP12DMR	D-22	F160-012Uxx-E991	A-19	F408-006Uxx-y991-zzz	A-39	FE25-024U10-E991	B-23
CLHP12NFR	D-25	F1C3-002Uxx-y991-CE9	A-41	F408-008Uxx-y991-zzz	A-39	FE25-036U10-E991	B-24
CLHP12NMR	D-25	F1C4-002Uxx-E991-CE9	A-45	F408-012Uxx-y991-zzz	A-39	FE25-072U10-E991	B-24
CLHP12NMR	D-25	F1C4-002Uxx-E991-CED	A-45	F408-024Uxx-y991-zzz	A-39	FE25-096U10-E991	B-24
CLHP-12DF	D-22	F2006xxSy	B-35	F409-024Uxx-y991-zzz	A-39	FE25-144U10-E991	B-25
CLHP-12DM	D-22	F2012xxSy	B-35	F409-024Uzz-E991	A-35	FE25-288U10-E991	B-25
CLHP-12NF	D-25	F2024xxSy	B-35	F409-024Uzz-E991	A-35	FE26-012U10-E991	B-23
CLH-12DF	D-8	F2036xxSy	B-35	F409-036Uxx-y991-zzz	A-39	FE26-024U10-E991	B-23
CLH-12DF	D-22	F2048xxSy	B-35	F409-036Uzz-E991	A-35	FE26-036U10-E991	B-24
CLH-12DFR	D-8	F2072xxSy	B-35	F409-036Uzz-E991	A-35	FE26-072U10-E991	B-24
CLH-12DM	D-8	F2096xxSy	B-35	F409-048Uxx-y991-zzz	A-39	FE26-096U10-E991	B-24
CLH-12DM	D-22	F209-024Uyy-E991	A-37	F409-048Uzz-E991	A-35	FE26-144U10-E991	B-25
CLH-12DMR	D-8	F209-036Uyy-E991	A-37	F409-048Uzz-E991	A-35	FE26-288U10-E991	B-25
CLH-12DMR	D-22	F209-048Uyy-E991	A-37	F409-072Uxx-y991-zzz	A-39	FE27-012U10-E991	B-23
CLH-12NF	D-10	F209-072Uyy-E991	A-37	F409-072Uzz-E991	A-35	FE27-024U10-E991	B-23
CLH-12NF	D-25	F260-002Uxx-E991	A-19	F409-072Uzz-E991	A-35	FE27-036U10-E991	B-24
CLH-12NFR	D-10	F260-004Uxx-E991	A-19	F409-096Uxx-y991-zzz	A-39	FE27-072U10-E991	B-24
CLH-12NFR	D-25	F260-006Uxx-E991	A-19	F409-096Uzz-E991	A-35	FE27-096U10-E991	B-24
CLH-12NM	D-10	F260-008Uxx-E991	A-19	F409-096Uzz-E991	A-35	FE27-144U10-E991	B-25
CLH-12NM	D-25	F260-012Uxx-E991	A-19	F410-024Uxx-y991-zzz	A-39	FE27-288U10-E991	B-25
CLH-12NMR	D-10	F262-024Uxx-E991	A-19	F410-036Uxx-y991-zzz	A-39	FE28-012U10-E991	B-23
CLH-12NMR	D-25	F262-036Uxx-E991	A-19	F410-036Uyy-z991	A-25	FE28-024U10-E991	B-23
CLH-22DF	D-8	F262-048Uxx-E991	A-19	F447-024Uxx-t991	A-9	FE28-036U10-E991	B-24
CLH-22DM	D-8	F2C2-012U13-6991-CE5	D-13	F447-032Uxx-t991	A-9	FE28-072U10-E991	B-24
CLH-22NF	D-10	F2C3-002U15-6991-CE9	A-41	F447-048Uxx-t991	A-9	FE28-096U10-E991	B-24
CLH-22NM	D-10	F303-006Uxx-y991-zzz	A-39	F447-064Uxx-t991	A-9	FE28-144U10-E991	B-25
CLH-33DF	D-8	F303-008Uxx-y991-zzz	A-39	F447-096Uxx-t991	A-9	FE28-288U10-E991	B-25
CLH-33DM	D-8	F303-012Uxx-y991-zzz	A-39	F449-024Uxx-t991	A-13	FE29-012U10-E991	B-23
CLH-33NF	D-10	F303-024Uxx-y991-zzz	A-39	F449-032Uxx-t991	A-13	FE29-024U10-E991	B-23
CLH-33NMR	D-10	F304-048Uxx-y991-zzz	A-39	F449-048Uxx-t991	A-13	FE29-036U10-E991	B-24
CLH-42DF	D-8	F304-072Uxx-y991-zzz	A-39	F449-064Uxx-t991	A-13	FE29-072U10-E991	B-24
CLH-42DM	D-8	F304-096Uxx-y991-zzz	A-39	F449-096Uxx-t991	A-13	FE29-096U10-E991	B-24
CLH-42NF	D-10	F304-144Uxx-y991-zzz	A-39	F456-012Uxx-y991	A-29	FE29-144U10-E991	B-25
CLH-42NM	D-10	F308-002Uxx-Eyy1	A-33	F456-024Uxx-y991	A-29	FE29-288U10-E991	B-25
D1-A009S5	A-49	F308-004Uxx-Eyy1	A-33	F456-048Uxx-y991	A-29	FE2A-012U10-E991	B-23
D1-B169S5	A-49	F308-006Uxx-Eyy1	A-33	F456-060Uxx-y991	A-29	FE2A-024U10-E991	B-24
D1-D009S5	A-49	F308-006Uxx-y991-zzz	A-39	F456-072Uxx-y991	A-29	FE2A-036U10-E991	B-24
D1-E169S5	A-49	F308-008Uxx-Eyy1	A-33	F456-084Uxx-y991	A-29	FE2A-072U10-E991	B-24
D1-J009S5	A-49	F308-008Uxx-y991-zzz	A-39	F456-096Uxx-y991	A-29	FE2A-096U10-E991	B-24
D1-K169S5	A-49	F308-012Uxx-Eyy1	A-33	F456-144Uxx-y991	A-29	FE2A-144U10-E991	B-25
D1-M009S5	A-49	F308-012Uxx-y991-zzz	A-39	F456-216Uxx-y991	A-29	FE2A-288U10-E991	B-25
D1-N169S5	A-49	F308-024Uxx-E991	A-33	F456-288Uxx-y991	A-29	FE2B-012U10-E991	B-23
D1-S009S5	A-49	F308-024Uxx-y991-zzz	A-39	F457-048Uyy-z991	A-5	FE2B-024U10-E991	B-24
D1-T169S5	A-49	F309-024Uxx-y991-zzz	A-39	F460-002Uxx-Eyy1	A-17	FE2B-036U10-E991	B-24
D1-V009S5	A-49	F309-036Uxx-y991-zzz	A-39	F460-004Uxx-Eyy1	A-17	FE2B-072U10-E991	B-24
D1-W169S5	A-49	F309-048Uxx-y991-zzz	A-39	F460-006Uxx-Eyy1	A-17	FE2B-096U10-E991	B-24
D1-2009S5	A-49	F309-072Uxx-y991-zzz	A-39	F460-008Uxx-Eyy1	A-17	FE2B-144U10-E991	B-25
D1-3169S5	A-49	F309-096Uxx-y991-zzz	A-39	F460-012Uxx-Eyy1	A-17	FE2B-288U10-E991	B-25
D1-5009S5	A-49	F309-144Uxx-y991-zzz	A-39	F462-024Uxx-Eyy1	A-17	FE2C-012U10-E991	B-23
D1-6169S5	A-49	F310-024Uxx-y991-zzz	A-39	F462-036Uxx-Eyy1	A-17	FE2C-024U10-E991	B-24
D3001L3yy	A-30	F310-036Uxx-y991-zzz	A-39	F462-048Uxx-Eyy1	A-17	FE2C-036U10-E991	B-24
D3001L5yy	A-30	F310-036Uyy-z991	A-25	F4C2-012U13-6991-CE5	D-12	FE2C-072U10-E991	B-24
D3-A009SA	A-48	F349-024Uxx-t991	A-13	F4C3-002U15-6991-CE9	A-41	FE2C-096U10-E991	B-24

Part Number	Page	Part Number	Page	Part Number	Page	Part Number	Page
FE2C-144U10-E991	B-25	FE38-096U10-E991	B-27	FE44-072U10-E991	B-29	FE4G-072U10-E991	B-30
FE2C-288U10-E991	B-25	FE38-144U10-E991	B-27	FE44-096U10-E991	B-30	FE4G-096U10-E991	B-30
FE2D-012U10-E991	B-23	FE38-288U10-E991	B-27	FE44-144U10-E991	B-30	FE4G-144U10-E991	B-30
FE2D-024U10-E991	B-24	FE39-012U10-E991	B-26	FE44-288U10-E991	B-30	FF1C-001U13-EA71	B-60
FE2D-036U10-E991	B-24	FE39-024U10-E991	B-26	FE45-012U10-E991	B-29	FF1C-001U13-EBN1	B-60
FE2D-072U10-E991	B-24	FE39-036U10-E991	B-26	FE45-024U10-E991	B-29	FF1C-001U13-EC11	B-60
FE2D-096U10-E991	B-24	FE39-072U10-E991	B-27	FE45-036U10-E991	B-29	FF1C-001U13-EC51	B-60
FE2D-144U10-E991	B-25	FE39-096U10-E991	B-27	FE45-072U10-E991	B-29	FF1C-001U13-EC91	B-60
FE2D-288U10-E991	B-25	FE39-144U10-E991	B-27	FE45-096U10-E991	B-30	FF1C-001U13-ECD1	B-60
FE2E-012U10-E991	B-23	FE39-288U10-E991	B-27	FE45-144U10-E991	B-30	FF1C-001U13-ECH1	B-60
FE2E-024U10-E991	B-24	FE3A-012U10-E991	B-26	FE45-288U10-E991	B-30	FF2T-001U15-E991	B-61
FE2E-036U10-E991	B-24	FE3A-024U10-E991	B-26	FE46-012U10-E991	B-29	FF2T-002U15-E991	B-61
FE2E-072U10-E991	B-24	FE3A-036U10-E991	B-26	FE46-024U10-E991	B-29	FG21-192U10-E991-COF	B-71
FE2E-096U10-E991	B-24	FE3A-072U10-E991	B-27	FE46-036U10-E991	B-29	FG30-006U23-E991-CEB	A-47
FE2E-144U10-E991	B-25	FE3A-096U10-E991	B-27	FE46-072U10-E991	B-29	FG31-006U23-E991-CEB	A-47
FE2E-288U10-E991	B-25	FE3A-144U10-E991	B-27	FE46-096U10-E991	B-30	FG41-012C10-E991-CEC	B-78
FE2F-012U10-E991	B-23	FE3A-288U10-E991	B-27	FE46-144U10-E991	B-30	FH10-006xxx-E99y	B-44
FE2F-024U10-E991	B-24	FE3B-012U10-E991	B-26	FE46-288U10-E991	B-30	FH10-012xxx-E99y	B-44
FE2F-036U10-E991	B-24	FE3B-024U10-E991	B-26	FE47-012U10-E991	B-29	FH10-024xxx-E99y	B-44
FE2F-072U10-E991	B-24	FE3B-036U10-E991	B-26	FE47-024U10-E991	B-29	FH10-036xxx-E99y	B-44
FE2F-096U10-E991	B-24	FE3B-072U10-E991	B-27	FE47-036U10-E991	B-29	FH10-048xxx-E99y	B-44
FE2F-144U10-E991	B-25	FE3B-096U10-E991	B-27	FE47-072U10-E991	B-30	FH10-060xxx-E99y	B-44
FE2F-288U10-E991	B-25	FE3B-144U10-E991	B-27	FE47-096U10-E991	B-30	FH10-072xxx-E99y	B-44
FE2G-012U10-E991	B-23	FE3B-288U10-E991	B-27	FE47-144U10-E991	B-30	FH10-096xxx-E99y	B-44
FE2G-024U10-E991	B-24	FE3C-012U10-E991	B-26	FE47-288U10-E991	B-30	FH10-144xxx-E99y	B-44
FE2G-036U10-E991	B-24	FE3C-024U10-E991	B-26	FE48-012U10-E991	B-29	FH10-216xxx-E99y	B-44
FE2G-072U10-E991	B-24	FE3C-036U10-E991	B-26	FE48-024U10-E991	B-29	FH10-288xxx-E99y	B-44
FE2G-096U10-E991	B-24	FE3C-072U10-E991	B-27	FE48-036U10-E991	B-29	FH16-006xxx-E99y	B-42
FE2G-144U10-E991	B-25	FE3C-096U10-E991	B-27	FE48-072U10-E991	B-30	FH16-012xxx-E99y	B-42
FE2G-288U10-E991	B-25	FE3C-144U10-E991	B-27	FE48-096U10-E991	B-30	FH16-024xxx-E99y	B-42
FE31-012U10-E991	B-26	FE3C-288U10-E991	B-27	FE48-144U10-E991	B-30	FH16-036xxx-E99y	B-42
FE31-024U10-E991	B-26	FE3D-012U10-E991	B-26	FE48-288U10-E991	B-30	FH16-048xxx-E99y	B-42
FE31-036U10-E991	B-26	FE3D-024U10-E991	B-26	FE49-012U10-E991	B-29	FH16-060xxx-E99y	B-42
FE31-072U10-E991	B-26	FE3D-036U10-E991	B-26	FE49-024U10-E991	B-29	FH16-072xxx-E99y	B-42
FE31-096U10-E991	B-27	FE3D-072U10-E991	B-27	FE49-036U10-E991	B-29	FH16-096xxx-E99y	B-42
FE31-144U10-E991	B-27	FE3D-096U10-E991	B-27	FE49-072U10-E991	B-30	FH16-144xxx-E99y	B-42
FE31-288U10-E991	B-27	FE3D-144U10-E991	B-27	FE49-096U10-E991	B-30	FH16-216xxx-E99y	B-42
FE32-012U10-E991	B-26	FE3D-288U10-E991	B-28	FE49-144U10-E991	B-30	FH16-288xxx-E99y	B-42
FE32-024U10-E991	B-26	FE3E-012U10-E991	B-26	FE49-288U10-E991	B-30	FH25-006xxx-E99y	B-43
FE32-036U10-E991	B-26	FE3E-024U10-E991	B-26	FE4A-012U10-E991	B-29	FH25-012xxx-E99y	B-43
FE32-072U10-E991	B-26	FE3E-036U10-E991	B-26	FE4A-024U10-E991	B-29	FH25-024xxx-E99y	B-43
FE32-096U10-E991	B-27	FE3E-072U10-E991	B-27	FE4A-036U10-E991	B-29	FH25-036xxx-E99y	B-43
FE32-144U10-E991	B-27	FE3E-096U10-E991	B-27	FE4A-072U10-E991	B-30	FH25-048xxx-E99y	B-43
FE32-288U10-E991	B-27	FE3E-144U10-E991	B-27	FE4A-096U10-E991	B-30	FH25-060xxx-E99y	B-43
FE33-012U10-E991	B-26	FE3E-288U10-E991	B-28	FE4A-144U10-E991	B-30	FH25-072xxx-E99y	B-43
FE33-024U10-E991	B-26	FE3F-012U10-E991	B-26	FE4A-288U10-E991	B-30	FH25-096xxx-E99y	B-43
FE33-036U10-E991	B-26	FE3F-024U10-E991	B-26	FE4B-012U10-E991	B-29	FH25-144xxx-E99y	B-43
FE33-072U10-E991	B-26	FE3F-036U10-E991	B-26	FE4B-024U10-E991	B-29	FH25-216xxx-E99y	B-43
FE33-096U10-E991	B-27	FE3F-072U10-E991	B-27	FE4B-036U10-E991	B-29	FH25-288xxx-E99y	B-43
FE33-144U10-E991	B-27	FE3F-096U10-E991	B-27	FE4B-072U10-E991	B-30	FH26-006xxx-E99y	B-45
FE33-288U10-E991	B-27	FE3F-144U10-E991	B-27	FE4B-096U10-E991	B-30	FH26-012xxx-E99y	B-45
FE34-012U10-E991	B-26	FE3F-288U10-E991	B-28	FE4B-144U10-E991	B-30	FH26-024xxx-E99y	B-45
FE34-024U10-E991	B-26	FE3G-012U10-E991	B-26	FE4B-288U10-E991	B-30	FH26-036xxx-E99y	B-45
FE34-036U10-E991	B-26	FE3G-024U10-E991	B-26	FE4C-012U10-E991	B-29	FH26-048xxx-E99y	B-45
FE34-072U10-E991	B-26	FE3G-036U10-E991	B-26	FE4C-024U10-E991	B-29	FH26-060xxx-E99y	B-45
FE34-096U10-E991	B-27	FE3G-072U10-E991	B-27	FE4C-036U10-E991	B-29	FH26-072xxx-E99y	B-45
FE34-144U10-E991	B-27	FE3G-096U10-E991	B-27	FE4C-072U10-E991	B-30	FH26-096xxx-E99y	B-45
FE34-288U10-E991	B-27	FE3G-144U10-E991	B-27	FE4C-096U10-E991	B-30	FH26-144xxx-E99y	B-45
FE35-012U10-E991	B-26	FE3G-288U10-E991	B-28	FE4C-144U10-E991	B-30	FH26-216xxx-E99y	B-45
FE35-024U10-E991	B-26	FE41-012U10-E991	B-29	FE4C-288U10-E991	B-30	FH26-288xxx-E99y	B-45
FE35-036U10-E991	B-26	FE41-024U10-E991	B-29	FE4D-012U10-E991	B-29	FHG1-012-U13-E991	D-6
FE35-072U10-E991	B-26	FE41-036U10-E991	B-29	FE4D-024U10-E991	B-29	FHG2-012-U13-E991	D-6
FE35-096U10-E991	B-27	FE41-072U10-E991	B-29	FE4D-036U10-E991	B-29	FHG3-012-U13-E991	D-6
FE35-144U10-E991	B-27	FE41-096U10-E991	B-30	FE4D-072U10-E991	B-30	FJ12-024U10-E991	B-69
FE35-288U10-E991	B-27	FE41-144U10-E991	B-30	FE4D-096U10-E991	B-30	FJ12-036U10-E991	B-69
FE36-012U10-E991	B-26	FE41-288U10-E991	B-30	FE4D-144U10-E991	B-30	FJ12-048U10-E991	B-69
FE36-024U10-E991	B-26	FE42-012U10-E991	B-29	FE4D-288U10-E991	B-31	FJ12-072U10-E991	B-69
FE36-036U10-E991	B-26	FE42-024U10-E991	B-29	FE4E-012U10-E991	B-29	FJ12-096U10-E991	B-69
FE36-072U10-E991	B-26	FE42-036U10-E991	B-29	FE4E-024U10-E991	B-29	FJ12-144U10-E991	B-69
FE36-096U10-E991	B-27	FE42-072U10-E991	B-29	FE4E-036U10-E991	B-29	FJ12-216U10-E991	B-69
FE36-144U10-E991	B-27	FE42-096U10-E991	B-30	FE4E-072U10-E991	B-30	FJ12-288U10-E991	B-69
FE36-288U10-E991	B-27	FE42-144U10-E991	B-30	FE4E-096U10-E991	B-30	FM006x1Sy	B-36
FE37-012U10-E991	B-26	FE42-288U10-E991	B-30	FE4E-144U10-E991	B-30	FM012x1Sy	B-36
FE37-024U10-E991	B-26	FE43-012U10-E991	B-29	FE4E-288U10-E991	B-31	FM024x1Sy	B-36
FE37-036U10-E991	B-26	FE43-024U10-E991	B-29	FE4F-012U10-E991	B-29	FM036x1Sy	B-36
FE37-072U10-E991	B-27	FE43-036U10-E991	B-29	FE4F-024U10-E991	B-29	FM048x1Sy	B-36
FE37-096U10-E991	B-27	FE43-072U10-E991	B-29	FE4F-036U10-E991	B-29	FM072x1Sy	B-36
FE37-144U10-E991	B-27	FE43-096U10-E991	B-30	FE4F-072U10-E991	B-30	FM096x1Sy	B-36
FE37-288U10-E991	B-27	FE43-144U10-E991	B-30	FE4F-096U10-E991	B-30	GB0424TU	D-41
FE38-012U10-E991	B-26	FE43-288U10-E991	B-30	FE4F-144U10-E991	B-30	GM012K011	D-6
FE38-024U10-E991	B-26	FE44-012U10-E991	B-29	FE4G-012U10-E991	B-29	GM012K111	D-6
FE38-036U10-E991	B-26	FE44-024U10-E991	B-29	FE4G-024U10-E991	B-29	GM012K221	D-6
FE38-072U10-E991	B-27	FE44-036U10-E991	B-29	FE4G-036U10-E991	B-29	HFAC-12DP	D-19

## Part Number Index

Part Number	Page	Part Number	Page	Part Number	Page	Part Number	Page
HFAC-12DR	D-18	K4-199-xA	A-113	LBA-57-1A	D-29	R1096x10y	B-67
HFSC-12D	D-5	K4-299-yA	A-113	LBHS12NH	D-35	R1096xD0y	B-62
HFSC-12DP	D-17	K8-A99-33	A-113	LBHS22NH	D-35	R1144x10y	B-67
HFSC-12DR	D-16	KC-919-x5	A-113	LBHS33NH	D-35	R1144xD0y	B-62
HFSC-6DFR	D-5	L2-199-x5	A-113	LBHS42NH	D-35	R1216x10y	B-67
J12-1DMDM	D-7	L2-299-y5	A-113	L-CT-12D	D-28	R1216xD0y	B-62
J12-1NMNM	D-7	L3002x301	A-27	L-CT-12DS	D-28	R1288x10y	B-67
J12-2DMDM	D-7	L3004x301	A-27	L-CT-22D	D-28	R1288xD0y	B-62
J12-2NMNM	D-7	L3006x10y	B-41	L-FT-42D	D-28	R1360xD0y	B-62
J12-3DMDM	D-7	L3006x401	A-27	L-GK-C12	D-32	R1432x10y	B-67
J12-3NMNM	D-7	L3008x401	A-27	L-GK-C22	D-32	R1432xD0y	B-62
J12-3NMNMR	D-7	L3012x10y	B-41	L-GK-C33	D-32	R1576x10y	B-67
J12-4DMDM	D-7	L3012x401	A-27	L-GK-C42	D-32	R1576xD0y	B-62
J12-4NMNM	D-7	L3018xK1Q	A-27	LHF-12D	D-2	R1864xD0y	B-62
J12-5DMDF	D-7	L3024x10y	B-41	LHF-12DP	D-15	R2012x1S5y	B-68
J12-5DMDM	D-7	L3024x401	A-27	LHF-12DR	D-14	R2012xD5y	B-63
J12-5NMNM	D-7	L3024xK1Q	A-27	LHF-22DU	D-4	R2024x1S5y	B-68
J12-6NMNMR	D-7	L3024xPB1	A-15	LHF-33D	D-2	R2024xD5y	B-63
JP121NFNF	D-21	L3024xW01	A-37	LHF-42DUF	D-4	R2036x1S5y	B-68
JP121NFRF	D-21	L3036x401	A-27	L-HG-12	D-31	R2048x1S5y	B-68
JP121NMNF	D-21	L3036xPB1	A-15	L-HG-22	D-31	R2048xD5y	B-63
JP121NMNM	D-21	L3036xW01	A-37	L-HG-33	D-31	R2072x1S5y	B-68
JP121NMRF	D-21	L3048x10y	B-41	L-HG-42	D-31	R2072xD5y	B-63
JP121NMRM	D-21	L3048x401	A-27	L-HG-12L	D-31	R2096x1S5y	B-68
JP122NFNF	D-21	L3048xP01	A-15	L-HG-22L	D-31	R2096xD5y	B-63
JP122NFRF	D-21	L3048xW01	A-37	L-HG-33L	D-31	R2144x1S5y	B-68
JP122NMNF	D-21	L3072x10y	B-41	L-HG-42L	D-31	R2144xD5y	B-63
JP122NMNM	D-21	L3072x401	A-27	L-SA-38	D-40	R2192x1S5y	B-68
JP122NMRF	D-21	L3072xP01	A-15	L-SH-S12	D-34	R2192xD5y	B-63
JP122NMRM	D-21	L3072xW01	A-37	L-SH-S22	D-34	R2216x1S5y	B-68
JP123NFNF	D-21	L3096x10y	B-41	L-SH-S33	D-34	R2216xD5y	B-63
JP123NFRF	D-21	L3096x401	A-27	L-SH-S42	D-34	R2288x1S5y	B-68
JP123NMNF	D-21	L3096xP01	A-15	L-SH-U12	D-33	R2288xD5y	B-63
JP123NMNM	D-21	L3096xW01	A-37	L-SH-U22	D-33	R2360x1S5y	B-68
JP123NMRF	D-21	L3144x10y	B-41	L-SH-U33	D-33	R2360xD5y	B-63
JP123NMRM	D-21	L3144x401	A-27	L-SH-U42	D-33	R2432x1S5y	B-68
JR121NFNF	D-20	L3144xP01	A-15	L-WK-U	D-30	R2432xD5y	B-63
JR121NFRF	D-20	L3144xW01	A-37	MR0723011	B-70	R2576x1S5y	B-68
JR121NMNF	D-20	L4002x301	A-27	P3002xx01	A-7	R2576xD5y	B-63
JR121NMNM	D-20	L4002xW01	A-37	P3004xx01	A-7	R2864xD5y	B-63
JR121NMRF	D-20	L4004x301	A-27	P3006xx01	A-7	RM060x1S5y	B-37
JR121NMRM	D-20	L4004xW01	A-37	P3008xx01	A-7	RM072x1S5y	B-37
JR122NFNF	D-20	L4006x401	A-27	P3012xx01	A-7	RM096x1S5y	B-37
JR122NFRF	D-20	L4006xW01	A-37	P3024xxA1	A-7	RM144x1S5y	B-37
JR122NMNF	D-20	L4008x401	A-27	P3024zzB1	A-13	RM192x1S5y	B-37
JR122NMNM	D-20	L4008xW01	A-37	P3036zzB1	A-13	RM216x1S5y	B-37
JR122NMRF	D-20	L4012x401	A-27	P3048zz01	A-13	RM-A100	D-38
JR122NMRM	D-20	L4012xW01	A-37	P3072zz01	A-13	RM-A300	D-38
JR123NFNF	D-20	L4018xK1Q	A-27	P3096zz01	A-13	S12883101	B-64
JR123NFRF	D-20	L4024x401	A-27	P3144zz01	A-13	S14323101	B-64
JR123NMNF	D-20	L4024xK1Q	A-27	P4002xx01	A-7	S15763101	B-64
JR123NMNM	D-20	L4024xKWQ	A-37	P4004xx01	A-7	S17203101	B-64
JR123NMRF	D-20	L4024xPB1	A-15	P4006xx01	A-7	S18643101	B-64
JR123NMRM	D-20	L4024xVB1	A-10	P4008xx01	A-7	S2360x10y	B-66
K2F-119-91	A-149	L4036x401	A-27	P4012xx01	A-7	S2432x10y	B-66
K2F-119-92	A-149	L4036xPB1	A-15	P4024xxA1	A-7	S2576x10y	B-66
K2F-129-91	A-149	L4036xVB1	A-10	P4024xxC1	A-5	S2720x10y	B-66
K2F-129-92	A-149	L4048x401	A-27	P4024zzB1	A-13	S2864x10y	B-66
K2F-139-91	A-149	L4048xP01	A-15	P4036zzB1	A-13	SA0A8x10y	B-66
K2F-139-92	A-149	L4048xV01	A-10	P4048zz01	A-13	SA-SS200	D-39
K2F-219-91	A-149	L4072x401	A-27	P4072zz01	A-13	SA-SS300	D-39
K2F-219-92	A-149	L4072xP01	A-15	P4096zz01	A-13	SSHAK3812*	D-34
K2F-229-91	A-149	L4072xV01	A-10	P4144zz01	A-13	T3006x201	A-20
K2F-229-92	A-149	L4096x401	A-27	P7-L21-yA	A-84	T3012x201	A-20
K2F-239-91	A-149	L4096xP01	A-15	P7-L21-yG	A-85	T3024x201	A-20
K2F-239-92	A-149	L4096xV01	A-10	P7-L33-yA	A-84	TBK-HFSC12	D-28
K2F-319-91	A-149	L4144x401	A-27	P7-L33-yG	A-85	TBK-LHFA12	D-28
K2F-319-92	A-149	L4144xP01	A-15	P7-L72-yA	A-84	TF-HFSC12	D-28
K2F-329-91	A-149	L4144xV01	A-10	P7-L72-yG	A-85	TF-LHFA12	D-28
K2F-329-92	A-149	L4-001-68	A-116	PW52-H46-E1	A-93	T-HFAC12DR	D-28
K2F-339-91	A-149	L4-199-xA	A-113	PW52-H46-x1	A-95	T-HFSC12DP	D-28
K2F-339-92	A-149	L4-299-yA	A-113	PW52-H46-x5	A-91	T-HFSC12DR	D-28
K2F-419-91	A-149	LBA-12-1A	D-29	PW52-H46-x8	A-91	T-LHF12DR	D-28
K2F-419-92	A-149	LBA-12-2A	D-29	PW52-H72-x5	A-91	T-LHFA12DP	D-28
K2F-429-91	A-149	LBA-12-3A	D-29	PW52-H72-x8	A-91	V4002xx01	A-7
K2F-519-91	A-149	LBA-12-4A	D-29	PW6H-H72-xB	A-56	V4004xx01	A-7
K2F-519-92	A-149	LBA-12-5A	D-29	R1012x10y	B-67	V4006xx01	A-7
K2F-529-91	A-149	LBA-22-1A	D-29	R1012xD0y	B-62	V4008xx01	A-7
K2F-529-92	A-149	LBA-22-2A	D-29	R1024xD0y	B-62	V4012xx01	A-7
K2F-539-91	A-149	LBA-22-3A	D-29	R1048x10y	B-67	V4024zzB1	A-9
K2F-539-92	A-149	LBA-22-4A	D-29	R1048xD0y	B-62	V4036zzB1	A-9
K2-199-x5	A-113	LBA-33-1A	D-29	R1072x10y	B-67	V4048zz01	A-9
K2-299-y5	A-113	LBA-42-1A	D-29	R1072xD0y	B-62	V4072zz01	A-9

Part Number	Page
V4096zz01	A-9
V4144zz01	A-9
W3024zz01	A-33
W3036zz01	A-33
W3048zz01	A-33
W3072zz01	A-33
W3084zz01	A-33
W3096zz01	A-33
W3144zz01	A-33
W4002x1yy	A-35
W4002xGyy	A-35
W4004x1yy	A-35
W4004xGyy	A-35
W4006x1yy	A-35
W4006xGyy	A-35
W4008x1yy	A-35
W4008xGyy	A-35
W4012x1yy	A-35
W4012xGyy	A-35
W4024xK01	A-35
W4024xK01	A-35
W7001x10y	B-59
W7001xU0y	B-58
W7002x10y	B-59
W7002xU0y	B-58
WATS-38	D-43
WPS12158D	D-42
WPSANT12D	D-42









## COMMUNICATIONS

5770 Powers Ferry Road NW, Suite 300  
Atlanta, Georgia 30327

P 770.657.6000  
T 800.551.8948  
F 877.291.7919

[www.SuperiorEssexCommunications.com](http://www.SuperiorEssexCommunications.com)