



USER MANUAL
VERSION: V1.0.5

VPX-1701

7x1:2 Scaling Presentation Switcher



AV FOR AN IT WORLD®

IMPORTANT SAFETY INSTRUCTIONS

1. READ these instructions.
2. KEEP these instructions.
3. HEED all warnings.
4. FOLLOW all instructions.
5. DO NOT use this apparatus near water.
6. CLEAN ONLY with dry cloth.
7. DO NOT block any ventilation openings. Install in accordance with the manufacturer's instructions.
8. DO NOT install near any heat sources such as radiators, heat registers, stoves, or other apparatus (including amplifiers) that produce heat.
9. DO NOT defeat the safety purpose of the polarized or grounding type plug. A polarized plug has two blades with one wider than the other. A grounding type plug has two blades and a third grounding prong. The wider blade or the third prong are provided for your safety. If the provided plug does not fit into your outlet, consult an electrician for replacement of the obsolete outlet.
10. PROTECT the power cord from being walked on or pinched, particularly at plugs, convenience receptacles, and the point where they exit from the apparatus.
11. ONLY USE attachments/accessories specified by the manufacturer.
12. USE ONLY with a cart, stand, tripod, bracket, or table specified by the manufacturer, or sold with the apparatus. When a cart is used, use caution when moving the cart/apparatus combination to avoid injury from tip-over.
13. UNPLUG this apparatus during lightning storms or when unused for long periods of time.
14. REFER all servicing to qualified service personnel. Servicing is required when the apparatus has been damaged in any way, such as power-supply cord or plug is damaged, liquid has been spilled or objects have fallen into the apparatus, the apparatus has been exposed to rain or moisture, does not operate normally, or has been dropped.
15. DO NOT expose this apparatus to dripping or splashing and ensure that no objects filled with liquids, such as vases, are placed on the apparatus.
16. To completely disconnect this apparatus from the AC Mains, disconnect the power supply cord plug from the AC receptacle.
17. Where the mains plug or an appliance coupler is used as the disconnect device, the disconnect device shall remain readily operable.
18. DO NOT overload wall outlets or extension cords beyond their rated capacity as this can cause electric shock or fire.



The exclamation point, within an equilateral triangle, is intended to alert the user to the presence of important operating and maintenance (servicing) instructions in the literature accompanying the product.



The lightning flash with arrowhead symbol within an equilateral triangle is intended to alert the user to the presence of uninsulated "dangerous voltage" within the product's enclosure that may be of sufficient magnitude to constitute a risk of electrical shock to persons.



ESD Warning: The icon to the left indicates text regarding potential danger associated with the discharge of static electricity from an outside source (such as human hands) into an integrated circuit, often resulting in damage to the circuit.

WARNING: To reduce the risk of fire or electrical shock, do not expose this apparatus to rain or moisture.

WARNING: No naked flame sources - such as candles - should be placed on the product.

WARNING: Equipment shall be connected to a MAINS socket outlet with a protective earthing connection.

WARNING: To reduce the risk of electric shock, grounding of the center pin of this plug must be maintained.

COPYRIGHT NOTICE

AMX© 2018, all rights reserved. No part of this publication may be reproduced, stored in a retrieval system, or transmitted, in any form or by any means, electronic, mechanical, photocopying, recording, or otherwise, without the prior written permission of AMX. Copyright protection claimed extends to AMX hardware and software and includes all forms and matters copyrightable material and information now allowed by statutory or judicial law or herein after granted, including without limitation, material generated from the software programs which are displayed on the screen such as icons, screen display looks, etc. Reproduction or disassembly of embodied computer programs or algorithms is expressly prohibited.

LIABILITY NOTICE

No patent liability is assumed with respect to the use of information contained herein. While every precaution has been taken in the preparation of this publication, AMX assumes no responsibility for error or omissions. No liability is assumed for damages resulting from the use of the information contained herein. Further, this publication and features described herein are subject to change without notice.

AMX WARRANTY AND RETURN POLICY

The AMX Warranty and Return Policy and related documents can be viewed/downloaded at www.amx.com.

ESD WARNING



To avoid ESD (Electrostatic Discharge) damage to sensitive components, make sure you are properly grounded before touching any internal materials.

When working with any equipment manufactured with electronic devices, proper ESD grounding procedures must be followed to make sure people, products, and tools are as free of static charges as possible. Grounding straps, conductive smocks, and conductive work mats are specifically designed for this purpose. These items should not be manufactured locally, since they are generally composed of highly resistive conductive materials to safely drain static discharges, with-out increasing an electrocution risk in the event of an accident.

Anyone performing field maintenance on AMX equipment should use an appropriate ESD field service kit complete with at least a dissipative work mat with a ground cord and a UL listed adjustable wrist strap with another ground cord.



CAUTION

RISK OF ELECTRIC SHOCK
DO NOT OPEN



WARNING: Do Not Open! Risk of Electrical Shock. Voltages in this equipment are hazardous to life. No user-serviceable parts inside. Refer all servicing to qualified service personnel.

Place the equipment near a main power supply outlet and make sure that you can easily access the power breaker switch.

WARNING: This product is intended to be operated ONLY from the voltages listed on the back panel or the recommended, or included, power supply of the product. Operation from other voltages other than those indicated may cause irreversible damage to the product and void the products warranty. The use of AC Plug Adapters is cautioned because it can allow the product to be plugged into voltages in which the product was not designed to operate. If the product is equipped with a detachable power cord, use only the type provided with your product or by your local distributor and/or retailer. If you are unsure of the correct operational voltage, please contact your local distributor and/or retailer.

FCC AND CANADA EMC COMPLIANCE INFORMATION:

This device complies with part 15 of the FCC Rules.

Operation is subject to the following two conditions:

(1) This device may not cause harmful interference, and (2) this device must accept any interference received, including interference that may cause undesired operation.

NOTE: This equipment has been tested and found to comply with the limits for a Class A digital device, pursuant to part 15 of the FCC Rules. These limits are designed to provide reasonable protection against harmful interference in a commercial environment. This equipment generates, uses and can radiate radio frequency energy and, if not installed and used in accordance with the instructions, may cause harmful interference to radio communications. However, there is no guarantee that interference will not occur in a particular installation. If this equipment does cause harmful interference to radio or television reception, which can be determined by turning the equipment off and on, the user is encouraged to try to correct the interference by one or more of the following measures:

- Reorient or relocate the receiving antenna.
- Increase the separation between the equipment and receiver.
- Connect the equipment into an outlet on a circuit different from that to which the receiver is connected.
- Consult the dealer or an experienced radio/TV technician for help.

Approved under the verification provision of FCC Part 15 as a Class A Digital Device. Caution

Changes or modifications not expressly approved by the manufacturer could void the user's authority to operate this device. CAN ICES-3 (B)/NMB-3(B)

EU COMPLIANCE INFORMATION:

Eligible to bear the CE mark; Conforms to European Union Low Voltage Directive 2006/95/EC; European Union EMC Directive 2004/108/EC; European Union Restriction of Hazardous Substances Recast (RoHS2) Directive 2011/65/EU; European Union WEEE (recast) Directive 2012/19/EU; European Union Radio and Telecommunications Terminal Equipment (R&TTE) Directive 1999/5/EC

WEEE NOTICE:



This appliance is labeled in accordance with European Directive 2012/19/EU concerning waste of electrical and electronic equipment (WEEE). This label indicates that this product should not be disposed of with household waste. It should be deposited at an appropriate facility to enable recovery and recycling.

Table of Contents

IMPORTANT SAFETY INSTRUCTIONS	2
Overview	6
Features.....	6
Package Contents	6
Specifications	7
Transmission Distance	8
Panel Description	9
Front Panel Description	9
Rear Panel Description	15
Pinout Information	15
RS232&IR	15
Audio IN/OUT	15
Installation and Wiring.....	16
Installation	16
Wiring	16
OSD.....	18
Input Source Switching	19
Auto Switching	19
Manual Switching	19
IR Operation	20
Control the Source.....	20
RS232 Operation	21
NetLinx Control.....	22
Device Number and Ports.....	22
Send command to control a device	23
Telnet Control	23
Launch TelnetWindow	23
Web UI Control via NetLinx	25
Web UI Control	26
Header Bar.....	26
Navigation Bar.....	27
Auto Switch.....	27
Key Lock.....	28
HDCP	28
EDID	28
Display.....	29
Audio	29
Resolution.....	30

Logo	30
Network	31
System.....	32
Firmware Upgrade	32
Before Starting	32
Transferring KIT Files.....	32
Troubleshooting	34
APICommandSet	35
NetLinx Commands.....	35
Telnet/SSH Commands.....	43

Overview

The VPX-1701 is an advanced presentation switcher, allowing switching among seven inputs and distribution to two outputs. It offers two VGA inputs with balanced analog audio embedded, five HDMI inputs, one HDMI output to a local display, plus one balanced de-embedded analog audio output and one HDBaseT mirrored output to a remote display via a Cat X cable.

The VPX-1701 has one built-in scaler which supports up to 4K@60Hz 4:4:4 8bit. The video stream goes through the scaler first before distributing to two outputs. The scaler output can be set to fixed resolution or auto scaling. When set to auto scaling, the scaler analyzes the EDIDs of two connected displays and output optimum resolution for both displays.

The VPX-1701 can be set to auto switching or manual switching. It can be controlled by front panel buttons, LAN control with NetLinx Studio, Telnet API and Web GUI.

Powered by HDBT 2.0 and DSC (Display Stream Compression), the VPX-1701 can transmit 4K@60Hz 4:4:4 8bit video up to 80m/262 ft via a shielded Cat 6a/7 cable, along with USB 2.0 (Host), bidirectional RS232 and IR pass-through. HDBaseT output also features PoE (PSE) to power an HDBT receiver.

The VPX-1701 simplifies integration and installation of a small presentation system for classrooms and small offices, providing localized presentation switching support over long distances.

Features

- Provides two VGA inputs with balanced embedded audio, five HDMI inputs, one HDMI and HDBT mirrored outputs.
- HDMI inputs, HDMI and HDBT outputs support up to 4K@60Hz 4:4:4 8bit and HDCP 2.2; VGA input supports up to 1920 x 1200@60Hz.
- Built-in scaler supports up to 4K@60Hz 4:4:4 8bit.
- Supports one-way PoE to power the remote HDBT receiver.
- HDBT transmits 4K@60 4:4:4 signals up to 80m/262 ft, 1080P signal up to 100m/328ft via a shielded Cat 6a/7cable.
- Transmits USB 2.0, bi-directional RS232 and IR signal over HDBT.
- Balanced de-embedded analog audio output with volume control.
- Auto-switching to the latest connected source input by detecting input signal status.
- Fast switching.
- Able to turn on/off connected displays automatically by detecting input signal status with its built-in CEC controller.
- Selection buttons on the front panel for local control and contact closures for remote keypad control.
- Supports LAN control through NetLinx Studio, Telnet API and WEB UI.

Package Contents

- 1 x VPX-1701
- 1 x US AC Power Cord
- 1 x UK AC Power Cord
- 1 x EU AC Power Cord
- 7 x Phoenix Male Connector (3.5mm, 5 Pins)
- 1 x Phoenix Male Connector (3.5mm, 6 Pins)
- 2 x Mounting Bracket (with Screws)

Specifications

Technical	
Input	2 x VGA; 5 x HDMI
Input Signal Type	<ul style="list-style-type: none"> HDMI with 4K@60Hz YUV 444, HDCP 2.2 VGA
Input Resolution Supported	1280 x 1024 @ 75 Hz 1152 x 870 @ 75 Hz 1024 x 768 @ 60 Hz, 70 Hz, 75 Hz, 87 Hz 832 x 624 @ 75 Hz 800 x 600 @ 56 Hz, 60 Hz, 72 Hz, 75 Hz 720 x 400 @ 70 Hz, 88 Hz 640 x 480 @ 60 Hz, 67 Hz, 72 Hz, 75 Hz CEA Video Information Code (VIC) Formats: VIC = 1, 640 x 480p 59.94/60 Hz 4:3 VIC = 2, 720 x 480p 59.94/60 Hz 4:3 VIC = 3, 720 x 480p 59.94/60 Hz 16:9 VIC = 4, 1280 x 720p 59.94/60 Hz 16:9 VIC = 5, 1920 x 1080i 59.94/60 Hz 16:9 VIC = 6, 720(1440) x 480i 59.94/60 Hz 4:3 VIC = 7, 720(1440) x 480i 59.94/60 Hz 16:9 VIC = 14, 1440 x 480p 59.94/60 Hz 4:3 VIC = 15, 1440 x 480p 59.94/60 Hz 16:9 VIC = 16, Native 1920 x 1080p 59.94/60 Hz 16:9 VIC = 17, 720 x 576p 50 Hz 4:3 VIC = 18, 720 x 576p 50 Hz 16:9 VIC = 19, 1280 x 720p 50 Hz 16:9 VIC = 20, 1920 x 1080i 50 Hz 16:9 VIC = 21, 720(1440) x 576i 50 Hz 4:3 VIC = 22, 720(1440) x 576i 50 Hz 16:9 VIC = 29, 1440 x 576p 50 Hz 4:3 VIC = 30, 1440 x 576p 50 Hz 16:9 VIC = 31, 1920 x 1080p 50 Hz 16:9 VIC = 32, 1920 x 1080p 23.97/24 Hz 16:9 VIC = 33, 1920 x 1080p 25 Hz 16:9 VIC = 34, 1920 x 1080p 29.97/30 Hz 16:9 VIC = 39, 1920 x 1080i 50 Hz 16:9 VIC = 41, 1280 x 720p 100 Hz 16:9 VIC = 42, 720 x 576p 100 Hz 4:3 VIC = 43, 720 x 576p 100 Hz 16:9 VIC = 44, 720(1440) x 576i 100 Hz 4:3 VIC = 45, 720(1440) x 576i 100 Hz 16:9 VIC = 47, 1280 x 720p 119.88/120 Hz 16:9 VIC = 48, 720 x 480p 119.88/120 Hz 4:3 VIC = 49, 720 x 480p 119.88/120 Hz 16:9 800x600 ⁸ , 1024x768 ⁸ , 1280x720 ⁸ , 1280x768 ⁸ , 1280x800 ⁸ , 1280x960 ⁸ , 1280x1024 ⁸ , 1360x768 ⁸ , 1366x768 ⁸ , 1440x900 ⁸ , 1600x900 ⁸ , 1600x1200 ⁸ , 1600x1050 ⁸ , 1680x1050 ⁸ , 1920x1080 ⁸ , 1920x1200 ⁸ , 2560x1440 ⁸ , 2560x1600 ⁸ , 3840x2160P ^{2,3,5,8} , 4096x2160P ^{2,3,5,8} 1 = at 23.98 Hz, 2 = at 24 Hz, 3 = at 25 Hz, 4 = at 29.97 Hz, 5 = at 30 Hz, 6 = at 50 Hz, 7 = at 59.94 Hz, 8 = 60 Hz
Maximum Pixel Clock	600MHz
Output	1 x HDMI, 1 x HDBaseT
Output Signal Type	HDMI with 4K@60Hz YUV 444, HDCP 2.2
Output Resolution Supported	VESA: 800x600 ⁸ , 1024x768 ⁸ , 1280x768 ⁸ , 1280x800 ⁸ , 1280x960 ⁸ , 1280x1024 ⁸ , 1360x768 ⁸ , 1366x768 ⁸ , 1440x900 ⁸ , 1600x900 ⁸ , 1600x1200 ⁸ , 1600x1050 ⁸ , 1920x1200 ⁸ , 3840x2160 ^{2,3,5,8} , 4096x2160 ^{2,3,5,8} and Auto Scaling SMPTE: 1280x720P ^{6,8} , 1920x1080P ^{6,8} 1 = at 23.98 Hz, 2 = at 24 Hz, 3 = at 25 Hz, 4 = at 29.97 Hz, 5 = at 30 Hz, 6 = at 50 Hz, 7 = at 59.94 Hz, 8 = at 60 Hz
Control Method	<ul style="list-style-type: none"> Auto switching Front panel buttons Contact closures LAN (Telnet API, WEBUI) NetLinX control

Audio	
Audio Input	2 x Balanced Analog Audio Inputs: 5-pin Phoenix Connector
Audio Output	1 x Balanced Analog Audio Output: 5-pin Phoenix Connector
Audio Format Supported	PCM 2.0
General	
Operating Temperature	0°C to 50°C (32°F to 122°F)
Storage Temperature	-10°C to 60°C (14°F to 140°F)
Humidity	5% to 85%, non-condensing
ESD Protection	Human-body Model: ±10kV(Air-gap discharge)/±5kV(Contact discharge)
Power Supply	100-240V AC
Power Consumption (Max)	45W
Device Dimension (W x H x D)	<ul style="list-style-type: none"> With mounting brackets: 482.6mm x 43.5mm x 300mm/19" x 1.71" x 11.81" Without mounting brackets: 440mm x 43.5mm x 300mm/17.32" x 1.71" x 11.81"
Product Weight	3.8kg/8.38lbs
Rack Space Required	1U
Certification	CE, FCC, ETL, PSE, RCM

Transmission Distance

Note: Straight-through category cable wired to T568B standard is recommended.

Cable Type	Range	Supported Video
Shielded Cat 6a/7	100/328 ft	1080P@60Hz
	80m/262 ft	4K@60 4:4:4
HDMI	Input/Output: 15m/50ft	1080P@60Hz
	Input: 5m/16ft Output: 10m/33ft	4K@60Hz 4:2:0
	Input/Output: 5m/16ft	4K@60Hz 4:4:4

Panel Description

Front Panel Description



No.	Name	Description
1	INPUT SELECT	INPUT Selection button: Press to manually select a source as the current source input. The button function can be enabled through command control or WEB UI on NetLinx. LED: LED is located on the top of the selection button. When the button function is enabled, pressing an input selection button will light the LED Green.
2	POWER LED (Green)	On: VPX-1701 is powered on. Off: VPX-1701 is powered off.

Rear Panel Description

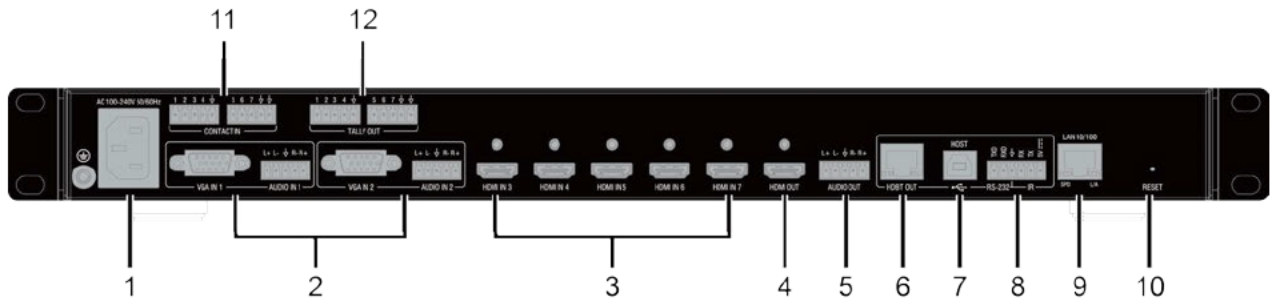

No.	Name	Description
1	AC	Connect the power cord provided. Accepts AC power of 100-240V 50/60Hz.
2	VGA IN	VGA IN (1-2): Connect to VGA sources. AUDIO IN (1-2): Connect to audio devices for audio input, embedded with the VGA sources.
3	HDMI IN (3-7)	Connect to HDMI sources.
4	HDMI OUT	Connect to an HDMI display.
5	AUDIO OUT	Connect to an audio receiver for HDMI audio de-embedding output.
6	HDBT OUT	Connect to an HDBT receiver via a Cat 5e/6/7 cable. The port mirrors to HDMI OUT.
7	HOST	Connect to the USB Host device, such as a PC.
8	RS-232 & IR Connector	Connect to an RS232-enabled device and an IR device.
9	LAN 10/100	Connect to an Ethernet device.
10	RESET	When the VPX-1701 is powered on, use a pointed stylus to hold down the RESET button for three or more seconds, and then release it. It will reboot and restore to its factory defaults.
11	CONTACT IN	Connect pins 1-4, 5-7 and ↓ to a remote controller for switching among VGA and HDMI IN 1-2: 1-2: Select VGA IN 1-2. 3-7: Select HDMI IN 3-7. ↓: Connect to Ground.
12	TALLY OUT	Connect pins 1-4, 5-7 and ↓ to a status display device such as LEDs to indicate which source is currently selected. 1-2: Positive signal means VGA IN 1/2 is selected. 3-7: Positive signal means HDMI IN 3/4/5/6/7 is selected. ↓: Connect to Ground.

Pinout Information

The following figures show the pinouts of the phoenix connectors.

RS232&IR

Connects to the RS232 and IR devices with the 6-pole, 3.5mm captive screw connectors.

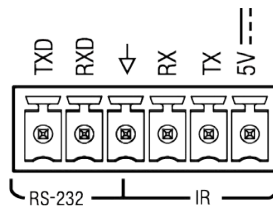

Audio IN/OUT

Connect to audio device with the 3-pole, 3.5mm captive screw connector.

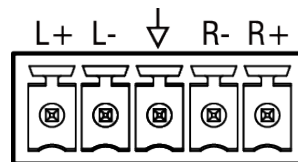

Installation and Wiring

Warning: Before installation, ensure the device is disconnected from the power source. The VPX-1701 can be placed on a solid and stable surface or installed in a standard equipment rack.

Installation

1. Attach the installation bracket to the enclosure using the screws provided.
2. The bracket is attached to the enclosure as shown.

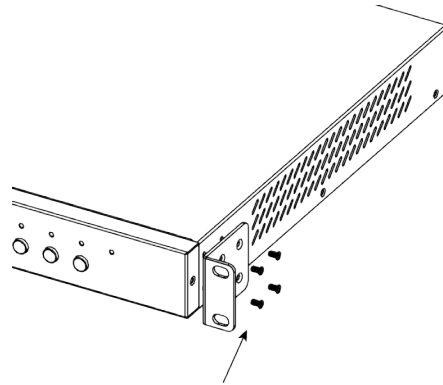

3. Repeat steps 1-2 for the other side of the unit.
4. Attach the brackets to a surface or suitable location with user supplied screws.

Wiring

Warning:

- Before wiring, disconnect the power from all devices.
- Connect and disconnect the cables with care.

1. Connect the video source
Connect the VGA and HDMI sources (such as PC, Blu-ray player, Apple TV, 4K media player, etc) to the VGA IN and HDMI IN ports of the VPX-1701.
2. Connect HDMI OUT
Connect an HDMI display device (such as TV, projector, LED/LCD display) to the HDMI OUT of the VPX-1701.
3. Connect AUDIO OUT
Connect an audio receiver (e.g. an amplifier) to the AUDIO OUT of the VPX-1701.
4. Connect HDBT OUT
Connect HDBT OUT of VPX-1701 to HDBT IN of an HDBT receiver with a Cat 5e/6/6a/7 cable.
5. Connections for additional control options:
 - LAN control (NetLinx/Telnet/Web UI): Connect a Local Area Network to the LAN port of the VPX-1701.
 - Input source switching control: Connect a keypad and LEDs to CONTACT IN and TALLY OUT ports for input switching and tally indication.
 - USB control: Connect a USB host to the VPX-1701, and USB devices to the HDBT receiver for remote KVM control.
 - RS232 pass-through: Connect an RS232 server device (or client device) to the RS232 port of the VPX-1701, and an RS232 client device (or server device) to the RS232 port of the remote receiver for bidirectional RS232 pass-through.
 - IR pass-through: Connect an IR emitter (or IR receiver) to the IR connector of the VPX-1701, and an IR receiver (or IR emitter) to the IR connector of the HDBT receiver for bi-directional IR pass-through.
6. Connect the AC power cord provided to the VPX-1701.
One-way PoH enables the VPX-1701 to power the remote HDBT DSC receiver along a single Cat X cable. No additional power adapter is required at the receiver.
7. Power on all attached devices.

When all connections are made and power is ON, check if all LED indicators on the VPX-1701 are normal to ensure installation is successful. For LED indication, please refer to Panel Description section.

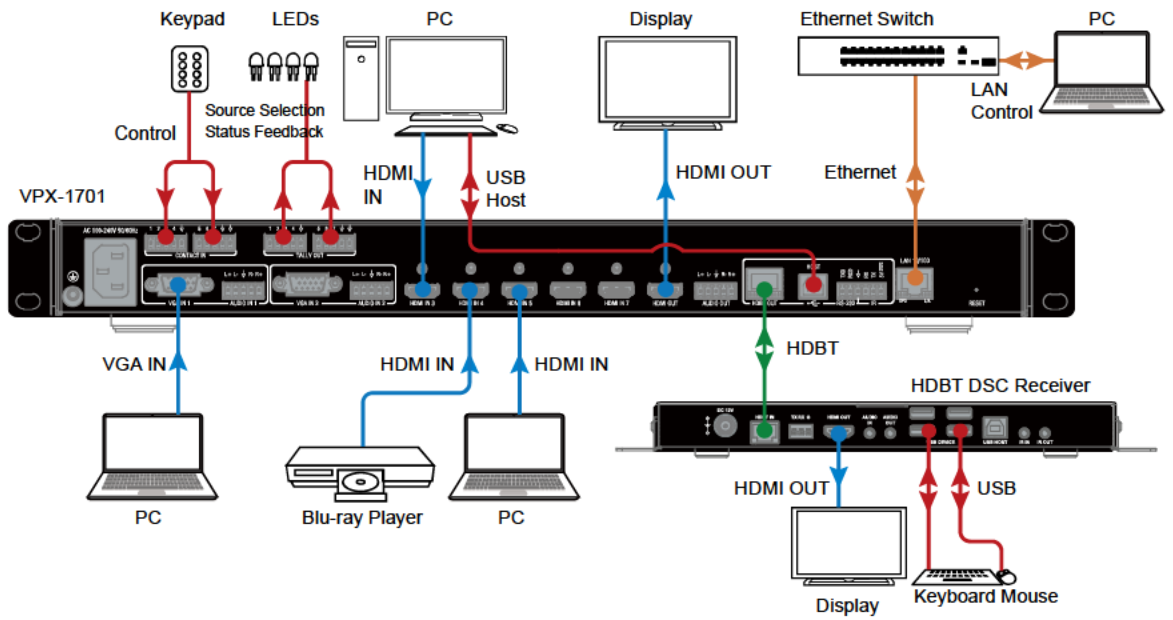

OSD

The VPX-1701 supports OSD (On Screen Display) to display its IP address. Follow these steps to initiate OSD:

1. Press and Hold the front panel buttons VGA IN 1 and VGA IN 2 for at least 3 seconds.
2. The IP address of the VPX-1701 will display on the upper right of the connected display's screen for about 15s and then disappear.

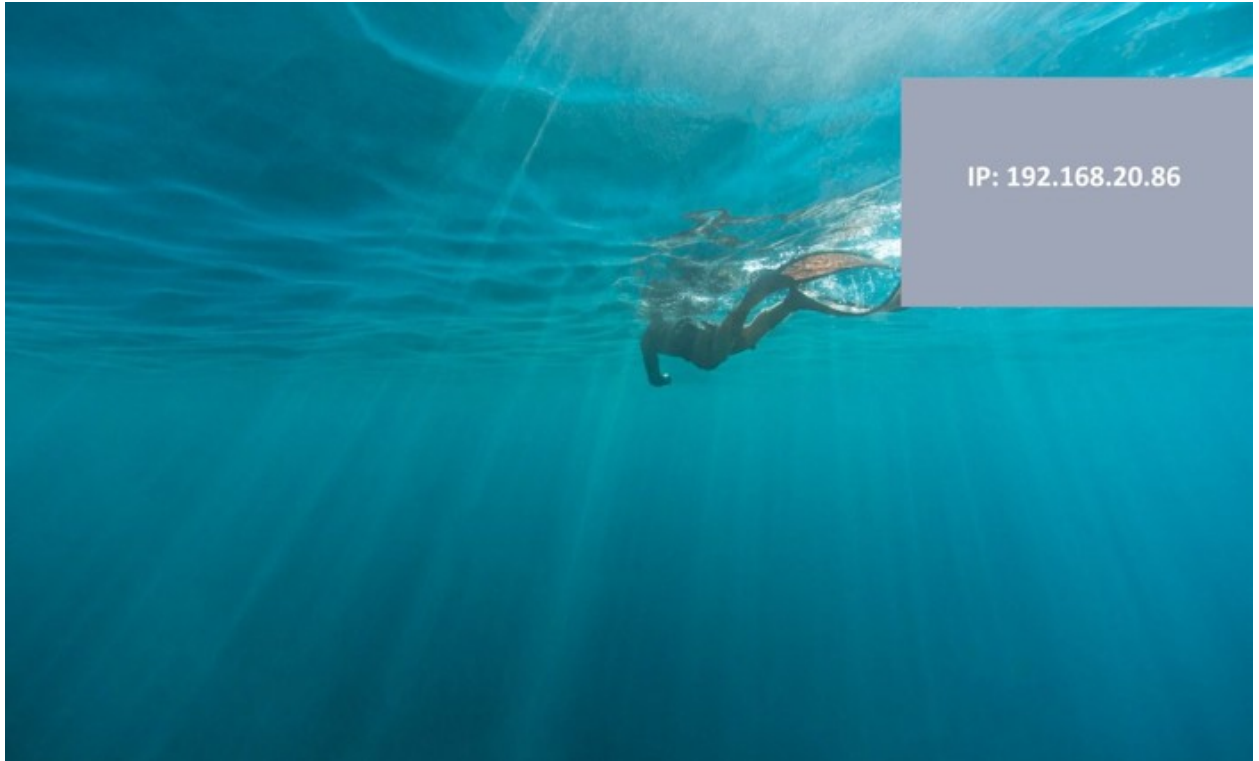

Input Source Switching

The VPX-1701 supports Auto and Manual Switching among the VGA and HDMI inputs.

Auto Switching

1. When multiple sources are inserted, and power is ON for all devices, the input will be switched to the active source with the highest priority.
2. Priority: VGA IN 1 > VGA IN 2 > HDMI IN 3 > HDMI IN 4 > HDMI IN 5 > HDMI IN 6 > HDMI IN 7
3. When a new source is inserted, the input will be switched to it automatically, following the Last-In-First-Out rule.
4. When the currently selected source is removed, the input will first be switched to the most recently selected port. If the port has no active source, the input will be switched to the active source with the highest priority.

Note:

- When in Auto Switching, Input Select buttons do not function. To use input select buttons, disable Auto Switching.
- The Auto Switching function is enabled by default once all devices are powered on.
- You can enable or disable Auto Switching through command setting or WEB UI on NetLinX.

Manual Switching

If you want to select a specific input port using selection buttons:

1. Disable Auto Switching through command setting or WEB UI on NetLinX.
2. Press the appropriate Input Button to select a desired input port. When an inactive port is selected, the VPX-1701 will output no signal.



IR Operation

The IR pass-through function allows remote control of the source from the display location or the display from the source location.

Control the Source

To control the source from the display location:

1. Connect an IR emitter to IR port of the VPX-1701;
2. Connect a broadband IR receiver to the IR IN port of an HDBT receiver.

When the connections are complete, the source can be controlled at the display location through a source remote.

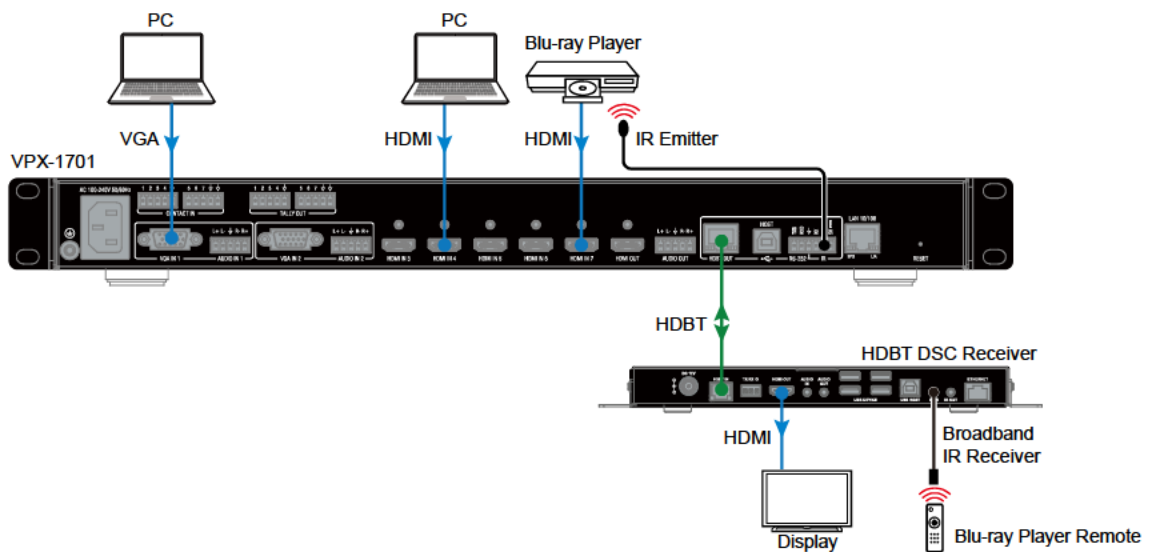

RS232 Operation

The RS232 port of the VPX-1701 can be used for bi-directional RS232 signal pass-through between the VPX-1701 and an HDBT receiver. To set up for RS232 pass-through:

1. Connect an RS232 Server (or Client) Device to the RS232 port of the VPX-1701 with an RS232 cable (See Pinout Information Section for RS232 wiring);
2. Connect an RS232 Client (or Server) Device to the RS232 port of an HDBT receiver with an RS232 cable.
3. Connect HDBT OUT of the VPX-1701 to HDBT IN of the HDBT receiver with a Cat 5e/6/7 cable.

When the connections are completed, RS232 signal can be passed through bi-directionally between two RS232 devices.

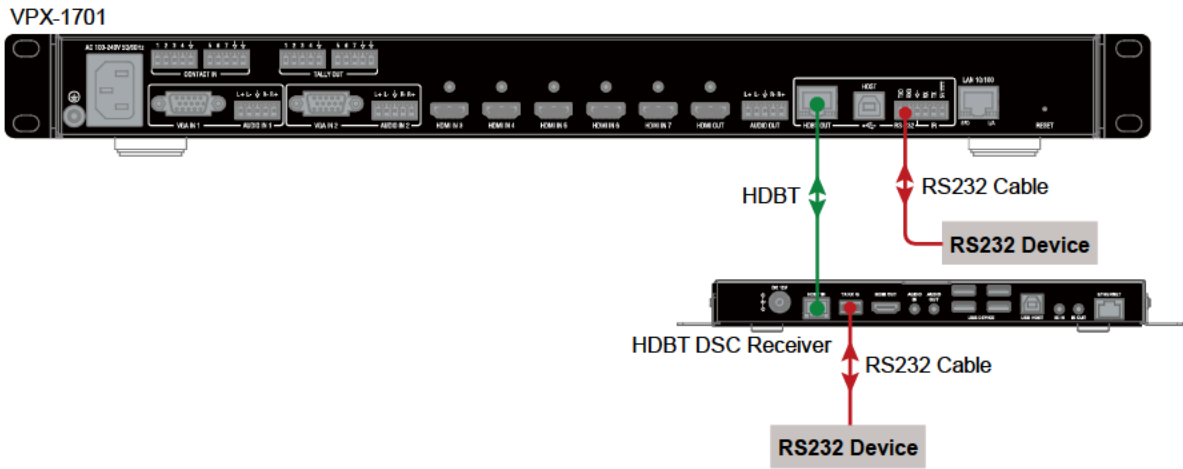

NetLinX Control

Controlling the VPX-1701 through NetLinX Studio.

Before launching NetLinX Studio, connect the VPX-1701, PC, and control system (e.g. NX-3200) to the same network.

Note: IDs and IP addresses in the following illustrations are examples. Check the Online Tree in NetLinX Studio to find the correct addresses for your device.

Device Number and Ports

Each VPX-1701 has its own Device Number (which is assigned when the unit is bound to a Control System) and the following ports.

Port 1: VGA IN 1 (AUDIO IN 1); HDMI OUT; AUDIO OUT; HDBT OUT

Port 2: VGA IN 2 (AUDIO IN 2)

Port 3: HDMI IN 3

Port 4: HDMI IN 4

Port 5: HDMI IN 5

Port 6: HDMI IN 6

Port 7: HDMI IN 7

Port 8:

Port 9: RS-232

Port 10: HOST

Port 11: IR

Port 12:

Port 22: CONTACT IN

Port 23: TALLY OUT

In NetLinX Studio's Online Tree, the VPX-1701 module displays its ports.

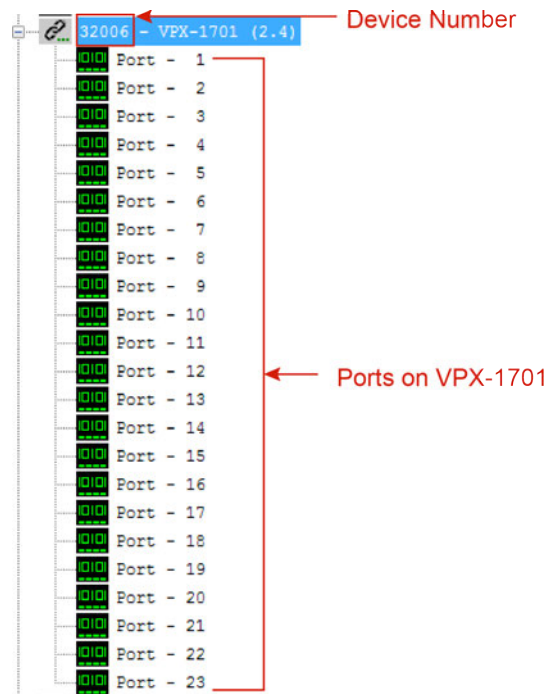

Send command to control a device

Click “Diagnostics” on the menu bar, select “Control a Device”.

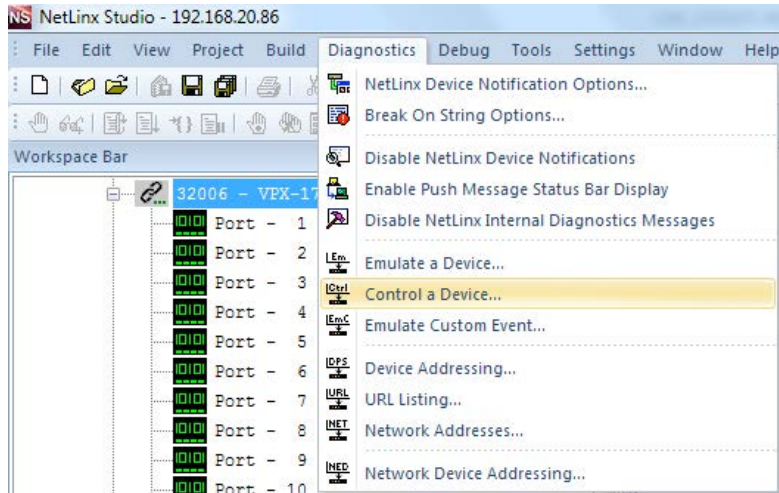

A window will display as follows, type the Device number, Port number, System and command respectively, and click “Send To Device”. (For API commands, see the Section **API Command Set**.)

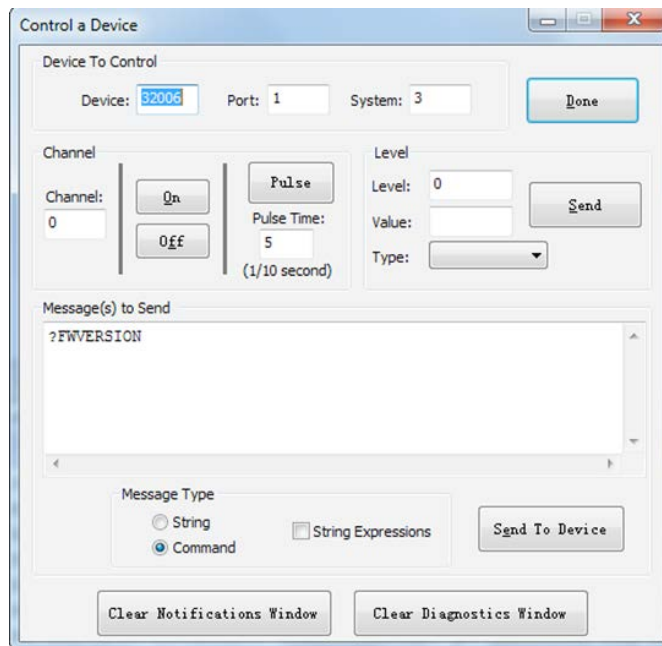

Telnet Control

Launch Telnet Window

To launch Telnet Window,

1. Right click the Device Number in NetLinx Studio's Online Tree, select “TELNET Window” – “Launch TELENT Window via NetLinx Studio” (or “Launch TELENT Window via User Defined Program”)*.

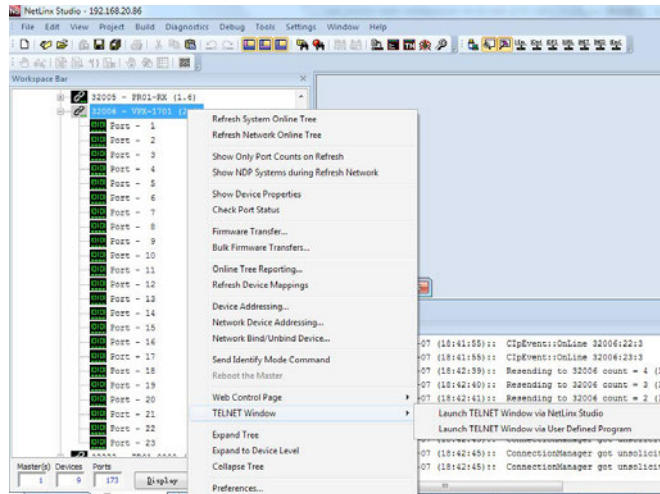

The Telnet window opens.

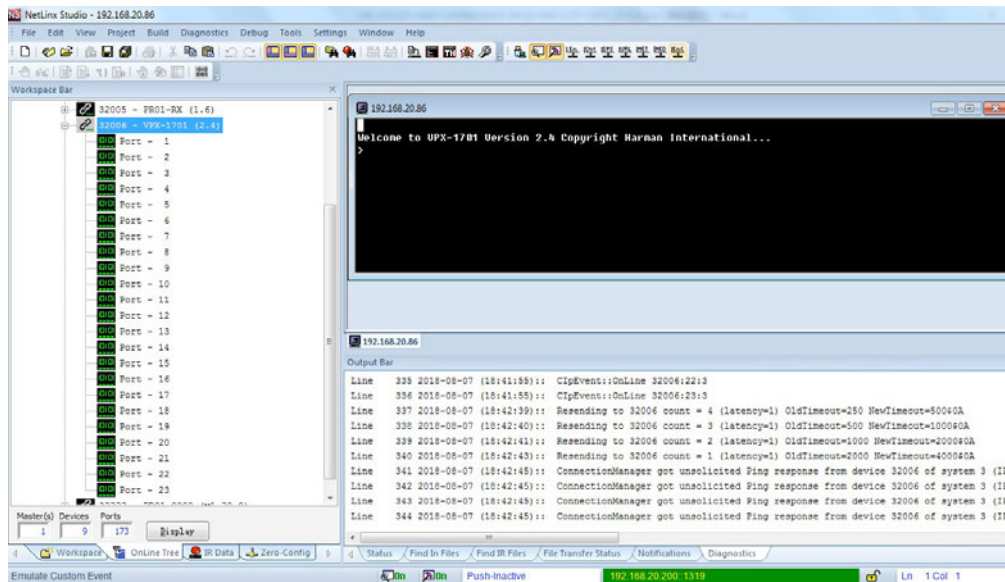

2. At the prompt (>), type the Telnet command and press Enter.

* Selecting “**Launch TELNET Window via User Defined Program**”, may require enabling Telnet by completing the following:

- (1) go to Start/Control Panel/Programs and Features;
- (2) on the left, select “Turn Windows features on or off”;
- (3) select the check-boxes Telnet Client and Telnet Server, and click OK.

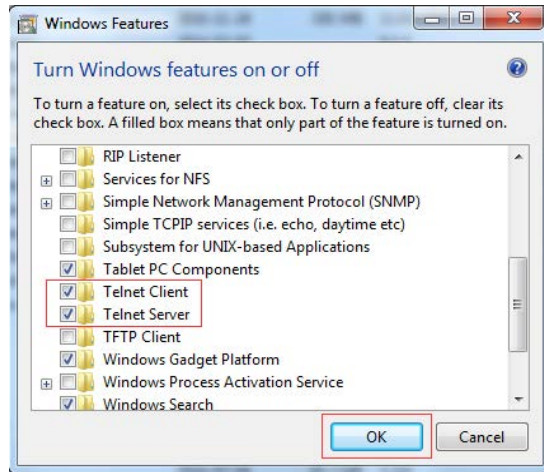

Web UI Control via NetLinx

To configure and control the device on the Web, right click the Device Number in the Online Tree Tab, choose “Web Control Page” – “Launch Web Control Page via NetLinx Studio”.

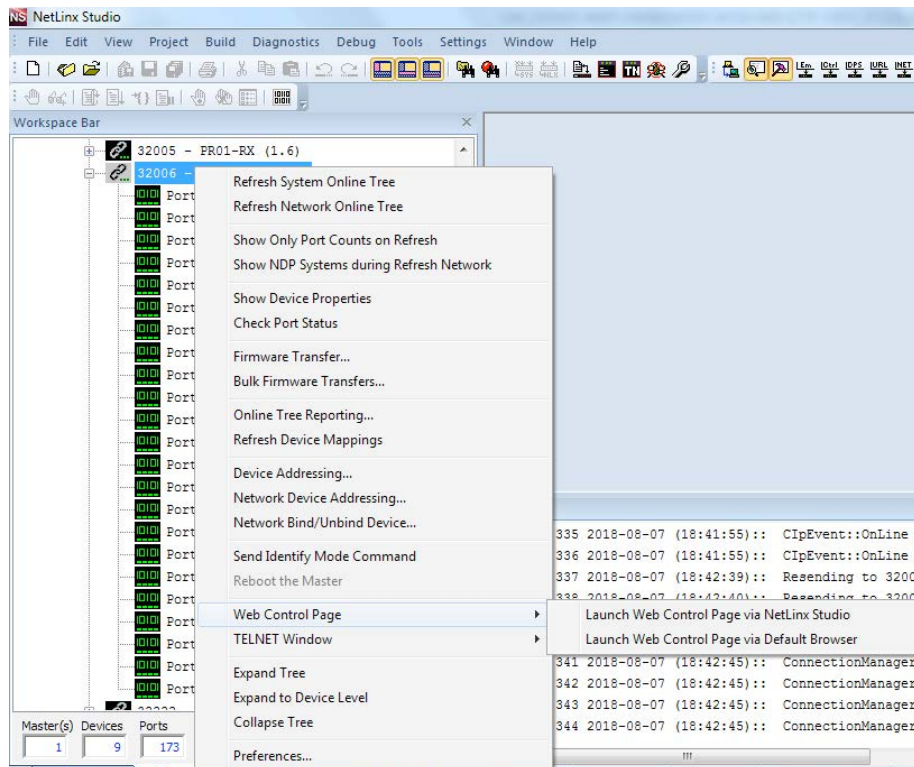

Web UI Control

The Web UI designed for the VPX-1701 allows basic controls and advanced settings of the device. The Web UI page can be accessed through NetLinx Studio.

To access the VPX-1701 Web UI:

1. Connect your PC and the LAN port of the VPX-1701 to the same local area network.
2. In NetLinx Studio's Online Tree, select "Web Control Page" – "Launch Web Control Page via Default Browser" (or select "Launch Web Control Page via NetLinx Studio").

The following page will pop up. Enter the default password "admin" and click "Login".



The main screen displays as follows.

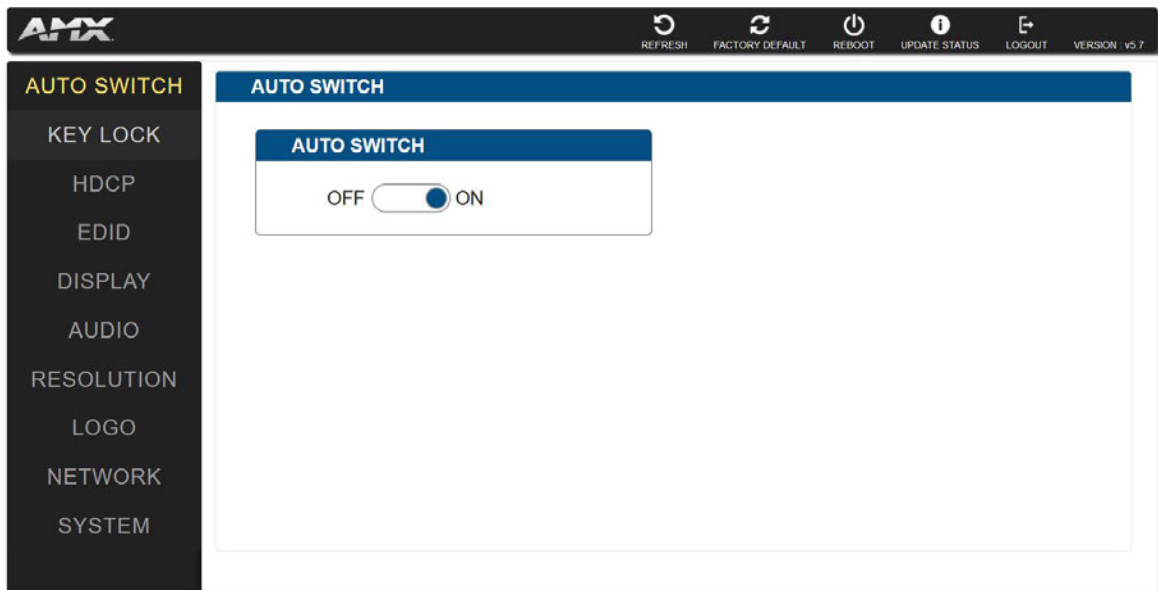

The Web UI page consists of header bar and navigation bar for basic and advanced settings, including Auto Switch, HDCP, EDID, Display, Resolution, Network, System, etc.

Header Bar

The header bar consists of logo, the following five buttons and version information.



: Refresh button, click to refresh the Web UI to the latest setting.



: Factory Default button, click to reset the device to factory default settings.

Steps to reset the device to factory default settings:

1. Click "Factory Default" button.
2. Click "OK" to proceed.

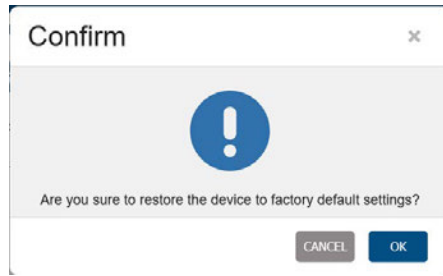

A successful reset will restore all the device settings to their factory defaults and the device will reboot automatically. Allow at least 2 minutes for the reboot to complete.



REBOOT: Reboot button, click to reboot the device.

Steps to reboot the device:

1. Click "Reboot" button.
2. Click "OK" to proceed. Then the device will reboot immediately.

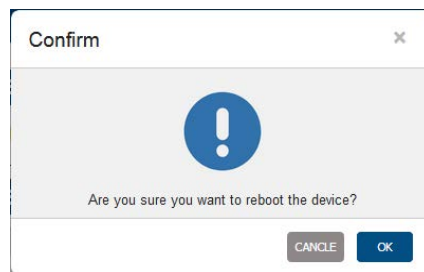

UPDATE STATUS: Update status button, click to view the device's firmware upgrade status.



LOGOUT: Logout button, click to logout from the Web UI.



VERSION : v5.6: Displays the device's firmware version information.

Navigation Bar

The navigation bar includes the following tabs: Auto Switch, Key Lock, HDCP, EDID, Display, Relay, Audio, Resolution, Logo, Network and System.

Auto Switch

Auto Switch allows switching among multiple inputs without using the buttons on the front panel.

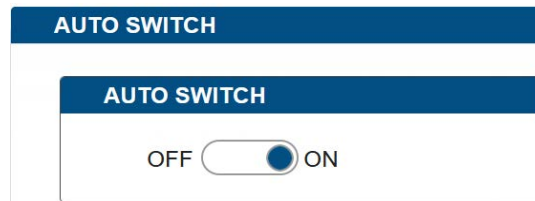

- **ON**: Click to enable Auto Switch (default setting).
- **OFF**: Click to disable Auto Switch.

Key Lock

Key Lock allows locking of the buttons on the VPX-1701 to prevent accidental or unwanted switching.

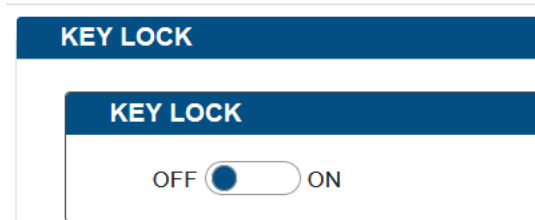

- **ON:** Click to enable Key Lock.
- **OFF:** Click to disable Key Lock (default setting).

HDCP

HDCP Support allows enabling or disabling HDCP compatibility of each input and HDMI output.

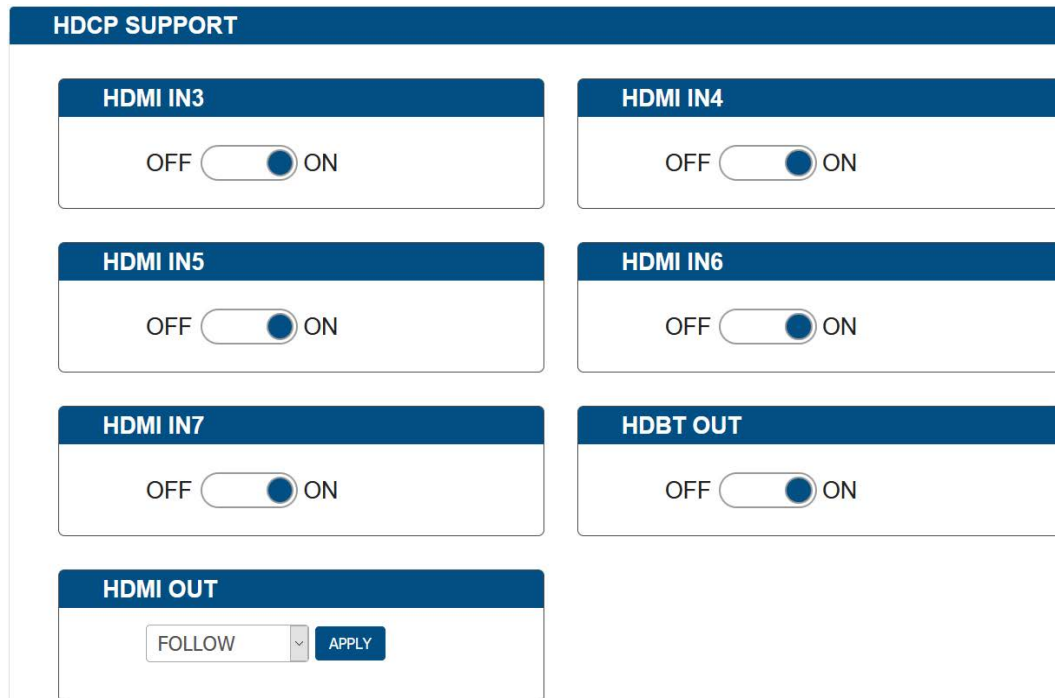

- **ON:** Click to enable HDCP compatibility for the corresponding input, which will transmit HDCP protected content (default setting).
- **OFF:** Click to disable HDCP compatibility for the corresponding input, which will transmit non-HDCP protected content.

For HDMI Out:

- **FOLLOW:** Select to follow the output display's HDCP compatibility for the HDMI Out, which will transmit content with the same HDCP compatibility as that of the output display (default setting).
- **HDCP 2.2:** Select to transmit HDCP 2.2 protected content to the output display.
- **HDCP 1.4:** Select to transmit HDCP 1.4 protected content to the output display.
- **NO HDCP:** Select to transmit non-HDCP protected content to the output display. (Note: If "NO HDCP" is selected for HDMI OUT, when the HDCP protected signal is being input, the receiver will output no signal.)
- **Apply:** Click to make the selection to take effect.

EDID

EDID Support allows configuration of the EDID setting of each input.

Locate the target input port and select specific EDID settings from the drop-down menu, then click "Apply" to perform the setting. The default EDID settings for all HDMI input ports are "Copy EDID from output display".

EDID SUPPORT

VGA IN1

1920x1080@60Hz 2CH (Default) APPLY

VGA IN2

1920x1080@60Hz 2CH (Default) APPLY

HDMI IN3

Copy from output (Default) APPLY

HDMI IN4

Copy from output (Default) APPLY

HDMI IN5

Copy from output (Default) APPLY

HDMI IN6

Copy from output (Default) APPLY

HDMI IN7

Copy from output (Default) APPLY

Display

DISPLAY

AUTO DISPLAY CONTROL

OFF ON DELAY TIME(1-30 min) 2 min

Auto Display Control allows control of CEC-enabled displays connected to the VPX-1701 through HDMI.

- **ON:** Click to enable the Auto Display Control.
- **OFF:** Click to disable the Auto Display Control. (Default setting)
- **DELAY TIME (1~30 min):** Click the down arrow to set the time for the display to power off automatically when no signal is present. Example: With the time set to 2 minutes, the output display will be powered off automatically when there is no signal input for 2 minutes.

Note: The time range for Auto Display Control is 1-30 minutes.

Audio

AUDIO

Output Volume: Mute

0 10 20 30 40 50 60 70 80 90 100



Min/Max:

0 10 20 30 40 50 60 70 80 90 100



- **Output Volume:** Move the slider to set the output audio volume.
- **Min/Max:** Move the sliders at the left and right sides of the scale to set the minimum and maximum range of the audio volume.
- **Mute:** Check (or uncheck) to mute (or unmute) the audio.

Resolution

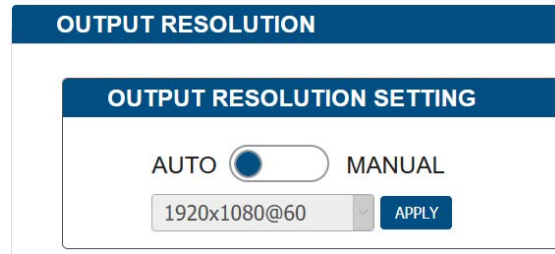

- **AUTO:** Click to set the output resolution to Auto mode (default setting). The output resolution may vary based on the connected display's native resolution.
- **MANUAL:** Click to set the output resolution to Manual mode. In Manual mode, click the down arrow to select a specific output resolution as required.
- **APPLY:** Click to set the output resolution to the desired setting.

Logo

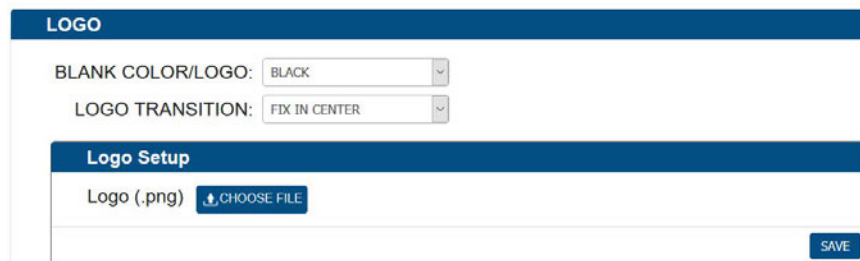

Logo section allows display content configuration for the display screen when there's no signal output to the display.

- **BLACK COLOR/LOGO:**
 - 1) **BLACK:** Select to set the display screen as black when there's no signal output to the display.
 - 2) **LOGO:** Select to set the display to show a logo picture when there's no signal output to the display.
 - **LOGO TRANSITION:**
 - 1) **FIX IN CENTER:** Select to set the logo picture to be shown in the display screen's center when there's no signal output to the display. (Default setting)
 - 2) **DRAG TOP LEFT:** Select to set the logo picture to shuttle slowly between the center and the top left of the display screen when there's no signal output to the display.
 - 3) **DRAG TOP RIGHT:** Select to set the logo picture to shuttle slowly between the center and the top right of the display screen when there's no signal output to the display.
 - 4) **DRAG BOTTOM LEFT:** Select to set the logo picture to shuttle slowly between the center and the bottom left of the display screen when there's no signal output to the display.
 - 5) **DRAG BOTTOM RIGHT:** Select to set the logo picture to shuttle slowly between the center and the bottom right of the display screen when there's no signal output to the display.
 - **Logo Setup**
 - 1) **CHOOSE FILE:** Click to upload a logo file to the switcher from your local computer.
 - 2) **SAVE:** Click to perform the logo file uploading.
- Note:**
- The logo file should be in .png format with size not larger than 1280x720, 60KB.
 - When the logo is loaded to the device successfully, the device will reboot immediately.

Network

NETWORK

DEVICE IP MODE <input checked="" type="radio"/> DHCP <input type="radio"/> STATIC	MAC ADDRESS 00:60:9f:a4:78:53
DEVICE IP ADDRESS 192.168.20.158	IP HOSTNAME AMX-VPX-1701-A47853
SUBNET MASK 255.255.255.0	DNS 1 192.168.20.1
DEFAULT GATEWAY 192.168.20.1	DNS 2 0.0.0.0

APPLY

NOTE: LAN MODULE WILL AUTOMATICALLY REBOOT AFTER CHANGING NETWORK SETTING.

Device IP Mode:

- **DHCP:** When enabled, the IP address of the switcher will be assigned automatically by the connected DHCP server.
- **Static:** When the switcher fails to obtain or detect an IP address from the network to which it is connected, select "Static" to set up the IP address manually.
- **APPLY:** Click to set the network setting.

Note: Allow 2-3 minutes for the device's LAN module to reboot and reconnect after the network setting is changed.

System

SYSTEM

ICSP PARAMETER

CONNECTION MODE:

MASTER URL:

SYSTEM NUMBER: (0-65535)

DEVICE NUMBER:

LOGIN PASSWORD

OLD PASSWORD:

NEW PASSWORD:

TELNET/SSH ACCESS

TELNET: OFF ON

SSH: OFF ON

TELNET ACCOUNT

USERNAME:

PASSWORD:

SSH ACCOUNT

USERNAME:

PASSWORD:

UPLOAD CERTIFICATE

PASSWORD

PRIVATE KEY(.pem)

CERTIFICATE(.pem)

NOTE: CERTIFICATE MODULE WILL AUTOMATICALLY REBOOT AFTER UPLOAD COMPLETED.

The system section is used to configure the ICSP Parameter, login password, Telnet/SSH account and upload certificate.

1. ICSP PARAMETER:
 - **CONNECTION MODE:** includes four options: NDP, Auto IP, URL/TCP, URL/UDP. The default setting is NDP.
 - **CONTROLLER URL:** Input the connected controller's URL.
 - **SYSTEM NUMBER:** Use the Online Tree to determine the system number. By default, it is disabled to be configured.
 - **DEVICE NUMBER:** Use the Online Tree to determine it. By default, it is disabled to be configured.
2. LOGIN PASSWORD:

LOGIN PASSWORD: Login Password can be changed. The default Login Password is **admin**.
3. TELNET/SSH ACCESS

TELNET/SSH ACCESS is used to enable or disable Telnet/SSH capability. The default setting is **ON**.
Note: Reboot the device for the setting change to take effect.
4. TELNET/SSH ACCOUNT

TELNET/SSH ACCOUNT is used to configure the user name and password of the account.

 - **TELNET ACCOUNT**

The default user name and password are null.
 - **SSH ACCOUNT**

The default user name is admin, the default password is password. Note: Reboot the device for the SSH ACCOUNT setting change to take effect.
 - **APPLY:** Click to choose each of the settings.
5. Upload Certificate
 - **Password:** Enter the password of the certificate uploaded.
 - **Private Key (.pem):** Click "CHOOSE FILE" to browse for the private key in .pem format of the https certificate in your local computer.
 - **Certificate (.pem):** Click "CHOOSE FILE" to browse for the https certificate in .pem format in your local computer.

- **Upload:** Click to upload the https certificate and its private key to the device.
- Note:** When certificate upload is completed, the certificate module will reboot automatically.

Firmware Upgrade

The VPX-1701 uses KIT files for firmware upgrade.

Before Starting

1. Verify that you have the latest version of NetLinx Studio on your PC.
2. Download the latest firmware (KIT) file to your PC. (Place KIT files on a local drive for the fastest throughput.)
3. Verify the following:
 - a) Verify that an Ethernet/RJ-45 cable is connected from the VPX-1701 to the same network as the control system.
 - b) Verify the VPX-1701 unit is powered ON.
4. Launch NetLinx Studio and open the Online Tree.
5. Bind the device to the integrated Controller: select and right-click the VPX-1701; from the context sensitive menu, select Network Bind/Unbind Device (be sure the check box is selected); click OK.

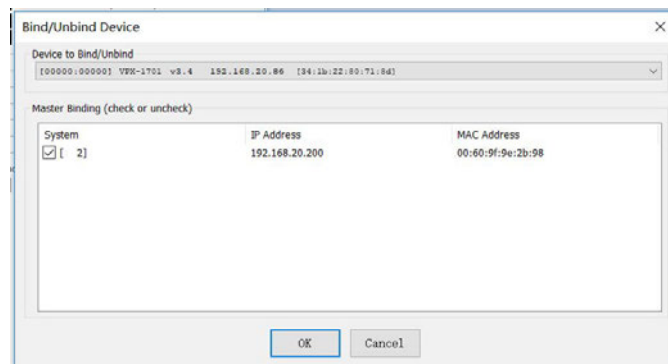

Transferring KIT Files

1. In NetLinx Studio, choose **Tools > Firmware Transfers > Send to NetLinx Device** to open the "Send to NetLinx Studio" dialog.
2. Click  to navigate to the target directory. The selected directory path is displayed in the Location text box. KIT files in the target directory display under File Name.

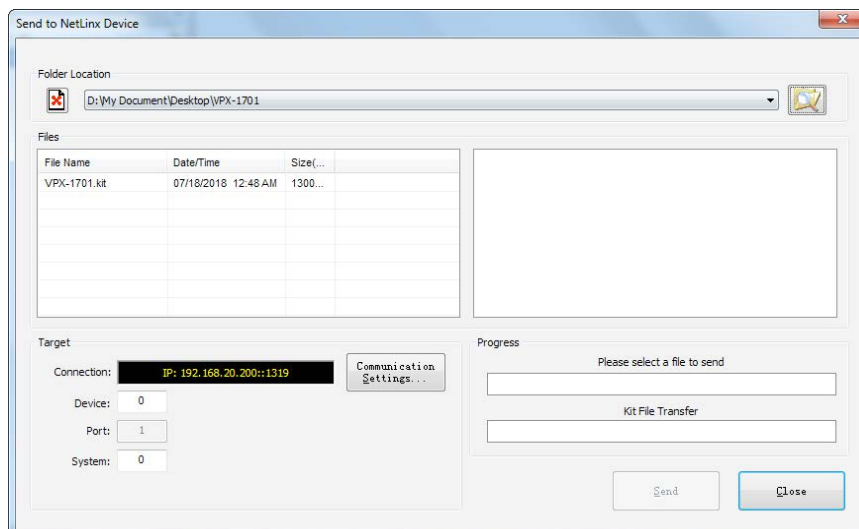

3. Select the appropriate KIT file from the File Name list.
4. Check the number of the Device to be upgraded in the Device text box.

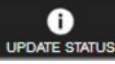
- The device number is 32006.
 - The system number is 3. (Use the Online Tree to determine the system number.)
5. Click “Send” to upgrade the firmware.
6. Click the  button on Web UI page to check the upgrade status. When the process completes, the device will restart automatically.

Note:

- The upgrade process takes 1 hour.
- Do not power off the device until it has been successfully upgraded.
- The device will restart two times to resume normal operation.

Troubleshooting

1. **Power:** Ensure all devices are powered on.
2. **Indicator:** Ensure all LED indicators of the switcher are normal according to the user manual.
3. **Devices:** Ensure picture can be shown normally when directly connecting a source a display device.
4. **Cable:** Plug the HDMI/Cat X cable in and out or connect a different HDMI/Cat X cable. Ensure the specific cable length is within the available transmission range according to the Specifications Section.
5. **Compatibility:** Test other source and display devices to determine correct compatibility.

API Command Set

NetLinx Commands

Device Port Name and Port Number:

Model name	Port name	Port No.
VPX-1701	VGA IN 1 (Audio in 1)	1
	VGA IN2 (Audio in2)	2
	HDMI IN 3	3
	HDMI IN 4	4
	HDMI IN 5	5
	HDMI IN 6	6
	HDMI IN 7	7
	HDMI OUT	1
	Audio out	1
	HDBT OUT	1
	HOST	10
	RS232	9
	IR	11
	Contact IN	22
	Tally Out	23

NetLinx Command List Instructions (cont.)

No.	Function Description	Syntax	Example
1	VIDIN_AUTO_SELECT To set the Auto Switch On/Off	Command: SEND_COMMAND <DEV>,"VIDIN_AUTO_SELECT-<ENABLE DISABLE>" Return: VIDIN_AUTO_SELECT-<ENABLE DISABLE>	Command: SEND_COMMAND <DEV>,"VIDIN_AUTO_SELECT-DISABLE" Return: VIDIN_AUTO_SELECT-DISABLE Description: Set Auto Switch Status off.
2	?VIDIN_AUTO_SELECT To verify the Auto Switch Status	Command: SEND_COMMAND <DEV>,"?VIDIN_AUTO_SELECT" Return: VIDIN_AUTO_SELECT-<ENABLE DISABLE>	Command: SEND_COMMAND SWITCHER,"?VIDIN_AUTO_SELECT" Return: VIDIN_AUTO_SELECT-ENABLE Description: Get Auto Switch Status. The Auto Switch Status is on.
3	FP_LOCKOUT To set Key Lock On/Off	Command: SEND_COMMAND <DEV>,"FP_LOCKOUT-<ENABLE DISABLE>" Return: FP_LOCKOUT-<ENABLE DISABLE>	Command: SEND_COMMAND <DEV>,"FP_LOCKOUT-DISABLE" Return: FP_LOCKOUT-DISABLE Description: Set Key Lock off.
4	?FP_LOCKOUT To verify the Key Lock Status	Command: SEND_COMMAND <DEV>,"?FP_LOCKOUT" Return: FP_LOCKOUT-<ENABLE DISABLE>	Command: SEND_COMMAND SWITCHER,"?FP_LOCKOUT" Return: FP_LOCKOUT-ENABLE Description: Get Key Lock status. The Key Lock status is on.
5	CI<input>O<output> To execute a switch	Command: SEND_COMMAND <DEV>,"CI<input>O<output>" Return: SWITCH-I<input>,OALL Description: <input> //{ 1: VGA IN1; 2: VGA IN2; 3: HDMIIN1; 4: HDMIIN2; 5: HDMIIN3; 6: HDMIIN4; 7: HDMIIN5; } O#: # = {ALL}	Command: SEND_COMMAND SWITCHER,"CI2OALL" Return: SWITCH-I2,OALL Description: Switch HDMI IN1 to all outputs.
6	?INPUT To verify switch status	Command: SEND_COMMAND <DEV>,"?INPUT" Return: SWITCH-L<sl>I<input>O<output> Description: <sl> : {ALL}. <input> //{ 1: VGA IN1; 2: VGA IN2; 3: HDMIIN1; 4: HDMIIN2; 5: HDMIIN3; 6: HDMIIN4; 7: HDMIIN5; }	Command: SEND_COMMAND SWITCHER,"?INPUT" Return: SWITCH-ALL,I1,OALL. Description: HDMI IN1 routes to all outputs.

NetLinx Command List Instructions (cont.)

No.	Function Description	Syntax	Example
7	?VIDIN_STATUS To verify Input signal status	<p>Command: SEND_COMMAND <DEV>,""?VIDIN_STATUS-<input>"</p> <p>Return: VIDIN_STATUS-<status string></p> <p>Description: input port //{ VGA IN1; VGA IN2; HDMI IN1; HDMI IN2; HDMI IN3; HDMI IN4; HDMI IN5; } <status string> { NO SIGNAL; VALID SIGNAL; }</p>	<p>Command: SEND_COMMAND VIDEO_INPUT_1,""?VIDIN_STATUS"</p> <p>Return: VIDIN_STATUS-NO SIGNAL</p> <p>Description: VGA IN Input has no signal.</p>
8	CEC_DISP_POWER To execute a display control on/off	<p>Command: SEND_COMMAND <DEV>,"CEC_DISP_POWER-<ON OFF>"</p> <p>Return: CEC_DISP_POWER-<ON OFF></p>	<p>Command: SEND_COMMAND <DEV>,"CEC_DISP_POWER-OFF"</p> <p>Return: CEC_DISP_POWER-OFF</p> <p>Description: Execute a display control off.</p>
9	CEC_DISP_AUTO To define the display control automatically	<p>Command: SEND_COMMAND <DEV>,"CEC_DISP_AUTO-<ON OFF>"</p> <p>Return: CEC_DISP_AUTO-<ON OFF></p>	<p>Command: SEND_COMMAND <DEV>,"CEC_DISP_AUTO-OFF"</p> <p>Return: CEC_DISP_AUTO-OFF</p> <p>Description: Define the display control automatically off.</p>
10	?CEC_DISP_AUTO To verify the display control Status	<p>Command: SEND_COMMAND <DEV>,""?CEC_DISP_AUTO"</p> <p>Return: CEC_DISP_AUTO-<ON OFF></p>	<p>Command: SEND_COMMAND SWITCHER,""?CEC_DISP_AUTO"</p> <p>Return: CEC_DISP_AUTO-ON</p> <p>Description: Get the display control Status. The display control Status is on.</p>
11	CEC_SLEEP_TIMEOUT To define a Delay Time to control the display off when on active signal	<p>Command: SEND_COMMAND <DEV>,"CEC_SLEEP_TIMEOUT-<time>"</p> <p>Return: CEC_SLEEP_TIMEOUT-<time></p> <p>Description: time: {1 ~ 30}</p>	<p>Command: SEND_COMMAND <DEV>,"CEC_SLEEP_TIMEOUT-5"</p> <p>Return: CEC_SLEEP_TIMEOUT-5</p> <p>Description: Set Delay Time as 5 Minutes.</p>
12	?CEC_SLEEP_TIMEOUT To verify Delay Time to control the display off when on active signal	<p>Command: SEND_COMMAND <DEV>,""?CEC_SLEEP_TIMEOUT"</p> <p>Return: CEC_SLEEP_TIMEOUT-<time></p> <p>Description: time: {1 ~ 30}</p>	<p>Command: SEND_COMMAND SWITCHER,""?CEC_SLEEP_TIMEOUT"</p> <p>Return: CEC_SLEEP_TIMEOUT-5</p> <p>Description: Get Delay Time to control the display off when on active signal. The Delay Time is 5 Minutes.</p>

NetLinx Command List Instructions (cont.)

No.	Function Description	Syntax	Example
13	VIDIN_PREF_EDID To Set input EDID	<p>Command: SEND_COMMAND <DEV>,"VIDIN_PREF_EDID-<resolution>"</p> <p>Return: NULL</p> <p>Description: Input port: //{ VGA IN1; VGA IN2 HDMI IN1; HDMI IN2; HDMI IN3; HDMI IN4; HDMI IN5; } <resolution> { For VGA Input 1920x1200,60 1920x1080,60 1680x1050,60 1600x900,60 1440x900,60 1360x768,60 1280x768,60 1024x768,60 For HDMI Input 3840x2160,60 3840x2160,30 1920x1080,60 1280x720,60 1920x1200,60 1680x1050,60 1600x1200,60 1600x900,60 1440x900,60 1400x1050,60 1366x768,60 1280x1024,60 1280x960,60 1024x768,60 COPY }</p>	<p>Command: SEND_COMMAND VIDEO_INPUT_2,"VIDIN_PREF_EDID-1920x1200,60"</p> <p>Return: VIDIN_PREF_EDID-1920x1200,60</p> <p>Description: Set fix EDID (1920x1200@60Hz 2CH)</p>

NetLinx Command List Instructions (cont.)

No.	Function Description	Syntax	Example
14	?VIDIN_PREF_EDID To Verify input EDID	<p>Command: SEND_COMMAND <DEV>, ""?VIDIN_PREF_EDID""</p> <p>Return: VIDIN_PREF_EDID-<resolution></p> <p>Description: Input port: //{ VGA IN1; VGA IN2; HDMI IN1; HDMI IN2; HDMI IN3; HDMI IN4; HDMI IN5; } <resolution> { For VGA Input 1920x1200,60 1920x1080,60 1680x1050,60 1600x900,60 1440x900,60 1360x768,60 1280x768,60 1024x768,60 For HDMI Input 3840x2160,60 3840x2160,30 1920x1080,60 1280x720,60 1920x1200,60 1680x1050,60 1600x1200,60 1600x900,60 1440x900,60 1400x1050,60 1366x768,60 1280x1024,60 1280x960,60 1024x768,60 COPY }</p>	<p>Command: SEND_COMMAND VIDEO_INPUT_1, ""?VIDIN_PREF_EDID""</p> <p>Return: VIDIN_PREF_EDID-1920x1200,60</p> <p>Description: the EDID of the Input is fix EDID 1920x1200@60Hz 2CH</p>
15	VIDIN_HDCP To Set Input HDCP Compliant	<p>Command: SEND_COMMAND <DEV>, ""VIDIN_HDCP-<option>""</p> <p>Return: VIDIN_HDCP-<ENABLE DISABLE></p> <p>Description: Input port: //{ HDMI IN1; HDMI IN2; HDMI IN3; HDMI IN4; HDMI IN5; }</p>	<p>Command: SEND_COMMAND VIDEO_INPUT_3, ""VIDIN_HDCP-ENABLE""</p> <p>Return: VIDIN_HDCP-ENABLE</p> <p>Description: Set HDMI IN2 HDCP Compliant.</p>
16	?VIDIN_HDCP To Get Input HDCP Compliant Status	<p>Command: SEND_COMMAND <DEV>, ""?VIDIN_HDCP""</p> <p>Return: VIDIN_HDCP-<ENABLE DISABLE></p> <p>Description: Input port: //{ HDMI IN1; HDMI IN2; HDMI IN3; HDMI IN4; HDMI IN5; }</p>	<p>Command: SEND_COMMAND VIDEO_INPUT_3, ""?VIDIN_HDCP""</p> <p>Return: VIDIN_HDCP-ENABLE</p> <p>Description: HDMI IN2 HDCP Compliant.</p>

NetLinx Command List Instructions (cont.)

No.	Function Description	Syntax	Example
17	VIDOUT_RES_REF To set output resolution	<p>Command: SEND_COMMAND <DEV>,"VIDOUT_RES_REF-<horizontal>x<vertical>,<refresh-rate>"</p> <p>Return: NULL</p> <p>Description: Variables: horizontal = An integer value representing the horizontal. vertical = An integer value representing the vertical. May have an additional qualifier such as 'i' or 'p'. refresh-rate = An integer value representing the refresh rate.</p> <pre>{ 4096x2160,60 4096x2160,30 4096x2160,25 4096x2160,24 3840x2160,60 3840x2160,50 3840x2160,30 3840x2160,25 3840x2160,24 1920x1200,60 1920x1080,60 1920x1080,50 1280x720,60 1280x720,50 1680x1050,60 1600x1200,60 1600x900,60 1440x900,60 1366x768,60 1360x768,60 1280x1024,60 1280x960,60 1280x800,60 1280x768,60 1024x768,60 800x600,60 }</pre>	<p>Command: SEND_COMMAND VIDEO_OUTPUT_1,"VIDOUT_RES_REF-1280x1024,60"</p> <p>Return: VIDOUT_RES_REF-1280x1024,60</p> <p>Description: Set HDMI out resolution as 1280x1024@60.</p>
18	?VIDOUT_RES_REF To get output resolution	<p>Command: SEND_COMMAND <DEV>,"?VIDOUT_RES_REF"</p> <p>Return: VIDOUT_RES_REF-<horizontal>x<vertical>,<refresh-rate></p> <p>Description: <horizontal>x<vertical>,<refresh-rate></p> <pre>{ 4096x2160,60 4096x2160,30 ... 1024x768,60 800x600,60 }</pre>	<p>Command: SEND_COMMAND VIDEO_OUTPUT_1,"?VIDOUT_RES_REF"</p> <p>Return: VIDOUT_RES_REF-3840x2160,60</p> <p>Description: HDMI out resolution is 3840x2160@60.</p>
19	REBOOT To cause a warm reboot	<p>Command: SEND_COMMAND <DEV>,"REBOOT"</p> <p>Return: REBOOT</p> <p>Description: Cause a warm reboot.</p>	<p>Command: SEND_COMMAND 5002:1:0,"REBOOT"</p> <p>Return: SEND_COMMAND 5002:1:0,"REBOOT"</p> <p>Description: Cause a warm reboot.</p>

NetLinx Command List Instructions (cont.)

No.	Function Description	Syntax	Example
20	?FWVERSION To determine the system's Application Code version	Command: SEND_COMMAND <DEV>,""?FWVERSION" Return: FWVERSION <version-string>	Command: SEND_COMMAND dvRX,""?FWVERSION" Return: FWVERSION-SCALER_V1.05 FWVERSION-STM32_V1.4
21	VIDOUT_SCALE Set the scaling mode for the video output port	Command: SEND_COMMAND <DEV>,"VIDOUT_SCALE-<AUTO MANUAL>" Return: VIDOUT_SCALE-<AUTO MANUAL>	Command: SEND_COMMAND VIDEO_OUTPUT_1,"VIDOUT_SCALE-AUTO" Return: VIDOUT_SCALE-AUTO Description: Set scale mode as auto.
22	?VIDOUT_SCALE Gets the scaling mode for the video output port	Command: SEND_COMMAND <DEV>,""?VIDOUT_SCALE" Return: VIDOUT_SCALE-<AUTO MANUAL>	Command: SEND_COMMAND VIDEO_OUTPUT_1,""?VIDOUT_SCALE" Return: VIDOUT_SCALE-Auto Description: Scale mode is auto.
23	VIDOUT_MUTE Sets the video mute mode for the video output port	Command: SEND_COMMAND <DEV>,"VIDOUT_MUTE-<ENABLE DISABLE>" Return: VIDOUT_MUTE-<ENABLE DISABLE>	Command: SEND_COMMAND SWITCHER,"VIDOUT_MUTE-ENABLE" Return: VIDOUT_MUTE-ENABLE Description: Set Video mute mode as enable.
24	?VIDOUT_MUTE Gets the video mute mode for the video output port	Command: SEND_COMMAND <DEV>,""?VIDOUT_MUTE" Return: VIDOUT_MUTE-<ENABLE DISABLE>	Command: SEND_COMMAND SWITCHER,""?VIDOUT_MUTE" Return: VIDOUT_MUTE-DISABLE Description: Video mute mode is disable.
25	VIDOUT_ON Sets the video on mode for the video output port	Command: SEND_COMMAND <DEV>,"VIDOUT_ON-<ON OFF>" Return: VIDOUT_ON-<ON OFF>	Command: SEND_COMMAND SWITCHER,"VIDOUT_ON-ON" Return: VIDOUT_ON-ON Description: Set Video on mode as on.
26	?VIDOUT_ON Gets the video ON mode for the video output port	Command: SEND_COMMAND <DEV>,""?VIDOUT_ON" Return: VIDOUT_ON-<ON OFF>	Command: SEND_COMMAND SWITCHER,""?VIDOUT_ON" Return: VIDOUT_ON-OFF Description: Video on mode is disable.
27	VIDOUT_RGB Sets the video color space for the video output port	Command: SEND_COMMAND <DEV>,"VIDOUT_RGB-<ENABLE DISABLE>" Return: VIDOUT_RGB-<ENABLE DISABLE>	Command: SEND_COMMAND SWITCHER,"VIDOUT_RGB-ENABLE" Return: VIDOUT_RGB-ENABLE Description: Set Video out color space as RGB.
28	?VIDOUT_RGB Get the video color space for the video output port	Command: SEND_COMMAND <DEV>,""?VIDOUT_RGB" Return: VIDOUT_RGB-<ENABLE DISABLE>	Command: SEND_COMMAND SWITCHER,""?VIDOUT_RGB" Return: VIDOUT_RGB-DISABLE Description: Video out color space is YUV.

NetLinx Command List Instructions (cont.)

No.	Function Description	Syntax	Example
29	AUDOUT_MUTE Set the audio mute mode for the audio output port	Command: SEND_COMMAND <DEV>,"AUDOUT_MUTE-<ENABLE DISABLE>" Return: AUDOUT_MUTE-<ENABLE DISABLE>	Command: SEND_COMMAND dxDev,"AUDOUT_MUTE-DISABLE" Return: AUDOUT_MUTE-DISABLE Description: Set Audio mute mode as disable.
30	?AUDOUT_MUTE Get the audio mute mode for the audio output port	Command: SEND_COMMAND <DEV>,"?AUDOUT_MUTE" Return: AUDOUT_MUTE-<ENABLE DISABLE>	Command: SEND_COMMAND dxDev,"?AUDOUT_MUTE" Return: AUDOUT_MUTE-disable Description: Audio mute mode is disable.
31	AUDOUT_MAXVOL Sets the audio max vol for the audio output port	Command: SEND_COMMAND <DEV>,"AUDOUT_MAXVOL-<value>" Return: AUDOUT_MAXVOL-<value> Description: Variable: <value> = {0~100}	Command: SEND_COMMAND AUDIO_OUTPUT_1,"AUDOUT_MAXVOL-75" Return: AUDOUT_MAXVOL-75 Description: Set Audio max as 75.
32	?AUDOUT_MAXVOL Get the audio max vol for the audio output port	Command: SEND_COMMAND <DEV>,"?AUDOUT_MAXVOL" Return: AUDOUT_MAXVOL-<value> Description: <value> = {0~100}	Command: SEND_COMMAND AUDIO_OUTPUT_1,"?AUDOUT_MAXVOL" Return: AUDOUT_MAXVOL-<100> Description: Audio max is 100.
33	AUDOUT_MINVOL Set the audio min vol for the audio output port	Command: SEND_COMMAND <DEV>,"AUDOUT_MINVOL-<value>" Return: AUDOUT_MINVOL-<value> Description: <value> = {0~100}	Command: SEND_COMMAND AUDIO_OUTPUT_1,"AUDOUT_MINVOL-5" Return: AUDOUT_MINVOL-5 Description: Set Audio min as 5.
34	?AUDOUT_MINVOL Get the audio min vol for the audio output port	Command: SEND_COMMAND <DEV>,"?AUDOUT_MINVOL" Return: AUDOUT_MINVOL-<value> Description: <value> = {0~100}	Command: SEND_COMMAND AUDIO_OUTPUT_1,"?AUDOUT_MINVOL" Return: AUDOUT_MINVOL-0 Description: Audio min is 0.
35	AUDOUT_VOLUME Set the audio vol for the audio output port	Command: SEND_COMMAND <DEV>,"AUDOUT_VOLUME-<VALUE>" Return: AUDOUT_VOLUME-<VALUE> Description: <value> = {0~100}	Command: SEND_COMMAND AUDOUT_VOLUME_1,"AUDOUT_VOLUME-50" Return: AUDOUT_VOLUME-50 Description: Set Audio vol as 50.
36	?AUDOUT_VOLUME Get the audio vol for the audio output port	Command: SEND_COMMAND <DEV>,"?AUDOUT_VOLUME" Return: AUDOUT_VOLUME-<value> Description: <value> = {0~100}	Command: SEND_COMMAND AUDOUT_VOLUME_1,"?AUDOUT_VOLUME" Return: AUDOUT_VOLUME-50 Description: Audio volume is 50.

Telnet/SSH Commands

No.	Command	Description	Example
1	help	Displays all of the supported commands	<pre>>help cpu usage Displays the total CPU usage date Display the current date. get ip Show the IP configuration of this device.</pre>
2	cpu usage	Displays the total CPU usage usage: cpu usage	<pre>>cpu usage CPU usage is 25%</pre>
3	date	Display the current date. Usage: date	<pre>>date The current date is: Thursday, January 1, 1970</pre>
4	get ip	Show the IP configuration of this device.	<pre>>get ip --- Current IP Settings --- Hostname: XXX IP Address: 192.168.2.201 Netmask: 255.255.240.0 DHCP: false</pre>
5	ping	Pings an address. Address may be an IP or URL.	<pre>>ping 192.16.2.203 PING 192.16.2.203 (192.16.2.203): 56 data bytes</pre>
6	reset factory	Resets configuration back to factory defaults.	<pre>>reset factory</pre>
7	set date	Set the current date.	<pre>>set date Usage: set date [day] [month] [year] Arguments: day integer of day of the week between 1 and 31 month integer of month between 1 and 12 year integer value of year later than 1900 Example: set date 01 11 2016</pre>

Telnet/SSH Commands (cont.)

No.	Command	Description	Example
8	set ip	Setup the IP configuration of this device.	<p>>set ip</p> <p>— Enter New Values or just hit Enter to keep current settings —</p> <p>Enter IP Address 192.168.2.201 192.168.2.202 Enter Netmask 255.255.240.0 255.255.255.0</p> <p>— New settings — IP Address 192.168.2.202 Netmask 255.255.255.0</p> <p>Would you like to save the new settings? Y/N -> y</p> <p>New settings were saved.</p>
9	set time	Set the current time.	<p>>set time</p> <p>Usage: set time [hours] [minutes] [seconds]</p> <p>Arguments: hours integer value of hours between 0 and 23 minutes integer value of minutes between 0 and 59 seconds integer value of seconds between 0 and 59</p> <p>Example: set time 13 30 00</p>
10	show mem	Displays the memory usage for all memory types.	<p>>show mem</p> <p>RAM available: 349634560 bytes RAM total: 406167552 bytes</p>
11	time	Display the current time.	<p>>time</p> <p>The current time is: 11:57:09 PM</p>
12	show vs100 stats	Displays DXLink transport information (MSE values, length, etc.).	<p>>show vs100 stats</p> <p>VS100 STATS: 50.</p>
13	echo	Enables/disables echo of typed characters.	<p>>echo</p> <p>Usage: echo [argument]</p> <p>Arguments: on Enable echo of typed characters off Disable echo of typed characters</p> <p>Example: echo on</p>
14	exit	Close this terminal session.	<p>>exit</p>

Telnet/SSH Commands (cont.)

No.	Command	Description	Example
15	msg	Enables/Disables extended diagnostic messages.	<p>>msg</p> <p>Usage: msg [argument]</p> <p>This command allows system logs to be redirected to the terminal session. There are multiple log levels, which are described below.</p> <p>Arguments:</p> <ul style="list-style-type: none"> on Enable default [warning] system log level debug Enable all system debug messages info Enable info system log level warning Enable warning system log level error Enable error system log level off Disable system log output to terminal session <p>Example: msg on</p>
16	reboot	Reboots the device.	>reboot
17	set dns	set DNS service	<p>>set dns</p> <p>--- Enter new values or keep current settings at the prompts ---</p> <p> -- Current DNS #1 -- Change the current value? Y/N -> y Enter DNS #1 192.168.2.1</p> <p> -- Current DNS #2 -- Change the current value? Y/N -> Y Enter DNS #2 192.168.3.1</p> <p>Would you like to save the new settings? Y/N -> Y</p> <p>New settings were saved...</p>
18	dns list	Display the current dns.	<p>>dns list</p> <p>Domain Name: amx.com</p> <p>DNS List: DNS #1: 192.168.2.1 DNS #2: 8.8.8.8</p>
19	set friendlyname	set friendlyname	<p>>set friendlyname</p> <p>Please input friendlyname:</p> <p>Old friendlyname: New friendlyname: 111 Would you like to save this setting(Y/N) y Setting is ok , you should reboot that make it effective</p>

Telnet/SSH Commands (cont.)

No.	Command	Description	Example
20	set location	it's setting location.	<pre>>set location Please input location: Old location: New location: 333 Would you like to save this setting(Y/N) y Setting is ok , you should reboot that make it effective</pre>
21	set connection	Set the controller connection settings.	<pre>>set connection --- Enter New Values or just hit Enter to keep current settings --- Enter Mode Type T for TCP/URL, U for UDP/URL, N for NDP or A for Auto and then Enter: Icsp_Auto A Enter Controller System Number: 1 1 --- New settings --- System Number 1 Controller Port 1319 Is this correct? Type Y or N and Enter -> Y Changed && Saved</pre>
22	get connection	get the controller connection settings.	<pre>>get connection Connection Mode: Icsp_Auto System Number: 1 Controller Ip/URL Controller Port: 1319</pre>
23	set telnet username	set telnet service login username	<pre>>set telnet username Enter Telnet new username 123 Would you like to set this username (y/n) y (please set telnet password) Changed && Saved</pre>
24	set telnet password	set telnet service login password	<pre>>set telnet password Enter Telnet new password 456 Would you like to set this password (y/n) y Changed && Saved</pre>
25	set ssh username	set ssh service login username	<pre>>set ssh username Enter ssh new username admin admin Would you like to set this username (y/n) y Changed && Saved (you should reboot this device that make your setting active)</pre>
26	set ssh password	set ssh service login password	<pre>>set ssh password Enter ssh new password password pass Would you like to set this password (y/n) y Changed && Saved (you should reboot this device that make your setting active)</pre>

Telnet/SSH Commands (cont.)

No.	Command	Description	Example
27	report firmware	Display version information for stored firmware installation files.	>report firmware --- FWVERSION-SCALER_V5.8 --- --- FWVERSION-STM32_V3.3 VS_V7.3.6 IN3_V2.3 IN4_V2.3 IN5_V2.3 IN6_V2.3 IN7_V2.3 OUT_V3.1 ---
28	set audout maxvol	set the device audio output max volume.	>set audout maxvol --- Max Volume of Audio Output between 0 and 100 : 80
29	get audout maxvol	get audio output max volume of this device	>get audout maxvol --- Current Max Volume of Audio Output: 80 ---
30	set audout minvol	set the device audio output minimum volume.	>set audout minvol --- Minimum Volume of Audio Output between 0 and 100 : 20
31	get audout minvol	get audio output minimum volume of this device	>get audout minvol --- Current Minimum Volume of Audio Output: 20 ---
32	set audout mute	set the device audio output mute mode.	>set audout mute --- Audio Output Mute Mode Setting(Type Y for ON, N for OFF) : n
33	set audout mute #param	set the device audio output mute mode. #param: Y for ON, N for OFF	>set audout mute Y
34	get audout mute	get audio output mute mode of this device	>get audout mute --- Current Mute Mode of Audio Output: OFF ---
35	set audout vol	set the device audio output volume.	>set audout vol --- Volume of Audio Output between 0 and 100 : 50
36	set audout vol #param	set the device audio output volume. #param: Volume of Audio Output between 0 and 100	>set audout vol 50
37	get audout vol	get audio output volume of this device	>get audout vol --- Current Volume of Audio Output: 50 ---
38	set auto switch	set the device auto switch mode.	>set auto switch --- Auto Switch Setting(Type Y for ON, N for OFF) : y
39	set auto switch #param	set the device auto switch mode. #param: Y for ON, N for OFF	>set auto switch Y
40	get auto switch	get auto switch mode of this device	>get auto switch --- Current Auto Switch Mode: ON ---
41	set cec auto	set the device cec auto mode.	>set cec auto --- CEC Auto Setting(Y for ON, N for OFF) : y

Telnet/SSH Commands (cont.)

No.	Command	Description	Example
42	set cec auto #param	set the device cec auto mode. #param: Y for ON, N for OFF	>set cec auto Y
43	get cec auto	get cec auto mode of this device	>get cec auto --- Current CEC Auto Mode: ON ---
44	set cec control	set the device display power on/off.	>set cec control --- Display Power Setting(Type Y for ON, N for OFF) : y
45	set cec control #param	set the device display power on/off. #param: Y for ON, N for OFF	>set cec control Y
46	set cec delay	set the delay time to control the display off when on active signal.	>set cec delay --- integer of Delay Time in Minutes between 1 and 30 : 2
47	set cec delay #param	set the delay time to control the display off when on active signal. #param: integer of Delay Time in Minutes between 1 and 30	>set cec delay 2
48	get cec delay	get the delay time to control the display off when on active signal	>get cec delay --- Current Delay Time in Minutes: 2 ---
49	set key lock	set the device key lock.	>set key lock --- Key Lock Setting(Type Y for ON, N for OFF) : y
50	set key lock #param	set the device key lock. #param: Y for ON, N for OFF	>set key lock Y
51	get key lock	get key lock mode of this device	>get key lock --- Current Key Lock Mode: ON ---
52	set vidin edid	set the device video input edid.	>set vidin edid --- Video Input Port Select(Type 1 for VGA_IN1, 2 for VGA_IN2, 3 for HDMI_IN3, 4 for HDMI_IN4, 5 for HDMI_IN5, 6 for HDMI_IN6, 7 for HDMI_IN7) : 1 --- VGA Input EDID Setting(<horizontal>x<vertical>,<refresh-rate>): --- 1: 1920x1200,60 --- 2: 1920x1080,60 --- 3: 1680x1050,60 --- 4: 1600x900,60 --- 5: 1440x900,60 --- 6: 1360x768,60 --- 7: 1280x768,60 --- 8: 1024x768,60 --- 3

Telnet/SSH Commands (cont.)

No.	Command	Description	Example
53	set vidin edid #param1 #param2	set the device video input edid. #param1:Video Input Port Select(Type 1 for VGA_IN1, 2 for VGA_IN2, 3 for HDMI_IN3, 4 for HDMI_IN4, 5 for HDMI_IN5, 6 for HDMI_IN6, 7 for HDMI_IN7) #param2:VGA Input EDID Setting(<horizontal>x<vertical>,<refresh-rate>): — 1: 1920x1200,60 — 2: 1920x1080,60 — 3: 1680x1050,60 — 4: 1600x900,60 — 5: 1440x900,60 — 6: 1360x768,60 — 7: 1280x768,60 — 8: 1024x768,60 or HDMI Input EDID Setting(<horizontal>x<vertical>,<refresh-rate>): — 1: 3840x2160,30 — 2: 1920x1080,60 — 3: 1280x720,60 — 4: 1920x1200,60 — 5: 1680x1050,60 — 6: 1600x1200,60 — 7: 1600x900,60 — 8: 1440x900,60 — 9: 1400x1050,60 — 10: 1366x768,60 — 11: 1280x1024,60 — 12: 1280x960,60 — 13: 1024x768,60 — 14: COPY	>set vidin edid 1 1
54	get vidin edid	get the video input edid of this device	>get vidin edid — Video Input Port Select(Type 1 for VGA_IN1, 2 for VGA_IN2, 3 for HDMI_IN3, 4 for HDMI_IN4, 5 for HDMI_IN5, 6 for HDMI_IN6, 7 for HDMI_IN7) : 3 — Current HDMI Video Input EDID: 3840x2160,60 —
55	set vidin hdcp	set the device video input hdcp mode.	>set vidin hdcp — Video HDMI Input Port Select(Type 3 for IN3, 4 for IN4, 5 for IN5, 6 for IN6, 7 for IN7) : 3 — HDCP Mode Setting(Type 0 for HDCP OFF, 1 for HDCP ON) : 1
56	set vidin hdcp #param1 #param2	set the device video input hdcp mode. #param1: Video HDMI Input Port Select(Type 3 for IN3, 4 for IN4, 5 for IN5, 6 for IN6, 7 for IN7) #param2: HDCP Mode Setting(Type 0 for HDCP OFF, 1 for HDCP ON)	>set vidin hdcp 2 1
57	get vidin hdcp	get video input hdcp mode of this device	>get vidin hdcp — Video HDMI Input Port Select(Type 3 for IN3, 4 for IN4, 5 for IN5, 6 for IN6, 7 for IN7) : 3 — Current HDMI Video In HDCP Mode: HDCP_ON —

Telnet/SSH Commands (cont.)

No.	Command	Description	Example
58	get vidin status	get the video input signal status of this device	>get vidin status --- Video Input Port Select(Type 1 for VGA_IN1, 2 for VGA_IN2, 3 for HDMI_IN3, 4 for HDMI_IN4, 5 for HDMI_IN5, 6 for HDMI_IN6, 7 for HDMI_IN7) : 2 --- Current Video Input Signal Status: VALID SIGNAL -- -
59	set color space	set the device video output color space.	>set color space --- Color Space Setting(Type R for RGB, Y for YUV) : r
60	set color space #param	set the device video output color space. #param: R for RGB, Y for YUV	>set color space r
61	get color space	get video output color space of this device	>get color space --- Current Video Output Color Space: RGB ---
62	set logo pos	set the device video output logo position.	>set logo pos --- LOGO Position Setting(Type C for FIX IN CENTER, TL for DRAG TOP LEFT, TR for DRAG TOP RIGHT, BL for DRAG BOTTOM LEFT, BR for DRAG BOTTOM RIGHT) : c
63	get logo pos	get video output logo position of this device	>get logo pos --- Current Video Output LOGO Position: FIX IN CENTER ---
64	set vidout blank	set the device video output blank.	>set vidout blank --- Video Output Blank Setting(Type B for BLACK, L for LOGO) : l
65	set vidout blank #param	set the device video output blank. #param: B for BLACK, L for LOGO	>set vidout blank l
66	get vidout blank	get video output blank mode of this device	>get vidout blank --- Current Video Output Blank Mode: LOGO ---
67	set vidout hdcp	set the device video output hdcp mode.	>set vidout hdcp --- Video Output Port Select(Type 1 for HDMI, 2 for HDBT) : 1 --- HDCP Mode Setting(Type 0 for HDCP OFF, 1 for HDCP 1.4, 2 for HDCP FOLLOW, 3 for HDCP 2.2) : 2
68	set vidout hdcp #param1 #param2	set the device video output hdcp mode. #param1: Video Output Port Select(Type 1 for HDMI, 2 for HDBT) #param2: HDMI HDCP Mode Setting(Type 0 for HDCP OFF, 1 for HDCP 1.4, 2 for HDCP FOLLOW, 3 for HDCP 2.2) or HDBT HDCP Mode Setting(Type 0 for HDCP OFF, 1 for HDCP ON)	>set vidout hdcp 1 2
69	get vidout hdcp	get video output hdcp mode of this device	>get vidout hdcp --- Video Output Port Select(Type 1 for HDMI, 2 for HDBT) : 1 --- Current HDMI Video Output HDCP Mode: HDCP FOLLOW ---

Telnet/SSH Commands (cont.)

No.	Command	Description	Example
70	set vidout mute	set the device video output mute mode.	>set vidout mute --- Video Output Mute Mode Setting(Type Y for ON, N for OFF) : n
71	set vidout mute #param	set the device video output mute mode. #param: Y for ON, N for OFF	>set vidout mute n
72	get vidout mute	get video output mute mode of this device	>get vidout mute --- Current Video Output Mute Mode: OFF ---
73	set vidout scale	set the device video output scale mode.	>set vidout scale --- Video Output Scale Mode Setting(Type M for MANUAL, A for AUTO) : a
74	set vidout scale #param	set the device video output scale mode. #param: M for MANUAL, A for AUTO	>set vidout scale a
75	get vidout scale	get video output scale mode of this device	>get vidout scale --- Current Video Output Scale Mode: AUTO ---
76	set vidout res	set the device video output resolution.	>set vidout res --- Video Output Resolution Setting(<horizontal>x<vertical>,<refresh-rate>): --- 1: 4096x2160,60 --- 2: 4096x2160,30 --- 3: 4096x2160,25 --- 4: 4096x2160,24 --- 5: 3840x2160,60 --- 6: 3840x2160,50 --- 7: 3840x2160,30 --- 8: 3840x2160,25 --- 9: 3840x2160,24 --- 10: 1920x1200,60 --- 11: 1920x1080,60 --- 12: 1920x1080,50 --- 13: 1280x720,60 --- 14: 1280x720,50 --- 15: 1680x1050,60 --- 16: 1600x1200,60 --- 17: 1600x900,60 --- 18: 1440x900,60 --- 19: 1366x768,60 --- 20: 1360x768,60 --- 21: 1280x1024,60 --- 22: 1280x960,60 --- 23: 1280x800,60 --- 24: 1280x768,60 --- 25: 1024x768,60 --- 26: 800x600,60 --- 11

Telnet/SSH Commands (cont.)

No.	Command	Description	Example
77	set vidout res #param	set the device video output resolution. #param: Video Output Resolution Setting(<horizontal>x<vertical>,<refresh-rate>): — 1: 4096x2160,60 — 2: 4096x2160,30 — 3: 4096x2160,25 — 4: 4096x2160,24 — 5: 3840x2160,60 — 6: 3840x2160,50 — 7: 3840x2160,30 — 8: 3840x2160,25 — 9: 3840x2160,24 — 10: 1920x1200,60 — 11: 1920x1080,60 — 12: 1920x1080,50 — 13: 1280x720,60 — 14: 1280x720,50 — 15: 1680x1050,60 — 16: 1600x1200,60 — 17: 1600x900,60 — 18: 1440x900,60 — 19: 1366x768,60 — 20: 1360x768,60 — 21: 1280x1024,60 — 22: 1280x960,60 — 23: 1280x800,60 — 24: 1280x768,60 — 25: 1024x768,60 — 26: 800x600,60	>set vidout res 11
78	get vidout res	get video output resolution of this device	>get vidout res — Current Video Output Resolution: FIX 1920x1080,60 —
79	switch video input	execute a switch video input to all output.	>switch video input — Video Input Port Select(Type 1 for VGA_IN1, 2 for VGA_IN2, 3 for HDMI_IN3, 4 for HDMI_IN4, 5 for HDMI_IN5, 6 for HDMI_IN6, 7 for HDMI_IN7) : 2
80	switch video input #param	execute a switch video input to all output. #param: 1 for VGA_IN1, 2 for HDMI_IN2, 3 for HDMI_IN3, 4 for HDMI_IN4	>switch video input 2
81	get switch channel	get video output logo position of this device	>get switch channel — Current Video Input Channel: HDMI_IN2 —
82	set vidout on	set the device video output on/off.	>set vidout on — Video Output On/Off Setting(Type Y for ON, N for OFF) : y
83	set vidout on #param	set the device video output on/off. #param: Y for ON, N for OFF	>set vidout on y
84	get vidout on	get video output on/off mode of this device.	>get vidout on — Current Video Output On/Off Mode: ON —



About AMX by HARMAN

Founded in 1982 and acquired by HARMAN in 2014, AMX® is dedicated to providing AV solutions for an IT World. AMX solves the complexity of managing technology with reliable, consistent and scalable systems comprising control, video switching and distribution, digital signage and technology management. AMX systems are deployed worldwide in conference rooms, classrooms, network operation/command centers, homes, hotels, entertainment venues and broadcast facilities, among others. AMX is part of the HARMAN Professional Group, the only total audio, video, lighting, and control vendor in the professional AV market. HARMAN designs, manufactures and markets premier audio, video, infotainment and integrated control solutions for the automotive, consumer and professional markets.

©2021 Harman. All rights reserved. Specifications subject to change.

www.amx.com | +1.469.624.7400 | 800.222.0193