

Sound Bar
HT-A3000



Use this Help Guide when you have any questions on how to use the speaker system.

Getting Started

[About Manuals of the Speaker System](#)

[What You Can Do with the Speaker System](#)

Guide to Parts and Controls

[Bar Speaker](#)

[Remote Control](#)

[Using the Home Menu](#)

Setting Up

Installing the Speaker System

[Installing the Bar Speaker](#)

[Mounting the Bar Speaker on a Wall](#)

Connecting to a TV

[Connecting a TV Compatible with ARC/eARC](#)

[Connecting a TV That Is not Compatible with ARC/eARC](#)

[When Your TV Has the S-CENTER SPEAKER IN Jack](#)

[Connecting to the AC Outlet \(mains\)](#)

[Performing Initial Settings](#)

Connecting the Optional Speaker

[Connecting the Optional Speaker with the Manual Connection](#)

[If Wireless Transmission Is Unstable](#)

[When the TV Remote Control Does not Work](#)

Watching Images

[Watching TV](#)

Listening to Music/Sound

Listening to Sony TV Sound with the BLUETOOTH® Function

[What You Can Do by Connecting a TV with the BLUETOOTH® Function](#)

[Listening to TV Sound by Connecting the Speaker System and TV Wirelessly](#)

[Listening to Sound of the Paired TV](#)

Listening to Music/Sound with the BLUETOOTH® Function

[Listening to Music by Pairing the Mobile Device That Is Connected for the First Time](#)

[Listening to Music from the Paired Device](#)

[Listening to Music on a USB Device](#)

Listening to Sound of the Connected TV or Device Using Headphones

[Listening to Sound by Pairing with Headphones](#)

[Listening to Sound with Paired Headphones](#)

[About the Connection of the Headphones](#)

Listening to Music by Connecting to a Network

[What You Can Do by Connecting the Speaker System to a Network](#)

[Notes on Connecting to the Internet](#)

Connecting to a Wireless Network

[Setting Up a Wireless Network Connection on the Home Menu](#)

[Setting Up a Wireless Network Connection Using Sony | Music Center](#)

[Setting Up a Wi-Fi Connection Using an iOS Device](#)

Playing music from Amazon Music

[Prerequisite: Making the Initial Settings for Alexa with Sony | Music Center](#)

[Audio Formats Available for Playback by Audio Casting Protocol](#)

[Playing Music with the Amazon Music App](#)

[Operating the Speaker System by Talking to an Alexa Built-in Device](#)

[Playing Music with the TIDAL App](#)

Playing Music from Other Streaming Services

[Prerequisite: Making the Initial Settings for Chromecast built-in](#)

[Playing Music with Apps Compatible with Other Streaming Services](#)

[Using Spotify](#)

[Using AirPlay](#)

[Using Sony | Music Center](#)

[Listening to Music on Your PC via a Home Network](#)

Adjusting the Volume and Sound Quality

[Adjusting the Volume](#)

[Enjoying Surround Effect \(SOUND FIELD\)](#)

[Making Dialogs Clearer \(VOICE\)](#)

[Enjoying Clear Sound with Low Volume at Midnight \(NIGHT\)](#)

[Adjusting the Delay Between the Picture and Sound](#)

[Enjoying Multiplex Broadcast Sound \(AUDIO\)](#)

[Adjusting the Dialog Volume While the DTS:X Content is Played Back](#)

Using the Speaker System by Interlocking with a TV

[Operating the Speaker System by Interlocking with a TV \(Control for HDMI Function\)](#)

[Operating the Speaker System by Interlocking with a TV Compatible with the "BRAVIA" Sync Function](#)

Changing the Settings

[Changing the Brightness of the Front Panel Display and Indicators \(DIMMER\)](#)

[Saving Power in Standby Mode](#)

[Performing Easy Setup](#)

Performing Advanced Settings

[Using the \[Advanced Settings\] Menu](#)

[\[Speaker Settings\]](#)

[\[Audio Settings\]](#)

[\[HDMI Settings\]](#)

[\[Bluetooth Settings\]](#)

[\[System Settings\]](#)

[\[Network Settings\]](#)

[\[Resetting\]](#)

[\[Software Update\]](#)

[Updating the Software](#)

Troubleshooting

[Troubleshooting](#)

Power

[The speaker system does not power up.](#)

[The speaker system does not turn on even when the TV is turned on.](#)

[The speaker system turns off when the TV is turned off.](#)

[The speaker system does not turn off even when the TV is turned off.](#)

[The speaker system cannot be turned off.](#)

Picture

[There is no picture or the picture is not output correctly.](#)

[The picture on the TV screen is distorted.](#)

Sound

[The speaker system cannot connect to a TV with the BLUETOOTH function.](#)

[No TV sound is output from the speaker system.](#)

[The sound is output from both the speaker system and TV.](#)

[The TV sound from this speaker system lags behind the image.](#)

[No sound or only a very low-level sound of the device connected to the speaker system is heard.](#)

[The surround effect cannot be obtained.](#)

[No sound is output from the optional rear speakers/subwoofer.](#)

[Sound is not output from some speakers.](#)

Sound Field Optimization

[Sound Field Optimization failed.](#)

USB Device Connection

[The USB device is not recognized.](#)

Mobile Device Connection

[Pairing cannot be achieved.](#)

[BLUETOOTH connection cannot be completed.](#)

[Sound of the connected BLUETOOTH mobile device is not output from the speaker system.](#)

Headphones Connection with the BLUETOOTH Function

[Pairing cannot be achieved.](#)

[BLUETOOTH connection cannot be completed.](#)

[No sound is output from the connected BLUETOOTH headphones.](#)

[The BLUETOOTH connection with the headphones becomes disconnected.](#)

Wireless LAN Connection

[The speaker system cannot connect to the network, or the network connection is unstable.](#)

[The wireless LAN router you want is not shown in the wireless network list.](#)

Internet Connection

[You cannot connect the speaker system to the Internet.](#)

Remote Control

[The remote control of this speaker system does not function.](#)

[TV remote control does not work.](#)

Optional Speakers

[No sound or only a very low-level sound is heard from the optional speaker.](#)

[Sound skips or has noise.](#)

Others

[The Control for HDMI function does not work properly.](#)

[\[PRTCT\] flashes in the front panel display for 5 seconds and the speaker system is turned off.](#)

[\[PRTCT\], \[PUSH\], speaker name \(\[SUB\], \[RL\], or \[RR\]\), and \[POWER\] flash alternately in the front panel display.](#)

[\[HIGH\]](#), [\[TEMP\]](#), and [\[ERROR\]](#) appear alternately for 2 seconds each in the front panel display, [\[STANDBY\]](#) appears in the front panel display, then the speaker system is turned off.

[\[BT TX\]](#) appears in the front panel display.

[Sensors of the TV do not work properly.](#)

[Wireless functions \(wireless LAN, the BLUETOOTH function, or optional subwoofer/rear speakers\) are unstable.](#)

[Music that you are not familiar with suddenly plays.](#)

[The speaker system cannot be turned off or \[Advanced Settings\] cannot be used./When pressing the power button, \[DEMO\] appears in the front panel display and the speaker system cannot be turned off.](#)

[Spotify cannot be played with the MUSIC SERVICE button, or cannot be played on the way of playback.](#)

[The speaker system restarts.](#)

[Resetting the Speaker System](#)

Additional Information

[Playable Types of Audio Files](#)

[Supported Input Audio Formats](#)

[On BLUETOOTH® Communication](#)

[Copyrights and Trademarks](#)

Sound Bar
HT-A3000

About Manuals of the Speaker System

The information included in each manual is as shown below.

Startup Guide



Introduces the initial procedures concerning installation and connection for using the speaker system, and operations until you play music.

Operating Instructions



Explains the basic operations.

- Connection with a TV
- Playback for music/sound of devices connected with an HDMI cable or the BLUETOOTH function
- Sound adjustment, etc.

Help Guide (Web manual) (this document)



Provides all operations including advanced usage.

- Playback for music/sound with the network function
- Details on menu items, etc.

Hint

- The instructions in these manuals describe operations using the controls on the remote control. You can use the buttons on the bar speaker if they have the same or similar names as those on the remote control.
- Characters in brackets [] appear on the TV screen or front panel display.
- Details are omitted from the illustrations.

Sound Bar
HT-A3000

What You Can Do with the Speaker System

The speaker system supports object-based audio formats such as Dolby Atmos and DTS:X.

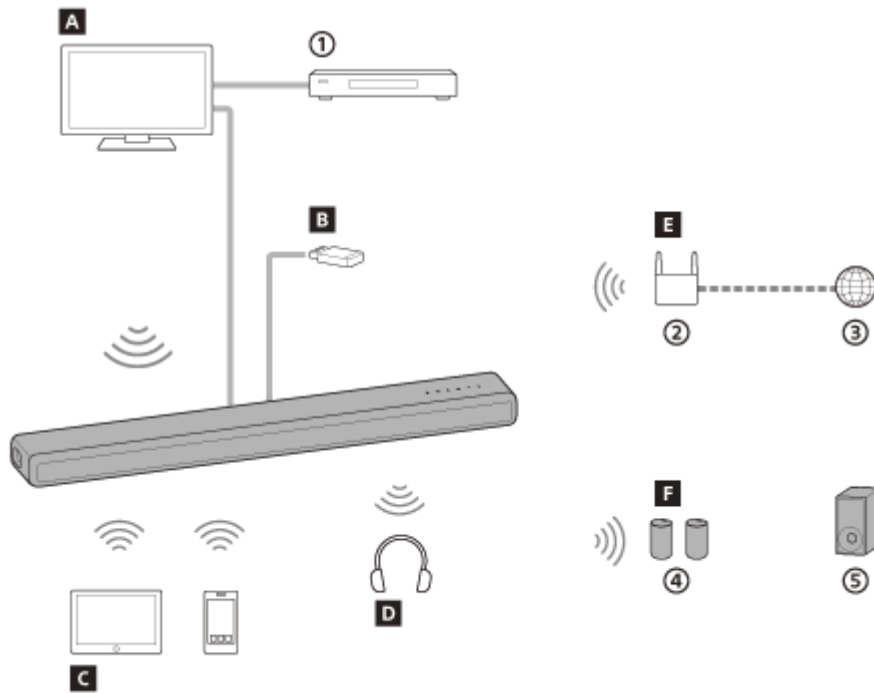

- ① Blu-ray Disc™ player, set-top box, gaming console, etc.
- ② Wireless LAN router
- ③ Internet
- ④ Optional rear speakers
- ⑤ Optional subwoofer

A TV

You can listen to sound of a TV with the speaker system by connecting the speaker system and TV with an HDMI cable or BLUETOOTH function.

[Watching TV](#)

[What You Can Do by Connecting a TV with the BLUETOOTH® Function](#)

B USB device

You can play music files stored on a USB device with the speaker system by connecting the USB device to the  (USB) port of the speaker system.

[Listening to Music on a USB Device](#)

C Mobile device

You can listen to sound of a mobile device with the speaker system by connecting the speaker system and mobile device with the BLUETOOTH function.

[Listening to Music by Pairing the Mobile Device That Is Connected for the First Time](#)

D Headphones

You can listen to sound of the connected TV from headphones by connecting the speaker system and headphones with the BLUETOOTH function.

[Listening to Sound by Pairing with Headphones](#)

E Network

You can perform streaming playback of music content or play music files stored on your PC with the speaker system by connecting the speaker system to the same network as that of the smartphone, tablet, or iOS device.

[What You Can Do by Connecting the Speaker System to a Network](#)

F Optional speakers

For the operations of the optional rear speakers and subwoofer, refer to their operating instructions.

For the supported optional speakers, confirm on the Sony website.

Bar Speaker

Front

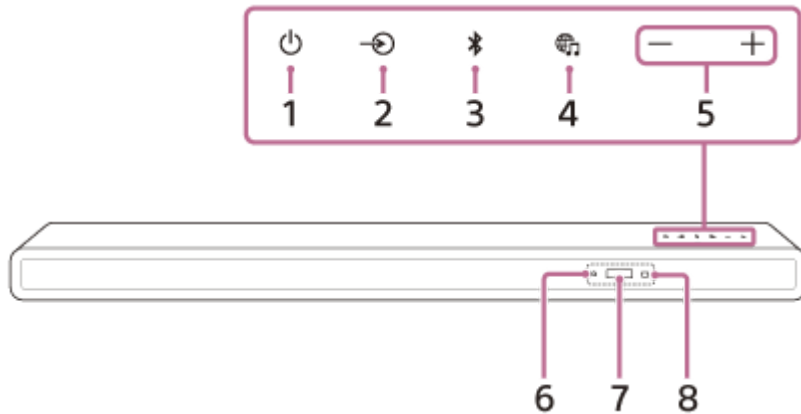

1. **⏻ (power) button**
Turns on the speaker system or sets it to standby mode.
2. **↻ (input select) button**
Selects the input for playback on the speaker system.
3. **📶 (BLUETOOTH) button**
4. **🎵 (MUSIC SERVICE) button**
If you have previously played music on Spotify on the speaker system, you can resume playback by pressing this button.
This button may not be available in some countries/regions.
5. **+/- (volume) buttons**
6. **BLUETOOTH indicator**
 - Flashes quickly in blue: During pairing standby status
 - Flashes in blue: BLUETOOTH connection is being attempted.
 - Lights in blue: BLUETOOTH connection has been established.
7. **Front panel display**
8. **Remote control sensor**
Point the remote control at the remote control sensor to operate the speaker system.

Rear

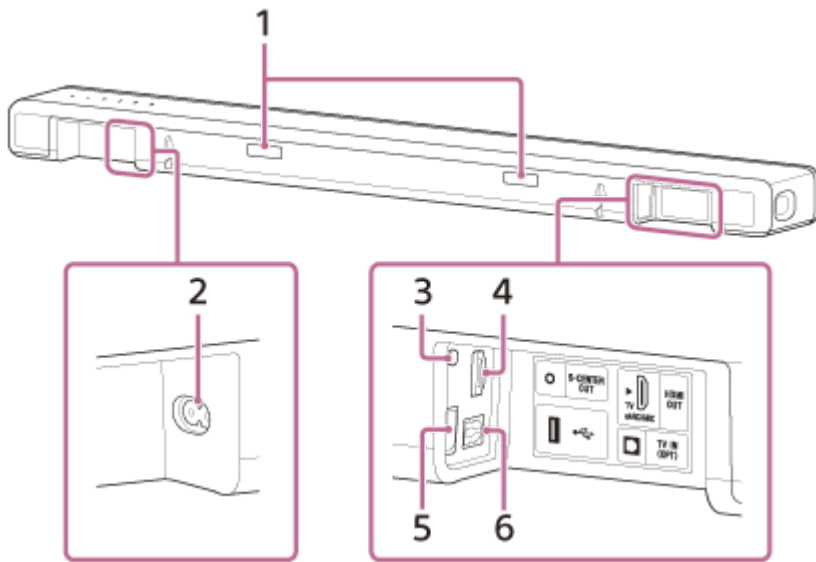

1. IR repeater

Transmits the remote signal of the TV remote control to the TV.

2. AC inlet

3. S-CENTER OUT jack

4. HDMI OUT (TV eARC/ARC) jack

Connect a TV that has an HDMI input jack with an HDMI cable. The speaker system is compatible with eARC and ARC. ARC is the function that sends TV sound to an AV device such as the speaker system from the TV's HDMI jack. eARC is an extension of ARC and enables transmission of the object audio and multi-channel LPCM content that cannot be transmitted with ARC.

5. USB (USB) port

6. TV IN (OPT) jack

Related Topic

- [When Your TV Has the S-CENTER SPEAKER IN Jack](#)

Remote Control

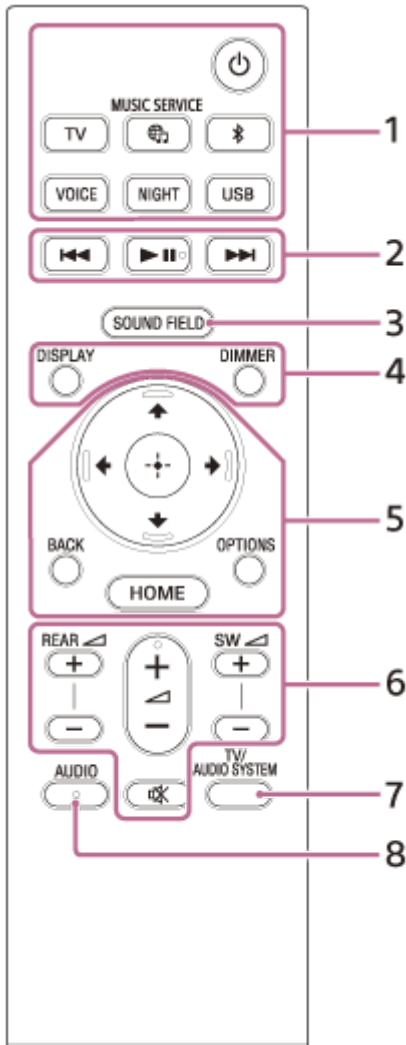

1. (power)

Turns on the speaker system or sets it to standby mode.

TV

(MUSIC SERVICE)

If you have previously played music on Spotify on the speaker system, you can resume playback by pressing this button.

This button may not be available in some countries/regions.

(BLUETOOTH)

VOICE

NIGHT

USB

2. Playback operation buttons

(previous)/ (next)

Selects the previous/next track or file.

Pressing and holding it searches backward or forward (rewind/fast forward) during playback.

(play/pause)(*)

Starts, pauses, or re-starts playback (resume play).

3. SOUND FIELD

4. DISPLAY

Displays stream information in the front panel display.

DIMMER

5. (up)/ (down)/ (left)/ (right)

 (enter)

BACK

OPTIONS

Displays the options menu in the front panel display.

HOME

6. **REAR** (rear speakers volume) +/-

Adjusts the volume of the optional rear speakers when connecting them.

 (volume) +(*)-

Adjusts the volume.

SW  (subwoofer volume) +/-

Adjusts the volume of the built-in subwoofer or optional subwoofer when connecting it.

 (muting)

Turns off the sound temporarily.



7. TV/AUDIO SYSTEM

Switches the output for the connected TV sound between the TV and speaker system.

Note

- This button works in the following conditions.
 - The connected TV is compatible with the System Audio Control function.
 - The Control for HDMI function of the speaker system is set to on.

8. AUDIO(*)

* The AUDIO, , and  (volume) + buttons have a tactile dot. Use it as a guide during operation.

About the replacement of batteries for the remote control

When the speaker system does not respond by operating with the remote control, replace two batteries with new batteries.

Use R03 or LR03 (size AAA) batteries for replacement.

Related Topic

- [Making Dialogs Clearer \(VOICE\)](#)
- [Enjoying Clear Sound with Low Volume at Midnight \(NIGHT\)](#)
- [Enjoying Surround Effect \(SOUND FIELD\)](#)

Sound Bar
HT-A3000

Using the Home Menu

You can display the home menu on the TV screen by connecting the speaker system and TV with an HDMI cable.

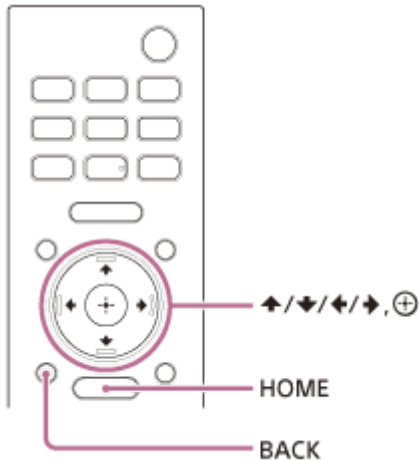

1 Press HOME.

The home menu appears on the TV screen.

2 Press ↑ (up)/ ← (left)/ → (right) to select the category that you want, then press ↓ (down) or ⊕ (enter).

The items for the selected category appear under the category list on the TV screen.

- **[Watch & Listen]:** Selects the input of the TV or audio device that is connected to the speaker system or music service for playing back on the speaker system.
- **[Setup]:** Performs the basic initial settings by using [Easy Setup] or various advanced settings of the speaker system.

3 Press ↑ (up)/ ↓ (down)/ ← (left)/ → (right) to select the item that you want, then press ⊕ (enter).

The selected input or setting display appears on the TV screen.
To return to the previous screen, press BACK.

Sound Bar
HT-A3000

Installing the Bar Speaker

Install the bar speaker in the same location as your TV. The bar speaker can be installed on a shelf, such as a TV stand, or mounted on a wall.

Installing on a shelf/stand

Install the bar speaker in an empty space in front of the TV.

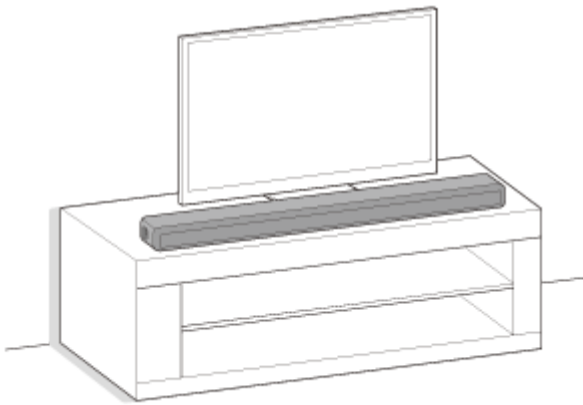

Mounting on a wall

Mount the bar speaker on the wall under the TV.

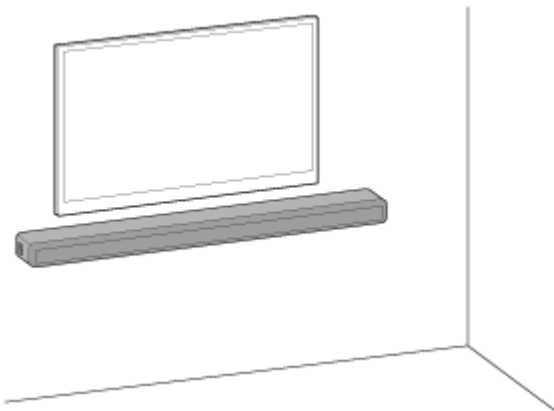

To set up with the optional subwoofer and/or rear speakers

Complete the setup of the speaker system following the Startup Guide. And then connect the optional speakers to the speaker system referring to the operating instructions supplied with the optional speakers.

If the optional speaker cannot connect to the speaker system, resetting the speaker system may solve this problem. For details, see [“Resetting the Speaker System”](#).

When the sound from the optional speakers skips, it may be improved by changing the installation position or setting. For details, see [“No sound is output from the optional rear speakers/subwoofer.”](#)

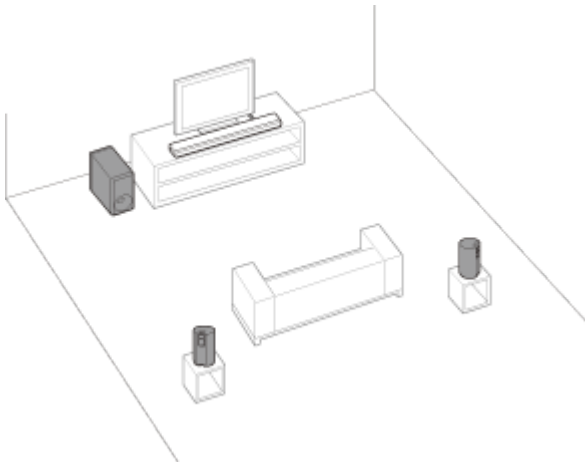

Note

- Before connecting the speaker system, disconnect the AC power cord (mains lead) of the TV from the AC outlet (mains). Reconnect it after connecting the speaker system to a TV.
- Do not place metal objects near the speaker system. Wireless functions may become unstable.
- There are ventilation holes at the rear of the bar speaker. Do not block these holes.

Sound Bar
HT-A3000

Mounting the Bar Speaker on a Wall

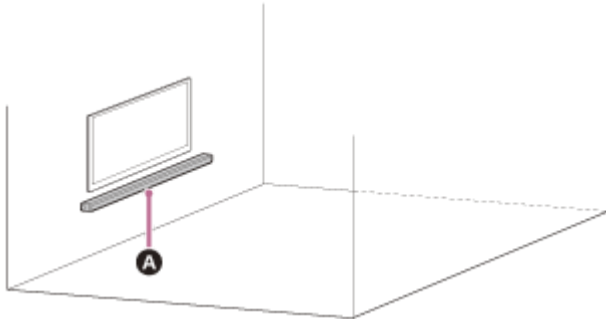

A Bar speaker

Note

- Prepare screws (not supplied) that are suitable for the wall material and stability. Depending on the wall material, the wall may be damaged.
- Fasten the screws securely in the wall beam.
- Hang the bar speaker horizontally on the reinforced wall.
- Have the installation done by a Sony dealer or licensed contractor and pay special attention to safety during the installation.
- Sony shall not be held responsible for accidents or damage caused by improper installation, insufficient wall stability, improper screw installation, natural disasters, etc.
- Two or more persons are required to hang the bar speaker for safety.

1 Prepare two screws (not supplied) that are suitable for the wall mount holes on the rear of the bar speaker.

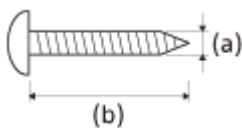

(a) 4 mm (3/16 in)

(b) More than 30 mm (1 3/16 in)

Hole on the rear of the bar speaker

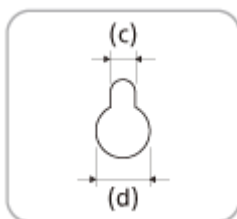

(c) 5 mm (7/32 in)

(d) 10 mm (13/32 in)

2 Align the vertical line above the “↑ ① TV CENTER LINE” printed on the WALL MOUNT TEMPLATE (supplied) with the center of the width of your TV.

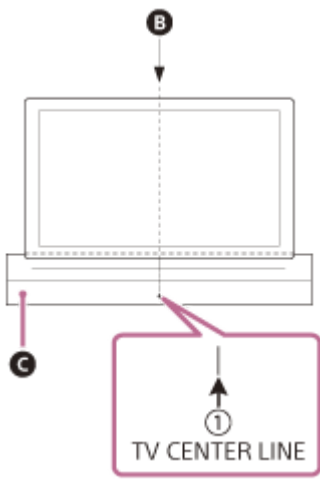

- B** Center of the TV
- C** WALL MOUNT TEMPLATE

3 Align the “ ←**2** TV BOTTOM LINE” printed on the WALL MOUNT TEMPLATE with the bottom of your TV, then adhere the WALL MOUNT TEMPLATE on the wall with a commercially available adhesive tape, etc.

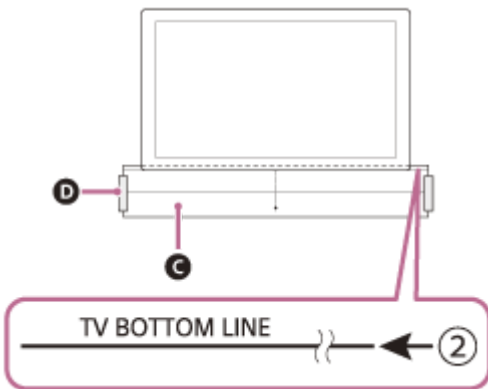

- C** WALL MOUNT TEMPLATE
- D** Adhesive tape, etc.

4 Fasten the screws prepared in step 1 securely into the screw marks on the “ ←**3** SCREW LINE” printed on the WALL MOUNT TEMPLATE.

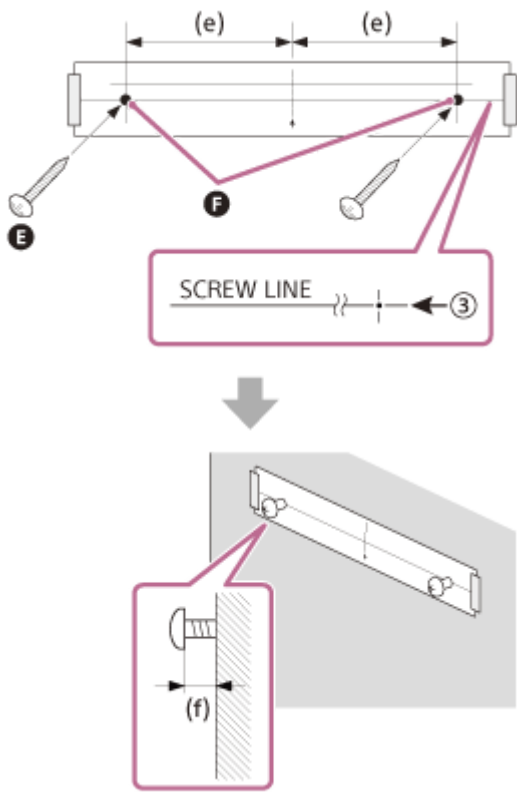

E Screws

F Marks

(e) 270 mm (10 3/4 in)

(f) 10 mm to 11 mm (approx. 7/16 in)

5 Remove the WALL MOUNT TEMPLATE.

6 Hang the bar speaker on the screws.

Align the holes of the rear of the bar speaker with the screws, then hang the bar speaker on the two screws.

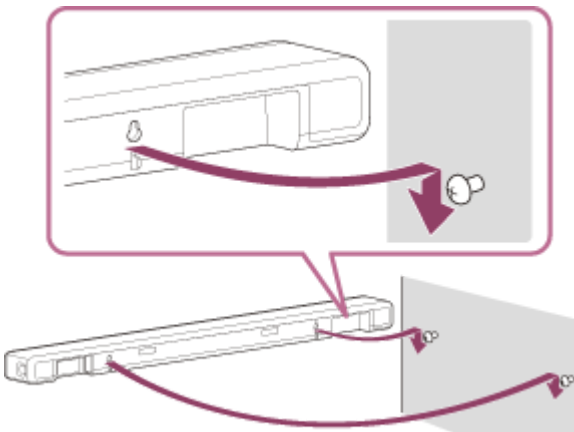

Note

- When adhering the WALL MOUNT TEMPLATE on the wall, smooth it out fully.
- Install the bar speaker apart from the TV by 70 mm (2 7/8 in) or more.

Connecting a TV Compatible with ARC/eARC

- 1 Connect the HDMI IN jack compatible with ARC/eARC on the TV and HDMI OUT (TV eARC/ARC) jack on the speaker system with the HDMI cable (supplied).

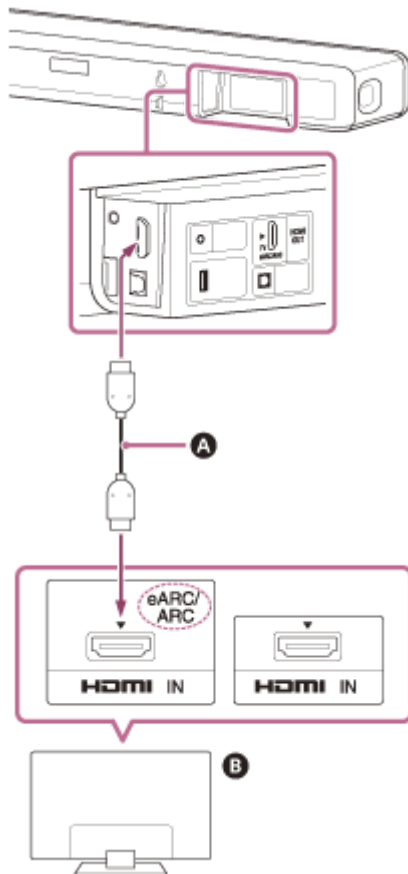

- A** HDMI cable (supplied)
- B** TV

Note

- Make sure that the connectors are firmly inserted.
- Enable the Control for HDMI function on the TV. If the Control for HDMI function on the TV is not enabled, TV sound will not be output from the speaker system.

Connecting a TV That Is not Compatible with ARC/eARC

- 1 Connect the HDMI IN jack on the TV and HDMI OUT (TV eARC/ARC) jack on the speaker system with the HDMI cable (supplied).

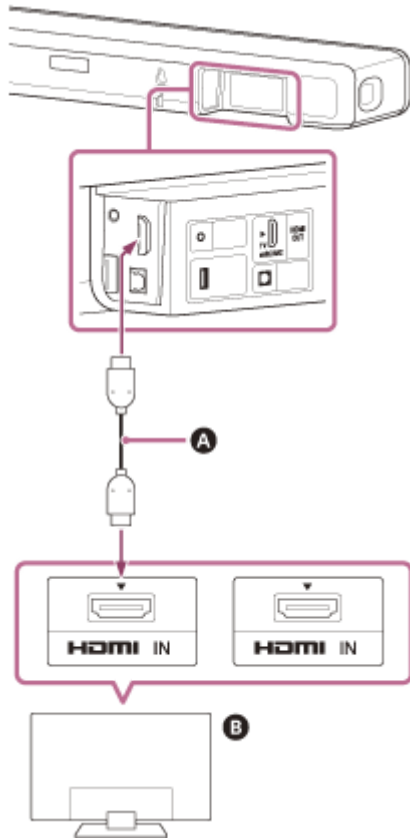

- A** HDMI cable (supplied)
- B** TV

- 2 Connect the optical digital output jack on the TV and the TV IN (OPT) jack on the speaker system with an optical digital cable (not supplied).

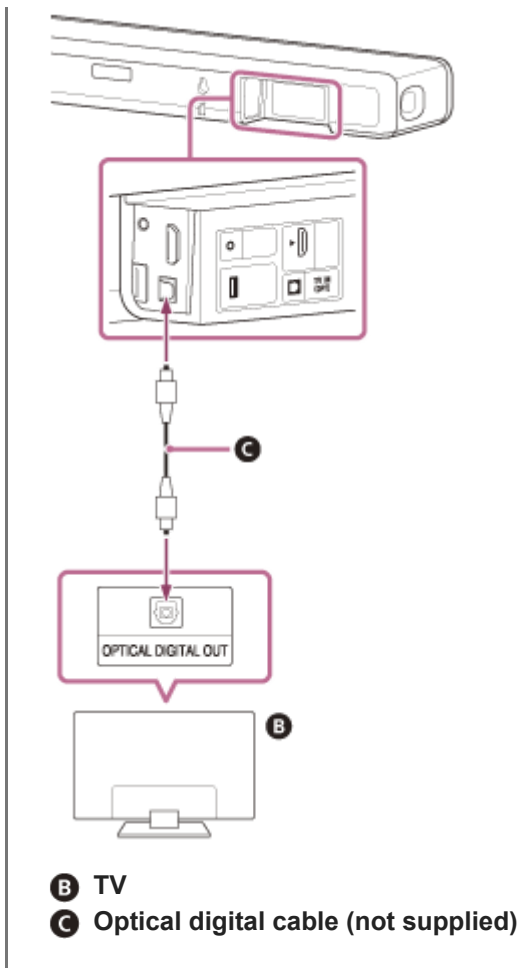

Note

- Make sure that the connectors are firmly inserted.
- Insert a plug of the optical digital cable in the correct direction by checking the shape of the plug and connector on the bar speaker and TV. If the plug is forcibly inserted in the wrong direction, the connector and plug may be damaged.

Sound Bar
HT-A3000

When Your TV Has the S-CENTER SPEAKER IN Jack

You can output the center part of the speaker system sound from the TV by connecting the TV with the following method.

- 1 Connect the speaker system and TV with the HDMI cable (supplied).
- 2 Connect the S-CENTER SPEAKER IN jack on the TV and the S-CENTER OUT jack on the speaker system with the TV center speaker mode cable (supplied).

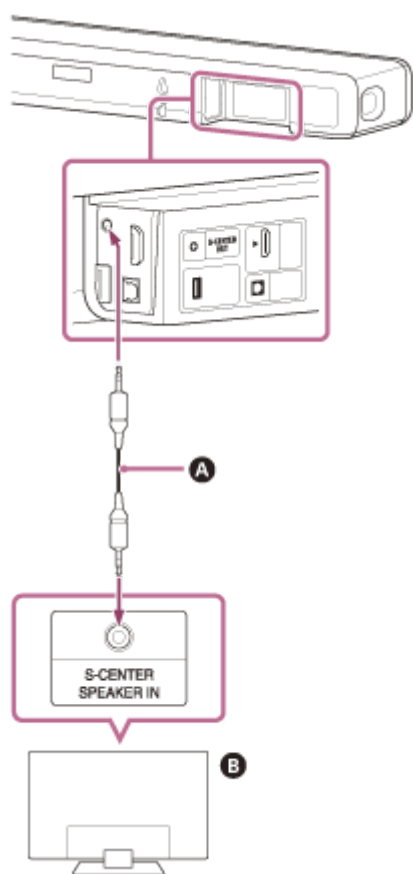

- A TV center speaker mode cable (supplied)
- B TV

Note

- Make sure that the connectors are firmly inserted.

Hint

- If the length of the TV center speaker mode cable is not sufficient, use a commercially available stereo mini cable.

- Connecting a TV Compatible with ARC/eARC
- Connecting a TV That Is not Compatible with ARC/eARC

5-034-491-11(3) Copyright 2022 Sony Corporation

Sound Bar
HT-A3000

Connecting to the AC Outlet (mains)

- 1 Connect the AC power cord (mains lead) (supplied) to the AC inlet on the speaker system, then connect to the AC outlet (mains).

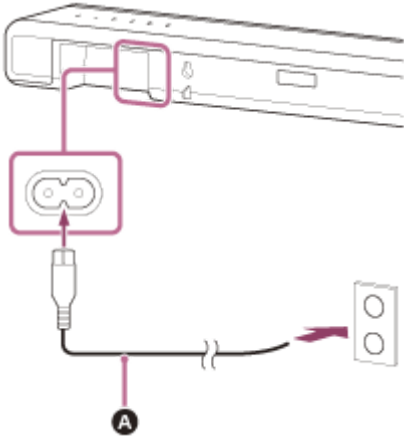

- A** AC power cord (mains lead) (supplied)

Performing Initial Settings

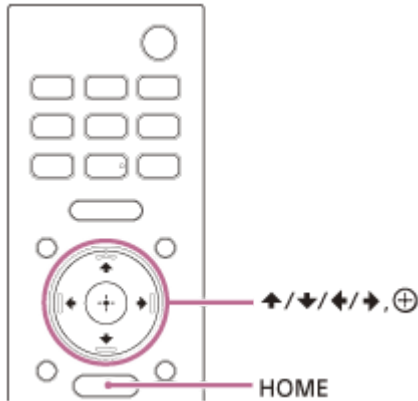

- 1 Press HOME on the remote control supplied with the speaker system to turn on the speaker system.

Operate the remote control by pointing it toward the front of the bar speaker.

- 2 Wait until [PLEASE WAIT] in the front panel display disappears and the next indication appears in the front panel display.

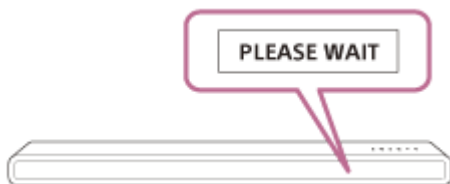

- 3 Turn on the TV.

- 4 Follow the instructions on the screen displayed on the TV to perform initial settings.

If the initial setting screen is not displayed, use the TV remote control to switch the input on the TV to the HDMI input that is connected to the speaker system, then press HOME on the remote control of the speaker system.



A Initial settings screen

- Press **↑** (up)/ **↓** (down)/ **←** (left)/ **→** (right) and **⊕** (enter) to select the item as instructed on the screen.

- If you use the optional subwoofer/rear speakers, connect them by following the instructions on the [Checking Wireless Speaker Connection] screen.
- Once [Setup is complete.] appears, select [Learn more].

Note

- Depending on the order in which you turn on the TV and the speaker system, the speaker system may be muted and [MUTING] is displayed on the front panel display of the speaker system. If this happens, turn all devices off, then turn on the speaker system after turning on the TV.

5-034-491-11(3) Copyright 2022 Sony Corporation

Sound Bar
HT-A3000

Connecting the Optional Speaker with the Manual Connection

The optional speaker is connected to the speaker system automatically when it is turned on. For details, refer to the operating instructions of the optional speaker.

If the optional speaker cannot be connected to the speaker system automatically, perform the manual connection by following the steps below.

1 Press HOME.

The home menu appears on the TV screen.

2 Select  [Setup] - [Advanced Settings] on the home menu.

3 Select [Speaker Settings] - [Wireless Speaker Settings] - [Start manual linking].

The [Start manual linking] screen appears on the TV screen.

4 Press LINK on the optional speaker.

The power indicator of the optional speaker that had LINK pressed flashes twice repeatedly in green.

5 Select [Start].

The manual connection starts.

The connecting process appears on the TV screen.

To cancel the manual connection, select [Cancel].

6 When the optional speaker which you want to connect displays [Connected], select [Finish].

7 Press  (enter).

The manual connection is established and the power indicator of the optional speaker lights in green.

Note

- If you perform [Start manual linking],  [Setup] - [Advanced Settings] - [Speaker Settings] - [Wireless Speaker Settings] - [Link mode] is set to [Manual] automatically.
- Only the speakers for which [Connected] has been displayed in step 6 connect to the speaker system. If the optional speaker is not properly connected, perform the operation again from step 1.

Sound Bar
HT-A3000

If Wireless Transmission Is Unstable

If you use multiple wireless systems, such as a wireless LAN, the wireless signals may become unstable. In this case, the transmission may be improved by changing the following setting.

1 Press HOME.

The home menu appears on the TV screen.

2 Select  [Setup] - [Advanced Settings] on the home menu.

3 Select [Speaker Settings] - [Wireless Speaker Settings] - [RF Channel].

4 Select the setting you want.

- **[On]:** Normally select this. The speaker system automatically selects the better channel for transmission. A stronger mode against wireless interference.
- **[Off]:** The speaker system selects a channel from the limited frequency band to prevent external wireless interference. If sound dropping occurs while [On] is selected, it may be improved by selecting [Off].

Note

- If you change the [RF Channel] setting from [Off] to [On], it may take 1 minute to reconnect.
- This setting does not appear depending on countries/regions.

Sound Bar
HT-A3000

When the TV Remote Control Does not Work

When the bar speaker obstructs the remote control sensor of the TV, the TV remote control may not work. In that case, enable the IR repeater function of the speaker system.

You can control the TV with the TV remote control by sending the remote signal from the rear of the bar speaker.

- 1 Press HOME.**
The home menu appears on the TV screen.
- 2 Select  [Setup] - [Advanced Settings] on the home menu.**
- 3 Select [System Settings] - [IR-Repeater].**
The [IR-Repeater] screen appears on the TV screen.
- 4 Select [On].**

Note

- Be sure to check that the TV remote control cannot control the TV, and then set [IR-Repeater] to [On]. If it is set to [On] when the remote control can control the TV, appropriate operation may not be obtained because of the interference between the direct command from the remote control and command via the bar speaker.
- Even if [IR-Repeater] is set to [On], this function may not work depending on your TV. Also, the remote controls of other devices such as an air conditioner may not work correctly. In this case, change the installation position of the speaker system or TV.

Sound Bar
HT-A3000

Watching TV

1 Press HOME.

The home menu appears on the TV screen.

2 Select  [Watch & Listen] - [TV] on the home menu.

3 Select the program using the TV remote control.

The selected TV program appears on the TV screen and the TV sound is output from the speaker system.

4 Adjust the volume.

Note

- When the bar speaker obstructs the remote control sensor of the TV and you cannot operate the TV by the TV remote control, enable the IR repeater function of the speaker system.

Hint

- You can select [TV] directly by pressing TV on the remote control.

Related Topic

- [When the TV Remote Control Does not Work](#)

Sound Bar
HT-A3000

What You Can Do by Connecting a TV with the BLUETOOTH® Function

When using Sony TV(*) with the BLUETOOTH function, you can listen to sound of the TV or device that is connected to the TV by connecting the speaker system and TV wirelessly.

* The TV needs to be compatible with A2DP (Advanced Audio Distribution Profile) of the BLUETOOTH profile.

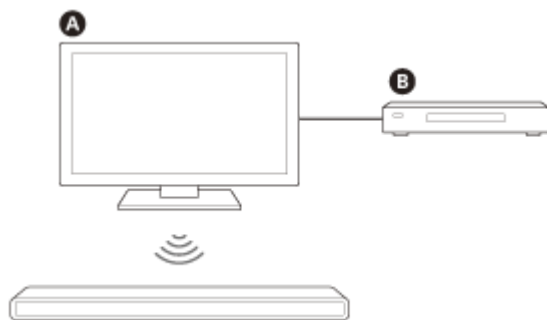

- A** Sony TV
- B** Blu-ray Disc player, set-top box, gaming console, etc.

Note

- If connecting the speaker system and TV by using the BLUETOOTH function, you cannot display the operation screen for the speaker system such as the home menu on the TV screen, and use functions of the speaker system other than the listening function for the sound of the TV or device that is connected to the TV.
To use all the functions of the speaker system, connect the speaker system and TV with the HDMI cable (supplied).

Related Topic



- [Connecting a TV Compatible with ARC/eARC](#)
- [Connecting a TV That Is not Compatible with ARC/eARC](#)

Listening to TV Sound by Connecting the Speaker System and TV Wirelessly

You need to perform pairing of the speaker system and TV by using the BLUETOOTH® function.

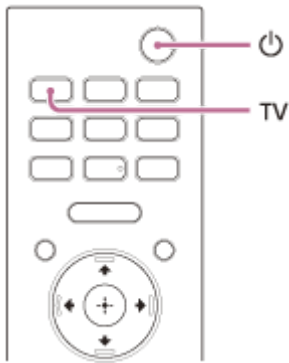
Pairing is the process required to mutually register the information on BLUETOOTH devices to be connected wirelessly in advance.



- 1 Turn on the TV.
- 2 Press  (power) to turn on the speaker system.
- 3 Press and hold  (BLUETOOTH) on the bar speaker and TV on the remote control simultaneously for 5 seconds.

The speaker system enters the BLUETOOTH pairing mode.
[TV-BT ON] and [PAIRING] appear in order in the front panel display.



A  (BLUETOOTH) button

- 4 Make sure that the BLUETOOTH indicator on the bar speaker flashes quickly in blue and [PAIRING] appears in the front panel display.

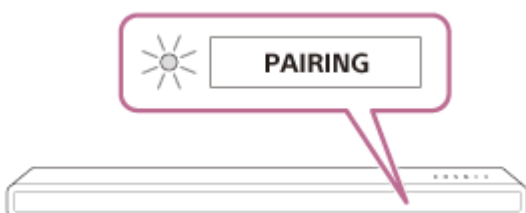

- 5 On the TV, search the speaker system by performing the pairing operation.

The list of the BLUETOOTH devices that are detected appears on the TV screen.

For the operation method to pair the BLUETOOTH device to the TV, refer to the operating instructions of the TV.

- 6 Pair the speaker system and TV by selecting “HT-A3000” from the list on the TV screen.**
- 7 Make sure that the BLUETOOTH indicator on the bar speaker lights in blue and [TV-BT] appears in the front panel display.**

A connection between the speaker system and TV has been established.
- 8 Select the program or input of the device by using the TV remote control.**

The sound of the displayed image on the TV screen is output from the speaker system.
- 9 Adjust the volume of the speaker system by using the TV remote control.**

When pressing the muting button on the TV remote control, the sound is muted temporarily.

Note

- If the TV sound is not output from the speaker system, press TV and check the status of the front panel display and indicators on the bar speaker.
 - [TV-BT] appears in the front panel display: The speaker system and TV are connected, and TV sound is output from the speaker system.
 - The BLUETOOTH indicator flashes quickly and [PAIRING] appears in the front panel display: Perform pairing on the TV.
 - [TV] appears in the front panel display: Perform steps from the start.
- When you connect the speaker system and TV with an HDMI cable, the BLUETOOTH connection is canceled. To connect the speaker system and TV with the BLUETOOTH function again, disconnect the HDMI cable, then perform the connecting operation from the start.

Listening to Sound of the Paired TV

1 Turn on the TV with the TV remote control.

The speaker system is turned on by interlocking with the TV power and TV sound is output from the speaker system.

2 Select the program or input of the device by using the TV remote control.

The sound of the displayed image on the TV screen is output from the speaker system.

3 Adjust the volume of the speaker system by using the TV remote control.

When pressing the muting button on the TV remote control, the sound is muted temporarily.

Hint

- When the TV is turned off, the speaker system is also turned off by interlocking with the TV power.

About operations with the remote control that is supplied with the speaker system

You can use the following buttons.

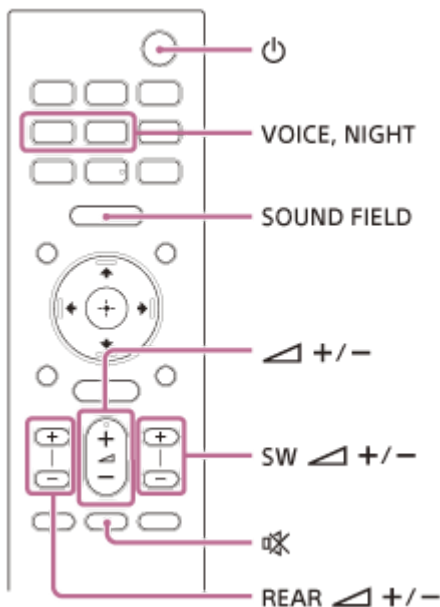

Note

- If you select the input other than TV on the remote control supplied with the speaker system, the TV sound is not output from the speaker system. To output the TV sound, press TV on the remote control to change to the TV input.
- While the TV is connected with the BLUETOOTH function, the following remote control buttons do not work.
 ▲ (up)/ ▼ (down)/ ◀ (left)/ ▶ (right), ⊕ (enter), BACK, HOME, DISPLAY, OPTIONS, ▶ || (play/pause), ◀◀ (previous)/ ▶▶ (next)

Listening to Music by Pairing the Mobile Device That Is Connected for the First Time

To use the BLUETOOTH® function, you need to perform pairing of the speaker system and mobile device in advance.

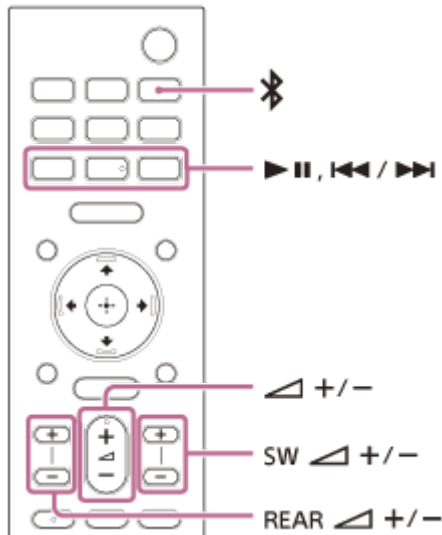

1 Press and hold (BLUETOOTH) for 2 seconds.

2 Make sure that the BLUETOOTH indicator on the bar speaker flashes quickly in blue and [PAIRING] appears in the front panel display.

The speaker system enters the pairing mode.

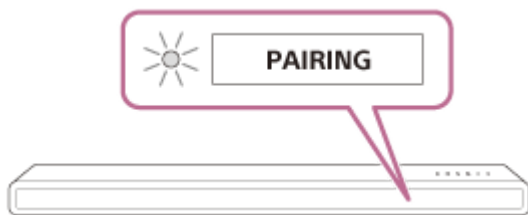

3 On the mobile device, search the speaker system by performing the pairing operation.

The list of the BLUETOOTH devices that are detected appears on the screen of the mobile device.

For the operation method to pair the BLUETOOTH device to the mobile device, refer to the operating instructions of the mobile device.

4 Pair the speaker system and mobile device by selecting "HT-A3000" from the list on the screen of the mobile device.

If a passkey is requested, enter "0000."

5 Make sure that the BLUETOOTH indicator on the bar speaker lights in blue and [BT] appears in the front panel display.

A connection between the speaker system and mobile device has been established.

6 Start audio playback with the music app on the connected mobile device.

Sound is output from the speaker system.

7 Adjust the volume.

You can play or pause the content by using the playback operation buttons on the remote control.

To check the connection status of the BLUETOOTH function

| Status | BLUETOOTH indicator |
|---------------------------------|-------------------------|
| During pairing standby status | Flashes quickly in blue |
| Connection is being attempted | Flashes in blue |
| Connection has been established | Lights in blue |

Hint

- If there is no mobile device that has been paired (ex. immediately after the purchase of the speaker system), the speaker system goes into pairing mode simply by changing the input to the BLUETOOTH input.
- Perform pairing for the second and subsequent mobile devices.

Listening to Music from the Paired Device

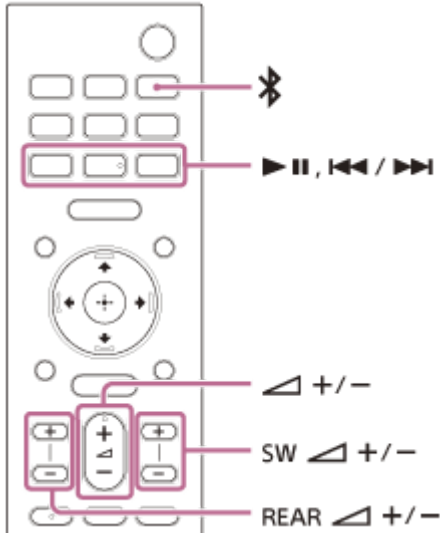

- 1 Turn the **BLUETOOTH®** function of the mobile device to on.
- 2 Press **Bluetooth** (BLUETOOTH).
The speaker system automatically reconnects to the mobile device it was most recently connected to.
- 3 Make sure that the **BLUETOOTH** indicator on the bar speaker lights in blue and **[BT]** appears in the front panel display.
A connection between the speaker system and mobile device has been established.
- 4 Start audio playback with the music app on the connected mobile device.
Sound is output from the speaker system.
- 5 Adjust the volume.
You can play or pause the content by using the playback operation buttons on the remote control.

Note



- If sound delay occurs, it may be improved by setting  [Setup] - [Advanced Settings] - [Bluetooth Settings] - [Bluetooth Connection Quality] to [Priority on Stable Connection].

Hint

- When the connection is not established, select "HT-A3000" on the mobile device.

To disconnect the mobile device

Perform any of the following items.

- Disable the BLUETOOTH function on the mobile device.
- Press  (BLUETOOTH) while the [Bluetooth Audio] screen appears on the TV screen.
- Set  [Setup] - [Advanced Settings] - [Bluetooth Settings] - [Bluetooth Mode] to [Transmitter] or [Off].
- Turn off the speaker system or mobile device.

5-034-491-11(3) Copyright 2022 Sony Corporation

Sound Bar
HT-A3000

Listening to Music on a USB Device

You can play music files stored on a connected USB device.

- 1 Connect the USB device to the  (USB) port.

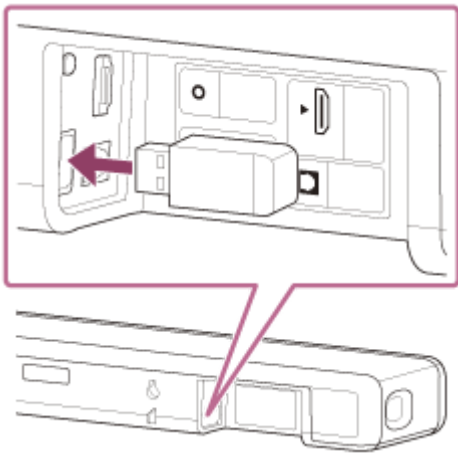

- 2 Press **HOME**.

The home menu appears on the TV screen.

- 3 Select  **[Watch & Listen] - [USB (Connected)]** on the home menu.

- 4 Select the folder on which songs are stored, then select a song.

The selected song is played and sound is output from the speaker system.

- 5 Adjust the volume.



Note

- Do not remove the USB device during operation. To avoid data corruption or damage to the USB device, turn the speaker system off before connecting or removing the USB device.









Hint





- You can select the USB input directly by pressing **USB** on the remote control.

About the music playback screen

Select the following buttons on the TV screen by pressing  (left)/  (right), then press  (enter).

-  (play)/  (pause)
Starts or pauses playback.
You can also operate by using  (play/pause) on the remote control.

-  (previous)/  (next)
Plays the previous or next music file.
You can also operate by using  (previous)/  (next) on the remote control.
-  (Shuffle play)
Shuffles the playback order. Each time you press  (enter), on/off of the shuffle play is switched.
-  (Repeat play)
Press  (enter) repeatedly to switch the repeat mode.

| Repeat mode | Explanation |
|---|--|
|  (Repeat all) | Repeats all music files. |
|  (Repeat folder) | Repeats all music files in a folder. |
|  1 (Repeat one) | Repeats a music file that is being played. |
|  (Off) | Cancels the repeat play. |

Hint

- You can rewind/fast forward by pressing and holding  (previous)/  (next) on the remote control during playback.

Related Topic

- [Playable Types of Audio Files](#)

Sound Bar
HT-A3000

Listening to Sound by Pairing with Headphones

- 1 Set the BLUETOOTH® compatible headphones to pairing mode.**

Refer to the operating instructions of the headphones for the pairing method.
- 2 Press HOME.**

The home menu appears on the TV screen.
- 3 Select  [Setup] - [Advanced Settings] on the home menu.**
- 4 Select [Bluetooth Settings] - [Bluetooth Mode] - [Transmitter].**

The speaker system enters BLUETOOTH transmission mode.
- 5 Select the name of the headphones from the [Device List] in [Bluetooth Settings].**

When the BLUETOOTH connection is established, [Connected] appears.
If you cannot find the name of your headphones in [Device List], select [Scan].
- 6 Return to the home menu, select  [Watch & Listen], and select the input.**

The image of the selected input appears on the TV screen, [BT TX] appears in the front panel display, then the sound is output from the headphones.
Sound from the speaker system is muted at the same time.
- 7 Adjust the volume.**

Adjust the volume level of the headphones first. Then, adjust the volume level of the headphones with +/- on the bar speaker or  (volume) +/- on the remote control.

To remove the paired headphones from the device list

1. Press HOME.

The home menu appears on the TV screen.
2. Select  [Setup] - [Advanced Settings] on the home menu.
3. Select [Bluetooth Settings] - [Device List].
4. Move the cursor to the name of the headphones that you want to remove, and then press DISPLAY.

To remove all the paired headphones from the device list, press AUDIO.
5. Follow the on-screen instructions to remove the desired headphones from the device list.

Note

- To display the paired headphones on the device list, Set  [Setup] - [Advanced Settings] - [Bluetooth Settings] - [Bluetooth Mode] to [Transmitter].

Sound Bar
HT-A3000

Listening to Sound with Paired Headphones

1 Set the BLUETOOTH® function of the headphones to on.

2 Press HOME.

The home menu appears on the TV screen.

3 Select  [Setup] - [Advanced Settings] on the home menu.

4 Select [Bluetooth Settings] - [Bluetooth Mode] - [Transmitter].

The speaker system enters BLUETOOTH transmission mode and the speaker system automatically reconnects to the headphones that was most recently connected to.

5 Return to the home menu, select  [Watch & Listen], and select the input.

The image of the selected input appears on the TV screen, [BT TX] appears in the front panel display, then the sound is output from the headphones.



Sound from the speaker system is muted at the same time.

6 Adjust the volume.

Adjust the volume level of the headphones first. Then, adjust the volume level of the headphones with +/- on the bar speaker or  (volume) +/- on the remote control.

To disconnect the paired headphones

Perform any of the following items.

- Disable the BLUETOOTH function on the headphones.
- Set  [Setup] - [Advanced Settings] - [Bluetooth Settings] - [Bluetooth Mode] to [Receiver] or [Off].
- Turn off the speaker system or headphones.
- Select the device name of the connected headphones from  [Setup] - [Advanced Settings] - [Bluetooth Settings] - [Device List].
[Connected] of the device name disappears.

Sound Bar
HT-A3000

About the Connection of the Headphones

- You may not be able to adjust the volume level depending on the BLUETOOTH® compatible headphones.
- Input of BLUETOOTH is disabled when  [Setup] - [Advanced Settings] - [Bluetooth Settings] - [Bluetooth Mode] is set to [Off] or [Transmitter].
- You can register up to 9 BLUETOOTH devices. If a 10th BLUETOOTH device is registered, the oldest connected BLUETOOTH device will be overwritten by the new one.
- The speaker system can display up to 15 detected BLUETOOTH devices in the [Device List].
- You cannot change the sound effect or settings while transmitting sound to the BLUETOOTH compatible headphones.
- Playback of audio/music on the BLUETOOTH device is delayed compared to that on the speaker system due to the characteristics of BLUETOOTH wireless technology.
- You can enable or disable the reception of LDAC audio from the BLUETOOTH device in [Bluetooth Settings].

Sound Bar
HT-A3000

What You Can Do by Connecting the Speaker System to a Network

You can perform streaming playback of music content via the speaker system by operating a smartphone, tablet, or iOS device, or play music stored on a computer via the speaker system by connecting to the network.

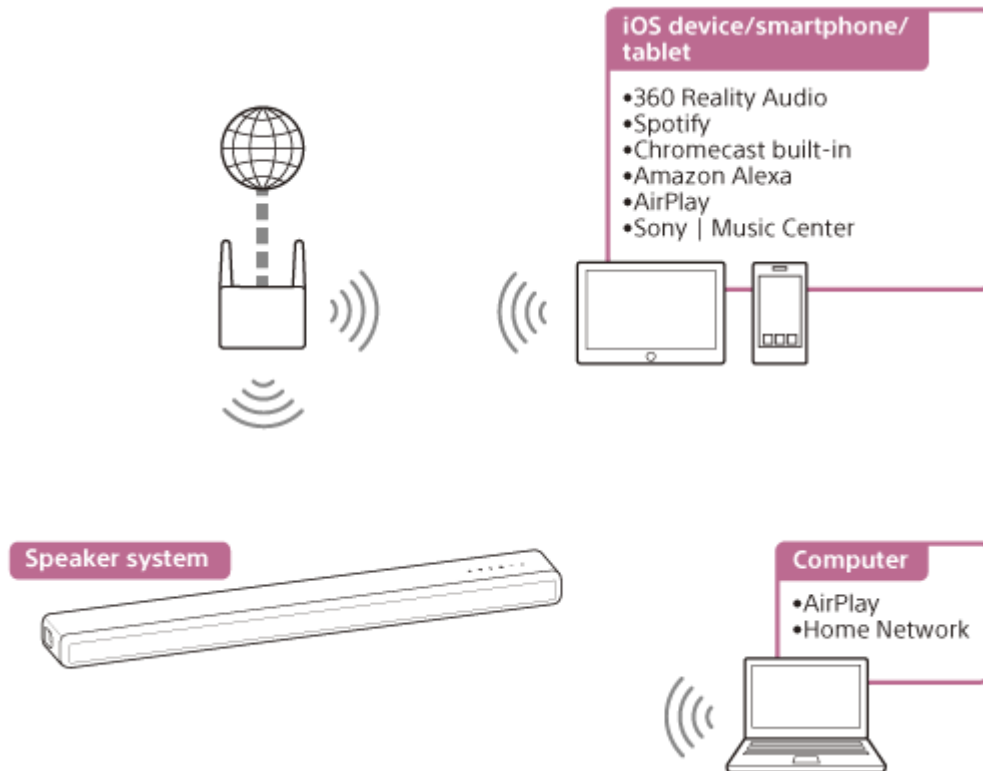

- **360 Reality Audio**

You can play 360 Reality Audio contents on the speaker system by selecting it on the streaming service app compatible with 360 Reality Audio.

- **Spotify**

You can select music on the Spotify app and play it on the speaker system.

Use your phone, tablet or computer as a remote control for Spotify. Go to spotify.com/connect to learn how.

- **Chromecast built-in™**

You can select music on the Chromecast-enabled app and play it on the speaker system.

- **Amazon Alexa**

You can perform voice control such as music playback, going to the next/previous song, volume adjustment, etc. on the streaming service by using the speaker system in combination with the Alexa built-in device (not supplied).

- **AirPlay**

The speaker system supports AirPlay. You can play music on the speaker system by operating an iOS device or a computer.

- **Sony | Music Center**

You can control the speaker system wirelessly by installing the “Sony | Music Center” app on your smartphone or tablet device.

- **Home Network**

You can play music files stored on your computer on a network location via your home network.

Note

- The server needs to be connected to the same network as that of the speaker system.

Related Topic

- [Prerequisite: Making the Initial Settings for Alexa with Sony | Music Center](#)
- [Playing Music with the TIDAL App](#)
- [Prerequisite: Making the Initial Settings for Chromecast built-in](#)
- [Using Spotify](#)
- [Using AirPlay](#)
- [Using Sony | Music Center](#)
- [Listening to Music on Your PC via a Home Network](#)

5-034-491-11(3) Copyright 2022 Sony Corporation

Sound Bar
HT-A3000

Notes on Connecting to the Internet

When connecting the speaker system to the Internet, be sure to connect via a router (*) with the appropriate security settings.

Once a security issue occurs, this product may suffer damage caused by malware (malicious software), etc. via the Internet and be exposed to security threats such as theft or tampering of personal information or content. This product may also cause damage to network services without your knowledge.

* A router is a device that relays the Internet and a local area network connection to other devices.

There are the following types of routers:

- Wired router
- ADSL modem router
- Optical Network Unit (ONU) with router function
- Wi-Fi access point that can function as a router
- In-wall access point router (**)

** If you are not sure whether an in-wall access point can be used as a router, check with your apartment manager or Internet service provider, etc.

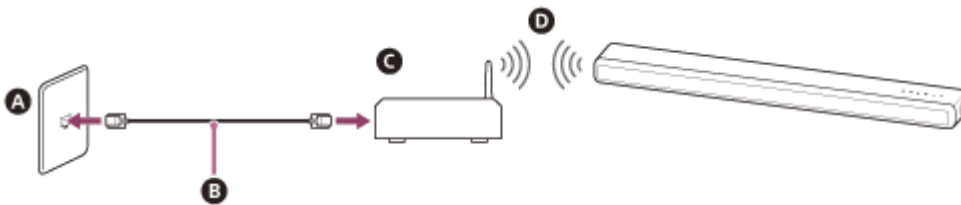

- A** LAN port on a wall
- B** LAN cable
- C** Router
- D** Wireless LAN

Sound Bar
HT-A3000

Setting Up a Wireless Network Connection on the Home Menu

Check the following information in advance.

- The network name (SSID)(*)
- The security key (password)(**)

* SSID (Service Set Identifier) is a name that identifies a particular access point.

** This information should be available from a label on your wireless LAN router/access point, from the operating instructions, from the person who set up your wireless network, or from the information provided by your Internet service provider.

1 Press HOME.

The home menu appears on the TV screen.

2 Select  [Setup] - [Advanced Settings] on the home menu.

3 Select [Network Settings].

Make sure that [Wi-Fi Connection] is set to [On].

4 Select [Internet Settings] - [Next].

5 Select [Search for Wi-Fi network].

The list of network names appears on the TV screen.

6 Select the desired network name (SSID).

When connecting to a network that does not appear in the list, select [New connection registration] and follow the on-screen instructions.

7 Enter the security key (or password) using the software keyboard, and then select [Enter].

The speaker system starts connecting to the network.

Sound Bar
HT-A3000

Setting Up a Wireless Network Connection Using Sony | Music Center

Sony | Music Center can connect the speaker system to the same wireless network as that of the mobile device. For details, follow the instruction of the app or refer to the following URL.

<https://www.sony.net/smcqa/>

Sound Bar
HT-A3000

Setting Up a Wi-Fi Connection Using an iOS Device

The speaker system is compatible with Apple Setup.

Using this function, you can connect the speaker system to the same network that connects your iOS device by Wi-Fi without entering the network name and password.

- 1 Press HOME.**

The home menu appears on the TV screen.
- 2 Select  [Setup] - [Advanced Settings] on the home menu.**
- 3 Select [Network Settings].**

Make sure that [Wi-Fi Connection] is set to [On].
- 4 Select [Internet Settings] - [Next].**
- 5 Select [Use Apple Setup].**
- 6 Operate the iOS device by following the on-screen instructions.**

Sound Bar
HT-A3000

Prerequisite: Making the Initial Settings for Alexa with Sony | Music Center

With Sony | Music Center, you can play music from Amazon Music or link the speaker system with an Amazon Alexa Built-in device.

To prepare the speaker system and mobile device, connect the mobile device by Wi-Fi to the same network as that of the speaker system, and register the speaker system to an Amazon account.

1 Connect the mobile device by Wi-Fi to the same network as that of the speaker system.

2 Install the free Sony | Music Center app on your mobile device.

3 Start Sony | Music Center and select the speaker system.



4 Select [Settings] - [Amazon Alexa] - [Initial Setup] and follow the on-screen instructions to make settings to operate the speaker system with Alexa.



Note

- Amazon Alexa is not available in all languages and countries/regions.
- Before you use Sony | Music Center, make sure that a Wi-Fi network connection is established.

Related Topic

- [Setting Up a Wireless Network Connection Using Sony | Music Center](#)

Audio Formats Available for Playback by Audio Casting Protocol

Audio formats available for playback vary depending on the audio casting protocol.

On the Amazon Music app for Android OS:

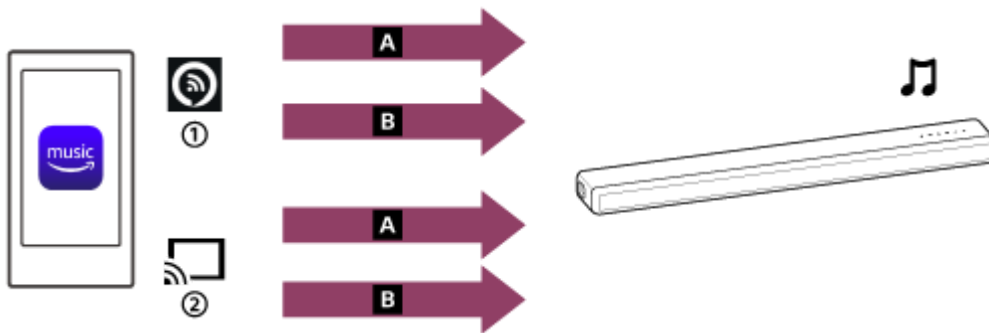

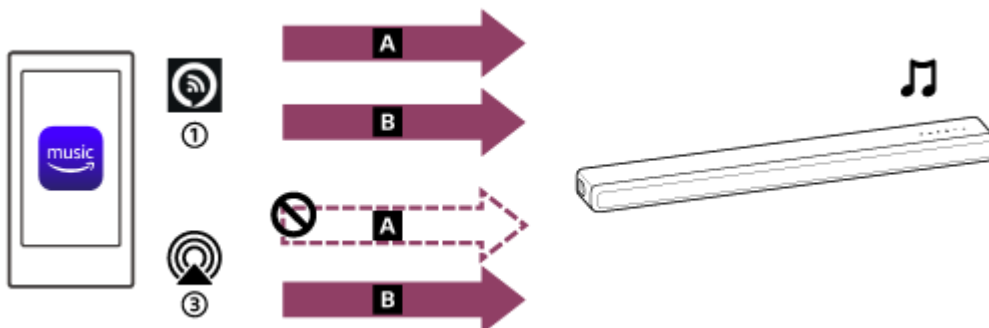

- A** 360 Reality Audio
- B** 2-channel audio
- ① Alexa Cast
- ② Cast icon

On the Amazon Music app for iOS:



- A** 360 Reality Audio
- B** 2-channel audio
- ① Alexa Cast
- ③ AirPlay

Hint

- Alexa Cast icon (): The speaker system is identified by the device name you specified in the initial settings for Alexa.
- Cast icon (): The speaker system is identified by the device name, [HT-A3000], or the device name you specified in the initial settings for Google Home.

Related Topic

- [Playing Music with the Amazon Music App](#)

Sound Bar
HT-A3000

Playing Music with the Amazon Music App

By operating a smartphone/iPhone on which the Amazon Music app is installed, you can play music from Amazon Music. You can play 360 Reality Audio compatible music available on Amazon Music as well.

To play 360 Reality Audio compatible music, you need to subscribe to Amazon Music Unlimited.

Note

- To download the app and use network services, additional registrations and payment of communication charges and other fees may be required.

1 Download and install the Amazon Music app on your smartphone/iPhone.





2 Start the Amazon Music app and select music of your choice for playback.

The music tracks indicated with the [360] icon are compatible with 360 Reality Audio.

3 Tap the cast icon ().

4 Select the speaker system as the music playback destination.

Tap the speaker system's name displayed with the Alexa Cast icon () or cast icon ().

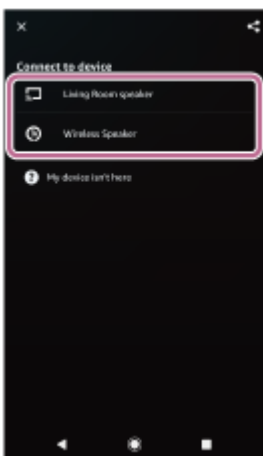

Note

- When selecting a playback device, selecting the speaker system's name displayed with the AirPlay icon () does not enable 360 Reality Audio playback.
- With Sony | Music Center, you can check the streaming services that provide 360 Reality Audio compatible music. On Sony | Music Center, select the speaker system and then select [Settings] - [About 360 Reality Audio] - [Next].
- The specifications and design of the app may change without notice.

Related Topic

- [Audio Formats Available for Playback by Audio Casting Protocol](#)

5-034-491-11(3) Copyright 2022 Sony Corporation

Sound Bar
HT-A3000

Operating the Speaker System by Talking to an Alexa Built-in Device

By talking to an Alexa Built-in device, you can stream music to the speaker system from a streaming service that supports Alexa.

1 Talk to the Alexa Built-in device to play music.

For details on voice commands for Alexa Built-in device, find them out on Sony | Music Center.



Note

- This function is not available in some countries/regions.
- Alexa skills that need user responses are not available on the speaker system because the speaker system does not have a microphone.
- An Amazon Alexa Built-in device (not supplied), such as Amazon Echo, is required to use voice command features. By using an Alexa Built-in device along with the speaker system, you can use voice commands to play, skip to the beginning of the next/current track, and adjust the volume.
- Not all of the Amazon Alexa functions are available on the speaker system.

Hint

- Use Sony | Music Center to deregister the speaker system from the Amazon account. Even if you deregister an account on the Alexa app, the speaker system will not recognize that the account has been deregistered.
- An image such as an album cover appears in the playback screen if the played content supports the feature.

Sound Bar
HT-A3000

Playing Music with the TIDAL App

By operating a smartphone/iPhone on which the TIDAL app is installed, you can play music from TIDAL. You can play 360 Reality Audio compatible music available on TIDAL as well. To play 360 Reality Audio compatible music, you need to subscribe to the TIDAL HiFi plan.

Note

- TIDAL may not be available in some languages or countries/regions.
- To download the app and use network services, additional registrations and payment of communication charges and other fees may be required.

1 Download and install the TIDAL app on your smartphone/iPhone.



2 Connect the mobile device by Wi-Fi to the same network as that of the speaker system.

3 Start the TIDAL app and select music of your choice for playback.

4 Tap the cast icon ().

5 Select the speaker system as the music playback destination.

Tap the speaker system's name ([HT-A3000] or the device name you specified in the initial settings for Google Home).

When you select either 2-channel audio or 360 Reality Audio compatible music, [360RAcast] appears.

Note

- With Sony | Music Center, you can check the streaming services that provide 360 Reality Audio compatible music. On Sony | Music Center, select the speaker system and then select [Settings] - [About 360 Reality Audio] - [Next].
- The specifications and design of the app may change without notice.

Sound Bar
HT-A3000

Prerequisite: Making the Initial Settings for Chromecast built-in

The speaker system is compatible with Chromecast built-in, which can stream music to the speaker from the mobile device.

1 Press HOME.

The home menu appears on the TV screen.

2 Select [Listen] - [Chromecast built-in] on the home menu.

Follow the steps that appear on the screen.

After performing the settings, [Network/Bluetooth Standby] is set to [On] automatically and you can play music quickly even when the speaker system is in standby mode.

Playing and controlling your music with Google Assistant

This speaker system is compatible with a Google Assistant-enabled device with Chromecast built-in so you can control your music with your voice. Simply link the speaker system to the Google Home app on your mobile device. For details, refer to the Google Home app.

Sound Bar
HT-A3000

Playing Music with Apps Compatible with Other Streaming Services

By operating a smartphone/iPhone on which an app compatible with a streaming service of your choice is installed, you can play 2-channel audio or 360 Reality Audio compatible music.

Depending on the streaming service, you need to subscribe to the premium plan to play 360 Reality Audio compatible music.

Note

- To download the app and use network services, additional registrations and payment of communication charges and other fees may be required.

- 1 Download and install an app compatible with a streaming service of your choice on your smartphone/iPhone.**
- 2 Connect the mobile device by Wi-Fi to the same network as that of the speaker system.**
- 3 Start the app you downloaded in step 1 and select music of your choice for playback.**
- 4 Tap the cast icon.**
The cast icon varies depending on the app.
- 5 Select the speaker system as the music playback destination.**
Tap the speaker system's name ([HT-A3000] or the device name you specified in the initial settings for Google Home).

Note

- With Sony | Music Center, you can check the streaming services that provide 360 Reality Audio compatible music. On Sony | Music Center, select the speaker system and then select [Settings] - [About 360 Reality Audio] - [Next].
- The specifications and design of the app may change without notice.

Sound Bar
HT-A3000

Using Spotify

You can select music on the Spotify app and play it on the speaker system.

Playing music on the speaker system by using the “Spotify Connect” function

Use your phone, tablet or computer as a remote control for Spotify. Go to spotify.com/connect to learn how.

Hint

- If [Network/Bluetooth Standby] is set to [On], you can play music quickly even when the speaker system is in standby mode.
- An image such as an album cover appears in the playback screen if the played content supports the feature.

Resuming music that has been played on the mobile device

1 Press MUSIC SERVICE.

When you have played music on Spotify on the speaker system, the music that was played with Spotify is resumed.

Note

- The Spotify app may not be available in some countries/regions.

Related Topic

- [\[System Settings\]](#)

Sound Bar
HT-A3000

Using AirPlay

The speaker system is compatible with AirPlay 2. You can select music content on an iOS device such as iPhone, iPad, and iPod touch and stream it to the speaker system.

- 1 **Connect the iOS device by Wi-Fi to the same network as that of the speaker system.**
- 2 **Play the music you want to stream on the iOS device.**
- 3 **Display the AirPlay icon () on the iOS device and tap it.**
- 4 **Select the speaker system as the speaker to stream to on the iOS device.**

The music is played on the speaker system.

Hint

- You can also select other speakers at the same time as the speaker system, and stream music through multiple speakers.

Streaming music on the speaker system by talking to Siri

If you add the speaker system to the Home app on the iOS device, you can stream music to the speaker system by talking to Siri.

Note

- Since the speaker system does not have a microphone, you cannot talk to the speaker system to operate it.
- Not all features of Siri are available on the speaker system.

Sound Bar
HT-A3000

Using Sony | Music Center

Sony | Music Center is an application for controlling compatible Sony audio devices using the mobile device such as a smartphone or tablet.

For details about Sony | Music Center, refer to the following URL.

<https://www.sony.net/smcqa/>

- 1 **Install the free Sony | Music Center app on your mobile device.**
- 2 **Connect the mobile device by Wi-Fi to the same network as that of the speaker system.**
- 3 **Start Sony | Music Center.**
- 4 **Operate by following the Sony | Music Center screen.**

Note

- Use Sony | Music Center of the latest version.
- If you cannot connect the speaker system and a BLUETOOTH device via the BLUETOOTH function, uninstall Sony | Music Center and try to connect via the BLUETOOTH function again.

Hint

- Connect the mobile device to the same network as that of the speaker system.

Related Topic

- [Setting Up a Wireless Network Connection on the Home Menu](#)
- [Setting Up a Wireless Network Connection Using Sony | Music Center](#)
- [Setting Up a Wi-Fi Connection Using an iOS Device](#)

Sound Bar
HT-A3000

Listening to Music on Your PC via a Home Network

You can play music files stored on your PC via your home network.

Music files can be played by operating Sony | Music Center on a mobile device such as a smartphone or tablet.

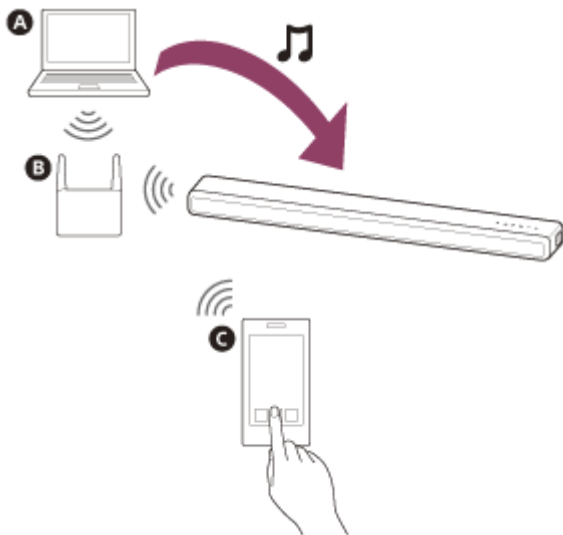

- A PC
- B Wireless LAN router
- C Smartphone or tablet

1 Connect the speaker system to a network.

2 Connect the PC to a network.

For details, refer to the operating instructions of the PC.

3 Set the PC.

To use the PC on your home network, you need to set the PC as the server. For details, refer to the operating instructions of the PC.

4 Listen to music on a PC by using Sony | Music Center.

You can play music files stored on the PC by operating Sony | Music Center that is installed to a mobile device such as a smartphone or tablet. For details of Sony | Music Center, refer to the following URL.

<https://www.sony.net/smcqa/>

Hint

- See  [Setup] - [Advanced Settings] - [Network Settings] - [Network Connection Status] when checking the network connection status.

Related Topic

- [Setting Up a Wireless Network Connection on the Home Menu](#)
- [Setting Up a Wireless Network Connection Using Sony | Music Center](#)
- [Setting Up a Wi-Fi Connection Using an iOS Device](#)

5-034-491-11(3) Copyright 2022 Sony Corporation

Sound Bar
HT-A3000

Adjusting the Volume

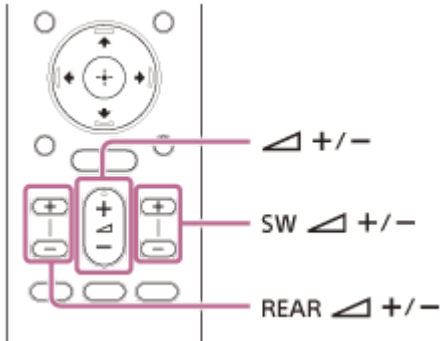

To adjust the speaker system volume

Press  (volume) +/-.

The volume level appears in the front panel display.

To adjust the subwoofer volume

Press SW  (subwoofer volume) +/-.

The volume level appears in the front panel display.

Note

- The subwoofer is designed for playback of bass or low frequency sound. When the input source, such as in TV programs, does not contain much bass sound, the bass sound from the subwoofer may be difficult to hear.

Hint

- When connecting the optional subwoofer, the optional subwoofer level is adjusted instead of the built-in subwoofer level.

To adjust the optional rear speaker volume

Press REAR  (rear speakers volume) +/-.

The volume level appears in the front panel display.

Note

- The optional rear speakers are designed for playback of the surround part of the multi-channel sound and surround sound that is created from the 2-channel sound using virtual processing. When the input source does not contain much surround sound, the surround sound from the optional rear speakers may be difficult to hear.
- REAR  (rear speakers volume) +/- does not work when the optional rear speakers are not connected.

Sound Bar
HT-A3000

Enjoying Surround Effect (SOUND FIELD)

You can turn the surround effect on or off to suit sound sources.

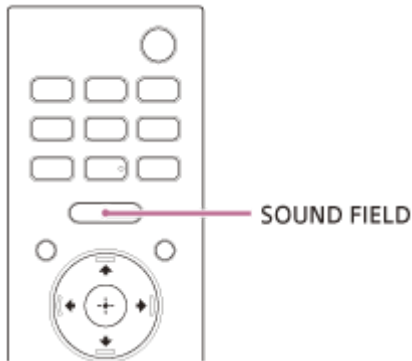

1 Press SOUND FIELD to select the setting.



The setting appears in the front panel display.

- **[SF.ON]:** The sound is output with the surround effect. This setting is suitable for experiencing the surround sound with presence regardless of the genre.
- **[SF.OFF]:** The sound is output without the surround effect.

Note

- You cannot change the setting in the following conditions even if you press SOUND FIELD.
 - The BLUETOOTH device is connected in BLUETOOTH transmission mode.
 - A test tone is emitted.
- Depending on the source, such as Dolby Atmos, this setting is always set to ON and cannot be changed.

Hint

- You can select the type of the surround effect in  [Setup] - [Advanced Settings] - [Audio Settings] - [Sound Field Setting]. You cannot change the setting of [Sound Field Setting] when  [Setup] - [Advanced Settings] - [Audio Settings] - [360 Spatial Sound Mapping] is set to [On].

Sound Bar
HT-A3000

Making Dialogs Clearer (VOICE)

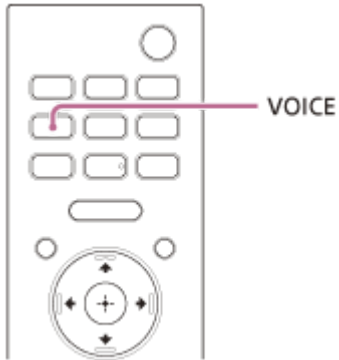

1 Press VOICE to select the setting.

The setting appears in the front panel display.

- **[Vo.ON]**: Dialog is easily heard by enhancing dialog range.
- **[Vo.OFF]**: Deactivates the voice mode function.

Note

- When the BLUETOOTH device is connected in BLUETOOTH transmission mode, the voice mode is disabled.

Sound Bar
HT-A3000

Enjoying Clear Sound with Low Volume at Midnight (NIGHT)

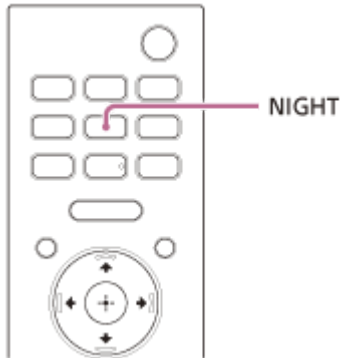

1 Press NIGHT to select the setting.

The setting appears in the front panel display.

- **[N.ON]:** Sound is output at low volume with minimum loss of fidelity and clarity of dialog.
- **[N.OFF]:** Deactivates the night mode function.

Note

- When you turn the speaker system off, this setting is set to [N.OFF] automatically.
- When the BLUETOOTH device is connected in BLUETOOTH transmission mode, the night mode is disabled.

Sound Bar
HT-A3000

Adjusting the Delay Between the Picture and Sound

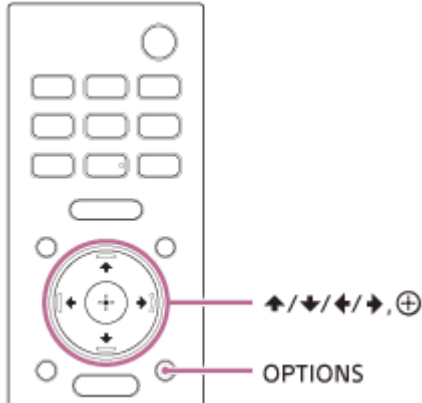

- 1 Press OPTIONS.**
[SYNC] appears in the front panel display.
- 2 Press → (right) or ⊕ (enter).**
The adjusting time appears in the front panel display.
- 3 Adjust the delay using ↑ (up)/ ↓ (down), then press ⊕ (enter).**
You can adjust from 0 msec to 300 msec in 25 msec increments.
- 4 Press OPTIONS.**
The options menu in the front panel display turns off.

Sound Bar
HT-A3000

Enjoying Multiplex Broadcast Sound (AUDIO)

You can enjoy multiplex broadcast sound when the speaker system receives a Dolby Digital multiplex broadcast signal.

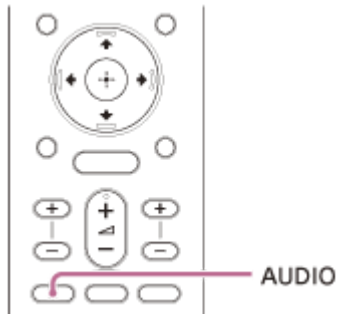

1 Press AUDIO to select the setting.

The setting appears in the front panel display.

- **[MAIN]:** Sound of the main language is output.
- **[SUB]:** Sound of the sub language is output.
- **[MN/SB]:** Main sound is output from the left speaker and sub sound is output from the right speaker.

Note

- To output Dolby Digital sound, you need to connect a TV that is compatible with eARC or ARC to the HDMI OUT (TV eARC/ARC) jack with the HDMI cable (supplied).
- If your TV's HDMI IN jack is not compatible with eARC or ARC, connect the TV to the TV IN (OPT) jack with an optical digital cable (not supplied) to output Dolby Digital sound.

Related Topic

- [Connecting a TV Compatible with ARC/eARC](#)
- [Connecting a TV That Is not Compatible with ARC/eARC](#)

Sound Bar
HT-A3000

Adjusting the Dialog Volume While the DTS:X Content is Played Back

By adjusting the dialog volume, you can easily listen to dialog since it stands out from the ambient noise. This function works while playing content that is compatible with the DTS:X dialog control function.

The setting method differs depending on the input.

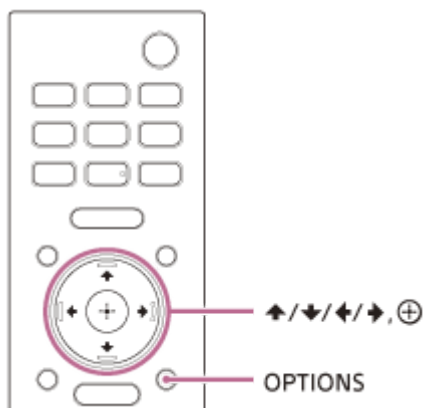

1 Press **OPTIONS**, display **[DIALOG]** in the front panel display using **▲** (up)/ **▼** (down), then press **⊕** (enter).

2 Adjust the dialog volume using **▲** (up)/ **▼** (down), then press **⊕** (enter).

You can adjust from 0.0 dB to 6.0 dB in 1.0 dB increments.

3 Press **OPTIONS**.

The options menu in the front panel display turns off.

Sound Bar
HT-A3000

Operating the Speaker System by Interlocking with a TV (Control for HDMI Function)

Connecting a TV compatible with the Control for HDMI function using an HDMI cable enables you to interlock the speaker system operation such as power on/off or volume adjustment with a TV.

About the Control for HDMI function

The Control for HDMI function is a function that enables operation of devices connected with an HDMI (High-Definition Multimedia Interface) cable by interlocking them.

Although this function works for devices compatible with the Control for HDMI function, it may not work if connecting devices other than those manufactured by Sony.

Preparing to operate by interlocking with a TV

Enable the Control for HDMI function settings of the TV connected to the speaker system with an HDMI cable. The default setting of the Control for HDMI function of the speaker system is [On].

Hint

- When connecting a device such as a Blu-ray Disc player to a TV with an HDMI cable, enable its Control for HDMI function.
- To enable the Control for HDMI function of a TV or Blu-ray Disc player, refer to their operating instructions.
- If you enable the Control for HDMI ("BRAVIA" sync) function when using a TV manufactured by Sony, the Control for HDMI function of the speaker system is also enabled automatically. When the setting is complete, [DONE] appears in the front panel display.

Performing power operation or volume adjustment by a TV remote control

When turning the TV on/off or adjusting the volume using the TV remote control, the speaker system power operation or volume adjustment is interlocked.



- A** TV
- B** TV remote control

Power interlocking

When you turn on or off the TV, the speaker system will turn on or off automatically.

Note

- If you turn off the speaker system before turning off the TV, the speaker system may not turn on automatically even though you turn on the TV next time. In this case, perform the following operation.
 - Select the speaker system for the sound output device in the TV menu.
 - When using Sony TV, turn on the speaker system while the TV is turned on.

Volume adjustment

The sound of the TV you are watching is output from the speaker system automatically. You can adjust the speaker system volume by the TV remote control.

Other interlocking functions

Menu operation by TV remote control

You can operate the menu of the speaker system by selecting the name of the speaker system when changing input or operating the Sync Menu on the TV.

Note

- Some Sony TVs support the Sync Menu. Refer to the operating instructions of your TV to see if your TV supports the Sync Menu.

Language follow

When you change the language for the on-screen display of the TV, the speaker system's on-screen display language is also changed.

Hint

- You can change the Control for HDMI settings by selecting  [Setup] - [Advanced Settings] - [HDMI Settings] on the home menu.

Sound Bar
HT-A3000

Operating the Speaker System by Interlocking with a TV Compatible with the “BRAVIA” Sync Function

“BRAVIA” Sync is an extended function developed by Sony based on the Control for HDMI function. By connecting “BRAVIA” Sync-compatible devices such as a TV or a Blu-ray Disc player using an HDMI cable, you can control the devices by interlocking them with each other.

To use “BRAVIA” Sync

“BRAVIA” Sync is enabled by enabling the Control for HDMI function of the Sony device.

What you can do with “BRAVIA” Sync

Control for HDMI function

- Power interlocking
- Volume adjustment
- Menu Operation by TV Remote Control
- Language Follow

Home Theatre Control function

Setting the speaker system, input switching, etc. can be done without switching the TV input.

Related Topic

- [Operating the Speaker System by Interlocking with a TV \(Control for HDMI Function\)](#)

Sound Bar
HT-A3000

Changing the Brightness of the Front Panel Display and Indicators (DIMMER)

You can change the brightness of the front panel display and BLUETOOTH indicator. The brightness of the indicators for the optional subwoofer and rear speakers also changes.

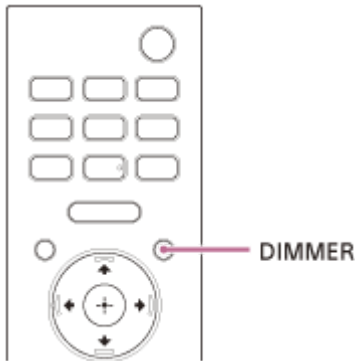

1 Press DIMMER to select the setting.

The setting appears in the front panel display.

- **[BRIGHT]:** The front panel display and indicators light brightly.
- **[DARK]:** The front panel display and indicators light darkly.
- **[OFF]:** The front panel display and indicators are turned off.

Note

- The front panel display and indicators are turned off when [OFF] is selected. They turn on automatically when you press any button, then turn off again if you do not operate the speaker system for about 10 seconds. However, in some cases, the front panel display and indicators may not turn off. In this case, the brightness of the front panel display and indicators are the same as [DARK].

Sound Bar
HT-A3000

Saving Power in Standby Mode

Check that  [Setup] - [Advanced Settings] - [System Settings] - [Network/Bluetooth Standby] is set to [Off].

Sound Bar
HT-A3000

Performing Easy Setup

You can make basic initial settings, speaker settings, and network settings for the speaker system easily by performing Easy Setup.

1 Press HOME.

The home menu appears on the TV screen.

2 Select  [Setup] - [Easy Setup] on the home menu.

The [Easy Setup] screen appears on the TV screen.

3 Select the desired setting.

- **[Easy Initial Setup]:** Performs the basic initial settings including the speaker settings and network settings.
- **[Easy Sound Setup]:** Performs the basic speaker settings for optimizing the surround sound for your environment. To use this setting, connect the optional subwoofer or rear speakers.
- **[Easy Network Setup]:** Performs the basic network settings.

4 Perform settings by following the on-screen instructions.

Sound Bar
HT-A3000

Using the [Advanced Settings] Menu

You can make various adjustments to items such as picture and sound on the [Advanced Settings] menu.









1 Press HOME.

The home menu appears on the TV screen.

2 Select  [Setup] - [Advanced Settings] on the home menu.

The [Advanced Settings] screen appears on the TV screen.

3 Select the setting item.

-  **[Speaker Settings]:** Makes the speakers settings for installing and connections.
-  **[Audio Settings]:** Makes the audio output settings.
-  **[HDMI Settings]:** Makes the HDMI settings.
-  **[Bluetooth Settings]:** Makes detailed settings for the BLUETOOTH function.
-  **[System Settings]:** Makes the speaker system-related settings.
-  **[Network Settings]:** Makes detailed settings for the Internet.
-  **[Resetting]:** Resets the speaker system to the factory default settings.
-  **[Software Update]:** Updates the software of the speaker system or optional subwoofer/rear speakers.

Sound Bar
HT-A3000

[Speaker Settings]

[Speaker Settings Information]

You can apply the [Sound Field Optimization] measured value, or the [Manual Speaker Settings] value to speaker settings. To use this setting, connect the optional subwoofer or rear speakers, execute [Sound Field Optimization] and disable [360 Spatial Sound Mapping].

[Sound Field Optimization value]: Applies the [Sound Field Optimization] measured value to speaker settings.

[Manual Speaker Settings value]: Applies the [Manual Speaker Settings] value to speaker settings.

[Sound Field Optimization]

This function automatically measures the distance from the bar speaker to the optional subwoofer (*1) and rear speakers (*1), and optimizes the surround sound quality for your environment.

Follow the on-screen instructions to start the measurements. Optimization will take up to 30 seconds. During optimization, the speakers may make loud sounds.

*1 This is measured only when using the optional subwoofer or rear speakers.

Note

- Do not make loud noises, walk or stand in front of the speakers during optimization.

[Sound Field Adjustment]

- **[Direction of sound field]**

Follow the instructions on the screen to set the positional relationship between the front speakers and the TV, and between the speakers and the listening position. This adjusts the direction from which you hear sound such as dialog to improve the synchronization of image and sound, and also adjusts the direction and balance of the sound to improve its realism.

To use this setting, connect the optional rear speakers and enable the [360 Spatial Sound Mapping] function.

- **[Height of sound field>(*1)]**

Adjust the height of the sound field.

*1 Depending on the rear speakers that are connected, this function may not be available.

- **[Test Tone]**

The test tone is played on the speakers to check for available speakers.

[On]: The test tone is played on the speakers.

[Off]: The test tone is not played on the speakers.

[Manual Speaker Settings]

You can set the speaker distance from your listening position and their output level, etc. to obtain the best possible surround sound.

To use this setting, disable [360 Spatial Sound Mapping].

- **[Distance]**

Set the distance from the listening position to the speaker.

You can set the value from 0 m to 10 m (0.1 m step) (0 ft to 33 ft (1/4 ft step)).

[Front]: Sets the front speaker distance.

[Subwoofer>(*1): Sets the optional subwoofer distance.

[Rear Speaker (L)](*2): Sets the optional left rear speaker distance.

[Rear Speaker (R)](*2): Sets the optional right rear speaker distance.

*1 This item appears when using the optional subwoofer.

*2 This item appears when using the optional rear speakers.

- **[Level]**

Adjust the sound level of the speakers.

You can set the value from -6.0 dB to 6.0 dB (0.5 dB step).

[Front]: Sets the front speaker level.

[Subwoofer>(*1): Sets the optional subwoofer level.

[Rear Speaker (L)](*2): Sets the optional left rear speaker level.

[Rear Speaker (R)](*2): Sets the optional right rear speaker level.

[Rear height (L)](*3): Sets the optional left rear height speaker level.

[Rear height (R)](*3): Sets the optional right rear height speaker level.

*1 This item appears when using the optional subwoofer.

*2 This item appears when using the optional rear speakers.

*3 This item appears when using the optional rear height speakers.

- **[Distance to the ceiling]**

Set the distance from the speaker to the ceiling.

[Front](*)1: Sets the front speaker distance. You can set the value from 1 m to 5 m (0.1 m step) (3.25 ft to 16.5 ft (1/4 ft step)).

[Rear Speaker (L)](*2): Selects the optional left rear speaker distance.

[Rear Speaker (R)](*2): Selects the optional right rear speaker distance.

*1 Depending on the rear speakers that are connected, this item may not be available.

*2 This item appears when using the optional rear speakers.

- **[Test Tone]**

The test tone is played on the speakers to check for available speakers.

[On]: The test tone is played on the speakers.

[Off]: The test tone is not played on the speakers.

Hint

- You can change measurement units (feet or meters) by pressing OPTIONS.

[Wireless Speaker Settings]

You can adjust various items related to wireless connection between the speaker system and optional subwoofer/rear speakers.

- **[Link mode]**

You can set the connection method for the optional subwoofer and rear speakers.

[Auto]: Connects the optional subwoofer and rear speakers to the speaker system automatically.

[Manual]: Connects the optional subwoofer and rear speakers manually.

- **[Start manual linking]**

Perform manual connection between the optional subwoofer/rear speakers and the speaker system. For details, refer to the operating instructions supplied with the optional speakers.

- **[Check wireless connection]**

You can check the connection status of the optional subwoofer and rear speakers.

- **[RF Channel]**

You can minimize interference with other wireless devices.

[On]: Normally select this. The speaker system automatically selects the better channel for transmission. This is the stronger mode against wireless interference.

[Off]: The speaker system selects a channel from the limited frequency band to prevent external wireless interference. If sound dropping occurs while [On] is selected, it may be improved by selecting [Off].

- **[Wireless Playback Quality]**

You can set the wireless playback quality of the optional subwoofer and rear speakers.

[Sound Quality]: The sound quality takes priority over the connection status of the wireless connection.

[Connection]: The connection status takes priority over the sound quality.

- **[Software Version]**

You can check the software version of the optional subwoofer and rear speakers.

Note

- [RF Channel], [Wireless Playback Quality], and [Software Version] become selectable only when the optional subwoofer and rear speakers are connected to the speaker system.
- [RF Channel] is not available in some countries/regions.

[TV Center Speaker Settings]

If you connect the speaker system and TV with the HDMI cable (supplied) and the TV center speaker mode cable (supplied), you can output the center speaker portion of the speaker system sound from the TV. Set [Control for HDMI] to [On].

- **[TV Center Speaker Mode]**

[On]: Uses a TV compatible with this feature as the center speaker.

[Off]: Off

- **[TV Position Setting]**

Follow the on-screen instructions to set up the speaker system positioning in relation to the TV so that the height at which the audio (e.g. dialog) can be heard is set to suit the height of the TV.

Note

- Depending on the audio content, sound may not be output from the TV.
- When the surround effect is set to [Sound Field: Effect On] by pressing SOUND FIELD on the remote control, sound is not output from the TV.

Sound Bar
HT-A3000

[Audio Settings]

[360 Spatial Sound Mapping]

Creates an amazing 360 Spatial Sound experience that makes the sound feel more spacious as if there are more speakers in the room.

Connect the optional rear speakers to use this setting.

[On]: Enables the [360 Spatial Sound Mapping] function.

[Off]: Disables the [360 Spatial Sound Mapping] function.

Note

- When the BLUETOOTH device is connected in BLUETOOTH transmission mode, the [360 Spatial Sound Mapping] setting is disabled.

[Sound Field Setting]

You can select the type of surround effect. This effect is available when the surround effect is set to [SF.ON] by pressing SOUND FIELD on the remote control.

You can change the settings when  [Audio Settings] - [360 Spatial Sound Mapping] is set to [Off].

When headphones are connected with the BLUETOOTH function, this function is not available.

[Sony | Vertical Surround Engine]: Sony | Vertical Surround Engine enhances the surround and height speaker channels to create an immersive and enveloping virtual surround effect.

[Dolby Speaker Virtualizer]: Dolby Speaker Virtualizer enhances the surround and height speaker channels to create an immersive and enveloping virtual surround effect when you play Dolby format. Disables sound effects other than Dolby format.

[DTS Virtual:X / DTS Neural:X]: Performs up mixing in accordance with the surround environment. This function is disabled while DTS format (96 kHz - 192 kHz), Dolby format or DSD format is playing.

[DSEE Extreme]

[On]: AI technology accurately reproduces frequency responses lost during compression, and it makes you feel as if you are in a recording studio or at a concert.

[Off]: Off

Note

- This function is compatible with the 2-channel digital input signals of 44.1 kHz or 48 kHz sampling frequency.
- This function is not compatible with DSD signals.
- The sampling frequency/bit depth after upscaling is up to 96 kHz/24 bit.
- This function does not work in the following conditions.
 - Chromecast built-in is used.
 - [Advanced Auto Volume] is set to [On].
 - The surround effect is set to [Sound Field: Effect On] by pressing SOUND FIELD on the remote control.

[Audio DRC]

You can compress the dynamic range of the audio signal to make it easier to hear quieter sounds.

[Auto]: Automatically compresses sound encoded in Dolby TrueHD.

[On]: Reproduces the Dolby and DTS sound track with the kind of dynamic range that the recording engineer intended.

[Off]: No compression of dynamic range.

[Advanced Auto Volume]

You can reduce the difference of volume due to the input signal. This function is effective when the volume of a TV commercial is louder than that of the TV program.

[On]: Adjusts the volume automatically.

[Off]: Off

Note

- Advanced Auto Volume function is not suitable for listening to music.

Related Topic

- [Enjoying Surround Effect \(SOUND FIELD\)](#)

Sound Bar
HT-A3000

[HDMI Settings]

[Control for HDMI]

[On]: The Control for HDMI function is enabled. Devices connected with an HDMI cable can control each other.

[Off]: Off

[Standby Linked to TV]

This function is available when you set [Control for HDMI] to [On].

[Auto]: If the input of the speaker system is [TV] or [HDMI], the speaker system turns off automatically when you turn off the TV.

[On]: The speaker system turns off automatically when you turn off the TV regardless of the input.

[Off]: The speaker system does not turn off when you turn off the TV.

[TV Audio Input Mode]

Set this function when the speaker system is connected to a TV's HDMI IN jack that is compatible with eARC or ARC. The eARC or ARC function is available when you set [Control for HDMI] to [On].

[Auto]: You can listen to TV sound from the speaker system. The sound of eARC or ARC takes priority while set to [Auto].

[Optical]: Use this setting when an optical digital cable is connected.

[eARC]

Set this function when the speaker system is connected to a TV's HDMI IN jack that is compatible with eARC. When connecting to a TV compatible with ARC (not compatible with eARC), the ARC function works regardless of this setting.

[On]: Enables the eARC function. The eARC function works when connecting a TV compatible with eARC.

[Off]: Disables the eARC function.

Note

- When [eARC] is set to [On], make sure of the eARC setting of the connected TV. For details, refer to the operating instructions of the TV.

Hint

- The speaker system is compatible with eARC (Enhanced Audio Return Channel). eARC is a new function standardized by HDMI2.1 and supports latest audio formats in addition to audio formats that are supported with existing ARC (Audio Return Channel).
You can enjoy object audio content, such as Dolby Atmos - Dolby TrueHD and DTS:X or multi-channel LPCM content that cannot be transmitted with ARC by connecting the speaker system and TV compatible with eARC using an HDMI cable.
For the connection, see "[Connecting a TV Compatible with ARC/eARC](#)."

Sound Bar
HT-A3000

[Bluetooth Settings]

[Bluetooth Mode]

You can enjoy content from a BLUETOOTH® device by using this speaker system or listen to sound from this speaker system by using BLUETOOTH compatible headphones.

[Receiver]: This speaker system is in receiver mode, which enables it to receive and output audio from the BLUETOOTH device.

[Transmitter]: This speaker system is in transmitter mode, which enables it to send audio to the BLUETOOTH compatible headphones. If you switch the input of the speaker system, [BT TX] appears on the front panel display.

[Off]: The BLUETOOTH function is turned off and you cannot select the [Bluetooth Audio] input.

Note

- When the [Bluetooth Mode] is set to [Transmitter], the following settings are disabled.
 - [360 Spatial Sound Mapping]
 - [Sound Field Setting]

[Device List]

When [Bluetooth Mode] is set to [Receiver]: A list of paired BLUETOOTH devices is displayed.

When [Bluetooth Mode] is set to [Transmitter]: A list of paired and detected BLUETOOTH headphones is displayed.

[Bluetooth Connection Quality]

You can set the BLUETOOTH connection quality for listening to audio of a mobile device using this speaker system.

This function is only available when you set [Bluetooth Mode] to [Receiver].

[Priority on Sound Quality]: Gives priority to sound quality. The codec is automatically selected as LDAC, AAC, or SBC depending on the compatible codec of the connected device.

[Priority on Stable Connection]: Gives priority to stable connection. The codec is set to SBC.

Note

- When connecting a BLUETOOTH device, the [Bluetooth Connection Quality] setting cannot be changed.

[Wireless Playback Quality]

You can set the transmission data rate of LDAC playback. This function is only available when you set [Bluetooth Mode] to [Transmitter].

[LDAC Sound Quality]: Enables LDAC codec and the highest bit rate is used. Sound is sent in a higher quality; however, audio playback sometimes may become unstable when the link quality is not good enough. If audio playback is unstable in this mode, select [LDAC Stable Connection (Auto)].

[LDAC Stable Connection (Auto)]: Enables LDAC codec and the data transfer rate is automatically changed depending on the environment.

[SBC Sound Quality]: Enables SBC codec. Sound is sent in a higher quality.

[SBC Stable Connection (Auto)]: Enables SBC codec and the data transfer rate is automatically changed depending on the environment.

Note

- When connecting a BLUETOOTH device, the [Wireless Playback Quality] setting cannot be changed.

5-034-491-11(3) Copyright 2022 Sony Corporation

Sound Bar
HT-A3000

[System Settings]

[Language]

You can select the language you want for the on-screen display of the speaker system.

[IR-Repeater]

[On]: Remote signals for the TV are sent from the rear of the bar speaker.

[Off]: Turns off the function.

[Network/Bluetooth Standby]

[On]: You can turn the speaker system on via the network or BLUETOOTH function.

[Off]: You can save power in standby mode. It may take time for sound to be output from the optional subwoofer or rear speakers after turning the speaker system on in this mode.

Note

- If you agree to use the Chromecast built-in function, [Network/Bluetooth Standby] automatically switches to [On].
- If you set [RF Channel] to [On], [Network/Bluetooth Standby] automatically switches to [On].

[Auto Standby]

[On]: Turns on the [Auto Standby] function. When you do not operate the speaker system while no signal is input for about 20 minutes, the speaker system enters standby mode automatically.

[Off]: Off

[Device Name Setting]

You can change the name of this speaker system according to your preference when using the following functions.

- The BLUETOOTH function
- The home network
- Spotify
- Chromecast built-in

Follow the on-screen instructions and use the software keyboard to enter the name.

[System Information]

You can display the speaker system information such as the software version.

[Software License Information]

You can display the Software License Information.

Sound Bar
HT-A3000

[Network Settings]

[Wi-Fi Connection]

[On]: Enables Wi-Fi connection of the speaker system.

[Off]: Disables Wi-Fi connection of the speaker system.

[Internet Settings]

You can set the network settings and check the network connections.

[Network Connection Status]

You can display the current network connection status.

[Software Update Notification]

[On]: Sets the speaker system to inform you of the latest software version information.

[Off]: Off

[Auto Update Settings]

- **[Auto Update]**

[On]: Software is updated automatically between 2 a.m. and 5 a.m. local time in the selected [Time Zone] while the speaker system is not in use. If you select [Off] for [Network/Bluetooth Standby], software updates are installed right after you turn off the speaker system.

[Off]: Off

- **[Time Zone]**

Select your area/city.

Note

- Software update may be performed even if you select [Off] in [Auto Update] depending on the details of the updates.
- Software update is performed automatically within 11 days of a new software release.
- If you agree to use the Chromecast built-in function, [Auto Update] automatically switches to [On].

[Privacy Setting]

The speaker system collects the information of your device usage. Read the privacy policy, which will appear when this setting is required, and decide whether you agree to information gathering.

[Agree]: Select this when you accept information gathering.

[Do not agree]: Select this when you do not accept information gathering.

Hint

- Even if you have selected [Agree], you will be able to stop information gathering by reselecting [Do not agree] or resetting [Network Settings] to the factory default via [Resetting].

[Chromecast built-in]

You can set sharing of usage data and confirm the Chromecast built-in feature.

- **[Share usage data]**

[On]: Provides information related to the use of the cast feature to Google™.

[Off]: Off

- **[About Chromecast built-in]**

Displays the reference URLs for the Chromecast built-in feature.

Sound Bar
HT-A3000

[Resetting]

You can reset the speaker system settings to the factory default by selecting the group of settings. All the settings within the group will be reset.

Related Topic

- [Resetting the Speaker System](#)

Sound Bar
HT-A3000

[Software Update]

You can update the software of the speaker system or optional subwoofer/rear speakers.

Related Topic

- [Updating the Software](#)

Sound Bar
HT-A3000

Updating the Software

By updating your software to the latest version, you can take advantage of the newest functions.
For information about update functions, visit the following website:

- For customers in Americas
<https://www.sony.com/am/support>
- For customers in Europe
<https://www.sony.eu/support>
- For customers in Asia-Pacific, Oceania, Middle East, and Africa
<https://www.sony-asia.com/support>

Note

- It may take up to 20 minutes for the update to be completed.
- An Internet environment is necessary to perform updates via the Internet.
- While the updating operation is in progress, do not turn on or off the speaker system, disconnect the AC power cord (mains lead), disconnect/connect an HDMI cable, or operate the speaker system or TV. Wait for the software update to complete.
- Set  [Setup] - [Advanced Settings] - [Network Settings] - [Auto Update Settings] - [Auto Update] to [On] when you want to perform software updates automatically. Software update may be performed even if you select [Off] in [Auto Update] depending on the details of the updates.



- 1 When using the optional subwoofer, make sure that it is turned on and connected to the speaker system. When using the rear speakers, make sure that they are connected to the wall outlet (mains), turned on, and connected to the speaker system.**

The power indicator(s) of the optional subwoofer and/or rear speaker light(s) in green.
- 2 Press HOME.**

The home menu appears on the TV screen.
- 3 Select  [Setup] - [Advanced Settings] on the home menu.**

If the speaker system detects update information for the speaker system on the network, the update notification and [Software Update] appear on the home menu. In this case, select [Software Update] and follow the on-screen instructions.
- 4 Select [Software Update].**

The [Software Update] screen appears on the TV screen.
- 5 Select the item for updating.**

Select the updating item from the following items by pressing  (up)/  (down) and  (enter), then update the software by following the on-screen instructions.
When a software update starts, the speaker system automatically reboots.
During a software update, [UPDATE] appears in the front panel display.

After the update is complete, the speaker system automatically reboots.

[Network Update]

Updates the software using the available network. Make sure that the network is connected to the Internet.

[USB Update]



Updates the software using a USB memory. For details on updating, refer to the instructions that are displayed when downloading the update file.

[Wireless Speakers Update]

When updating the software, connect the wireless speaker to the AC outlet (mains) and turn on.

Updates the software of the optional subwoofer and rear speakers when the software of the speaker system is the latest version.

Note

- You can perform [USB Update] by pressing and holding the  (BLUETOOTH) and  (power) button on the bar speaker for 7 seconds.
- If updating of the optional subwoofer or rear speakers does not work, move them to a location near the bar speaker and update.

Sound Bar
HT-A3000

Troubleshooting

If the speaker system does not work properly, handle it in the following order.

1. Search for the cause and solution of the issue by referring to these Help Guide or Operating Instructions.
The troubleshooting method is listed in "Troubleshooting."



2. Search for the cause and solution of the issue on the Sony support site.
Sony support site provides latest support information and Frequently Asked Questions.

- For customers in Americas
<https://www.sony.com/am/support>
- For customers in Europe
<https://www.sony.eu/support>
- For customers in Asia-Pacific, Oceania, Middle East, and Africa
<https://www.sony-asia.com/support>



3. Reset the speaker system.
All the settings of the speaker system return to their initial status.



4. Should any problems persist, consult your nearest Sony dealer.

Sound Bar
HT-A3000

The speaker system does not power up.

- Check that the AC power cord (mains lead) is connected securely.
- Disconnect the AC power cord (mains lead) from the wall outlet (mains), and then reconnect after several minutes.

Sound Bar
HT-A3000

The speaker system does not turn on even when the TV is turned on.

- Set  [Setup] - [Advanced Settings] - [HDMI Settings] - [Control for HDMI] to [On]. The TV must support the Control for HDMI function. For details, refer to the operating instructions of your TV.
- Check the speaker settings of the TV. The speaker system power syncs with the speaker settings of the TV. For details, refer to the operating instructions of your TV.
- Depending on the TV, if the sound was output from the speakers of the TV the previous time, the speaker system may not turn on by interlocking with the TV power even when the TV is turned on.

Sound Bar
HT-A3000

The speaker system turns off when the TV is turned off.

- Check the setting of  [Setup] - [Advanced Settings] - [HDMI Settings] - [Standby Linked to TV]. When [Standby Linked to TV] is set to [On] or [Auto], the speaker system turns off automatically when you turn off the TV.

Sound Bar
HT-A3000

The speaker system does not turn off even when the TV is turned off.

- Check the setting of  [Setup] - [Advanced Settings] - [HDMI Settings] - [Standby Linked to TV]. To turn the speaker system off automatically, regardless of the input when you turn off the TV, set [Standby Linked to TV] to [On]. The TV must support the Control for HDMI function. For details, refer to the operating instructions of your TV.

Sound Bar
HT-A3000

The speaker system cannot be turned off.

- The speaker system may be in demo mode. To cancel demo mode, reset the speaker system. Press and hold  (power) and – (volume) on the bar speaker for more than 5 seconds.

Sound Bar
HT-A3000

There is no picture or the picture is not output correctly.

- Select the appropriate input.
- When there is no picture while the TV input is selected, select the TV channel that you want using the TV remote control.
- Disconnect an HDMI cable, then connect it again. Make sure that the cable is firmly inserted.

Sound Bar
HT-A3000

The picture on the TV screen is distorted.

- Interference of the wireless function between the TV/other wireless devices and the speaker system may have occurred. Install the speaker system far away from the TV/other wireless devices.
- There is an interference of the frequency band between the wireless LAN and the wireless connection of the optional speakers. Switch the band of the wireless LAN connection of the TV or device that is playing an image to 2.4 GHz.



Sound Bar
HT-A3000

The speaker system cannot connect to a TV with the BLUETOOTH function.

- When you connect the speaker system and TV with an HDMI cable, the BLUETOOTH connection is canceled.

Sound Bar
HT-A3000

No TV sound is output from the speaker system.

- Check the type and connection of an HDMI cable, TV center speaker mode cable, or optical digital cable that is connected to the speaker system and the TV.
- Disconnect the cables that are connected to the TV and the speaker system, then connect them firmly again. Disconnect the AC power cords (mains leads) of the TV and the speaker system from the AC outlets (mains), then connect them again.
- When the speaker system and TV are connected with an HDMI cable, check the following.
 - The HDMI jack of the connected TV is labeled with “eARC” or “ARC.”
 - The Control for HDMI function of the TV is set to on.
 - The eARC or ARC function of the TV is enabled.
 - The number of connected devices that can be controlled by the Control for HDMI function has not exceeded the limit.
 - On the speaker system,  [Setup] - [Advanced Settings] - [HDMI Settings] - [Control for HDMI] is set to [On] and  [Setup] - [Advanced Settings] - [HDMI Settings] - [TV Audio Input Mode] is set to [Auto].
- If your TV is not compatible with eARC, set  [Setup] - [Advanced Settings] - [HDMI Settings] - [eARC] to [Off].
- If your TV is not compatible with eARC or ARC, connect an optical digital cable. If the TV is not compatible with eARC or ARC, TV sound will not be output from the speaker system even if the speaker system is connected to the TV's HDMI IN jack.
- Switch the input of the speaker system to the TV input.
- Increase the volume on the speaker system or cancel muting.
- Depending on the order in which you turn on the TV and the speaker system, the speaker system may be muted and [MUTING] is displayed on the front panel display of the speaker system. If this happens, turn on the TV first, then the speaker system.
- Press TV/AUDIO SYSTEM on the remote control to switch the output for the connected TV sound or set the speakers setting of your TV to Audio System. Refer to the operating instructions of your TV regarding how to set the TV.

Related Topic

- [Connecting a TV Compatible with ARC/eARC](#)
- [Connecting a TV That Is not Compatible with ARC/eARC](#)

Sound Bar
HT-A3000

The sound is output from both the speaker system and TV.

- Mute the sound of the speaker system or TV.
- When you connect the speaker system and TV with the TV center speaker mode cable and set  [Setup] - [Advanced Settings] - [Speaker Settings] - [TV Center Speaker Settings] - [TV Center Speaker Mode] to [On], the center part of the speaker system sound is output from the TV.

Sound Bar
HT-A3000

The TV sound from this speaker system lags behind the image.



- Set the adjustment value of the delay between the picture and sound to 0 msec if it is set to the range between 25 msec and 300 msec.
 - A time gap between the sound and picture may occur depending on the sound source. If your TV has a function that delays the image, use it for adjustment. For details, refer to the operating instructions of your TV.
-
-

Related Topic

- [Adjusting the Delay Between the Picture and Sound](#)

Sound Bar
HT-A3000

No sound or only a very low-level sound of the device connected to the speaker system is heard.

- Press  (volume) + on the remote control and check the volume level.
- Press  (muting) or  (volume) + on the remote control to cancel the muting function.
- Make sure the input source is selected correctly. You should try other input sources by pressing the input select button on the remote control (TV/USB/BLUETOOTH).
- Make sure that the connectors are firmly inserted.

Sound Bar
HT-A3000

The surround effect cannot be obtained.

- Depending on the combination of the setting of SOUND FIELD and input signal, surround sound processing may not work effectively. The surround effect may be subtle, depending on the program or disc.

Sound Bar
HT-A3000

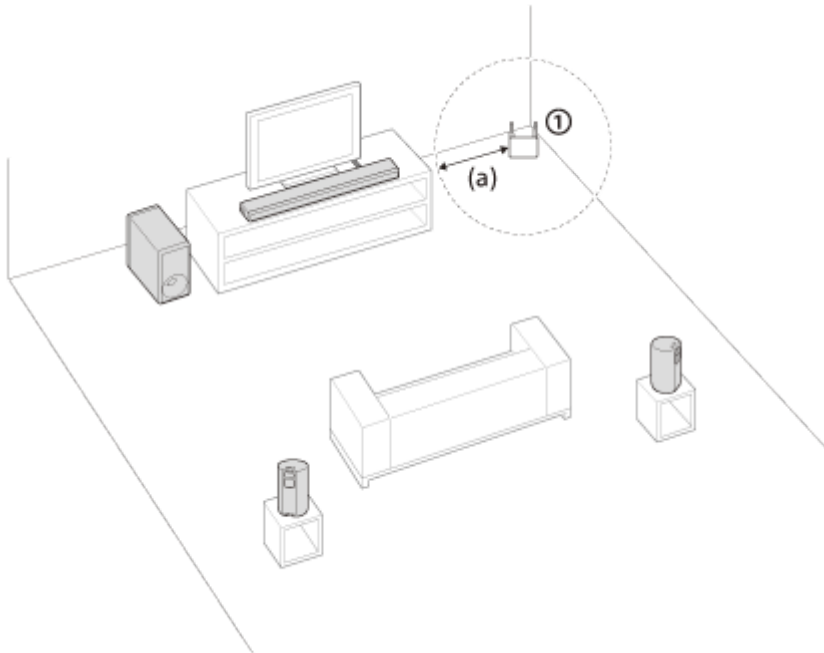

No sound is output from the optional rear speakers/subwoofer.

- Install the speaker system, the optional rear speakers and subwoofer at a distance of 1.5 m (5 ft) or more from a wireless LAN router, etc.
It may be improved by changing the direction or the antenna's angle of the wireless LAN router.



① Wireless LAN router, etc.

(a) 1.5 m (5 ft) or more

- It may be improved by setting  [Setup] - [Advanced Settings] - [Speaker Settings] - [Wireless Speaker Settings] - [Wireless Playback Quality] to [Connection].
- Set  [Setup] - [Advanced Settings] - [Speaker Settings] - [Wireless Speaker Settings] - [RF Channel] to [Off], then set to [On].
- If a device that generates electromagnetic radiation, such as a wireless LAN device or a microwave oven is nearby, move the speaker system away from the device.
- Refer to the operating instructions of the optional rear speakers/subwoofer.

Sound is not output from some speakers.

- Depending on the combination of the setting of SOUND FIELD and sound source, some speakers may not output sound.
- If sound is not output from the optional rear speakers
By pressing SOUND FIELD to turn on the surround effect, the speaker system upmixes audio signals, and sound is output from all speakers.

| Audio signal | Sound output from the optional rear speakers | |
|-----------------------|--|----------|
| | [SF.ON] | [SF.OFF] |
| 2-channel content | ⊙ | – |
| Multi-channel content | ⊙ | ⊙ |

⊙ : Sound is output from both the speaker system and the optional rear speakers.

–: Sound is output from the speaker system only. Sound is not output from the optional rear speakers.

Note

- When [Sound Field Setting] is set to [Dolby Speaker Virtualizer], some speakers may not output sound depending on the input content.
- Sound is not output from the optional rear speakers when Dual Mono audio is being played.

Sound Bar
HT-A3000

Sound Field Optimization failed.

- When using the optional rear speakers, install them upright so that the labels on the bottom of the speakers are directed downwards.
- Perform Sound Field Optimization again in a situation where the surrounding is quiet.
- If the distance between the bar speaker and optional rear speakers/subwoofer is too close or far away from each other, Sound Field Optimization cannot be performed properly. Adjust the distance between speakers and perform Sound Field Optimization again.
- If there is any obstacle between speakers or the microphone for measurement of the speaker is blocked by an obstacle, Sound Field Optimization cannot be performed properly. Remove it if there is any obstacle between speakers or in front of speakers.

Sound Bar
HT-A3000

The USB device is not recognized.

- Try the following:
 1. Turn the speaker system off.
 2. Remove and reconnect the USB device.
 3. Turn the speaker system on.
- Make sure that the USB device is securely connected to the  (USB) port.
- Check to see if the USB device is damaged.
- Make sure that the USB device is turned on.
- If the USB device is connected via a USB hub or cable, disconnect it and connect the USB device directly to the speaker system.
- When connecting a WALKMAN® or smartphone, its internal storage or external storage (such as a memory card) may not be recognized.

Sound Bar
HT-A3000

Pairing cannot be achieved.

- Bring this speaker system and the BLUETOOTH device closer together.
- Make sure this speaker system is not receiving interference from a wireless LAN device, other 2.4 GHz wireless devices, or a microwave oven. If a device that generates electromagnetic radiation is nearby, move the device away from this speaker system.

Sound Bar
HT-A3000

BLUETOOTH connection cannot be completed.

- Make sure that the BLUETOOTH indicator of the bar speaker is lit.
 - Make sure the BLUETOOTH device to be connected with is turned on and the BLUETOOTH function is enabled.
 - Bring this speaker system and the BLUETOOTH device closer together.
 - Pair this speaker system and the BLUETOOTH device again. You may need to cancel the pairing with this speaker system using your BLUETOOTH device first.
 - Pairing information may be deleted. Perform the pairing operation again.
-

Related Topic

- [Listening to Music by Pairing the Mobile Device That Is Connected for the First Time](#)

Sound Bar
HT-A3000

Sound of the connected BLUETOOTH mobile device is not output from the speaker system.

- Make sure that the BLUETOOTH indicator of the bar speaker is lit.
 - Bring this speaker system and the BLUETOOTH device closer together.
 - If a device that generates electromagnetic radiation, such as a wireless LAN device, other BLUETOOTH devices, or a microwave oven is nearby, move the device away from this speaker system.
 - Remove any obstacle between this speaker system and the BLUETOOTH device or move this speaker system away from the obstacle.
 - Reposition the connected BLUETOOTH device.
 - Switch the wireless LAN frequency of any nearby wireless LAN router or PC to the 5 GHz range.
 - Increase the volume on the connected BLUETOOTH device.
-

Related Topic

- [Listening to Music by Pairing the Mobile Device That Is Connected for the First Time](#)

Sound Bar
HT-A3000

Pairing cannot be achieved.

- Bring this speaker system and the BLUETOOTH headphones closer together.
- Make sure this speaker system is not receiving interference from a wireless LAN device, other 2.4 GHz wireless devices, or a microwave oven. If a device that generates electromagnetic radiation is nearby, move the device away from this speaker system.

Sound Bar
HT-A3000

BLUETOOTH connection cannot be completed.

- Make sure that the BLUETOOTH indicator of the bar speaker is lit.
 - Make sure the BLUETOOTH headphones to be connected with is turned on and the BLUETOOTH function is enabled.
 - Bring this speaker system and the BLUETOOTH headphones closer together.
 - Pair this speaker system and the BLUETOOTH headphones again. You may need to cancel the pairing for the BLUETOOTH headphones with this speaker system first.
 - Pairing information may be deleted. Perform the pairing operation again.
-

Related Topic

- [Listening to Music by Pairing the Mobile Device That Is Connected for the First Time](#)
- [Listening to Sound by Pairing with Headphones](#)

Sound Bar
HT-A3000

No sound is output from the connected BLUETOOTH headphones.

- Make sure that the BLUETOOTH indicator of the bar speaker is lit.
 - Bring this speaker system and the BLUETOOTH headphones closer together.
 - If a device that generates electromagnetic radiation, such as a wireless LAN device, other BLUETOOTH devices, or a microwave oven is nearby, move the device away from this speaker system.
 - Remove any obstacle between this speaker system and the BLUETOOTH headphones, or move this speaker system away from the obstacle.
 - Reposition the connected BLUETOOTH headphones.
 - Switch the wireless LAN frequency of any nearby wireless LAN router or PC to the 5 GHz range.
 - Increase the volume on the connected BLUETOOTH headphones.
 - Set  [Setup] - [Advanced Settings] - [Bluetooth Settings] - [Wireless Playback Quality] to [LDAC Stable Connection (Auto)] or [SBC Stable Connection (Auto)].
 - Some content may not be output due to content protection.
-

Related Topic

- [Listening to Music by Pairing the Mobile Device That Is Connected for the First Time](#)

Sound Bar
HT-A3000

The BLUETOOTH connection with the headphones becomes disconnected.

- When using Chromecast built-in, the headphones cannot connect to the speaker system via the BLUETOOTH function.

Sound Bar
HT-A3000

The speaker system cannot connect to the network, or the network connection is unstable.

- Make sure that the wireless LAN router is turned on.
- Check the network connection and network settings.
- Depending on the usage environment (including the wall material), radio wave reception conditions, or obstacles between the speaker system and wireless LAN router, the possible communication distance may be shortened. Move the speaker system and wireless LAN router closer to each other.
- Devices that use a 2.4 GHz frequency band, such as a microwave, BLUETOOTH, or digital cordless device, may interrupt communication. Move the speaker system away from such devices, or turn off such devices.
- The wireless LAN connection may become unstable depending on the usage environment, especially while using the BLUETOOTH function of the speaker system. In this case, adjust the usage environment.

Sound Bar
HT-A3000

The wireless LAN router you want is not shown in the wireless network list.

- Press **OPTIONS** on the remote control to update the list. If the wireless LAN router you want is still not detected, select **[New connection registration]** from the network list, then input a network name (SSID) manually.

Sound Bar
HT-A3000

You cannot connect the speaker system to the Internet.

- Check the wireless LAN connection.
- Restart the wireless LAN router.

5-034-491-11(3) Copyright 2022 Sony Corporation

Sound Bar
HT-A3000

The remote control of this speaker system does not function.

- Point the remote control at the remote control sensor on the bar speaker.
 - Remove any obstacles in the path between the remote control and the speaker system.
 - Replace both batteries in the remote control with new ones if they are weak.
 - Make sure you are pressing the correct button on the remote control.
-

Related Topic

- [Bar Speaker](#)

Sound Bar
HT-A3000

TV remote control does not work.





- This problem might be solved by enabling the IR repeater function.
-

Related Topic

- [When the TV Remote Control Does not Work](#)



Sound Bar
HT-A3000

No sound or only a very low-level sound is heard from the optional speaker.

- Press SW  (subwoofer volume) + on the remote control to increase the subwoofer volume, or press REAR  (rear speakers volume) + to increase the rear speaker volume.
- Check the wireless connection status in  [Setup] - [Advanced Settings] - [Speaker Settings] - [Wireless Speaker Settings] - [Check wireless connection].
- Set the night mode to off.
- If you change the  [Setup] - [Advanced Settings] - [Speaker Settings] - [Wireless Speaker Settings] - [RF Channel] setting from [Off] to [On], it may take 1 minute for the sound to be output.
- Refer to the operating instructions of the optional rear speakers/subwoofer.

Sound Bar
HT-A3000

Sound skips or has noise.

- If there is a device nearby that generates electromagnetic waves, such as a wireless LAN or a microwave oven in use, set the optional speaker and the speaker system apart from it.
- If there is an obstacle between the optional speaker and the speaker system, move or remove it.
- Set the optional speaker and the speaker system in a position as close as possible.
- Change the  [Setup] - [Advanced Settings] - [Speaker Settings] - [Wireless Speaker Settings] - [RF Channel] setting to [Off], and then change to [On] again.
- Switch the network connection of the TV or Blu-ray Disc player from wireless to wired.
- Set  [Setup] - [Advanced Settings] - [Speaker Settings] - [Wireless Speaker Settings] - [Wireless Playback Quality] to [Connection].

The Control for HDMI function does not work properly.

- Check the connection with the speaker system.
 - Enable the Control for HDMI function on the TV. For details, refer to the operating instructions of your TV.
 - Wait a while, and then try again. If you unplug the speaker system, it will take a while before operations can be made. Wait for 15 seconds or longer, and then try again.
 - Make sure the TV connected to the speaker system support the Control for HDMI function.
 - The type and number of devices that can be controlled by the Control for HDMI function are restricted by the HDMI CEC standard as follows:
 - Recording devices (Blu-ray Disc recorder, DVD recorder, etc.): up to 3 devices
 - Playback devices (Blu-ray Disc player, DVD player, etc.): up to 3 devices (this speaker system uses one of them)
 - Tuner-related devices: up to 4 devices
 - Audio system (receiver/headphones): up to 1 device (used by this speaker system)
-

Related Topic

- [Connecting a TV Compatible with ARC/eARC](#)
- [Connecting a TV That Is not Compatible with ARC/eARC](#)

Sound Bar
HT-A3000

[PRTCT] flashes in the front panel display for 5 seconds and the speaker system is turned off.

- Disconnect the AC power cord (mains lead) and make sure nothing is obstructing the ventilation holes of the speaker system.

Sound Bar
HT-A3000

[PRTCT], [PUSH], speaker name ([SUB], [RL], or [RR]), and [POWER] flash alternately in the front panel display.

-
- Press  (power) on the corresponding speaker ([SUB]: optional subwoofer, [RL]: optional left rear speaker, [RR]: optional right rear speaker) to turn each off. For the optional rear speaker, disconnect the AC power cord (mains lead), then restart the speaker system. For the optional subwoofer, disconnect the AC power cord (mains lead) and make sure nothing is obstructing the ventilation holes of the optional subwoofer, then restart the speaker system. If they are reconnected properly, the display in the front panel display returns to the normal display.

Sound Bar
HT-A3000

[HIGH], [TEMP], and [ERROR] appear alternately for 2 seconds each in the front panel display, [STANDBY] appears in the front panel display, then the speaker system is turned off.

-
- High-temperature is detected in the speaker system. Press  (power) to restart the speaker system.

Sound Bar
HT-A3000

[BT TX] appears in the front panel display.

-
- Set  [Setup] - [Advanced Settings] - [Bluetooth Settings] - [Bluetooth Mode] to [Receiver]. [BT TX] appears in the front panel display if [Bluetooth Mode] is set to [Transmitter].

Sound Bar
HT-A3000

Sensors of the TV do not work properly.

- The bar speaker may block some sensors (such as the brightness sensor), the remote control receiver of your TV or the emitter for 3D glasses (infrared transmission) of a 3D TV that supports the infrared 3D glass system, or wireless communication. Move the bar speaker away from the TV within a range that allow those parts to operate properly. For the locations of the sensors and remote control receiver, refer to the operating instructions of the TV.

Sound Bar
HT-A3000

Wireless functions (wireless LAN, the BLUETOOTH function, or optional subwoofer/rear speakers) are unstable.

- Do not place metal objects other than a TV around the speaker system.

Sound Bar
HT-A3000

Music that you are not familiar with suddenly plays.

- The pre-installed sample music may have been played. Press  (input select) on the bar speaker to stop playback.

Sound Bar
HT-A3000

The speaker system cannot be turned off or [Advanced Settings] cannot be used./When pressing the power button, [.DEMO] appears in the front panel display and the speaker system cannot be turned off.

-
- The speaker system may be in demo mode. To cancel demo mode, reset the speaker system. Press and hold  (power) and – (volume) on the bar speaker for more than 5 seconds.

Sound Bar
HT-A3000

Spotify cannot be played with the MUSIC SERVICE button, or cannot be played on the way of playback.

- Play music on Spotify on the speaker system by using the Spotify Connect function on the Spotify app of the mobile device.

Sound Bar
HT-A3000

The speaker system restarts.

- When connecting to a TV with a resolution that is different from that of the speaker system, the speaker system may restart to reset the picture output setting.

Sound Bar
HT-A3000

Resetting the Speaker System

If the speaker system still does not operate properly, reset the speaker system as follows.

- 1 **Press HOME.**
The home menu appears on the TV screen.
- 2 **Select  [Setup] - [Advanced Settings] on the home menu.**
- 3 **Select [Resetting].**
- 4 **Select the menu item you want to reset.**
- 5 **Select [Start].**

To cancel resetting

Select [Cancel] in step 5.

If you cannot perform resetting using the home menu

Press and hold  (power) and – (volume) on the bar speaker for more than 5 seconds.

The settings return to their initial status.

Note

- By resetting, the link with the optional subwoofer and rear speakers may be lost. In this case, reconnect them by referring to their operating instructions.

Sound Bar
HT-A3000

Playable Types of Audio Files

| Codec | Extension |
|------------------------------|------------------------|
| MP3 (MPEG-1 Audio Layer III) | .mp3 |
| AAC/HE-AAC | .m4a, .aac, .mp4, .3gp |
| WMA9 Standard | .wma |
| LPCM | .wav |
| FLAC | .flac |
| DSF | .dsf |
| DSDIFF(*) | .dff |
| AIFF | .aiff, .aif |
| ALAC | .m4a |
| Vorbis | .ogg |
| Monkey's Audio | .ape |

* The speaker system does not play DST encoded files.

Note

- Some files may not play depending on the file format, file encoding, recording condition, or other conditions.
- Some files edited on a PC may not play.
- Fast forward or fast reverse may not be available with some files.
- The speaker system does not play coded files such as DRM.
- The speaker system cannot recognize a file/folder depending on the name/meta-data.
- Some USB devices may not work with this speaker system.
- The speaker system can recognize Mass Storage Class (MSC) devices (such as flash memory).

Sound Bar
HT-A3000

Supported Input Audio Formats

Supported audio formats differ depending on the input setting of the speaker system. “○” indicates the supported audio format and “-” indicates the unsupported audio format in the table below.

| Format | TV input (eARC) | TV input (ARC) | TV input (OPT) |
|--|-----------------|----------------|----------------|
| LPCM 2ch | ○ | ○ | ○ |
| LPCM 5.1ch | ○ | - | - |
| LPCM 7.1ch | ○ | - | - |
| Dolby Digital | ○ | ○ | ○ |
| Dolby TrueHD | ○ | - | - |
| Dolby Digital Plus | ○ | ○ | - |
| Dolby Atmos | ○ | - | - |
| Dolby Atmos - Dolby TrueHD | ○ | - | - |
| Dolby Atmos - Dolby Digital Plus | ○ | ○ | - |
| DTS | ○ | ○ | ○ |
| DTS-ES Discrete 6.1, DTS-ES Matrix 6.1 | ○ | ○ | ○ |
| DTS 96/24 | ○ | ○ | ○ |
| DTS-HD High Resolution Audio | ○ | - | - |
| DTS-HD Master Audio | ○ | - | - |
| DTS:X | ○ | - | - |

On BLUETOOTH® Communication

- BLUETOOTH devices should be used within approximately 10 meters (33 feet) (unobstructed distance) of each other. The effective communication range may become shorter under the following conditions.
 - When a person, metal object, wall or other obstruction is between the devices with a BLUETOOTH connection
 - Locations where a wireless LAN is installed
 - Around microwave ovens that are in use
 - Locations where other electromagnetic waves occur
- BLUETOOTH devices and wireless LAN (IEEE 802.11 b/g/n) use the same frequency band (2.4 GHz). When using your BLUETOOTH device near a device with wireless LAN capability, electromagnetic interference may occur. This could result in lower data transfer rates, noise, or inability to connect. If this happens, try the following remedies:
 - Use this speaker system at least 10 meters (33 feet) away from the wireless LAN device.
 - Turn off the power to the wireless LAN device when using your BLUETOOTH device within 10 meters (33 feet).
 - Install this speaker system and BLUETOOTH device as closer to each other as possible.
- The radio waves broadcast by this speaker system may interfere with the operation of some medical devices. Since this interference may result in malfunction, always turn off the power on this speaker system and BLUETOOTH device in the following locations:
 - In hospitals, on trains, in airplanes, at gas stations, and any place where flammable gasses may be present
 - Near automatic doors or fire alarms
- This speaker system supports security functions that comply with the BLUETOOTH specification to ensure secure connection during communication using BLUETOOTH technology. However, this security may be insufficient depending on the setting content and other factors, so always be careful when performing communication using BLUETOOTH technology.
- Sony cannot be held liable in any way for damages or other loss resulting from information leaks during communication using BLUETOOTH technology.
- BLUETOOTH communication is not necessarily guaranteed with all BLUETOOTH devices that have the same profile as this speaker system.
- BLUETOOTH devices connected with this speaker system must comply with the BLUETOOTH specification prescribed by the Bluetooth SIG, Inc., and must be certified to comply. However, even when a device complies with the BLUETOOTH specification, there may be cases where the characteristics or specifications of the BLUETOOTH device make it impossible to connect, or may result in different control methods, display or operation.
- Noise may occur or the audio may cut off depending on the BLUETOOTH device connected with this speaker system, the communications environment, or surrounding conditions.

If you have any questions or problems concerning your speaker system, please consult your nearest Sony dealer.

Sound Bar
HT-A3000

Copyrights and Trademarks

This speaker system incorporates Dolby(*) Digital and the DTS(**) Digital Surround System.

* Dolby, Dolby Atmos, and the double-D symbol are registered trademarks of Dolby Laboratories Licensing Corporation. Manufactured under license from Dolby Laboratories. Confidential unpublished works. Copyright © 2012–2022 Dolby Laboratories. All rights reserved.

** For DTS patents, see <http://patents.dts.com>.

Manufactured under license from DTS, Inc. DTS, DTS:X, and the DTS:X logo are registered trademarks or trademarks of DTS, Inc. in the United States and other countries. © 2022 DTS, Inc. ALL RIGHTS RESERVED.

The Bluetooth® word mark and logos are registered trademarks owned by Bluetooth SIG, Inc. and any use of such marks by Sony Group Corporation and its subsidiaries is under license.

The terms HDMI™, HDMI High-Definition Multimedia Interface, and the HDMI Logo are trademarks or registered trademarks of HDMI Licensing Administrator, Inc.

Google, Google Play, Google Home and Chromecast built-in are trademarks of Google LLC. Google Assistant is not available in certain languages and countries.

Apple, AirPlay, iPad, iPhone, iPod touch and Siri are trademarks of Apple Inc., registered in the U.S. and other countries.

Use of the Works with Apple badge means that an accessory has been designed to work specifically with the technology identified in the badge and has been certified by the developer to meet Apple performance standards.

“BRAVIA” logo is a trademark of Sony Corporation.

WALKMAN® and WALKMAN® logo are registered trademarks of Sony Corporation.

“PlayStation” is a registered trademark or trademark of Sony Interactive Entertainment Inc.

MPEG Layer-3 audio coding technology and patents licensed from Fraunhofer IIS and Thomson.

Windows Media is either a registered trademark or trademark of Microsoft Corporation in the United States and/or other countries.

This product is protected by certain intellectual property rights of Microsoft Corporation. Use or distribution of such technology outside of this product is prohibited without a license from Microsoft or an authorized Microsoft subsidiary.

Wi-Fi®, Wi-Fi Protected Access® and Wi-Fi Alliance® are registered trademarks of Wi-Fi Alliance.

Wi-Fi CERTIFIED™, WPA™, and WPA2™ are trademarks of Wi-Fi Alliance.

LDAC™ and LDAC logo are trademarks of Sony Corporation.

LDAC is an audio coding technology developed by Sony that enables the transmission of High-Resolution (Hi-Res) Audio content, even over a Bluetooth connection. Unlike other Bluetooth compatible coding technologies such as SBC, it operates without any down-conversion of the Hi-Res Audio content(*), and allows approximately three times more data(**) than those other technologies to be transmitted over a Bluetooth wireless network with unprecedented sound quality, by means of efficient coding and optimized packetization.

* excluding DSD format contents

** in comparison with SBC (Subband Coding) when the bitrate of 990 kbps (96/48 kHz) or 909 kbps (88.2/44.1 kHz) is selected

This product contains software that is subject to the GNU General Public License (“GPL”) or GNU Lesser General Public License (“LGPL”). These establish that customers have the right to acquire, modify, and redistribute the source code of said software in accordance with the terms of the GPL or the LGPL.

For details of the GPL, LGPL and other software licenses, please refer to [Software License Information] under  [Setup] - [Advanced Settings] - [System Settings] on the product.

You may find a copy of the relevant source code as required under the GPL/LGPL (and other licenses) at the following URL. You may obtain the source code as required by the GPL/LGPL on a physical medium from us for a period of three years after our last shipment of this product by applying through the form at the following URL.

This offer is valid to anyone in receipt of this information.

<https://oss.sony.net/Products/Linux/>

Please note that Sony cannot answer or respond to any inquiries regarding the content of this source code.

“DSEE Extreme” is a trademark of Sony Corporation.

“TRILUMINOS” and “TRILUMINOS” logo are a registered trademark of Sony Corporation.

The Spotify Software is subject to third party licenses found here:

<https://www.spotify.com/connect/third-party-licenses>.

Spotify and Spotify logos are trademarks of the Spotify Group.*)

* Depending on the country and region, this function may not be available.

Amazon, Alexa and all related logos are trademarks of Amazon.com, Inc. or its affiliates.

All other trademarks are trademarks of their respective owners.

5-034-491-11(3) Copyright 2022 Sony Corporation