

EKI-KxxxT4xx Series

4K Value Express Kits

Cameras

- 1/3" (4 MP) Progressive Scan CMOS
- 2560 x 1440 (4 MP) Resolution
- 2.8 mm Fixed Lens
- EXIR 2.0 with 100 ft (30 m) IR Range
- H.265+/H.265/H.264+/H.264/MJPEG
- IP67 Protection
- Durable Metal Housing
- 120 dB WDR for Clear Images

NVR

- Up to 8 MP Resolution Recording
- H.265+/H.265/H.264+/H.264/MPEG
- Plug-and-Play with 4, 8, or 16 PoE Cameras
- Up to 2 SATA Interfaces

Hikvision EKI-KxxxT4xx Series 4K Value Express Kits are cost-effective solutions for value-oriented users.

Each kit is supplied with four, six, or twelve network cameras with 4 MP image sensors and a 4-, 8-, or 16-channel NVR in the same box.

Kits are plug-n-play and can be set up quickly.

Available models:

EKI-K41T44

(1) ERI-K104-P4 NVR + (4) ECI-T2(4)4F2 Cameras

EKI-K82T46

(1) ERI-K108-P8 NVR + (6) ECI-T2(4)4F2 Cameras

EKI-K164T412

(1) ERI-K216-P16 NVR + (12) ECI-T2(4)4F2 Cameras

EKI-K41T44 Kit



(4) 4 MP Cameras



(1) 4 PoE Port NVR

EKI-K82T46 Kit



(6) 4 MP Cameras



(1) 8 PoE Port NVR

EKI-K164T412 Kit



(12) 4 MP Cameras



(1) 16 PoE Port NVR



Specifications

	EKI-K41T44	EKI-K82T46	EKI-K164T412
Camera			
Camera Model	ECI-T2(4)4F2		
Image Sensor	1/3" (4 MP) progressive scan CMOS		
Minimum Illumination	Color: 0.15 lux @ (f/2.0, AGC on); 0.03 lux @ (f/2.0, AGC on), 0 lux with IR		
Shutter Speed	1/3 s to 1/100,000 s		
Slow Shutter	Yes		
Auto-Iris	No		
Day/Night	IR cut filter		
Digital Noise Reduction	3D DNR		
WDR	120dB WDR		
Angle Adjustment	Pan: 0° to 360°, tilt: 0° to 75°, rotation: 0° to 360°		
Lens			
Focal Length	2.8 mm		
Aperture	f/2.0		
Field of View	Horizontal 100°, vertical 55°, diagonal 117°		
Lens Mount	M12		
IR			
IR Range	Up to 100 ft (30 m)		
Wavelength	850 nm		
Compression Standard			
Video Compression	Main stream: H.265+/H.265/H.264+/H.264; sub-stream: H.265+/H.265/H.264+/H.264/MJPEG		
H.264 Type	Baseline profile/main profile/high profile		
H.264+	Main stream		
Video Bit Rate	32 Kbps to 8 Mbps		
Smart Features			
Region of Interest	One fixed region for main stream and sub-stream		
Image			
Maximum Resolution	2560 × 1440		
Main Stream	20 fps (2560 × 1440), 30 fps (2304 × 1296, 1920 × 1080, 1280 × 720)		
Sub-Stream	30 fps (640 × 480, 640 × 360, 320 × 240)		
Image Enhancement	BLC, 3D DNR		
Image Setting	Saturation, brightness, contrast, sharpness, AGC, white balance adjustable by client software or Web browser		
Day/Night Switch	Auto, scheduled		
Network			
Network Storage	Supports NAS (NFS, SMB/CIFS)		
Alarm Trigger	Motion detection, video tampering alarm, illegal login		
Protocols	TCP/IP, ICMP, HTTP, HTTPS, FTP, DHCP, DNS, DDNS, RTP, RTSP, RTCP, NTP, UPnP, SMTP, IGMP, 802.1x, QoS, IPv6, UDP, Bonjour		
General Function	Anti-flicker, heartbeat, mirror, password protection, privacy mask, watermark		
API	ONVIF (PROFILE S, PROFILE G), ISAPI		
Simultaneous Live View	Up to 6 channels		
User/Host	Up to 32 users; three levels: administrator, operator, and user		
Client	iVMS-4200, Hik-Connect		
Web Browser	IE 8+, Chrome 31 to 44, Firefox 30.0 to 51, Safari 8.0+		
Interface			
Communication Interface	1-Port RJ-45 10M/100M self-adaptive Ethernet port		
General			
Operating Conditions	-22° to 122° F (-30° to 50° C); humidity: 95% or less (non-condensing)		
Power Supply	12 VDC ±25%, 5.5 mm coaxial power plug; PoE (802.3af, class 3)		
Power Consumption and Current	12 VDC, 0.4 A, maximum: 5 W; PoE: (802.3af, 36 V to 57 V), 0.2 A to 0.1 A, maximum: 6.5 W		
Protection Level	IP67		
Material	Metal and plastic		
Dimensions	Camera: Ø4.3" x 3.7" (Ø110 mm x 93.2 mm)		
Weight	Camera: 0.80 lbs (360 g)		

Specifications (continued)

NVR			
NVR Model	ERI-K104-P4	ERI-K108-P8	ERI-K216-P16
Video/Audio Input			
IP Video Input	4-ch	8-ch	16-ch
	Up to 8 MP resolution		
Two-Way Audio	1-ch, RCA (2.0 Vp-p, 1k Ω)		
Network			
Incoming Bandwidth	40 Mbps	80 Mbps	160 Mbps
Outgoing Bandwidth	80 Mbps		
Video/Audio Output			
Recording Resolution	8 MP/6 MP/5 MP/4 MP/3 MP/1080p/UXGA/720p/VGA/4CIF/DCIF/2CIF/CIF/QCIF		
HDMI Output Resolution	1-ch, 1920 × 1080p, 1600 × 1200, 1280 × 1024, 1280 × 720, 1024 × 768		
VGA Output Resolution	1-ch, 1920 × 1080p, 1600 × 1200, 1280 × 1024, 1280 × 720, 1024 × 768		
Audio Output	1-ch, RCA (linear, 1k Ω)		
Decoding			
Decoding Format	H.265/H.265+/H.264/H.264+/MPEG4		
Live View/Playback Resolution	8 MP/6 MP/5 MP/4 MP/3 MP/1080p/UXGA/720p/VGA/4CIF/DCIF/2CIF/CIF/QCIF		
Synchronous Playback	4-ch	8-ch	16-ch
Capability	1-ch @ 8 MP/4-ch @ 1080p		
Network Management			
Network Protocols	TCP/IP, DHCP, Hik-Connect, DNS, DDNS, NTP, SADP, SMTP, NFS, iSCSI, UPnP™, HTTPS		
Hard Disk			
SATA	1 SATA interface	2 SATA interfaces	
Drive Bays	1	2	
Capacity for Each Disk	Up to 8 TB		
External Interface			
Network Interface	1, RJ-45 10/100/1000 Mbps self-adaptive Ethernet interface		
USB Interface	2 × USB 2.0		
PoE Interface			
Interface	4, RJ-45 10/100 Mbps self-adaptive Ethernet interface	8, RJ-45 10/100 Mbps self-adaptive Ethernet interface	16, RJ-45 10/100 Mbps self-adaptive Ethernet interface
Power	≤50 W	≤80 W	≤150 W
Standard	IEEE 802.3 af/at		
General			
Power Supply	48 VDC	100 to 240 VAC	
Power	≤65 W	≤180 W	≤280 W
Consumption (w/o Hard Disk)	≤10 W (w/o enabling PoE)	≤15 W	
Working Temperature	14 to 131° F (-10 to 55° C)		
Working Humidity	10% to 90% (non-condensing)		
Chassis	1U chassis		
Dimensions (W × D × H)	12.4" × 9.4" × 1.9" (315 mm × 240 mm × 48 mm)	15.2" × 12.4" × 2.0" (385 mm × 315 mm × 52 mm)	
Weight (w/o Hard Disk)	2.2 lb (≤1 kg)	5.7 lb (≤2.6 kg)	

Dimensions

ECI-T2(4)4F2

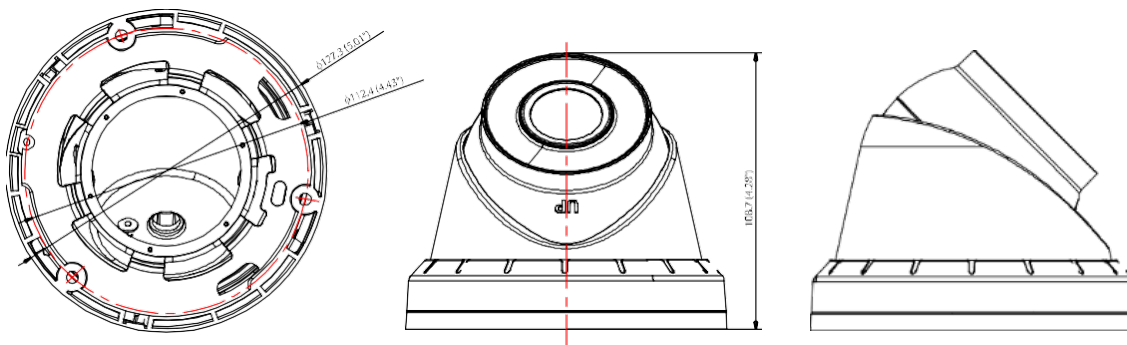

Unit: mm (inch)

Interface

ERI-K104-P4 Rear Panel

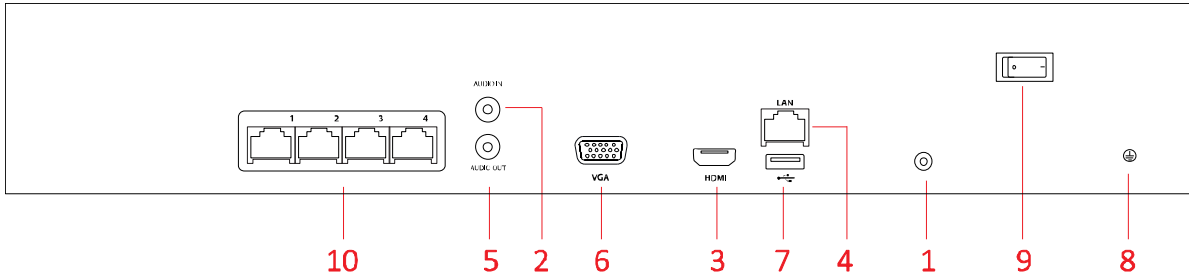

ERI-K108-P8 Rear Panel

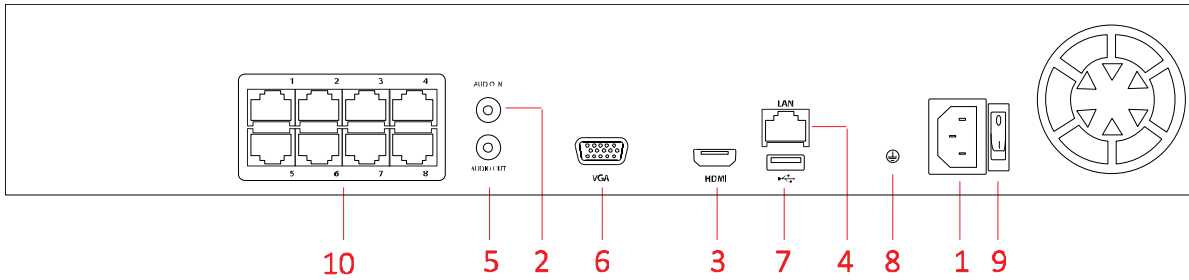



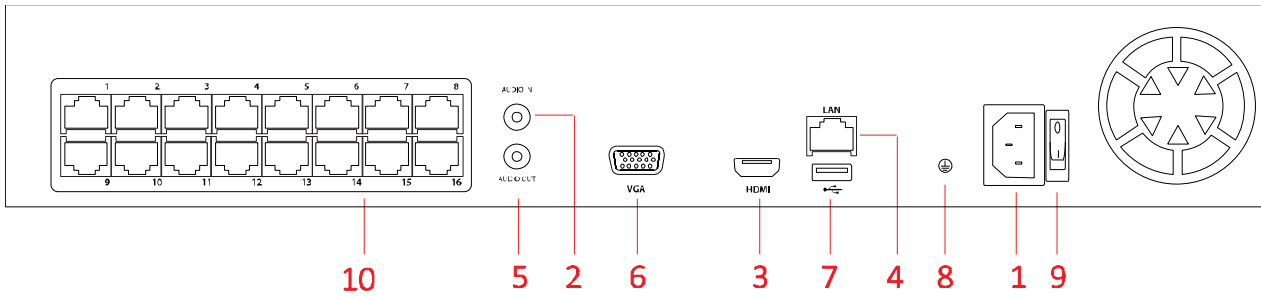



ERI-K216-P16 Rear Panel



Index	Description	Index	Description
1	48 VDC Power Supply	6	VGA Interface
2	Audio In	7	USB 2.0 Interface
3	HDMI Interface	8	Ground
4	LAN Interface	9	Power Switch
5	Audio Out	10	LAN Network Interfaces with PoE Function

Accessories (Not Included)

					
PC130T 130 mm Pendant Cap	WMS Short Wall Mount w/ Junction Box	PM Pole Mount Adapter	CM Corner Mount Adapter	CBM Conduit Base	CPM Ceiling Pendant Mount