

NETWORK VIDEO RECORDER

Quick Guide









XRN-6420DB4/XRN-6420B4/XRN-3220B4

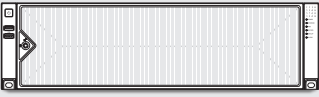

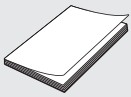
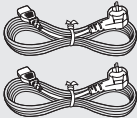
Package Contents



- The appearance of the components may differ from the image shown.
- Accessory category and quantity may differ depending on sales region.
- For some regions, HDD is not pre-installed. HDD Fixing Screw, SATA Cable quantity vary depending on the model.

		
Recorder	Mouse	Quick Guide
		
Power Cable (2 ea) (XRN-6420DB4)	Power Cable (XRN-6420B4/XRN-3220B4)	Terminal Block (2 ea)
		
Front Cover Lock Key	HDD Fixing Screw (64 ea)	Anti-slip Rubber Pad
		
Hard Disk Number Sticker		

Hanwha Vision Co., Ltd. is a surveillance camera manufacturer that provides video information equipment with various functions. Users must comply with local laws when using our devices. Users are solely responsible for any illegal use of our products.

Installing the HDD



- If you are adding a new or previously used HDD to this product in addition to the HDD(s) originally installed, format the new HDD manually in the set before use.
- If you wish to replace or add an HDD, contact your dealer or our customer service first.

- 1 Use the front cover lock key to unlock the cover. Grab the front cover with both hands and pull it to the left to remove it.

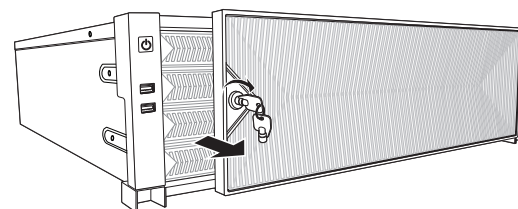

- 2 Press the orange button on the hard disk bracket to the left and pull forward to separate the main body and the hard disk bracket.

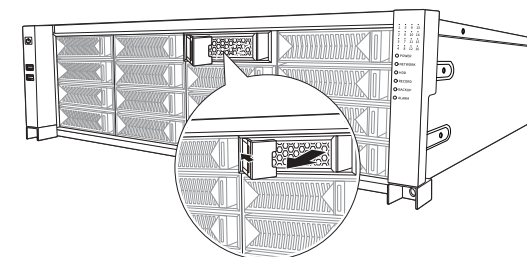

- 3 Mount a HDD in the HDD bracket and screw it in using the screws provided.

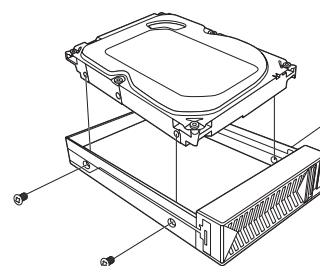

- 4 Once the HDD is mounted in the bracket, push the bracket into the main body and close the front cover.

- Fit the front cover into the right notch of the main body, then press and close until you hear a 'click'.
- Use the front cover lock key to lock the front cover so that it does not get separated.

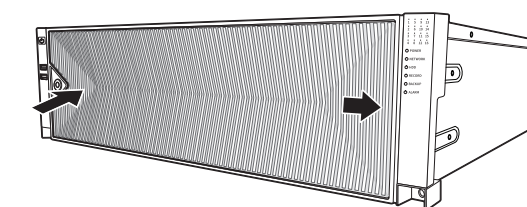

CAUTION

- RISK OF EXPLOSION IF BATTERY IS REPLACED BY AN INCORRECT TYPE. DISPOSE OF USED BATTERIES ACCORDING TO THE INSTRUCTIONS.
- Do not ingest battery, Chemical Burn Hazard.
- This product contains a coin / button cell battery. If the coin / button cell battery is swallowed, it can cause severe internal burns in just 2 hours and can lead to death.
- Keep new and used batteries away from children. If the battery compartment does not close securely, stop using the product and keep it away from children. If you think batteries might have been swallowed or placed inside any part or the body, seek immediate medical attention.

ATTENTION

- IL Y A RISQUE D'EXPLOSION SI LA BATTERIE EST REMPLACÉE PAR UNE BATTERIE DE TYPE INCORRECT. METTRE AU REBUT LES BATTERIES USAGÉES CONFORMÉMENT AUX INSTRUCTIONS.
- Ne pas ingérer la pile, risque de brûlure chimique.
- Ce produit contient une pile de type bouton/pièce de monnaie. Si la pile de type bouton/pièce de monnaie est avalée, elle peut causer de graves brûlures internes en seulement 2 heures et peut entraîner la mort.
- Gardez les piles neuves et usagées hors de portée des enfants. Si le compartiment de la pile ne se ferme pas correctement, cessez d'utiliser le produit et gardez-le d'atteinte des enfants. Si vous suspectez que des piles ont été avalées ou insérées dans une partie du corps, consultez un médecin sans tarder.

Installing the Rack

Rack Installation Requirements and Reference Dimensions

Classification	Requirements
Rack type	19-inch rack of EIA-310-D standard
POST count	4
POST distance	Depth 800 mm

Dimensions of mounting flange

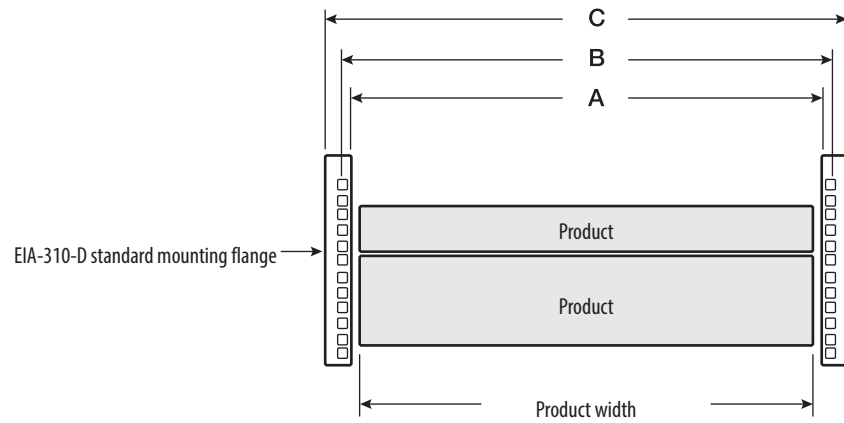

• Notable dimensions

Index	Dimension
A	450 mm (17.717 inches) min.
B	465 mm (18.307 inches) nominal
C	483.4 mm (19.031 inches) min.

- Flange mounting holes (square holes are recommended for XRN-6420/XRN-3220 series)
While EIA-310-D standard allows the mounting flange holes to be round, square, or tapped (threaded), the XRN-6420/XRN-3220 series is only designed to work with round or square holes, but not tapped holes.

• Square mounting holes

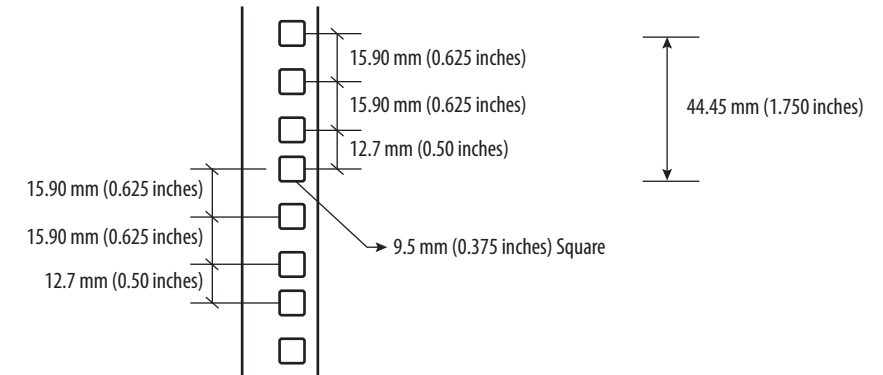

Recommended rack dimensions

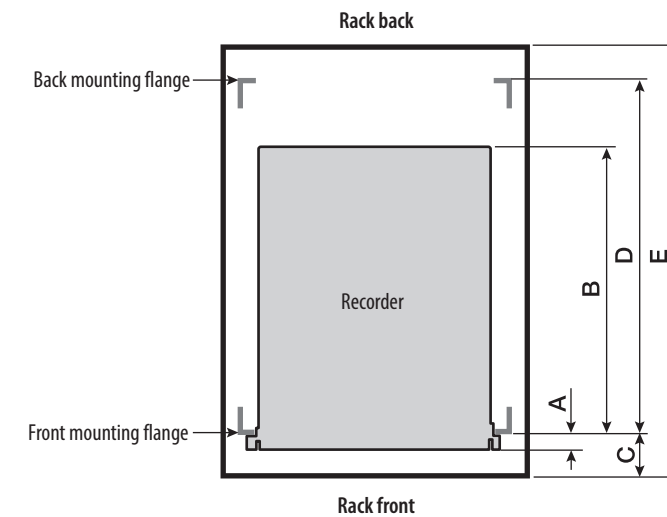

Index	Dimension	Description
A	28 mm	Recorder front dimension
B	560 mm	Recorder product dimension
C	51 mm	Offset distance between mounting flange and rack front
D	617~730 mm	Offset distance between mounting flanges
E	800 mm	Rack depth

Precautions when Selecting Shelves

To prevent any problem while installing the recorder, make sure to select a structure where the bottom of the product is mounted.

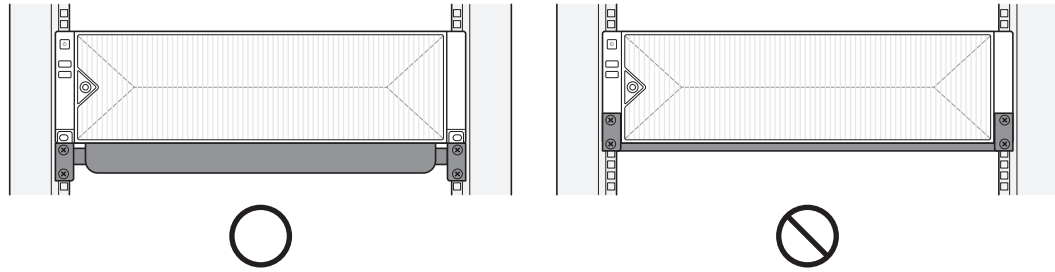

For installation stability, fixed shelf dedicated to 19-inch rack that supports the load of at least 30 kg is recommended.

- A shelf needs to be secured with at least 4 screws.

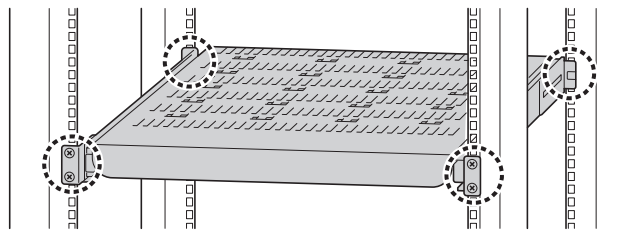

Precautions when Using Sliding Shelves

When removing a shelf, fix the rack to the ground so that it does not get toppled.

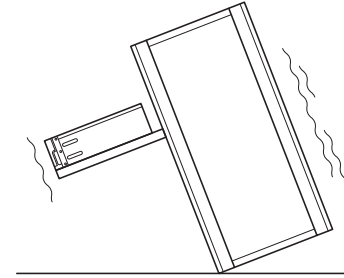

Avoid leaning on the installed product or place an object on it while its shelf is pulled out.

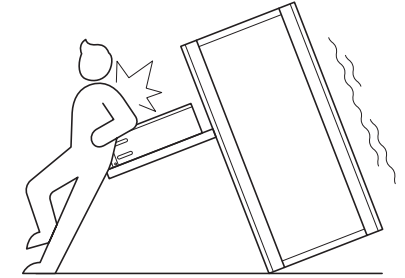

When sliding in/out the shelf, be careful not to drop the product.

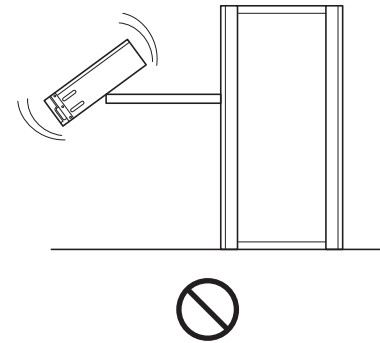

Use a shelf that supports the load of at least 30 kg while it is pulled out, and ensure that there is no deformation on the rail part while in use.

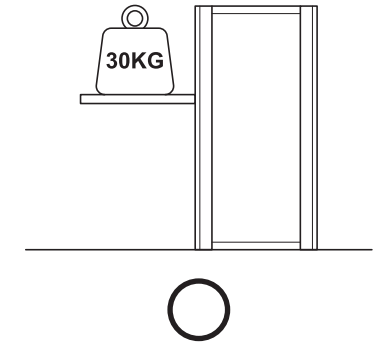

How to Install Rack

- 1 Mount the fixed or sliding shelf onto the 19-inch rack.
 - See the manual provided by the manufacturer for installing the fixed shelf.

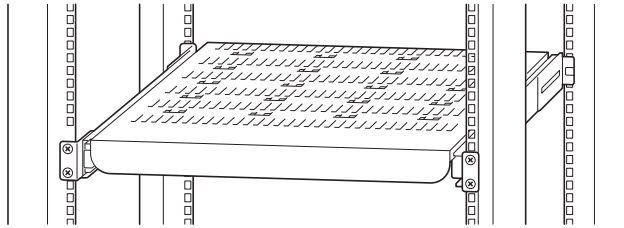

- 2 Place the recorder on the shelf and push it until the left/right fixing holes of the recorder align with the mounting flange holes of the 19-inch rack.
 - Cage nuts must be assembled in the mounting flange holes of the 19-inch rack.

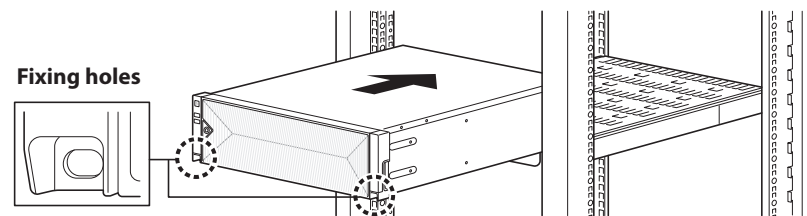

- 3 Insert the screws in the left/right fixing holes of the recorder to secure the recorder.
 - Fixing nuts and cage nuts for the recorder are not shipped with the product. They are separately sold at the place where you purchased the shelf or rack. (M6 nuts and cage nuts of head size equal to 12 mm or less are recommended.)

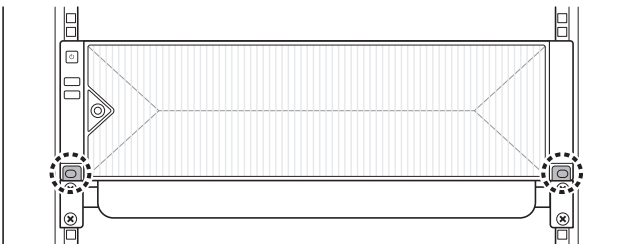

Using Product Information

You can check the product information/manual/firmware information/FAQ/HDD compatibility list on the homepage or mobile web of your smartphone.

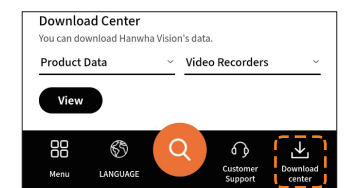
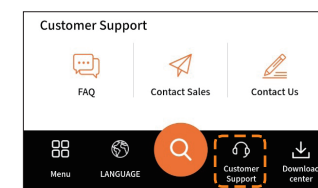
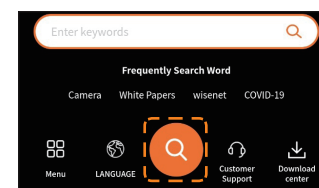
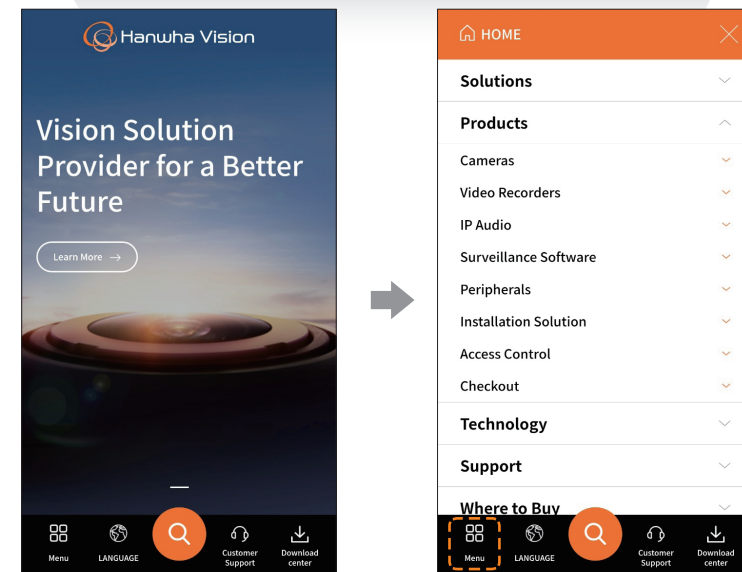
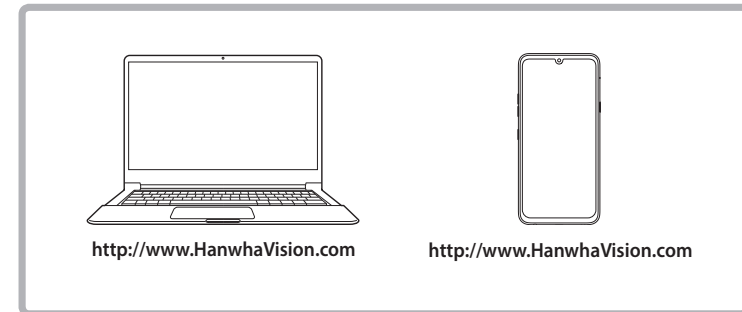

Connecting to a Network Using a Router

If you want to add 1-3 PCs and recorders in an environment using xDSL/Cable modem, you can use the router with only one Internet line.

This guide is an installation guide for network beginners. Follow the instructions to set up your router, local PC, and recorder.

Connecting the cable

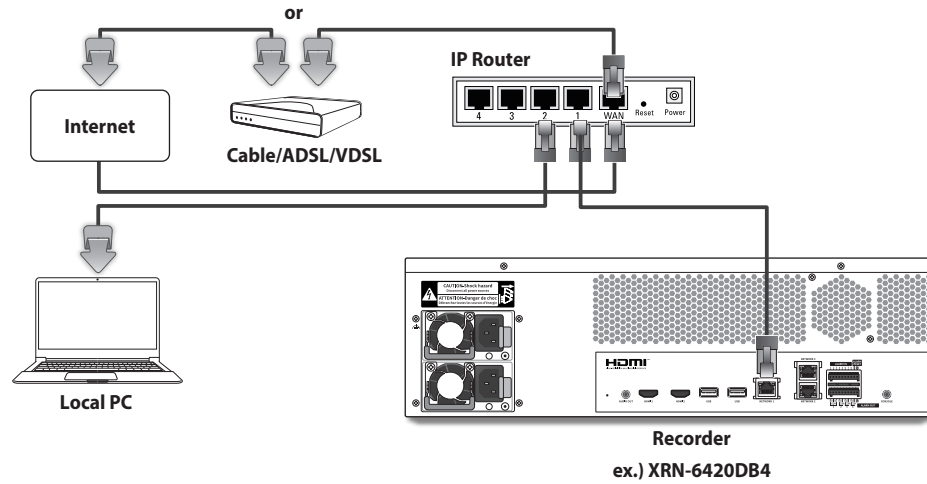

Connecting a router with PC



Refer to the router's user manual.

Connecting a recorder and a router

Move to **<IP & Port>** of the Recorder **<Network>** Setting menu, and set the **1 <IP address>** and **2 <Gateway>** in **<Setup>**.

- ※ The **<Default gateway>** checked in the **[cmd.exe]** window of the local PC and the **<Gateway>** of the recorder must be the same.
- ※ The first three numbers of the recorder **<IP address>** should match the first three of the **<Default gateway>** checked in the **[cmd.exe]** window of the local PC.

```

C:\Users\WUser>ipconfig
Windows IP Configuration

Ethernet adapter Ethernet 2:

    Connection-specific DNS Suffix  . : kornet
    IPv4 Address. . . . . : 192.168.219.192
    Subnet Mask . . . . . : 255.255.255.0
    Default Gateway . . . . . : 192.168.219.1
  
```

<cmd screen>

The screenshot shows the Recorder's Network2 setting screen. The IP address is set to 192.168.219.192 and the Gateway is set to 192.168.219.1. The DNS is set to 168.126.63.1. The screen also shows options for IPv6 and DNS settings.

<ex. Recorder screen>



Hanwha Vision cares for the environment at all product manufacturing stages, and is taking measures to provide customers with more environmentally friendly products. The Eco mark represents Hanwha Vision's devotion to creating environmentally friendly products, and indicates that the product satisfies the EU RoHS Directive.

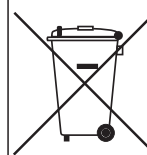

Correct Disposal of This Product (Waste Electrical & Electronic Equipment)

(Applicable in the European Union and other European countries with separate collection systems)

This marking on the product, accessories or literature indicates that the product and its electronic accessories (e.g. charger, headset, USB cable) should not be disposed of with other household waste at the end of their working life. To prevent possible harm to the environment or human health from uncontrolled waste disposal, please separate these items from other types of waste and recycle them responsibly to promote the sustainable reuse of material resources.

Household users should contact either the retailer where they purchased this product, or their local government office, for details of where and how they can take these items for environmentally safe recycling.

Business users should contact their supplier and check the terms and conditions of the purchase contract. This product and its electronic accessories should not be mixed with other commercial wastes for disposal.



Correct disposal of batteries in this product

(Applicable in the European Union and other European countries with separate battery return systems.)

This marking on the battery, manual or packaging indicates that the batteries in this product should not be disposed of with other household waste at the end of their working life. Where marked, the chemical symbols Hg, Cd or Pb indicate that the battery contains mercury, cadmium or lead above the reference levels in EC Directive 2006/66. If batteries are not properly disposed of, these substances can cause harm to human health or the environment.

To protect natural resources and to promote material reuse, please separate batteries from other types of waste and recycle them through your local, free battery return system.

