

Eaton Tripp Lite Series SmartPro

Advanced User Guide

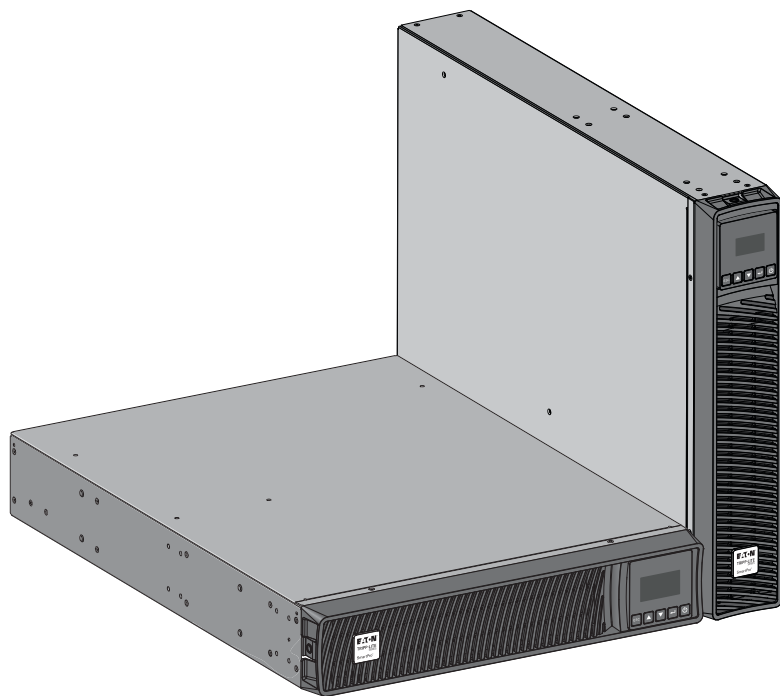

SMART750RMXL2U
SMART750RMXL2UN
SMART1000RMXL2U
SMART1000RMX2UN
SMART1500RMXL2U
SMART1500RMXLN
SMART2200RMXL2U
SMART2200RMXLN
SMART2200RM2U
SMART2200RM2UN
SMART3000RMXL2U
SMART3000RMXLN
SMART3000RM2U
SMART3000RM2UN

BP48VRM2U / BP72VRM2U

Safety Instructions

SAVE THESE INSTRUCTIONS. This manual contains important instructions that should be followed during installation and maintenance of the UPS and batteries.

This equipment has been tested and found to comply with the limits for a Class A digital device, pursuant to Part 15 of the FCC Rules. These limits are designed to provide reasonable protection against harmful interference when the equipment is operated in a commercial environment. This equipment generates, uses, and can radiate radio frequency energy and, if not installed and used in accordance with the instruction manual, may cause harmful interference to radio communications. Operation of this equipment in a residential area is likely to cause harmful interference in which case the user will be required to correct the interference at his own expense.

⚠ WARNING

This is a category C2 UPS product. In a residential environment, this product may cause radio interference, in which case the user may be required to take additional measures.

Supplier's Declaration of Conformity of Federal Communications Commission Statement

This device complies with Part 15 of the FCC Rules. Operation is subject to the following two conditions:

1. this device may not cause harmful interference, and
2. this device must accept any interference received, including interference that may cause undesired operation.

For questions regarding this FCC SDoC declaration, contact Eaton Corporation by telephone or through the Internet.

Eaton Corporation 8609 Six Forks Road,
Raleigh, NC 27615, USA
Telephone: 800-356-5794

Eaton reserves the right to change specifications without prior notice. Eaton is a registered trademark of Eaton. All other trademarks are property of their respective companies.

©Copyright 2022 Eaton, Raleigh, NC, USA. All rights reserved. No part of this document may be reproduced in any way without the express written approval of Eaton.

Special Symbols

The following are examples of symbols used on the product to alert you to important information:



RISK OF ELECTRIC SHOCK - Observe the warning associated with the risk of electric shock symbol.



CAUTION: REFER TO OPERATOR'S MANUAL - Refer to your operator's manual for additional information, such as important operating and maintenance instructions.



Information, advice, help.



Read the documentation provided.



Disconnect input plug.



Before maintenance, first shut down the UPS then disconnect the AC power source, internal and external batteries then discharge capacitors by pressing the ON button and wait 5 minutes.



This equipment should only be used in a dry indoor environment.



Operating range of temperature.



Operating range of humidity.



The UPS and their batteries must be kept in a ventilated place.

Safety of Persons

- The system has its own power source (the battery). Consequently, the power outlets may be energized even if the system is disconnected from the AC power source. Dangerous voltage levels are present within the system. It should be opened exclusively by qualified service personnel.
- The system must be properly grounded at all times.
- The battery supplied with the system contains small amounts of toxic materials. To avoid accidents, the directives listed below must be observed:
 - Servicing of batteries should be performed or supervised by personnel knowledgeable about batteries and the required precautions.
 - When replacing batteries, replace with the same type and number of batteries or battery packs.
 - Do not dispose of batteries in a fire. The batteries may explode.

- Batteries constitute a danger (electrical shock, burns). The short-circuit current may be very high.
- Precautions must be taken for all handling:
 - Wear rubber gloves and boots.
 - Do not lay tools or metal parts on top of batteries.
 - Disconnect charging source prior to connecting or disconnecting battery terminals.
 - Determine if battery is inadvertently grounded. If inadvertently grounded, remove source from ground. Contact with any part of a grounded battery can result in electrical shock. The likelihood of such shock can be reduced if such grounds are removed during installation and maintenance (applicable to equipment and remote battery supplies not having a grounded supply circuit).

Product Safety

- To connect the UPS, instructions and operation described in the manual must be followed in the indicated order.
- CAUTION - To reduce the risk of fire, the unit connects only to a circuit provided with 20 or 30 amperes maximum branch circuit overcurrent protection in accordance with the National Electric Code, ANSI/NFPA 70 (US installations only).
- Check that the indications on the rating plate correspond to your AC powered system and to the actual electrical consumption of all the equipment to be connected to the system.
- For PLUGGABLE EQUIPMENT, the socket-outlet shall be installed near the equipment and shall be easily accessible
- Never install the system near liquids or in an excessively damp environment.
- Never let a foreign body penetrate inside the system.
- Never block the ventilation grates of the system.
- Never expose the system to direct sunlight or source of heat.
- If the system must be stored prior to installation, storage must be in a dry place.
- The admissible storage temperature range is -25°C to +55°C without batteries, 0°C to 40°C with batteries.
- The system is not for use in a computer room AS DEFINED IN the standard for the Protection of Information Technology Equipment, ANSI/NFPA 75 (US installations only).

Special Precautions

- The unit is heavy: wear safety shoes and use vacuum lifter preferentially for handling operations.
- All handling operations will require at least two people (unpacking, lifting, installation in rack system).
- Before and after the installation, if the UPS remains de-energized for a long period, the UPS must be energized for a period of 24 hours, at least once every 6 months (for a normal storage temperature less than 25°C). This charges the battery, thus avoiding possible irreversible damage.
- During the replacement of the Battery Module, it is imperative to use the same type and number of element as the original Battery Module provided with the UPS to maintain an identical level of performance and safety. If there are any questions, don't hesitate to contact your local Eaton representative. For potential safety issue on defective UPS : DISCONNECT INTERNAL BATTERY for storage and transportation.
- All repairs and service should be performed by AUTHORIZED SERVICE PERSONNEL ONLY. There are NO USER SERVICEABLE PARTS inside the UPS.

Table of Contents

1 Introduction	1
1.1 Environmental protection	1
1.2 Benefits	1
1.3 Special Precautions	2
2 Presentation	3
2.1 Standard installation	3
2.2 Optional accessories	4
2.3 Rear panel	5
3 Installation	7
3.1 Inspecting the equipment	7
3.2 Recommended Positions	8
3.3 Connecting the Internal Battery	10
3.4 EBM Connection	11
3.5 UPS connection	12
3.6 Connection with a FlexPDU (Power Distribution Unit) optional module	13
3.7 Connection with a HotSwap MBP (Maintenance ByPass) optional module	13
3.7.1 UPS Start-Up with the HotSwap MBP Module	14
3.7.2 HotSwap MBP module test	14
3.8 HotSwap MBP module test	14
4 Interfaces and Communication	15
4.1 Control panel	15
4.2 LCD Description	16
4.3 Display Functions	18
4.4 User Settings	19
4.5 Communication Ports	21
4.6 UPS Remote Control Functions	22
4.7 Power Alert Software	25
4.8 Cybersecurity	25
5 Operation	27
5.1 Start-up and normal operation	27
5.2 Starting the UPS on battery	27
5.3 UPS shutdown	27
5.4 Operating modes	28
5.5 Return of AC input power	28
5.6 Configuring Battery Settings	28
5.7 Retrieving the event and fault log	29
6 UPS Maintenance	31

Table of Contents

6.1 Equipment Care	31
6.2 Storing the Equipment	31
6.3 When to Replace Batteries	31
6.4 Replacing Batteries	31
6.5 Replacing the UPS Equipped with a HotSwap MBP	34
7 Troubleshooting	35
7.1 Typical Alarms and Faults	35
7.2 Detail Alarm or Fault Code	36
7.3 Silencing the Alarm	37
7.4 Service and Support	37
8 Specifications	39
8.1 UPS Model List	39
8.2 Extended Battery Module Model List	39
8.3 Weights and Dimensions	39
8.4 Electrical Input	40
8.5 Electrical Input Connections	41
8.6 Electrical Output	41
8.7 Electrical Output Connection	42
8.8 Battery	42
8.9 Environmental and Safety	42

Chapter 1 Introduction

1.1 Environmental protection

Eaton Tripp Lite Series has implemented an environmental-protection policy. Products are developed according to an eco-design approach.

Substances

This product does not contain CFC and HCFC. This product does not contain asbestos. This product is compliant with regulations on the restriction of the use of substances in electrical and electronic equipment.

Packaging

To improve waste treatment and facilitate recycling, separate the various packing components.

- The cardboard we use comprises over 50% of recycled cardboard.
- Plastic bags are made of polyethylene.
- Packing materials are recyclable and bear the appropriate identification symbol. 

Table 1.

Materials	Abbreviations	Number in the symbols
Polyethylene terephthalate	PET	01
High-density polyethylene	HDPE	02
Polyvinyl chloride	PVC	03
Low-density polyethylene	LDPE	04
Polypropylene	PP	05
Polystyrene	PS	06

Follow all local regulations for the disposal of packing materials.

End of life

Eaton Tripp Lite Series will process products at the end of their service life in compliance with local regulations. Eaton Tripp Lite Series works with companies in charge of collecting and eliminating our products at the end of their service life.

Product

The product is made up of recyclable materials. Dismantling and destruction must take place in compliance with all local regulations concerning waste. At the end of its service life, the product must be transported to a processing center for electrical and electronic waste. tripplite.com/support/recycling-program/

Battery

The product contains lead-acid batteries that must be processed according to applicable local regulations concerning batteries. The battery may be removed to comply with regulations and in view of correct disposal.

1.2 Benefits

The Eaton Tripp Lite Series SmartPro uninterruptible power system (UPS) protects your sensitive electronic equipment from the most common power problems, including power outages, voltage sags, impulsive

Special Precautions

transients, line noise, and long-term under and over voltage conditions, frequency variations, switching transients, and harmonic distortion.

Power outages can occur when you least expect it and power quality can be erratic. These power problems have the potential to corrupt critical data, destroy unsaved work sessions, and damage hardware - causing hours of lost productivity and expensive repairs.

With the Eaton Tripp Lite Series SmartPro, you can safely eliminate the effects of power disturbances and guard the integrity of your equipment. Providing outstanding performance and reliability, the Eaton Tripp Lite Series SmartPro's unique benefits include:

- Standard communication options: one RS-232 communication port, one USB communication port, relay output contacts.
- Optional connectivity cards with enhanced communication capabilities.
- Extended runtime with up to four Extended Battery Modules (EBMs) per UPS.
- Remote on/off (ROO) and remote power off (RPO).
- Backed by worldwide agency approvals.

1.3 Special Precautions

- The unit is heavy: wear safety shoes and use vacuum lifter preferentially for handling operations.
- All handling operations will require at least two people (unpacking, lifting, installation in rack system).
- Before and after the installation, if the UPS remains de-energized for a long period, the UPS must be energized for a period of 24 hours, at least once every 6 months (for a normal storage temperature less than 25°C). This charges the battery, thus avoiding possible irreversible damage.
- During the replacement of the Battery Module, it is imperative to use the same type and number of element as the original Battery Module provided with the UPS to maintain an identical level of performance and safety. If there are any questions, don't hesitate to contact your local EATON representative.
- All repairs and service should be performed by AUTHORIZED SERVICE PERSONNEL ONLY. There are NO USER SERVICEABLE PARTS inside the UPS.
- For potential safety issue on defective UPS : DISCONNECT INTERNAL BATTERY for storage and transportation.

Chapter 2 Presentation

2.1 Standard installation

Table 2. Installation Formats

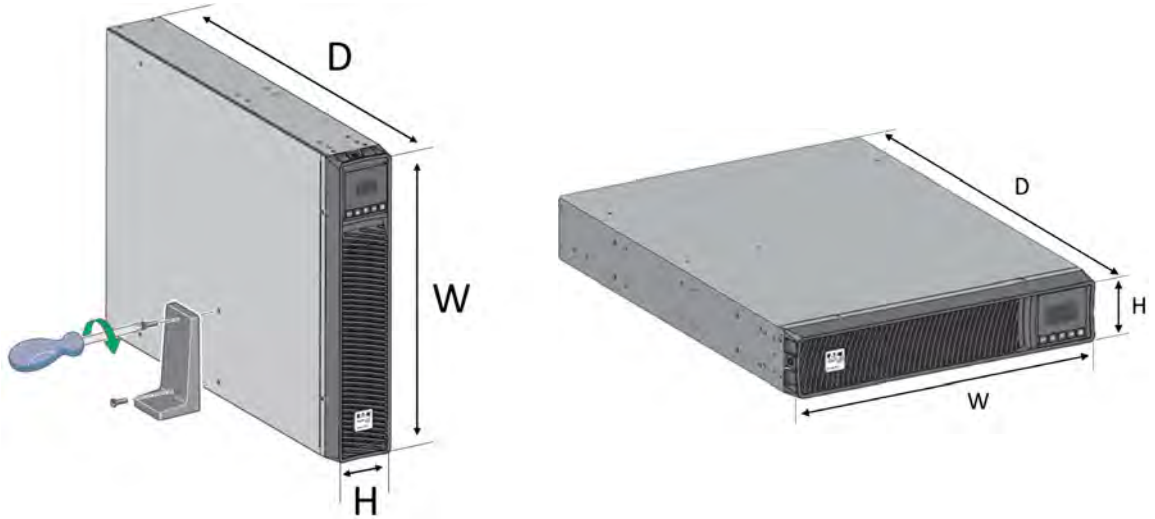

Table 3. Weights and Dimensions

Description (UPS)	Weights (lb / kg)	Dimensions (inch / mm) D x W x H
SMART750RMXL2U SMART750RMXL2UN	44.5 / 20.2	17.6x17.2x3.4 / 448x438x85.5
SMART1000RMXL2U SMART1000RMX2UN	44.5 / 20.2	17.6x17.2x3.4 / 448x438x85.5
SMART1500RMXL2U SMART1500RMXLN	50.7 / 23.0	17.6x17.2x3.4 / 448x438x85.5
SMART2200RMXL2U SMART2200RMXLN SMART2200RM2U SMART2200RM2UN	65.3 / 29.6	23.7x17.2x3.4 / 603x438x85.5
SMART3000RMXL2U SMART3000RMXLN SMART3000RM2U SMART3000RM2UN	74.5 / 33.8	23.7x17.2x3.4 / 603x438x85.5
Description (EBM)	Weights (lb / kg)	Dimensions (inch / mm) D x W x H
BP48VRM2U	61.3 / 27.8	17.6x17.2x3.4 / 448x438x85.5
BP72VRM2U	89.1 / 40.4	23.7x17.2x3.4 / 603x438x85.5

2.2 Optional accessories

Table 4. Smart Pro Optional Accessories

Part number	Description
BP48VRM2U BP72VRM2U	Extended Battery Module
WEBCARDLXE	UPS Web Management Accessory Card SNMP Remote Monitoring HTML5

2.3 Rear panel

SMART750RML2U / SMART750RML2UN / SMART1000RML2U /
SMART1000RMX2UN / SMART1500RML2U / SMART1500RMLN

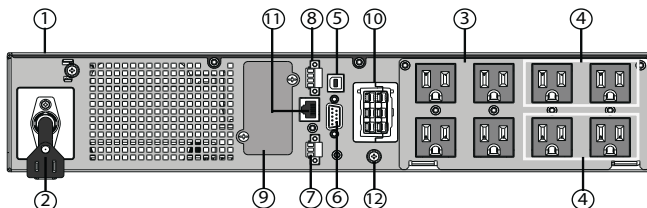

SMART2200RML2U / SMART2200RMLN

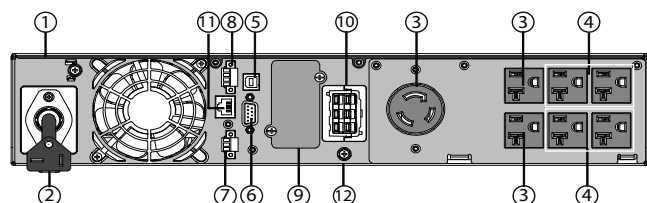

SMART3000RML2U / SMART3000RMLN

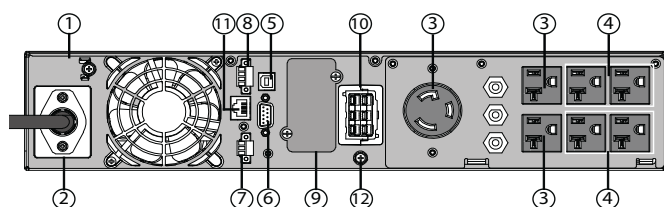

SMART2200RM2U / SMART2200RM2UN

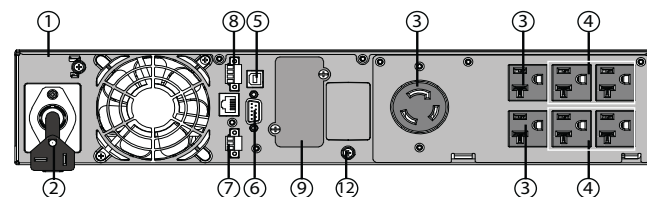

SMART3000RM2U / SMART3000RM2UN

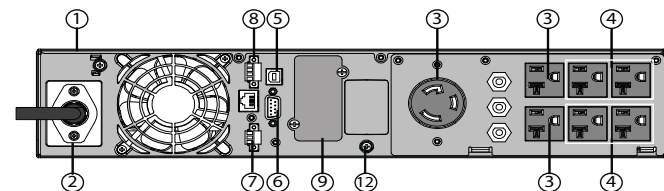

BP48VRM2U / BP72VRM2U

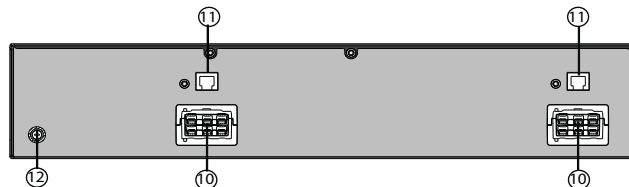

- ① UPS
- ② Input AC power source
- ③ Primary group (critical equipment)
- ④ Outlet group (programmable outlets)
- ⑤ USB communication ports
- ⑥ RS232 communication port
- ⑦ Relay output contact
- ⑧ Connector for ROO (Remote On/Off) control and RPO (Remote Power Off)
- ⑨ Slot for optional communication card
- ⑩ Connector for additional battery module
- ⑪ Connector for automatic recognition of an additional battery module
- ⑫ Ground screw

Rear panel

Chapter 3 Installation

3.1 Inspecting the equipment

If any equipment has been damaged during shipment, keep the shipping cartons and packing materials for the carrier or place of purchase and file a claim for shipping damage. If you discover damage after acceptance, file a claim for concealed damage. For pluggable equipment, the socket outlet shall be installed near the equipment and shall be easily accessible.

To file a claim for shipping damage or concealed damage:

1. File with the carrier within 15 days of receipt of the equipment;
2. Send a copy of the damage claim within 15 days to your service representative.



IMPORTANT

Check the battery recharge date on the shipping carton label. If the date has passed and the batteries were never recharged, do not use the UPS. Contact your service representative.

Table 5. Package content

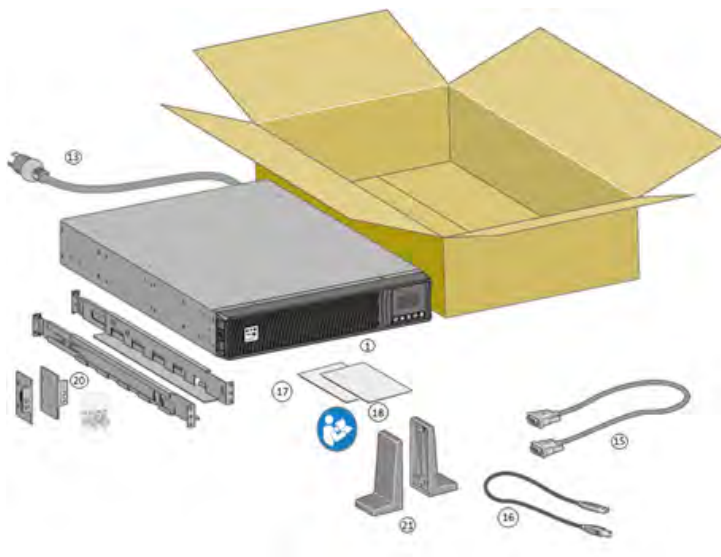

Verify that the following additional items are included with the UPS:

1. UPS
 13. Connection cable to AC power source
 15. RS232 communication cable
 16. USB communication cable
 17. Safety instructions
 18. Quick start
 20. Rack kit for 19-inch 4-post enclosures
 21. Two supports for tower position (tower feet)
- WEBCARDLXE (optional)

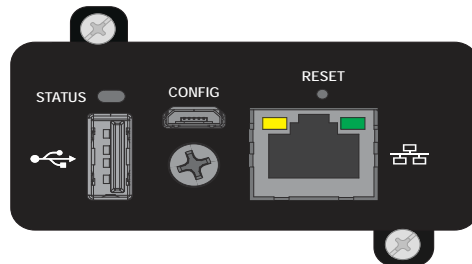

3.2 Recommended Positions

Installation in rack position

Follow steps 1 to 4 for module mounting on the rails.

Figure 1. Rack Installation Steps

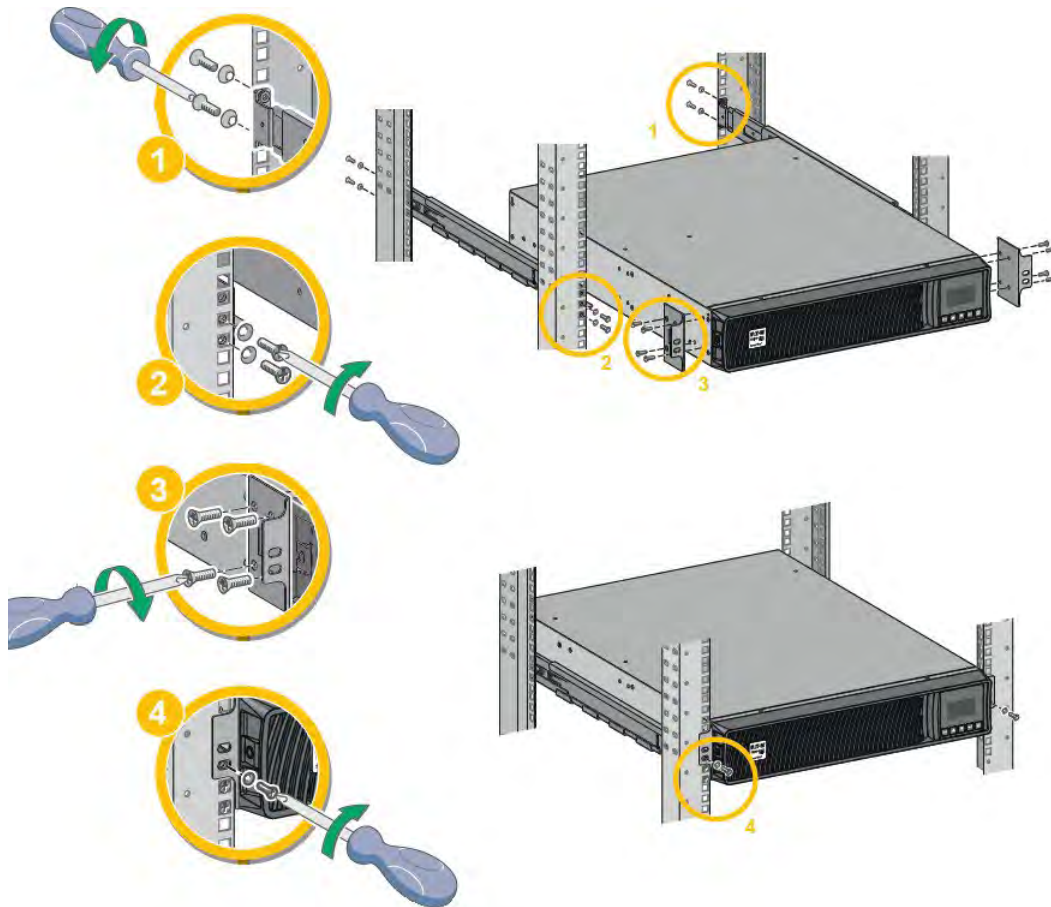

NOTE

The rails and necessary hardware are supplied by Eaton.

Installation in tower position



If you ordered other UPS accessories, refer to specific user manuals to check the tower installation with the UPS.

To install the UPS:

Place the UPS on a flat, stable surface in its final location. Always keep 6" or 150 mm of free space behind the UPS rear panel for ventilation.

If installing additional EBM, place them next to the UPS in their final location.

Follow steps 1 to 5 to adjust the orientation of the LCD panel and of the logo.

Figure 2. Tower Installation Steps

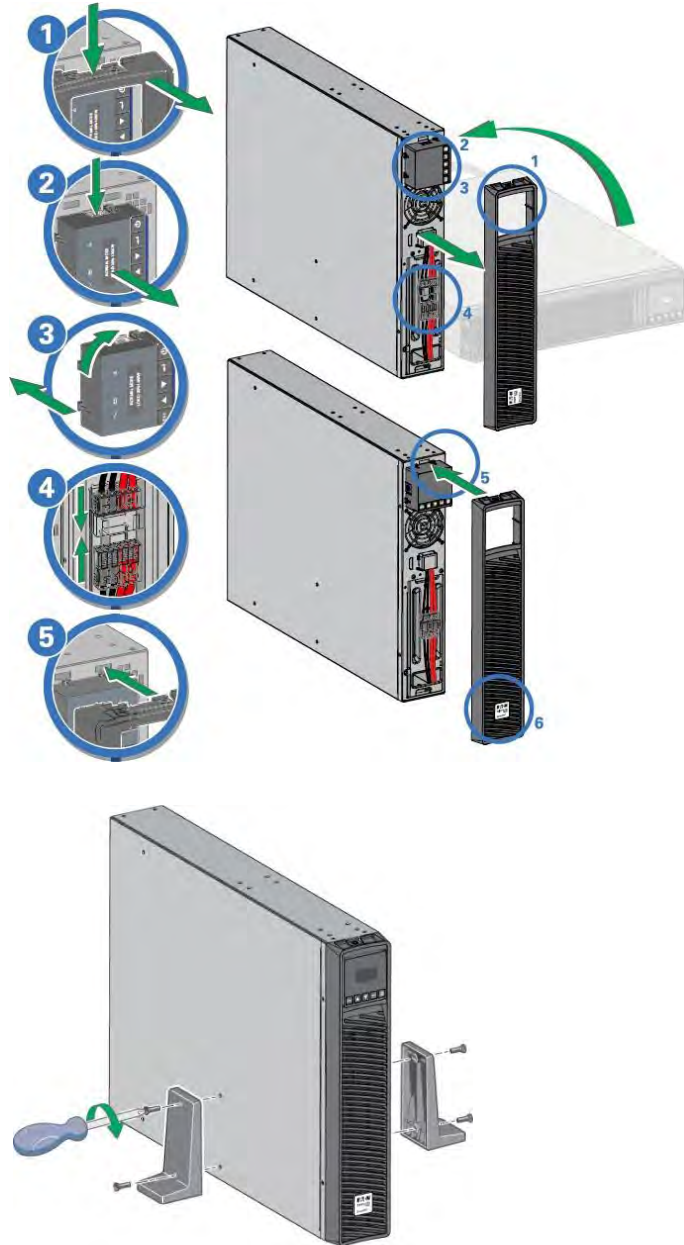

3.3 Connecting the Internal Battery

Figure 3. Internal Battery Connection

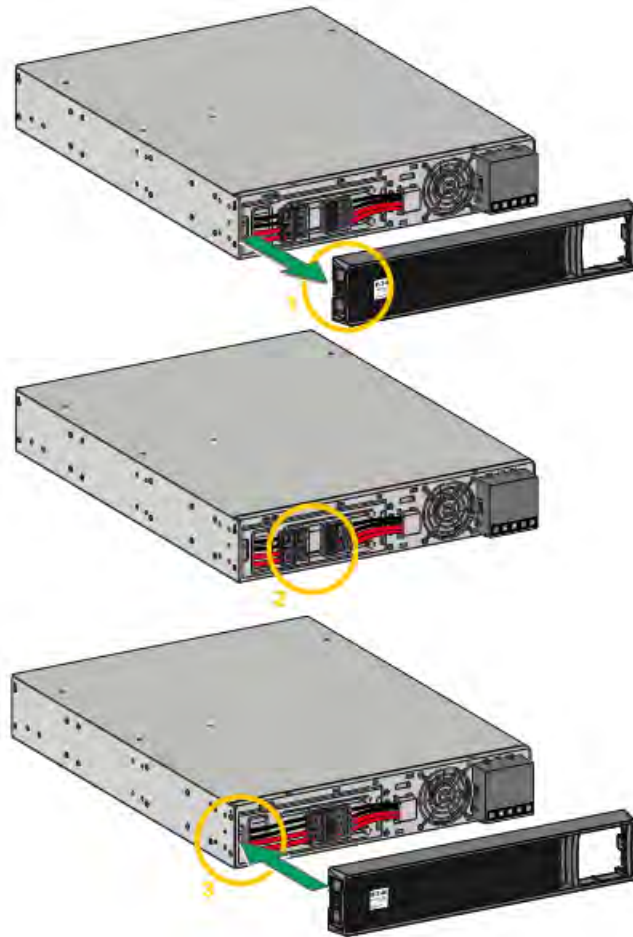

⚠ WARNING

A small amount of arcing may occur when connecting the internal batteries. This is normal and will not harm personnel. Connect the cables quickly and firmly.

1. Remove the front panel by pressing on both sides of the panel.
2. Connect the two battery connectors together.
3. Replace the front panel.

3.4 EBM Connection

WARNING

The optional CBLADAPT48 or CBLADAPT72 cables are forbidden with Eaton Tripp Lite Series SmartPro models installed in the US or Canada.



WARNING

A small amount of arcing may occur when connecting an EBM to the UPS. This is normal and will not harm personnel. Insert the EBM cable into the UPS battery connector quickly and firmly.

1. Attach the UPS and the EBMs to each other using the supplied mounting plate. Up to 4 EBMs may be connected to the UPS.
2. Connect the EBMs power cable and the attached battery detection cable as shown in the picture.
3. Verify that the EBM connections are tight and that adequate bend radius and strain relief exist for each cable.

Table 6. Rack EBM Installation Steps

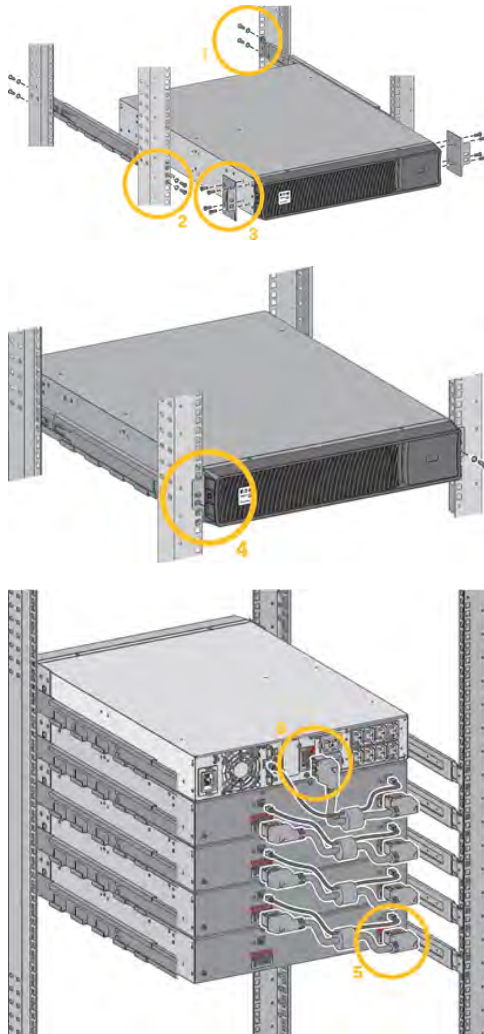

1. Fix the rail on the back of the rack.
2. Fix the rail on the front of the rack using the two holes at the bottom.
3. Fix the ears plate to the UPS.
4. Place the UPS on the rails and fix the ears plate to the top hole of the rail.
5. Connect the EBM power cable as shown in the picture.
6. Connect the RJ45 battery detection cable of the first EBM between the EBM and the UPS connector "Batt detection" (11). For any additional EBM, connect the battery detection cable to the previous EBM.

Verify that the EBM connections are tight and that adequate bend radius and strain relief exist for each cable.

⚠WARNING

A small amount of arcing may occur when connecting an EBM to the UPS. This is normal and will not harm personnel. Insert the EBM cable into the UPS battery connector quickly and firmly.

⚠CAUTION

To increase stability, it is preferable to place the EBM below the UPS.

3.5 UPS connection

⚠CAUTION

Check that the indications on the name plate located on the back of the UPS correspond to the AC-power source and the true electrical consumption of the total load.

Table 7. Power Supply Connection Steps

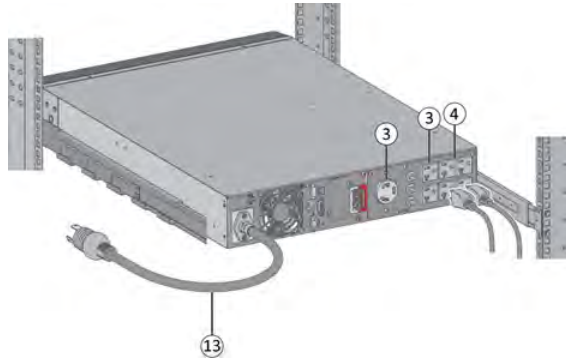

1. Connect the UPS input cable (13) to the AC power source.
2. Connect the loads to the UPS. It is preferable to connect the priority loads to the outlets marked (3) and the non-priority loads to the outlets Group1, Group2 (4) that can be programmed.

For the SmartPro2200 / 3000 models, connect any high-power devices or matching Power Distribution Unit (PDU) to the L5-20R or L5-30R outlet.

3. To program shutdown and startup of the Group1 and Group2 outlets in order to extend battery runtime and perform scheduled shutdowns, please see the XREF "In/Out settings" section.

3.6 Connection with a FlexPDU (Power Distribution Unit) optional module

Table 8. FlexPDU Connection Steps

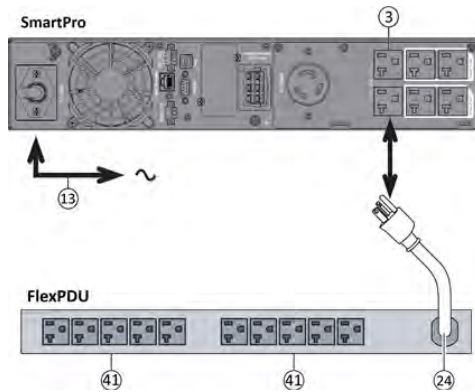

1. Connect the UPS power cord (13) to the AC power source.
2. Connect the input cord of the FlexPDU module (24) to one of the UPS outlets (3).
3. Connect the equipment to the outlets (41) on the FlexPDU module. These outlets differ, depending on the version of the FlexPDU module.

3.7 Connection with a HotSwap MBP (Maintenance ByPass) optional module

The HotSwap MBP module makes it possible to service or even replace the UPS without affecting the connected loads (HotSwap function).

Table 9. HotSwap MBP Connection Steps

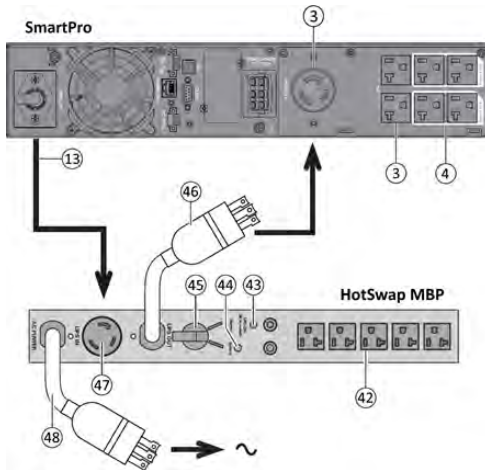

1. Connect the input socket (48) on the HotSwap MBP module to the AC power source.
2. Connect the UPS input power cord (13) to the receptacle "UPS Input" (47) of the HotSwap MBP module.
3. Connect the "UPS Output" cable (46) of the HotSwap MBP module to the outlet (3) of the UPS .
4. Connect the equipment to the outlets (42) on the HotSwap MBP module.

These outlets differ, depending on the version of the HotSwap MBP module.

CAUTION

Do not use UPS outlets (4) to supply equipment because use of switch (45) on the HotSwap MBP module would cut supply to the equipment.

Table 10. HotSwap MBP Module Operation

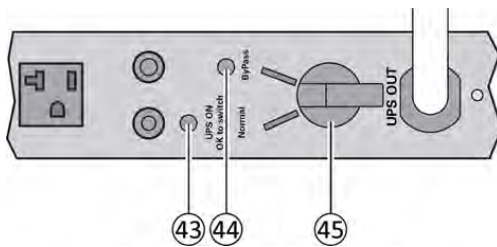

The HotSwap MBP module has a rotary switch (45) with two positions:
Normal : the load is supplied by the UPS, LED (43) is on.
Bypass : the load is supplied directly by the AC power source. LED (44) is on. Load is not protected.

3.7.1 UPS Start-Up with the HotSwap MBP Module

1. Check that the UPS is correctly connected to the HotSwap MBP module.
2. Start the UPS by pressing the  button on the UPS control panel. LED (43) "UPS ON - OK to switch" on the HotSwap MBP module goes ON (otherwise, there is a connection error between the HotSwap MBP module and the UPS).
3. Set switch (45) to Normal position. The red LED on the HotSwap MBP module goes OFF.

3.7.2 HotSwap MBP module test

1. Set switch (45) to Bypass position and check that the load is still supplied.
2. Set switch (45) back to Normal position.

3.8 HotSwap MBP module test

1. Set switch (45) to Bypass position and check that the load is still supplied.
2. Set switch (45) back to Normal position.

Chapter 4 Interfaces and Communication

4.1 Control panel

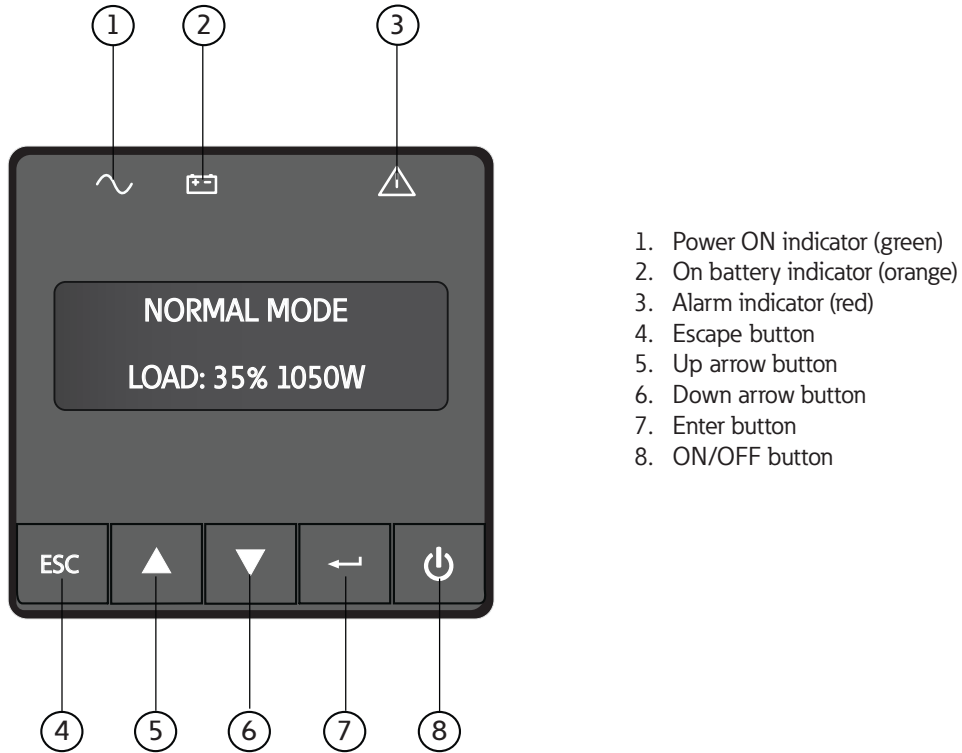

The screen provides useful information about the UPS itself, load status, events, measurements and settings.

Figure 4. Control Panel Details



The following table shows the indicator status and description :

Table 11. LED Indicator Details

Indicator	Status	Description
 Green	On	The UPS is "On" and the load is protected.
 Orange	On	The UPS is in battery mode and the load is protected.
	Flashing	The battery voltage is below the warning level.
 Red	On	The UPS has an active alarm or fault. See troubleshooting page for additional information.

4.2 LCD Description

The LCD screen has 2 lines, each line may show 16 characters maximum. The first line shows UPS mode, which may be standby mode, normal mode, battery mode, backup end mode or fault mode. The second line shows measures. The backlight LCD automatically dims after 5 minutes of inactivity. Press any button to restore the screen.



If fault or alarm appears, the first line of LCD will cycle between fault/alarm message and UPS mode, see for additional information.

Figure 5. LCD Screen – Example

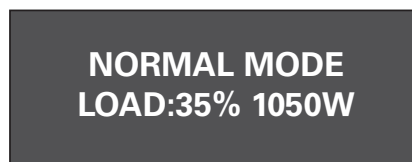

Table 12. LCD Screen – Display Details

Screen	Battery area display	Bottom row values
1st Screen (home / default screen): Load percentage and Watt.		The LOAD data screen specifies the amount of power that connected equipment is currently using in terms of percentage and Watt. Load % , 0 decimal. Load W , 0 decimals.
2nd Screen: Load percentage and VA.		The OUTPUT LOAD LEVEL screen indicates the load percentage and VA output load level. Load % , 0 decimals. Load VA , 0 decimals.
3rd Screen: Output load power factor		The OUTPUT LOAD POWER FACTOR screen indicates the power factor of connected equipment. 2 decimal.
4th Screen: Input voltage and frequency		The INPUT VOLTAGE & FREQUENCY screen displays current data. Input voltage: 0 decimal. Input frequency HZ,1 decimal.
5th Screen: Output voltage and frequency		The OUTPUT VOLTAGE & FREQUENCY screen displays current data. Output voltage: 0 decimal. Output frequency HZ,1 decimal.

Table 12. LCD Screen – Display Details (Continued)

6th Screen: Battery voltage and charge percentage	UPS MODE BAT: xx. xV xxx%	The BATTERY voltage screen tracks the charge level of your connected battery bank in terms of voltage and charge percentage. Battery voltage:1 decimal. Charge percentage:0 decimal.
7th Screen: Remaining battery runtime	UPS MODE RUNTIME: xxxMIN	The RUNTIME remaining screen tracks the approximate minutes of runtime available under the current loading and battery pack configuration. The runtime value will automatically re-calculate as connected equipment power consumption changes. 0 decimal.
8th Screen: External battery quantity	UPS MODE EBM: x	The EBM screen display external battery quantity. This screen is only for long time model. 0 decimal.
9th Screen: Remaining watts of UPS	UPS MODE REMAIN W: x. xxKW	The REMAIN WATTS screen tracks the remaining capacity of the UPS in kilowatt 2 decimals.
10th Screen: Demand energy	UPS MODE DEMAND E: x. xxKWH	The DEMAND ENERGY screen offers continuous data on the KWh(kilowatt-hour) that connected equipment has consumed in the last one-hour period. 2 decimals.

The following table describes the status information provided by the UPS :

Table 13. System Operational Status Details

Operation status	Possible cause	Action
Standby mode	The UPS is OFF, waiting for start-up command from user	Equipment is not power until button  is pressed during start up and the green "normal mode" LED indicator is illuminated.
Normal mode	The UPS is operating normally.	The UPS is powering and protecting the equipment.
Battery Mode One beep every 10 seconds	A utility failure has occurred and the UPS is in Battery mode.	The UPS is powering the equipment with battery power. Prepare your equipment for shutdown.

Table 13. System Operational Status Details (Continued)

End of backup time 1 beep every 3 seconds	The UPS is in Battery mode and the battery is running low.	This warning is approximate, and the actual time to shutdown may vary significantly. Depending on the UPS Load, the "Battery Low" warning may occur before the battery reaches 20% capacity remaining.
Fault Mode	Some fault has happened to the UPS. Action may be needed.	See for additional information.

4.3 Display Functions

Press the Enter () button to activate the menu options. Use the two middle buttons (□ and □) to scroll through the menu structure. Press the Enter (□) button to select an option. Press the **(ESC)** button to cancel or return to the previous menu.

Table 14. Menu Map for Display Functions

Main menu	Submenu	Display information or Menu function
CONTROL	BATTERY TEST	Starts a manual battery test(possible if load>10% and battery >80%).
	RESET FAULT ST	Reset fault state.
	CLEAR EVENT LOG	Clears the faults and events stored.
	RESET KWH USED	Reset the power used.
	FACTORY SETT	Restore factory settings.
LOCAL SETTING	LANGUAGE	Sets product general parameters, see
	AUDIBLE ALARM	Sets input and output parameters, see
IN/OUT SETTING	OUTPUT VOLTAGE	Select output voltage through this submenu.
	INPUT THRESHOLD	Input threshold can be set to normal or extended through this menu.
	SENSITIVITY	Sensitivity can be set to high or low through this menu.
	OVRLOAD PREALARM	Overload pre-alarm can be set through this menu.
ON/OFF SETTING	COLD START	Cold start can be enabled or disabled through this menu.
	AUTO RESTART	Auto restart can be enabled or disabled through this menu.
	AUTO START	Auto start can be enabled or disabled through this menu.
	SLEEP MODE	Sleep mode can be enabled or disabled through this menu.
	SITE WIRING FLT	Site wiring fault can be enabled or disabled through this menu.
BATTERY SETTING	AUTO BAT TEST	Auto battery test period can be set through this menu.
	RESTART LEVEL	Restart battery level can be set through this menu.
	BAT LOW LEVEL	Battery low percentage can be set through this menu.

Table 14. Menu Map for Display Functions (Continued)

Main menu	Submenu	Display information or Menu function
	BAT LOW TIME	Battery low remaining time can be set through this menu.
COM SETTING	REMOTE ON/OFF	Select input signal function for REMOTE ON/OFF.
	REMOTE PWR OFF	Select input signal function for REMOTE PWR OFF.
	INPUT DB9-4	Select input signal function for INPUT DB9-4.
	OUTPUT RELAY	Select output signal function for OUTPUT RELAY.
	OUTPUT DB9-1	Select output signal function for OUTPUT DB9-1.
	OUTPUT DB9-7	Select output signal function for OUTPUT DB9-7.
	OUTPUT DB9-8	Select output signal function for OUTPUT DB9-8.
EVENT LOG		Event log has utmost 50 items to show what happened.
IDENTIFICATION		This menu shows IDENTIFICATION information.

4.4 User Settings

The following table displays the options that can be changed by the user.

Table 15. User Settings

	Submenu	Available settings	Default settings
LOCAL SETTING	LANGUAGE	ENGLISH FRANCAIS ESPANOL	ENGLISH
	AUDIBLE ALARM	ENABLED DISABLED ON BAT ALWAYS DISABLED	ENABLED
IN/OUT SETTING	OUTPUT VOLTAGE	[200 V] [208 V] [220 V] [230 V] [240 V]	[208 V]
	INPUT THRESHOLD	NORMAL EXTENDED	NORMAL
	SENSITIVITY	HIGH LOW	HIGH
	OVRLOAD PREALARM	[50%-105%, step is 5%.	105%
ON/OFF SETTING	COLD START	ENABLED/DISABLED	ENABLED
	AUTO RESTART	ENABLED/DISABLED	ENABLED
	AUTO START	ENABLED/DISABLED	DISABLED
	SLEEP MODE	ENABLED/DISABLED	ENABLED
	SITE WIRING FLT	ENABLED/DISABLED	DISABLED
BATTERY SETTING	AUTO BAT TEST	NO TEST MONTHLY	MONTHLY
	RESTART LEVEL	0%-100%, step is 5%.	0%
	BAT LOW LEVEL	0%-100%, step is 10%.	0%

Table 15. User Settings (Continued)

	Submenu	Available settings	Default settings
	BAT LOW TIME	0MIN-60MIN, step is 3MIN	3MIN
COM SETTING	REMOTE ON/OFF	NO ROO RPO BLD.ALARM SHUTDOWN CMD	NO
	REMOTE PWR OFF	NO ROO RPO BLD.ALARM SHUTDOWN CMD	NO
	INPUT DB9-4	NO ROO RPO BLD.ALARM SHUTDOWN CMD	NO
	OUTPUT RELAY	ON BATTERY LOW BATTERY BATTERY FAULT UPS OK LOAD PROTECTED LOAD POWERED GENERAL ALARM OVRLOAD PREALARM BAT DISCONN	BATTERY FAULT
	OUTPUT DB9-1	ON BATTERY LOW BATTERY BATTERY FAULT UPS OK LOAD PROTECTED LOAD POWERED GENERAL ALARM OVRLOAD PREALARM BAT DISCONN	LOW BATTERY
	OUTPUT DB9-7	ON BATTERY LOW BATTERY BATTERY FAULT UPS OK LOAD PROTECTED LOAD POWERED GENERAL ALARM OVRLOAD PREALARM BAT DISCONN	UPS OK

Table 15. User Settings (Continued)

	Submenu	Available settings	Default settings
	OUTPUT DB9-8	ON BATTERY LOW BATTERY BATTERY FAULT UPS OK LOAD PROTECTED LOAD POWERED GENERAL ALARM OVRLOAD PREALARM BAT DISCONN	ON BATTERY

4.5 Communication Ports

Table 16. RS232/USB Communication Port Connection Steps

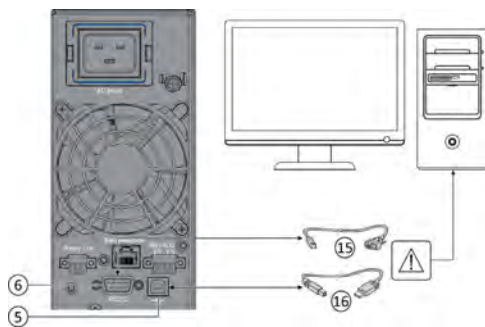

1. Connect the RS232 (15) or USB (16) communication cable to the serial or USB port on the computer equipment.
2. Connect the other end of the communication cable (15) or (16) to the USB (5) or RS232 (6) communication port on the UPS.



The UPS can now communicate with Eaton Tripp Lite Series power management software.

You can improve the remote monitoring and power management of the UPS by adding a communication card compatible with the SmartPro product, see paragraph .

Table 17. RS232 Communication Port Contact Details

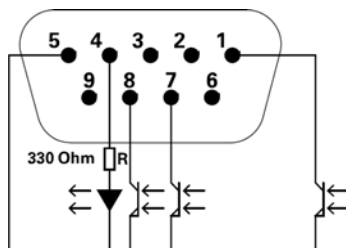

Contact characteristics (optocoupler)

- Voltage: 48 V DC max
- Current: 25 mA max
- Power: 1.2 W

Pin	Signal	Direction	Function
1	Bat low	Output	Low Battery Output
2	TxD	Output	Transmit to external device
3	RxD	Input	Receive from external device
4	I/P SIG	Input	-
5	GNDS	-	Signal Common tied to chassis
6	PNP	Input	Plug and Play
7	UPS OK	Output	UPS OK
8	BAT mode	Output	UPS on battery mode
9	+5V	Output	Power supply for external signal or options

Table 18. Communication Card Installation Steps

Installation of the communication cards

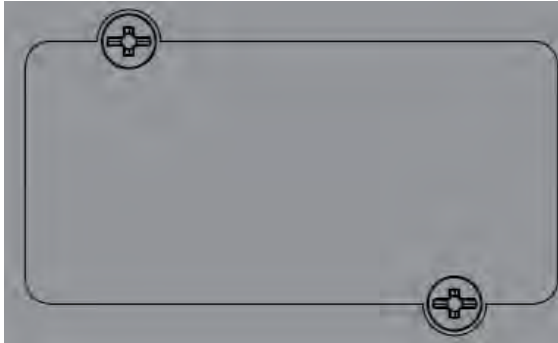

Accessory Slot: Remove the small cover panel from this slot to install optional accessories to remotely monitor and control your UPS. Refer to your accessory’s manual for installation instructions. Contact Tripp Lite Customer Support at www.tripplite.com/support for more information, including a list of available SNMP, network management and connectivity products.

NOTE Select models include a preinstalled network management card. For these models, refer to the management card accessory user manual included with your UPS for connection, configuration and complete operating instructions.

4.6 UPS Remote Control Functions

Connectivity cards

Connectivity cards allow the UPS to communicate in a variety of networking environments and with different types of devices. The SmartPro models have one available communication bay for the following connectivity card:

- **Network card (WEBCARDLXE)** : Operate any compatible UPS system or PDU as a managed device on your network. Monitor and control the device using an SNMP network management platform, web browser, SSH or Telnet.

Figure 6. Network Card

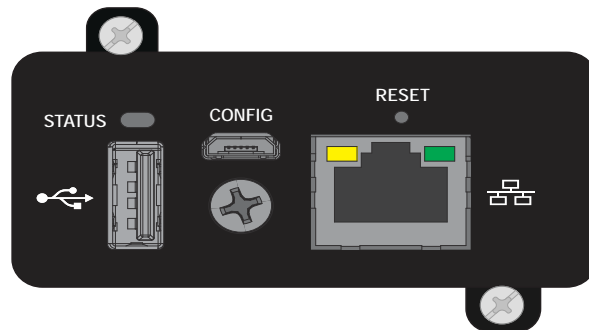

Programmable signal inputs

The SmartPro incorporates several programmable signal inputs: one Remote Power Off (RPO) input terminal, one Remote On/Off (ROO) input terminal, one RS-232 input (pin-4).

Signal inputs can be configured (see Settings > Comm settings > Signal Input) to have one of the following functions:

Table 19. Programmable Signal Input Details

Function	Description
No	No function. (Please choose a function if you want to use input signal.)
RPO	Remote Power off (RPO) is used to shutdown the UPS remotely.
ROO	Remote On/Off allows remote action of a button or other interface to switch On/ Off the UPS. (Cold start is prohibited while using the ROO function.)
Building alarm	Active input generates an alarm "building alarm".
Shutdown commands	Active input turns UPS output (or outlet groups) off after a user defined shutdown delay but keeps on charging batteries according to a selected charging scheme; inactive input does not abort shutdown countdown. Depending on the "Restart" parameter (see Settings > Comm Settings > Shutdown commands) the unit may startup automatically.



Signal inputs have no function by default; please choose a function through the LCD (Settings > Com settings > Input signals).

See the following two examples of system configuration with the RPO terminal used as RPO function and the ROO terminal use as ROO function:

Remote Power Off (RPO)

RPO is used to shutdown the UPS remotely when the contact is open. This feature can be used for shutting down the load and the UPS by thermal relay, for example, in the event of room over temperature. When RPO is activated, the UPS turns off the output and shuts down all power converters immediately (except for logic power). The UPS remains "ON" to alarm the fault.

The RPO circuit is a safety extra low voltage (SELV) circuit. This circuit must be separated from any hazardous voltage circuits by reinforced insulation.

- The RPO must not be connected to any utility connected circuits. Reinforced insulation to the utility is required. The RPO switch must be a dedicated latching-type switch not tied into any other circuit. The RPO signal must remain active for at least 250 ms for proper operation.
- To ensure the UPS stops supplying power to the load during any mode of operation, the input power must be disconnected from the UPS when the Remote Power Off function is activated.

Table 20. RPO Connections Detail

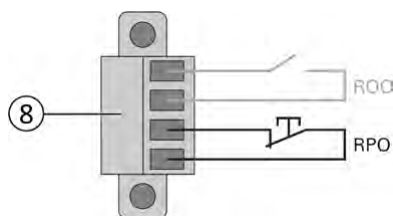

RPO	Comments
Connector type	Terminal, 14 AWG Maximum wires
Terminal rating	60 V DC/30 V AC 20 mA max

Remote On/Off (ROO)

- Remote On/Off allows remote action of button to switch On/Off the UPS.
- When contact changes from open to closed, the UPS is switched-on (or stays On).
- When contact changes from closed to open, the UPS is switched-off (or stays Off).
- On/Off control via button has priority over the remote control.



The ROO function is only active after the first use of the "Remote OFF" function.

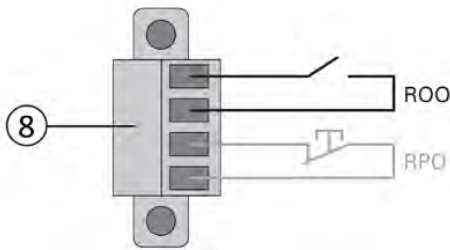

ROO	Comments
Connector type	Terminal, 14 AWG Maximum wires
Terminal rating	60 V DC/30 V AC 20 mA max

Remote control connection and test

1. Check the UPS is shut down and the electrical supply network disconnected.
2. Remove RPO connector from the UPS by removing the screws.
3. Connect a normally closed volt-free contact between the two pins of connector.

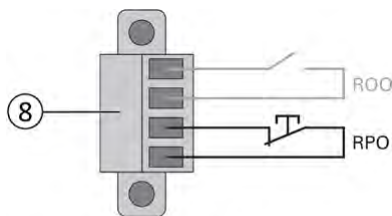

Normally Closed

Contact open: shut down of UPS.

To return to normal operation, deactivate the external remote shut down contact and restart the UPS from the front panel.

4. Plug the RPO connector into the back of the UPS and fix the screws.
5. Connect and restart the UPS according to the previously described procedures.
6. Activate the external remote shut down contact to test the function

Always test the RPO function before applying your critical load to avoid accidental load loss.

Programmable signal outputs

The SmartPro incorporates several programmable signal outputs: one relay output and two optocoupler outputs (DB9 pins 1 and 8). Signal outputs can be configured (see Settings > Comm settings > Output Signals) to report the following information:

Table 21. Programmable Signal Outputs Details

Signal	Default Assignment	Description
On battery (On Bat)	DB9-Pin 8	UPS is in battery mode
Low battery (Low Bat)	DB9-Pin 1	UPS is in battery mode and has reached the low battery alarm threshold
Battery fault	(1) Relay output	Battery fault
UPS OK	DB9-Pin 7	Load is powered with no alarm (from inverter or bypass)
Load protected	-	UPS is on inverter, with no alarm and ready to go to battery
Load powered	-	Load is powered(from inverter or bypass)
General alarm	-	Choose events that will trigger this alarm through the LCD (Settings > Comm settings > General alarm). For more information on possible events please look at User settings
OVLd pre-alarm	-	Overload pre-alarm
Bat disconn	-	Battery is disconnected

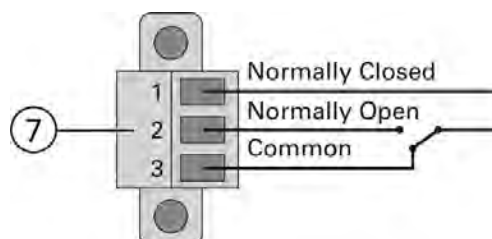
Figure 7. Relay Output Details

4.7 Power Alert Software

Use with Tripp Lite's PowerAlert Software and included cables to enable your computer to automatically save open files and shut down equipment during a blackout. Also use PowerAlert Software to monitor a wide variety of AC line power and UPS operating conditions. Consult your PowerAlert Software manual or contact Tripp Lite Customer Support for more information.

4.8 Cybersecurity

Eaton is committed to minimizing the Cybersecurity risk in its products and employs cybersecurity best practices and the latest cybersecurity technologies in its products and solutions, making them more secure, reliable and competitive for our customers. Eaton also offers Cybersecurity Best Practices whitepapers to its customers, referenced at www.eaton.com/cybersecurity.

Chapter 5 Operation

5.1 Start-up and normal operation



CAUTION

Check that the indications on the name plate located on the back of the UPS meets to the AC power source and the true electrical consumption of the total load.

Battery charge

The UPS charges the battery as soon as it is connected to the AC outlet, whether the ON/OFF button is pressed or not. It is recommended that the UPS be permanently connected to the AC power supply to ensure the best possible autonomy.

To start the UPS:

1. Verify that the UPS power cord is plugged in.
2. The UPS front panel display illuminates.
3. Press the  button on the UPS front panel for at least two seconds.
4. Check the UPS front panel display for active alarms or notices. Resolve any active alarms before continuing; if the  indicator is on, do not proceed until all alarms are clear (see). Check the UPS status from the front panel to view the active alarms. Correct the alarms and restart if necessary.
5. Verify that the  indicator illuminates solid, indicating that the UPS is operating normally and any loads are powered and protected. The UPS should be in Normal mode.

5.2 Starting the UPS on battery

Before using this feature, the UPS must have been powered by utility power with output enabled at least once.

Battery start can be disabled. See the "Cold start" setting in .

To start the UPS on battery:

1. When the UPS is disconnected from the AC power source, press the  button on the UPS front panel.

The UPS transfers from Standby mode to Battery mode. The  indicator illuminates solid.

The UPS supplies power to your equipment.

2. Check the UPS front panel display for active alarms or notices besides the "Battery mode" and related notifications that indicates missing utility power. Resolve any active alarms before continuing. See .
Check the UPS status from the front panel to view the active alarms. Correct the alarms and restart if necessary.

5.3 UPS shutdown

To shut down the UPS:

Press the  button on the front panel for three seconds.

The UPS starts to beep and shows a status of "SHUTTING DOWN...". The UPS then transfers to Standby mode.

5.4 Operating modes

The Eaton Tripp Lite Series SmartPro front panel indicates the UPS status through the UPS indicators located above the LCD screen.

Normal mode

When the green sinewave symbol is illuminated, the UPS is providing protected AC power output. The UPS monitors and charges the batteries as needed and provides power protection to your equipment.

Battery mode

When the UPS is operating during a power outage, the alarm beeps once every ten seconds and the indicator illuminates solid. The necessary energy is provided by the battery.

When the utility power returns, the UPS transfers to Normal mode operation while the battery recharges. If battery capacity becomes low while in Battery mode, the audible alarm beeps once every three seconds.

This warning is approximate, and the actual time to shutdown may vary significantly; gracefully shutdown all applications on connected equipment due to imminent UPS shutdown.

When utility power is restored after the UPS shuts down, the UPS automatically restarts.

Low-battery warning

- The  indicator illuminates solid.
- The audio alarm beeps every three seconds.

The remaining battery power is low. Shut down all applications on the connected equipment because automatic UPS shutdown is imminent.

End of battery backup time

- LCD displays "BACKUP END MODE".
- All the LEDs go OFF.
- The audible alarm stops.

5.5 Return of AC input power

Following an outage, the UPS restarts automatically when AC input power returns (unless the restart function has been disabled) and the load is supplied again.

5.6 Configuring Battery Settings

Automatic battery test

Automatic battery tests are done every month.

During the test, the UPS transfers to Battery mode and discharges the batteries for 10 seconds under load. Battery mode is not displayed and battery low alarm does not activate during a battery test.

The battery test may be postponed due to bad conditions, or failed if battery is not ok.

Low battery warning

During discharge, the low battery alarm is activated if the remaining runtime goes below 3 minutes or less than the setting capacity threshold (0% by default).

This threshold can be modified.

External battery setting

The number of Extended Battery Module is automatically detected.

Deep discharge protection

This setting is recommended to avoid damaging the battery. Warranty is void if deep discharge protection is disabled.

5.7 Retrieving the event and fault log

To retrieve the event and fault log through the display:

1. Press any button to activate the menu options, then select event log.
2. Scroll through the listed events and faults.

Retrieving the event and fault log

Chapter 6 UPS Maintenance

6.1 Equipment Care

For the best preventive maintenance, keep the area around the equipment clean and dust free. If the atmosphere is very dusty, clean the outside of the system with a vacuum cleaner.

For full battery life, keep the equipment at an ambient temperature of 25 °C (77 °F).

The batteries are rated for a 3-5 year service life. The length of service life varies, depending on the frequency of usage and ambient temperature (life divided by 2 each 10 °C above 25 °C).

If the UPS requires any type of transportation, verify that the UPS is turned off.

Batteries used beyond expected service life will often have severely reduced runtimes. Replace batteries at least every 4 years to keep units running at peak performance.

Batteries runtime will be reduced at low temperature (below 10 °C).

6.2 Storing the Equipment

If you store the equipment for a long period, recharge the battery every 6 months by connecting the UPS to utility power. The internal batteries charge to 90% capacity in less than 3 hours. However, Eaton recommends that the batteries charge for 48 hours after long-term storage.

Check the battery recharge date on the shipping carton label. If the date has passed and the batteries were never recharged, do not use them. Contact your service representative.

6.3 When to Replace Batteries

Eaton Tripp Lite Series UPS batteries have an expected life span of 3-5 years.

After 4 years of operation you should take proactive steps to ensure you replace your batteries for optimal operation and reliability.

Contact your service representative to order new batteries.

Battery recommended replacement reference can be accessed through the LCD.

6.4 Replacing Batteries



DO NOT DISCONNECT the batteries while the UPS is in Battery mode.

For battery replacement, follow Eaton Tripp Lite Series instructions provided on www.eaton.com/UPSservices.

Batteries can be replaced easily without turning off the UPS or disconnecting the load.

Consider all warnings, cautions, and notes before replacing batteries.

- Servicing should be performed by qualified service personnel knowledgeable of batteries and required precautions.

Keep unauthorized personnel away from batteries.

- Batteries can present a risk of electrical shock or burn from high short circuit current.

Observe the following precautions:

1. Remove watches, rings, or other metal objects,
2. Use tools with insulated handles,

Replacing Batteries

3. Do not lay tools or metal parts on top of batteries,
 4. Wear rubber gloves and boots.
- When replacing batteries, replace with the same type and number of batteries or battery packs. Contact your service representative to order new batteries.
 - Proper disposal of batteries is required. Refer to your local codes for disposal requirements.
 - Never dispose of batteries in a fire. Batteries may explode when exposed to flame.
 - Do not open or mutilate the battery or batteries. Released electrolyte is harmful to the skin and eyes and may be extremely toxic.
 - Determine if the battery is inadvertently grounded. If inadvertently grounded, remove source from ground. Contact with any part of a grounded battery can result in electrical shock. The likelihood of such shock can be reduced if such grounds are removed during installation and maintenance (applicable to equipment and remote battery supplies not having a grounded supply circuit).
 - **ELECTRIC ENERGY HAZARD.** Do not attempt to alter any battery wiring or connectors. Attempting to alter wiring can cause injury.
 - Disconnect charging source prior to connecting or disconnecting battery terminals.

Replacing the Internal Battery

The internal battery is heavy. Use caution when handling the heavy batteries. See [Figure 8](#).

**NOTE**

A Phillips head screwdriver is needed to perform this procedure.

1. Pull off the front panel by pressing the tabs on both sides.
2. Disconnect the battery pack by separating the connectors (never pull on the wires).
3. Remove the metal protection cover in front of the battery (three screws).
4. Pull the plastic tab to remove the battery pack and replace it.

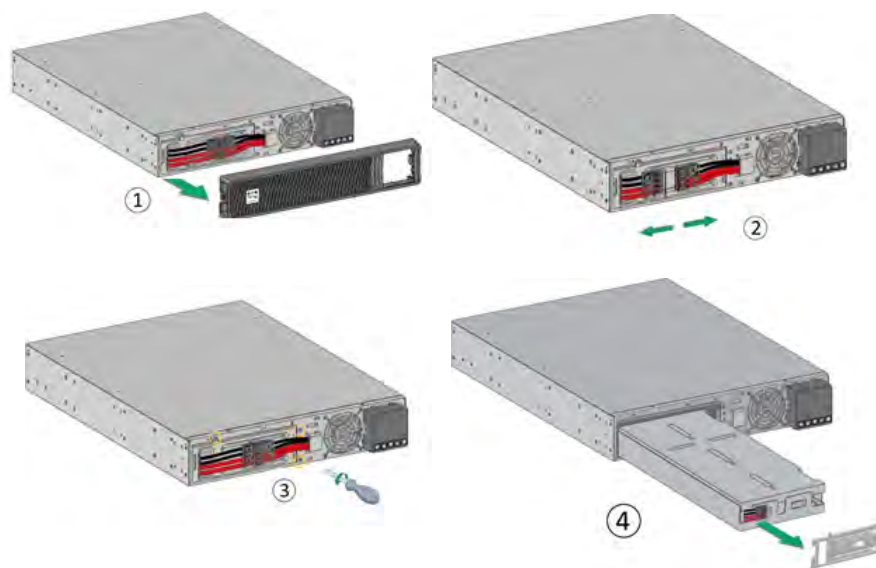
Figure 8. Battery Replacement

WARNING

Take care not to reverse the polarity + (red) and - (black) when connecting the batteries as this will destroy the device.

Testing New Batteries

To test new batteries:

1. Charge the batteries for 48 hours.
2. Press any button to activate the menu options.
3. Select "CONTROL" then Start battery test. The UPS starts a battery test if the batteries are fully charged, the UPS is in Normal mode with no active alarms, and the bypass voltage is acceptable. During the battery test, the UPS transfers to Battery mode and discharges the batteries for 10 seconds. The front panel displays "BAT TESTING".

6.5 Replacing the UPS Equipped with a HotSwap MBP

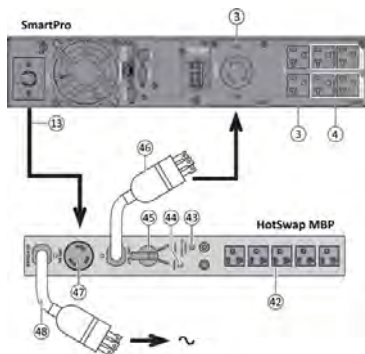

The HotSwap MBP module makes it possible to service or even replace the UPS without affecting the connected loads (HotSwap function).

Maintenance

1. Set switch (45) to Bypass position. The red LED on the HotSwap MBP module goes ON, indicating that the load is supplied directly with AC input source power.
2. Stop the UPS by pressing the  button on the UPS control panel. LED (43) "UPS ON - OK to switch" goes OFF, the UPS can now be disconnected and replaced.

Return to normal operation

1. Check that the UPS is correctly connected to the HotSwap MBP module.
2. Start the UPS by pressing the  button on the UPS control panel. LED (43) "UPS ON - OK to switch" on the HotSwap MBP module goes ON (otherwise, there is a connection error between the HotSwap MBP module and the UPS).
3. Set switch (45) to Normal position. The red LED on the HotSwap MBP module goes OFF.

Chapter 7 Troubleshooting

7.1 Typical Alarms and Faults

To check the Event log or Fault log:

1. Press any button on the front panel display to activate the menu options.
2. Press the ▼ button to select Event log.
3. Scroll through the listed events or faults.

The following table describes typical conditions:

Table 22. Alarm Conditions







Conditions	Possible cause	Action
Battery mode  LED is On. 1 beep every 10 seconds	A utility failure has occurred and the UPS is in battery mode.	The UPS is powering the equipment with battery power. Prepare your equipment for shutdown.
Battery low  LED is On. 1 beep every 3 seconds	The UPS is in Battery mode and the battery is running low.	This warning is approximate, and the actual time to shutdown may vary significantly. Depending on the UPS load and number of Extended Battery Modules (EBMs), the "BATTERY LOW" warning may occur before the remaining time reaches 3 minutes by default.
No battery  LED is On Beep continuous	The batteries are disconnected.	Verify that all batteries are properly connected. If the condition persists, contact your service representative.
Battery fault  LED is On. Beep continuous	The battery test is failed due to bad or disconnected batteries.	Verify that all batteries are properly connected. If the condition persists, contact your service representative.
The UPS does not provide the expected backup time.	The batteries need charging or service.	Apply utility power for 48 hours to charge the batteries. If the condition persists, contact your service representative.
Power Overload  LED is On	Power requirements exceed the UPS capacity (greater than 100% of nominal; see "User Settings" for specific output overload ranges).	Remove some of the equipment from the UPS. The UPS continues to operate, but may shut down if the load increases. The alarm resets when the condition becomes inactive.
UPS overtemperature  LED is On 1 beep every 3 seconds	The UPS internal temperature is too high or a fan has failed. At the warning level, the UPS generates the alarm but remains in the current operating state. If the temperature rises another 10°C, the UPS shuts down.	Clear vents and remove any heat sources. Allow the UPS to cool. Ensure the airflow around the UPS is not restricted. Restart the UPS. If the condition continues to persist, contact your service representative.

Table 22. Alarm Conditions (Continued)

Conditions	Possible cause	Action
The UPS does not start	The input source is not connected correctly.	Check the input and battery connections.
	The Remote Power Off (RPO) switch is active or the RPO connector is missing.	If the UPS Status menu displays the "Remote Power Off" notice, deactivate the RPO input.

7.2 Detail Alarm or Fault Code

Table 23. Alarm Codes

Alarm Code	Message	Description
#004	UPS TEMP. ALARM	Ambient or NTC temperature is high
#110	BUILDING ALARM	Building alarm
#604	BATTERY LOW	Battery level is below Remaining Capacity Limit threshold or Run Time to Empty is below Remaining Time Limit threshold.
#802	IMMINENT SHUTOFF	Shut down imminent
#806	EMERGENCY OFF	Emergency stop was proceed
#808	OVLN PREALARM	The load percent is > the overload level setting(default 105%)

Table 24. Alarm Fault Codes

Fault Code	Message	Description
#007	FAN FAULT	Ventilator fault
#60D	NO BATTERY	Battery not present
#607	BATTERY FAULT	Battery need replacement OR is faulty
#004	UPS TEMP. FAULT	UPS internal temperature is high, over fault point
#808	POWER OVERLOAD	Overload counter time reach, transfer to Fault mode
#805	OUTPUT SHORTED	Short circuit on output
#107	INPUT BAD WIRING	Site wiring fault that can come of Phase neutral inversion on single phase UPS
#809	INDU OVERLOAD	Inductive overload occurred, transfer to Fault mode
#80A	CAPA OVERLOAD	Capacitive overload occurred, transfer to Fault mode
#804	IMBALANCE LOAD	Load is unbalance

Table 24. Alarm Fault Codes (Continued)

Fault Code	Message	Description
#002	INTERNAL FAULT	UPS Internal fault:Main relay abnormal
#002	SAFETY FAULT	Safety relay is failure
#002	NTC ABNORMAL	NTC abnormal
#105	AVR TOO HOT	AVR is abnormal
#500	CHARGER FAULT	Charger internal failure
#502	MAX CHARGER VOLT	The charger voltage is>2.5VPC
#503	MIN CHARGER VOLT	The charger voltage is<1.5VPC

7.3 Silencing the Alarm

Press the ESC (Escape) button on the front panel display to silence the alarm. Check the alarm condition and perform the applicable action to resolve the condition. If the alarm status changes, the alarm beeps again, overriding the previous alarm silencing.

7.4 Service and Support

If you have any question or problem with the UPS, call Eaton Tripp Lite Series or your local service representative in your

country / region.

Please have the following information ready when you call for service:

- Model number
- Serial number
- Firmware version number
- Date of failure or problem
- Symptoms of failure or problem
- Customer return address and contact information

If repair is required, you will be given a Returned Material Authorization (RMA) number. This number must appear on the outside of the package and on the Bill Of Lading (if applicable). Use the original packaging or request packaging from the Help Desk or distributor. Units damaged in shipment as a result of improper packaging are not covered under warranty. A replacement or repair unit will be shipped freight prepaid for all warranted units.

NOTICE

For critical applications, immediate replacement may be available. Call the Help Desk for the dealer or distributor nearest you.

For US and Canada you can contact post-sales service support at: 1-(800)-356-5737.

Chapter 8 Specifications

8.1 UPS Model List

Description	Catalog Number	Power rating	Configuration
TRIPP LITE SMARTPRO 750 RTXL2U TRIPP LITE SMARTPRO 750 RTXL2U NETPACK	SMART750RML2U SMART750RML2UN	750W/750VA	Rack / Tower
TRIPP LITE SMARTPRO 1000 RTXL2U TRIPP LITE SMARTPRO 1000 RTXL2U NETPACK	SMART1000RML2U SMART1000RMX2UN	1000W/1000VA	Rack / Tower
TRIPP LITE SMARTPRO 1500 RTXL2U TRIPP LITE SMARTPRO 1500 RTXL2U NETPACK	SMART1500RML2U SMART1500RMLN	1440W/1440VA	Rack / Tower
TRIPP LITE SMARTPRO 2200 RTXL2U TRIPP LITE SMARTPRO 2200 RTXL2U NETPACK	SMART2200RML2U SMART2200RMLN SMART2200RM2U SMART2200RM2UN	1950W/1950VA	Rack / Tower
TRIPP LITE SMARTPRO 3000 RTXL2U TRIPP LITE SMARTPRO 3000 RTXL2U NETPACK	SMART3000RML2U SMART3000RMLN SMART3000RM2U SMART3000RM2UN	3000W/3000VA	Rack / Tower

8.2 Extended Battery Module Model List

Model	Catalog Number	Configuration	Battery voltage	Use with
Tripp Lite SmartPro 48V BP 2U	BP48VRM2U	Rack / Tower	48Vdc	SMART750RML2U, SMART750RML2UN, SMART1000RML2U, SMART1000RMX2UN SMART1500RML2U, SMART1500RMLN
Tripp Lite SmartPro 72V BP 2U	BP72VRM2U	Rack / Tower	72Vdc	SMART2200RML2U, SMART2200RMLN, SMART3000RML2U, SMART3000RMLN

8.3 Weights and Dimensions

Description (UPS)	Weights (lbs / kg)	Dimensions (inch / mm) D x W x H
SMART750RML2U SMART750RML2UN	44.5 / 20.2	17.6x17.2x3.4 / 448x438x85.5
SMART1000RML2U SMART1000RMX2UN	44.5 / 20.2	17.6x17.2x3.4 / 448x438x85.5

Electrical Input

Description (UPS)	Weights (lbs / kg)	Dimensions (inch / mm) D x W x H
SMART1500RML2U SMART1500RMLN	50.7 / 23.0	17.6x17.2x3.4 / 448x438x85.5
SMART2200RML2U SMART2200RMLN SMART2200RM2U SMART2200RM2UN	65.3 / 29.6	23.7x17.2x3.4 / 603x438x85.5
SMART3000RML2U SMART3000RMLN SMART3000RM2U SMART3000RM2UN	74.5 / 33.8	23.7x17.2x3.4 / 603x438x85.5
Description (EBM)	Weights (lbs/ kg)	Dimensions (inch / mm) D x W x H
BP48VRM2U	61.3 / 27.8	17.6x17.2x3.4 / 448x438x85.5
BP72VRM2U	89.1 / 40.4	23.7x17.2x3.4 / 603x438x85.5

8.4 Electrical Input

Default frequency	60Hz
Nominal frequency	50/60Hz
Frequency range	47-70Hz

Catalog Number	Default input (Voltage/ Current)	Input nominal voltages	Input voltage window
SMART750RML2U SMART750RML2UN SMART1000RML2U SMART1000RMX2UN	120V/12A	100-125V	80-151V adjustable to 70-153V
SMART1500RML2U SMART1500RMLN	120V/12A		
SMART2200RM2U SMART2200RM2UN SMART2200RML2U SMART2200RMLN	120V/16A		
SMART3000RM2U SMART3000RM2UN SMART3000RML2U SMART3000RMLN	120V/24A		

8.5 Electrical Input Connections

Catalog Number	Input connection	Input cable
SMART750RMXL2U SMART750RMXL2UN	Fixed	NEMA 5-15P
SMART1000RMXL2U SMART1000RMX2UN		NEMA 5-15P
SMART1500RMXL2U SMART1500RMXLN		NEMA 5-15P
SMART2200RM2U SMART2200RM2UN SMART2200RMXL2U SMART2200RMXLN		NEMA 5-20P
SMART3000RM2U SMART3000RM2UN SMART3000RMXL2U SMART3000RMXLN		NEMA L5-30P

8.6 Electrical Output

All models	Normal mode	Battery mode	
Voltage regulation	Boost : $V_{in} * 1.15$ Buck : $V_{in} * 0.87$	(-10% ,6%)	
Efficiency	>96%	750-2200 > 82% 3000 > 85%	
Frequency regulation		+/-0.1 Hz	
Nominal output	100/110/120/125V		
Frequency	Follows input frequency	50/60Hz	
Output overload	[105%,120%] 30min [120%,150%] 5min >150% 10s	[105% ~110%] 10s - Output short-circuit current max RMS & delay time: 114.5A/100ms; The max peak value: 202A	
Short circuit current limitation in battery mode		Model	Current limitation
		750	41A
		1000	41A
		1500	56A
		2200	66A
		3000	90A
Transfer time	Utility Outage: 1-4ms for normal mode, >5ms for sensitive mode Utility abnormal: <10ms for normal mode, <25ms for sensitive mode		

8.7 Electrical Output Connection

Catalog Number	Output connection
SMART750RML2U SMART750RML2UN	(4) 5-15R Primary (2) 5-15R Group1 (2) 5-15R Group2
SMART1000RML2U SMART1000RMX2UN	
SMART1500RML2U SMART1500RMLN	
SMART2200RM2U SMART2200RM2UN SMART2200RML2U SMART2200RMLN	(2)5-20R + (1)L5-20R Primary (2) 5-20R Group1 (2) 5-20R Group2
SMART3000RM2U SMART3000RM2UN SMART3000RML2U SMART3000RMLN	(2)5-20R + (1)L5-30R Primary (2) 5-20R Group1 (2) 5-20R Group2

8.8 Battery

	Internal batteries	EBM
Specifications	750VA: 48Vdc - 4 x 12V, 7Ah (9Ah max) 1000VA: 48Vdc - 4 x 12V, 7Ah (9Ah max) 1500VA: 48Vdc - 4 x 12V, 9Ah 2200VA: 72Vdc - 6 x 12V, 7Ah (9Ah max) 3000VA: 72Vdc - 6 x 12V, 9Ah	BP48VRM2U: 48Vdc - 2 x 4 x 12V, 2 x 9Ah BP72VRM2U: 72Vdc - 2 x 6 x 12V, 2 x 9Ah
Type	Sealed, maintenance-free, valve-regulated, lead-acid, with minimum 3-5 year float service life at 25°C (77°F).	
Monitoring	Advanced monitoring for earlier failure detection and warning	
EBM battery cable length	2U EBM cable length : 350mm/13.78in	

8.9 Environmental and Safety

Standards	IEC/EN 62040-1:2008+A1:2013 EN IEC 62040-2: 2018 IEC 62040-2: 2016 FCC CFR Title 47, Part 15, Subpart B IEC/EN 62040-3 IEC 62040-1:2017 UL1778 5th edition CSA 22.2
EMC (Emissions)	EN IEC 62040-2: 2018 C2 EN 62040-2: 2006 C2

	IEC 62040-2: 2016 C2 EN 55011:Class A CISPR11 Class A CISPR32 Class A FCC part 15 Class A
Agency markings	CE, cTUVus, FCC, Energy star NOM
Operating temperature	0 to 40 °C (32 to 104 °F)
Storage temperature	-15 to 50°C (5 to 122 °F)
Relative humidity	20 to 90 % (without condensation)
Operating altitude	Up to 3,000 meters (9,843 ft) above sea level, no derating for 40°C (104°F) room temperature
Transit altitude	Up to 10,000 meters (32,808 ft) above sea level
Audible noise	Line mode:<40dB Buck/boost mode:<45 dB Batt. Mode: <45dB, 50dB for 3K



614-40194 05