

DIVERSITY **SERIES**

QUICK START GUIDE

NETWORK VIDEO RECORDERS

TABLE OF CONTENT

- Connection Diagram..... 1
- HDD Installation..... 2
- Startup Wizard..... 3
- Remote Access via Web Client..... 12
- Remote Live View on Mobile Devices..... 14

The first time you run the NVR, you will be required to set your password immediately in order to protect your privacy.

Please be sure to record your username and password and save them in a secure place. If you forget your password, you will be unable to login the system, please contact your reseller to reset the password.

Connection Diagram

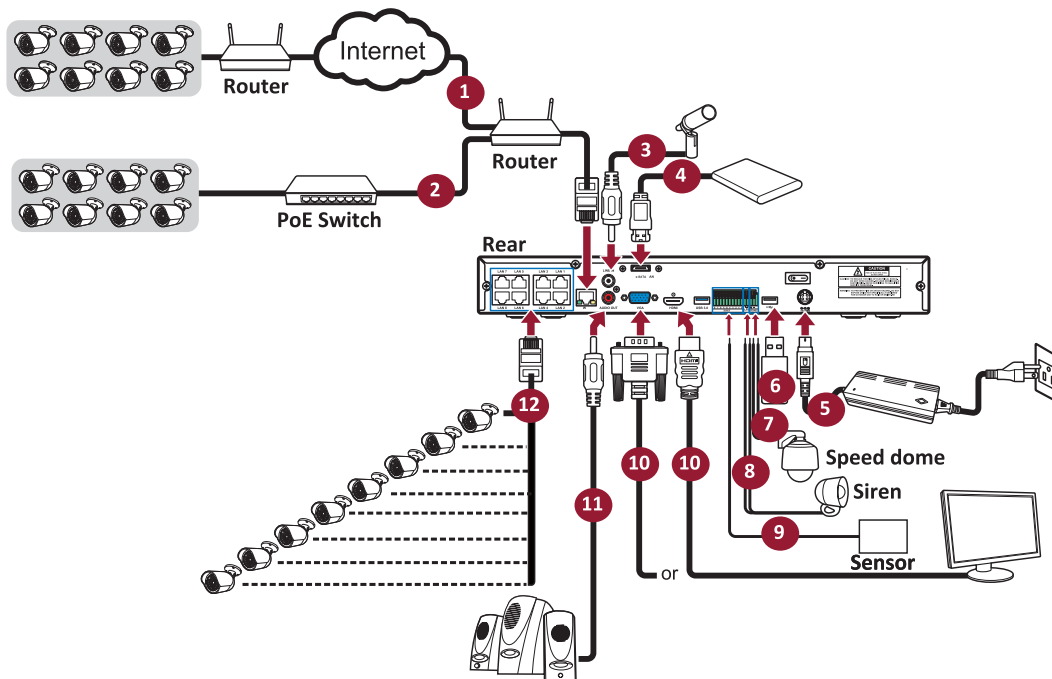

- 1) You can connect to other IP cameras remotely over the Internet.
- 2) Connect a CAT.5E or higher RJ45 Ethernet cable for local connectivity. You can connect to other IP cameras through your local network.
- 3) Two-way voice conversation with the remote PC.
- 4) Connect an external hard disk drive to backup files stored on the NVR.
- 5) Connect the included power cable (48V/2A, 4-Pin DIN connector).
- 6) Use the USB flash disk for backup, camera, or system upgrade.
- 7) Connect a RS-485 device such as speed dome camera.
- 8) Connect an external alarm output device such as siren.
- 9) Connect external alarm sensors.
- 10) Connect the video output of the NVR to the TV or monitor via HDMI or VGA connection.
- 11) Connect speakers if you want to listen to the live audio sound or audio playback from the NVR.
- 12) Connect the PoE IP cameras. It may take up to 1 minute for the cameras to start transmitting video to the NVR.

NOTE: Above diagram is for reference only. The practical connection may be different depending on the NVR you purchased.

HDD Installation

This NVR supports two 3.5" or 2.5" SATA hard disk drives.

Caution: DO NOT install or remove the hard disk drive while the device power is turned ON.

a) Connect the data and power cables to the two hard disk drives and place the hard disk drives on the NVR case.

b) Carefully flip the NVR case and secure the hard disk drives to the NVR with the eight (8) screws.

2.5"HDD

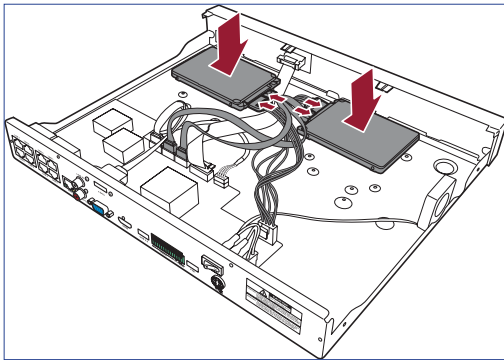

2.5"HDD

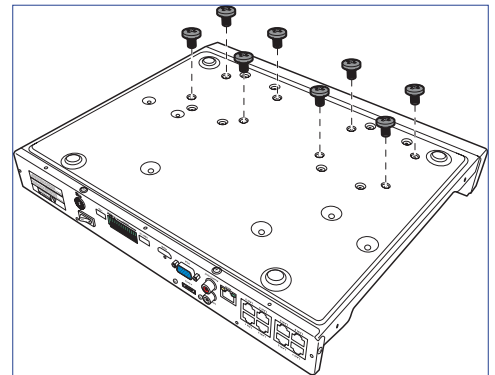

3.5"HDD

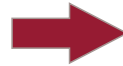
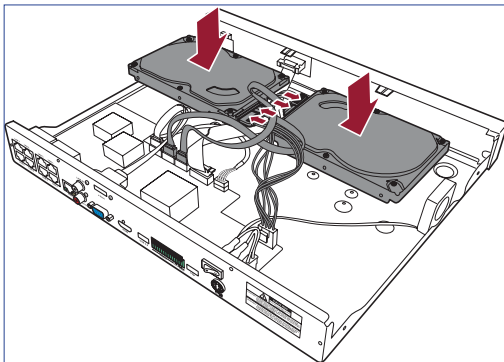

3.5"HDD

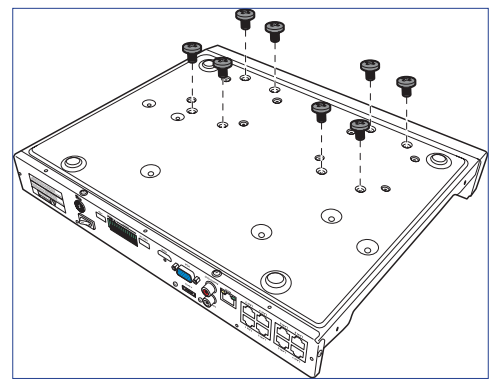

Startup Wizard

Wizard setting menu includes: start wizard page, Network, Network Configuration, Date/Time, IPC Setup, Disk, Resolution, Mobile and Summary.

1) Start Wizard

Click the **Start Wizard** to proceed to the next step

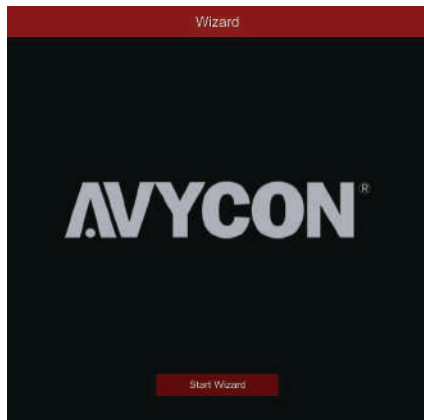

2) Network Configuration

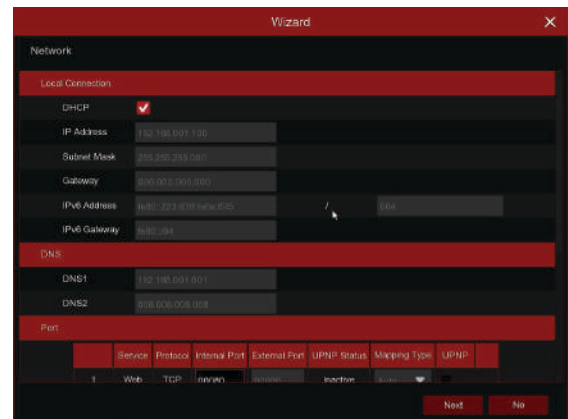

If you connect to a router allows to use DHCP, please check the **DHCP** box. The router will assign automatically all the network parameters for your NVR. Unless the network is manually addressed below parameters:

IP Address: The IP address identifies the NVR in the network. It consists of four groups of numbers between 0 to 255, separated by periods. For example, "192.168.001.100".

Subnet Mask: Subnet mask is a network parameter which defines a range of IP addresses that can be used in a network. If IP address is like a street where you live then subnet mask is like a neighborhood. The subnet address also consists of four groups of numbers, separated by periods. For example, "255.255.000.000".

Gateway: This address allows the NVR to access the Internet. The format of the **Gateway** address is the same as the **IP Address**. For example, "192.168.001.001".

DNS1/DNS2: DNS1 is the primary DNS server and DNS2 is a backup DNS server. Usually should be enough just to enter the DNS1 server address

Port

Web Port: This is the port that you will use to log in remotely to the NVR (e.g. using the Web Client). If the default port 80 is already taken by other applications, please change it.

Client Port: This is the port that the NVR will use to send information through (e.g. using the mobile app). If the default port 9000 is already taken by other applications, please change it.

RTSP Port: This is the port that the NVR will be allowed to transmit real-time streaming to other device (e.g. using a streaming Media player.).

UPnP: If you want to log in remotely to the NVR using Web Client, you need to complete the port forwarding in your router. Enable this option if your router supports the UPnP. In this case, you do not need to configure manually port forwarding on your router. If your router does not support UPnP, make sure the port forwarding is completed manually in your router.

PPPoE

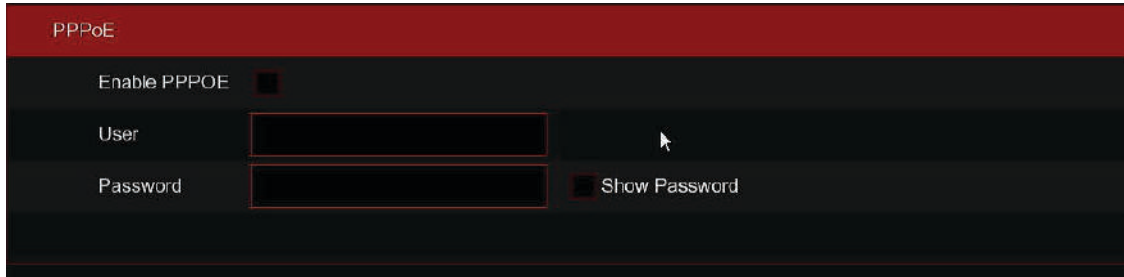

This is an advanced protocol that allows the NVR to connect to the network more directly via DSL modem.

Check the "Enable PPPOE" box, and then enter the User name & Password of the PPPoE.

3G

This is a prior using the mobile network, you need to connect a 3G dongle to the NVR. Enable the 3G option, enter the APN, Dial Code, User name & password according to the instruction of your 3G dongle device.

3) Date/Time

This menu allows you to configure the Date, Time, Date Format, Time Format, Time Zone, NTP and DST.

Date and Time

Click on the calendar icon to set the current system date.

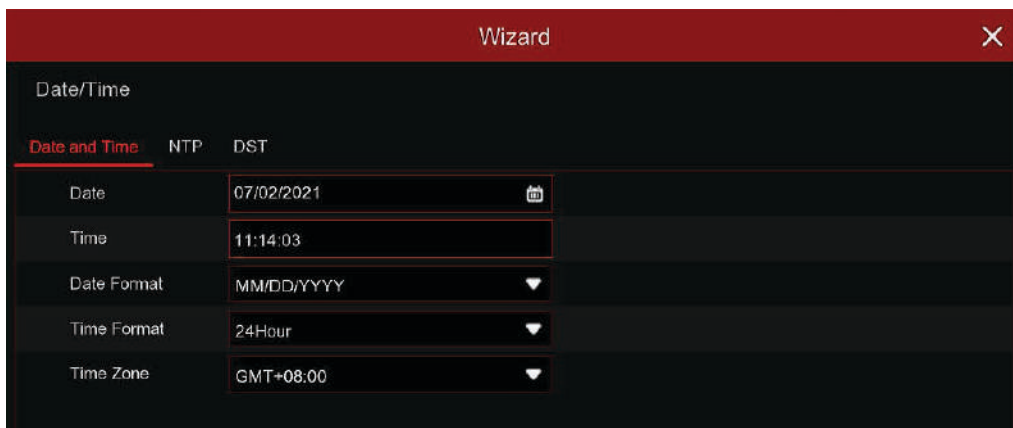

Date: Click on the calendar icon to set the system date.

Time: Click to set the system time.

Date Format: Choose from the dropdown menu to set preferred date format.

Time Format: Choose time format between 24Hour and 12Hour.

Time Zone: Set the correct time zone.

NTP

NTP stands for Network Time Protocol. This feature allows you to synchronize the date and time automatically on the NVR over Internet. Therefore, the NVR needs to be connected to the Internet.

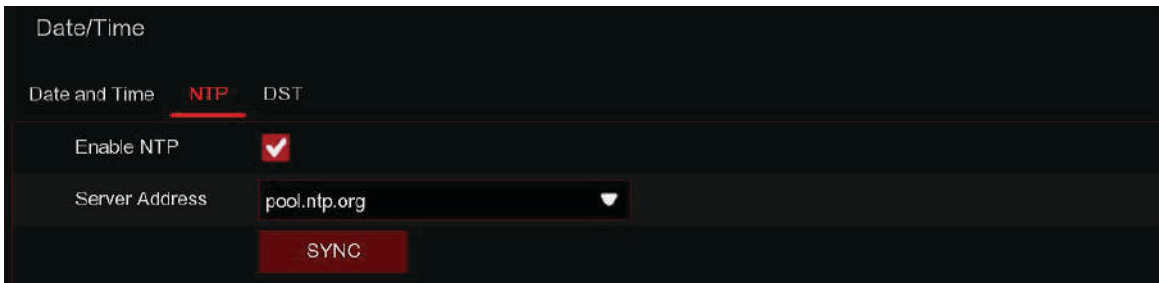

Date/Time

Date and Time **NTP** DST

Enable NTP

Server Address pool.ntp.org

SYNC

Check the **"NTP"** box, and select the NTP server.

DST

DST stands for Daylight Savings Time.

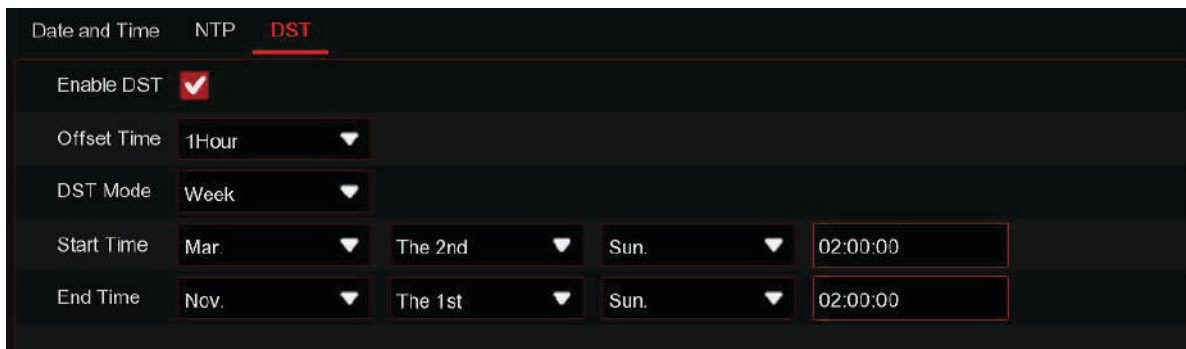

Date and Time NTP **DST**

Enable DST

Offset Time 1Hour

DST Mode Week

Start Time Mar. The 2nd Sun. 02:00:00

End Time Nov. The 1st Sun. 02:00:00

DST: Enable if Daylight Saving Time (DST) is observed in your region

Time Offset: Select the amount of time to offset for DST

Time Mode: Choose to set the daylight saving time in weeks or in days

Start Time/End Time: Set the start time and end time for daylight saving

4) IP Camera

This menu allows you to add IP cameras to the NVR.

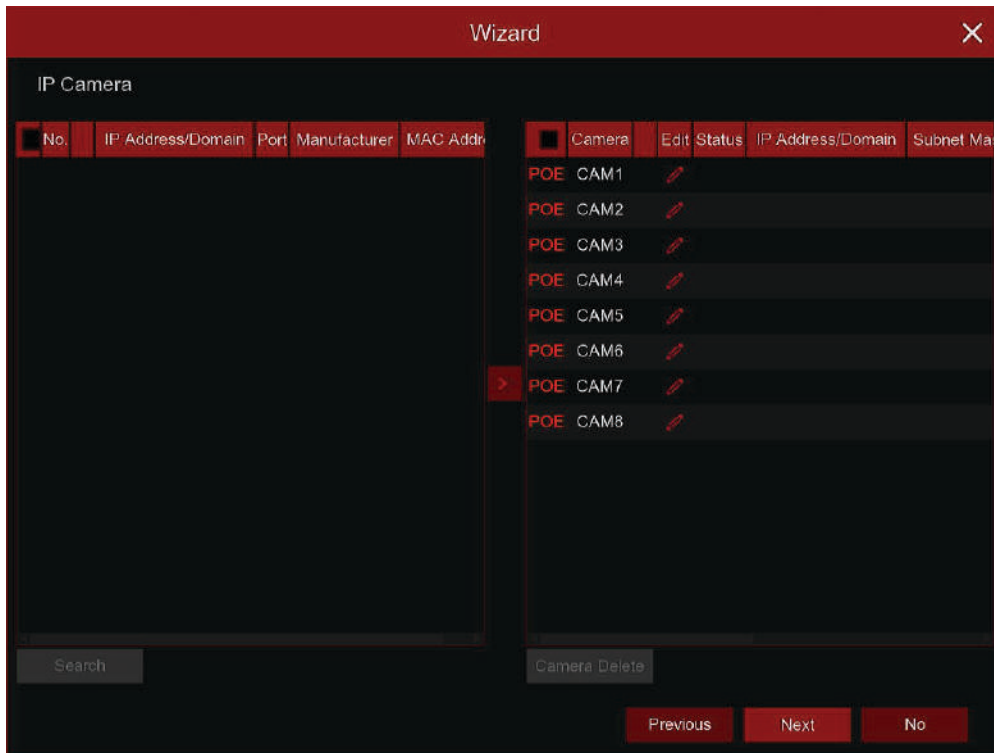

Click **Search** to search IP cameras in the same network. Choose the IP camera(s) you want to add, and then click **→** icon to add to the NVR.

Position: Left-Top

Port: 9988 Auto

Protocol: Private Auto

User Name: admin

Password: Show Password

Add Cancel

Enter the camera's user name & password to add the camera(s).

You can also click **+** button to add individual IP camera to a single channel.



Click **Search** button to search IP cameras, and then click one of the IP camera in the device list.

IP Address/Domain: IP address or domain name of the IP camera

Alias: Name of the IP camera

Position: Position to display the camera name on the screen.

Port: Port of the IP camera

Protocol: Choose the protocol of the IP camera from the dropdown menu

User Name: User Name of the IP camera

Password: Password of the IP camera

Bind channel: Choose a channel of the NVR you want to attach to

5)Disk



If the HDD is installed in the NVR for the first time, it must be formatted. Select the HDD and then click button **Format HDD** to format the HDD.

Overwrite: Use this option to overwrite the old recordings on the HDD when the HDD is full. For example, if you choose the option 7 days then only the last 7 days recordings are kept on the HDD. To prevent overwriting any old recordings, select Disable. If you have disabled this function, please check the HDD status regularly, to make sure the HDD is not full.

Record On ESATA: If your NVR comes with an e-SATA port on the rear panel, you can enable to record the video to e-SATA HDD.

6)Resolution

Choose an output resolution matches to your monitor. The NVR supports to adjust the output resolution automatically to match the best resolution of your monitor when the system is starting up.

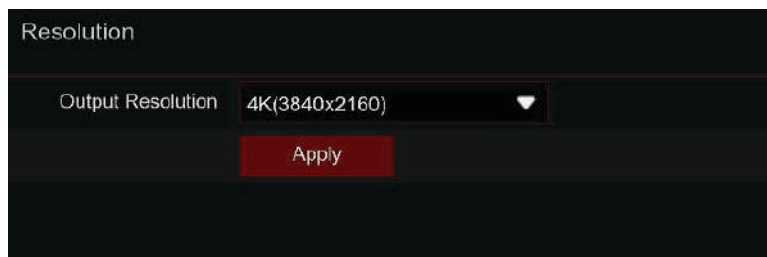

7) Mobile

If your NVR come with a P2P ID, you can scan the QR code with your mobile app to view the NVR remotely.

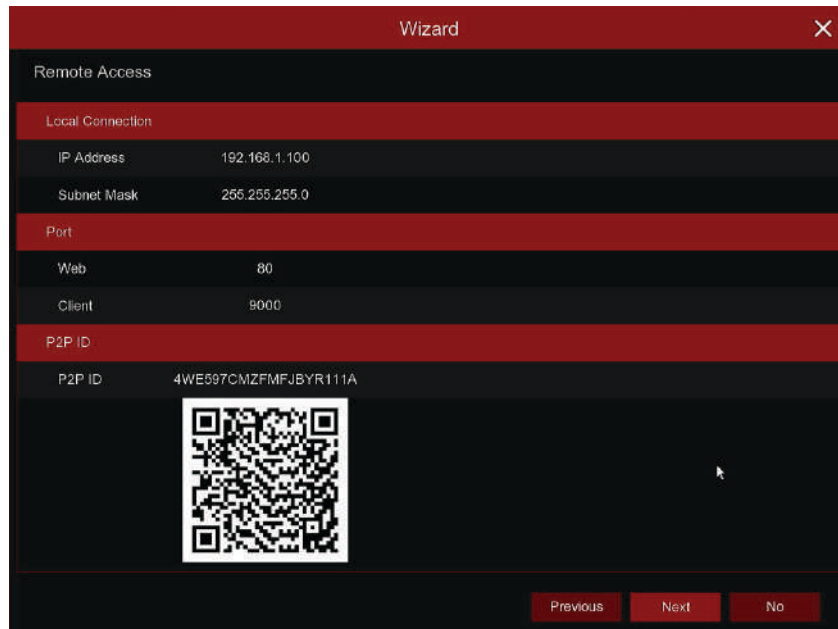

8) Summary

You can check the system summary information you had set in the start wizard and finish the wizard.

Tick "**Don't show this window next time**" if you don't want to display Start Wizard when system reboot next time. Click **Finish** button to save & exit.

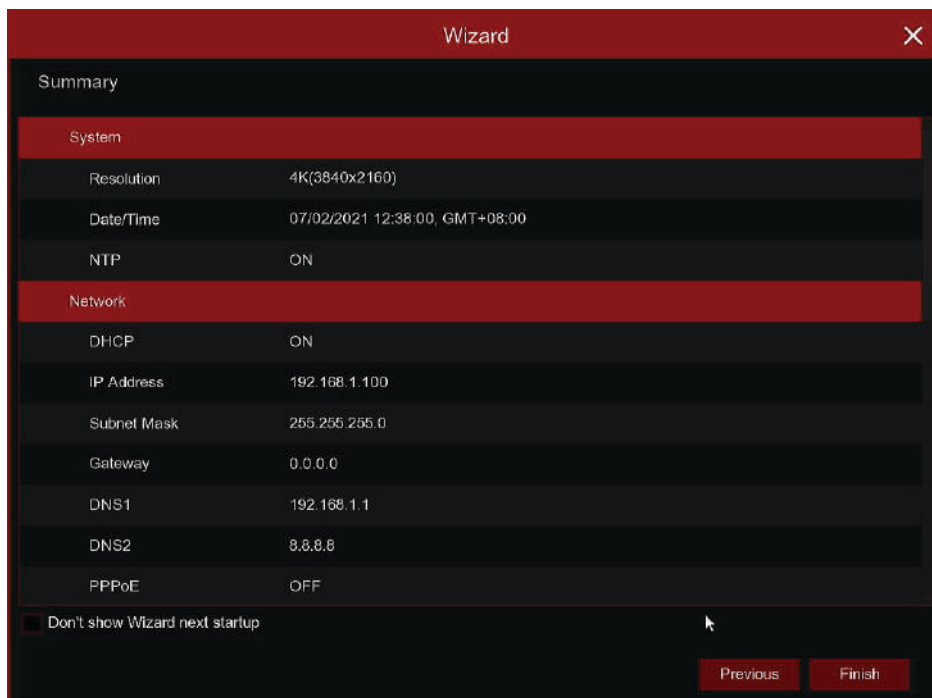

Live View Screen Overview

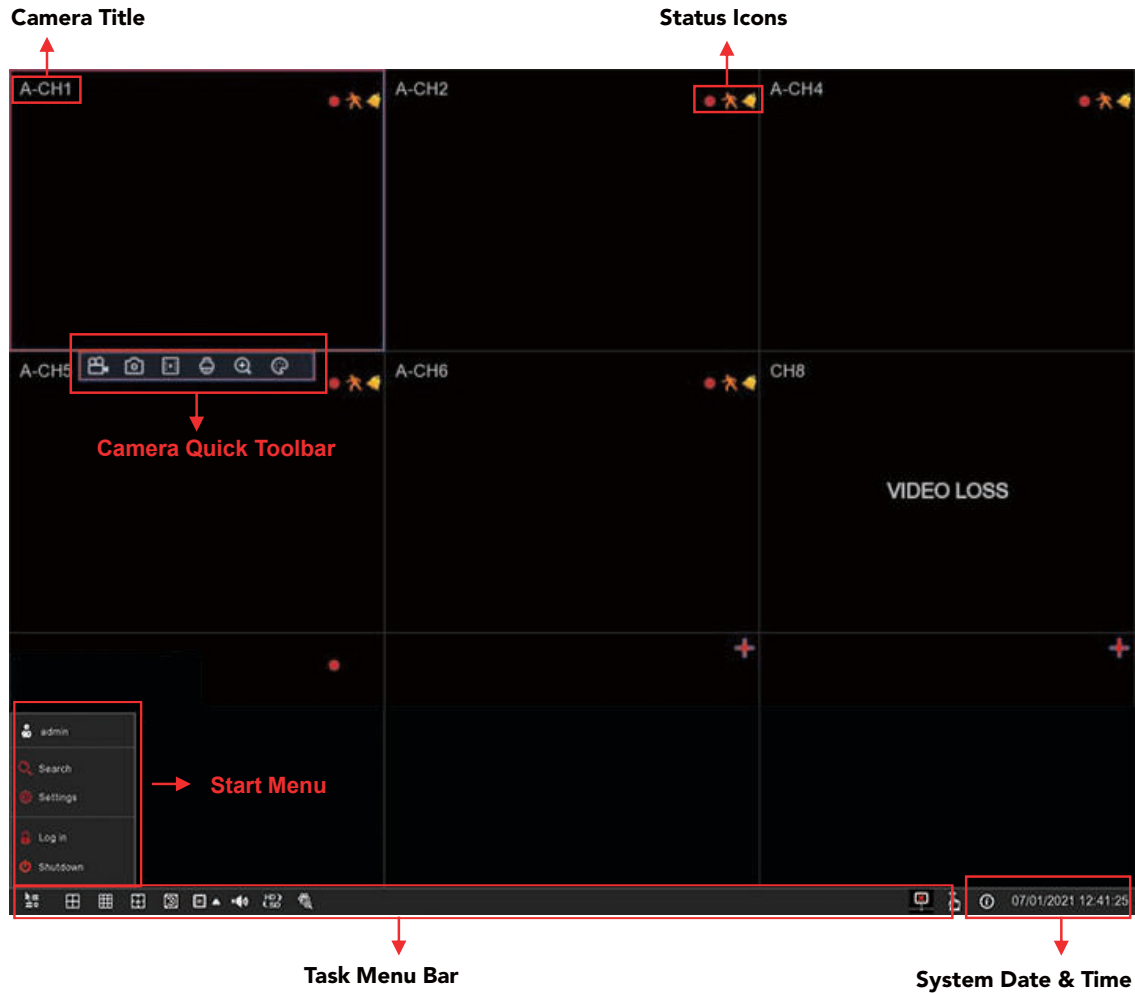

Camera Title

To display the camera title







A-: This indicates that the camera connected is an AHD camera

T-: This indicates that the camera connected is a TVI camera

C-: This indicates that the camera connected is a CVI camera

IP: This indicates that the camera connected is an IP camera

Status Icons

-  This indicates that the NVR is currently recording.
-  This icon appears when the camera has detected motion.
-  The icon indicates that the external I/O alarm device is triggered.
-  This icon indicates that the HDD is in error to work.
-  This icon indicates the HDD is unformatted.
-  This icon indicates the HDD is full.
-  This icon indicates the HDD is read-only.

VIDEO LOSS: The analog camera is disconnected.

No Camera: IP camera is disconnected.

Decoding Failed: The NVR doesn't support this kind of IP camera compression standard, please change to H.264 compression standard.

Click to open **Quick Add** menu to add IP camera

Click to edit current IP camera

※ Visit "www.al8.co" to download more tools.

Remote Access via Web Client

Use the Web Client to remotely access your NVR at anytime via a PC. Before you access the Web Client, you need to ensure that the network settings of the NVR are configured properly. The most convenient and easiest way is if you have set the NVR a static IP address . It means you only need to open the web browser on your PC and type in the static IP address you have set on the NVR. However, if the IP address of the NVR is assigned by a DHCP server , then it means that each time you reboot the NVR, the IP address changes. In this case, ask if your ISP can provide you a static IP address. If not, then configure the DDNS service. Also, please make sure the UPnP is configured in the NVR and router, or the manual port forwarding is completed in the router.

You will need to install the plug-in if this is the first time you connect to your NVR via IE, Google Chrome, Firefox, or Mac Safari.

Login to Web Client

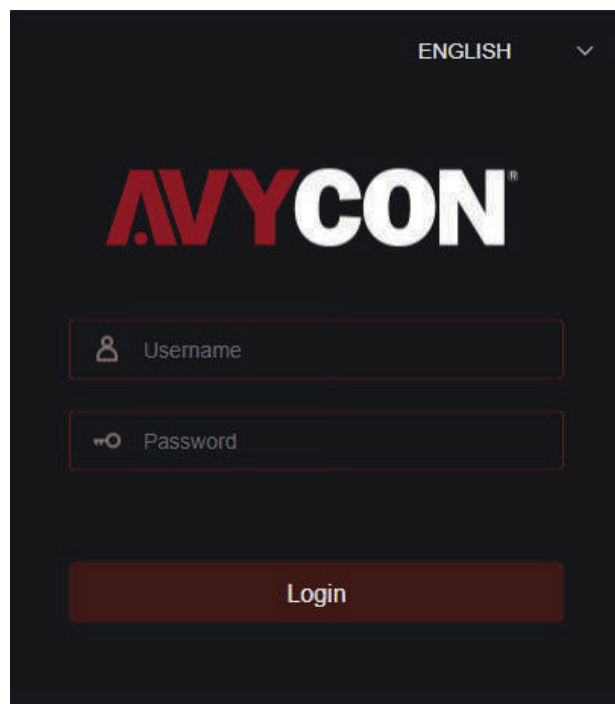

Notice for Windows 8 and Windows10 Users:

- 1) If you are running Windows 8 or Windows10,you will have to right click on Internet Explorer from the start menu and select "Run as administrator".
- 2) After successful Login to the Net Viewer,the system will enter into live display interface and connect to audio/video feed automatically.

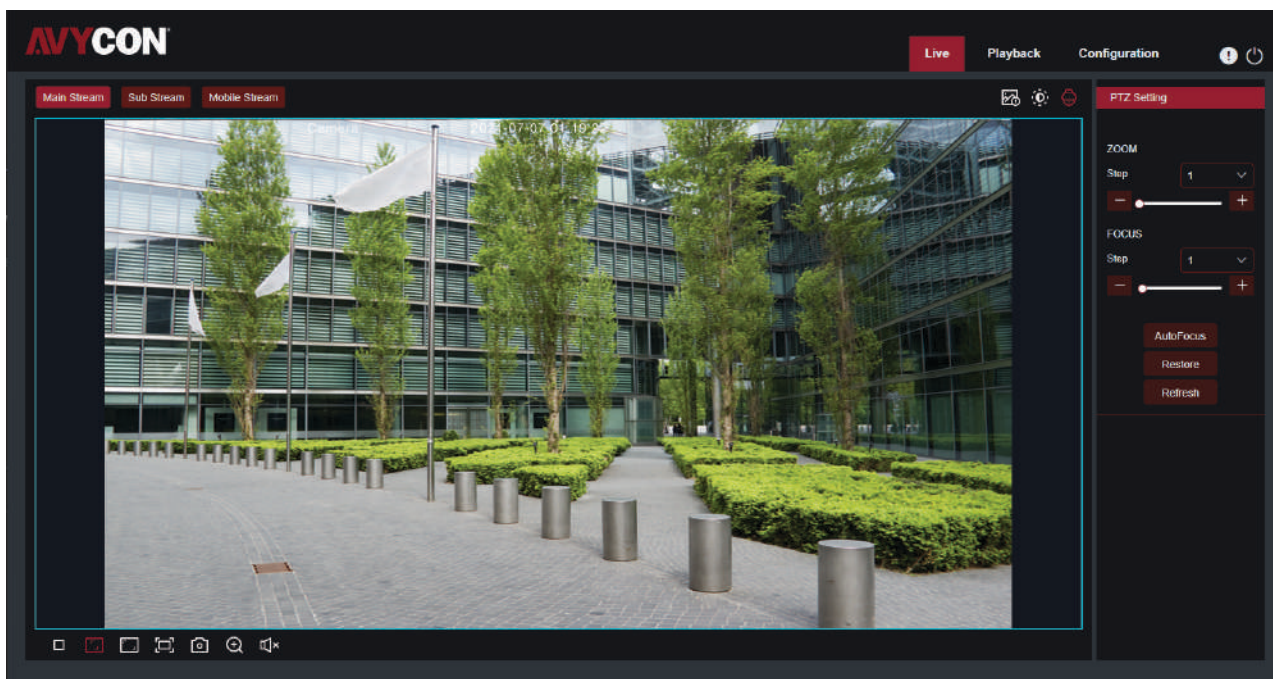

Remote Live View on Mobile Devices

- 1.) Open the App Store (iOS) or Play Store (Android).
- 2.) Search for and install AVY MobileOne application.
- 3.) Open AVY MobileOne application ()
- 4.) Go to Device. Click ' + ' to add new device. Scan QR code under NVR box. Then input client port, user name, and password, and then click "Save" to log into the NVR.
- 5.) Live View

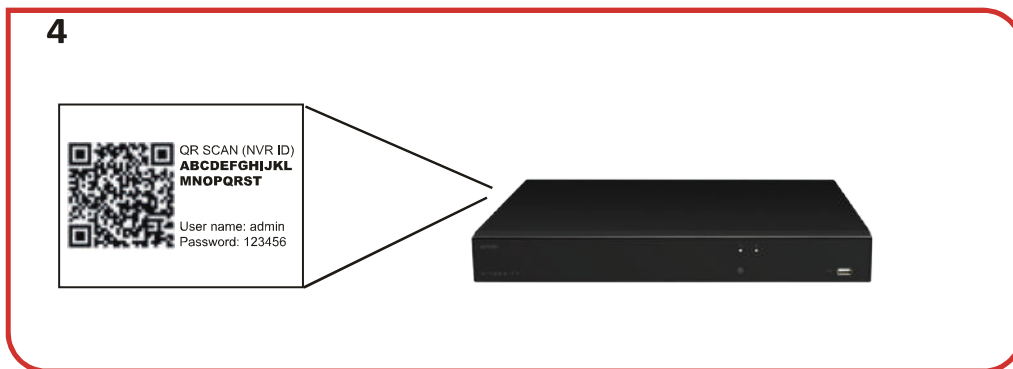
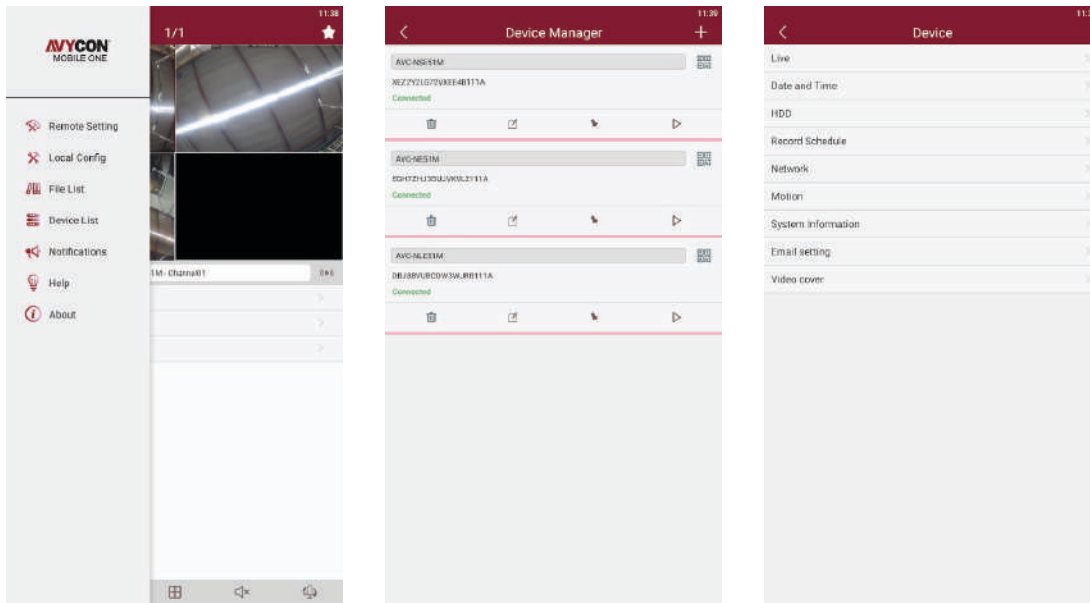

AVYCON[®]



AVYCON[®]

Copyright © AVYCON. All rights reserved. Specifications and pricing are subject to change without notice.

phone: 949-752-7606
email: info@avycon.com
social: [@avycon_aivo](#)
website: avycon.com