

Back-UPS HS 500 User's Manual

NOTE: APC recommends your network equipment (computer, modem, router, hub, or other networked devices) be completely installed, configured, and tested prior to adding this UPS to the network.

990-9236 3/04

INSTALLATION

1 Placement

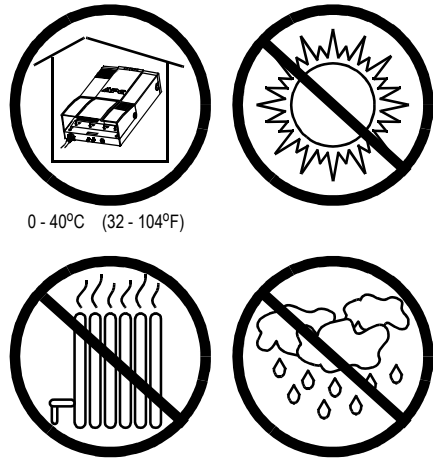

2 Remove Connector Cover

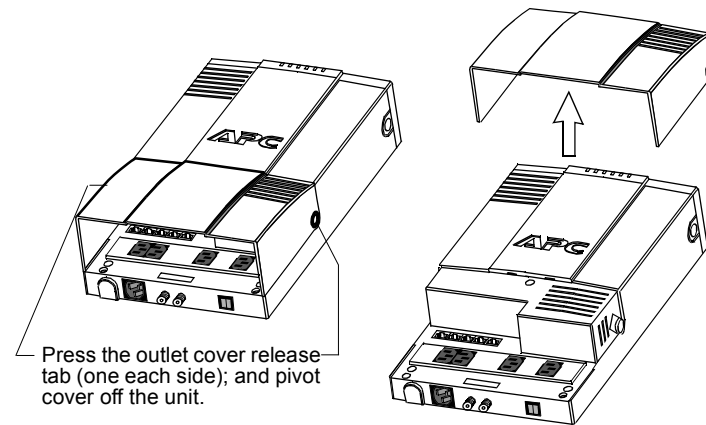

3 Remove Battery (if wall-mounting - if not proceed at Step 5)

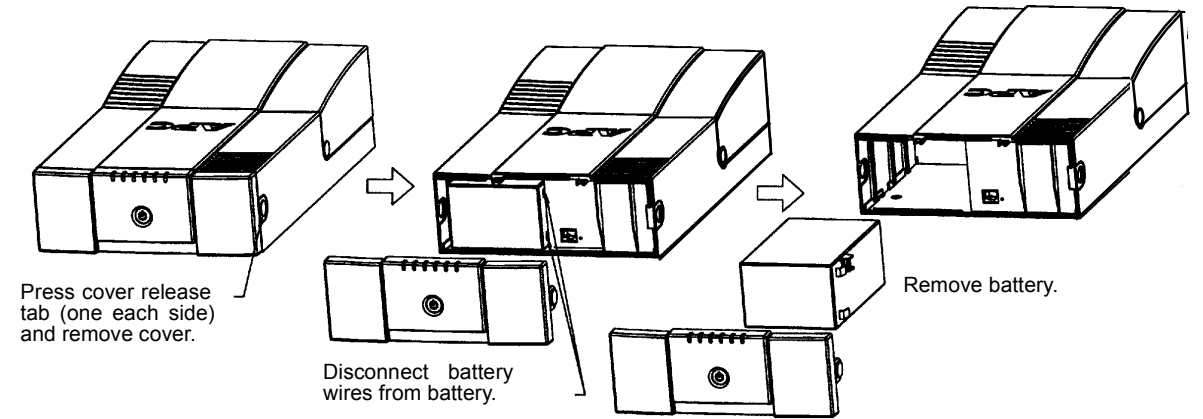

Caution: To prevent damage to the ribbon cable (not shown) that connects the cover to the UPS, replace the cover after removing the battery. Do not disconnect the ribbon cable from the cover or the UPS.

4 Mount Back-UPS (optional)

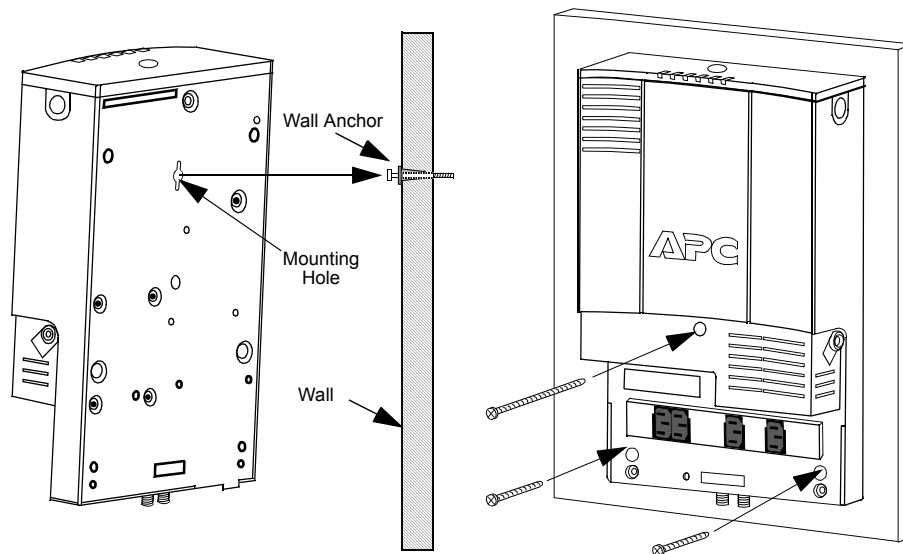

5 Connect/Install Battery, Install Battery Cover

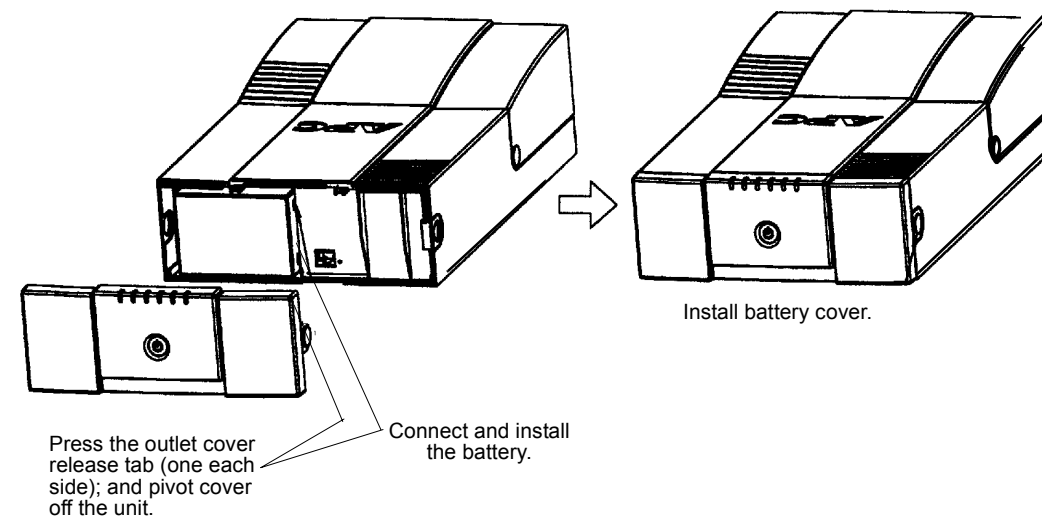

6 Connect Cable Modem, DSS or CATV Receiver to Surge Protection (optional)

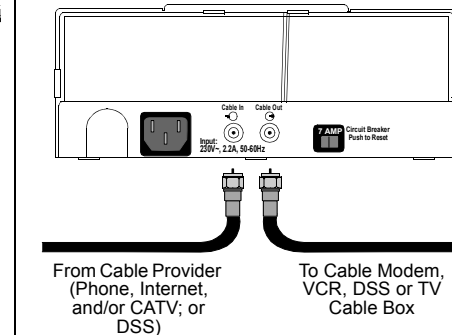

7 Connect Phone Line or DSL to Surge Protection (optional)

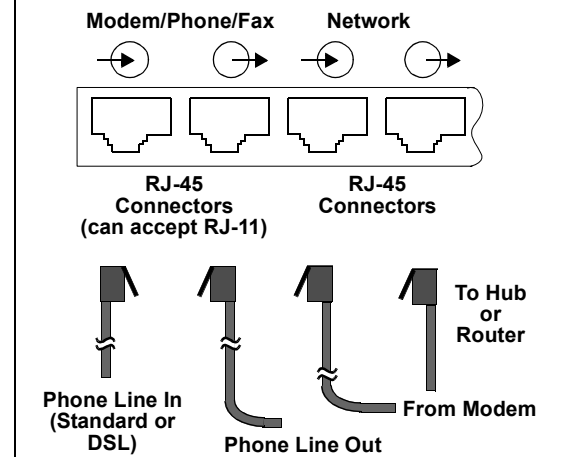

8 Connect Network Equipment

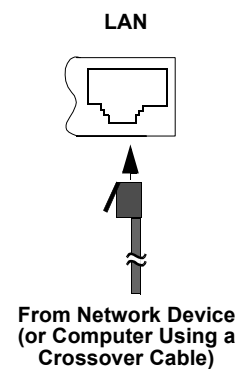

9 Connect Equipment Power Cords

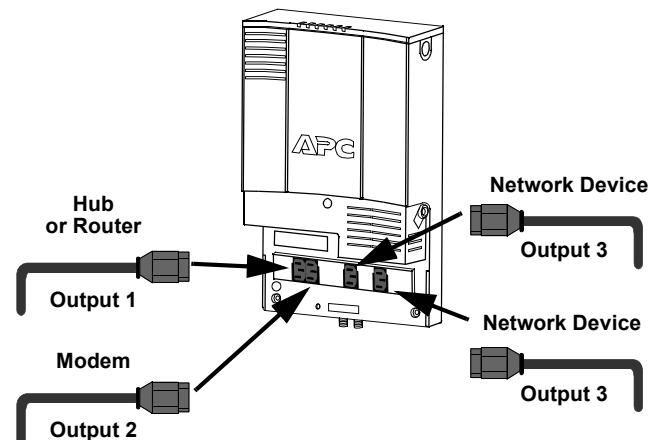

10 Install Connector Cover

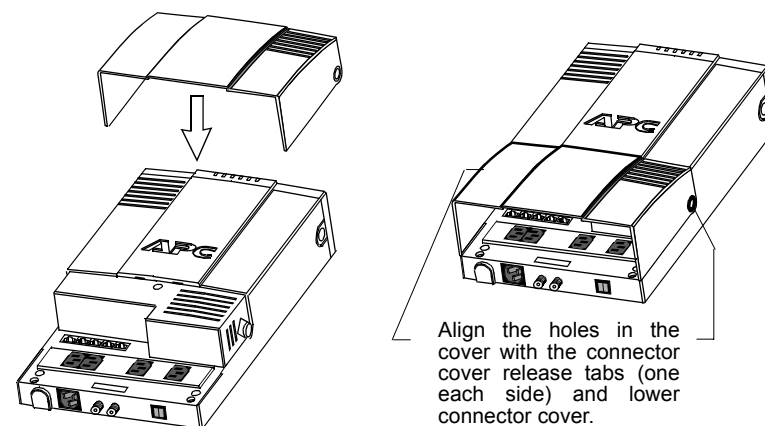

11 Connect to Power Source and Switch on UPS Power

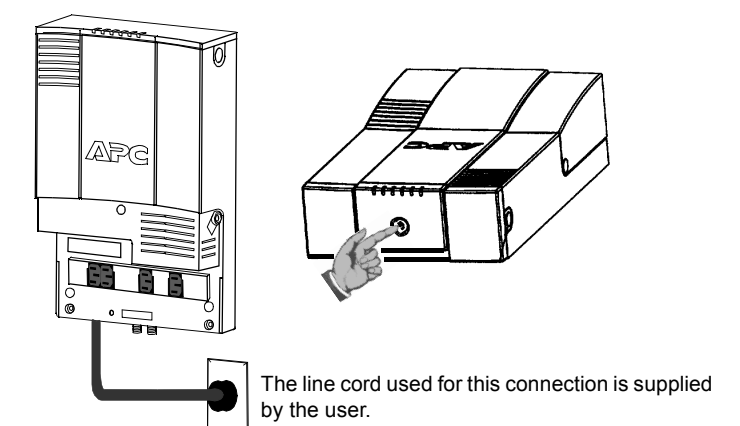

STATUS INDICATORS AND ALARMS

There are six status indicators (lights) on the front panel of the Back-UPS (**On Line**, **On Battery**, **Overload**, **Replace Battery**, **TX/RX**, and **ACT/LNK**).

On-Line **On Battery** **Overload** **Replace Battery** **TX/RX** **ACT/LNK**

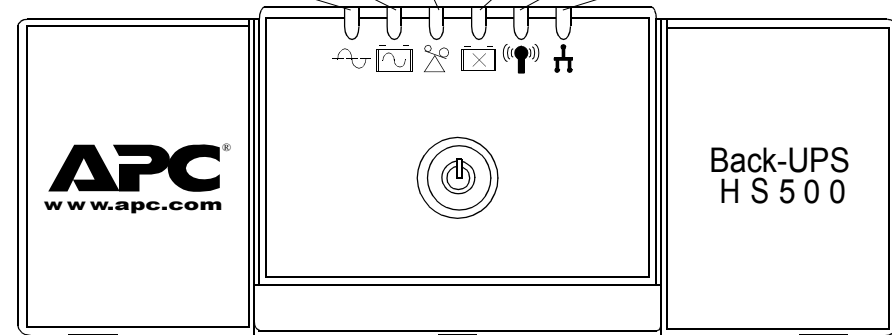

On Line (green) - is lit whenever AC utility power is powering the outlets.

Overload (red) - is lit whenever power demand has exceeded the capacity of the Back-UPS.

Continuous Tone - this alarm is sounded whenever the Back-UPS outlets are overloaded.

On Battery (yellow) - is lit whenever the battery of the Back-UPS is supplying power to the equipment connected to the outlets.

Four Beeps Every 30 Seconds - this alarm is sounded whenever the Back-UPS is running On Battery. Consider saving work-in-progress.

Continuous Beeping - this alarm is sounded whenever a low battery condition is reached. Battery run-time is very low. Promptly save any work-in-progress and exit all open applications. Shutdown the operating system, computer, and the Back-UPS.

Replace Battery (red) - is lit whenever the battery is near the end of its useful life, or if the battery is not connected (see above). A battery that is near the end of its useful life has insufficient run-time and should be replaced.

Chirps for 1 Minute Every 5 Hours - this alarm is sounded whenever the battery has failed the automatic diagnostic test.

TX/RX (green) - is lit whenever the Back-UPS is sending or receiving data over the network.

ACT/LNK (green) - is lit whenever the Back-UPS is connected to equipment and is ready and waiting to send or receive data.

Circuit Breaker - the rocker-type circuit breaker switch located on the bottom panel of the Back-UPS will trip if an overload condition forces the Back-UPS to disconnect itself from AC utility power. If the switch trips, disconnect non-essential equipment. Reset the circuit breaker by pushing it to the ON position.

TRANSFER VOLTAGE/SENSITIVITY ADJUSTMENT (Optional)

In situations where the Back-UPS or connected equipment appears too sensitive to input voltage, it may be necessary to adjust the transfer voltage. This is a simple task requiring use of the front panel pushbutton. It can also be accomplished using the **Configuration Page Screen** in the supplied software (see *Install and Setup Software*). To adjust the transfer voltage, proceed as follows:

1. Plug the unit into an AC utility power source; the Back-UPS will go into Standby Mode (no indicators lit).
2. Press the front panel pushbutton fully inward for 10 seconds. All indicators on the Back-UPS will flash to acknowledge going into Programming Mode.
3. The Back-UPS will then indicate its current Sensitivity Setting, as shown in the following table.

Indicators Flashing	Sensitivity Setting	Input Voltage Range (for utility operation)	Use When
1 (yellow)	Low	160 - 278 Vac	Input voltage is extremely low or high. Not recommended for computer loads.
2 (yellow, and red)	Medium (factory default)	180 - 266 Vac	Back-UPS frequently goes On Battery (recommended).
3 (yellow, red, and red)	High	196 - 256 Vac	Connected equipment is sensitive to voltage fluctuations.

4. To select the Low Sensitivity setting, press the pushbutton until the yellow indicator is flashing.
5. To select the Medium Sensitivity setting, press the pushbutton until the yellow and red indicators are flashing.
6. To select the High Sensitivity setting, press the pushbutton until yellow and both red indicators are flashing.
7. To exit without changing the Sensitivity Setting, press the pushbutton until the green indicator is flashing.
8. Once in Programming Mode, if the pushbutton is not pressed within 5 seconds, the Back-UPS will exit Programming Mode; all indicators will extinguish.

INSTALL AND SETUP SOFTWARE

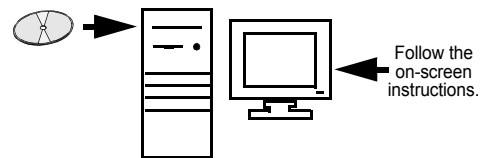

If Autoplay is enabled on your computer, the software on the CD-ROM will automatically start the installation program.

If Autoplay is not enabled on the computer, proceed as follows:

1. On the computer desktop of the display, double-click on **My Computer**, or start **Windows Explorer** to locate the computer's **CD-ROM drive icon**.
2. Double-click on the **CD-ROM drive icon** and then double-click on the **setup.exe icon**. The software will start and display the **InstallShield Wizard Screen** (Figure 1). The software will begin the installation process. To stop the installation, click **Cancel**.

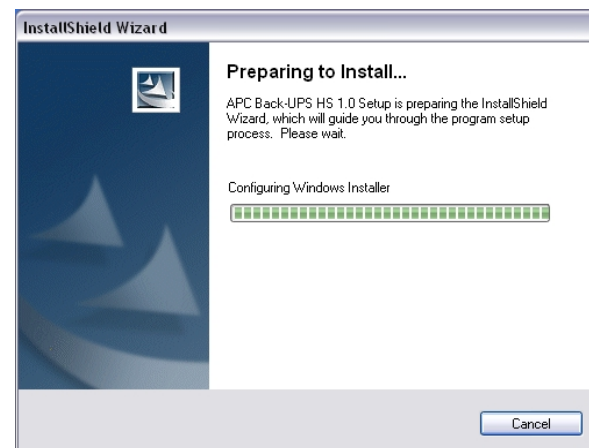

Figure 1. InstallShield Wizard Screen

3. After about 4 seconds, the software will display the **Welcome Screen** (Figure 2). To continue, click **Next**. To cancel the installation, click **Cancel**.

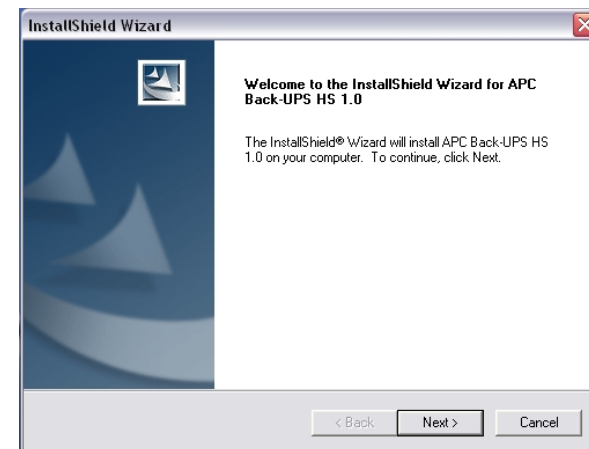

Figure 2. InstallShield Welcome Screen

4. The software will then display the **License Agreement** (Figure 3). Please read the Agreement and accept the terms by clicking **Yes**. To decline the Agreement, click **No** - the software will not install.



Figure 3. InstallShield License Agreement Screen

5. The software will display the **Choose Destination Location Screen** (Figure 4). Select **Browse** to find a location, click **Next** to accept the system default location, the system will then display the **Setup Status Screen** (Figure 5). Click on **Cancel** to stop the installation.

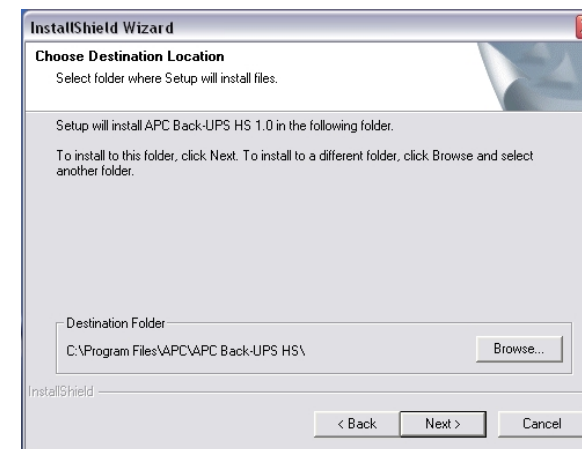

Figure 4. Choose Destination Location Screen

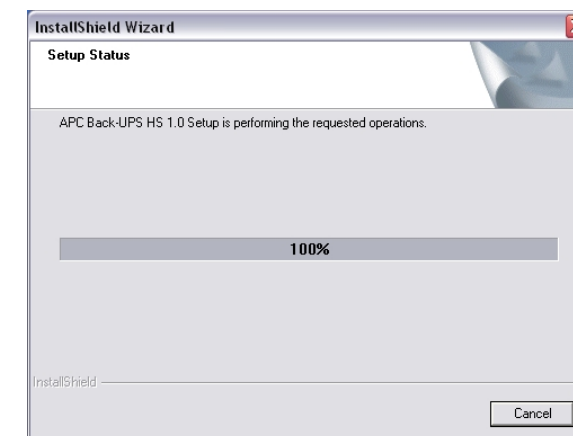

Figure 5. Setup Status Screen

6. The software then displays the **InstallShield Wizard Complete Screen** (Figure 6). Select **Finish** to quit the installation program..

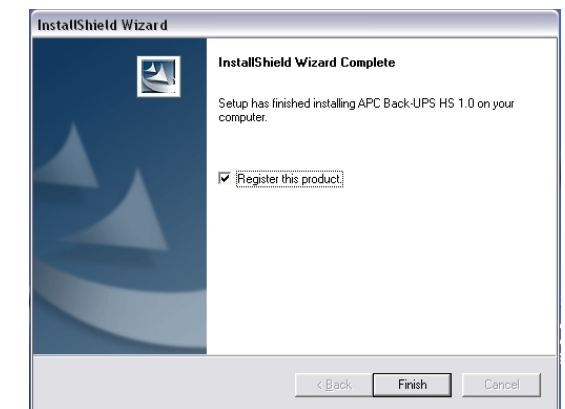

Figure 6. InstallShield Wizard Complete Screen

7. To launch the program, go to the **Start** menu, select **APC**, then select **APC Back-UPS HS** (Figure 7). **Continued on the next page -**

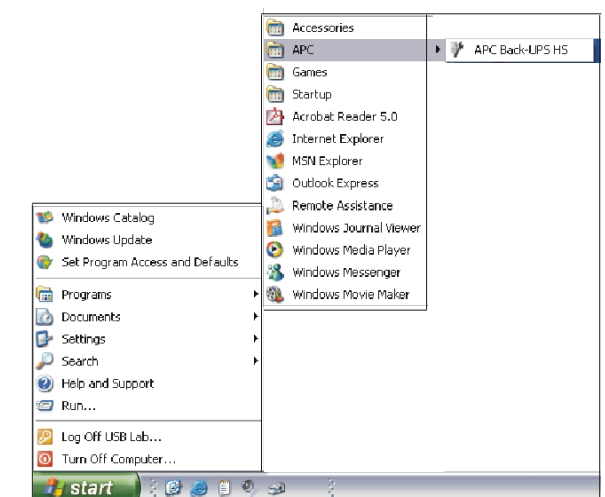

Figure 7. APC Software Startup Menu Selections

8. Following installation, the Back-UPS HS software is available in the **Start** menu. Upon launching the program, it searches for all Back-UPS HS devices on the network, and will identify them as shown in Figure 8 by IP Address and MAC Address. The IP Address is automatically assigned to the Back-UPS by the DHCP services from your hub or router. IP Addresses assigned by the DHCP service may automatically change over time. Thus, APC recommends you do not bookmark the IP Address, as you may not be able to access it through your browser. The MAC Address is assigned to the Back-UPS HS 500 at the factory.

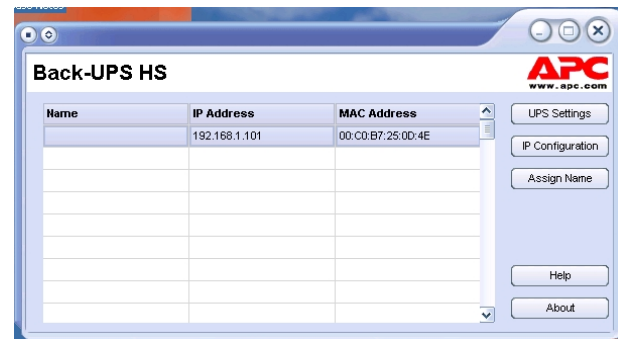

Figure 8. Back-UPS HS IP Address and MAC Address Screen

9. If there are no DHCP services on the network, or if you want to assign an IP Address you can easily remember, you can manually assign an IP Address to the Back-UPS by clicking on the **IP Configuration** button. The address you assign must follow the format shown in Figure 9 and cannot duplicate an address already assigned. Figure 10 shows the IP Configuration Screen with the IP Address fields set to zero (0).

To assign an IP Address to your computer, please read and follow the directions that came with your computer.

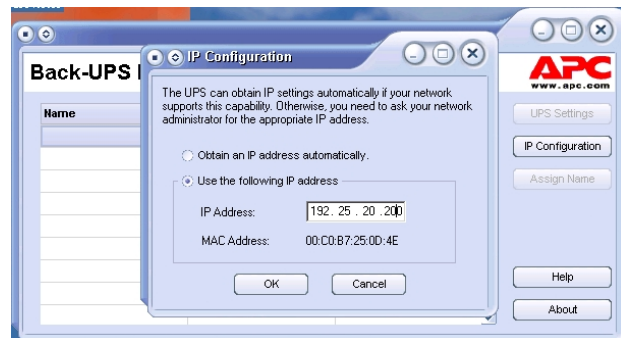

Figure 9. Assign IP Address Screen

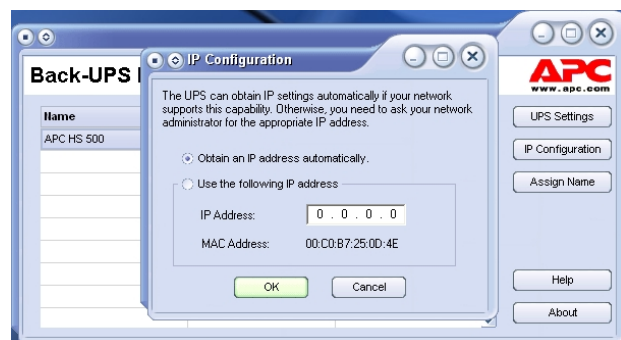

Figure 10. Blank Assign IP Address Screen

10. You can assign a name to the Back-UPS by clicking on the **Assign Name** button (Figure 8) and entering the name in the Assign Name Screen dialog. It will appear in the column to the left of the IP Address of the device (Figure 11). Names should not be duplicated.

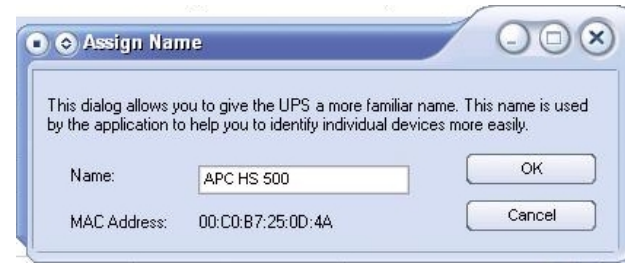

Figure 11. Assign Name Screen

11. To reset the Back-UPS HS to factory default values, use the **UPS Settings** button. If the Back-UPS HS does not reset using the software, remove the Battery Cover and insert a small object (about 2 inches in length) into the hole located next to the telephone jack (Figure 12) for approximately 5 seconds. **Note:** The telephone jack is provided for factory testing only - do not connect anything to this jack).

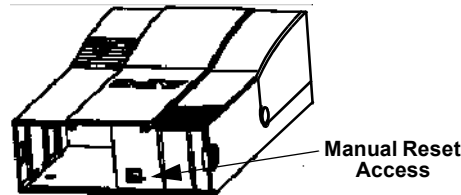

Figure 12. Manual Reset Access

12. Before performing any UPS maintenance task, check the Status of the UPS by clicking on the **Status** link. The screen shown in Figure 13 will be displayed.

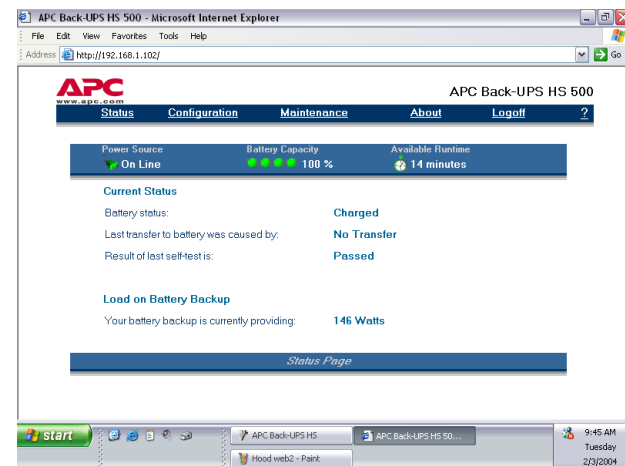

Figure 13. Back-UPS HS 500 Status Screen

13. To change the configuration of the Back-UPS or perform UPS maintenance, you must log on to the web page (Figure 11) by clicking on the **UPS Settings** button.

When this page is displayed, enter a default **Username** of **apc**, and a default **Password** of **apc**. To change the **Username** or **Password**, you must log on and then click **Maintenance** (Figure 14).

Note: You can also access the **Logon Page Screen** by entering the **IP Address** into the **Address line** of your browser.

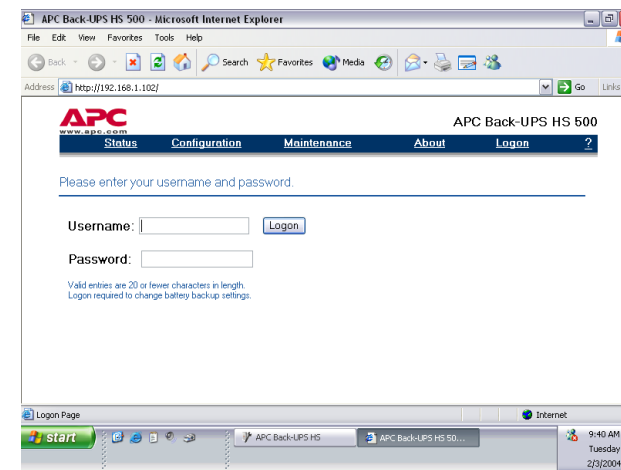

Figure 14. Log On Screen

14. Using the **Maintenance Screen** (Figure 15), you can perform a **Battery Self-Test**, **Update the Battery Replacement Date**, **Change the User Name or Password** (as previously discussed) then click **Update Now**, or you can **Restore Factory Defaults**. **Note:** You must be logged on to perform any of these tasks.

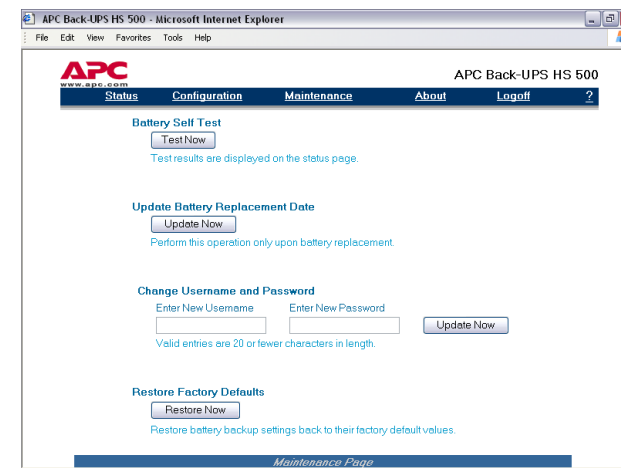

Figure 15. Maintenance Page Screen

15. Using the **Configuration Page Screen** (Figure 14), you can adjust the **Sensitivity** of the Back-UPS. By adjusting the Sensitivity, the Back-UPS will allow the unit to switch to battery power depending on the quality of the AC utility power being supplied to the unit. Use of the Sensitivity settings are for the following conditions:

Low - Use only for extreme conditions of low input voltage. Not recommended for computer loads.

Medium - Back-UPS frequently goes On Battery due to low input voltage (recommended).

High - Connected equipment is sensitive to low voltage.

The **Configuration Page Screen** also allows you to **enable** or **disable** the **Audible Alarm**. If enabled, this alarm operates as described in the *Status Indicators and Alarms* section of this manual. If disabled, the Back-UPS will quiet the alarm.

Additionally, the **Configuration Page Screen** allows you to adjust the voltage **Transfer Points**. The Back-UPS will transfer to **On Battery** operation at input voltages **Above** or **Below** the points selected in the drop-down **Volts** menu.

Finally, the **Configuration Page Screen** provides **Output Control** for the four outlets of the Back-UPS. Control consists of switching power **On** or **Off** at **Output 1**, **Output 2**, or the two outlets of **Output 3**. It also allows you to **Reboot** loads by automatically switching power **Off** and then **On** at the selected outlet. If an outlet is switched **Off**, it cannot be rebooted.

To use the **Configuration Page Screen**, you must be logged on to the Back-UPS. Select the desired function and click on the **Apply** button. To reset the unit to the factory defaults, click the **Reset** button.

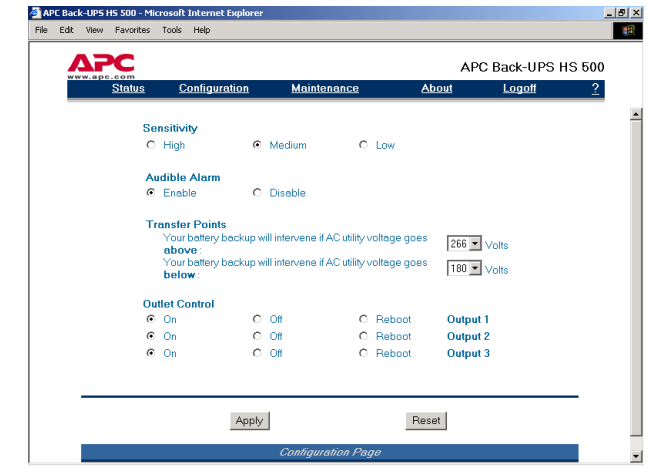

Figure 16. Configuration Page Screen

16. The **About Page Screen** provides general information about your Back-UPS including **Network Parameters** (IP and MAC Addresses), as well as **Technical Parameters** (Model, Serial Number, Firmware Revision, Web Firmware Revision, UPS Date of Manufacture, and Battery Replacement Date).

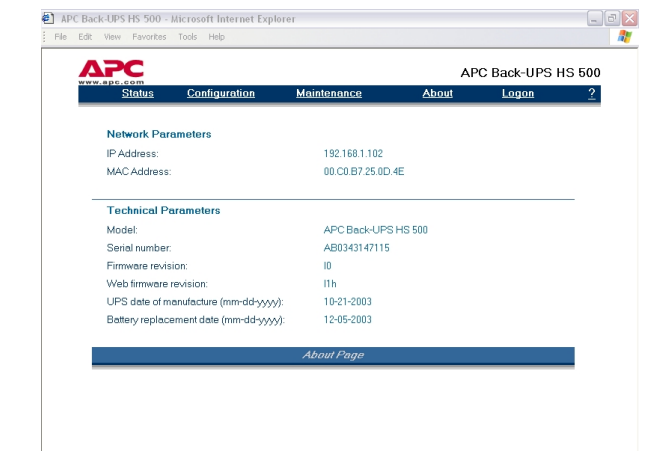

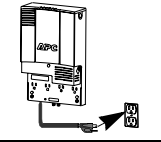
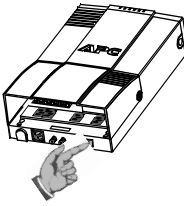

Figure 17 About Page Screen

Specifications

Input Voltage (on line)	180 - 266 Vac
Input Frequency	47 - 63 HZ (autosensing)
Output Wave Form (On battery)	Stepped Sine Wave
Maximum Load	500 VA 300 Watts
Operating temperature	32 - 104° F (0 to 40° C)
Storage temperature	5 - 113° F (-15 to 45° C)
Operating humidity	10 - 90% non-condensing
Storage humidity	10 - 95% non-condensing
Physical: (H x W x D)	14.65 x 8.85 x 4.13 in (37.2 x 22.5 x 10.5 cm)
Weight	16.3 lb (7.4 kg)
Typical Recharge Time	6 - 8 hours
EMI Classification	EN50091-2, Class B
Approvals	NEMKO-GS, CE, and GOST

Troubleshooting

Use the tables below to solve minor Back-UPS installation and operation problems. Consult APC On-line Technical Support or call APC Technical Support for assistance with problems that cannot be resolved using this document:

Possible Cause	Procedure	
Back-UPS will not switch on		
Back-UPS not connected to an AC power source.	Check that the Back-UPS power plug is securely connected to the wall outlet.	
Back-UPS circuit breaker "tripped".	Disconnect non-essential equipment from the Back-UPS. Reset the circuit breaker (located on the bottom of the Back-UPS) by pushing the rocker-type circuit breaker to the ON position. If the circuit breaker resets, switch the Back-UPS on and reconnect the equipment one-at-a-time. If the circuit breaker trips again, the last connected device is causing the overload.	
Very low or no AC utility power.	Check the wall outlet that supplies AC power to the Back-UPS using a table lamp. If the lamp bulb is very dim, have the AC utility power checked by a qualified electrician.	

Back-UPS does not supply power to network devices during an outage

Internal battery is not connected.	Check the battery connections. (See "Connect/Install Battery, Install Battery Cover" under "Installation" on the front page of this document.
------------------------------------	-----------------------------------------------------------------------------------------------------------------------------------------------

Back-UPS operates on battery although normal utility voltage exists

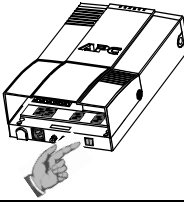
Back-UPS circuit breaker "tripped".	Disconnect non-essential equipment from the Back-UPS. Reset the circuit breaker (located on the bottom of the Back-UPS) by pushing the rocker-type circuit breaker to the ON position.	
The wall outlet that the Back-UPS is connected to does not supply AC utility power to the unit.	Connect the Back-UPS to another wall outlet or have a qualified electrician check the building wiring.	

Back-UPS does not provide expected backup time

Back-UPS is excessively loaded.	Unplug non-essential connected equipment, such as laser printers. Note: Devices that have motors or dimmer switches (laser printers, heaters, fans, lamps, and vacuum cleaners, for example) should not be connected to the Back-UPS outlets.
Back-UPS battery is weak due to recent outage and has not had time to recharge.	Charge the battery. The battery charges whenever the Back-UPS is connected to a wall outlet. Typically, eight hours of charging time are needed to fully charge the battery from total discharge. Back-UPS run-time is reduced until the battery is fully charged.
Battery requires replacement.	Replace battery (see Order Replacement Battery). Batteries typically last 3-6 years, shorter if subjected to frequent power outages or elevated temperatures.

Possible Cause	Procedure
A red indicator is illuminated	
Battery is not connected properly.	Check the battery connections. Consult "Connect/Install Battery, Install Battery Cover", which shows how to access the battery and connect the wires.
The Overload indicator is illuminated if equipment connected to the Back-UPS outlets is drawing more power than the Back-UPS can provide.	Disconnect one or more equipment power plugs until the indicator is no longer illuminated.
Battery requires replacement.	The battery should be replaced within two weeks (see "Order Replacement Battery"). Failure to replace the battery will result in reduced run-time during a power outage.

Replace Battery indicator illuminated / alarm sounds when the unit is turned on

Internal battery not connected.	Check the battery connections. Consult "Connect the Battery" under "Installation" on the front page of this document. It shows how to access the battery and connect the wires.
---------------------------------	---------------------------------------------------------------------------------------------------------------------------------------------------------------------------------

Red indicators are flashing

Back-UPS failure.	Call APC for service.
-------------------	-----------------------

ACT/Link Indicator is not illuminated

Unable to link to the Ethernet port.	Connect another network device to the LAN connector. Verify all network connections.
--------------------------------------	-----------------------------------------------------------------------------------------

TX/RX Indicators are flashing.

Back-UPS failure.	Contact APC technical support.
-------------------	--------------------------------

Unable to browse to Back-UPS HS

Cannot access the Web interface of the Back-UPS.	<p>Using the Back-UPS HS Software, check the assigned Internet Protocol (IP) address of the Back-UPS. If the assigned address is 0.0.0.0, shut down the Back-UPS HS Software and then restart the program. The equipment providing DHCP will reassign an IP Address to the Back-UPS.</p> <p>Verify you can "ping" the Back-UPS, as follows:</p> <p>Open an MS-DOS window and enter the Ping Command as, ping XXX.XXX.XXX.XXX (IP address of the device to be "pinged")</p> <p>If a message similar to the following appears, a communication link between your computer and the device has been established:</p> <p style="text-align: center;">Pinging XXX.XXX.X.X with 32 bytes of data Reply from XXX.XXX.X.X: bytes=32=2ms TTL=64</p> <p>If you get the following message, Pinging XXX.XXX.X.X with 32 bytes of data Request timed out.</p> <p>there may be something wrong in your network configuration. Check the following items in sequence:</p> <ol style="list-style-type: none"> 1. Ensure the ethernet cable is properly connected. 2. Ensure TCP/IP is properly configured on your computer. 3. Check that the ACT/LNK and TX/RX LEDs are illuminated. <p>Verify that you are using Internet Explorer 5.0 (or higher), or Netscape Navigator 7.0 (or higher).</p>
--------------------------------------------------	----------------------------------------------------------------------------------------------------------------------------------------------------------------------------------------------------------------------------------------------------------------------------------------------------------------------------------------------------------------------------------------------------------------------------------------------------------------------------------------------------------------------------------------------------------------------------------------------------------------------------------------------------------------------------------------------------------------------------------------------------------------------------------------------------------------------------------------------------------------------------------------------------------------------------------------------------------------------------------------------------------------------------------------------------------------------------------------------------------------------------------------------------------------------------------------------------------------------------------------------------------------------------------------------------------------------------------------------------------------------------------------------------------------------

Order Replacement Battery

Replace with an APC qualified battery. Replacement batteries can be ordered from APC Global Services. Have your Back-UPS HS model number available when ordering. Your model number can be found on the bottom of the unit.

Warranty

The standard warranty is two (2) years from the date of purchase. APC's standard procedure is to replace the original unit with a factory reconditioned unit. APC will ship the replacement unit once the defective unit has been received by the repair department, or cross-ship upon the receipt of a valid credit card number. The customer pays for shipping the unit to APC. APC pays ground freight transportation costs to ship the replacement unit to the customer.

Warranty Registration

To register this product for purposes of the warranty, please go to warranty.apc.com.

APC Contact Information

Technical Support	www.apc.com/support
Internet	www.apc.com
USA and Canada	800-800-4272