



# **CineTension 3 Series**

## **Tab-tensioned Electric Motorized Projection Screen**

### **User's Guide – E/H type (RC1)**

**V1.0**

---

#### **Important Safety & Warning Precautions**

**Make sure to read this user's guide and follow the procedures below.**

**Caution:** The screen's Black Top Drop is already set to its maximum drop distance. There is NO extra Black Top Drop in the roller. Please be aware of this as it will void your warranty with Elite Screens. Unapproved changes or modifications (except for cutting the power cord for hardwire installations) to this unit are prohibited and will void your warranty. For more information, please contact our Technical Support Department.

- Please retain this user's guide for future reference.
- To avoid damaging the unit, do not use with any unauthorized accessories not recommended by the supplier.
- Handle the unit carefully during transportation to avoid any damages.
- To ensure safe and reliable operation, direct connection to a properly grounded power source is advised.
- The power outlet supplying power to the unit should be close to the unit and easily accessible.
- Do not install the unit on uneven, inclined surfaces;
- Do not install in damp places to avoid an electric shock or short circuit.
- Do not place any heavy objects over the power cord.
- Position the power cord properly to avoid creating a trip obstacle.
- To avoid an electrical shock or fire, due to a loose contact or short circuit, do not overload the power cord.
- The internal & external parts of this unit are not end user serviceable. Do not attempt to disassemble this unit by yourself. No one except authorized technicians can open and make repairs to this unit.
- Make sure the power source that this unit is connected to has a continuous power flow.
- If there is need to use an extension cord, make sure the cord has an equal rating as the appliance to avoid over heat.
- Do not handle the power plug when your hands are wet or your feet are in contact with water.
- Properly dispose of this equipment according to the environmental regulations in your area when product is no longer of service.

**Do not use this unit under the following circumstances.**

- Disconnect the power cord under the conditions of heavy rain, wind thunder or lightning.
- Avoid direct sun light, rain shower and moisture.
- Keep away from fire sources and high temperature to prevent this device from overheating.
- Cut off the power supply first before transportation or maintenance.
- To avoid possible injury and/or an electric shock, do not attempt to use this screen if there is obvious damage or if there are any evident broken parts.

#### **Installation Warning**

The instructions provided in this user's guide are for reference only. Please consult a professional installation company for further installation and safety advice. The installer must ensure that proper mounting hardware is used to provide adequate strength suitable for the installation. Elite Screens is not liable for any faulty installations.

The Screen's **Top Black Drop** is already set to its maximum drop distance. There is **NO** extra top black drop in the roller. Please be aware of this as it will void the limitation of your warranty.

Individual modifications to this product are prohibited and will void the warranty with the supplier. Please contact Elite Screens Customer Service for any questions.

**NOTE:** This equipment has been tested and found to comply with the limits for a Class B digital device, pursuant to Part 15 of the FCC Rules.

These limits are designed to provide reasonable protection against harmful interference in a residential installation. This equipment generates and can radiate radio frequency energy and, if not installed and used in accordance with the instructions, may cause harmful interference to radio communications.

However, there is no guarantee that the interference will not occur on a particular installation. If this equipment causes harmful interference to radio or television reception, which can be determined by turning the equipment off and on, the user is encouraged to try to correct the interference by one or more of the following measures.





- ✓ **Reorient or relocate the receiving antenna of the device which may be causing the interference.**
- ✓ **Increase the separation between the screen and the device's receiver.**
- ✓ **Connect the equipment into a different power outlet other than the device.**

### **Pre-Installation**

1. Carefully unpack the screen.
2. Always handle the screen in a leveled position on a clean surface.
3. In order to protect the screen from exposure to stains, keep the screen out of contact with foreign particles such as dust, sawdust, and/or liquids.

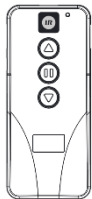
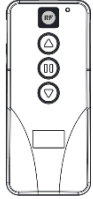
### **NOTE**

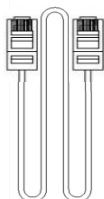
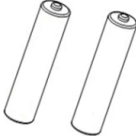
Regardless of the mounting method, the screen should be securely supported so that the vibration or pulling on the viewing surface will not cause the casing to become loose or fall. The installer must ensure the fasteners that are used are of adequate strength and suitable for the installation location.

| <b>CineTension 3   Controls and Accessories</b>                                     |   |   |   |   |   |
|---|---|---|---|---|---|
| <b>A. IR Remote<br/>ZRC1-IR</b>   | <b>B. RF Remote<br/>ZRC1-RF</b>   | <b>C. Wall box<br/>controller<br/>ZRC1-WB</b>                                       | <b>D. RJ50 Cable<br/>ZRC1-RJ50</b>  | <b>E. AAA<br/>batteries</b>   | <b>F. Bubble Level</b>  |
|  |  |  |  |  |  |

### **Screen operation**

**Electric Current:** 100 ~ 110v voltage

1. After ensuring the power outlet & screen are compatible (voltage), plug the power cord into the power outlet.
2. Once the screen has power, you'll be able to control it using any of the 5 methods described below.

**1. IR Remote control (Item A, Fig 1):** The Infrared functions by direct line of sight contact using an effective beam range of 25 feet within a 30-degree angle. Aim the IR remote directly at either the IR receiver on the Wall Box Controller or on the screen to operate the screen.

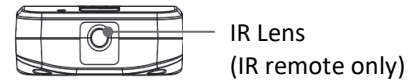

**Note:** Assure there is no obstruction between the IR remote and IR receiver.

**2. RF Remote Control (Item B):** The radio waves eliminate the need for a direct line of sight and has a longer distance control range.

The RF remote is already pre-synced/paired and ready to use. If synchronization/ pairing is needed, please follow the steps below.

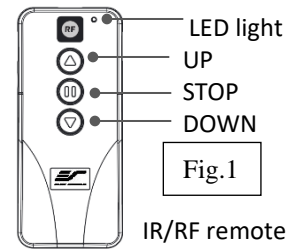

**How to synchronize/pair a new RF remote:**

- Press & hold the “**Programming Key**”, then press the “**Up Key**” on the **Wall box controller** (wall-box LED flashes). *Reference the wall box controller section for programming key location.*
- Then press the “**Up Key**” on the **RF remote**.
- The **Wall box LED** will flash 5 times, to indicate the RF remote has been properly synchronized/paired.

**How to change the RF code** (For use when multiple screens/RF remotes are owned)

Changing the RF code avoids controlling multiple screens at the same time and prevents electrical interference leading to accidental control of the screen.

1. Remove the batteries
2. Change the RF code switch
3. Insert the batteries
4. Synchronize it with the wall box controller

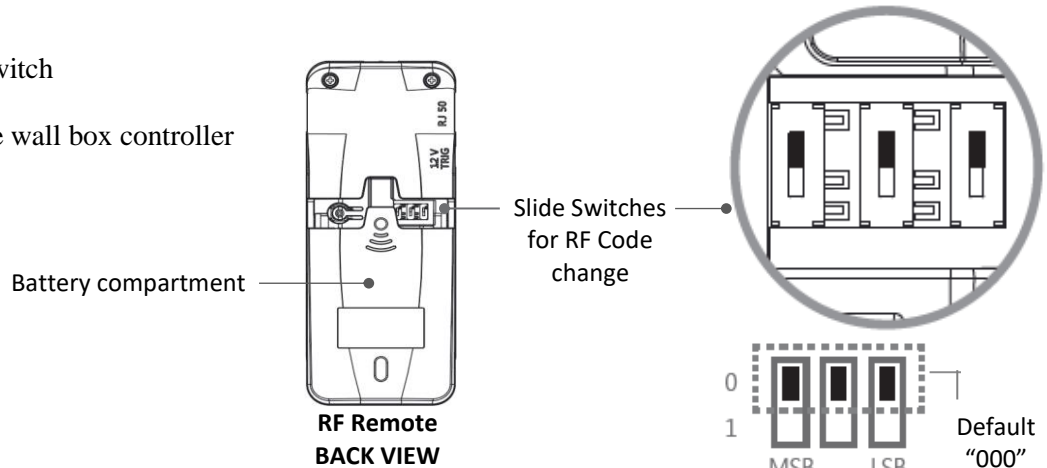

**3. Wall box controller (Item C, Fig 2):** The wall box controller switch is a wall mounted control box with an up/stop/down button. It plugs directly into the screen’s RJ50 port.

**RJ50 PORT:**  
Connects to the Screen RJ50 PORT  
(RJ50 CABLE ONLY)

3.5mm mono Projector  
Trigger Port (if Projector  
equipped)

Wall box controller  
SIDE VIEW

Programming  
Key

Wall box controller  
BACK VIEW

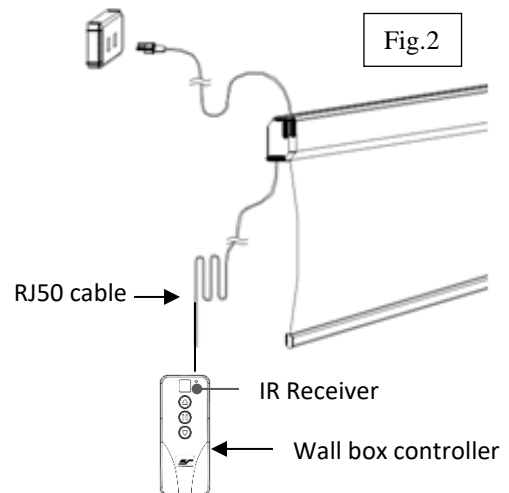

**4. Wired 5-12 volt trigger (Fig 3):** Requires a 3.5mm to 3.5mm mono cable (not included)

**Step 1:** Connect one end of the RJ50 cable to the screen and the other end to the Wall box controller.

**Step 2:** Then connect one end the 3.5mm mono cable to the wall box controller and the other to the projector.

Once the two cables have been connected, the wired trigger feature is ready to synchronize the screen's up/down operation with the projector's power cycle.

- Projector on, screen drops
- Projector off, screen raises

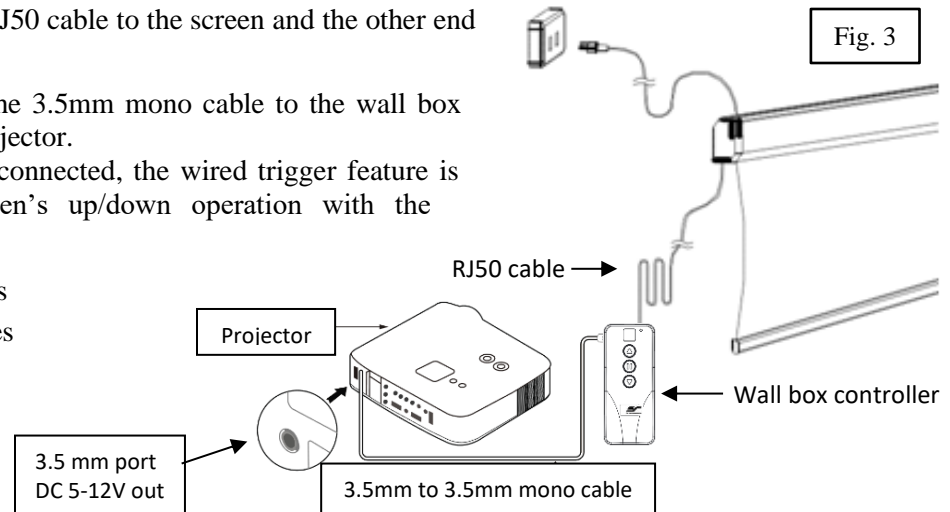

**5. Wireless 5-12 volt trigger (Fig 4):** Requires a 3.5mm to 3.5mm mono cable (not included).

The Radio Frequency (RF) remote control serves as a dual purpose, independently as a handheld remote control, or as a Wireless 5-12 volt trigger. The radio frequency technology sends a wireless signal that synchronizes the screen's drop & rise with the projector's power cycle.

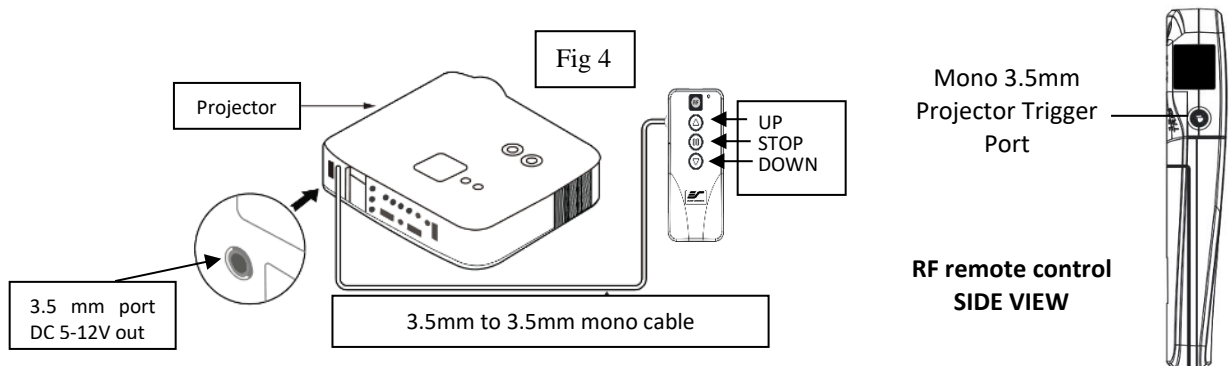

**Here's how to set up your Wireless 5-12 volt trigger**

The 5-12V wireless trigger should already be synced and ready to work.

**Step 1:** Connect one end of the 3.5 mm mono trigger cable to the RF remote.

**Step 2:** Connect the other 3.5 mm mono end of the cable to your projector.

**Step 3:** Turn on the projector and the screen should automatically deploy.

**Step 4:** Turn off your projector and the screen should automatically retract.

*(Please be aware, the projector on/off cycle may take longer to fully activate. It usually takes around 20- 30 seconds for full off and on cycle each time)*

**Note:** If the wireless trigger feature does not work, please resync the RF remote to the Wall box controller per the instructions in the Radio Frequency remote section.

## **ADVANCED Programming Key Instructions: (FOR ADVANCED USERS ONLY)**

\* Wall box controller must be connected to the screen.

**ATTENTION:** Reducing the factory's full screen drop may produce waves/wrinkles on the projection surface on tab-tension screens. The full drop is recommended to allow the screen to rely on the tab-tension system to maintain the projection surface flat and taut on all sides.

The same applies on non-tensioned screens, although some level of waves may be present due to the nature of the screen not being tensioned. If wrinkles/waves develop after making the adjustment to the desired drop position, reset it to the factory's default position per the instructions below.

**FLATNESS AFFECTED BY NEW PROGRAMMED VERTICAL POSITION IS NOT COVERED UNDER A REPLACEMENT WARRANTY.**

### **1. Preset the Screen's Drop Position:**

Use the RF/IR remote or Wall Box Controller to Drop the screen to the desired position you want to set it at. Press & hold the "**Programming Key**", then press the "**Down key**" on the Wall Box Controller. The LED will flash 5 times to confirm new programmed drop position.

#### **PROGRAMMING NOTE:**



The programmed vertical position relies on a time-count which adjusts itself according to the programmed timed difference. Multiple up/down programming will result in the vertical position being off a few inches. It is recommended that programming is done the **first-time** the desired vertical position is determined or RESET it to factory default and programming the desired vertical position afterwards.

### **2. Clear/Reset the Screen's Drop Position to factory default:**

Press & hold the "**Programming Key** + "**Stop key**" on the wall box controller.

## **Hardware Parts List for CineTension 3 Series**

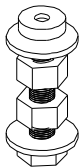
*Please make sure all parts listed below are included before proceeding with the installation.*

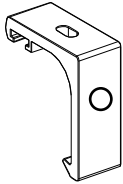
|  |   |  |   |
|--|---|--|---|
| A. M12 Dry-wall anchor x 4 or 6<br> | B. Bolt x 2 or 3<br> | C. Masonry Screw x 4 or 6<br> | D. Extruded Hanging Bracket x 2 or 3 120" & above x 3 brackets<br> |
|--|---|--|---|

## **Installation Instruction**

Wall Screws included with this product are complimentary and may not be adequate for all mounting surfaces. Consult with a professional installer or hardware store for proper mounting screws and anchors.

**Elite Screens is not liable for any faulty installations.**

1. Insert each **Bolt (B)** through the right & left slide channel located on the top of the screen's case.

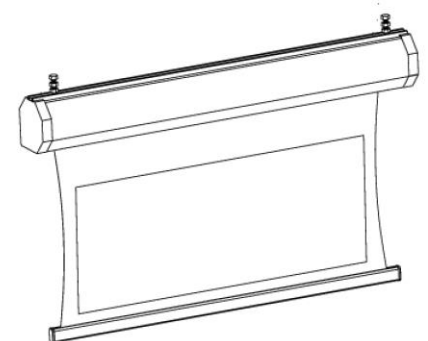
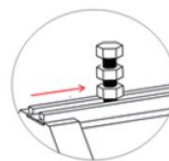

- Slide the **Extruded Hanging Bracket (D)** through the rail located below the slide channel until it meets with the top of the **Bolt (B)** and slightly secure the lug-nuts located on the top & bottom of the bolt to attach the bracket.

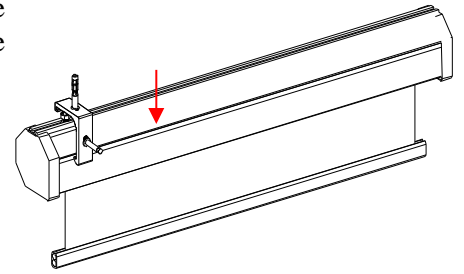

- Mark the installation location to drill your hole. Insert the proper screw and secure the bolts to the bracket.

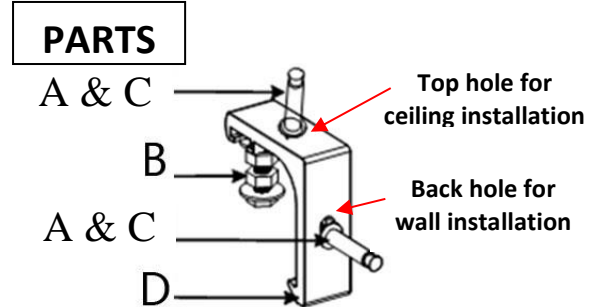

- Example of the CineTension 3 installed to a wall, ceiling and enclosed.

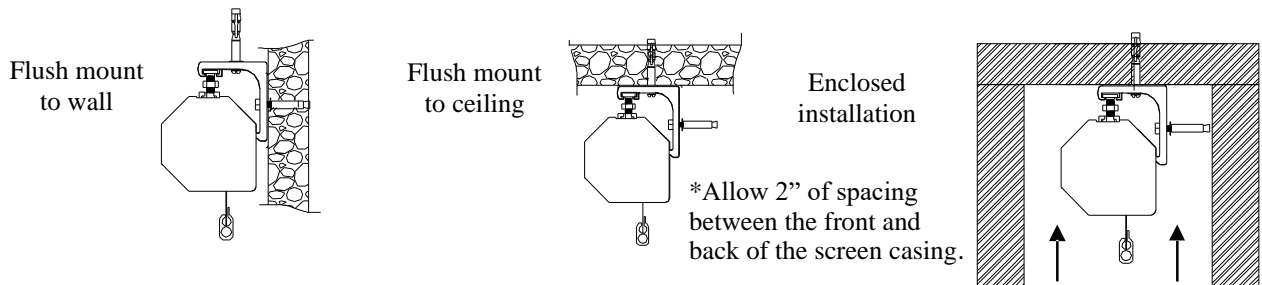

### Adjusting the Tension String

There are adjustment knobs located at the end of the weight bar of the screen. If for any reason the tension string(s) is loose, you can re-tension it by adjusting the tension string(s) knobs. The tension should be equally balanced in order to provide a flat, uniform projection surface.

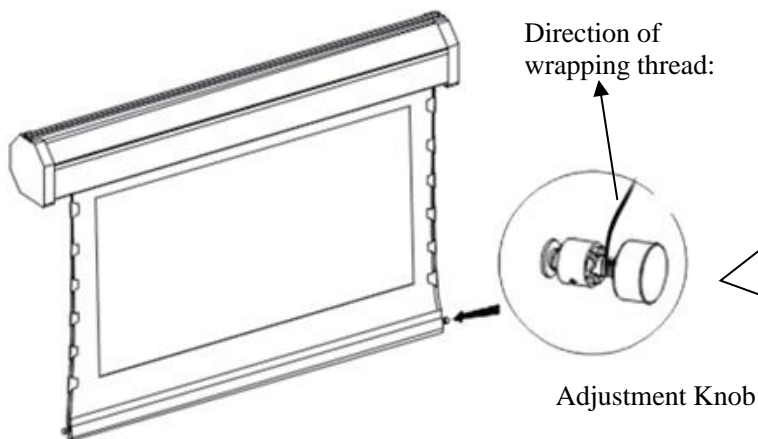

**Adjustment method:** Pull out the adjusting knob and rotate it to tighten or loosen tension string. The direction to tighten/loosen the string will depend on the direction of the wrapping thread.

**Attention:** The string and screen will lose all tension if the string is loosened to its maximum. To reverse this, simply turn the knob in the opposite direction.

**Attention:** The screen's tension has been preset to achieve its best performance. The adjustments are typically not required. Please contact Elite Screens for assistance to avoid damaging the screen and voiding your warranty.

For local Elite Screens contact or Technical Support, please visit  
[www.elitescreens.com](http://www.elitescreens.com)