

Mini Network Camera Quick Setup Guide

R2-2MPINCAM

NO:101-300-0798-01
Issue:1.0

Precautions

Fully understand this document before using this device, and strictly observe rules in this document when using this device. If you install this device in public places, provide the tip "You have entered the area of electronic surveillance" in an eye-catching place. Failure to correctly use electrical products may cause fire and severe injuries.

WARNING	It alerts you to moderate dangers which, if not avoided, may cause minor or moderate injuries.
CAUTION	It alerts you to risks. Neglect of these risks may cause device damage, data loss, device performance deterioration, or unpredictable results.
NOTE	It provides additional information.

WARNING

- Strictly observe installation requirements when installing the device. The manufacturer shall not be held responsible for device damage caused by users' non-conformance to these requirements.
- Strictly conform to local electrical safety standards and use power adapters that are marked with the LPS standard when installing and using this device. Otherwise, this device may be damaged.
- Use accessories delivered with this device. The voltage must meet input voltage requirements for this device.
- If this device is installed in places with unsteady voltage, ground this device to discharge high energy such as electrical surges in order to prevent the power supply from burning out.
- When this device is in use, ensure that no water or any liquid flows into the device. If water or liquid unexpectedly flows into the device, immediately power off the device and disconnect all cables (such as power cables and network cables) from this device.
- Do not focus strong light (such as lighted bulbs or sunlight) on

this device. Otherwise, the service life of the image sensor may be shortened.

- If this device is installed in places where thunder and lightning frequently occur, ground the device nearby to discharge high energy such as thunder strikes in order to prevent device damage.

CAUTION

- Avoid heavy loads, intensive shakes, and soaking to prevent damages during transportation and storage. The warranty does not cover any device damage that is caused during secondary packaging and transportation after the original packaging is taken apart.
- Protect this device from fall-down and intensive strikes, keep the device away from magnetic field interference, and do not install the device in places with shaking surfaces or under shocks.
- Clean the device with a soft dry cloth. For stubborn dirt, dip the cloth into slight neutral cleanser, gently wipe the dirt with the cloth, and then dry the device.
- Do not jam the ventilation opening. Follow the installation instructions provided in this document when installing the device.
- Keep the device away from heat sources such as radiators, electric heaters, or other heat equipment.
- Keep the device away from moist, dusty, extremely hot or cold places, or places with strong electric radiation.
- If the device is installed outdoors, take insect- and moisture-proof measures to avoid circuit board corrosion that can affect monitoring.
- Remove the power plug if the device is idle for a long time.
- Before unpacking, check whether the fragile sticker is damaged. If the fragile sticker is damaged, contact customer services or sales personnel. The manufacturer shall not be held responsible for any artificial damage of the fragile sticker.

Special Announcement

- All complete products sold by the manufacturer are delivered along with nameplates, quick setup guide and accessories after strict inspection. The manufacturer shall not be held responsible for counterfeit products.
- The manufacturer will update this manual according to product function enhancement or changes and regularly update the software and hardware described in this manual. Update information will be added to new versions of this manual without prior notice.
- This manual may contain misprints, technology information that is not accurate enough, or product function and operation description that is slightly inconsistent with the actual product, the final interpretation of company is as a standard.
- This manual is only for reference and does not ensure that the information is totally consistent with the actual product. For consistency, see the actual product.

NOTE

For more information, please refer to website.

1 Open Package Examination

Open the package, check the appearance of product for no obvious damage, and confirm the item list for table 1-1 is consistent.

Table 1-1 Packing list

Component	Quantity	Remark
Mini Network Camera	1	
Quick Setup Guide	1	
Multi-head cable	1	

2 Device Structure

2.1 Device Ports

NOTE

Different devices may have different ports and multi-head cables; Please refer to the actual product.

Figure 2-1 Multi-head cable

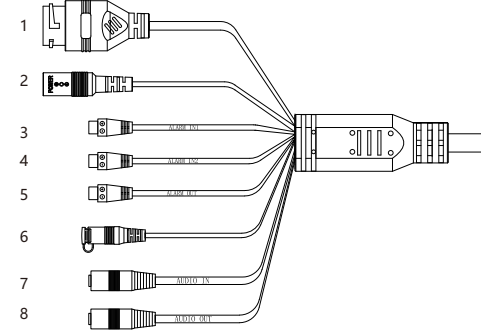
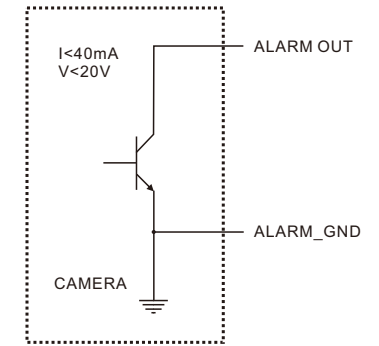

Table 2-1 Multi-head cable description

ID	Core	Description	Remark
1	Network access port	Connects to a standard Ethernet cable.	
2	Power supply (DC 12V)	Connects to a 12V direct current (DC) power supply .	
3	Alarm in1	Alarm input 1	Applied for alarm function
4	Alarm in2	Alarm input 2	
5	Alarm out	Alarm output	
6	Reset button	Long press the reset button for 5s to restore the original settings.	
7	Audio input port	Receives an analog audio signal from devices such as a sound pickup device.	Applied for audio function
8	Audio output port	Connects to an external audio device such as a speaker.	

2.2 Alarm output (open-drain output)

Figure 2-2 Alarm output schematic diagram



Alarm: ALARM_OUT = 0
No alarm: ALARM_OUT = Hi-impedance

2.3 Camera Dimensions (Unit:mm)

NOTE

Different devices may have different dimensions; Please refer to the actual product.

Figure 2-3 Dimensions (Pinhole lens)

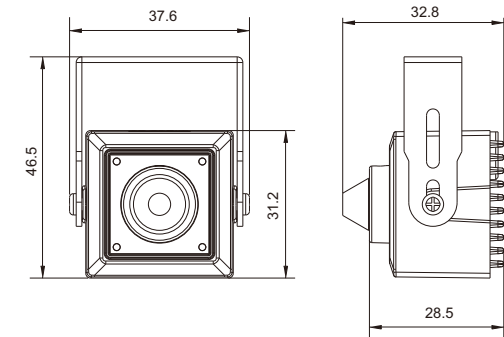

3 Device Installation

Installation Steps:

Step 1 Open the package, take out the camera and unscrew the screws on both sides of the bracket, remove the bracket as shown in figure 3-1.

Figure 3-1 Removing bracket

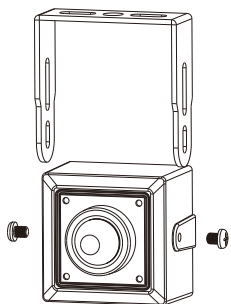

Step 2 Use screws to fix the bracket in the installation position.

Figure 3-2 Installing bracket

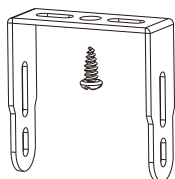

Step 3 Connect the multi-head cable and insert SD card.
Step 4 Install the camera to the bracket, adjust the position so that the camera faces the monitored area, then tighten the screws on both sides of the bracket.

Figure 3-3 Installing camera

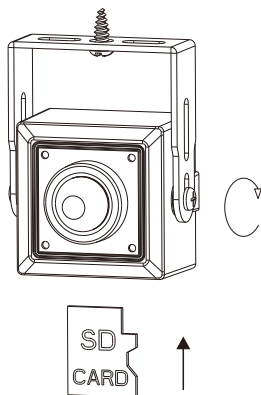

4 Quick Configuration(e.g IE)

4.1 Login

Open the Internet Explorer, enter the IP address of IP camera (default value: DHCP on) in the address box, and press Enter. The activation page is displayed, as shown in figure 4-1.



NOTE

- Create password when you log in camera for the first time to ensure system security

Figure 4-1 Activation

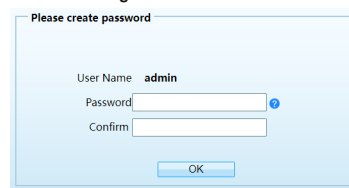

- It is advised to restart the device three minutes later after modifying the password to ensure it was modified successfully
- You can change the system display language on the login page.

Click Login, the main page is displayed.

Figure 4-2 Login

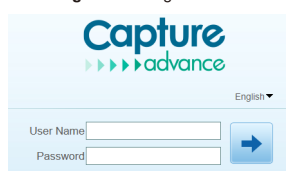

4.2 Modify IP address

Choose **Configuration > Device > Local Network**, the **Local Network** page is displayed.

Enter the IP address in the IP Address box and click **Apply** as shown in figure 4-2.

After the IP address is set successfully, please use the new IP address to log in the Web interface.

Figure 4-2 Local Network



4.3 Browsing Video

To ensure the real-time video can be played properly, you must perform the following operation when you log in the web for the first time:

If you can view the live video directly, please ignore the steps of adding trusted sites.

Step 1 the Internet Explorer. Choose **Tools > Internet options > Security > Trusted sites > Sites**, in the display dialog box, click **Add**, as shown in figure 4-3.

Step 2 In the Internet Explorer, choose **Tool > Internet Options > Security > Customer level**, and set **Download unsigned ActiveX control** and **initialize and script ActiveX controls not marked as safe for scripting under ActiveX controls and plug-ins** to **Enable**, as shown in figure 4-4.

Figure 4-3 Adding a trusted site

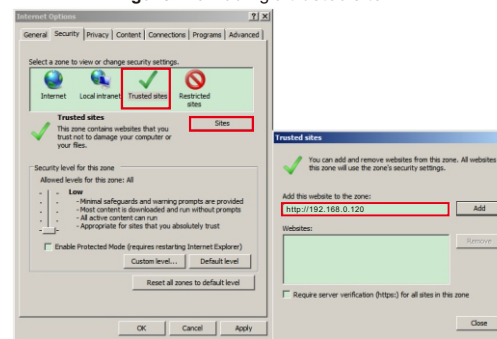
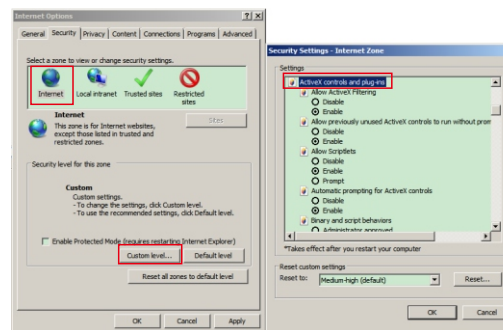

Figure 4-4 Configuring ActiveX control and plug-ins



Step 3 Download and install the player control as prompted.



NOTE

If the repair tips displayed when installing the control, please ignore the prompt, and continue the installation, the login page is displayed when the control is loaded.

To browse a real-time video, click Live Video. The Live Video page is displayed, as shown in figure 4-5.

Figure 4-5 Live Video

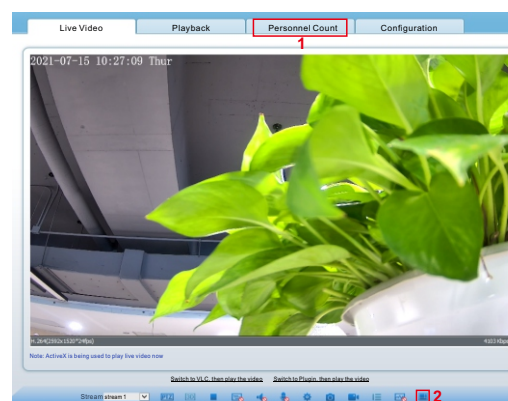

1 Personnel Count: User can query the data of personnel count, through year, month, day. The statistics can be downloaded. The data can be shown by line chart, histogram, list.

2 AI Live Video: Click the icon to view the snapshots of human face or license plate (click "Face" or "Plate" to switch). The bottom page will show the captured images of vehicle and human face.

Figure 4-6 Installation of personnel count

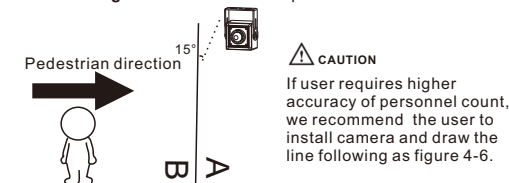

4.4 Two-way audio



NOTE

Partial cameras do not support two-way audio, this section does not apply.

4.4.1 Camera ↔ PC

Connection:

- Step 1 Connect microphone to audio input interface of camera.
- Step 2 Connect speaker to the PC audio output interface.
- Step 3 Log in camera Web, click to turn on two-way audio.

4.4.2 PC ↔ Camera

- Step 1 Connect microphone to PC audio input interface.
- Step 2 Connect speaker to camera audio out interface.
- Step 3 Log in camera Web, click to turn on two-way audio.

4.5 Intelligent Analysis

At "Configuration > Intelligent Analysis" interface, user can set the parameters of Perimeter, Single Virtual Fence, Double Virtual Fence, Multi Loiter, Converse and Personnel Count, as shown in figure 4-7.

Figure 4-7 Intelligent Analysis

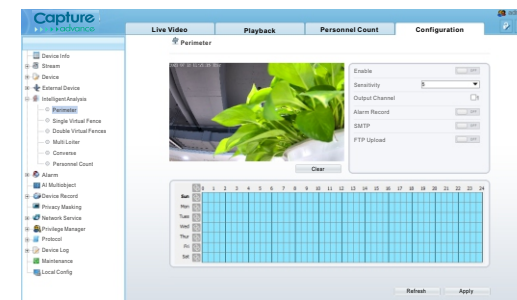

4.6 AI Multi object

At "Configuration > AI Multi object" interface, user can enable face detection, full body detection, vehicle detection, set the other parameters of detection, as shown in figure 4-8.

Figure 4-8 AI Multi object

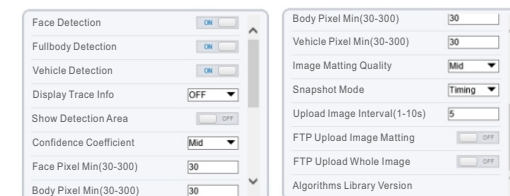

NOTE

For better capture performance, it is recommended to use 6mm focus length lens or above.