



# VDP-100

## Video-Eye People Counter™

*Instruction Manual and User's Guide*



Potter Electric Signal Company  
2081 Craig Road, St. Louis, Mo 63146  
Phone (800) 325-3936, Fax (314) 878-7264  
<http://www.pottersignal.com>

Potter Electric Signal Company  
2081 Craig Road, St. Louis, Mo 63146  
Phone (800) 325-3936, Fax (314) 878-7264  
<http://www.pottersignal.com>

1	Description
2	Features
3	Complete Kit Parts List
4	Precautions
5	Installation Procedures
6	Front Panel Controls and Names
7	The Counter Display Settings
8	The Video Sensor Settings
9	Troubleshooting
10	Specifications

## 10. Specifications

### System Specifications

Model Name	VDP-100 Video-Eye People Counter™	
Operating Voltage	Video Sensor Unit	12V DC
	Counter Display	12V AC / 15VA
Power Consumption	Stand by	400mA
	In Alarm	600mA
Size (h x w x d)	Video Sensor Unit	5.1" x 3.1" x 1.8" (130 x 80 x 47 mm)
	Counter Display	4" x 3.3" x 1.2" (102 x 85 x 31 mm)
Traffic Detection Method	by a Motion Detection Video Camera	
Image Sensor	1/4 inch Color CMOS Sensor	
Lens Angle	90 degree	
Sensor Image Resolution	Horizontal 300 lines	
Video Format	NTSC	
Processor	BF531 Digital Signal Processor	
Counter	6 digits (999,999) of independent Entry / Exit Dual Counter	
Chime Sound	Two distinctive chime sounds announcing entry / exit event	
Chime Type	Volume Adjustable Electronic Chime(0~85db)	
Operating Temperature	14℉	
Required Illumination	Recommend 7 LUX~3,000 LUX (Indoor Use)	
Installation Heights	Recommend to install between 7~14 feet high from the floor	
Detection Area	10 feet wide when installed at 8 feet high 17 feet wide when installed at 14 feet high	

### Wires Specifications

Connector Cable	Two 26 ft. AWG # 22 wires for 12V DC Output Two 26 ft. AWG # 24 wires for Signal Output
-----------------	--

\* Wires of AWG # 20 or more are required for connecting the Counter Display and the Video Sensor Unit at over 300 ft.

Power Cord	Two 6 ft. AWG # 22 wires for 12V AC Output
------------	--

### Power Transformer Specifications

Power Transformer	Input 120V AC, 60Hz Output 12V AC
-------------------	--------------------------------------

Thank you for purchasing AMSECO VDP-100 Video-Eye People Counter™. Please read this manual thoroughly before making connections and operating the unit. Following the instructions in this manual will enable you to obtain optimum performance from the system.

Please retain this manual for future reference.

**9. Troubleshooting**

**Condition: Cannot get the system power on.**

Check the power cable connections both of power transformer and the Counter Display terminal.  
Check whether the in-line switch is ON.  
Make sure your power source is 120V AC 60Hz.

**Condition: Counter is ON but the status LED of the Video Sensor Unit is off.**

Check the wiring connection of the counter unit terminal and 4P connector.  
In case you have extended the length of wires, check whether you have used wires of required gage (AWG # 24 by 100 ft. / AWG #22 or above for over 100 ft)

**Condition: Status LED is ON and blinking on traffic events, but the Counter doesn't count at all.**

Check the signal cable connections.

**Condition: Counter is not accurate.**

Ensure you have installed the system in the environment as required in this instruction manual such as illumination condition, installation heights or the floor condition. **Move the installation position or reduce the illumination of the room if the shadows of people generate false counting.**

Check whether the Video Sensor unit is facing in parallel with the floor.

**Condition: Can't get the Chime Sounds.**

Check the volume control.  
Check the Speaker connector in the Video Sensor Unit.

**Condition: I get the ENTRY chime sounds and counts when EXIT events occur, while getting EXIT chime sounds and counts on ENTRY events.**

Check whether you have installed the Video Sensor Unit in the correct direction. Rounded end of the Unit must face the door (heading EXIT direction) for proper operations.

**1. Descriptions**

AMSECO VDP-100 Video-Eye People Counter™ is the digital image tracking technology based people traffic counter and door announcer system integrating a Video Camera as a detecting sensor. The system distinguishes and counts entry / exit traffic events simultaneously by its unique Object's Motion Detection Algorithm, and provides the users very useful information on accumulated entry /exit traffic counts in offices, retail shops, department stores, or any other facility as well as announcing people's entry or exit events with pleasant chime sounds.

You can also use the VDP-100 as a monitoring camera by simply connecting its video output to any NTSC monitor.

**2. Features**

- **Entry / Exit Distinguishable People Counter** discriminating the object's moving direction and counting entry /exit events separately
- **Six Digit Resettable Counter** capable of displaying up to 999,999 counts of the entry or exit events
- **Two Distinctive Chime Sounds** to announce Entry and Exit Event separately
- **Adjustable Chime Volume**
- **Easier Installations** not requiring additional reflector installations or adjustments
- **Ceiling Mount**
- **CMOS Color Video Camera integrated**
- **Digital Signal Processor (DSP) driven system**
- **NTSC Video Output** ready to be used as the monitoring camera
- **Counter Memory Back-up** from accidental Power failure
- **Tamper Protection** from blocking camera's view

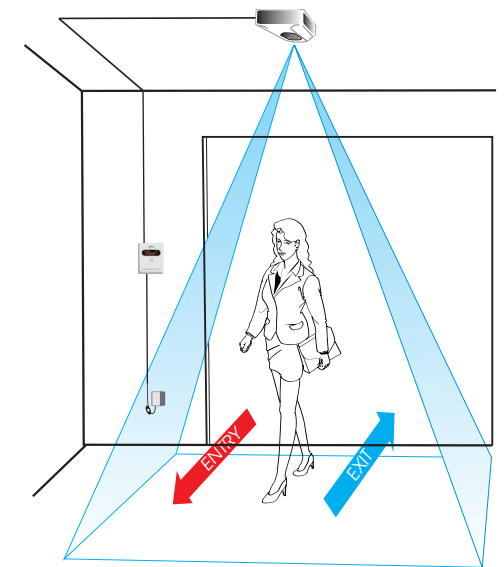

**3. Complete Kit Parts List**

Upon opening of the package please ensure the following parts are enclosed properly before installation.

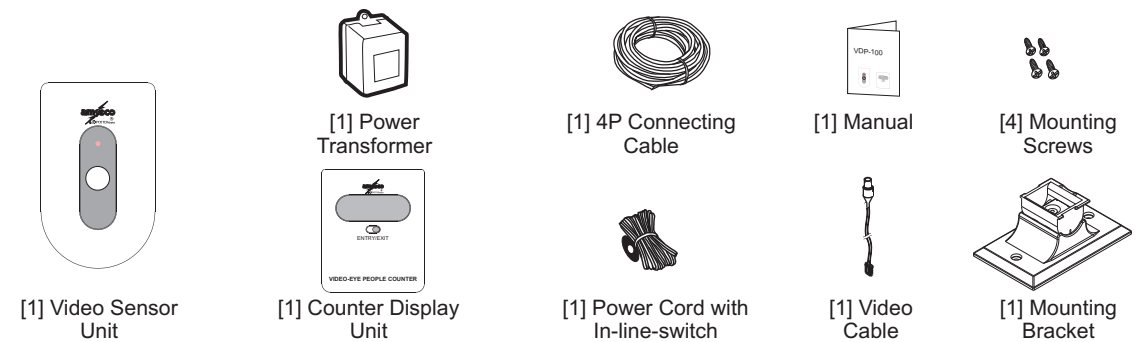

**4. Precautions**

It is important that you carefully read these installation instructions before starting the installation. While the installation procedures are very simple, there are guidelines to follow to ensure that the system will operate properly. The guidelines are as follows:

- 1) The Video Sensor Unit and the Counter Display Unit should be mounted onto a flat, firm surface.
- 2) USE only AMSECO 12V AC transformer provided together and wires as specified in this Instructions.
- 3) For the maximum accuracy of the counter it is strongly recommended that you install the system in the environment satisfying the following conditions:

**Recommended Installation Conditions**

Install the Video Sensor Unit in the illumination intensity between 7 Lux to 3,000 Lux.



The Video Sensor Unit is recommended to be installed maximum 14 feet high above the floor.

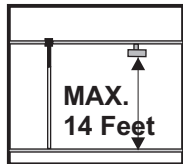

Recommend to install the Video Sensor Unit exactly in parallel with the floor so that the camera gets a bird's-eye view of the Detection Area. Adjust the angle of the Unit by the maximum 20 degrees.

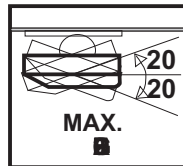

Refer to the dimensions of Detection Area for each installation height (Fig. 1) and clear the Detection Area from any movement of objects other than intended traffic.

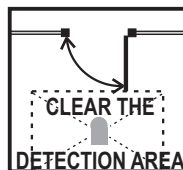

Refer to the dimensions of Detection Area for each installation height on page 5 (Fig. 1), and place the Camera unit so that the passage is fully covered by the detection area.

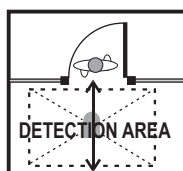

**Installation NOT Recommended**

Outdoor Installations. The product is designed for indoor use only.

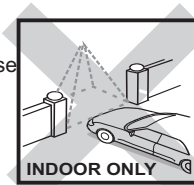

DO NOT install the video sensor unit above the floor facing directly into the sun light or other bright lights. The shadow or reflections caused by strong lights may generate false counting.



DO NOT adjust the angle of the Video Sensor Unit over 20 degrees from normal angle.

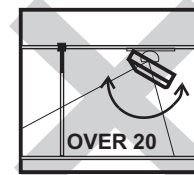

DO NOT install the Unit too close to the door so that the door intrudes the Detection Area, or the Detection Area crosses the door.

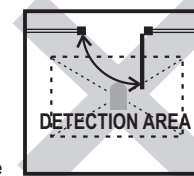

**Video Sensor Unit**

- 4) Volume Control: Adjusts the chime volume.  
(Clockwise : volume down / Counterclockwise : volume up)
- 5) Status LED: Lights on when the system is ON  
Blinks upon ENTRY / EXIT events
- 6) Camera Lens

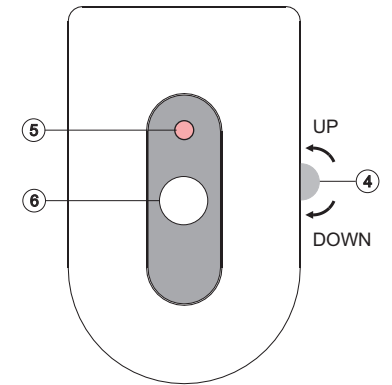

**7. The Counter Display Settings**

**SW2 COUNTER RESET:** Resets both ENTRY / EXIT Counter

\* Counter Reset button is designed to be reached through the pinhole under the Counter Display Unit to prevent accidental reset. Please use a paperclip or a similar sharp element inside the pinhole to press the reset button.

**SW4 ENTRY/EXIT:** Switches the display to ENTRY/EXIT counter

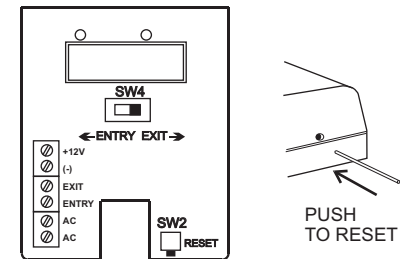

**8. The Video Sensor Settings**

**VR1: Volume Control**

**SW1 RESET:** System reset switch

**JP1:** ENTRY Chime sound selection jumper

- JP2 ON = high tone sound (Factory Setting)
- JP2 OFF = low tone sound

**Note:** EXIT Chime sound stays unchanged regardless the Jumper setting.

**JP2:** CAMERA View block warning mode deactivation Jumper

When Camera View block mode is activated, the system generates alarm sounds of repeated chimes if the Camera View is fully blocked over 10 seconds.

- JP2 ON : Camera View block warning mode deactivated (Factory Setting)
- JP2 OFF : Camera View block warning mode activated

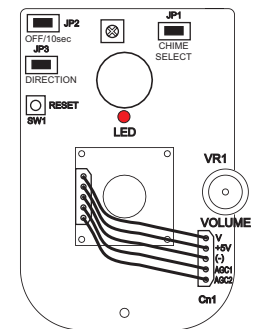

Although the system is designed to event false triggering of Camera View block warning during nights or under dark environment, we recommend to turn the power switch off during the nights or dark environment when the Camera View block warning mode is activated.

**5) Wiring Diagrams**

Refer to the following wiring diagram and make sure your connections are correct before turning on the system.

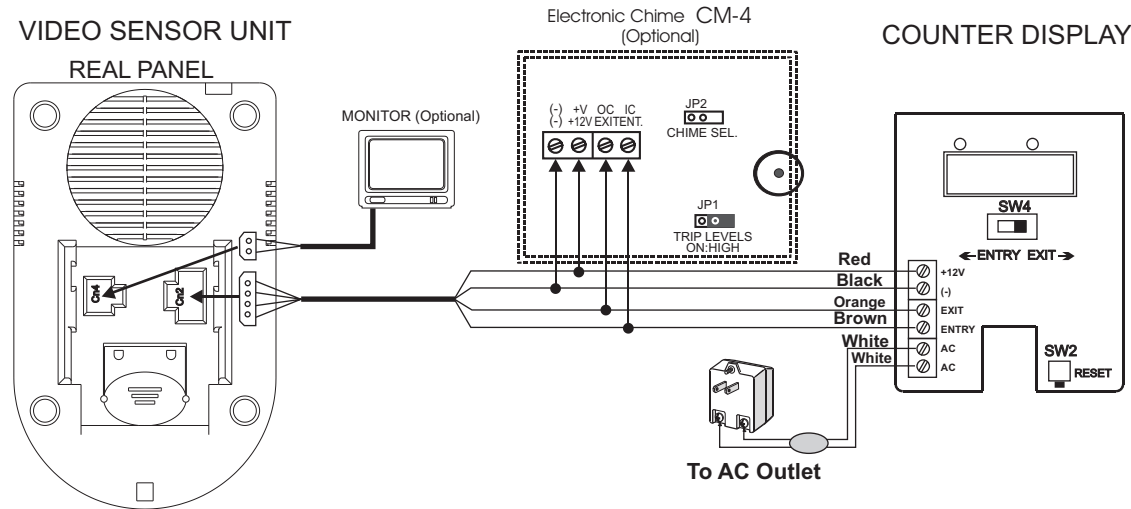

**Video Sensor Unit**

**Counter Display**

- Cn1:** Connector to CMOS Camera
- V:** Video Signal Input
- (-):** Ground
- +5V:** DC 5V Power Output
- AGC1:** Automatic Gain Control 1
- AGC2:** Automatic Gain Control 2

- Cn3:** Chime Speaker Connector

- +12V:** 12V DC Output
- (-):** Ground for DC Output
- EXIT:** (-) Signal Input for Exit Events
- ENTRY:** (-) Signal Input for Entry Events
- AC:** 12V AC Input
- AC:** 12V AC Input
- BZ1:** Unused (Reserved for future use)

- Cn2:** Connector to Counter Display
- (-):** Ground
- +12V:** 12V DC Input
- EXIT:** (-) Exit
- ENTRY:** (-) Entry Signal output

- Cn4:** Connector to Monitor
- V:** Video Signal Output
- (-):** Ground

**6. Front Panel Controls and Names**

**Counter Display**

- 1) Digital Counter LED Display : displays the accumulated number of entry / exit events depending on the status of Entry / Exit indication switch.
- 2) Entry / Exit indication switch:
  - At ENTRY position - the LED display indicates the number of entry events.
  - At EXIT position - the LED display indicates the number of exit events.
- 3) Counter Display Status Indicator:
  - ① Indicate whether the counter is displaying ENTRY counts or EXIT counts.
  - ② ENTRY or EXIT LED blinks for 5 seconds when entry or exit events occur.

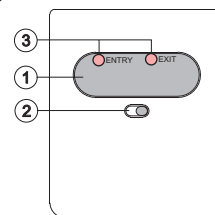

**5. Installation Procedures**

**1) Plan the Installation: Decide the Position of Camera / Controller Unit First**

VDP-100 senses the people's movement in a certain Detection Area and analyzes the traffic in the Area using motion tracking technology. It is important to locate the Video Sensor Unit 1) to fully utilize the Detection Area of VDP-100, and 2) to clear the area from any movements confusing the counter.

Detection Area of the VDP-100 is different depending on the installation heights from the floor, and therefore ***we recommend you determine the detection area of the VDP-100 at your intended installation height, and find the best location of your VDP-100 before starting any other installation procedure.***

Please decide the best position of VDP-100 in the following steps before starting any installation :

- Step 1) Refer to Fig. 1 and find the dimensions of detection area at your intended installation height
- Step 2) Stand facing the center of the door, and assume a square of detection area on the floor.
- Step 3) Make sure people will cross at least 2/3 of the detection area when they enter.
- Step 4) Make sure that the detection area is not crossing the door or the wall. Move the VDP-100 if necessary.
- Step 5) Make sure the area is clear from any unnecessary movement.
- Step 6) The ceiling right above the center of the detection area is where you install your VDP-100 Video Sensor Unit.

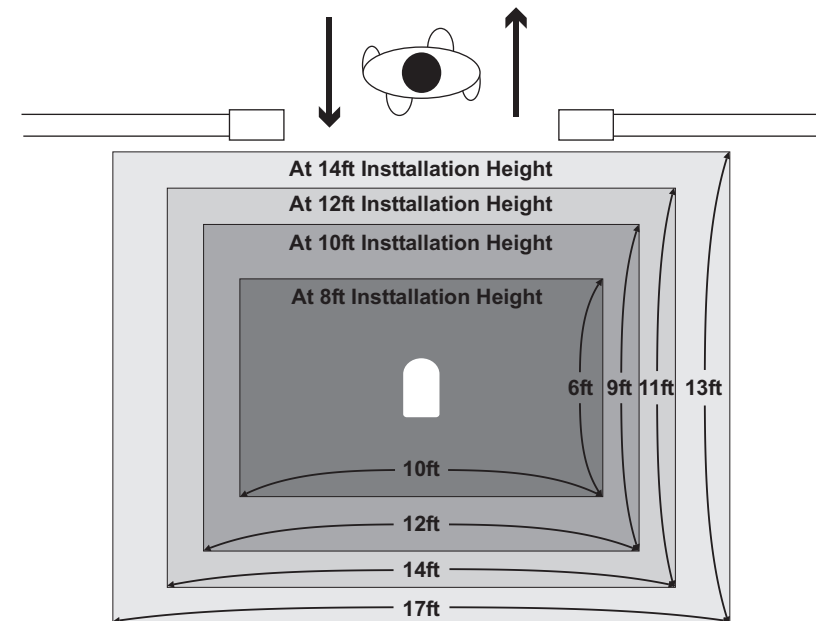

Fig. 1 Installation Heights and Detection Area



## Installation Procedures

### 2) Installation of the Video Sensor Unit

**Step 1)** Refer to page 5 and decide the position to install the Video Sensor Unit.

**Step 2)** Pass the 4-pin Connector and Video Connector through the holes in the mounting bracket. Make a hole by removing the tab on the intended side of the bracket for wire-through if necessary. **You can connect the Video Connector with your monitor if you want to use the VDP-100 as a monitoring camera.**

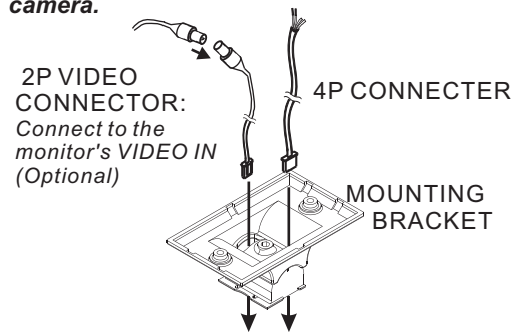

**Step 3)** Using the two screws provided, secure the Mounting Bracket at the location that the Video Sensor Unit is to be installed. (Refer to the **Plan the Installation** on page 5 to decide an optimal position for the Video Sensor Unit.)

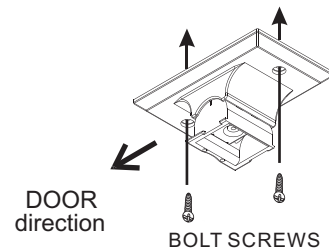

**BE CAREFUL FOR THE DIRECTION OF BRACKET INSTALLATION WHEN MOUNTING ON THE CEILING**

**Step 4)** Connect the 4-pin connector and video connector to the Video Sensor Unit by snapping them in until it is secure.

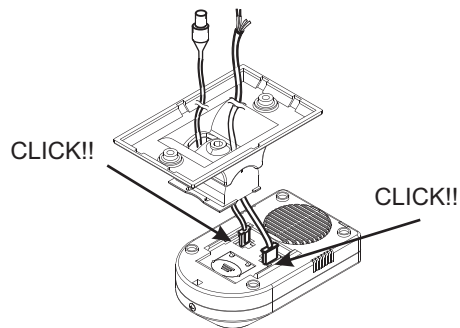

**Step 5)** Secure the Mounting Bracket and the Video Sensor Unit by sliding the unit into the guide rails of the bracket until it is secured. Make sure the round part of the Video Sensor Unit is facing the door.

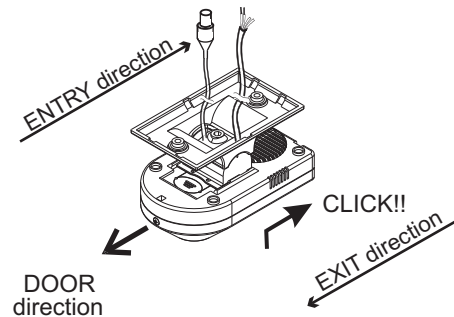

**Step 6)** Pull the wires to the Counter Display Unit and move to the Counter Display Installations stage.

### 3) Installation of the Counter Display Unit

**Step 1)** Decide a place to install the Counter Display within the reach of a Power Source.

**WARNING: PLEASE INSTALL THE COUNTER DISPLAY CLOSE TO THE VIDEO SENSOR UNIT SO THAT THE WIRE LENGTH BETWEEN THE UNITS DOES NOT EXCEED 300 FEET. (AWG # 20 OR LARGER GAUGE WIRES ARE REQUIRED FOR CONNECTIONS OVER 300 FEET.)**

## Installation Procedures

**Step 2)** Open the front panel of the Counter Display shifting the screw up at the bottom of the unit.

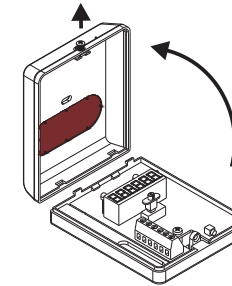

**Step 3)** Using the 6-ft. Power Cord with in-line-switch, connect the pre-stripped wires to the 12V AC 20VA transformer terminals. Strip the insulation on the opposite ends of the wires approximately 1/4 inch, and insert into the terminals on the Counter Display marked AC12V INPUT.

**Step 4)** Refer to the **Wiring Diagram** on page 8, and connect the end of the 4-pin Connector Cable to the terminals on the Counter Display.

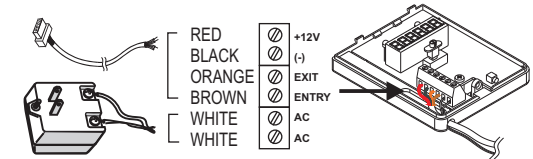

**WARNING: DO NOT PLUG THE TRANSFORMER INTO AC OUTLET AT THIS TIME**

**WARNING: FOR ADDITIONAL EXTENSIONS OF POWER CORDS USE ONLY WIRES OF AWG # 22 OR ABOVE.**

**Step 5)** Remove the tab on the bottom of the Counter Display if necessary to arrange the wires, and Secure the Counter Display to the intended location using two screws provided.

Close the cover and secure it with the screw.

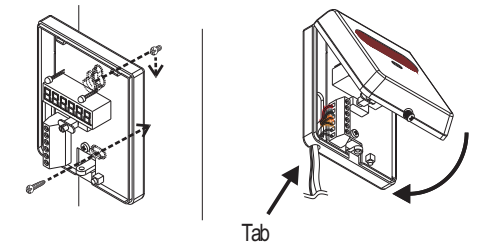

### 4) Turning ON / Testing the System

**Step 1)** Plug-in the AC Transformer to AC outlet and turn the in-line switch ON. Make sure the red LED of the Video Sensor Unit and LED display of the Counter Display is ON upon turning on the system. Check the wiring and power sources if it is not.

**Step 2)** Walk across the detection area and check whether the counter and chime sounds are working. (Ding-dong on ENTRY / Ding on EXIT) Adjust the angle of view a bit if necessary. Check over the installation procedures and precautions in this Instruction Manual if the system does not work properly.

**WARNING: VDP-100 SHOWS ITS BEST PERFORMANCE WHEN THE VIDEO SENSOR UNIT IS INSTALLED IN PARALLEL WITH THE FLOOR SO THAT THE CAMERA HAS A BIRDS-EYE VIEW ON THE AREA. DO NOT ADJUST THE ANGLE UNLESS IT IS NECESSARY.**

**Step 3)** Refer to page 9 of this manual, and adjust the chime volume and other user options if necessary.

**Step 4)** Now your VDP-100 Video-Eye People Counter™ is ready.