

SECTION A-A

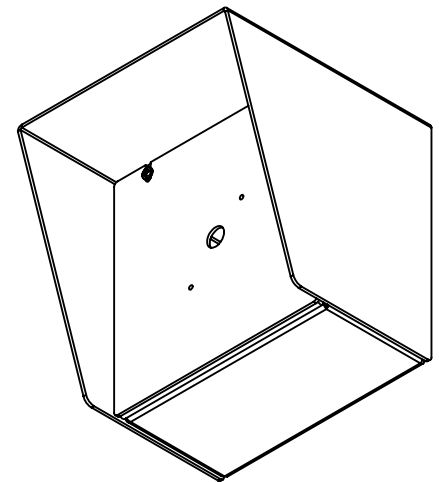

NOTES:

1. MATERIAL OF CONSTRUCTION IS 304 SS, BRUSHED #4.

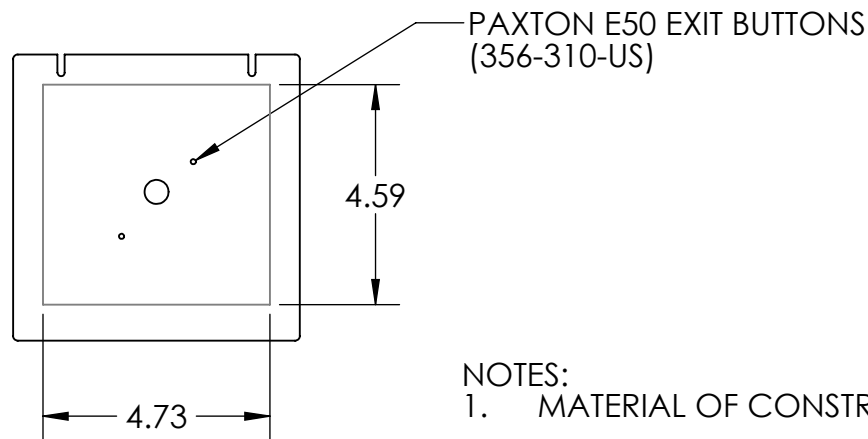
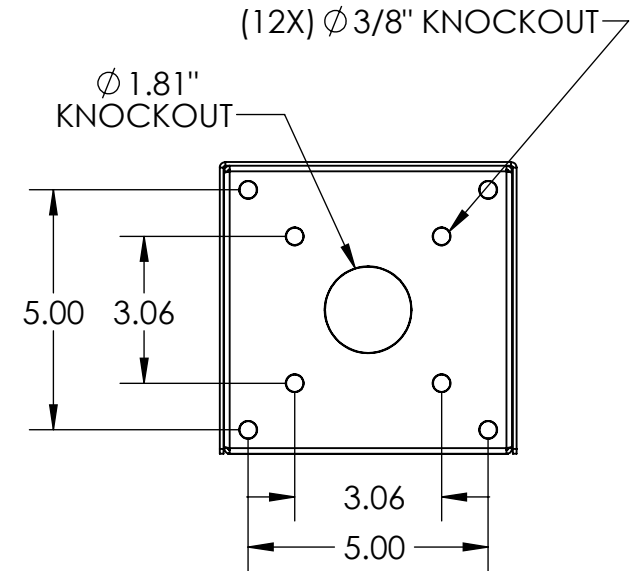

PEDESTALPRO.COM
1-800-660-3072

UNLESS OTHERWISE SPECIFIED:

DIMENSIONS ARE IN INCHES
TOLERANCES:
FRACTIONAL $\pm 1/32$
ANGULAR: $\pm 2^\circ$
TWO PLACE DECIMAL ± 0.010
THREE PLACE DECIMAL ± 0.005

INTERPRET GEOMETRIC
TOLERANCING PER:
ASME Y14.5 -2009

NAME	DATE
DRAWN	
CHECKED	

PROPRIETARY AND CONFIDENTIAL
THE INFORMATION CONTAINED IN THIS DRAWING IS THE SOLE PROPERTY OF PEDESTALPRO LLC. ANY REPRODUCTION IN PART OR AS A WHOLE WITHOUT THE WRITTEN PERMISSION OF PEDESTALPRO LLC IS PROHIBITED.

TITLE:
INSTALLATION

Friday, May 26, 2023 9:10:43 AM

WEIGHT: 5.621

SIZE	PART NO.	REV
A	66HOU-PAXT-06-304	A
NO SCALE		SHEET 1 OF 6

ITEM NO.	PART NUMBER	DESCRIPTION	QTY.
1	66HOU-PAXT-06-304 ENCLOSURE	ENCLOSURE WELDMENT	1
2	66HOU-PAXT-06-304 DOOR	DOOR	1
3	66HOU-PAXT-06-304 HOOD	HOOD	1
4	HINGE	PIANO HINGE	1
5	GASKET SIDE	3/8" X .150 WEATHERSTRIPPING	2
6	GASKET TOP	3/8" X .150 WEATHERSTRIPPING	1
7	--	6-32 PAN HEAD SCREW	4
8	--	6-32 EXTERNAL TOOTH LOCK NUT	2

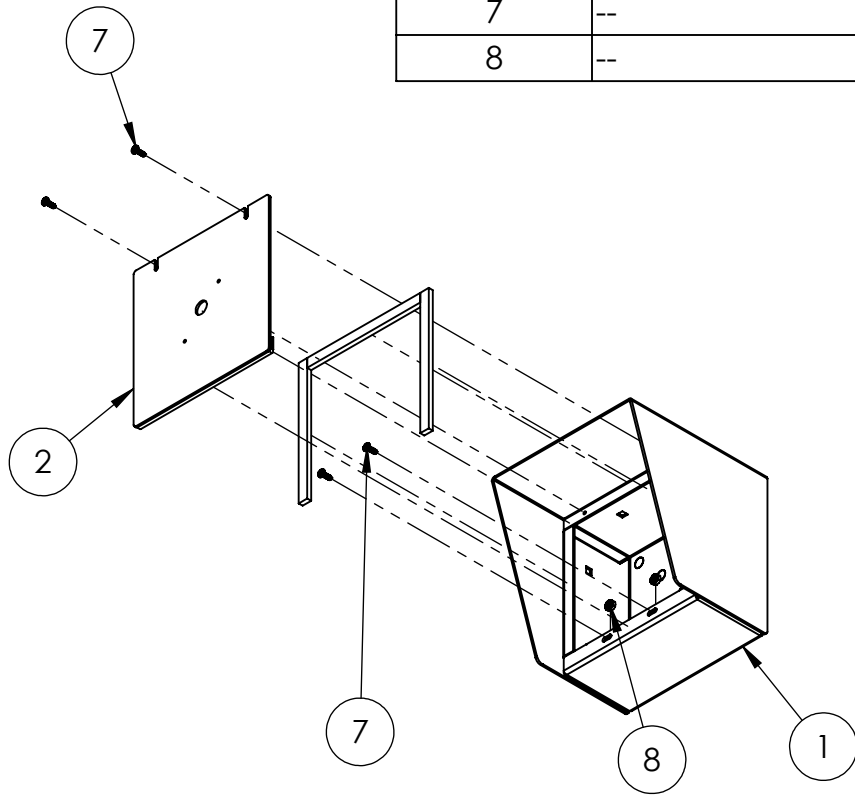

NOTES:

- SEE STANDARD PREPARATION AND COATING INSTRUCTIONS FOR COATING PROCEDURE AND COLOR.
- SEE STANDARD PACKAGING INSTRUCTIONS FOR PACKAGING PROCEDURE.



PEDESTALPRO.COM
1-800-660-3072

UNLESS OTHERWISE SPECIFIED:

DIMENSIONS ARE IN INCHES
TOLERANCES:
FRACTIONAL $\pm 1/32$
ANGULAR: $\pm 2^\circ$
TWO PLACE DECIMAL ± 0.010
THREE PLACE DECIMAL ± 0.005

INTERPRET GEOMETRIC
TOLERANCING PER:
ASME Y14.5 -2009

NAME	DATE
DRAWN	
CHECKED	

PROPRIETARY AND CONFIDENTIAL
THE INFORMATION CONTAINED IN THIS DRAWING IS THE SOLE PROPERTY OF PEDESTALPRO LLC. ANY REPRODUCTION IN PART OR AS A WHOLE WITHOUT THE WRITTEN PERMISSION OF PEDESTALPRO LLC IS PROHIBITED.

TITLE:
ASSEMBLY

Friday, May 26, 2023
9:10:43 AM

WEIGHT: 5.621

SIZE	PART NO.	REV
A	66HOU-PAXT-06-304	A
NO SCALE		SHEET 2 OF 6