

AXIS S3008 Mk II Recorder

User manual

AXIS S3008 Mk II Recorder

About your device

About your device

AXIS S3008 Mk II Recorder is a compact network video recorder with a built-in PoE switch for easy installation. The device features a surveillance-grade hard drive. It also includes a USB port for easy export of video footage. The recorder comes in three models – including a 2 TB, 4 TB or 8 TB hard drive.

How many cameras can I connect to the recorder?

Up to eight devices can be connected to the PoE switch of the recorder.

How much power can the recorder supply to the cameras?

These are the limitations for power over Ethernet (PoE):

- The recorder can supply up to eight devices with PoE.
- The total amount of power available is 124 W.
- Each network port supports up to 15.4 W (PoE Class 3) at the PoE port (PSE) and 12.95 W on the camera side (PD).
- The switch allocates PoE power based on the PoE class of the connected device.

Browser support

Windows®

- Chrome™ (recommended)
- Firefox®
- Edge®

OS X®

- Chrome™ (recommended)
- Safari®

Other

- Chrome™
- Firefox®

To find out more about how to use the device, see the Manual available at [Documentation](#) | [Axis Communications](#).
If you want more information about recommended browsers, go to [Axis OS browser support](#) | [Axis Communications](#).

AXIS S3008 Mk II Recorder

Installation

Installation



To watch this video, go to the web version of this document.

help.axis.com/?&pid=89590§ion=about-your-device

The AXIS S3008 Recorder Mk II is used with version 4 of the AXIS Companion video management software.

AXIS S3008 Mk II Recorder

Get started

Get started

Get started with AXIS Companion

Note

Internet access is required during the system setup.

Installation overview:

1. Register a My Axis account on page 4
2. Install the hardware on page 5
3. Install the desktop app on page 5
4. Create a site on page 5
5. Install the mobile app on page 6

Result of system installation:

- The firmware is upgraded on all Axis devices.
- A password is set for the devices.
- The recordings are enabled with default settings.
- The remote access is enabled.

Register a My Axis account

Register a My Axis account at axis.com/my-axis/login.

You can make your My Axis account more secure by activating multi-factor authentication (MFA). MFA is a security system that adds another layer of verification to ensure the user's identity.

Activate MFA:

1. Log in with your My Axis credentials.
2. Go to  and select **Account settings**.
3. Click **Security settings**
4. Turn on **2-Step verification**.

You are redirected to a login page.

5. Log in with your My Axis credentials.

MFA is now active.

Log in when MFA is active:

1. Log in to your My Axis account.

An email is sent to you.

2. Open the email and click **Authenticate**.

If you didn't receive an email, check if it's in your spam folder. If it's not there, contact IT support.

AXIS S3008 Mk II Recorder

Get started

Install the hardware

1. Install your camera hardware.
2. Connect the recorder to your network via the LAN port.
3. Connect the cameras to the recorder's integrated PoE switch or an external PoE switch.
4. Connect the computer to the same network as the recorder.
5. Connect the power supply to the recorder.

Important

You must first connect the power cord to the recorder, and then connect the power cord to the power outlet.

6. Wait a few minutes for the recorder and cameras to boot up before proceeding.

⚠ CAUTION

Keep the recorder in a well ventilated environment and with plenty of empty space around the recorder to avoid overheating.

Install the desktop app

1. Go to axis.com/products/axis-companion and click **Download** to download AXIS Companion version 4 for Windows.
2. Open the setup file and follow the wizard.
3. Sign in with your *My Axis account*.

Create a site

A site is a single point of entry to a surveillance solution, for example all cameras in a store. You can keep track of several sites through a single My Axis account.

Note

If you have used an earlier version of AXIS Companion, the sites you created will not appear in the list of sites in AXIS Companion version 4. You might also have devices that are not supported. See *Migrating from AXIS Companion Classic to version 4* for more information.

1. Start the AXIS Companion desktop app.
2. Sign in with your *My Axis account*.
3. Click **Create new site**.
4. Name your site and enter your company name.
5. Click **Next**.
6. Select the devices you want to add to your site.
7. Click **Next**.
8. Select storage.
9. Click **Next**.
10. On the **Ready to install** page, **Offline mode** and **Upgrade firmware** are turned on by default. You can turn them off if you do not want to access offline mode or upgrade your devices to the latest firmware version.
11. Click **Install** and wait while AXIS Companion configures the devices.

The configuration may take several minutes.

AXIS S3008 Mk II Recorder

Get started

Install the mobile app

With AXIS Companion mobile app, you can access your devices and recordings from anywhere. You can also get notifications when suspicious events occur, or when someone calls from an intercom.

For Android

Click *Download* or scan the following QR Code.

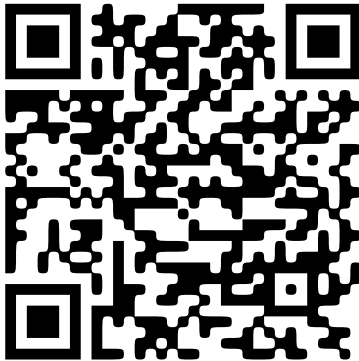

For iOS

Click *Download* or scan the following QR Code.

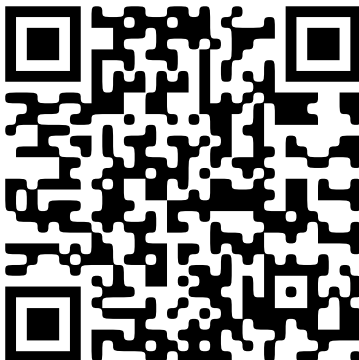

Open the AXIS Companion app and log in with your Axis credentials.

If you don't have a My Axis account, you can go to axis.com/my-axis to register a new account.

AXIS S3008 Mk II Recorder







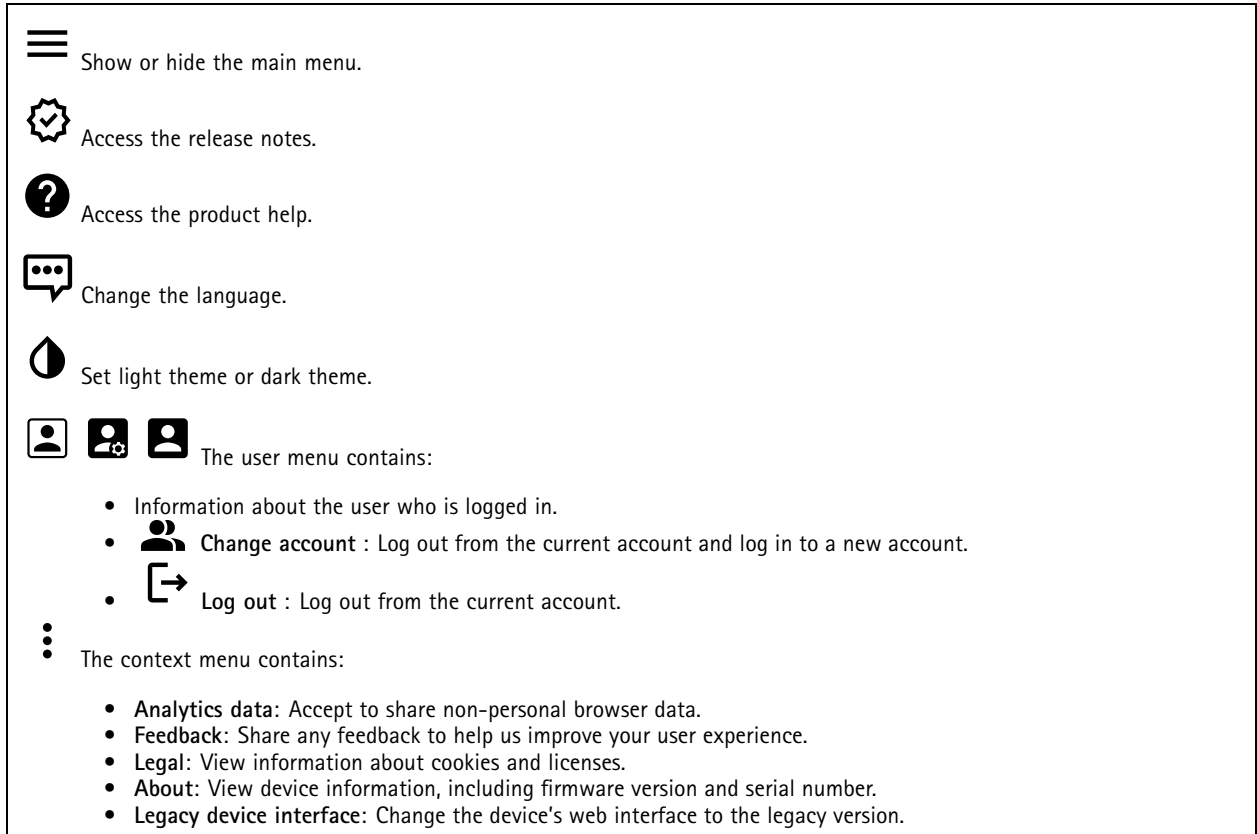



The web interface

The web interface

To reach the device's web interface, type the device's IP address in a web browser.



The screenshot shows a vertical list of menu items, each with an icon and a description:

-  Show or hide the main menu.
-  Access the release notes.
-  Access the product help.
-  Change the language.
-  Set light theme or dark theme.
-    The user menu contains:
 - Information about the user who is logged in.
 -  **Change account** : Log out from the current account and log in to a new account.
 -  **Log out** : Log out from the current account.
-  The context menu contains:
 - **Analytics data**: Accept to share non-personal browser data.
 - **Feedback**: Share any feedback to help us improve your user experience.
 - **Legal**: View information about cookies and licenses.
 - **About**: View device information, including firmware version and serial number.
 - **Legacy device interface**: Change the device's web interface to the legacy version.

Status



Time sync status

Shows NTP synchronization information, including if the device is in sync with an NTP server and the time remaining until the next sync.

NTP settings: View and update the NTP settings. Takes you to the **Date and time** page where you can change the NTP settings.

Ongoing recordings

Shows ongoing recordings and their designated storage space.

Recordings: View ongoing and filtered recordings and their source. For more information, see   Shows the storage space where the recording is saved.

Device info

Shows the device information, including firmware version and serial number.

AXIS S3008 Mk II Recorder

The web interface

Upgrade firmware: Upgrade the firmware on your device. Takes you to the Maintenance page where you can do a firmware upgrade.

Connected clients

Shows the number of connections and connected clients.

View details: View and update the list of the connected clients. The list shows IP address, protocol, port, and PID/Process of each client.

Apps



Add app: Install a new app.

Find more apps: Find more apps to install. You will be taken to an overview page of Axis apps.

Allow unsigned apps: Turn on to allow installation of unsigned apps.

Allow root-privileged apps: Turn on to allow apps with root privileges full access to the device.



View the security updates in AXIS OS and ACAP apps.

Note

The device's performance might be affected if you run several apps at the same time.

Use the switch next to the app name to start or stop the app.

Open: Access the app's settings. The available settings depend on the application. Some applications don't have any settings.



The context menu can contain one or more of the following options:

- **Open-source license:** View information about open-source licenses used in the app.
- **App log:** View a log of the app events. The log is helpful when you contact support.
- **Activate license with a key:** If the app requires a license, you need to activate it. Use this option if your device doesn't have internet access.
If you don't have a license key, go to axis.com/products/analytics. You need a license code and the Axis product serial number to generate a license key.
- **Activate license automatically:** If the app requires a license, you need to activate it. Use this option if your device has internet access. You need a license code to activate the license.
- **Deactivate the license:** Deactivate the license to replace it with another license, for example, when you change from a trial license to a full license. If you deactivate the license, you also remove it from the device.
- **Settings:** Configure the parameters.
- **Delete:** Delete the app permanently from the device. If you don't deactivate the license first, it remains active.

System

Time and location

Date and time

The time format depends on the web browser's language settings.

AXIS S3008 Mk II Recorder

The web interface

Note

We recommend you synchronize the device's date and time with an NTP server.

Synchronization: Select an option for the device's date and time synchronization.

- **Automatic date and time (manual NTS KE servers):** Synchronize with the secure NTP key establishment servers connected to the DHCP server.
 - **Manual NTS KE servers:** Enter the IP address of one or two NTP servers. When you use two NTP servers, the device synchronizes and adapts its time based on input from both.
- **Automatic date and time (NTP servers using DHCP):** Synchronize with the NTP servers connected to the DHCP server.
 - **Fallback NTP servers:** Enter the IP address of one or two fallback servers.
- **Automatic date and time (manual NTP servers):** Synchronize with NTP servers of your choice.
 - **Manual NTP servers:** Enter the IP address of one or two NTP servers. When you use two NTP servers, the device synchronizes and adapts its time based on input from both.
- **Custom date and time:** Manually set the date and time. Click **Get from system** to fetch the date and time settings once from your computer or mobile device.

Time zone: Select which time zone to use. Time will automatically adjust to daylight saving time and standard time.

Note

The system uses the date and time settings in all recordings, logs, and system settings.

Network

IPv4

Assign IPv4 automatically: Select to let the network router assign an IP address to the device automatically. We recommend automatic IP (DHCP) for most networks.

IP address: Enter a unique IP address for the device. Static IP addresses can be assigned at random within isolated networks, provided that each address is unique. To avoid conflicts, we recommend you contact your network administrator before you assign a static IP address.

Subnet mask: Enter the subnet mask to define what addresses are inside the local area network. Any address outside the local area network goes through the router.

Router: Enter the IP address of the default router (gateway) used to connect devices that are attached to different networks and network segments.

Fallback to static IP address if DHCP isn't available: Select if you want to add a static IP address to use as fallback if DHCP is unavailable and can't assign an IP address automatically.

Note

If DHCP isn't available and the device uses a static address fallback, the static address is configured with a limited scope.

IPv6

Assign IPv6 automatically: Select to turn on IPv6 and to let the network router assign an IP address to the device automatically.

Hostname

Assign hostname automatically: Select to let the network router assign a hostname to the device automatically.

Hostname: Enter the hostname manually to use as an alternative way of accessing the device. The server report and system log use the hostname. Allowed characters are A-Z, a-z, 0-9 and -.

DNS servers

AXIS S3008 Mk II Recorder

The web interface

Assign DNS automatically: Select to let the DHCP server assign search domains and DNS server addresses to the device automatically. We recommend automatic DNS (DHCP) for most networks.

Search domains: When you use a hostname that is not fully qualified, click **Add search domain** and enter a domain in which to search for the hostname the device uses.

DNS servers: Click **Add DNS server** and enter the IP address of the DNS server. This provides the translation of hostnames to IP addresses on your network.

Network discovery protocols

Bonjour®: Turn on to allow automatic discovery on the network.

Bonjour name: Enter a friendly name to be visible on the network. The default name is the device name and MAC address.

UPnP®: Turn on to allow automatic discovery on the network.

UPnP name: Enter a friendly name to be visible on the network. The default name is the device name and MAC address.

WS-Discovery: Turn on to allow automatic discovery on the network.

One-click cloud connection

One-click cloud connection (O3C) together with an O3C service provides easy and secure internet access to live and recorded video from any location. For more information, see axis.com/end-to-end-solutions/hosted-services.

Allow O3C:

- **One-click:** This is the default setting. Press and hold the control button on the device to connect to an O3C service over the internet. You need to register the device with the O3C service within 24 hours after you press the control button. Otherwise, the device disconnects from the O3C service. Once you register the device, **Always** is enabled and the device stays connected to the O3C service.
- **Always:** The device constantly attempts to connect to an O3C service over the internet. Once you register the device, it stays connected to the O3C service. Use this option if the control button on the device is out of reach.
- **No:** Disables the O3C service.

Proxy settings: If needed, enter the proxy settings to connect to the proxy server.

Host: Enter the proxy server's address.

Port: Enter the port number used for access.

Login and Password: If needed, enter username and password for the proxy server.

Authentication method:

- **Basic:** This method is the most compatible authentication scheme for HTTP. It's less secure than the **Digest** method because it sends the username and password unencrypted to the server.
- **Digest:** This method is more secure because it always transfers the password encrypted across the network.
- **Auto:** This option lets the device select the authentication method depending on the supported methods. It prioritizes the **Digest** method over the **Basic** method.

Owner authentication key (OAK): Click **Get key** to fetch the owner authentication key. This is only possible if the device is connected to the internet without a firewall or proxy.

AXIS S3008 Mk II Recorder

The web interface

Network ports

Power over Ethernet

- **Allocated power:** Number of watts (W) that are currently allocated.
- **Total PoE consumption:** Number of watts (W) that are consumed.
- **Keep PoE active during recorder restart:** Turn on to supply power to connected devices during a restart of the recorder.



Click to show or hide the ports image.

- Click a port in the image to see the port details in the port list.

Port list

- **Port:** The port number.
- **PoE:** Turn on or off PoE for the port.
- **Network:** Turn on or off network for the port.
- **Status:** Shows if there is device connected to this port.
- **Friendly name:** The friendly name is set in **Network settings**. The default name is a combination of the model and the media access control address (MAC address) of the connected device.
- **Power consumption:** Number of watts (W) that are currently consumed and allocated by the connected device.

Power over Ethernet

Allocated power: Number of watts (W) that are currently allocated.

Total PoE consumption: Number of watts (W) that are consumed.

Keep PoE active during recorder restart: Turn on to supply power to connected devices during a restart of the recorder.

Used space: Percentage of space used.

Free space: Percentage of space available for recordings.

Free space: Available disk space displayed in megabytes (MB), gigabytes (GB), or terabytes (TB).

Disk status: Current status of the disk.

Disk temperature: Current running temperature.

PoE: Turn on or off PoE for each port. When a device is connected, you'll see the following information:

- **Friendly name:** The friendly name is set in **Network settings**. The default name is a combination of the model and the media access control address (MAC address) of the connected device.
- **Power consumption:** Number of watts (W) that are currently consumed and allocated.

Security

Certificates

AXIS S3008 Mk II Recorder

The web interface

Certificates are used to authenticate devices on a network. The device supports two types of certificates:

- **Client/server certificates**
A client/server certificate validates the device's identity, and can be self-signed or issued by a Certificate Authority (CA). A self-signed certificate offers limited protection and can be used before a CA-issued certificate has been obtained.
- **CA certificates**
You can use a CA certificate to authenticate a peer certificate, for example to validate the identity of an authentication server when the device connects to a network protected by IEEE 802.1X. The device has several pre-installed CA certificates.

These formats are supported:

- Certificate formats: .PEM, .CER, and .PFX
- Private key formats: PKCS#1 and PKCS#12

Important

If you reset the device to factory default, all certificates are deleted. Any pre-installed CA certificates are reinstalled.



Filter the certificates in the list.



Add certificate : Click to add a certificate.

- More  : Show more fields to fill in or select.
- **Secure keystore**: Select to use **Secure element** or **Trusted Platform Module 2.0** to securely store the private key. For more information on which secure keystore to select, go to help.axis.com/en-us/axis-os#cryptographic-support.
- **Key type**: Select the default or a different encryption algorithm from the drop-down list to protect the certificate.



The context menu contains:

- **Certificate information**: View an installed certificate's properties.
- **Delete certificate**: Delete the certificate.
- **Create certificate signing request**: Create a certificate signing request to send to a registration authority to apply for a digital identity certificate.

Secure keystore  :

- **Secure element (CC EAL6+)**: Select to use secure element for secure keystore.
- **Trusted Platform Module 2.0 (CC EAL4+, FIPS 140-2 Level 2)**: Select to use TPM 2.0 for secure keystore.

IEEE 802.1x

IEEE 802.1x is an IEEE standard for port-based network admission control providing secure authentication of wired and wireless network devices. IEEE 802.1x is based on EAP (Extensible Authentication Protocol).

To access a network protected by IEEE 802.1x, network devices must authenticate themselves. The authentication is performed by an authentication server, typically a RADIUS server (for example, FreeRADIUS and Microsoft Internet Authentication Server).

Certificates

When configured without a CA certificate, server certificate validation is disabled and the device tries to authenticate itself regardless of what network it is connected to.

When using a certificate, in Axis' implementation, the device and the authentication server authenticate themselves with digital certificates using EAP-TLS (Extensible Authentication Protocol - Transport Layer Security).

To allow the device to access a network protected through certificates, you must install a signed client certificate on the device.

Client certificate: Select a client certificate to use IEEE 802.1x. The authentication server uses the certificate to validate the client's identity.

AXIS S3008 Mk II Recorder

The web interface

CA certificate: Select CA certificates to validate the authentication server's identity. When no certificate is selected, the device tries to authenticate itself regardless of what network it is connected to.

EAP identity: Enter the user identity associated with the client certificate.

EAPOL version: Select the EAPOL version that is used in the network switch.

Use IEEE 802.1x: Select to use the IEEE 802.1x protocol.

Custom-signed firmware certificate

To install test firmware or other custom firmware from Axis on the device, you need a custom-signed firmware certificate. The certificate verifies that the firmware is approved by both the device owner and Axis. The firmware can only run on a specific device which is identified by its unique serial number and chip ID. Only Axis can create custom-signed firmware certificates, since Axis holds the key to sign them.

Install: Click to install the certificate. You need to install the certificate before you install the firmware.

Accounts

Storage

Onboard storage

Hard drive

- **Free:** The amount of free disk space.
- **Status:** If the disk is mounted or not.
- **File system:** The file system used by the disk.
- **Encrypted:** If the disk is encrypted or not.
- **Temperature:** The current temperature of the hardware.
- **Overall health test:** The result after checking the health of the disk.

Tools

- **Check:** Check the storage device for errors and tries to repair it automatically.
- **Repair:** Repair the storage device. Active recordings will pause during the repair. Repairing a storage device may result in lost data.
- **Format:** Erase all recordings and format the storage device. Choose a file system.
- **Encrypt:** Encrypt stored data.
- **Decrypt:** Decrypt stored data. The system will erase all files on the storage device.
- **Change password:** Change the password for the disk encryption. Changing the password doesn't disrupt ongoing recordings.
- **Use tool:** Click to run the selected tool

Unmount  : Click before you disconnect the device from the system. This will stop all ongoing recordings.

Write protect: Turn on to protect the storage device from being overwritten.

Autoformat  : The disk will automatically format using the ext4 file system.

Logs

SSH server

Secure Shell (SSH): Turn on to allow a user to securely log on and perform shell and network services over the network.

AXIS S3008 Mk II Recorder

The web interface

Maintenance

Restart: Restart the device. This does not affect any of the current settings. Running applications restart automatically.

Restore: Return *most* settings to the factory default values. Afterwards you must reconfigure the device and apps, reinstall any apps that didn't come preinstalled, and recreate any events and presets.

Important

The only settings saved after restore are:

- Boot protocol (DHCP or static)
- Static IP address
- Default router
- Subnet mask
- 802.1X settings
- O3C settings

Factory default: Return *all* settings to the factory default values. Afterwards you must reset the IP address to make the device accessible.

Note

All Axis device firmware is digitally signed to ensure that you only install verified firmware on your device. This further increases the overall minimum cybersecurity level of Axis devices. For more information, see the white paper "Signed firmware, secure boot, and security of private keys" at axis.com.

Firmware upgrade: Upgrade to a new firmware version. New firmware releases can contain improved functionality, bug fixes, and completely new features. We recommend you to always use the latest release. To download the latest release, go to axis.com/support.

When you upgrade, you can choose between three options:

- **Standard upgrade:** Upgrade to the new firmware version.
- **Factory default:** Upgrade and return all settings to the factory default values. When you choose this option, you can't revert to the previous firmware version after the upgrade.
- **Autorollback:** Upgrade and confirm the upgrade within the set time. If you don't confirm, the device reverts to the previous firmware version.

Firmware rollback: Revert to the previously installed firmware version.

AXIS S3008 Mk II Recorder

Product overview

Product overview

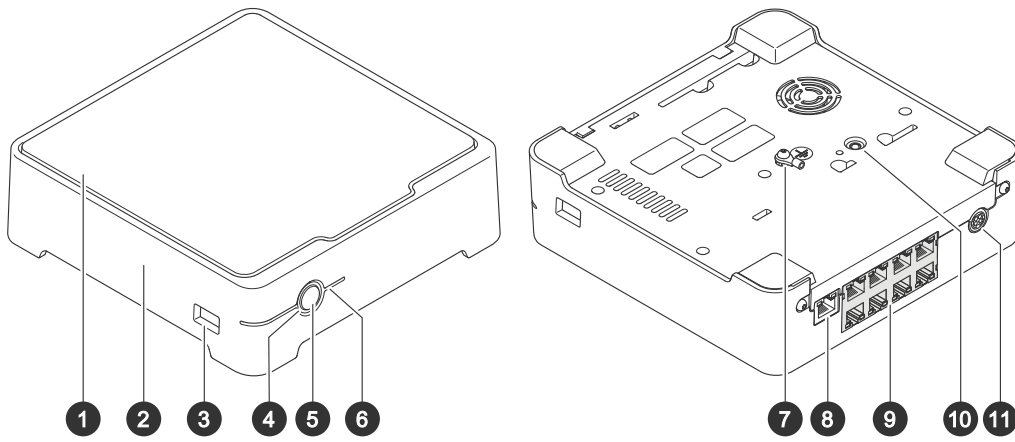

- 1 Hard drive
- 2 Alarm buzzer
- 3 USB port
- 4 Status LED
- 5 Power button
- 6 Hard drive LED
- 7 Grounding
- 8 LAN port
- 9 PoE port (8x)
- 10 Control button
- 11 Power input

Power button

- To shut down the recorder, long press the power button until the buzzer makes a brief sound.
- To silence the buzzer, short press the power button.

Control button

The control button is used for:

- Resetting the product to factory default settings. See *Hard reset a recorder on page 17*.
- Connecting to a one-click cloud connection (O3C) service over the internet. To connect, press and hold the button for about 3 seconds until the status LED flashes green.

AXIS S3008 Mk II Recorder

Troubleshooting

Troubleshooting

The status LED gives you the following information:

Status LED	Indication
Green	The recorder is on and the status is ok.
Orange	The recorder is starting up, or the firmware is upgrading. Wait until the LED turns green.
Red	This can mean that the PoE budget is exceeded. If you just connected a device to the recorder, try to remove it again. For more information about PoE limitations, see .

The hard drive LED gives you the following information:

Hard drive LED	Indication
Green	The LED is flashing green when data is written to the hard drive.
Red	A recording disruption has occurred. Go to System > Storage for more information.

The buzzer sounds for this reason:

- The PoE budget is exceeded. If you just connected a device to the recorder, try removing it again. For more information about PoE limitations, see

Note

You can stop the buzzer with a short press of the power button.

The recorder shuts down:

- The recorder is severely overheated.

Technical issues, clues and solutions

Issue	Solution
My recordings are not available.	Go to <i>Fix common issues on page 16</i> .
I cannot connect to my cameras.	Go to <i>Fix common issues on page 16</i> .
I receive error notification: "No contact".	Go to <i>Fix common issues on page 16</i> .
My sites do not appear in my mobile app.	Make sure you have version 4 of the AXIS Companion mobile app.

Fix common issues

Before you restart, configure or reset your devices, we recommend that you to save a system report.

See *Save a system report on page 18*.

1. Check that your cameras and recorder have power.

AXIS S3008 Mk II Recorder

Troubleshooting

2. Check that you are connected to the internet.
3. Check that the network is working.
4. Check that the cameras are connected to the same network as the computer, unless you are remote.

Still not working?

5. Make sure that your cameras, recorder and AXIS Companion desktop app have the latest firmware and software updates.
See [Upgrade firmware on page 17](#).
6. Restart the AXIS Companion desktop app.
7. Restart you cameras and recorder.

Still not working?

8. Make a hard reset on the cameras and the recorder, to completely put them back to factory default settings.
See [Hard reset a recorder on page 17](#).
9. Add the reset cameras to your site again.

Still not working?

10. Update your graphics card with the latest drivers.

Still not working?

11. Save a system report and contact *Axis technical support*.
See [Save a system report on page 18](#).

Upgrade firmware

New firmware updates bring you to the latest and improved set of features, functions, and security enhancements.

1. Go to the leader device's web interface.
2. Go to **Maintenance > Firmware upgrade** and click **Upgrade**.
3. Follow the instructions on the screen.

Hard reset a recorder

Important

Move the recorder carefully while it's switched on. Sudden moves or shocks may damage the hard drive.

Note

- A hard reset will reset all the settings, including the IP address.
- A hard reset will not remove your recordings.

1. Switch off the recorder:

Press the power button on the front of the recorder for 4-5 seconds until you hear a beep.

2. Wait until the recorder is switched off, then turn it over to access the control button.
3. Press and hold the control button. Press and release the power button to start the recorder. Release the control button after 15-30 seconds when the LED indicator flashes amber.

AXIS S3008 Mk II Recorder

Troubleshooting

4. Carefully put the recorder back in its place.
5. The process is complete when the status LED indicator turns green. The product has been reset to the factory default settings. If no DHCP server is available on the network, the default IP address is 192.168.0.90
6. Reset your devices connected to the recorder.
7. If your hard drive is encrypted, it must be mounted manually after the recorder is reset:
 - 7.1 Go to the device's web interface.
 - 7.2 Go to **System > Storage** and click **Mount**.
 - 7.3 Enter the encryption password used when encrypting the hard drive.

I can't log in to the product's web interface

If you set a password for the product during configuration, and later add that product to a site, you can no longer log in to the product's web interface with the password you've set. This is because AXIS Companion software changes the passwords of all devices in the site.

To log in to a device in your site, type the username **root** and your site password.

How to erase all recordings

1. In the device's web interface, go to **System > Storage**.
2. Select **Format** and click **Use tool**.

Note

This procedure erases all recordings from the hard drive, but the configuration of the recorder and the site doesn't change.

Save a system report

1. In AXIS Companion, go to  > **Save system report**.
2. When you register a new case at Axis Helpdesk, attach the system report.

AXIS S3008 Mk II Recorder

Need more help?

Need more help?

Useful links

- *AXIS Companion user manual*

Contact support

Contact support at axis.com/support.

