



Network Camera

Operation Guide



VB-H47/VB-M46

VB-S32VE/VB-S32D

VB-S820D/VB-S920F

Table of Contents

Introduction.....	8
Precautions for Use (Disclaimer)	8
License Agreement of Software.....	9
Trademarks	9
Third Party Software.....	9
Security Export Control	10
User Manuals.....	11
Types of User Manuals	11
How to Use This Document	11
Symbols Used in This Document.....	12

Chapter 1

Before Use

Functions of the Network Camera	14
Camera Software	15
Camera Operations and Settings	15
Software to Install on the Computer.....	15
Additional Licenses (Sold Separately).....	16
Operating Environment.....	17
Computer Environment Details	17
Verified Mobile Environment (Settings Page, Camera Viewer, Mobile Camera Viewer) – As of May, 2022.....	17
Steps for Setting Up the Camera.....	18
Step 1 Preparing to Install the Camera.....	18
Step 2 Installing the Camera.....	18
Step 3 Setting the Camera Angle	18
Step 4 Using the Camera Viewers	18
Step 5 Adjusting Advanced Settings According to Its Use	18
Troubleshooting	18

Chapter 2

Camera Setup

Installing Software	20
Necessary Software	20
Installation.....	20
Checking Windows Settings.....	21
Firewall Settings	21
Settings When Using Windows Server.....	21
Settings for the Environment Which Uses a Proxy Server	22
Configuring Initial Camera Settings.....	23
Flow of Configuration Using the Camera Management Tool	23
Camera's Settings Page from the Web Browser.....	23
Setting the Camera Angle	25

Chapter 3

Camera Viewer

Viewing Video with the Camera Viewer	27
Launching the Camera Viewer.....	27
Camera Viewer Access Restrictions.....	28
Camera Viewer Screen	29
Changing the Reception Video Size and Display Screen Size	32
Changing the Reception Video Size/Format and Display Screen Size	32
Displaying in Full Screen Mode	33
Operating the Camera.....	35
Obtaining Camera Control Privileges	35
Using Pan/Tilt/Zoom.....	36
Adjusting Video.....	39
Using Backlight Compensation	40
Using Presets or the Home Position	41
Viewer PTZ and Digital PTZ.....	42
Magnifying and Displaying a Part of Video (Viewer PTZ)	42
Cropping and Displaying Part of the Video (Digital PTZ)	44
Saving Snapshots.....	46
Recording Video to a Memory Card.....	47
Recording Videos Manually	47
Confirming Recorded Video	47
Receiving/Transmitting Audio.....	48
Receiving Audio.....	48
Transmitting Audio	49
Operating the External Device Output and Checking the Status of Event Detection ...	50
Operating External Device Output.....	50
Checking the Status of Event Detection	50

Chapter 4

Settings Page

How to Use the Settings Page.....	53
Accessing the Settings Page.....	53
Common Settings Page Operations	54
Operating the Video Display Area	55
Each Settings Page.....	56
[Video] > [Video]	58
Stream 1, Stream 2	58
Stream 3, Stream 4	59
Digital PTZ.....	59
[Video] > [Camera Angle]	60
[Video] > [Preset]	61
Camera Position.....	61
Simple Camera Settings	61
Exposure/Compensation.....	62
Focus	66
White Balance	67
Image Adjustment.....	68
Register Preset.....	69

[Video] > [Preset Tour]	71
Screen Composition.....	71
Tour Route Settings.....	73
[Video] > [Picture (Option)]	75
Camera Control.....	75
Day/Night	76
[Video] > [ADSR].....	78
ADSR, ADSR Area	78
General ADSR.....	79
[Video] > [On-screen display].....	80
Date display	80
Time display.....	80
Text display.....	80
Common Settings.....	81
[Video] > [Privacy Mask]	82
Registering Privacy Masks.....	82
Changing/Deleting a Privacy Mask.....	83
[Video] > [View Restriction].....	85
Setting View Restrictions.....	86
[Video] > [Panorama]	89
Creating a Panorama Image.....	89
Saving the Panorama Image as an Image File/Opening the Image File	91
[Audio] > [Audio].....	92
General Audio	92
AAC-LC	93
Audio Server	93
Sound Clip Upload 1 to 3.....	94
[Video Record] > [Upload].....	95
Video Record Settings	95
General Upload.....	95
FTP Upload	96
HTTP Upload.....	97
[Video Record] > [Memory Card Recording].....	99
Video Record Settings	99
Memory Card Operations	100
Memory Card Information	101
[Video Record] > [E-mail Notification].....	102
E-mail Notification	102
[Detection] > [Audio Detection]	104
Volume Detection.....	104
[Detection] > [Intelligent Function] - Overview -	106
Intelligent Function.....	106
Notes on Intelligent Function Settings and Operations	109
Settings Screen.....	110
Steps for Configuring Video Detection	112

[Detection] > [Intelligent Function] - Detection Settings -	115
[Detection Conditions]	115
Setting Area or Line	116
Displaying Detection Status	117
[Event]	119
[Event] > [External Device]	121
External Device Output	121
External Device Input	121
External Device Input 1, 2	122
[Event] > [Timer]	124
Timer 1 to 4	124
[Event] > [Switch Day/Night]	126
Switch Day/Night	126
[Event] > [Linked Event]	127
Linked Event 1 to 4	127
Linked Event Operation Examples	129
[Server] > [Server]	131
HTTP Server	131
SNMP Server	131
SNMP v1 and v2c Server	132
SNMP v3 Server	132
[Server] > [Video Server]	133
Video Server	133
[Server] > [RTP Server]	134
RTP Server	134
Audio Settings 1, 2	134
RTP Stream 1 to 5	135
[ONVIF] > [ONVIF]	136
WS-Security	136
Media Profile Settings	136
[Security] > [Certificate Management]	137
Server/Client Certificate Management	137
Create Certificate	137
CA Certificate Management	138
CRL Management	138
[Security] > [SSL/TLS]	139
Encrypted Communications	139
Server Certificates	139
[Security] > [802.1X]	140
802.1X Authentication	140
Authentication Method	140
Client Certificates	140
[Security] > [User Management]	141
Administrator Account	141
Authorized User Account	141
User Authority	142

[Security] > [Host Access Restrictions]	143
IPv4 Host Access Restrictions	143
IPv6 Host Access Restrictions	143
[System] > [System]	144
Camera Name	144
Installation Conditions	144
Camera Position Control	144
External Input Device	145
External Output Device	145
[System] > [Viewer]	146
General	146
Viewer Settings	146
[System] > [Date and Time]	147
Current Date and Time	147
Settings	147
[System] > [Memory Card]	149
Memory Card Operations	149
Memory Card Information	149
[System] > [Network]	150
LAN	150
IPv4	150
IPv6	151
DNS	152
mDNS	152
[Maintenance] > [General]	153
Device Information	153
Tool	153
Initialization	153
[Maintenance] > [Backup / Restore]	155
Backup / Restore	155
[Maintenance] > [Update Firmware]	156
Device Information	156
Update Firmware	156
[Maintenance] > [Environment]	157
Environment	157
[Maintenance] > [Log]	158
View Logs	158
Log Notifications	158

Chapter 5

Appendix

Modifiers	161
Troubleshooting	163
List of Log Messages	166
Log Messages on the Camera	166
Error Log	166
Warning Log	171
Notification Log	175

List of Viewer Messages	179
Messages Shown in the Information Display	179
Restoring Factory Default Settings	181
Restoring the Initial Settings from a Web Browser.....	181
Restoring Factory Default Settings with the Reset Switch on the Camera	181
List of Factory Default Settings.....	183
Cleaning the Camera.....	189
Confirmation of Video Image	189
Cleaning Method.....	189
Camera Disposal	190
Index.....	191

Introduction

Thank you for purchasing a Canon Network Camera (hereafter referred to as the camera)*. This "Operation Guide" explains the camera settings and operations. Read this document carefully before using the camera to ensure correct use.

* The cameras described in this document may include models not available in your country and/or region.

For the latest information on this product (firmware and software, user manual, operating environment, etc.), refer to the Canon website.

Precautions for Use (Disclaimer)

■ Installation and Lightning Protection

 Caution
Request a professional installer for all installation work. Never try to install the camera yourself. Doing so may result in unforeseen accidents such as dropping the camera or electric shock.

For installing cameras, installation of a lightning arrester (a surge protection device) is strongly recommended as a measure against failures caused by lightning strikes.

■ Network Security

The user is responsible for the network security of this product and its use. Take appropriate network security measures to avoid security breaches. To the full extent permitted by laws and regulations, neither Canon Inc. nor any of its subsidiaries or affiliates shall be liable for any losses, direct, incidental or consequential damages, or liabilities that may be incurred as a result of network security incidents such as unauthorized accesses.

<Network Security Recommendations>

- Set the administrator password that should not be easily guessed by third parties.
- Change the HTTP or HTTPS port number of the camera.
- Limit access to the camera by network devices.

■ CMOS Sensor

When shooting a fast-moving subject with a network camera or when the angle of view changes during shooting, the subject may happen to look bent diagonally.

This is a phenomenon that occurs when the CMOS image sensor is used, and this is not a malfunction of the network camera.

■ Built-In Camera Functions

Do not use the following built-in camera functions in situations requiring high reliability:

- Intelligent Function
- Image Stabilization Function **HM4x**

These do not guarantee high-precision capture and cannot support applications beyond their intended range of use. Canon will assume no liability for any accident or damage resulting from the use of these functions or software.

License Agreement of Software

For the license agreement of the software, refer to the text file provided along with the installer.

Trademarks

- Microsoft, Windows, Windows Server and Microsoft Edge are trademarks or registered trademarks of Microsoft Corporation in the United States and other countries.
- Windows is legally recognized as the Microsoft Windows Operating System.
- Safari is a trademark of Apple Inc.
- IOS is a trademark or registered trademark of Cisco in the U.S. and other countries and is used under license.
- ONVIF® is a trademark of ONVIF, Inc.
- All other company or product names used in this document are trademarks or registered trademarks of their respective holders.

Third Party Software

This camera contains third party software modules. Confirm each module's license conditions in [Maintenance] > [General] > [Tool] > [See Third Party Software License Conditions] on the Settings page.

Software Licensed Under the GPL and LGPL

If you would like to acquire the source code licensed under the GPL and LGPL, please contact us using one of the following methods:

- (1) To receive an e-mail with the URL to download the source code, access <<https://global.canon/en/oss/scd/index.html>> and complete the request form; or
- (2) To receive the source code by post, send us a letter in writing to the address below with the following information.
In the case you have chosen (2), WE MAY CHARGE YOU for the delivery cost.
 - (i) Your Address (Country/Region, ZIP code, Address, Your name) [mandatory]
 - (ii) Your e-mail address (for the purpose of possible communication with us) [optional]
 - (iii) Product Name/Application Name [mandatory]
 - (iv) Product/Application Software Version [optional]If you do not specify a version, we will send source code corresponding to the latest version.
 - Address:
Open Source Promotion Division, Canon Inc.
30-2, Shimomaruko 3-chome, Ohta-ku, Tokyo 146-8501, Japan
 - For Canon's privacy policy, refer to Canon Global Website <<https://global.canon/>>.

This product is licensed under AT&T patents for the MPEG-4 standard and may be used for encoding MPEG-4 compliant video and/or decoding MPEG-4 compliant video that was encoded only (1) for a personal and non-commercial purpose or (2) by a video provider licensed under the AT&T patents to provide MPEG-4 compliant video. No license is granted or implied for any other use for MPEG-4 standard.

THIS PRODUCT IS LICENSED UNDER THE AVC PATENT PORTFOLIO LICENSE FOR THE PERSONAL USE OF A CONSUMER OR OTHER USES IN WHICH IT DOES NOT RECEIVE REMUNERATION TO (i) ENCODE VIDEO IN COMPLIANCE WITH THE AVC STANDARD ("AVC VIDEO") AND/OR (ii) DECODE AVC VIDEO THAT WAS ENCODED BY A CONSUMER ENGAGED IN A PERSONAL ACTIVITY AND/OR WAS OBTAINED FROM A VIDEO PROVIDER LICENSED TO PROVIDE AVC VIDEO. NO LICENSE IS GRANTED OR SHALL BE IMPLIED FOR ANY OTHER USE. ADDITIONAL INFORMATION MAY BE OBTAINED FROM MPEG LA, L.L.C. SEE [HTTP://WWW.MPEGLA.COM](http://www.mpegla.com)

This product comes with exFAT, a licensed file system technology from Microsoft.

Security Export Control

This product is subject to security export control. Therefore, to export or carry it overseas may require an authorization by governmental agencies.

Types of User Manuals

The following describes the different camera user manuals. When instructed to reference another manual, its name will be listed as shown below.

Before Using This Camera (included)

Explanation on safety precautions and downloading information from the Canon website.

Installation Guide

This describes precautions and procedures for installing the camera.

Operation Guide (this document)

This explains the camera initial settings, camera viewer operations, settings on the Settings page, and troubleshooting, etc.

Mobile Camera Viewer Operation Guide

This explains details on how to use the Mobile Camera Viewer.

Specifications

This lists the camera specifications.

Camera Management Tool User Manual

This explains details on how to use the Camera Management Tool.

Recorded Video Utility User Manual

This explains details on how to use the Recorded Video Utility.

■ Notes

1. Any unauthorized reproduction of this document is prohibited.
2. The contents of this document are subject to change without any prior notice.
3. This document has been prepared with the utmost attention to accuracy. If you have any comments, however, please contact a Canon sales representative.
4. Canon shall assume no liability for any outcome of using this product, notwithstanding items 2 and 3 above.

How to Use This Document

The assumed reading format of this document is on a computer screen.

■ Software Screenshots





The software screenshots samples shown in this document are for illustration only. The screenshots may differ from the actual screens displayed.

Descriptions use sample screens when connected to the VB-H47, with Windows 10 for the operating system and Google Chrome for the web browser.

Symbols Used in This Document





■ Symbols Indicating Camera Models

Explanations that differ depending on the camera model are indicated by the camera name and the following symbols.

Symbol	Camera Model
	VB-H47, VB-M46
	VB-S32VE
	VB-S32D
	VB-S820D, VB-S920F

■ Symbols Indicating Safety Precautions

This section explains the symbols used in this document. The following symbols indicate information for the safe use of the product as well as important and supplemental information the user should know. Be sure to read and understand this information when using the product.

Symbol	Meaning
 Warning	Failure to follow the instructions indicated by this symbol may result in death or serious injury. Be sure to follow these warnings to ensure safety.
 Caution	Failure to follow the instructions indicated by this symbol may result in injury or property damage. Be sure to follow these precautions to ensure safety.
 Important	Cautions and restrictions. Make sure to read these carefully.
 Notes	Supplementary descriptions and reference information.

Chapter

1



Before Use

Camera functions and the software to be used, and the operating environment are explained in this chapter. It also describes the flow from preparation and setup through to actual use.

Functions of the Network Camera

A network camera not only enables to operate the camera, but also allows to record and upload the video, and perform monitoring using the various intelligent functions of the camera.

However, the functions that can be used differ depending on the model. Refer to the table below for the differences in functions depending on the model.

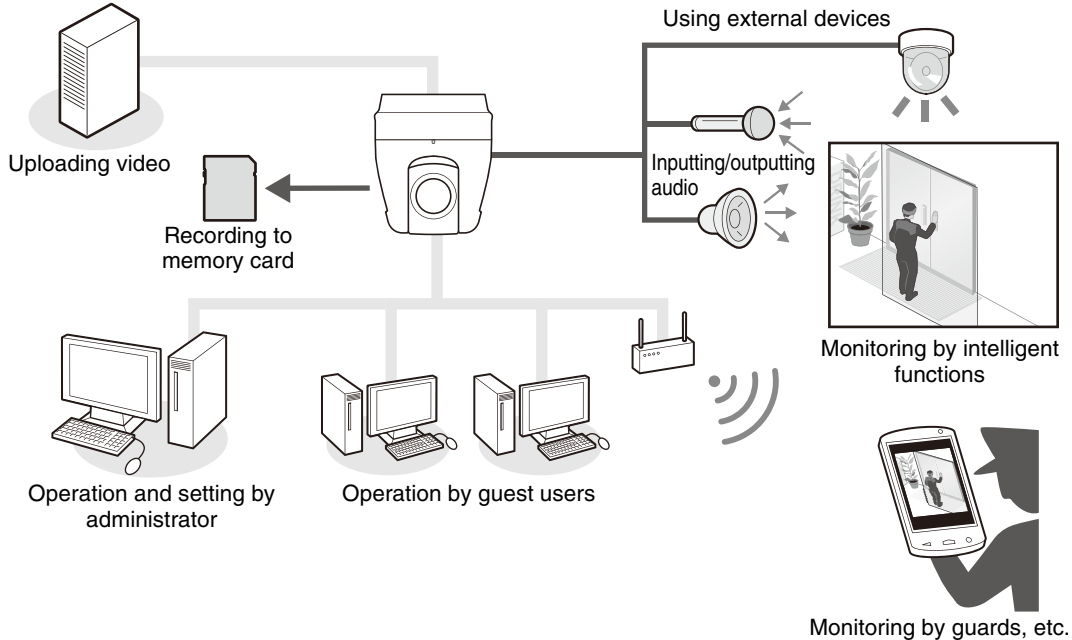

Table of Function Compatibility by Model

The functions for which availability differs depending on the model are shown below.

	HM4x	S32VE	S32D	S820D/S920F
Pan/Tilt/Zoom	✓	✓	✓	-
Audio Output Terminals	✓	✓	-	-
External Device Input Terminals	2	1	1	1
External Device Output Terminals	2	1	1	1
Rotate Video Display	-	-	-	✓
Focus	✓	✓	✓	-
Aperture	✓	-	-	-
Enhanced Digital Zoom	✓	-	-	-
Image Stabilizer	✓	-	-	-
Day/Night Mode Focus	✓	-	-	-
Panorama Creation	✓	✓	✓	-
View Restriction Setting	✓	✓	✓	-
Maximum Number of Registered Presets	64	64	64	20
Preset Tour	✓	-	-	✓
Event Triggered Preset Movement	✓	✓	✓	-
microSD/microSDHC/microSDXC Memory Cards* Supported	-	✓	✓	✓
SD/SDHC/SDXC Memory Cards* Supported	✓	-	-	-
Maximum Resolution 1920 x 1080	VB-H47, VB-S32VE, VB-S32D, VB-S820D, VB-S920F			
Maximum Resolution 1280 x 960	VB-M46			

* Memory card that can be used with cameras are referred to as "memory card" in this document.

Camera Software

The following software is available for efficiently configuring and operating the camera.

Camera Operations and Settings

Camera operations are performed using the Camera Viewer/Mobile Camera Viewer.
Camera settings are specified from the Settings page.

■ Camera Viewer (P. 26) /Mobile Camera Viewer

Controls the camera, and monitors video and various events.

There are two types of viewers; Camera Viewer (mainly for computers) and the Mobile Camera Viewer (mainly for devices with a screen size of 7 inches or less).

The functions available in the Viewer differ according to the user privilege (P. 28).



Note

- For details on how to use the Mobile Camera Viewer, refer to "Mobile Camera Viewer (Operation Guide)".

■ Settings Page (P. 52)

The Settings page is for the administrator to configure and manage the camera.

Software to Install on the Computer

The following software can be installed on the computer to be used.

■ Camera Management Tool

This tool is used for batch managing multiple cameras, from initial settings to performing maintenance. The Camera Management Tool can perform the following tasks.

- Detecting cameras
- Various camera settings
- Displaying the Viewer and the Settings page
- Updating firmware, back up/restoring settings, performing memory card and other operations, as well as camera maintenance.

For details on uses and functions, refer to "Camera Management Tool User Manual".

The Camera Management Tool can be installed from the installer.

Installer name: VBToolsInstall.exe

■ Recorded Video Utility

This utility is used for viewing and managing the videos recorded on the memory card mounted in the camera. The Recorded Video Utility enables to perform the following settings/operations on recorded videos.

- Displaying a list of videos
- Playing and deleting videos
- Downloading videos to a computer

For details on uses and functions, refer to "Recorded Video Utility User Manual".

The Recorded Video Utility can be installed from the installer.

Installer name: VBToolsInstall.exe

Additional Licenses (Sold Separately)

Purchase additional software and licenses as necessary.

■ H.264/H.265 Additional User License AUL-VB 2

Additional license for viewing H.264/H.265 video with multiple computers via the Viewer or Recorded Video Utility. Each camera includes one license. Additional licenses are necessary for multiple computers to view H.264/H.265 video from a single camera.

Operating Environment

For the latest information on this product (firmware and software, user manual, operating environment, etc.), refer to the Canon website.

Computer Environment Details

CPU (Recommended)	Intel Core i7-2600 or greater	
Graphics Board (Recommended)	Not specified	
Memory (Recommended)	2 GB or more	
Viewer Display (Recommended)	1920 x 1080 or higher	
OS and Compatible Web Browser	Windows 10 64-bit Windows 11 Windows Server 2019 Standard 64-bit Windows Server 2022 Standard 64-bit	Microsoft Edge Chrome
	– Must be configured to allow use of JavaScript, IFRAME (HTML tag), and Web Storage – For Camera Viewer only, cookies must be enabled	
Operating System Language	Settings Page, Camera Viewer, Mobile Camera Viewer: German/English/Spanish/French/Italian/Russian/Thai/Korean/ Chinese (Simplified) /Japanese	



Note

- For information on the operating environment of the Camera Management Tool, refer to “Camera Management Tool User Manual”.
- For information on the operating environment of the Recorded Video Utility, refer to “Recorded Video Utility User Manual”.

Verified Mobile Environment (Settings Page, Camera Viewer, Mobile Camera Viewer) – As of May, 2022

OS	Compatible Web Browser
Windows 10 Pro, Windows 11	Microsoft Edge 100
iOS 15, iPadOS 15	Safari*
Android 12	Chrome 100
– Must be configured to allow use of JavaScript and Web Storage – For Camera Viewer only, cookies must be enabled	

* Settings page and Camera Viewer are not supported for the iPhone.

Steps for Setting Up the Camera

Step 1 Preparing to Install the Camera

Make preparations to use the camera via a network.

Install the necessary software

→ “Installing Software” (P. 20)

Check/configure the computer and web browser security settings

→ “Checking Windows Settings” (P. 21)

Use the Camera Management Tool to configure initial camera settings.

→ “Configuring Initial Camera Settings” (P. 23)

Step 2 Installing the Camera

Install the camera to suit the environment that it will be used in.

→ “Installation Guide”

Step 3 Setting the Camera Angle

S820D/S920F

Set the camera angle on the Settings page while checking the video in the computer.

→ “Setting the Camera Angle” (P. 25)

Step 4 Using the Camera Viewers

Operate the camera while viewing the video in the Viewer.

→ “Camera Viewer” (P. 26)

Step 5 Adjusting Advanced Settings According to Its Use

Advanced settings can be made in the Settings page, such as for camera control and security, according to how the camera will be used.

Settings can also be made using the Camera Management Tool. For details, refer to “Camera Management Tool User Manual”.

→ “Settings Page” (P. 52)

Troubleshooting

For error messages or problems, refer to “Appendix” (P. 160).

The top portion of the page features a blue gradient background. In the upper right corner, there are several overlapping, semi-transparent images of camera lenses, creating a sense of depth and focus. The word "Chapter" is written in a white, sans-serif font on the left side. To its right, a large, white, stylized number "2" is prominently displayed, serving as the chapter identifier.

Chapter 2

Camera Setup

To prepare the camera for use, install the necessary software on the computer, and configure the initial settings for web browser security and the camera.

Installing Software

Install the necessary software.

Necessary Software

The following software is needed:

- Camera Management Tool
- Recorded Video Utility

Installation

■ Installation Methods

The software can be installed by [Easy Installation] that enables batch installation, or by [Custom Installation] that allows users to select the software.

■ Installing Software

1 Confirm that all other applications have been closed.

2 Double-click [VBToolsInstall.exe].



The installation screen is displayed.

Note

- If the [User Account Control] screen is displayed, click [Yes] or [Continue].

3 Select the installation method.

Select [Easy Installation] to install all the included software (Camera Management Tool and Recorded Video Utility).

Select [Custom Installation] to install software individually by selecting which software to be installed and how it is installed.

4 Follow the on-screen instructions, then click [Exit] or [Reboot] on the Installation Complete screen.

The Camera Management Tool icon and Recorded Video Utility icon will be displayed on the desktop.



Checking Windows Settings

Camera configuration and operation may be blocked, depending on the security functions of the operating system. Change or check the operating system settings beforehand.

Firewall Settings

To use the software on computers where Windows Firewall is enabled, it is necessary to add each software as an application allowed to communicate via the firewall.

Note

- Even if not performing the following steps, it is still possible to add each software as an allowed application with the [Windows Security Alert] dialog box that is displayed when the software is launched.

- 1** Click [System and Security] > [Windows Defender Firewall] in [Control Panel].
- 2** Click [Allow an app or feature through Windows Firewall].
- 3** Click [Change settings] > [Allow another app].
- 4** Select the software to use, such as [Camera Management Tool], and click [Add].

Settings When Using Windows Server

■ Adding the Camera IP Address as a Trusted Site

When the security level for internet sites and intranet sites is set to [High], it is necessary to add the IP address of the camera to the list of trusted sites.

Note

- Set the camera IP address with the Camera Management Tool. For details, refer to "Camera Management Tool User Manual".

- 1** Click [Network and Internet] > [Internet Options] in [Control Panel].
- 2** Click the [Security] tab.
- 3** Select [Trusted sites], then click [Sites].
The [Trusted sites] dialog box is displayed.
- 4** Enter the IP address of the camera under [Add this website to the zone], then click [Add].

Note

- Clear the [Require server verification (https:) for all sites in this zone] checkbox if it is selected.
The camera's IP address will be added to the [Websites] list.
- It is possible to add IP addresses for multiple cameras by using a wildcard (*) when entering the IP address.
For example, if "192.160.1.*" is entered, all cameras that share the "192.160.1" portion of the address will be added as trusted sites.

■ Sound Settings for Using the Audio Functions

In the initial setting of Windows Server, the sound function is disabled by default.

To use audio functions with the viewer, follow the steps below to enable the sound function.

- 1** Open [Control Panel] and click [Hardware and Sound].
- 2** Click [Sound].
The [Audio Service Not Running] dialog box is displayed.
- 3** Click [Yes].
The [Sound] dialog box is displayed.
- 4** Click the [Playback] tab to confirm that an audio device has been installed.
If no audio device is installed, refer to the computer manual for use.

Settings for the Environment Which Uses a Proxy Server

In the environment that uses a proxy server, the camera IP address needs to be specified as an exception.

- 1** Click [Network and Internet] > [Internet Options] in [Control Panel].
- 2** Click [Connections] tab > [LAN settings].
- 3** Click [Advanced] and enter the IP address in [Exceptions].

Configuring Initial Camera Settings

To use a camera, it is necessary to first set the administrator account for the camera, then configure the network settings, and afterwards connect the camera and computer via the network. Use the Camera Management Tool to configure these settings. The Camera Management Tool also enables multiple cameras to be configured at the same time. For information on how to use the Camera Management Tool, refer to the “Camera Management Tool User Manual”.

Flow of Configuration Using the Camera Management Tool

Launching the Camera Management Tool



Searching for Cameras

Search for cameras connected to the same network as the computer in which the Camera Management Tool is installed.



Registering the Administrator Account (Administrator Name and Administrator Password)



Configuring Initial Camera Settings

Configure the basic settings of the camera, such as the network settings and camera name.

Camera's Settings Page from the Web Browser

Able to access the camera by directly specifying the IP address from a web browser.

If there is an IP address assigned by the DHCP server, specify it, otherwise specify "192.168.100.1".

Important

- Able to access with the IP address of 192.168.100.1 approximately 30 seconds after connecting the camera to the network environment.
- If an IPv4 address is assigned by the DHCP server, it will switch to that address and access by 192.168.100.1 will not be possible.
- If there are devices with 192.168.100.1 on the same network, the same IP address will be assigned, and access to the camera with 192.168.100.1 will not be possible.

- 1** When accessing with 192.168.100.1, set the IP address of the computer.
Set the IP address of the computer to the same network as 192.168.100.1 such as 192.168.100.xxx.
- 2** Start the web browser.
- 3** Enter the camera's IP address in the address column of the web browser and press [Enter].
The [Default Settings (1/2)] screen of the camera is displayed.
- 4** Enter the administrator name and administrator password, and click [Apply].

After rebooting the camera, the [Default Settings (2/2)] screen is displayed.

5 Set each item of [Environment], [Network], and [Date and Time], then click [Apply] or [Apply and reboot].

The screenshot shows the 'Default Settings (2/2)' interface. At the top right, there are buttons for 'Reboot', 'Apply', and 'Clear'. The settings are organized into three sections: Environment, Network, and Date and Time.

Environment	
System Frequency (Hz)	60
WDR	Mild
Intelligent Function	Disable
Maximum Frame Rate (fps)	30

Network	
IPv4 Address Settings Method	Auto (DHCP)
IPv4 Address (DHCP)	
IPv4 Default Gateway Address (DHCP)	
Name Server Address 1	
Name Server Address 2	
Set Name Server Address Automatically	Use DHCP/DHCPv6
Name Server Address (DHCP)	
Name Server Address (DHCPv6)	

Date and Time	
Settings Method	Set manually
Date yyyy/mm/dd	
Time hh:mm:ss	
Time Zone	(GMT+09:00) Osaka, Sapporo, Tokyo
Daylight Saving Time	Disable

For the details about settings content, refer to the following items of the Settings page:

- [Maintenance] > [Environment] (P. 157)
- [System] > [Network] (P. 150)
- [System] > [Date and Time] (P. 147)

After the camera reboots, the Settings page is displayed and the settings can be configured.

After installing the camera, set the camera angle while checking the video displayed on the Settings page.

The camera angle settings are configured by accessing the following Settings page.

- [Video] > [Camera Angle] (P. 60)
- [System] > [System] > [Installation Conditions] > [Video Flip] (P. 144)



Important

- If the camera angle is changed after configuring the intelligent function, it is necessary to reconfigure it.
- If the [Video Flip] setting is changed after setting the preset, ADSR, privacy mask, or intelligent function, it is necessary to reset them.

Chapter 3

Camera Viewer

Use the web browser to access the Viewer in the camera to perform camera operations, display live video, and check the status of events.

Viewing Video with the Camera Viewer

Start the Camera Viewer to switch users and/or check/configure the camera status and the video display.

Note

- If opening another window or tab to access the camera while an authenticated web page is displayed, the authentication information of the displayed web page may be discarded.
In this case, enter the authentication information again.

Launching the Camera Viewer

Starting the Camera Viewer from the Settings Page

An administrator can start the Camera Viewer from the Settings page.

1 Open the Settings page (P. 53).

2 Click [Viewer].

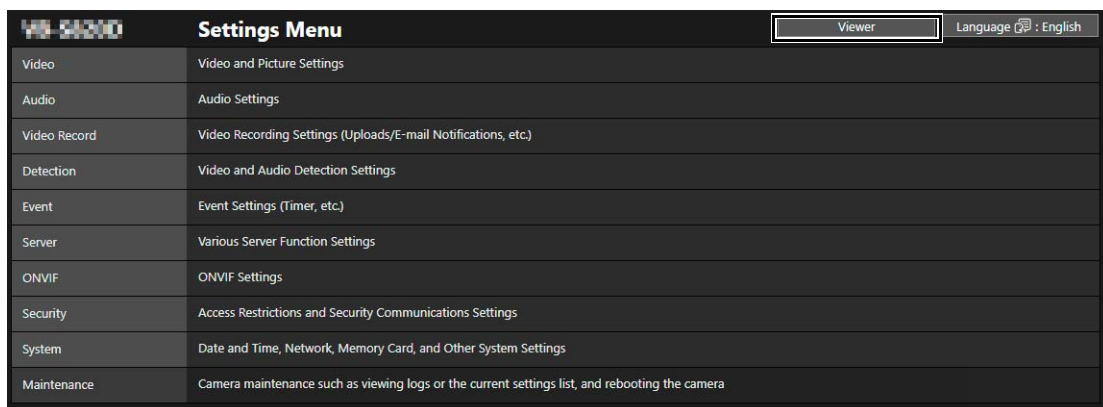

The Camera Viewer is displayed.

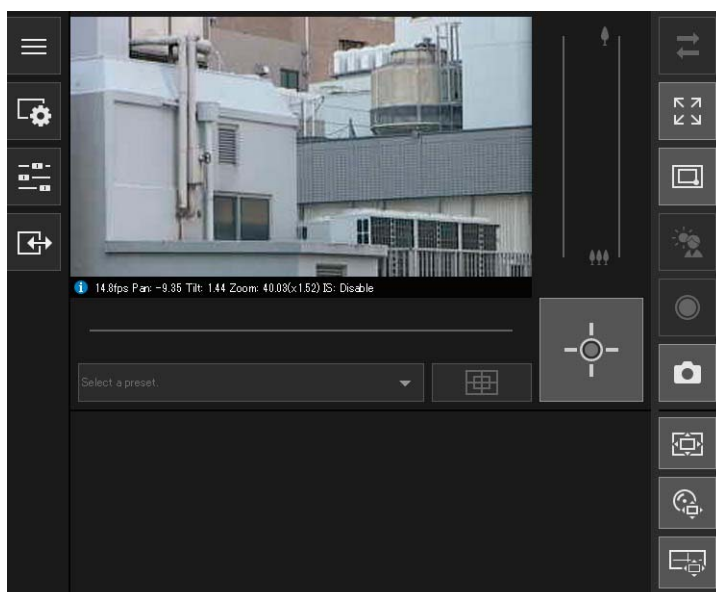

■ Starting the Camera Viewer Directly

Able to set [System] > [Viewer] > [General] > [Default Page] to [Display Viewer] in the Settings page to set the Viewer as the default page (P. 146).

1 Start the web browser.

2 Enter the IP address and click the Enter key.

The authentication screen for the Viewer is displayed.

3 Enter the administrator name and administrator password, and click [OK].

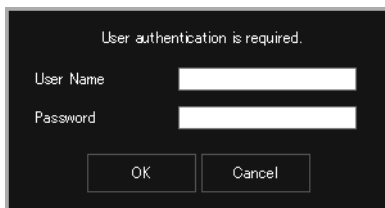

The Camera Viewer is displayed.

Camera Viewer Access Restrictions

Two types of users can be set; authorized users, which require user authentication, and guest users, that do not require authentication.

The functions that each user can use in the Camera Viewer depend on the privileges assigned to the user (P. 142).

Important

- Multiple administrator accounts cannot connect to a single camera at the same time. An authorized user or a guest user can connect to the camera from multiple computers at the same time. When controlling a camera, the authorized user who acquired the control privilege later will be given the priority. On the other hand, guest users are placed in a queue.

Note

- If [System] > [Viewer] > [Viewer Settings] > [User Authentication] is set to [Do not authenticate] on the Settings page, the authentication screen is not displayed when connecting to the Viewer, and the user is connected as a guest user. Guest users can only perform some operations with the Viewer, however it is possible to later switch users in order to use the Viewer as an administrator or authorized user. Click [Switch Users] to log into the Viewer again as an administrator or authorized user.







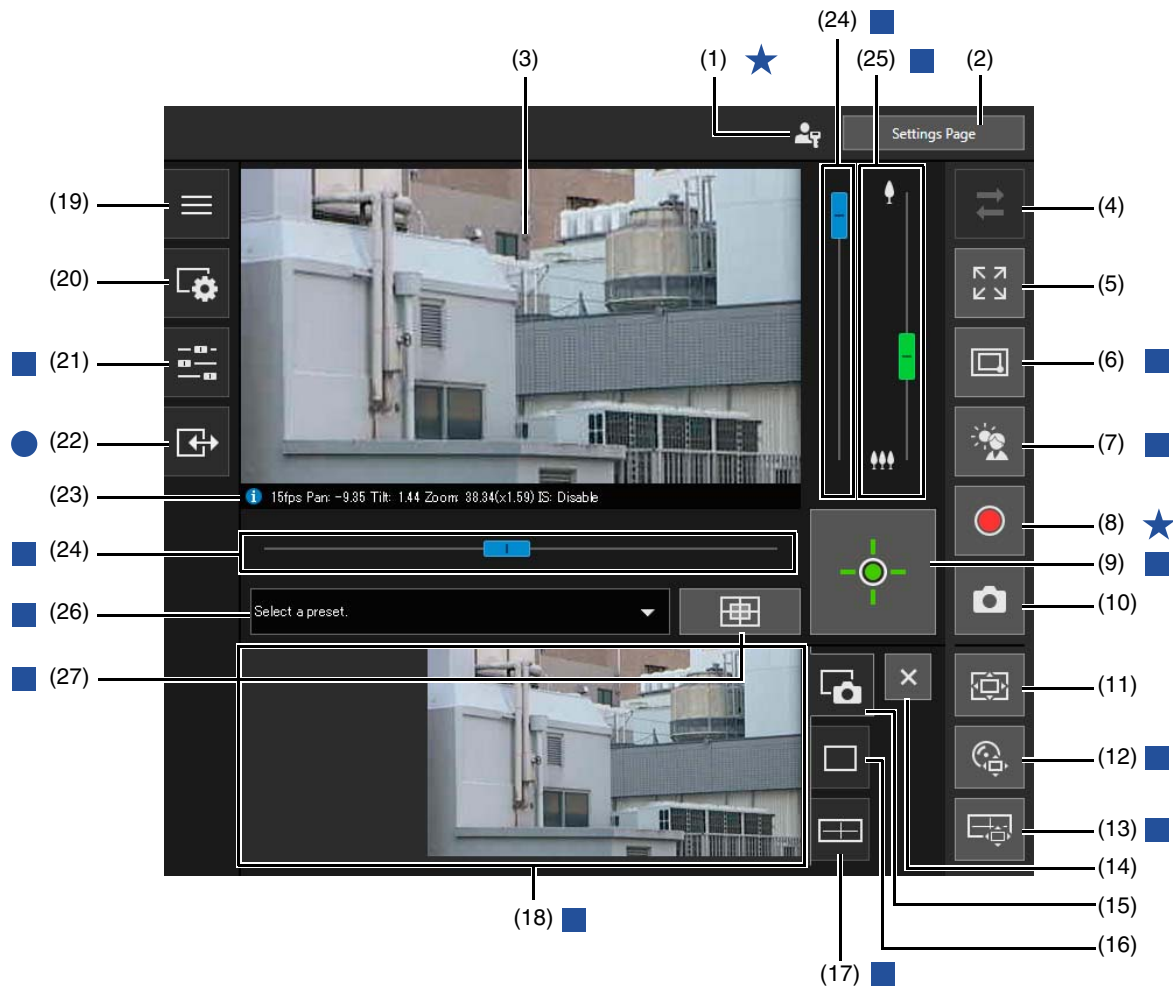



Camera Viewer Screen

The privileges required for operating the Viewer are indicated with the following symbols.



★	Administrator privileges
●	Privileged camera control or higher privileges
■	Camera control or higher privileges
No Symbol	Video distribution or higher privileges

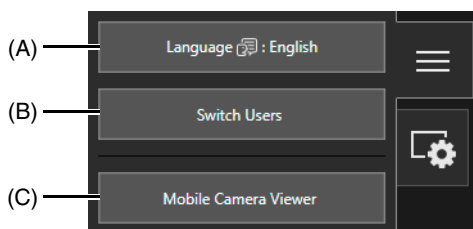

- (1) Administrator Icon
Appears when logged in as the administrator.
- (2) [Settings Page]
Displays the Settings page (P. 53).
- (3) Video Display Area
Displays video received from the camera.
- (4) [Reconnect] Button
Reconnects to the camera. It is possible to operate when the Viewer is not connected to the camera.
- (5) [Full Screen Mode] Button
Video display area is displayed in full screen mode (P. 33).
- (6) [Switch Area Zoom/Drag to Move] Button **HM4x S32VE S32D**
Switches the dragging operation in the video display area between Area Zoom and Drag to Move functions (P. 37).
- (7) [Back Light Compensation] Button
Turns on/off backlight compensation. This control is effective when the video is dark due to backlight (P. 40).

- (8)  **[Memory Card Recording] Button**
Starts/stops video recording to a memory card (P. 47).
- (9)  **[Obtain/Release Camera Control Privileges] Button**
Obtains/releases the camera control privileges (P. 35).
- (10)  **[Snapshot] Button**
The snapshot panel appears in the control display area and displays a still image of the moment when the button is clicked (P. 46).
- (11)  **[Viewer PTZ] Button**
Starts/stops the Viewer PTZ. When started, the Viewer PTZ panel is shown in the control display area (P. 42).
- (12)  **[Digital PTZ] Button**
Starts/stops the Digital PTZ. When started, the Digital PTZ panel is shown in the control display area (P. 44).
- (13)  **[Panorama Display] Button** **HM4x S32VE S32D**
Displays the panorama display panel in the control display area (P. 39).
- (14)  **[Close] Button**
Closes the panels shown in the control display area.
- (15)  **Snapshot Tab**
Click this to switch the control display area to the snapshot panel (P. 46).
- (16)  **Viewer PTZ/Digital PTZ Tab**
Click this to switch the control display area to the Viewer PTZ/Digital PTZ panel (P. 42).
- (17)  **Panorama Display Tab** **HM4x S32VE S32D**
Click this to switch the control display area to the panorama display panel (P. 39).
- (18) **Control Display Area**
Click (15), (16), or (17) to display the snapshot panel, Viewer PTZ/Digital PTZ panel, or panorama display panel.
- (19)  **[Main] Menu**
Switches the language or user, and moves to the Settings page or Mobile Camera Viewer.



- (A) **[Language] Button**
Switches the display language.
- (B) **[Switch Users]**
Use this to log in as an administrator or authorized user.
- (C) **[Mobile Camera Viewer]**
Switches the connection to the Mobile Camera Viewer. For details on how to use the Mobile Camera Viewer, refer to “Mobile Camera Viewer Operation Guide”.
- (20)  **[Video and Audio Menu]**
Configures the video display size and audio transmission/reception of the Viewer. Privileges that can be operated vary depending on the function. For details, refer to “Changing the Reception Video Size and Display Screen Size” (P. 32) and “Receiving/Transmitting Audio” (P. 48).
- (21)  **[Camera Operation Menu]**
Use this button to perform pan, tilt, and zoom operations of the camera (P. 38). Video adjustments are enabled, such as focus, exposure, and Day/Night mode switching (P. 39).
- (22)  **[Event and Input/Output Menu]**
Able to check the output operations and input status of an external device, the detection status of the intelligent function and the status of linked events (P. 50).

(23) Information Display

Information, such as the frame rate, camera pan/tilt/zoom values and descriptions of each function, is shown in the Information Display.

Warning and error messages will also be displayed here if there are problems with camera operations or systems.

For details on the information displayed, refer to "List of Viewer Messages" (P. 179).



Important HM4x

- When [Video] > [Picture (Option)] > [Camera Control] > [Image Stabilizer] (P. 75) on the Settings page is set to on, the actual angle of view of the video will be smaller than the zoom values shown in the Information Display.

(24) Pan/Tilt Slider

Drag the slider to pan (horizontally) or tilt (vertically) the camera (P. 36).

(25) Zoom Slider

Drag the slider to operate the zoom in (telephoto)/zoom out (wide-angle) function of the camera (P. 36).

(26) Preset Selection Menu



Selects a preset registered in the camera in advance (P. 41).

(27) [Home Position] Button

Moves the camera angle to the home position (P. 41).



Note

- The (4)  [Reconnect] button, (19)  [Main] Menu, and (23) Information Display are available even if all authorized user and guest user privileges are disabled on the Settings page.

Changing the Reception Video Size and Display Screen Size

It is possible to set the size and format of the video received from the camera and the size of the display screen on the computer.

Changing the Reception Video Size/Format and Display Screen Size

Open the  [Video and Audio Menu] and configure the video received from the camera. This requires video distribution or higher privileges.

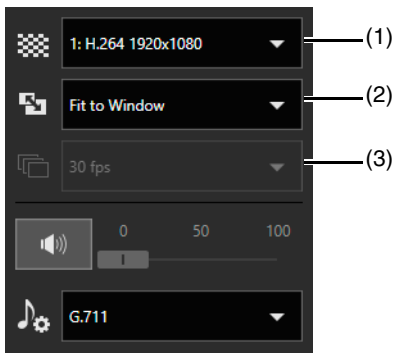

(1) Video Size Setting

Select the size and format of video received from the camera.

Select which stream to receive among video streams set in [Video] > [Video] (P. 58) on the Settings page.

1 to 4 corresponds to video stream 1 to 4, and 5 is displayed during digital PTZ operation.

Important

- Additional user licenses are required to receive H.264/H.265 video on multiple computers (P. 16).
- Unable to display H.265 video when connected by HTTP.
- If a web browser that cannot display H. 264/H. 265 video is used, video cannot be displayed for video streams 1 and 2.
- When the video format is H.264, the video is displayed on the camera viewer with a delay compared with other formats. However, setting a larger video size or a higher video quality may reduce the delay.

(2) Display Size Setting

Select the video display size for the screen.

The size that users can set varies depending on the settings of each video stream in [Video] > [Video] on the Settings page (P. 58).

Note

- [Actual Pixels] displays the video at the size at which it is being captured.
- [Fit to Window] displays the video at the maximum size possible in the web browser window.

(3) Maximum Frame Rate (JPEG)

Able to select the maximum frame rate for JPEG video. It requires camera control or higher privileges.

This cannot be set when displaying H.264/H.265 video in the video display area.

Displaying in Full Screen Mode

The video display area is displayed in full screen mode by clicking the  [Full Screen Mode] button in the upper right of the Viewer.

Menus

When displayed in the full screen mode, the menu panels required for controlling the camera are displayed on the bottom of the screen, as well as on the Camera Viewer screen.

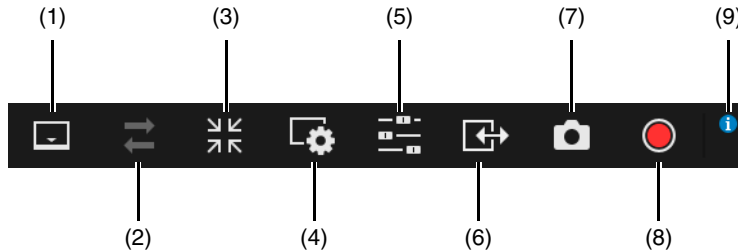

(1) [Menu Bar] Button

Switches between displaying and hiding the menu bar.

(2) [Reconnect] Button (P. 29)

(3) [Exit Full Screen Display] Button

Returns the video display area to the regular view.

(4) [Video and Audio Menu] Button (P. 32, P. 48)

(5) [Camera Operation Menu] Button

Switches the display/non display of the camera operation menu. For [Day/Night], privileged camera control or higher privilege is required. For other items, camera control or higher privileges is required.

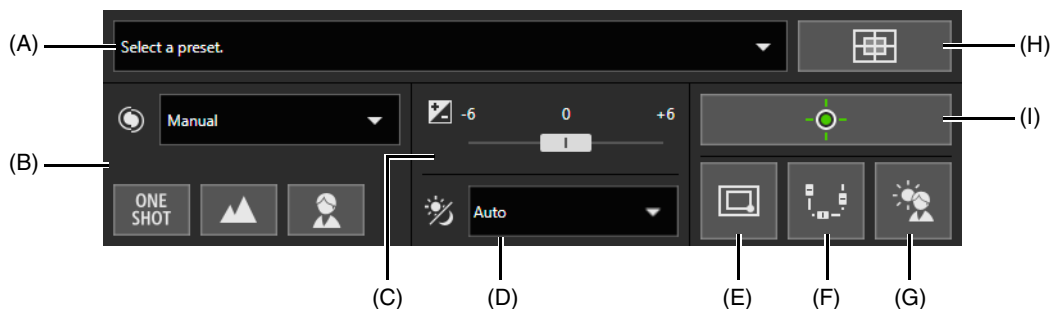

(A) Preset Selection Menu (P. 41)

(B) Focus **HM4x S32VE S32D** (P. 40)

(C) Exposure Compensation (P. 40)

(D) Day/Night (P. 40)

(E)  /  Switch Area Zoom/Drag to Move **HM4x S32VE S32D** (P. 37)

(F) Pan/Tilt/Zoom

Turn on this button (purple) to display the pan/tilt/zoom sliders on the screen, and operation of the sliders will be enabled.

The pan slider is displayed on the bottom of the screen, the tilt slider on the left edge of the screen, and the zoom slider on the right edge of the screen.

(G) [Back Light Compensation] (P. 40)

(H) [Home Position] (P. 41)

(I) Obtain/Release Camera Control Privileges (P. 35)

Note

- (B) Focus, (C) Exposure Compensation, and (D) Day/Night items are displayed when [System] > [Viewer] > [In-Viewer Picture Adjustment] (P. 146) on the Settings page is set to [Allow].

- (6) [Event and Input/Output Menu] Button
Switches the display/non display of the camera operation menu (P. 50).
- (7) [Snapshot] (P. 46)
- (8) [Memory Card Recording] (P. 47)
- (9) Information Display (P. 31)

Operating the Camera

This section describes the operations and settings required for using the camera, such as obtaining camera control privileges, setting the angle and focus.

Important

- For the operation or settings of the camera described in this section, camera control or higher privileges are required. Also, it is necessary to obtain the camera control privileges, which is explained first.

Obtaining Camera Control Privileges





To operate the camera, it is necessary to obtain control privileges from the Viewer.

In the status the user has not yet obtained camera control privileges, click the  [Obtain/Release Camera Control Privileges] button.

Control privileges are obtained and will enable the use of each button on the Viewer.

■ Camera Control Privilege Status Indicator

Depending on the camera control privilege status, the [Obtain/Release Camera Control Privileges] button appearance changes as follows.

Appearance	Control Privilege Status	Explanation
	Control privileges not obtained	Camera control privileges have not been obtained.
	Waiting for control privileges	When a guest user is waiting to obtain camera control privileges, the remaining time is counted down.
	Control privileges obtained	Camera control privileges have been obtained.
	Control privileges obtained (remaining control time)	After a guest user has obtained camera control privileges, the time that the user can retain control privileges in priority over other guest users is counted down.

Important

- Multiple users cannot obtain control privileges simultaneously.
- The [Obtain/Release Camera Control Privileges] button is displayed for authorized users and guest users if [Camera Control] is selected in [System] > [User Management] > [User Authority] on the Settings page.
- Administrators can take away camera control privileges from authorized users or guest users. Authorized users can also take away camera control privileges from guest users.
A user with higher privileges can possess the camera control privileges, during which time a user with lower privileges cannot obtain camera control privileges. Once finished viewing, the user should always exit the Viewer or click the [Obtain/Release Camera Control Privileges] button to release the control privileges.

Using Pan/Tilt/Zoom

Set the camera angle by panning, tilting and zooming the camera.

Important S32VE S32D

- The camera is designed to last for a total of 50,000 pan/tilt reciprocating operations. For example, the camera will last for approximately six years if it performs 25 reciprocating operations per day. If the durability limit for pan/tilt operations is exceeded, the camera may not be able to perform focus and zoom operations correctly.

Note

- Camera operations using clicking and dragging, do not offer a high precision control of the camera.
- The administrator can operate the camera regardless of view restrictions. Authorized or guest users can only operate the camera within the view restriction. HM4x S32VE S32D

■ Clicking on the Video Display Area or Using the Sliders

Moving by Clicking on the Video Display Area

If clicking in the video display area, the camera angle will move so that the clicked mouse pointer location will become the center. If the camera angle does not center on the desired location with a single click, repeat the operation.

Note

- Click operations are not available in the video display area while using the Viewer PTZ or Digital PTZ. HM4x S32VE S32D
- Click operations in the video display area become available after starting the Viewer PTZ or Digital PTZ. S820D/S920F

Moving Using the Sliders

Drag the pan and tilt sliders to pan and tilt the camera.
Drag the zoom slider to zoom the camera.
The slider can also move by clicking directly on the slider bar.

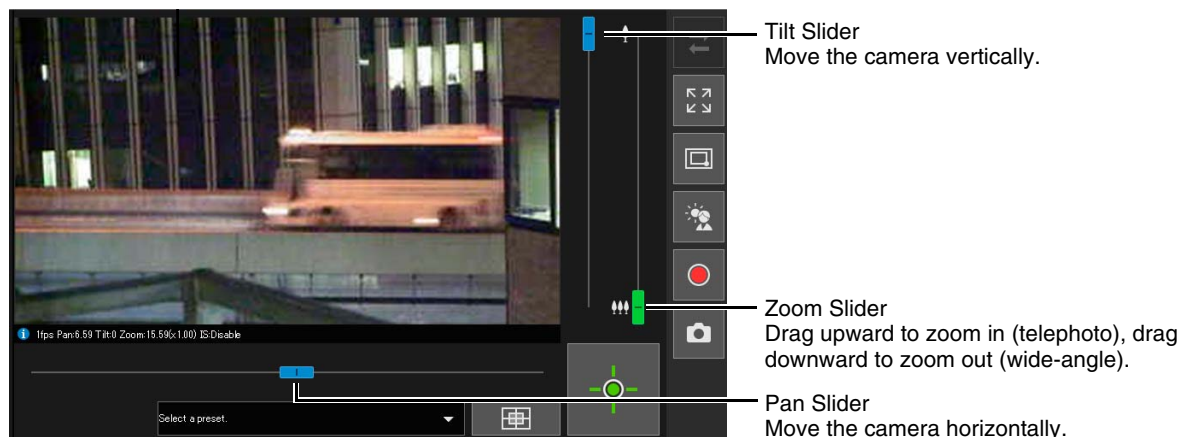

Note S820D/S920F

- Slider operations cannot be performed unless the Viewer PTZ or Digital PTZ is started.

Sliders Used for Digital Zoom and Enhanced Digital Zoom HM4x S32VE S32D

If [Video] > [Picture (Option)] > [Camera Control] > [Digital Zoom] is set to [Enable] on the Settings page (P. 75), the digital zoom range (orange) will be displayed on the zoom slider and digital zoom operation becomes available. Also, if [Video] > [Picture (Option)] > [Camera Control] > [Enhanced Digital Zoom] is set to [Enable] on the Settings page (P. 75), the enhanced digital zoom range (blue) is displayed on the zoom slider and enhanced digital zoom operation becomes available.

Enhanced digital zoom performs digital zooming according to the received video size, within a range where image quality roughness is not apparent.

The models that can be used with digital zoom and enhanced digital zoom with are indicated below.

- Digital Zoom **HM4x** **S32VE** **S32D**
- Enhanced Digital Zoom **HM4x**

Note

- Enhanced digital zoom or digital zoom cannot be operated when using digital PTZ function.
- The zoom magnification for enhanced digital zoom is limited to the video size set by the user with camera control privileges. Since other users also use digital zoom with the same zoom ratio, video deterioration may occur, depending on the received video size.
- If performing a zoom in operation that passes the telephoto end of the enhanced digital zoom area when both the digital zoom area and enhanced digital zoom area exist, the camera temporarily stops at the telephoto end of the enhanced digital zoom area.
- The zoom ratio (digital zoom ratio) is shown in the information display.
- With digital zoom, image quality is reduced as the zoom ratio increases.

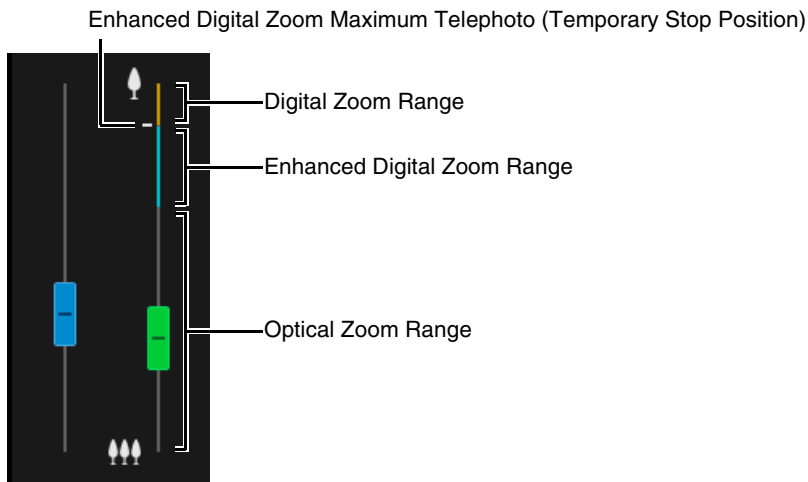

Using Area Zoom/Drag to Move

HM4x **S32VE** **S32D**

Able to zoom in and out, and change the camera angle by dragging in the video display area.

Note

- Not able to use Area Zoom or Drag to Move when using Viewer PTZ or Digital PTZ.

Using Area Zoom to Zoom In and Out

1 Click the / [Switch Area Zoom/Drag to Move] button to enter (Area Zoom) mode.

2 Drag out a frame in the video display area.

For zooming in, drag left-to-right to define the area to zoom in with a frame.

For zooming out, drag out a frame right-to-left.

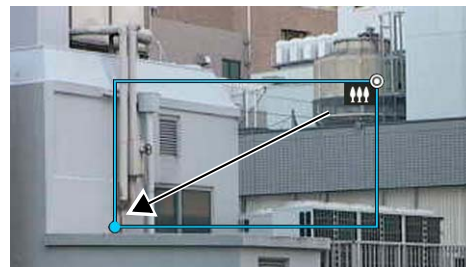
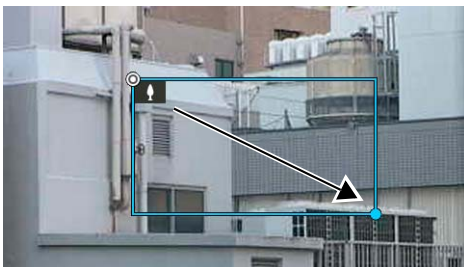

When operating in Area Zoom mode, an icon (zoom in: ; zoom out:) is displayed in the frame.



To stop Area Zoom, click the right button of the mouse with the left button held down while the frame is displayed.

3 Release the mouse button.

When dragged left-to-right, the framed area fills the entire video display area.

When dragged right-to-left, the camera will zoom out positioning the center of the frame on the center of the video display area.

Using Drag to Move to Change the Camera Angle

1 Click the  /  [Switch Area Zoom/Drag to Move] button to switch to  (Drag to Move) mode.

2 In the video display area, drag in the expected direction to move the camera angle, which will be displayed as an arrow.

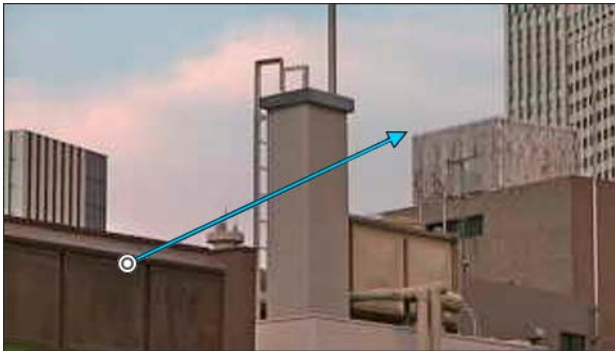

The camera angle will move in the direction of the arrow.

The maximum length of the arrow is half the width and height of the video display area, and movement speed increases the longer the length of the arrow becomes.

Note

- When using Drag to Move, the pan/tilt sliders will not move.

3 Release the mouse button.

The camera will stop.

Using [Pan/Tilt/Zoom] in the [Camera Operation Menu]

HM4x S32VE S32D

Open the  [Camera Operation Menu] and perform camera pan, tilt, and zoom operations.

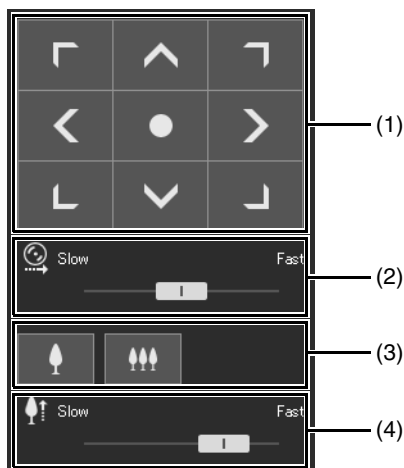

(1) [Pan/Tilt]



The camera angle will move in the direction of each arrow. Movement will continue while holding the button down, and stop when released.

Click the center button to move the camera angle to the midpoint of the pan/tilt operation range. However, if a view restriction is set (P. 86) and the midpoint is outside the restrict view area, the camera angle moves to the edge of the restrict view area.

(2) **Pan/Tilt Speed**

Set the operation speed by the [Pan/Tilt] button.

(3) **[Zoom]**

Click the  (Zoom in) and  (Zoom out) buttons. Movement will continue while holding the button down, and stop when released.

(4) **Zoom Speed**

Set the operation speed by the [Zoom] button.

 **Note**

- Even if the pan/tilt speed or zoom speed settings are changed, the speed of pan/tilt/zoom operations on the slider or panorama does not change.

■ Operating the Camera with the Panorama Display Panel

HM4x S32VE S32D

Able to operate the camera by using the frame in the panorama display area.

To display a panorama image in the panorama display panel, it is necessary to create the panorama image and save it to the camera (P. 89).

1 Click the  [Panorama Display] button.

The panorama display panel is shown in the control display area.

2 Use the frame in the panorama display panel to pan/tilt/zoom the camera.

The frame indicates the area being captured by the current camera.

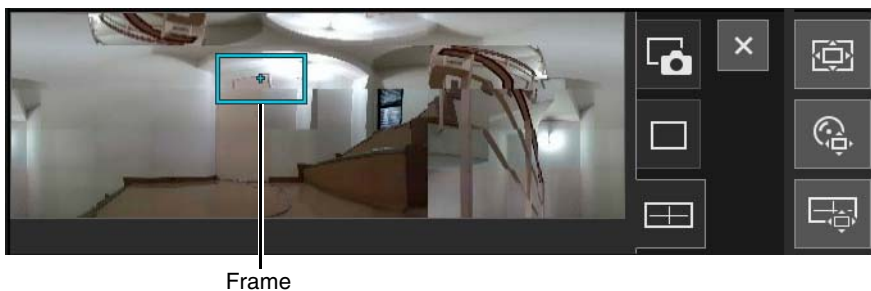

Move or Zoom by Dragging

Click inside the frame and drag it to pan and tilt the camera.

If outside the frame is clicked or dragged, a new frame will be drawn. The camera will pan/tilt/zoom to capture the area in the frame.

If an edge of the frame is dragged to change its size, the camera will zoom in or out to capture the area in the frame.

Move by Clicking

If outside the frame is clicked, the frame will move and center on that point, panning and tilting the camera.

Adjusting Video

Open the  [Camera Operation Menu] to operate focus, exposure compensation and day/night function.

 **Note**

- Focus, Exposure Compensation, and Day/Night items are displayed when [System] > [Viewer] > [In-Viewer Picture Adjustment] (P. 146) on the Settings page is set to [Allow].

■ Focusing

Focus on the subject.

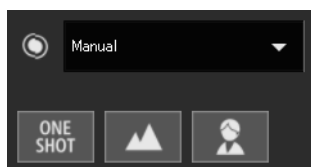

[Auto]

Automatically adjusts the focus.

[Manual]

Click and hold the  (Near) and  (Far) buttons to adjust the focus in the near and far directions.

Clicking the  [One-shot AF] button automatically adjusts the focus once.

[Fixed at infinity]

Moves the focus position to near infinity.

If more precise focusing is needed, select [Manual] and adjust the focus.



Note

- For cautions on using Focus, refer to the “Important” section on P. 66.

■ Setting the Exposure Compensation

Adjust the brightness of the video.

Move the slider to a negative value to make the video darker or a positive value to make the video brighter.

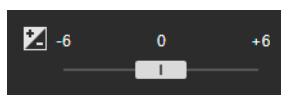

Important

- Cannot be set when [Exposure] is set to [Manual] on the Settings page (P. 63).

■ Switching Day/Night

Set the shooting mode according to the brightness of the installation environment of the camera.



For details on this function, refer to [Day/Night] on the Settings page (P. 65).



Important

- Privileged camera control or higher privilege is required.
- For cautions on using Day/Night, refer to the “Important” section on P. 66.

Using Backlight Compensation

Click  [Back Light Compensation] to brighten video that is dark due to backlight.

The [Back Light Compensation] button becomes active (purple) while backlight compensation is being performed.

Click the button again to cancel backlight compensation.



Important

- The [Back Light Compensation] button is disabled if [Exposure] is set to [Manual] on the Settings page.

Note

- If blown highlights in bright areas are of a concern, set the [Use WDR] on the Settings page to [Enable] (P. 62).

Using Presets or the Home Position

It is possible to control the camera using a preset or home position registered to the camera in advance.

When clicking the preset selection menu and selecting a preset from the list that is displayed, the camera will be set to the registered setting of the selected preset.

Clicking the  [Home Position] button will set the camera angle to the registered setting of the home position.

Important S820D/S920F

- H.265 video cannot be displayed while the Viewer is connected via HTTP. If H.265 is specified as the video compression method of the digital PTZ, the preset registered with the digital PTZ position cannot be selected.

Note

- Register preset/home positions in advance in [Video] > [Preset] > [Register Preset] (P. 69) on the Settings page. The registered preset is displayed in the preset selection menu.

Viewer PTZ and Digital PTZ

Viewer PTZ and Digital PTZ are both functions which allow easy panning, tilting and zooming using the digital zoom. The following differences exist:

Viewer PTZ	Digital PTZ
Enlarges the specified part of the video transmitted from the camera and then displays it in the viewer.	Transmits only the cropped part of the entire area that can be captured by the camera.
The size of the received data is large.	The size of the received data is small.
Camera control privilege is not required.	Camera control privilege is required.
PTZ operation can be performed independently for each Viewer.	Independent operation cannot be performed by each Viewer. (If multiple Viewers are connected, the same Digital PTZ display is applied to the other Viewers.)

Magnifying and Displaying a Part of Video (Viewer PTZ)

Use the Viewer PTZ to magnify part of a video (using digital zoom) without moving the camera. Since the camera's pan, tilt, or zoom functions are not used, it is useful when the camera position should not be changed, such as when using of the intelligent function.



Important HM4x S32VE S32D

- It is not possible to perform camera operations by clicking/dragging in the video display area while using the Viewer PTZ.



Note

- It is not possible to record the video magnified with the Viewer PTZ.
- Able to display the magnified video in full screen mode when using the Viewer PTZ.

1 Click the [Viewer PTZ] button.

The [Viewer PTZ] button turns active (purple), and the Viewer PTZ panel is shown in the control display area. Initially, the preview frame (Blue Frame) surrounds the entire video.

2 In the Viewer PTZ panel, drag the frame of the preview frame to make it smaller.

The video of the area inside the preview frame is magnified to fill the video display area.

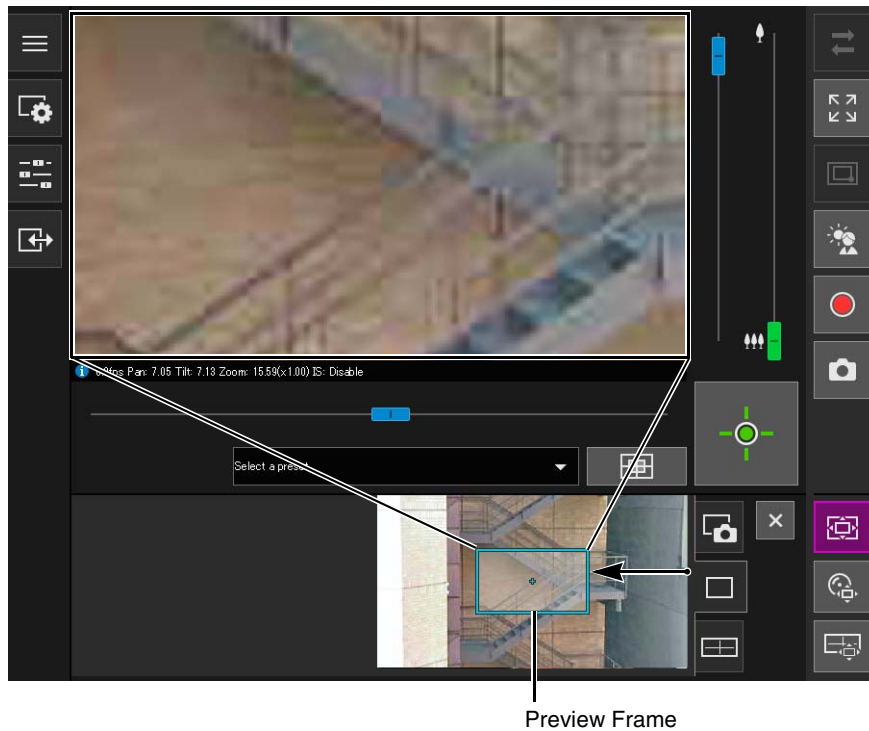

3 Move the frame to the area expected to magnify, and resize the frame as desired.

Move or Resize by Dragging

The preview frame moves by pressing the mouse button inside the frame and dragging it.

If the mouse button is pressed and dragged outside the frame, a new preview frame will be drawn.

By dragging the frame to change the size of the preview frame, the image will be magnified or reduced.

Move by Clicking

If the outside the frame is clicked, the preview frame will move and center on that point.

Using the Sliders to Move/Resize **S820D/S920F**

Able to move the preview frame by operating the pan and tilt sliders in the video display area. Able to resize the preview frame by operating the zoom slider.

Note

- The Viewer PTZ uses digital zoom, so the higher the digital zoom ratio, the lower the quality of the video.

Exiting Viewer PTZ

By the following operations, it is possible to exit the Viewer PTZ.

- Click the [Viewer PTZ] button to disable it.
- Click the [Digital PTZ] button to start the Digital PTZ.



Note

- Even performing the following operations, the magnified view on the video display area will be retained so long as the [Viewer PTZ] button is active (purple) and the Viewer PTZ is not closed.
 - Click the [Close] button on the control display area to close the Viewer PTZ panel.
 - Click the snapshot tab or panorama display tab (**HM4x S32VE S32D**) to switch the panel in the control display area.

Cropping and Displaying Part of the Video (Digital PTZ)

Able to crop and display part of a camera video in the video display area by using the Digital PTZ panel.

Note

- Digital PTZ can be operated only in the optical zoom area. Click the  [Digital PTZ] button to hide the digital zoom and enhanced digital zoom area. When zoom slider knob is in the digital zoom or enhanced digital zoom area, starting a digital PTZ moves the knob position to the optical zoom area. **HM4x S32VE S32D**
-  [Digital PTZ] cannot be clicked depending on the setting of [Video] > [Video] > [Digital PTZ] > [Video Compression Method] on the Settings page or the Viewer's environment.
 - When [Video Compression Method] is set to H.265 and the Viewer is connected via HTTP.
 - When [Video Compression Method] is H.264 or H.265 and using a web browser that cannot display H.264/H.265 video.

Cropping Video With Digital PTZ Panel

1 Click the [Digital PTZ] button.

The [Digital PTZ] button turns active (purple), and the Digital PTZ panel is shown in the control display area.

2 In the Digital PTZ panel, move and resize the preview frame.

The preview frame operations are the same as with the Viewer PTZ (P. 43).

Note

- The entire gray frame displayed on the digital PTZ panel corresponds to the entire image that can be taken.
- The preview frame will move in steps. Fine-tuned movement is not possible.

The video of the area inside the manipulated preview frame is magnified to fill the video display area.

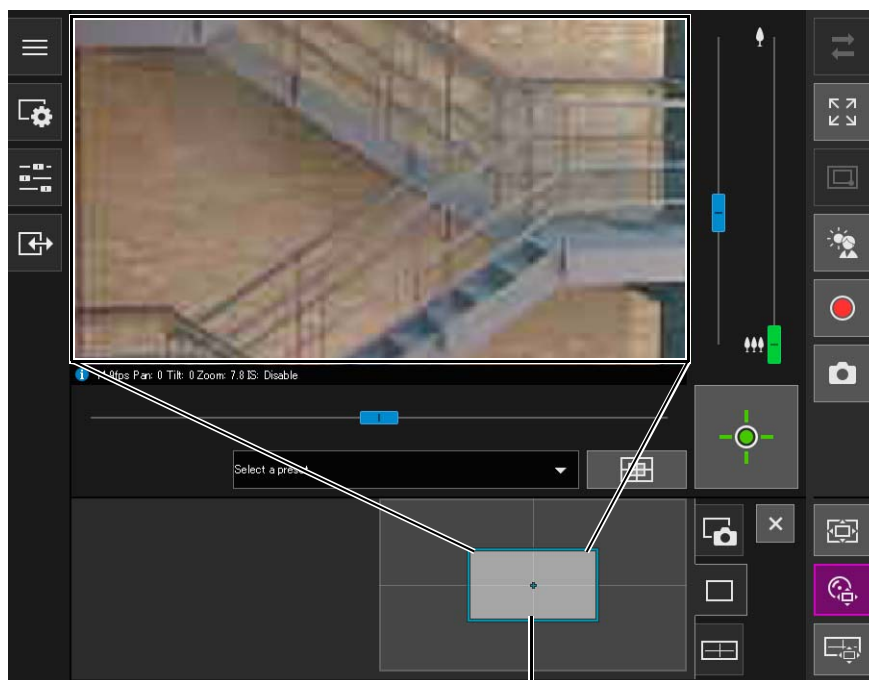

Important **HM4x S32VE S32D**

- Even if the camera angle is changed due to a slider operation or preset, the position of the preview frame on the Digital PTZ panel is fixed.

Note

- For the Digital PTZ, the higher the magnification ratio, the lower the image quality.

Using Presets or the Home Position S820D/S920F

Able to use a registered preset or home position to specify the range for Digital PTZ.

When a preset is selected, the preview frame on the Digital PTZ panel moves to the preset position, and the video inside the frame is shown in the video display area.



Note

- Register presets in advance in [Video] > [Preset] > [Register Preset] on the Settings page (P. 69).

Exiting Digital PTZ

To exit the Digital PTZ, perform one of the following operations.

- Click the [Digital PTZ] button to disable the Digital PTZ.
- Click the [Viewer PTZ] button to start the Viewer PTZ.



Note

- Even performing the following operations, so long as the [Digital PTZ] button is active (purple) the Digital PTZ continues without being closed.
 - Click the [Close] button on the control display area to close the Digital PTZ panel.
 - Click the snapshot tab or panorama display tab (HM4x S32VE S32D) to switch the panel in the control display area.

Saving Snapshots

Takes snapshots while checking the video in the video display area.

- 1 Click the  [Snapshot] button at the moment wanting to capture a still image.

The snapshot panel is opened in the control display area and the still image from the instant that the button was clicked is displayed.

If the [Snapshot] button is clicked again, the image displayed in the Snapshot panel will be updated.

- 2 To save the snapshot, right-click on the Snapshot panel.

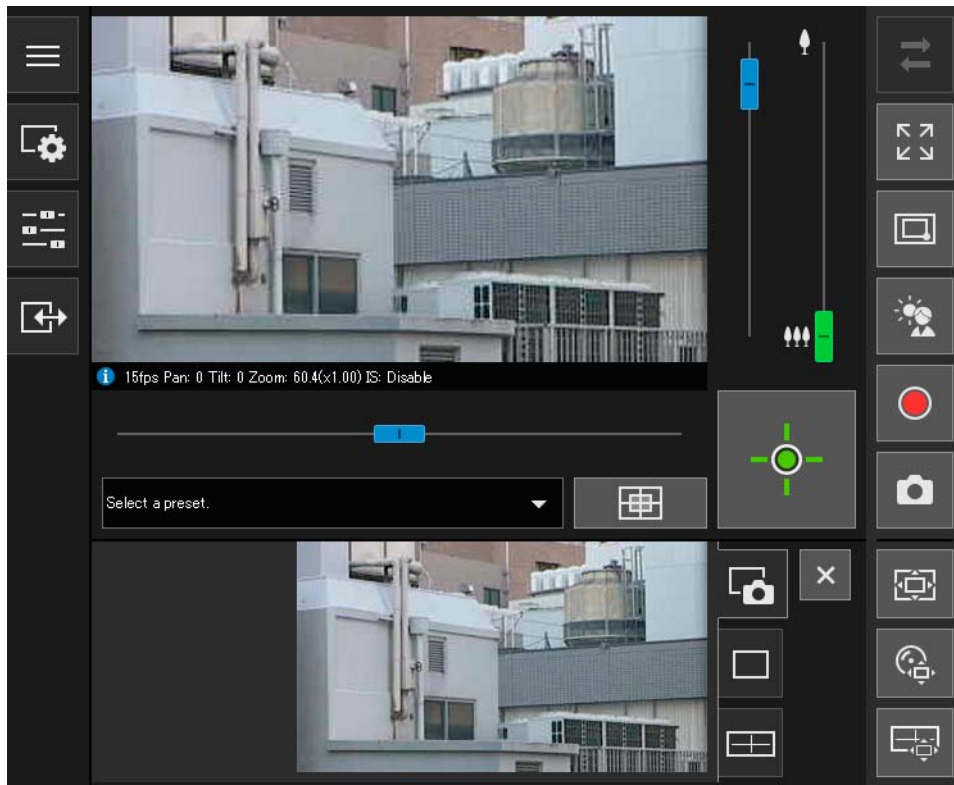

- 3 Click [Save picture as] in the menu that is displayed.

- 4 Enter the desired file name and save the snapshot.

Note

- Saving format for the snapshots will depend on the web browser used.
- The size of the saved snapshots are the same as the reception video size.

Recording Video to a Memory Card

Manually record video being shown in the video display area to a memory card inserted in the camera.

Note





- It is possible to record video manually if the following conditions have been met.
 - The memory card inserted in the camera is mounted.
 - [Operation Settings] is set to [Save Logs and Videos] in [Video Record] > [Memory Card Recording] > [Memory Card Operations] (P. 100) on the Settings page.
- Each video stream that is recorded on the memory card can be set in [Video Record] > [Memory Card Recording] > [Video Record Settings] > [Video Type] on the Settings page (P. 99).

Recording Videos Manually

1 If camera control privileges have not been obtained, click the  [Obtain/Release Camera Control Privileges] button to obtain the privileges.

2 Click the  [Memory Card Recording] button.

The display of the [Memory Card Recording] button will change during video recording.

-  Recording
-  Recording (while camera control privileges are not obtained)
-  Not recording (while camera control privileges are obtained)
-  Not recording (while camera control privileges are not obtained, or when no memory card is mounted to the camera)

3 To stop video recording, click the [Memory Card Recording] button again.

Important

- Video manually recorded to the memory card will automatically be terminated after 300 seconds of recording.
- When recording manually, do not change the settings in the [Settings Page]. Doing so may result in the termination of the manual recording.
- Recording will continue even if releasing the camera control privileges or disconnecting the camera while manually recording to the memory card.

Confirming Recorded Video

Use the Recorded Video Utility to check and playback the video manually recorded to a memory card. For details, refer to “Recorded Video Utility User Manual”.

Receiving/Transmitting Audio

Open the  [Video and Audio Menu] to set the audio reception from the camera, the audio transmission from the Viewer and the corresponding volumes.

Receiving Audio

Receive audio from the microphone and play it back in the Viewer. Administrator privilege or audio distribution privilege is required.

- 1 Select the compression method for audio data to be received in [Audio Compression Method] of  [Video and Audio Menu].

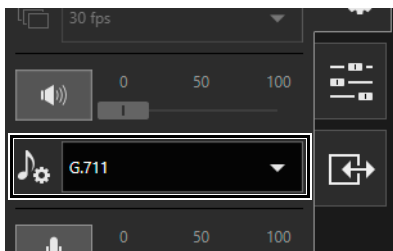

- 2 Click the  [Audio Reception] button.

Audio reception starts.

The [Audio Reception] button icon will change to active (purple) while receiving audio.

- 3 With the [Output Volume] slider, adjust the volume to an appropriate level.

Note

- To receive audio, it is required to connect the microphone to the camera (not needed for [S32VE](#)) and set [Audio Input] to [Enable] in [Audio] > [Audio] > [General Audio] (P. 92) and set [Audio Transmission from the Camera] to [Enable] in [Audio] > [Audio] > [Audio Server] (P. 93) on the Settings page.
- While the icon is active (purple), audio is constantly received even if the [Video and Audio Menu] is closed. However, even if the icon is active (purple), audio input from the microphone will not be received because there is no sound sent from the camera in the following cases.
 - While the administrator is transmitting audio when [Audio Communication Method] is set to [Half Duplex] in [Audio] > [Audio] > [General Audio] on the Settings page (P. 92) [HM4x](#) [S32VE](#)
 - While Camera's pan/tilt is being operated when [Mute During Pan/Tilt] is set to [Mute] in [Audio] > [Audio] > [General Audio] (P. 92) on the Settings page. [S32VE](#)
- During the audio reception, [Audio Compression Method] cannot be changed. Click the  [Audio Reception] button to temporarily stop receiving the audio.
- When using audio function with proxy server, it is required to select the [Use a proxy server for your LAN] checkbox in [Network and Internet] > [Internet options] > [Connections] tab > [LAN settings] > [Proxy server] in [Control Panel], then specify the camera IP address in [Advanced] > [Exceptions].

Able to transmit audio received from an external device connected to the computer to a speaker with an amplifier connected to the camera.

To transmit audio, it is required to connect using HTTPS with administrator privileges.

- 1 In the [Audio Transmission Time] in  [Video and Audio Menu], select the maximum audio transmission time.

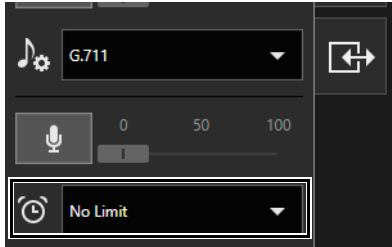

- 2 Click the  [Audio Transmission] button.

Audio transmission starts.

The [Audio Transmission] button icon will change to active (purple) while transmitting audio.

- 3 With the [Input Volume] slider, adjust the volume to an appropriate level.

Note

- To transmit audio, first set [Audio] > [Audio] > [Audio Server] > [Audio Reception from Viewer] to [Enable] on the Settings page (P. 94).
- While the icon is active (purple), audio is constantly transmitted even if the [Video and Audio Menu] is closed.
- If [Audio Communication Method] is set to [Half Duplex] in [Audio] > [Audio] > [General Audio] on the Settings page (P. 93), there is no sound sent from the camera to other users while the administrator is transmitting audio. Therefore, even if the  [Audio Reception] button (P. 48) is active (purple), audio input from the microphone cannot be received.
- When using audio function with proxy server, it is required to select the [Use a proxy server for your LAN] checkbox in [Network and Internet] > [Internet options] > [Connections] tab > [LAN settings] > [Proxy server] in [Control Panel], then specify the camera IP address in [Advanced] > [Exceptions].

Operating the External Device Output and Checking the Status of Event Detection

In the  [Event and Input/Output Menu], it is possible to operate the output of an external device and check the status of input of the external device, detection of intelligent functions, and occurrence of linked events.

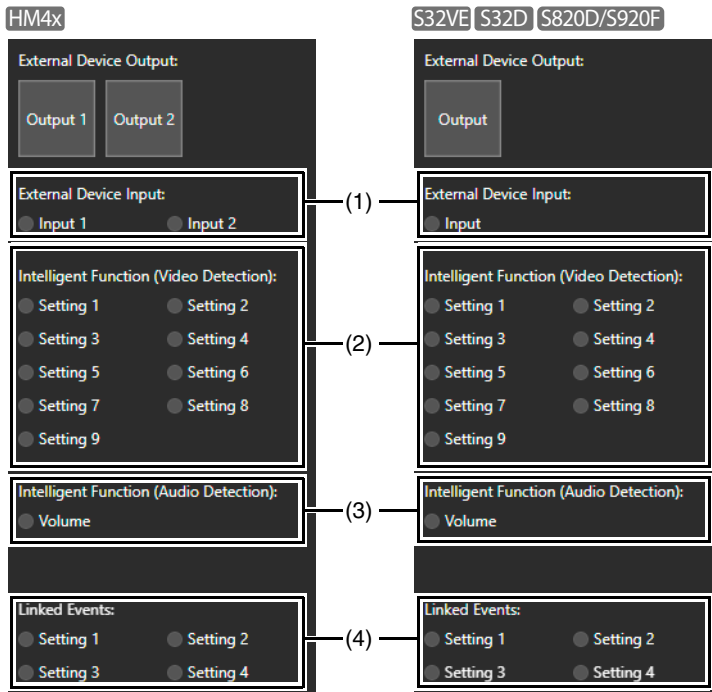

Operating External Device Output

Operate the output for the external device set in [Event] > [External Device] (P. 121) on the Settings page. Click the icon to switch between the active (purple)/inactive (gray) status.

Note

- To perform the external device output operation, it is necessary to obtain camera control privileges.

Checking the Status of Event Detection

- (1) [External Device Input]
Displays the input status of the external device set in [Event] > [External Device] (P. 122) on the Settings page. When a contact input signal is received from an external device, input will be activated and the icon becomes green.
- (2) [Intelligent Function (Video Detection)]
The status of video detection set in the video detection in [Detection] > [Intelligent Function] (P. 110) is displayed for each detection setting number. When the detection settings configured in Intelligent Function (Moving Object Detection, Abandoned Object Detection, Removed Object Detection, Camera Tampering Detection, Passing Detection, or Intrusion Detection) are triggered, the corresponding icon will turn green. If a name is entered for detection settings name (P. 116) in [Detection] > [Intelligent Function] on the Settings page, that name is displayed in [Setting 1] to [Setting 15].

Note

- The icon indicating the detection status will be displayed for a maximum of five minutes (except for Moving Object Detection).
- (3) [Intelligent Function (Audio Detection)]
Displays the status of [Volume Detection] set in [Detection] > [Audio Detection] (P. 104) on the Settings page. If detection is triggered, the icon will turn green.

(4) **[Linked Events]**

Displays the status of linked events set in [Event] > [Linked Event] (P. 127) on the Settings page. If a linked event is triggered, the icon will turn green.

Chapter 4

Settings Page

The Settings page enables to configure all the settings required for using the camera. Configure the settings on the Settings page according to the usage of the camera before starting the camera operation. The Settings pages also provides menus to be performed during the operation, such as camera maintenance.

How to Use the Settings Page

This section describes how to display the Settings page, and common operations to each Settings page.

Note

- The Settings page can only be operated by administrators.
- Use the Camera Management Tool in advance to configure the administrator account and network settings.

Accessing the Settings Page

Directly enter the IP address set with the Camera Management Tool into a web browser to display the Settings page of the camera.

Note

- The Settings page can also be accessed from the Camera Management Tool. For details, refer to “Camera Management Tool User Manual”.

- 1** Start the web browser.
- 2** Enter the IP address, and press the Enter key.
The user authentication window is displayed.
- 3** Enter the administrator name and administrator password, and click [Sign in].

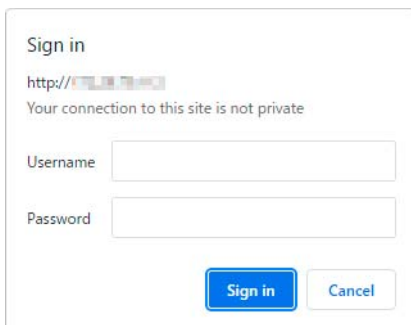

The Settings menu is displayed.

Important

- If an administrator and authorized user(s) share and use a Viewer on the same computer, it is strongly recommend not to save the password on a web browser.

Note

- The Viewer is displayed when [System] > [Viewer] > [General] > [Default Page] is set to [Display Viewer] in the Settings menu (P. 146).

■ Settings Menu

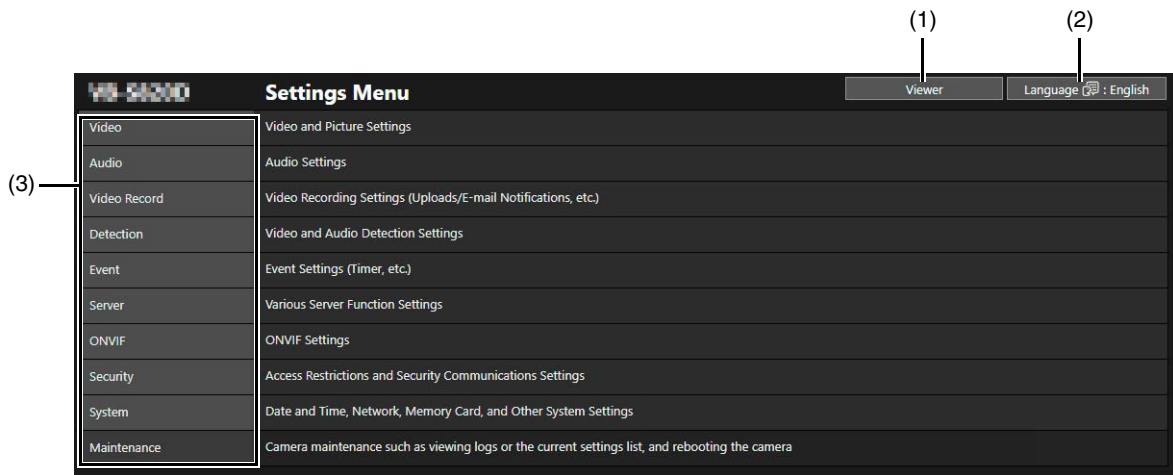

- (1) **[Viewer] Button**
Start the Camera Viewer (P. 27).
- (2) **Language Switch Button**
Set the language to be displayed on the screen.
- (3) **Settings Menu**
Click to display the detailed items. Click each item to navigate to its Settings page (P. 56).



Important

- If opening another window or tab to access the camera while an authenticated web page is displayed, the authentication information of the displayed web page may be discarded. In this case, enter the authentication information again.
- To ensure security, exit the web browser after completing settings on the Settings page and after using the Camera Viewer.
- Do not open multiple Settings pages at one time to change the settings of a single camera.

Common Settings Page Operations

This section describes the basic operation of the Settings page, and common operations to each Settings page.



Note

- If the setting that does not display the dialog in the web browser is enabled, it may not be possible to operate the Settings page. If this happens, exit the web browser and launch it again.

■ Applying Changes to the Settings

If the settings are changed on the Settings page, the [Apply] and [Clear] buttons on the upper right or lower right of the screen are no longer grayed out and can be clicked.



Click [Apply] in this state to apply the changed settings.
Click [Clear] to revert to the previous settings.

■ Setting Changes that Require Restarting

Setting items that require the camera to be restarted in order to apply the changed settings are indicated with an orange [Reboot] symbol to their right.



When an item indicated with a [Reboot] symbol is changed, [Apply] displayed at the upper right and lower right of each Settings page changes to [Apply and reboot].

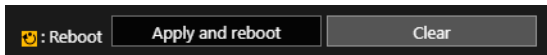

Click [Apply and reboot] to apply the changed settings and reboot the camera.
Click [Clear] to revert to the previous settings.

Important

- Changed settings will be lost if the page is navigated to another Settings page without clicking [Apply] or [Apply and reboot]. Be sure to click [Apply] or [Apply and reboot] to apply the changed settings.

Return to the Settings Menu

Click [Settings Menu] at the upper right of each Settings page to return to the settings menu.



Important

- Do not use the [Back] or [Forward] buttons in the web browser to navigate the Settings page. The changed settings may revert to the original settings or unintended setting changes may be applied.

Help

Click [Help] at the beginning of any setting item to display a detailed explanation of that setting item.

Setting Ranges and Limits of the Number of Characters

For settings where numerical values or characters are to be entered, the setting range or limits of the number of characters will be displayed.

Enter the settings within the displayed ranges.



Operating the Video Display Area

Configure settings in some Settings pages using the video display area.

Note

- The displayed items changes depending on the Settings page.
- Other users cannot access the Viewer while video is being displayed on the Settings page. Also, video cannot be displayed or configured while the administrator is connected to the Viewer.



(1) **Video Display Area**

Camera video is displayed here. Use the mouse to set the areas, etc. The operations on the video display area are the same as in the Viewer (P. 36).

HM4x S32VE S32D

The following operations can be performed while the cursor is [+] in the video display area depending on the Settings pages.

- Centering the camera angle to the clicked position (P. 36)
- Area zoom operations (P. 37)

(2) **Pan/Tilt Slider**

Pan and tilt operations in the video display area are the same as in the Viewer (P. 36).

(3) **Zoom Slider**

Zoom operations in the video display area are the same as in the Viewer (P. 36).

(4) **[Screen resize] Button**

The size of the video display area is switched between large and small each time this button is clicked.

(5) **[Switch Mouse Operation] Button** HM4x S32VE S32D

Click the button to center the camera angle to the position clicked in the video display area while the button is purple.

(6) **Panorama Screen/Full-View Screen**

Displays the full range of motion of the camera. Setting of areas, etc. can be made using mouse operations on the panorama screen depending on the Settings pages.

HM4x S32VE S32D

If a panorama image is registered in the camera (P. 89), the panorama image is displayed.

(7) **[Reconnect] Button**

Reconnects to the camera. Use this button when not connected to the camera.

(8) **[Snapshot] Button**

Opens the snapshot window and displays a still image of the moment the button is clicked (P. 46).

(9) **[Obtain/Release Camera Control Privileges] Button**

Obtains or releases the camera control privileges (P. 35).

Each Settings Page

Items in each Settings page are summarized as follows:

Category	Item	Description
Video	Video	General settings of the video, such as video size and quality distributed from the camera (P. 58)
	Camera Angle	Setting the Camera Angle (P. 60)
	Preset	Registering a series of settings as presets (P. 61)
	Preset Tour	Settings for automatically touring multiple presets registered in advance (P. 71)
	Picture (Option)	Settings for Camera Control and Day/Night (P. 75)
	ADSR	Setting ADSR (Area-specific Data Size Reduction) (P. 78)
	On-screen display	Displaying the date and time, camera name and any string of characters on the Video (P. 80)
	Privacy Mask	Setting the mask on the area not to be shown in the camera video (P. 82)
	View restriction	Setting the range that the camera can capture (P. 85)
	Panorama	Creation and management of panorama images (P. 89)
Audio	Audio	Settings for audio input from the microphone, audio output from the Viewer and playback of a sound clip (P. 92)

Category	Item	Description
Video Record	Upload	Settings for uploading video via FTP or HTTP when an event is triggered (P. 95)
	Memory Card Recording	Settings for recording video to a memory card when an event is triggered (P. 99)
	E-mail Notification	Settings for sending an e-mail notification to a specified recipient when an event is triggered (P. 102)
Detection	Audio Detection	Detecting changes in audio input from the microphone, which triggers operations such as video recording or e-mail notification (P. 104)
	Intelligent Function	Settings for the intelligent functions such as moving object detection, camera tampering detection, and intrusion detection (P. 106)
Event	External Device	Settings for external device output and operations triggered by external device input events (P. 121)
	Timer	Settings for timer events for performing operations such as video recording or e-mail notification at regular intervals (P. 124)
	Switch Day/Night	Moving the camera angle to preset positions when Day Mode and Night Mode are switched (P. 126)
	Linked Event	Settings for combining two types of events into occurring as a single event (P. 127)
Server	Server	Settings for the HTTP server and SNMP server (P. 131)
	Video Server	Settings for clients which can be connected to the Video server (P. 133)
	RTP Server	Settings for streaming using RTP (P. 134)
ONVIF	ONVIF	Settings for WS-Security time checking and Media Profile (P. 136)
Security	Certificate Management	Settings for certificate creation and management (P. 137)
	SSL/TLS	Settings for encrypted communications and server certificate (P. 139)
	802.1X	Settings for 802.1X authentication, authentication status display, and certificate management (P. 140)
	User Management	Adding/deleting administrator account information and/or authorized users, and setting operation privileges (P. 141)
	Host Access Restrictions	Settings for individual access control for access from IPv4 and IPv6 addresses (P. 143)
System	System	Settings for camera name and external input/output device name, and for camera operation and installation (P. 144)
	Viewer	Settings for startup, authentication, and display of the Viewer (P. 146)
	Date and Time	Settings for camera date and time (P. 147)
	Memory Card	Memory card operations such as mounting/unmounting, formatting execution, etc. (P. 149)
	Network	Setting the network to which the camera is connected (P. 150).
Maintenance	General	Performing verification of device information and license, and reboot and/or initialization of the cameras (P. 153)
	Backup / Restore	Performing backup and restore (P. 155)
	Update Firmware	Performing firmware update (P. 156)
	Environment	Settings for the system frequency, WDR, intelligent function, and displaying maximum frame rate (P. 157)
	Log	Settings for log display and log notification (P. 158)

[Video] > [Video]

This section provides a general description of the video, including video size and quality of each stream delivered from the camera.

Settings are made for each of the following five streams.

- Stream 1
- Stream 2
- Stream 3
- Stream 4
- Digital PTZ

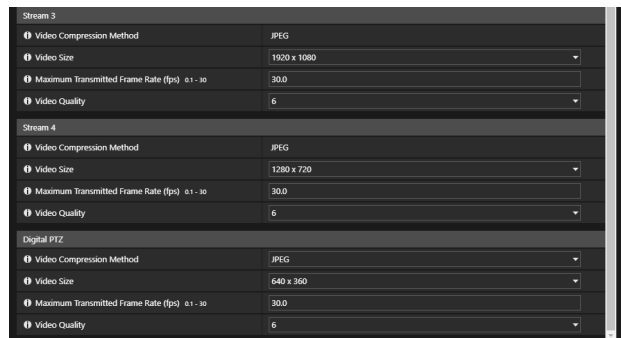
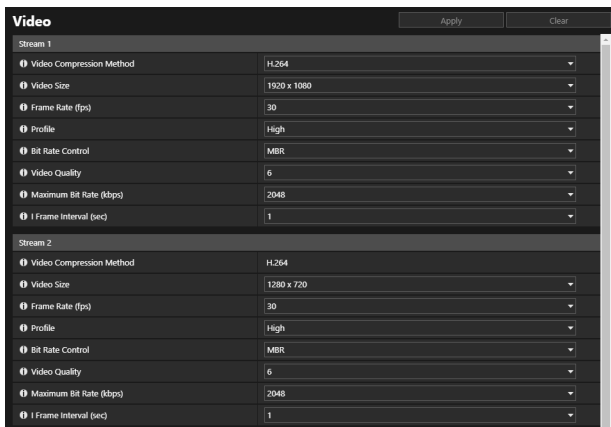

Important

- Ensure that the total frame rate of streams for transmission does not exceed 60 fps (at system frequency 60 Hz) or 50 fps (at system frequency 50 Hz).
- If the video size, video quality and bit rate are set higher, or if a large number of clients access simultaneously, the network load may increase and the video frame rate may decrease.
- The data size may increase depending on the type or movement of the subject. If the frame rate remains low or other undesirable conditions continue for a long time, lower the video size or quality setting.
- In case of H.264/H.265 video, block noise may be noticeable if the video size is set larger and the bit rate is set lower.

Stream 1, Stream 2

Settings for H.264/H.265 video transmitted from the camera.

[Video Compression Method]

Select the video codec type.

The settings in Stream 1 are also reflected in Stream 2.

[Video Size]

Select a video size.

[1920x1080] cannot be set for Stream 2.

[Frame Rate (fps)]

Select the video frame rate. The choices depend on the settings in [Maintenance] > [Environment].

Important HM4x S820D/S920F

- 60 fps (at system frequency 60 Hz) or 50 fps (at system frequency 50 Hz) can be selected only for Stream 1. In addition, all of the following conditions must be met.
 - Both [WDR] and [Intelligent Function] in [Maintenance] > [Environment] are set to [Disable].
 - [Video Record] > [Memory Card Recording] > [Operation Settings] is set to [Save Log].
 - [Upload] is set to [Upload Disabled], when [Video Record Action] is set to [Upload] in [Video Record] > [Upload].

[Profile]

Select a video profile when [Video Compression Method] is set to [H. 264].

[Bit Rate Control]

Set the video bit rate.

- When [VBR] is selected, the set [Video Quality] is retained and the bit rate varies depending on the video.
- When [MBR] is selected, the set [Video Quality] is retained and the bit rate varies depending on the video. However, only when the set [Maximum Bit Rate (kbps)] is going to be exceeded, the [Video Quality] adjusts so that it does not exceed the set value.
- When [CBR] is selected, adjusts the bit rate by changing the [Video Quality], aiming at the set [Target Bit Rate (kbps)].

[Video Quality]

Select the video quality if [Bit Rate Control] is set to [VBR] or [MBR].

The higher the value, the higher the image quality becomes.

[Maximum Bit Rate (kbps)]

Select the maximum bit rate if [Bit Rate Control] is set to [MBR].

[Target Bit Rate (kbps)]

Select the target bit rate if [Bit Rate Control] is set to [CBR].

[I Frame Interval (sec)]

Select the interval (sec) for inserting I frames.



Important

- When Stream 1 or Stream 2 video is used for memory card recording or uploading, the following restrictions apply to the setting.
 - [Bit Rate Control]: Only [MBR] or [CBR]
 - [Maximum Bit Rate (kbps)], [Target Bit Rate (kbps)]: [8192] or less
 - [I Frame Interval (sec)]: Either [0.5], [1], or [1.5]

Stream 3, Stream 4

Settings for the quality and video size of the JPEG video delivered from the cameras.

[Video Size]

Select the default video size delivered from the camera when no video size has been specified by the Viewer.

[1920x1080] cannot be set for Stream 4.

[Maximum Transmitted Frame Rate (fps)]

Limit the maximum frame rate per second for transmission to reduce the viewer load. Up to 30 frames per second can be set.

[Video Quality]

Select the quality of the video delivered from the camera.

The higher the value, the higher the image quality becomes.

Digital PTZ

In addition to stream 1 to 4, it is possible to set another video stream. Use this for capturing and delivering part of the video.

[Video Compression Method]

Select the type of video compression method.

It is possible to select either video CODEC or JPEG set for Stream 1.

[Video Size]

Select a video size.

[Frame Rate (fps)], [Profile], [Bit Rate Control], [Maximum Bit Rate (kbps)], [Target Bit Rate (kbps)],

[I Frame Interval (sec)]

The settings are the same as for Stream 1 and Stream 2.

[Maximum Transmitted Frame Rate (fps)], [Video Quality]

The settings are the same as for Stream 3 and Stream 4.

Set the camera angle by operating the zoom slider. Video cropped at the set camera angle will be delivered by Stream 1 to 4.

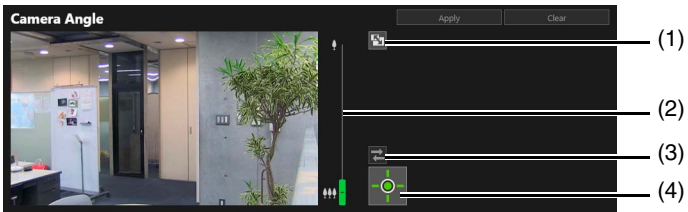

- (1) **[Screen resize] Button**
The size of the video display area is switched between large and small each time this button is clicked.
- (2) **Zoom Slider**
Drag the slider to operate the zoom in (telephoto)/zoom out (wide-angle) function of the camera.
- (3) **[Reconnect] Button**
Reconnects to the camera. Use this button when not connected to the camera.
- (4) **[Obtain/Release Camera Control Privileges] Button**
Obtains or releases the camera control privileges. To operate the zoom slider, it is necessary to obtain the control privileges. For details, refer to “Obtaining Camera Control Privileges” (P. 35).

[Video] > [Preset]

By registering the camera angle or exposure as home position or preset, it will be possible to easily call out the settings from the Viewer, etc.

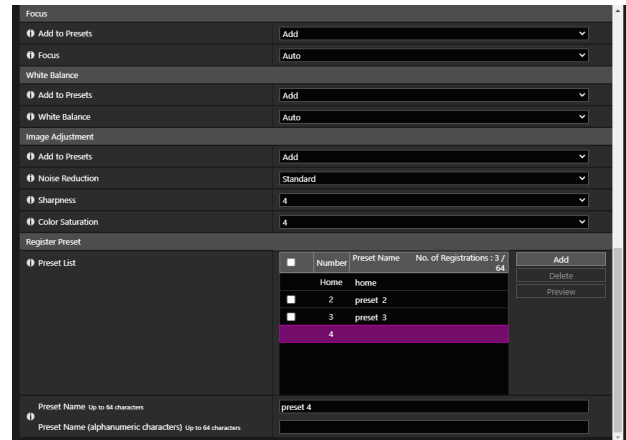
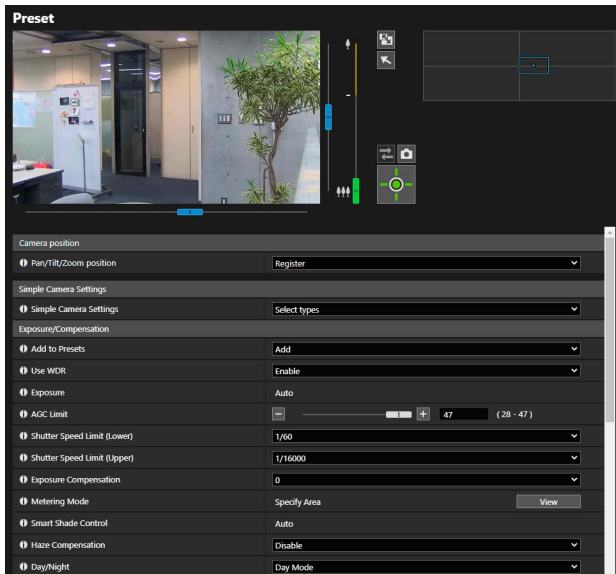

Camera Position

Setting the camera position to be registered as the preset.



Important HM4x S32VE S32D

- If zooming position is changed after configuring the intelligent function, privacy mask, preset, and ADSR, these settings must be configured again.

[Pan/Tilt/Zoom position] HM4x S32VE S32D

Register the current pan, tilt, and zoom positions as the preset. It is possible to perform pan, tilt, and zoom operations by operating the frame on the video display area or the panorama screen.

[Digital PTZ Position] S820D/S920F

Register the current digital PTZ position as the preset.

By selecting [Register], a yellow frame is displayed in the video display area. Operate the frame to specify the Digital PTZ cropping position for the preset.



Note

- The digital PTZ frame (yellow) for cropping at the preset is set in incremental sizes. The sizes that can be set are the same as the [Digital PTZ] of the Viewer (P. 44).

Simple Camera Settings

Sets the camera settings to be registered as the preset.

[Simple Camera Settings]

Recommended values for each item of [Exposure/Compensation] and [Image Adjustment] are displayed at the same time according to the selected type (The table below shows the items and values for which the recommended values change). When necessary, it is possible to change the recommended value for each item and click [Apply] to reflect it.

Type	Standard Settings	Motion Priority	Low Light Visibility	Data Size Reduction	Depth Priority HM4x
Use scene	Cancelling the scene settings to restore the factory default settings.	Suppressing blurring for moving subjects.	Brightening by raising the sensitivity for dark subjects.	Reducing the data size in lowlight conditions.	Focusing over a wide range, from near to far.
[Use WDR]	S32VE S32D S820D/S920F - HM4x Enable*	-	-	-	Disable
[Exposure]	Auto	Auto	Auto	Auto	Auto (Aperture-priority AE)
[AGC Limit]	HM4x S820D/S920F 47 S32VE S32D 36			HM4x S820D/S920F 32 S32VE S32D 28	47
[Shutter Speed Limit (Lower)]	1/60 (sec.)	HM4x 1/1000 (sec.) S32VE S32D S820D/S920F 1/250 (sec.)	HM4x S820D/S920F 1/8 (sec.) S32VE S32D 1/30 (sec.)		1/60 (sec.)
[Shutter Speed Limit (Upper)]	HM4x S820D/S920F S32VE S32D	1/16000 (sec.) 1/8000 (sec.)			1/16000 (sec.)
[Smart Shade Control]	Auto	-	Auto	-	-
[Noise Reduction]	Standard	Mild	Strong	Strong	Standard
[Sharpness]	4	4	4	3	6
[Color Saturation]	4	4	4	4	4

* Only when [Maintenance] > [Environment] > [WDR] is set to anything other than [Disable]

Important

- Note the following regarding [Simple Camera Settings].

[Motion Priority]

- Flickering may occur due to fluorescent lighting, etc.
- In low light conditions, the video may be darker or the noise may increase compared to [Standard Settings].

[Low Light Visibility]

- Residual images may appear for moving subjects in dark scenes.

[Data Size Reduction]

- Residual images may appear for moving subjects in dark scenes.

[Depth Priority] HM4x

- In low light conditions, the video may be darker or the noise may increase compared to [Standard Settings].

Exposure/Compensation

Settings for exposure and image compensation.

[Add to Presets]

When adding the settings for [Exposure/Compensation] to preset, select [Add].

[Use WDR]

Select whether to use the WDR function. Displayed when setting [Maintenance] > [Environment] > [WDR] to other than [Disable].

[Exposure]

Select the exposure mode.

Important

- When [Use WDR] is set to [Enable], fixed to [Auto].

Note

- When [Day/Night] is set to [Auto], set [Exposure] to one of the following [Auto], [Auto (Flickerless)], [Auto (Flickerless2)] (**S32VE S32D S820D/S920F**), [Auto (Shutter-priority AE)], or [Auto (Aperture-priority AE)] (**HM4x**).

[Auto]

Automatically controls the exposure.

[Auto (Flickerless)]

Automatically adjusts the shutter speed according to the brightness of the usage environment. Reduces unevenness in brightness on screens caused by fluorescent light, etc.

[Auto (Flickerless2)] **S32VE S32D S820D/S920F**

Use this mode if the desired reduction of unevenness in brightness cannot be obtained even after selecting [Auto (Flickerless)]. However, the appropriate exposure level may not be applied (causing excessive brightness) because the range of automatic shutter speed adjustment cannot exceed 1/100 sec. (when system frequency is 60 Hz) or 1/120 sec. (when system frequency is 50 Hz) seconds while using this mode.

Important

- Unstable light sources may still cause flickering on the screen, even if [Auto (Flickerless)] or [Auto (Flickerless2)] is selected.

[Auto (Shutter-priority AE)]

Automatically adjusts the aperture and gain according to the specified [Shutter Speed].

[Auto (Aperture-priority AE)] **HM4x**

Automatically adjusts the gain and shutter speed according to the specified [Aperture].

[Manual]

Manually set [Shutter Speed], [Aperture] (**HM4x**), and [Gain].

[AGC Limit]

Select the upper limit value of Auto Gain Control (AGC) for increasing gain to brighten video in low light conditions. The higher the value, the higher the sensitivity will become, but video noise will increase.

Important

- Minimum subject illumination may change when [AGC Limit] is set.

Note

- When [Use WDR] is set to [Enable], the values that can be set are limited.

[Shutter Speed Limit (Lower)]

If [Exposure] is set to one of the following [Auto], [Auto (Flickerless)], [Auto (Flickerless2)] (**S32VE S32D S820D/S920F**), or [Auto (Aperture-priority AE)] (**HM4x**), the lowest shutter speed can be selected.

Important

- When [Exposure] is set to [Auto (Flickerless)] or [Auto (Flickerless2)] (**S32VE S32D S820D/S920F**), a speed faster than 1/50 sec. (at system frequency 60 Hz) or 1/30 sec. (at system frequency 50 Hz) cannot be selected.

[Shutter Speed Limit (Upper)]

If [Exposure] is set to [Auto], [Auto (Flickerless)], or [Auto (Aperture-priority AE)] (**HM4x**), the highest shutter speed can be selected.

Important

- A speed slower than [Shutter Speed Limit (Lower)] cannot be selected.
- When [Exposure] is set to [Auto (Flickerless)], a speed slower than 1/100 sec. (at system frequency 60 Hz) or 1/120 sec. (at system frequency 50 Hz) cannot be selected.

[Shutter Speed]

If [Exposure] is set to [Auto (Shutter-priority AE)] or [Manual], the shutter speed can be fixed.

Important

- Setting a slow shutter speed may prevent the intelligent function from working correctly. Select a shutter speed that suits the scene to be captured and the purpose.

Note

- Slower shutter speeds generate residual images in video when capturing a moving subject.
- When capturing a moving subject, selecting a higher shutter speed can reduce blurry video capture.

[Aperture] HM4x

If [Auto (Aperture-priority AE)] or [Manual] is selected for [Exposure], set a desired aperture.

Moving the slider to the left closes the aperture and darkens the image. Moving the slider to the right opens the aperture and brightens the image.

[Gain]

If [Manual] is selected for [Exposure], set the sensitivity according to brightness.

Moving the slider to the left darkens the video, and moving it to the right brightens video.

[Exposure Compensation]

When [Exposure] is set to other than [Manual], the brightness of the video can be adjusted by selecting the exposure compensation value.

[Metering Mode]

When [Exposure] is set to other than [Manual], it is possible to select a metering mode.

Important

- When [Use WDR] is set to [Enable], fixed to [Specify Area].

[Center-Weighted]

Performs photometry with the entire screen center-weighted.

Even if there is a slight difference in light and dark around the screen, subjects near the center will have the appropriate exposure.

Use this when the subject is near the center of the screen.

[Average]

Performs photometry evenly on the entire screen.

This enables to obtain stable exposure even in shooting environments with large differences in light and dark on the screen.

Use this to stabilize the exposure for scenes when cars are passing or people are entering and exiting.

[Spot]

Performs photometry on the center of the screen.

This enables to obtain the appropriate exposure for subjects in the center of the screen, regardless of differences in light and dark around the screen.

Use this to adjust the exposure on the center of the screen when the subject is hit by spotlights or backlit.

[Specify Area]

Controls to achieve the optimal brightness in the specified area.

Frame's position and size displayed on the video display area can be set as desired.

Follow the steps below.

1. When [View] is clicked with the zoom at its widest angle, a frame appears in the video display area.
2. Set the frame to any area.
 - Drag inside the frame to move the area.
 - Drag the corner □ to change the size.

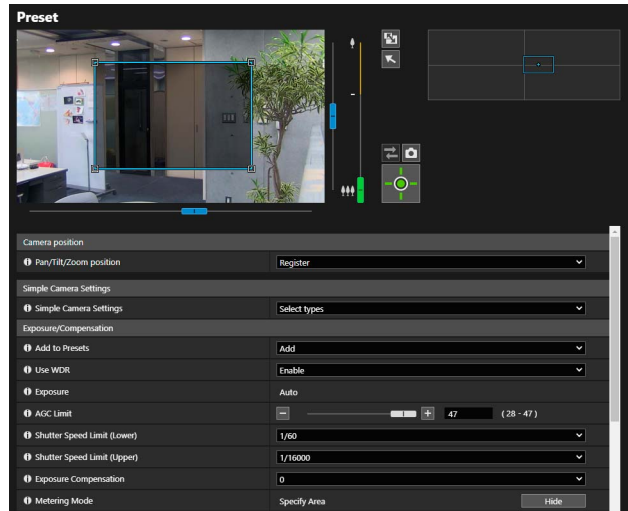

Important

- The frame cannot be displayed in the digital zoom area.

Note

- Frames may not be specified at the top, bottom, left and right edges of the video display area.

[Smart Shade Control]

Select whether to enable the Smart Shade Control function. If the background is bright and the subject is hard to see, by using the Smart Shade Control, dark areas are automatically compensated be bright to improve subject visibility.

Important

- When [Use WDR] is set to [Enable], fixed to [Auto].

Note

- The video data size increases if the Smart Shade Control is set.

[Haze Compensation]

Select whether to enable the Haze Compensation function. If the subject is obscured by haze, by using the Haze Compensation function, the video contrast is adjusted automatically to improve subject visibility. The strength of compensation can be changed by [Video] > [Picture (Option)] > [Camera Control] > [Haze Compensation Strength (Auto)] (P. 76).

Note

- The video data size may increase by setting the Haze Compensation.

[Day/Night]

Select a shooting mode according to the brightness of the installation environment.

[Auto]

The camera automatically switches to Day Mode or Night Mode according to the ambient brightness.

[Day Mode]

Captures normal color video.

[Night Mode]

Video turns to monochrome.

Removes the infrared cut filter to increase sensitivity. **HM4x**

Important

- When using in [Auto], note the following.
 - Conduct a thorough operation test beforehand to check the effectiveness of the setting.
 - Set [Exposure] to one of the following [Auto], [Auto (Flickerless)], [Auto (Flickerless2)] (S32VE S32D S820D/S920F), [Auto (Shutter-priority AE)], or [Auto (Aperture-priority AE)] (HM4x).
 - The infrared cut filter may reciprocate several times while the mode is switching between Day Mode and Night Mode. It will not be possible to use pan, tilt, zoom and manual focus during this period. HM4x
- If the Viewer is closed while [Day Mode] or [Night Mode] is set, these will remain in effect, even if [Day/Night] is set to [Auto] on the Settings page.
To enable Auto Day/Night mode, set [Day/Night] to [Auto] before exiting the Viewer.
- If an infrared illumination from an external device is used when set to Night Mode, turn on the infrared illumination before switching to Night Mode. HM4x
- The camera is equipped with an infrared cut filter without insertion-extraction mechanism, thus unable to obtain the infrared illumination effect. S32VE S32D S820D/S920F

Focus

HM4x S32VE S32D

Settings for focus.

[Add to Presets]

When adding the settings for [Focus] to preset, click [Add].

[Focus]

Select the focus.

[Auto]

Automatically adjusts the focus.

[Fixed at infinity]

Moves the focus position to near infinity.

If more precise focusing is needed, select [Manual] and adjust the focus.

[Manual]

By clicking and holding the [Near] and [Far] buttons in [Adjust Focus], adjust the focus in the near and far directions respectively.

By clicking [Exec] in [One-shot AF], the camera will focus once using autofocus and then switch to manual mode.

The following procedure enables to adjust the focus appropriately.

1. Select [Auto (Aperture-priority AE)] in [Exposure], and move the aperture slider to the right end to fully open the aperture. The depth of field becomes shallow, enabling to adjust the focus appropriately.
2. To adjust the focus, click and hold the [Far] or [Near] button in [Adjust Focus], or click [Exec] in [One-shot AF].
3. When the focus adjustment is finished, change [Exposure] to an appropriate setting.

Important

- The set focus is also applied to other users.
- Depending on the lighting used, focus may not be maintained when switching between [Day Mode] and [Night Mode]. Focus when switching between Day/Night mode can be set in [Event] > [Day/Night Mode Switching].
- If [Manual] is selected in [Exposure] and the shutter speed is set to 1/1 sec, the focus cannot be achieved even if set to [Auto]. In this case, adjust the focus with [Manual].
- Note that when the focus is set to [Manual] it will remain fixed.
- In conditions such as shooting an outdoor scene from an indoor through a glass window, the camera may focus on the glass if there is dust or water droplets on the surface. Install the camera at the shortest possible distance from the glass surface.

Note

- Focusing may be difficult for the following types of subjects in [Auto] or [One-shot AF].

Difficult to focus objects

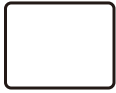

Objects such as white walls without bright/dark contrast

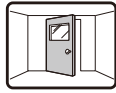

Slanting objects



Objects reflecting strong light



Objects consisting of only slant lines or horizontal stripes



Intangible objects such as flame or smoke



Objects seen through glass



Fast moving objects

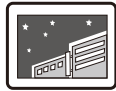

Dark areas or night view



Subjects both near and far in the frame

- It is recommended to check that the camera is focused after rebooting.
- For information about the focus range (approx.), refer to "Specifications."
- When [Fixed at Infinity] is selected and an external infrared illumination device is used, subjects that were originally in focus on visible light may not be in focus. **HM4x**

[One-shot AF]

Use when [Focus] is set to [Manual]. By clicking [Exec], the camera will focus once using autofocus and then switch to manual.

[Adjust Focus]

If the [Focus] is set to [Manual], click and hold the [Near] and [Far] buttons to adjust the focus position in the near and far directions respectively.

White Balance

Settings for the white balance.

[Add to Presets]

When adding the settings for [White Balance] to preset, click [Add].

[White Balance]

Select the white balance according to the light source to achieve natural color in the video.

Important

- When the subject has only one color, is under low light conditions, or when sodium lamps, mercury lamps or certain other fluorescent lighting is used, [Auto] may not adjust colors appropriately.
- If [Auto] is set, and the screen appears greenish under mercury lamps, select [Mercury Lamp]. If the colors of the screen are not appropriate under a mercury lamp even if [Mercury Lamp] is selected, select [Manual] and use [One-shot WB].
- Since the light source selection options are based on representative characteristics, appropriate colors may not be achieved depending on the available light source. If this occurs, select [Manual] and use the [One-shot WB].

[Auto]

Automatically adjusts the white balance.

[Manual]

Operate [One-shot WB], [R Gain], and [B Gain] to manually set the white balance.

[Daylight Fluorescent] (approx. 6100 K to 6600 K)

Select this when capturing under a daylight fluorescent lamp.

[White Fluorescent] (approx. 4100 K to 5000 K)

Select this when capturing under a daylight fluorescent lamp or white fluorescent lamp.

[Warm Fluorescent] (approx. 2500 K to 3000 K)

Select this when capturing under a warm fluorescent lamp.

[Sodium Lamp] (approx. 2000 K)

Select this when capturing under an orange sodium lamp.

[Halogen Lamp] (approx. 2700K to 3200 K)

Select this when capturing under a halogen lamp or incandescent lamp.

[Mercury Lamp] (approx. 4300 K)

Select this when capturing under a mercury lamp.

[One-shot WB]

If the white balance is set to [Manual], this will force the white balance to match the light source and lock the setting.

Setting Method Example:

Illuminate a white subject (white paper, etc.) using the light source, making sure the subject fills the entire screen, and then click [Exec].

[R Gain]

If the white balance is set to [Manual], set the Red gain values.

[B Gain]

If the white balance is set to [Manual], set the Blue gain values.



Important

- When [Day/Night] is set to [Night Mode] (including when it is set to [Auto] and Night Mode is judged to be applicable), the white balance function cannot be used.
- If a subject that seldom changes is captured in a location where the light source changes gradually, such as when capturing a subject continuously day and night, appropriate colors may not be achieved. In this case, appropriate colors can be achieved by adding changes to the video to be captured by executing [One-shot WB] for example.

Image Adjustment

Settings for image quality such as noise reduction and sharpness.

[Add to Presets]

When adding the settings for [Image Adjustment] to preset, click [Add].

[Noise Reduction]

Select a noise reduction level. This setting is generally more effective in low-light conditions.

When set to [Strong], the noise reduction effect is increased, but residual images are more likely to appear.

When set to [Mild], the noise reduction effect is decreased and resolution is increased, but the video file size becomes larger.

[Sharpness]

Select a sharpness level.

When set to [Strong] with higher value, the sharper the images become, while set to [Mild] with lower value, the softer the images become.

When set to [Strong] with higher value, the video file size becomes larger.

[Color Saturation]

Select a color saturation level.

Register Preset

By registering the camera settings such as camera angles and exposure as presets, the presets can be easily called up by Viewers to execute the settings.

Important

- It is strongly recommended to register as presets, the camera positions to be used for intelligent functions. **HM4x S32VE S32D**
- If a preset registered in the digital zoom area is used, it may not be possible to reproduce the camera position at registration with high accuracy. Therefore, it is recommended to use a preset registered in the optical zoom area for the preset tour (**HM4x** only) or in the intelligent functions. **HM4x S32VE S32D**
- When following items are changes, reset the presets.
 - [System] > [System] > [Installation Conditions] > [Video Flip] (P. 144)
 - Each video stream setting in [Video] > [Video] (P. 58)
- If the settings are changed in [Video] > [Picture (Option)] > [Camera Control] > [Image Stabilizer] after setting the presets (P. 75), the angle of view when the camera is operated will not match the angle of view when the presets are set. If [Image Stabilizer] settings are changed, recheck the preset settings. **HM4x**
- If a separately sold indoor dome housing dedicated to the camera is used, be sure to set presets with the dome installed. **HM4x**

■ Using Presets

In addition to immediate execution of registered camera angles and the camera settings such as exposure when operating the viewer, presets can be used as follows.

- Execute the presets during switches between Day Mode and Night Mode (P. 126).
- Automatically cycle through multiple presets at a set time and in a predetermined sequence (Preset Tour) (P. 71). **HM4x S820D/S920F**
- When using the Intelligent Functions, the monitoring position can be locked at a preset camera angle (P. 112). **HM4x S32VE S32D**

■ Registering a Preset

The camera angle and camera settings can be registered as presets.

The number of presets that can be registered is as follows.

- Maximum 64 presets (including the home position) **HM4x S32VE S32D**
- Maximum 20 presets (including the home position) **S820D/S920F**

To register a new preset, select an unnamed preset in the Preset list.

If selecting a preset already registered in the Presets list and clicking [Add] in step 4, the preset is overwritten.

1 Operate the video display area to set the angle.

The camera angle can also be operated from the following screens.

HM4x S32VE S32D

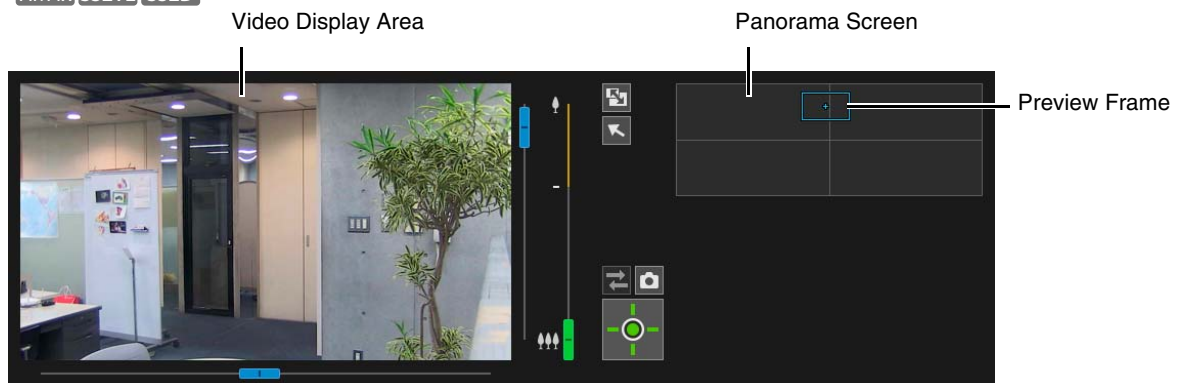



2 Set the items for preset registration.

[Pan/Tilt/Zoom position] **HM4x S32VE S32D** / [Digital PTZ Position] **S820D/S920F**

Select [Register] to register the current camera angle as a preset.

Note

- If [Home] (home position) is selected in the preset list, [Pan/Tilt/Zoom position]/[Digital PTZ Position] is always registered.

[Exposure/Compensation], [Focus] **HM4x S32VE S32D**, [White Balance], [Image Adjustment]

Select [Register] to register the current camera settings as a preset. Select [Add] in [Add to Presets] to set each item.

Note

- By setting [Simple Camera Settings], it is easy to set [Exposure/Compensation] and [Image Adjustment].

3 Enter a preset name.

[Preset Name], [Preset Name (alphanumeric characters)]

Be sure to enter a preset name in the [Preset Name].

When the [Preset Name] is entered, the [Preset Name] listed will be displayed with priority in the preset lists of the Viewer and the Settings page.

4 Click [Add].

The preset is saved in the camera.

Note **HM4x S32VE S32D**

- If the preset position is outside the viewing limit,  (a warning icon) is displayed on the left.

5 To register multiple presets, repeat steps 1 to 4.

■ Deleting a Preset

Select the preset to delete in the preset list, and click [Delete] to delete the preset from the camera. [Home] (home position) cannot be deleted.

■ Previewing a Preset

Select a preset in the preset list, and click [Preview]. The preset settings are shown in the video display area.

The camera can automatically tour multiple registered presets for monitoring.

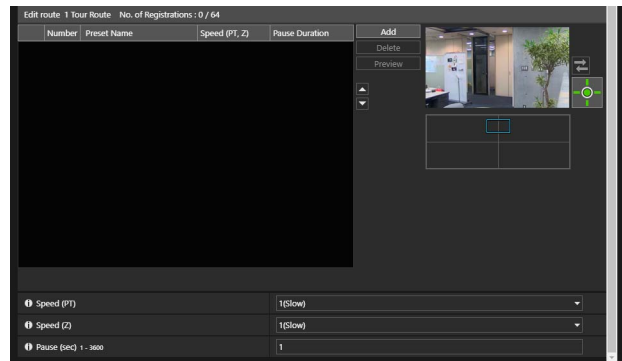
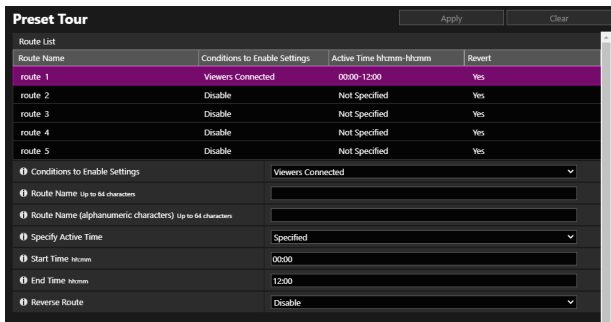

Important HM4x

- When using a preset with the focus set to Auto, the pause may prolong in case the focus has not been achieved within the pause duration that has been set.

Note

- Preset tour is not performed when the camera control privileges are obtained by the Camera Viewer or the video is displayed on the Settings page.

Screen Composition

Due to the number of tour routes that can be registered, number of presets that can be toured with a single route, and the tour conditions which differ depending on the camera model, the screen composition becomes as follows,

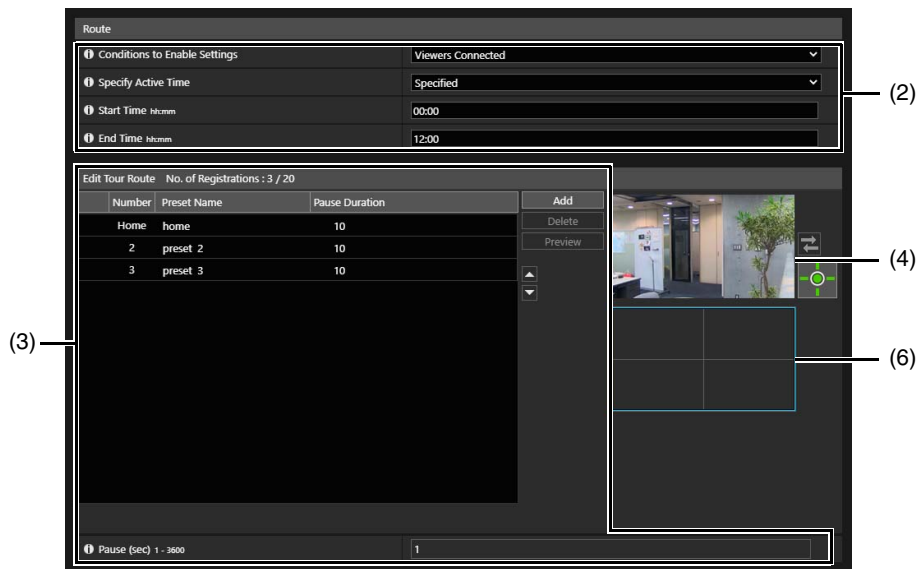
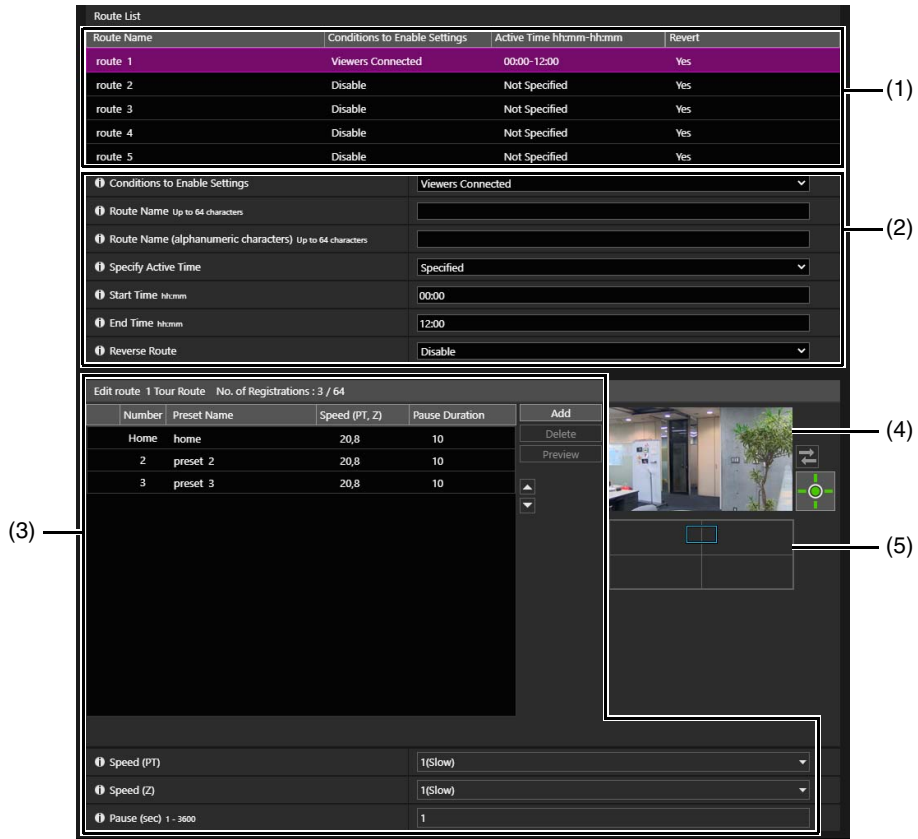

- (1) **[Route List] HM4x**
The list of preset tour routes. Displays the tour conditions that are set. Up to five tour routes can be set.
- (2) **Tour Condition Settings**
Set the conditions for touring (P. 73).
- (3) **[Edit Tour Route]**
Displays a list of the presets to tour. The presets are toured from the top of the list.
It is possible to change the order of the presets and set the time to stop at the preset positions, etc.
- (4) **Video Display Area**
Displays the current camera video.

(5) **Panorama Screen** HM4x

Displays the panorama images registered in the camera.



(a) **Pan/Tilt Preview Frame (Red Frame)**

Displays the vertical and horizontal range the camera can move. Displayed when the view restriction is set (P. 85).

(b) **Preview Frame (Blue Frame)**

Indicates the current camera angle in the video display area.

(c) **Preset Preview Frame (White Frame)**

Indicates the preset/home position that is currently selected.

(6) **Digital PTZ Panel** S820D/S920F

Displays the full video obtained by the camera when starting [Preset Tour].



(b) **Preview Frame (Blue Frame)**

Indicates the currently cropped area in the video display area.

(c) **Preset Preview Frame (White Frame)**

Indicates the preset/home position that is currently selected.

Tour Route Settings

The number of tour routes that can be registered and the number of presets that can be toured per route are as follows.

- Maximum 5 routes, maximum 64 presets per route HM4x
- Maximum 1 route, maximum 20 presets per route S820D/S920F

 **Note** HM4x

- If there are conflicts of conditions or active time of the registered tour routes, the routes listed higher in the [Route List] take precedence.

1 Select the tour route to configure from [Route List]. HM4x

2 Configure settings for tour route name and operations.

[Conditions to Enable Settings]

Select the conditions to perform a preset tour.

[Disable]

Preset tour is not performed.

[Viewers Connected]

Preset tour is performed when a Viewer is connected to the camera.

[Always]

Preset tour is always performed.

Note

- If [Disable] is selected, the following preset tour route settings, 3 to 6, cannot be configured.

[Route Name], [Route Name (alphanumeric characters)]

Enter the tour route name.

When the [Route Name] is entered, the [Route Name] listed will be displayed with priority in the [Route List].

[Specify Active Time]

For performing a preset tour at a predetermined time, select [Specified] and enter the start time and end time for the preset tour.

If [Viewers Connected] is set for [Conditions to Enable Settings], the preset tour operates when the Viewer is connected to the camera at the tour start time. If [Always] is set for [Conditions to Enable Settings], the preset tour always operates.

[Reverse Route]

By selecting [Enable], the preset tour order in [Edit Tour Route] will be reversed.

3 Click [Add] in [Edit Tour Route].

4 Select a preset to tour from the [Preset List].



Multiple presets can be specified.

Note

- If the preset position is outside the view restriction area,  (a warning icon) is displayed on the left.

5 Click [Add].

The preset is added to the [Edit Tour Route].

Select a preset in [Edit Tour Route] and click  or  to change its position in the list.

By selecting a preset in [Edit Tour Route] and then clicking [Delete], the preset will be deleted.

By selecting a preset name in the [Preset List] or [Edit Tour Route] list, and clicking [Preview], the preset settings can be checked in the video display area.

Note

- If a preset has already been added to [Edit Tour Route] when another preset is added from [Preset List], the added preset will be displayed below the preset selected in [Edit Tour Route].

6 Configure the preset speed and pause duration.

Select the preset to configure in [Edit Tour Route] and set the tour operation.

[Speed (PT)]

Select the camera pan/tilt speed for moving to the next preset.

[Speed (Z)]

Select the camera zoom speed for moving to the next preset.

[Pause (sec)]

Enter the time the camera pauses at the preset position.

Note

- For viewing the video moving between presets, select a slower speed. For viewing the video only at the preset position switching quickly, select a faster speed.

7 Click [Apply].

Click [Apply] after setting the route. The set value will be saved to the camera.

Note

- Click [Clear] to set the route again. The settings saved in the camera are restored. However, note that presets only added to the [Edit Tour Route] by clicking [Add] are all discarded.

[Video] > [Picture (Option)]

Settings for details of camera control and Day/Night when set to Auto.

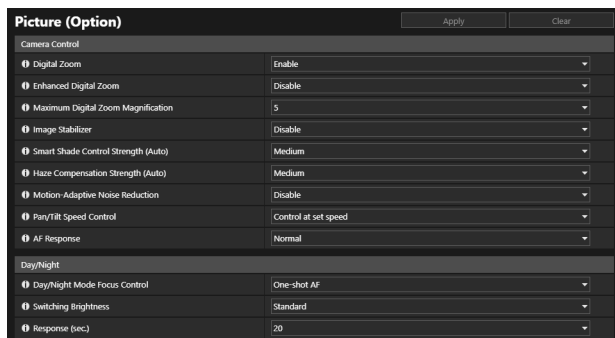

Camera Control

Set various controls for easier viewing of video.

[Digital Zoom] **HM4x** **S32VE** **S32D**

Select whether to use the digital zoom.

If [Enable] is selected, the area indicating digital zoom will be displayed on the zoom slider (P. 36).

Unlike optical zoom, the higher the digital zoom ratio, the lower the video quality.

[Enhanced Digital Zoom] **HM4x**

Select whether to use the enhanced digital zoom.

When the video size is small, digital zoom can be used to enlarge the picture up to the maximum resolution with reduced video deterioration.

When [Enable] is selected, an area indicating the enhanced digital zoom and a horizontal line (blue) indicating the maximum telephoto by the enhanced digital zoom are displayed on the zoom slider of the Viewer (P. 36).

[Maximum Digital Zoom Magnification] **HM4x**

Sets the maximum zoom magnification for digital zoom.

[Image Stabilizer] **HM4x**

Select this to enable or disable blur reduction in video due to camera vibration.

If there is still blur after selecting [On1], select [On2].

Do not deliver more than two streams simultaneously. However, even if the number of streams is two or less, image stabilizer may not work properly under the following conditions:

- Video size, video quality and bit rate are set higher
- On-screen display (date and time) setting is enabled

Important

- Stabilization is not effective beyond a certain degree of vibration or for momentary vibrations.
- The process of image stabilization will temporarily stop during pan, tilt and zoom operations.
- Image stabilizer is fixed to [Disable] when [Maintenance] > [Environment] > [WDR] is set to [Disable].
- For using Image Stabilization, refer to the information listed in the following "Important" sections.
 - The "Important" section in "Viewing Video with the Camera Viewer" (P. 31).
 - The "Important" section in "Register Preset" (P. 69).
 - The "Important" section in "Registering Privacy Masks" (P. 83)
 - The "Important" section in "Setting View Restriction" (P. 86).

Note

- If [On2] is selected, it is recommended to select a reception video size less than [640 x 480].
- The angle of view will be narrower and video noisier when using the Image Stabilizer, compared to when it is not used. However, it is not a problem.

- Depending on the vibration of the camera, the image may appear stretched or distorted, which is a phenomenon caused by the characteristics of the CMOS sensor and cannot be reduced by the image stabilizer function.

[Smart Shade Control Strength (Auto)]

Select the control strength when [Smart Shade Control] (P. 65) is set to [Auto].

- [Mild]: Select if noise is noticeable.
- [Medium]: Recommended setting for Auto mode (default setting)
- [Strong]: Select to increase visibility in dark areas.

[Haze Compensation Strength (Auto)]

Select the strength of compensation when [Haze Compensation] (P. 65) is set to [Auto].

Note

- When [Haze Compensation] is set to [Auto] and [Haze Compensation Strength (Auto)] is set to [Strong], contrast may be strong between bright and dark if the subject is not obscured by haze. If this happens, set [Haze Compensation Strength (Auto)] to [Mild].

[Motion-Adaptive Noise Reduction]

When [Enable] is selected, noise reduction is automatically adjusted according to movement. For scenes with little movement, noise reduction is increased decreasing the data size.

Important

- The intended effect may not be achievable, depending on the following conditions:
 - the size of the subject
 - the movement speed of the subject
 - scenes with a lot of noise
 - subjects without bright/dark contrast (white walls, etc.)

[Pan/Tilt Speed Control] **HM4x S32VE S32D**

Select the mode controlling the pan/tilt movement.

If [Control by zoom position] is selected, the pan/tilt speed will be slower in telephoto, and faster in wide-angle.

[AF Response] **HM4x S32VE S32D**

Selects the responsiveness of the autofocus.

The setting values are High, Normal, and Low in order of the shortest time until the focus operation starts.

Day/Night

[Day/Night Mode Focus Control] **HM4x**

Select the focus control method for day/night mode switching. This is executed when [Focus] (P. 66) is set to [Manual].

Note

- If a preset is set in [Event] > [Day/Night Mode Switching], this is executed when the [Focus] registered in the preset is set to [Manual].

[Compensation for fluorescent light source]

When switching the Day/Night mode, the focus position is corrected according to day mode or night mode under the illumination environment of fluorescent light.

[One-shot AF]

One-shot AF is executed.

Important

- When using [One-shot AF], since the camera focuses on the subject when switching day/night mode, it may not be able to focus on the target subject if a person walks across the scene.

[Switching Brightness]

Select the brightness for switching Day/Night Mode when [Day/Night] (P. 65) is set to [Auto].

Select [Darker] if the video should be captured in color as much as possible.

Select [Brighter] to reduce noise. Note that this mode switches to monochrome sooner.

[Response (sec.)]

Select the number of seconds for determining when to switch Day/Night Mode, when [Day/Night] (P. 65) is set to [Auto].

Day/Night Mode switches when the brightness continues to exceed or fall below the brightness set in [Switching Brightness] for the number of seconds selected.

Select [30] or [60] if brightness changes frequently, such as when a light source passes in front of the camera. Select [5] or [10] if change in brightness is minimal.

[Video] > [ADSR]

Reduces the size of transmitted H.264/H.265 video by reducing the video quality of non-target areas, such as ceilings and the sky.

ADSR is an abbreviation for Area-specific Data Size Reduction.

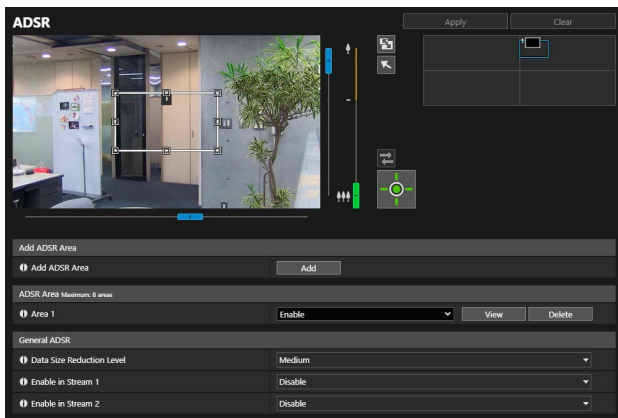

Important

- Depending on the captured scene or the ADSR area setting, it may not be possible to obtain the reduction effect. Please check the reduction effect before use.

Note

- The image quality in the ADSR area varies depending on the [Bit Rate Control] setting specified for H.264/H.265 video in [Video] > [Video].
- The image quality for outside the ADSR area will be reduced according to [Data Size Reduction Level].

HM4x S32VE S32D

- Even if the camera pans, tilts, or zooms, the ADSR area follows the movement of the camera.
- ADSR areas can only be configured within view restrictions.

ADSR, ADSR Area

Set the area where video quality is not to be reduced. Up to 8 areas can be set.

Important

- Reset ADSR areas if following items are changed.
 - [System] > [System] > [Installation Conditions] > [Video Flip] (P. 144)
 - Each video stream setting in [Video] > [Video] (P. 58)

HM4x S32VE S32D

- Set the ADSR area to a larger size.
- ADSR areas may deviate slightly from the specified position depending on the zoom position.
- The ADSR area can only be set within the optical zoom range, and cannot be set using the digital zoom range (P. 36).

1 Click [Add].

The frame for the ADSR area is displayed on the video display area.

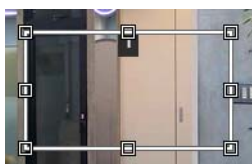

2 Set the ADSR area.

Set the ADSR area as follows on the video display area.

- Change the size of the frame by dragging the □ on the frame.
- For changing the camera angle, use the slider to operate pan/tilt/zoom. **HM4x S32VE S32D**

3 Click [Apply].

The settings are saved in the camera.

The camera will move to a ADSR area by clicking [View].

For modifying an area, click [View] for the area, then after modifying the area, click [Apply].

Click [Delete] to delete the set ADSR area from the list.



Note

- Use the Camera Viewer to check video with ADSR settings applied. Video outside the ADSR area will deteriorate according to the data reduction effect.
- If the camera angle is changed before operating the area frame, the area frame may become hidden. To display the area frame again, either click [View] for the target ADSR area, or use the slider to move the camera angle to a position where the entire area frame is displayed. **HM4x S32VE S32D**

General ADSR

Sets the data size reduction of outside ADSR areas.

[Data Size Reduction Level]

Set the data size reduction level for the outside ADSR area. If [Low] is selected, the data size reduction effect is lower. If [High] is selected, the data size reduction effect is higher.

[Enable in Stream 1]

Select [Enable] to lower video quality of outside ADSR areas in Stream 1 video.

[Enable in Stream 2]

Select [Enable] to lower video quality of outside ADSR areas in Stream 2 video.

[Video] > [On-screen display]

Displays the date and time, camera name and any string of characters on the video.

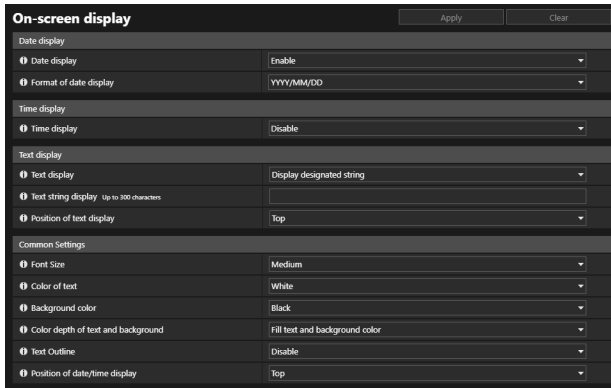

The screenshot shows the 'On-screen display' settings menu. It is divided into several sections: 'Date display', 'Time display', 'Text display', and 'Common Settings'. Each section contains a list of settings with their current values.

Section	Setting	Value
Date display	Date display	Enable
	Format of date display	YYYY/MM/DD
Time display	Time display	Disable
	Text display	Display designated string
Text display	Text string display (up to 300 characters)	
	Position of text display	Top
	Common Settings	
Font Size	Medium	
Color of text	White	
Background color	Black	
Color depth of text and background	Fill text and background color	
Text Outline	Disable	
Position of date/time display	Top	

Important

- The time on on-screen display is not suitable for usage where high reliability is required. Only use it as reference information for usage such as surveillance where very high reliability is required.

Note

- Depending on video quality settings, the on-screen display may become illegible. Set it after checking on the actual video.
- All of the texts may not be displayed depending on the video size, text length, and text position. Check the display after changing the video size and on-screen display settings.

Date display

[Date display]

Select whether to display the date on the video.

[Format of date display]

Select the year, month and day display order.

Time display

[Time display]

Select whether to display the time on the Video.

Text display

[Text display]

Select the string of characters to display on the video.

[Display designated string]

Displays the string of characters entered in [Text string display].

[Display camera name]

Displays the camera name entered in [Camera Name] (P. 144).

[Text string display]

If [Text display] is set to [Display designated string], enter the string of characters to be displayed on the video in alphanumeric characters.

[Position of text display]

Select position for string of characters display on the video.

Common Settings

[Font Size]

Select the font size from three types (small, medium, large).

[Color of text]

Select from eight colors for the text color.

[Background color]

Select from eight colors for the background color.

[Color depth of text and background]

Select the combination of color depth of text and background (Filling, Transparence, Translucence).

[Text Outline]

Select whether to outline the text in black.

[Position of date/time display]

Select position for date and time display on the video.

[Video] > [Privacy Mask]

It is possible to mask any area of the camera image video and fill it with a specified color or apply a mosaic. It is possible to set up to eight privacy masks while checking the camera video.

When the camera is panned, tilted, or zoomed, the privacy mask areas follow the camera video. **HM4x S32VE S32D**

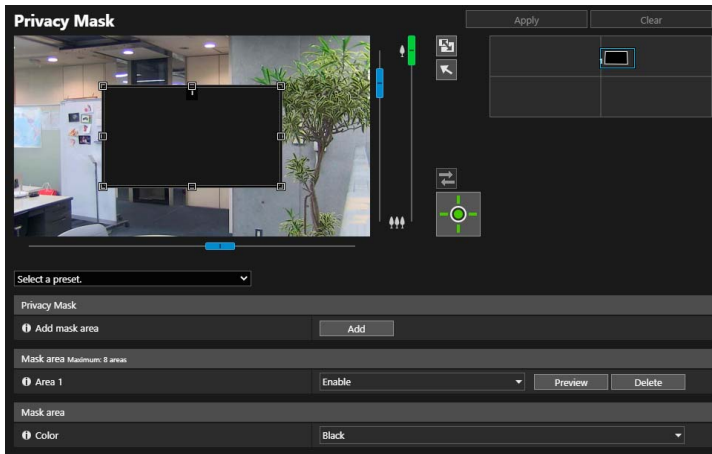

Important

- Privacy masks are applied to all video transmitted from the camera (live video, uploaded video, recorded video and video recorded to a memory card).
- Privacy masks are not available in the following cases.
 - When the camera is launched immediately after being turned on
 - While a panorama image is being created **HM4x S32VE S32D**
- Intelligent Function detection also works in the privacy mask areas. On [Detection] > [Intelligent Function], the movement of the subject may be recognized by the outline of the detected object displayed on the mask.

Registering Privacy Masks

Use the mouse to position and size the privacy mask areas, then save the settings to the camera.

- 1** Display the area to be added as a mask area on the video display area. **HM4x S32VE S32D**

Operate the camera angle using the slider or preset selection box.

- 2** In [Add mask area], click [Add].

The preview frame with an area number is displayed on the video display area, and the privacy mask area with the corresponding number is also displayed in the privacy mask registration area.

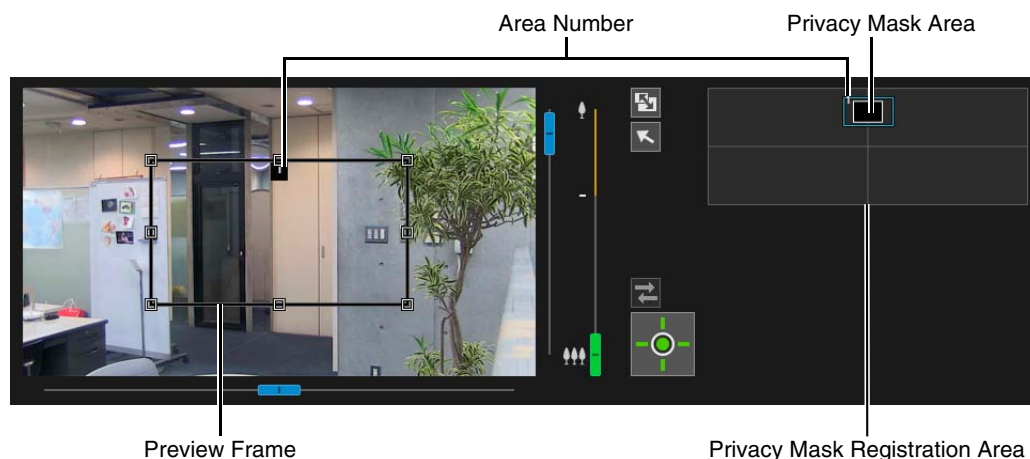

3 Set the size and position for the preview frame in the video display area.

Drag the preview frame shown in the video display area to the position to be masked.
Change the size of the preview frame by dragging □ on its four sides.



Important HM4x S32VE S32D

- Set the privacy mask area to a slightly larger size than the area to be masked.

4 Set [Mask area] to [Enable].

The settings for the privacy mask area is enabled.

Set [Mask area] to [Disable] to temporarily disable privacy mask areas without deleting. The privacy mask areas in the privacy mask registration area will be displayed as frames with a diagonal line.

5 Change the color of the privacy mask area with [Color] as necessary.

The color selected here is reflected to all the preview frames and privacy mask areas.

6 To add privacy mask areas, repeat steps 1 to 5.

Up to eight privacy masks can be saved.

7 Click [Apply].

The privacy mask area is saved to the camera.

Saved privacy mask areas are shown in the video display area and the privacy mask registration area.



Important

- It will be necessary to reset the position of the privacy masks if the settings in [System] > [System] > [Installation Conditions] > [Video Flip] are changed.
- For resetting the privacy masks after changing [Video] > [Picture (Option)] > [Camera Control] > [Image Stabilizer], reset all the privacy mask positions and sizes. HM4x

HM4x S32VE S32D

- If the privacy mask settings are changed after saving a panorama image in [Panorama], recreate the panorama image in [Panorama] (P. 89).
- After registering a privacy mask, pan, tilt and zoom the camera to confirm the areas to be masked do not become visible when the camera angle is altered.
- Privacy masks may deviate slightly from the specified position depending on the zoom position.

Changing/Deleting a Privacy Mask

■ Privacy Mask Registration Area

This shows the positions of privacy mask areas in the entire area that can be captured by the camera.

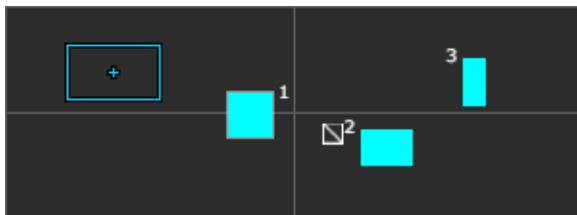

Privacy mask area is displayed with its frame filled in. When [Mask area] is set to [Disable] (P. 83), □ appears next to the area number.



Note HM4x S32VE S32D

- The current camera position shown in the video display area is indicated by a preview frame (blue frame).

- If view restrictions (P. 85) have been set or panorama images (P. 89) have been registered to the camera, they will appear in privacy mask registration area.

■ Changing Mask Position and Size

How to Select a Privacy Mask

The following methods are available for selecting the privacy mask area.

- Click the privacy mask area to be selected in the privacy mask registration area.
- Click [Preview] of the mask area to be displayed.
- Click the privacy mask area shown in the video display area.

1 Select the privacy mask area to be changed.

2 Change the position and size of the privacy mask area.

Move the preview frame by dragging it and change its size by dragging on its four sides.



Note

- To discard changes and restore settings saved to the camera, click [Clear]. However, note that mask area settings that have not been saved in the camera by clicking [Apply] are all discarded.

3 Click [Apply].

The changed privacy mask area is saved to the camera.

■ Deleting a Privacy Mask from the Camera

Click [Delete] of [Mask area] in the privacy mask to be deleted, then click [Apply].
The selected privacy mask area is deleted from the camera.

Setting the area that the camera can capture.

To be used, for cases such as to limit zoom or the field of view to a certain area.

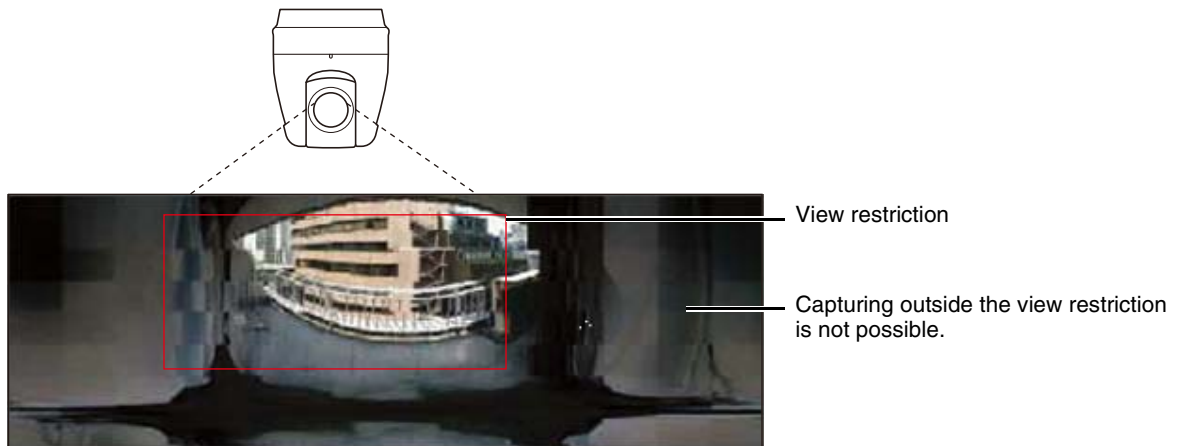
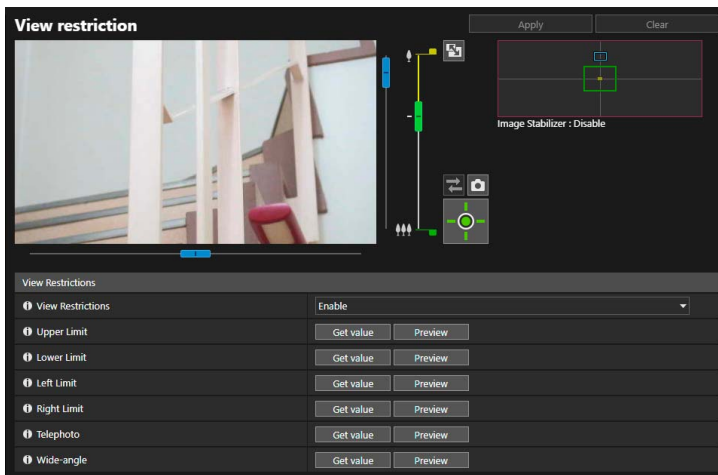

Scope of View Restriction Settings

Restrictions set by the view restriction function are applied in the following cases.

- When the Camera Viewer is accessed with authorized user or guest user privileges.
- For preset settings or functions that move to preset.

Important

- Since view restriction is set using a frame with an aspect ratio of 16:9, visible range cannot move to the left or right edge when using video with an aspect ratio of 4:3.
- Even when view restrictions are set, an area outside the view restriction may still be displayed momentarily when the camera is controlled near the boundary of the view restriction.

Setting View Restrictions

Set view restriction and click [Apply] to restrict the capture range on the Camera Viewer.

Important

- If the settings for the camera installation method is changed, review the view restriction settings.
- If changes have been made to each video streams in [Video] > [Video], review the view restriction settings.
- When [Video] > [Picture (Option)] > [Camera Control] > [Digital Zoom] or [Image Stabilizer] (**HM4x**) is changed, check the view restriction settings again.

1 Select [Enable] in [View Restrictions].

Note

- To release view restriction settings, select [Disable], and click [Apply].

2 Set the view restriction area.

Operate the camera angle using the frame on the video display area or the panorama screen/full-view screen to acquire the positions, and specify the view restriction area.

[Upper Limit]/[Lower Limit]/[Left Limit]/[Right Limit]

Operate the camera angle to the positions to be set respectively on the upper limit, lower limit, left limit, and right limit in the video display area.

Click [Get value] in each position to reflect to the pan/tilt preview frame.

Click [Preview] individually for [Upper Limit]/[Lower Limit]/[Left Limit]/[Right Limit], then the preview frame will move to the upper limit, lower limit, left limit, and right limit of the current pan/tilt preview frame respectively, and will be displayed in the video display area.

[Telephoto]/[Wide-angle]

Operate the camera angle to the positions to be set for the wide-angle or telephoto, using the frame on the video display area or the panorama screen.

Click [Get value] in each position to reflect the values to the wide-angle preview frame/telephoto preview frame.

Click [Preview] for [Telephoto]/[Wide-angle] individually then the preview frame will be transformed to the telephoto/wide-angle limit of the current telephoto preview frame/wide-angle preview frame and displayed in the video display area.

It is also possible to set the telephoto/wide-angle limit range by directly moving up and down the view restriction operation knob on the zoom slider. In this case also, each preview frame will be transformed to the telephoto/wide-angle limit of the current wide-angle preview frame/telephoto preview frame and displayed in the video display area.

If the telephoto knob is dragged to the upper end and the wide-angle knob to the lower end, the view restriction is disabled for the respective end (there is no restriction).

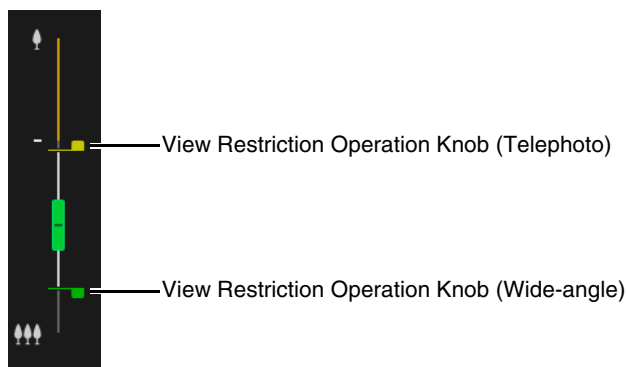

Drag the frames displayed on the panorama screen to transform and set the view restriction area.

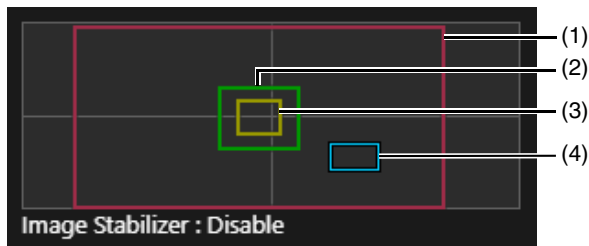

(1) Pan/Tilt Preview Frame (Red Frame)

Displays the vertical and horizontal range the camera can move. The view restriction area can be changed directly by dragging the pan/tilt preview frame.

If the pan/tilt preview frame is dragged to outside of the panorama area, the view restriction is disabled for each end (there is no restriction).

(2) Wide-Angle Preview Frame (Green Frame)

The restriction limit of wide-angle can be directly changed by dragging the wide-angle preview frame, but the aspect ratio cannot be changed.

The wide-angle preview frame can be set within the pan/tilt preview frame.

(3) Telephoto Preview Frame (Yellow Frame)

The restriction limit of telephoto can be directly changed by dragging the telephoto preview frame, but the aspect ratio cannot be changed.

The telephoto preview frame can be set within the wide-angle preview frame.

(4) Preview Frame (Blue Frame)

Indicates the current position shown in the video display area.

Note

- If the preview frame (blue frame) is positioned outside the pan/tilt preview frame (red frame) that is transformed, the camera position will be moved inside the view restriction.
- When the pan/tilt preview frame is changed, the preview frame will move onto the changed end. If the limit of the wide-angle/telephoto preview frame are changed, the wide-angle/telephoto end of the preview frame will also be changed.

3 Click [Apply].

The settings are saved to the camera.

Important

- The panorama screen may vary slightly from the actual video. After setting the view restrictions, be sure to use the Camera Viewer to confirm the view restriction settings have been reflected correctly. View restrictions are not applied to the video display area of the view restriction setting.

Note

- The controllable range and shootable range are as follows.

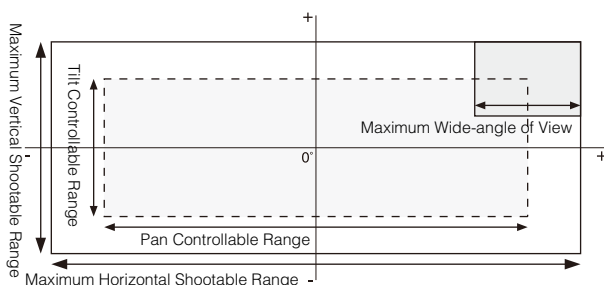

- The pan and tilt ranges vary depending on the zoom ratio (angle of view).

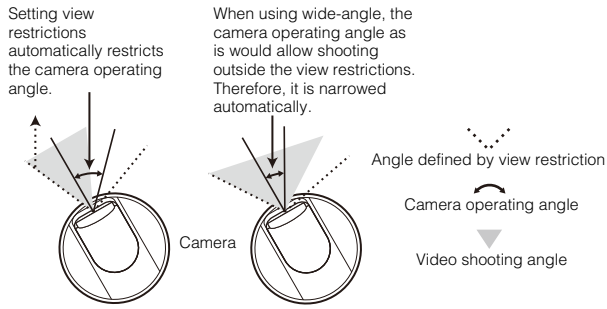

- If the view restriction will be exceeded as a result of zooming toward wide-angle, the camera will first pan and tilt to a position where the maximum wide-angle will be within the view restriction. Wide-angle zoom control will then be enabled within the view restriction.

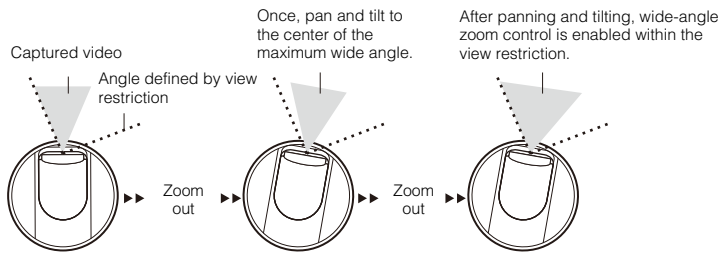

- Narrowing the view restriction may also narrow the zoom range.

It is possible to create a panorama image that captures the entire area that can be captured by the camera. Created panorama images are displayed in the Viewer and part of the Settings page.

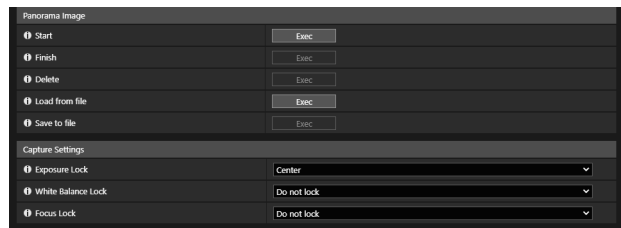
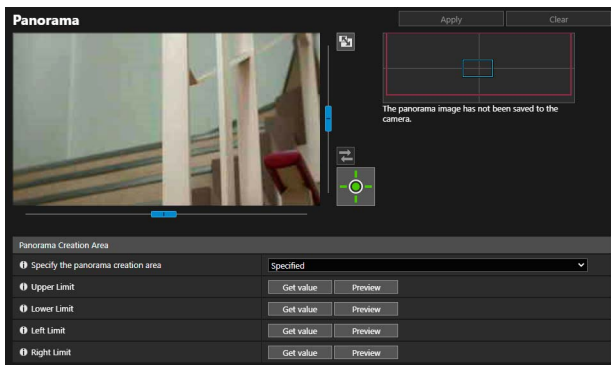

Important

- If the privacy mask settings are changed in [Privacy Mask], it is recommended to create the panorama image again to reflect the new privacy mask settings in the panorama image.
- If the camera installation method settings are changed, recapture the panorama image.

Creating a Panorama Image

A panorama image can be used in the Viewer and for a privacy mask by clicking [Apply] to save it to the camera after capturing.

Note

- While a panorama image is being captured, the Image Stabilizer is temporarily disabled. **HM4x**
- The following users will be disconnected while creating a panorama image.
 - All users except for administrators
 - Users not connected via RTP
- When a small value is entered for [Video] > [Video] > [Stream 3] or [Stream 4] (P. 59), panorama capture is slowed down.

1 Set [Panorama Creation Area].

Set the area for panorama creation. This enables to reduce the panorama creation time.

[Specify the panorama creation area]

By selecting [Specified], the panorama image is created specifying the area within an area that can be captured.

By selecting [Not Specified], the panorama image is created in the entire area that can be captured.

If [Not Specified] is selected, proceed to step 3.

2 Set the creation area using the video display area.

Operate the camera angle using the video display area, get the positioning value to specify the panorama creation area.

[Upper Limit]/[Lower Limit]/[Left Limit]/[Right Limit]

Operate the camera angle to the positions to be set respectively on the upper limit, lower limit, left limit, and right limit in the video display area.

Click [Get value] in each position to reflect the values to the panorama creation area frame.

Click [Preview] for [Upper Limit]/[Lower Limit]/[Left Limit]/[Right Limit], then the preview frame will move to the upper limit, lower limit, left limit, and right limit of the current panorama creation area frame respectively and will be displayed in the video display area.

Two types of frames are displayed for panorama images.

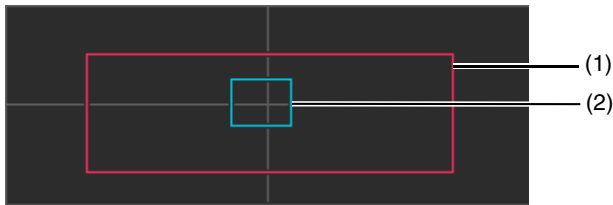

(1) Panorama creation area frame (red frame)

Indicates the capture range of the panorama image. It is also possible to drag the panorama creation area frame to set the capture range for the panorama image.

Note

- If the preview frame is positioned outside the transformed panorama creation area frame, the camera position is moved inside the panorama creation area frame.

(2) Preview frame (blue frame)

Indicates the current position shown in the video display area.

3 Set [Capture Settings] as necessary.

[Exposure Lock]

The exposure for the selected position will be automatically adjusted and locked during capture.

[White Balance Lock]

The white balance for the selected position will be automatically adjusted and locked during capture.

[Focus Lock]

The focus for the selected position will be automatically adjusted and locked during capture for the entire scene.

4 In [Start], click [Exec].

Capturing starts, and the panorama image is created.

Click [Cancel] to interrupt capturing.

When the panorama image shooting is completed, a grid frame appears on the image. Right-click the mouse pointer over the area to recapture and select [Recapture] to recapture that area only.

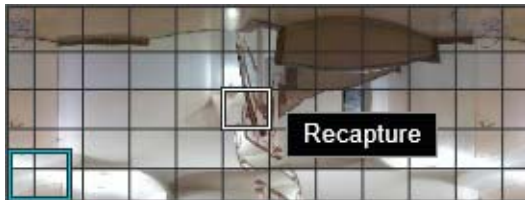

For reshooting the entire panorama image, click again [Exec] in [Start].

5 In [Finish], click [Exec].

The created image is not yet saved in the camera at this moment.

6 Click [Apply].

The panorama image is saved in the camera and reflected in the other settings.

■ Deleting a Panorama Image from the Camera

Deleting a panorama image saved in the camera.

1 Click [Exec] of [Delete].

The displayed panorama image is cleared.

2 Click [Apply].

The confirmation message is displayed.

3 Click [OK].

The panorama image saved in the camera is deleted.

Saving the Panorama Image as an Image File/Opening the Image File

The captured panorama image can be saved as an image file and image files can be opened as panorama images. Only image files in the JPEG format can be used.

Saving the Panorama Image as an Image File

1 After creating the panorama image, click [Exec] in [Save to file].

2 In the displayed dialog box, select the folder to save the file in, and enter the file name.

3 Click [Save].

The image file is saved in the specified location.

Opening the Image File

1 In [Load from file], click [Exec].

2 In the displayed dialog box, select the image file to use and click [Open].

The panorama image is displayed.

[Audio] > [Audio]

Settings for audio input from the microphone and audio output from the Viewer. Also, registering the sound clip to be outputted when an event occurs.

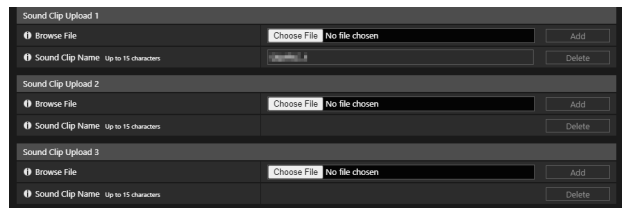
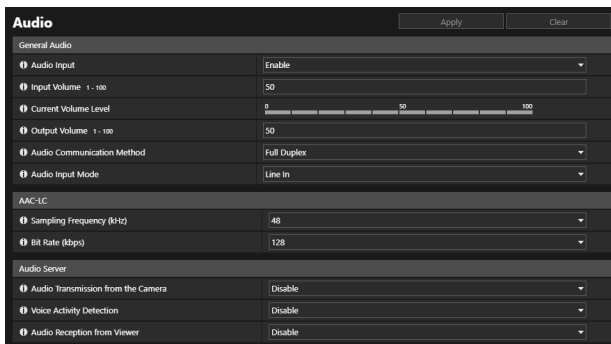

Important

- Video and audio can be delivered to up to 30 clients. However, when there are many clients or they are connected to the camera over an SSL/TLS connection, when the audio is received from the camera, the video frame rate may decrease or the audio may be interrupted.
- The video and audio may not be synchronized.
- If the [Input Volume] or [Low-Cut Filter] **S32VE** setting is changed after setting volume detection (P. 104), review the detection setting.
- The audio may be temporarily interrupted, depending on the performance of the computer and the network environment.
- The audio may be interrupted if anti-virus software is enabled.
- When communication is temporarily interrupted due to reseating the LAN cable, the audio is interrupted. If this occurs, reconnect from the Viewer.
- The volume, sound quality, etc., may change depending on the characteristics of the microphone used. **HM4x** **S32D** **S820D/S920F**
- Use a speaker with an amplifier to connect to the camera (refer to the “Installation Guide”).

General Audio

Setting the volume of the input/output audio, the type of microphone, and the operation of the built-in microphone for audio input.

[Audio Input]

Select whether to use audio input from the microphone. If [Enable] is selected, it is possible to use functions related to audio input such as [Audio Server] > [Audio Transmission from the Camera] (P. 93) or [Detection] > [Audio Detection] > [Volume Detection] > [Volume Detection Event] (P. 104).

If you select [Disable] and click [Apply], the following settings are locked and audio input functions are disabled.

- [Audio Server] > [Audio Transmission from the Camera] > [Disable]
- [Server] > [RTP Server] > [RTP Stream 1] to [RTP Stream 5] > [Audio Transmission] > [Disable]
- [Detection] > [Audio Detection] > [Volume Detection] > [Volume Detection Event] > [Disable]

[Input Volume]

Set the input volume from the microphone.

This is applied when [Audio Input] is set to [Enable].

[Current Volume Level]

When [Audio Input] is set to [Enable], the current volume level is displayed on the status bar.

[Low-Cut Filter] **S32VE**

When [Audio Input] is set to [Enable], select whether to use the function of cutting the low frequency range of the input audio. By selecting [Enable], it is possible to reduce noise, such as wind noise, that occurs when the wind hits microphone, making it easier to hear conversations.

By selecting [Disable], environmental noise, such as generated by traffic or crowd, are inputted more accurately.

[Mute During Pan/Tilt] S32VE

Set when [audio Input] is set to [enable]. By selecting [Mute], the audio input during Pan/Tilt operation is muted.

[Output Volume] HM4x S32VE

Enter the output volume from the Viewer to the speaker connected to the camera.

This is applied when [Audio Server] > [Audio Reception from Viewer] (P. 94) is set to [Enable].

[Audio Communication Method] HM4x S32VE

Select the audio transmission/reception method.

[Full Duplex]

Audio can be transmitted from the camera to the Viewer even while the camera is receiving audio from the Viewer.

[Half Duplex]

It is possible to prevent howling that occurs when the microphone and speaker are placed nearby. However, there is no sound sent from the camera to the Viewer while the camera is receiving audio from the Viewer or while an audio file is being played back.

[Audio Input Mode] HM4x S32D S820D/S920F

Select the type of microphone connected to the camera.



Important

- If using a microphone, switch [Line In] and [Microphone In] with [Audio Input Mode] to suit the specifications of the microphone. Incorrect use may damage the camera and/or microphone. Be sure to configure settings correctly.

AAC-LC

Setting audio compression.

[Sampling Frequency (kHz)], [Bit Rate (kbps)]

The value of the selectable bit rate is determined according to the sampling frequency.

Sampling frequency	Bit Rate
16 kHz	16 kbps, 32 kbps, 64 kbps, 96 kbps
48 kHz	32 kbps, 64 kbps, 96 kbps, 128 kbps

Audio Server

Set audio transmission from the microphone, and audio reception from the Viewer to the camera.

[Audio Transmission from the Camera]

Select [Enable] to transmit audio from the microphone to the Viewer.

It is not possible to set to [Enable] if [General Audio] > [Audio Input] is set to [Disable].

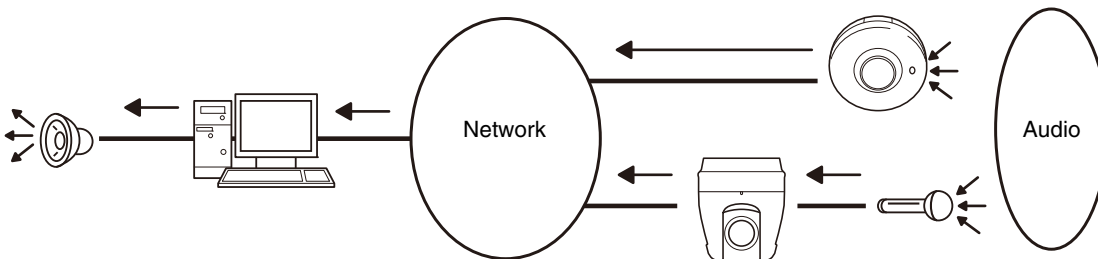

[Voice Activity Detection]

Select whether to detect when there is no sound coming from the microphone.

When set to [Enable], audio data transmission will pause temporarily while there is no audio input from the camera. This can reduce the load on the network used.

[Audio Reception from Viewer] HM4x S32VE

Select whether to receive audio from Camera Viewer.

Received audio can be outputted from a speaker with an amplifier connected to the camera.

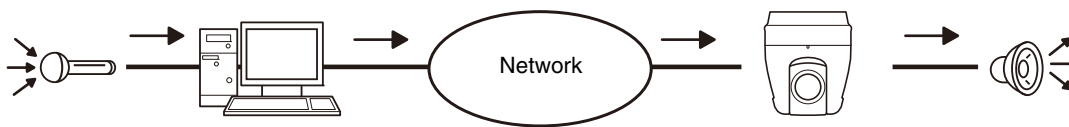

Sound Clip Upload 1 to 3

HM4x S32VE

It is possible to upload up to three sound clips for playback when an event is triggered.

Note

- The sound clip is used for the [Event] tab (P. 119) when setting the audio playback in [Event] > [External Device] > [External Device Input] (P. 121) or [Detection] > [Intelligent Function].

[Browse File]

Specify the sound clip to upload and click [Add].

For a sound clip that can be uploaded, the following requirements must be satisfied.

- Playback length: less than 20 seconds
- File Format: ".wav" (μ -law PCM 8bit, sampling frequency 8000 Hz, monaural)

If [Apply] is clicked without entering information, the sound clip registered in the camera will be deleted.

To delete a sound clip uploaded by [Add], click [Delete] next to the name of the sound clip.

[Sound Clip Name]

Enter the name of the sound clip to upload.

Be sure to enter the sound clip name.

[Video Record] > [Upload]

Settings for uploading video via FTP or HTTP when an event is triggered.

Important

- For using the upload function, the following settings are required according to each event.
 - [Video Record] settings in [Event] > [External Device] (P. 122), [Timer] (P. 125) and [Linked Event] (P. 128)
 - [Video Record] settings in [Detection] > [Audio Detection] (P. 105)
 - Settings in the [Event] tab of the Intelligent Function (P. 119).
- When the upload function is running, do not change the settings in the Settings page. Doing so may stop the operation.
- When using both uploading via FTP or HTTP and e-mail notification by text and video, set the video stream to be selected in [Video Type] to a small size.
- When the camera is set to upload or send e-mail notification continuously, it may not be possible to send all videos or e-mails depending on the video size and the network condition to the server.

Video Record Settings

When an event is triggered, it possible to set whether to upload the camera video via FTP or HTTP or to record to a memory card.

This can also be set in [Video Record] > [Memory Card Recording] (P. 99) and will be reflected in [Video Record Settings] here. A video type different from [Video Type] in [Video Record] > [Memory Card Recording] cannot be set.

[Video Record Action]

Select [Upload] to upload video.

[Video Type]

Select the video to be used for uploading from the video streams set in [Video] > [Video].

Important

- For setting H.264/H.265 video, it is necessary to set in [Video] > [Video] (P. 58) as follows.
 - [Frame Rate (fps)]: Other than [60] and [50] **[HM4x S820D/S920F]**
 - [Bit Rate Control]: Only [MBR] or [CBR]
 - [Maximum Bit Rate (kbps)], [Target Bit Rate (kbps)]: [8192] or less
 - [I Frame Interval (sec)]: either [0.5], [1], or [1.5]

General Upload

Set the upload method and video format for upload.

[Upload]

Select whether to upload via FTP or HTTP.

[Frame Rate]

When a video stream in JPEG format is selected in [Video Type], enter the maximum frame rate of the video to upload.

[Pre-event Buffer (number of frames)], [Post-event Buffer (number of frames)], [Pre-event Buffer (sec)], [Post-event Buffer (sec)]

Enter the number of frames or seconds of the video to be saved in the buffer before and after the event.

When the JPEG format video stream is selected in [Video type], enter the maximum number of frames in [Pre-event Buffer (number of frames)] and [Post-event Buffer (number of frames)].

When the H.264 or H.265 format video stream is selected in [Video type], enter the maximum number of seconds in [Pre-event Buffer (sec)] and [Post-event Buffer (sec)].

Important

- The maximum video buffer capacity is approx. 56 MB (**HM4x**)/approx. 5 MB (**S32VE S32D S820D/S920F**). If a large video size is set, the frame rate, pre-event buffer and post-event buffer may not be performed as set. If buffering cannot be performed as set, a message is displayed to the log (P. 158). Confirm that no messages are displayed in the log before use.

Note

- If the server or network load increases due to the upload settings, the video frame rate may drop. If this occurs, review the following settings to reduce the size and frequency of data to be uploaded.
 - Select a small size video stream (P. 58).
 - Reduce the number of frames or seconds in [Pre-event Buffer] or [Post-event Buffer].
 - If [Volume Detection Event] is enabled, disable [ON Event Operation], [OFF Event Operation] or [Ongoing ON Event Operation] (P. 104).
 - From the Intelligent Function [Event] tab, disable [ON Event Operation], [OFF Event Operation] or [Detected mode Operation] (P. 119).
 - If [External Device Input Event] is enabled, disable [Active Event Operation], [Inactive Event Operation] or [Ongoing Active Event Operation] (P. 122).
 - If [Timer Event] is enabled, increase the value in [Repeat Interval] (P. 124).

FTP Upload

Settings for the FTP upload function when [Upload] is set to [FTP Upload].

[Notification]

This is set to [Video].

[SSL Connection]

Select whether to enable SSL connection.

[Verify Server Certificate]

When [SSL Connection] is [Enable], set whether to verify the server certificate.

Note

- To verify a server certificate, it is necessary to import the CA certificate required for verification in [Security] > [Certificate Management] > [CA Certificate Management] in advance.

[FTP Server]

Enter the host name or IP address of FTP server.

[User Name], [Password]

Enter the user name and password required for authentication.

[PASV Mode]

Select whether to use PASV mode when connecting to an FTP server.

[File Upload Path]

Enter a path name of the destination (directory name) for video files to be uploaded to.

[File Naming]

Select a file naming rule for the upload file.

[YYYYMMDDHHMMSSms]

Video is uploaded with the file name of “{year}{month}{day}{hour}{minute}{second}{ms}.jpg”.

(Example: 20220601112122000.jpg)

[YYYYMMDD Directory/HHMMSSms]

First, create a subdirectory named "{year}{month}{day}" , then upload the video using the file name "{hour}{minute}{second}{ms}.jpg".

(Example: 20220601/112Z122000.jpg)

[Loop]

Video is uploaded with a file name numbered in sequence from 0000 up to the value set in [Maximum Number of Loops]. (Example: 0000.jpg, 0001.jpg) The number will return to 0000 when the maximum number of loops is reached.

Since the way FTP servers manage the upload of files with existing file names differs as follows, be sure to check the FTP server specifications before configuring this setting.

- Overwrite the existing file name
- Automatically save the file with a different name
- Generate an error

[Maximum Number of Loops]

If [File Naming] is set to [Loop], enter the maximum number of loops.

[User Settings]

Upload the video with the file name specified in [Subdirectory Name to Create] and [File Name to Create].

[Subdirectory Name to Create], [File Name to Create]

If [File Naming] is set to [User Settings], enter the subdirectory name to be created as well as the file name to create.

For entering, parameter description can be used with the "%" character (P. 161).

[Upload Test]

Clicking [Exec] initiates an upload test based on the set value already entered.

Only a single JPEG image will be uploaded, but it is not necessary to apply the set value at that time. After entering a password, first click [Exec], then click [Apply].

HTTP Upload

Settings for the HTTP upload function when [Upload] is set to [HTTP Upload].

HTTP upload is the function to send notifications via HTTP or images via HTTP according to the network camera events.

For information about the HTTP upload function and settings, contact a Canon's sales representative.

[Notification]

Select whether to send event information notifications only or notifications with attached videos when using HTTP upload.

[SSL Connection]

Select whether to enable SSL connection.

[Verify Server Certificate]

When [SSL Connection] is [Enable], set whether to verify the server certificate.

Note

- To verify a server certificate, it is necessary to import the CA certificate required for verification in [Security] > [Certificate Management] > [CA Certificate Management] in advance.

[URI]

Enter the HTTP server URI to upload to.

[User Name], [Password]

Enter the user name and password required for authentication.

[Proxy Server]

When using a proxy server, enter the host name or IP address of the proxy server.

[Proxy Port]

When using a proxy server, enter the port number of the proxy server.

[Proxy User Name], [Proxy Password]

Enter to use a user name and password for the proxy server.

[Parameter (query string)]

Enter the request parameters.

Parameters can be described using the "%" character (P. 161).

[Upload Test]

Clicking [Exec] initiates an upload test based on the set value already entered.

Only a single JPEG image will be uploaded, but it is not necessary to apply the set value at that time. After entering a password, first click [Exec], then click [Apply].



Important

- Enter [Proxy Server], [Proxy Port], [Proxy User Name] and [Proxy Password] only if connecting via a proxy server.

[Video Record] > [Memory Card Recording]

Settings for recording video to a memory card inserted in the camera. It is also possible to see the status of the memory card.

For operations of the memory card such as execution of mounting/unmounting and formatting, refer to [System] > [Memory Card] (P. 149).

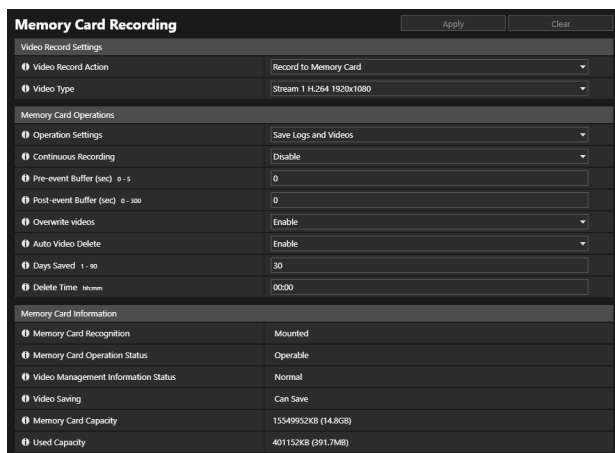

Important

- Information recorded to the memory card may be regarded as “personal information”. Take sufficient precautions for handling this information when releasing the camera to third parties for disposal, transfer or repair.
- For using memory card recording, the following settings are required according to each event.
 - [Video Record] settings in [Event] > [External Device] (P. 122), [Timer] (P. 125) and [Linked Event] (P. 128)
 - [Video Record] settings in [Detection] > [Audio Detection] (P. 105)
 - Settings in the [Event] tab of the Intelligent Function (P. 119).
- When recording to the memory card, do not change the settings in the Settings page. Doing so may stop the operation.
- When both memory card recording and text/video e-mail notification are used, set the video stream to be selected in [Video Type] to a small size.
- If memory card recording or mail notification is set to be executed continuously, video recording or mail transmission may not be possible depending on the size of the video or the writing speed of the memory card.

Note

- Memory card videos can be viewed and managed using the Recorded Video Utility. For information on operating the Recorded Video Utility and its downloaded data, refer to “Recorded Video Utility User Manual”.
- When a large number of files have been recorded onto a memory card, the Recorded Video Utility can take longer time to process the video list in proportion to the number of files. Please reduce the number of days saved in [Auto Video Delete], or manually delete unnecessary files with the Recorded Video Utility, on a regular basis.
Also, if a video stream with H.264 or H.265 video format is specified, the number of video files can be reduced compared to recording with a JPEG stream specified.
- For the supported memory cards and insertion and removal of the cards, refer to the "Installation Guide".
- When the memory card used in the camera for the first time, format the memory card first, after inserting it into the camera (P. 149).

Video Record Settings

Set whether to record the camera video to a memory card or upload it via FTP or HTTP.

These can also be set with [Video Record] > [Upload] (P. 95) and will be reflected in [Video Record Settings] here.

[Video Record Action]

When recording to a memory card, select [Record to Memory Card].

[Video Type]

Select the video to be used for memory card recording from the video stream set in [Video] > [Video].

Important

- For setting H. 264/H. 265 video, it is necessary to set in [Video] > [Video] (P. 58) as follows.
 - [Frame Rate (fps)]: Other than [60] and [50] **HM4x** **S820D/S920F**
 - [Bit Rate Control]: Only [MBR] or [CBR]
 - [Maximum Bit Rate (kbps)], [Target Bit Rate (kbps)]: [8192] or less
 - [I Frame Interval (sec)]: either [0.5], [1], or [1.5]

Memory Card Operations

The setting items will change depending on the memory card status (unmounted/mounted).

[Operation Settings]

Select the data to save to the memory card.

When [Save Logs and Videos] has been set, the following data is saved automatically.

- Videos of recording stream (only JPEG) that could not be distributed due to a network error
- Videos failed to be uploaded via FTP or HTTP
- Video files manually recorded by the user from the Camera Viewer
- Video files recorded by [External Device Input], [Audio Detection] and [Intelligent Function] when an event occurs
- Video files recorded using a timer
- Log
- Video recorded with ONVIF

Note

- New files cannot be saved to the memory card if there is no free space. When [Overwrite videos] is set to [Enable], old video can be deleted to save new video.

[Continuous Recording]

Select whether to record to the memory card continuously.

[Pre-event Buffer (number of frames)], [Post-event Buffer (number of frames)], [Pre-event Buffer (sec)], [Post-event Buffer (sec)]

Enter the number of frames or seconds of the video to be saved in the buffer before and after the event.

When the JPEG format video stream is selected in [Video type], enter the maximum number of frames in [Pre-event Buffer (number of frames)] and [Post-event Buffer (number of frames)].

When the H.264 or H.265 format video stream is selected in [Video type], enter the maximum number of seconds in [Pre-event Buffer (sec)] and [Post-event Buffer (sec)].

Depending on conditions, however, saving the set number of frames or seconds may not be possible.

[Overwrite videos]

When recording video to a memory card due to an event being triggered, select whether to allow overwriting data when the available space on the memory card becomes too small.

If [Enable] is selected, videos recorded due to an event, with timer or ONVIF will be overwritten starting from the oldest file.

If [Disable] is selected, use the Recorded Video Utility to delete unnecessary videos. For information on the operation, refer to "Recorded Video Utility User Manual."

[Auto Video Delete]

Select to automatically delete videos from the memory card that have exceeded the Days Saved.

If [Enable] is selected, set [Days Saved] and [Delete Time].

[Days Saved]

Enter the number of days for which video recorded to the memory card should be saved.

[Delete Time]

Enter the time to delete video that has exceeded the Days Saved.

Memory Card Information

Displays the current status of the memory card inserted in the camera and information about card capacity. Also, similar information is displayed in [System] > [Memory Card] > [Memory Card Information] (P. 149).

[Memory Card Recognition]

Displays the current status of the memory card.

[Memory Card Operation Status]

Displays the operation status of the memory card.

When [Operable] is displayed, all operations are possible.

When [Recreating video management information] is displayed, video management information is being recreated. Other operations cannot be performed.

When [Deleting videos] is displayed, videos are being deleted. Other operations cannot be performed.

[Video Management Information Status]

Displays the status of the video management information.

When [Normal] is displayed, video management information is normal.

When [Video Management Information Recreation Required] is displayed, management files of the video records are corrupted or not consistent with saved video files.

It is necessary to click [Exec] in [Recreate Video Management Information] to recreate the management file.

If the management files are not recreated even when [Recreate Video Management Information] is used, [Format] (P. 149) must be used.

[Video Saving]

Displays whether videos can be saved to the memory card.

[Cannot Save] may occur for the following reasons.

- Memory card is not mounted.
- The video management file is corrupted.
- The card is write-protected.
- The memory card is full and [Overwrite videos] is set to [Disable].

[Memory Card Capacity]

Displays the memory card capacity.

[Used Capacity]

Displays the current used capacity of the memory card.

[Video Record] > [E-mail Notification]

Settings for sending an e-mail notification to a specified recipient when an event is triggered.

Field	Value
Notification	Text Only
Copy E-mail Settings	Exec
Mail Server Name	
Mail Server Port	25
Sender (From)	
Recipient (To)	
Authentication	POP before SMTP
User Name	
Password	*****
Verify Server Certificate	Verify
POP Server	
Subject	
Message Body	
E-mail Notification Test	Exec

E-mail Notification

Set the mail server to be used for e-mail notifications and the content of the e-mail to be sent.

[Notification]

Text is [Subject] and [Message Body].

If set to [Text with Video], an image (JPEG format) captured just before the event will be attached.

[Copy E-mail Settings]

Copy the e-mail settings used in [Maintenance] > [Log] > [Log Notifications] (P. 158). However, [Password] is not copied.

[Mail Server Name]

Enter the host name or IP address of the SMTP server.

[Mail Server Port]

Enter the port number of the SMTP server. When making email notification via SMTPS, set "465" or "587."

[Sender (From)]

Enter the e-mail address of the sender.

[Recipient (To)]

Enter the e-mail address of the recipient.

[Authentication]

Select an authentication method suited to the destination SMTP server.

[User Name], [Password], [POP Server]

Enter the user name and password needed for authentication, and host name or IP address of the POP server when e-mail authentication is set to [POP before SMTP].

[User Name], [Password]

Enter the user name and password needed for authentication when e-mail authentication is set to [SMTP-AUTH].

[Verify Server Certificate]

When making email notification via SMTPS, set whether to verify the server certificate.

Note

- To verify a server certificate, it is necessary to import the CA certificate required for verification in [Security] > [Certificate Management] > [CA Certificate Management] in advance.

[Subject]

Enter the subject of the e-mail in alphanumeric characters.

[Message Body]

Enter the message body (text) of the e-mail in alphanumeric characters.

The parameter description by "%" character is possible in the text (P. 161).

[E-mail Notification Test]

Clicking [Exec] initiates an e-mail notification test based on the settings currently entered.

It is not necessary to click [Apply]. After entering a password, first click [Exec], then click [Apply].

[Detection] > [Audio Detection]

When loud sound is inputted from the microphone, or the audio expected to be inputted is interrupted, operations such as video recording or e-mail notification can be triggered.

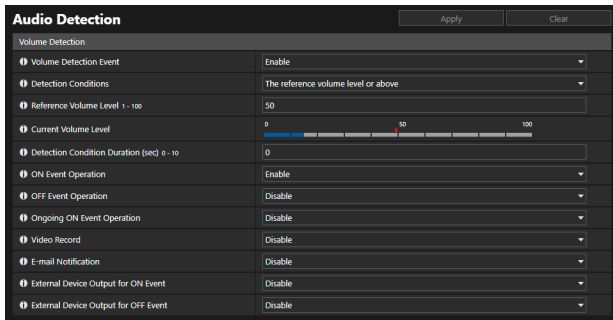

Important

- For notes on use of audio detection, refer to "Built-In Camera Functions" (P. 8).

Note

- Able to check the audio detection status on the [Event and Input/Output Menu] of the Camera Viewer (P. 50).

Volume Detection

A volume detection event will be triggered when audio input volume is detected exceeding or falling below the reference volume setting.

Set the conditions for triggering a volume detection event and the operations to perform according to an event.

Important

- Volume detection is temporarily disabled when an event causes the playback of a sound clip or when audio is transmitted from the Viewer.
- When [Audio] > [Audio] > [General Audio] > [Mute During Pan/Tilt] is set to [Mute], the volume detection function is temporarily disabled while the camera is panning or tilting. [S32VE](#)

[Volume Detection Event]

Select whether to use volume detection event.

[Enable] cannot be selected if [Audio] > [Audio] > [General Audio] > [Audio Input] is set to [Disable].

[Detection Conditions]

Select the condition for triggering a volume detection event.

[Reference Volume Level]

Enter the reference volume level to be used for detection.

Set the reference volume level by performing an actual test while checking [Current Volume Level] before configuring the setting.

Note [S32VE](#)

- When the settings in [Audio] > [Audio] > [Audio General] > [Low-Cut Filter] (P. 92) are changed, review the [Reference Volume Level] settings.
- If the [Reference Volume Level] is set low, the zoom and focus drive sounds may be detected mistakenly.

[Current Volume Level]

The current volume level is displayed on the status bar.

The level set in [Reference Volume Level] is indicated by a red mark. Volume below the reference level is displayed in blue, that above the reference level is displayed in red.

[Detection Condition Duration (sec)]

When the status meeting the volume detection condition has continued for the specified duration or longer, an ON event is triggered.

[ON Event Operation]

If [Enable] is set, the processes set in [Preset] (HM4x S32VE S32D), [Video Record] and [E-mail Notification] will be executed according to their settings when a volume detection event is triggered (ON event).

[OFF Event Operation]

If [Enable] is set, the processes set in [Preset] (HM4x S32VE S32D), [Video Record] and [E-mail Notification] will be executed according to their settings when a volume detection event is completed (OFF event).

[Ongoing ON Event Operation]

Select the operation to be performed during an ON event. This can be set when [ON Event Operation] is set to [Enable]. If [Enable] is selected, the processes set in [Video Record] and [E-mail Notification] will be executed during the volume detection event.

[Preset] HM4x S32VE S32D

If a preset is specified, the camera angle will automatically move to the preset location when a volume detection event is triggered.

It is necessary to set presets beforehand in [Video] > [Preset] (P. 61).



Important

- When the camera is triggered by a volume detection event and moved to a preset position specified in the [Preset] settings, camera control privileges are released, even if the user has obtained those camera control privileges using the Camera Viewer or other camera control applications.

[Video Record]

Select whether to record video triggered by the volume detection event.

When [Enable] is selected, video will be transmitted to the recording destination specified in [Video Record] > [Upload] > [Video Record Settings] > [Video Record Action] (P. 95).

[E-mail Notification]

Select whether to send an e-mail notification triggered by the volume detection event.

If [Enable] is selected and a volume detection event is triggered, an e-mail notification will be sent.

To use e-mail notification, it is necessary to set [Video Record] > [E-mail Notification] (P. 102) beforehand.

[External Device Output for ON Event]

Select the actions of the external device to output when an ON event is triggered.

[External Device Output for OFF Event]

Select the actions of the external device to output when an OFF event is triggered.

[Detection] > [Intelligent Function] - Overview -

Intelligent Function

The Intelligent Function starts events such as video record, e-mail notifications, and audio playback when it detects changes in the video due to subject movement.

The Intelligent Function has the following operation modes.

- Video Detection
- Audio Detection

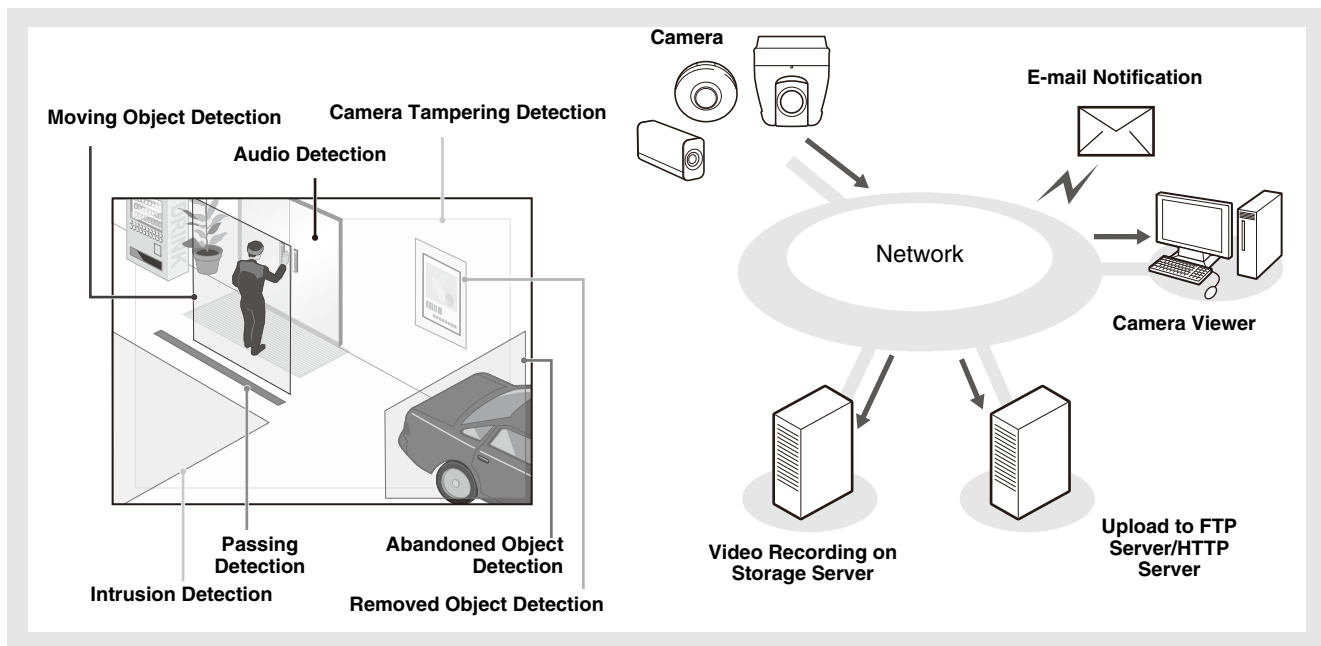

Notes on Use of This Camera

The Intelligent Function is not suitable for applications where high reliability is required. It is not recommended to use this function for usage such as surveillance where very high reliability is required. Canon shall assume no liability for any accident, loss or other undesirable outcomes resulting from Intelligent Function operations.

Video Detection

Detects changes in the video in a set detection area. There are seven detection types to suit the users needs.

Moving Object Detection

Detects moving objects. This function can be used to detect visitors or suspicious individuals. Moving object detection is triggered while moving objects are inside the detection area.

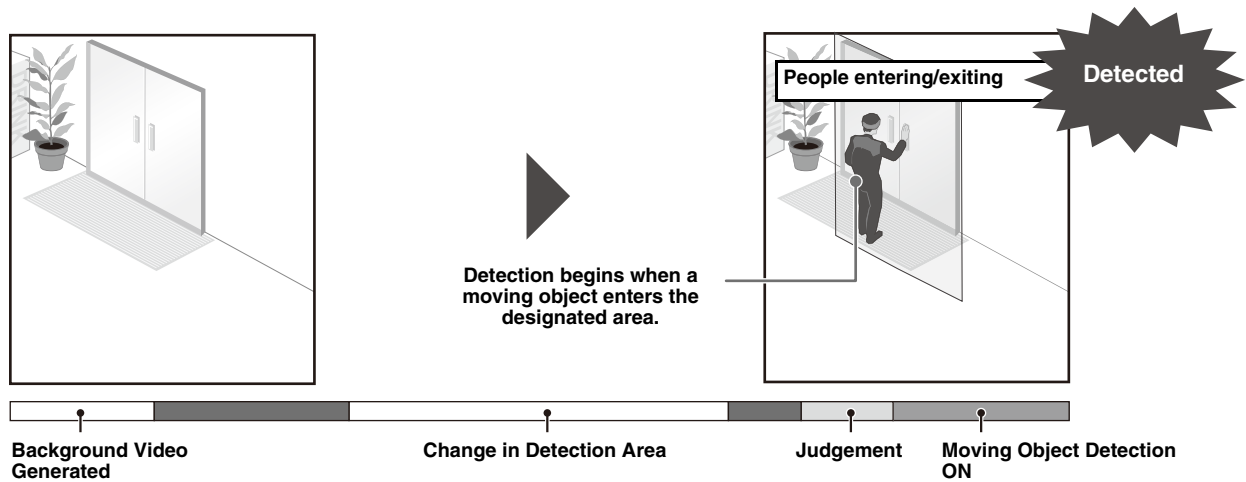

Abandoned Object Detection

Detect objects that are carried in and abandoned for more than a certain duration. This function can be used to detect suspicious objects that have been left behind.

An object is judged as abandoned if it is left and remain in the detection area for longer than the specified duration.

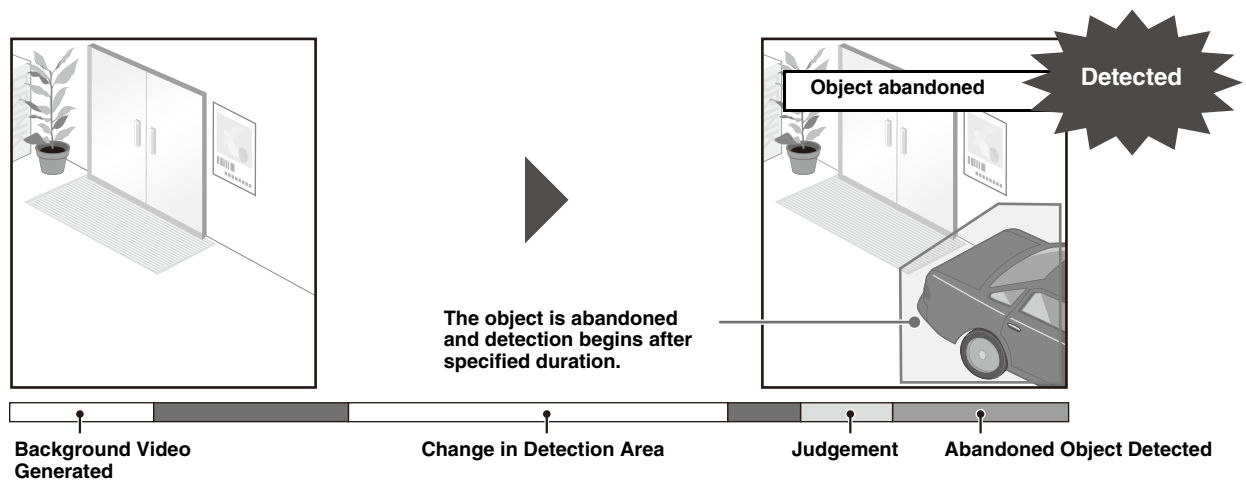

Removed Object Detection

Detect objects that have been removed. This can be used to detect actions such as taking away valuables.

An object is judged as removed if it is taken away from the detection area for longer than the specified duration.

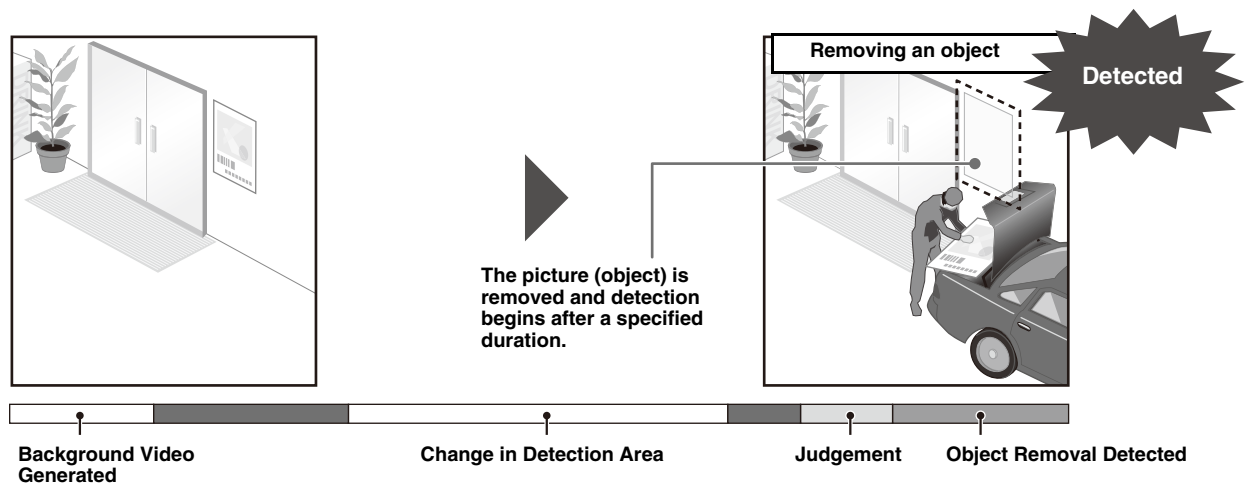

Camera Tampering Detection

Detect when capture is being interrupted. This can be used to detect when the camera orientation is changed or the video display is hindered with spray, etc.

Camera tampering detection is judged to have occurred when an area exceeding the set ratio of the object is continuously altered.

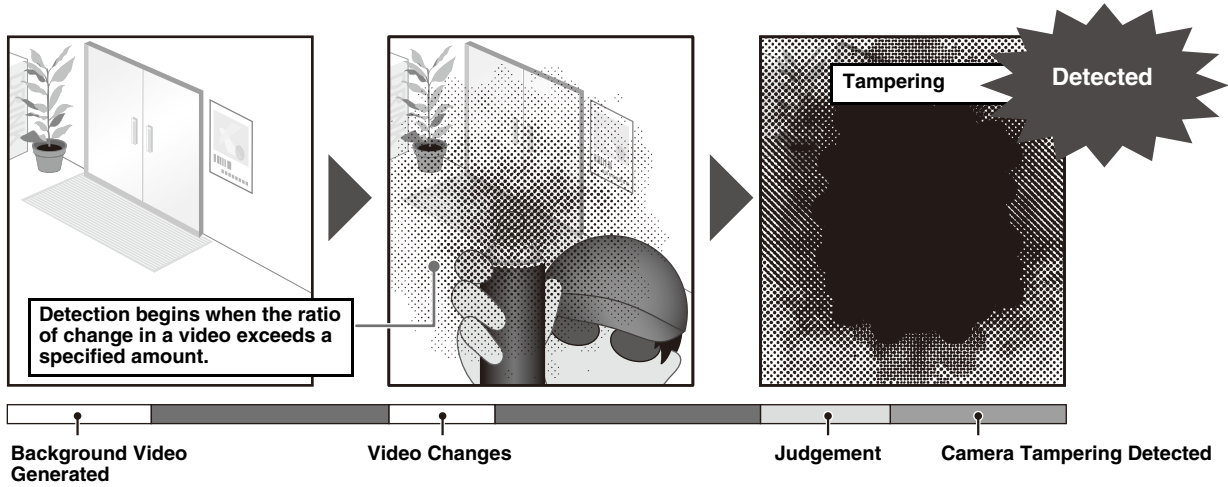

Passing Detection

Detect when a person or moving object crosses a specified line.

This determines that an object passed the line when the decision point of the object detection frame crosses a detection line.

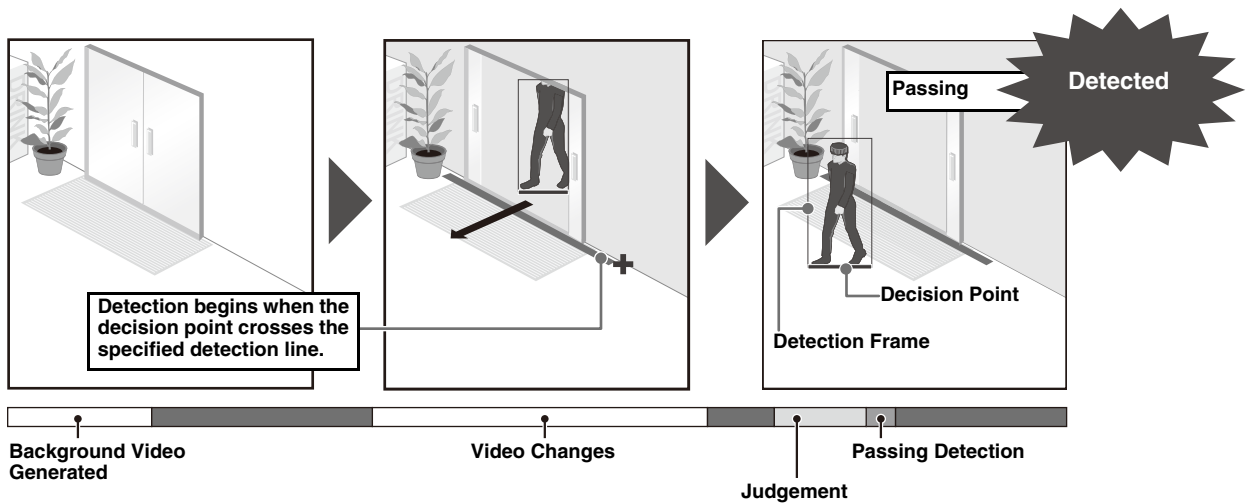

Intrusion Detection

Detect when a person or moving object entered into a specified area. This can be used to detect the act of intrusion, such as breaking in over the fence of the exclusion zone of places such as in museums. This determines that intrusion by an object has occurred when the decision point of the object detection frame enters the detection area and the specified duration has elapsed.

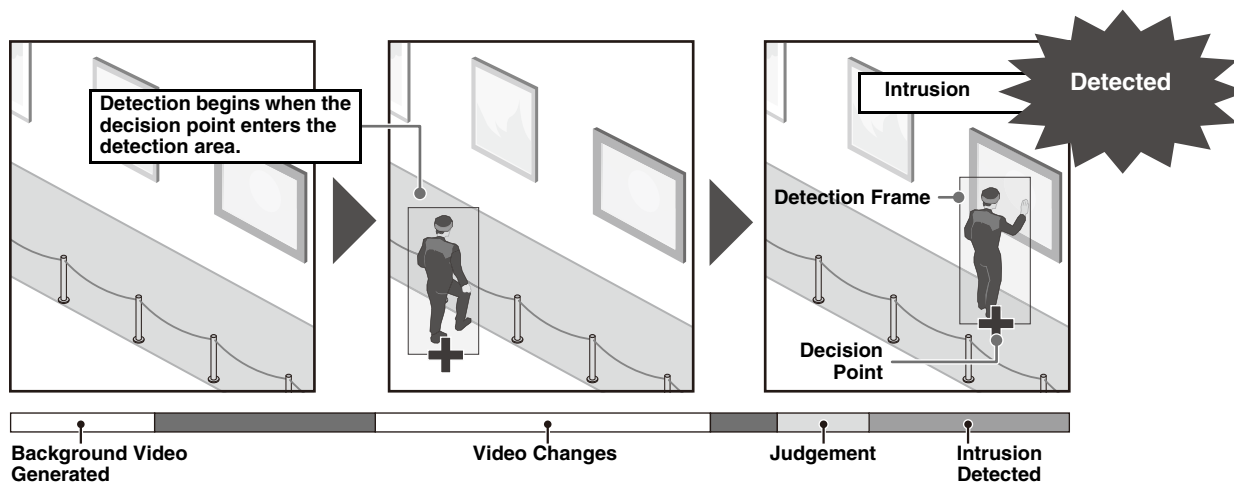

Face Detection

Able to acquire face information of a person in the video and use it for analysis by an external system or application.

■ Audio Detection

Detects audio input to the camera.

Volume Detection

Function which detects whether the volume level input to the camera is greater or less than the reference value set in the settings.

These are set with [Audio Detection] > [Volume Detection] (P. 104), not with [Intelligent Function].

Notes on Intelligent Function Settings and Operations

- When setting the Intelligent Function, perform an actual detection test to confirm that detection will be performed correctly.
- If a sudden change in lightness or darkness occurs within the entire screen, proper detection may not be possible for up to six minutes.
- In order to detect movement of objects, the intelligent function internally generates and stores video without movement as background image. The intelligent function restarts and regenerates background images in the following cases. It may take tens of seconds to restart depending on the settings. No detection is performed during this time. For more information regarding restart settings, refer to [Option Settings] > (2) [Reset Processing] (P. 112).
 - When operating the camera while Intelligent Function is being set or is operating
 - When switching to day mode/night mode (P. 65)
 - When running [Restart intelligent function] (P. 110)
- If each video stream is changed in [Video] > [Video], be sure to change the preset position settings and Intelligent Function settings, and check operations. The Intelligent Function may not operate, depending on the settings.
- Image shift due to camera vibration may be detected as image change.
- If the camera vibrates excessively, the detection result may not be displayed properly even if image shift is reduced by applying Image Stabilizer. **HM4x**

HM4x S32VE S32D

- When the image is zoomed in (telephoto), detection may not work as expected.
- Please review the Intelligent Function if the angle of view has changed through camera operation, or the preset/home position fixing the camera position has changed.
- If there are [Enable] detection settings in [Status] of [Detection Settings] when the camera position is fixed, control privileges cannot be obtained by the Viewer connected by the user without privileges for privileged camera control. Also, the preset tour (**HM4x**) will no longer run.
- If a preset registered in the digital zoom area is used, it may not be possible to reproduce the camera position at registration with high accuracy. Therefore, it is recommended to use a preset registered in the optical zoom area for the intelligent function.

Important

- For using the intelligent function, set [Maintenance] > [Environment] > [Intelligent Function] to [Enable].

Difficult-to-Detect Subjects

The following subjects may not be detected, or may result in erroneous detection.

- Objects or areas where there is little contrast in color or brightness with the background may not be detected.
- Small objects and changes on the screen may not be detected.
- Changes in brightness in all or part of the angle of view may trigger detection.
- When there are multiple overlapping objects, the detection function may be affected.. For example, objects passing may not be detected or detected at the wrong timing.
- When there are a large number of objects in the screen, it may not be properly detected.

Register Presets in Advance

HM4x S32VE S32D

It is strongly recommended to register the camera angle as a preset in advance and lock the camera to the preset position when using video detection. It is also recommended to use the angle of view that captures targeted objects larger.

For information regarding preset register, refer to [Video] > [Presets] (P. 61).

Settings Screen

In video detection, select the type to detect, and set the detection area for video changes while checking images on the camera. Set which operations (e-mail notification, record video, outputting to an external device, etc.) should be carried out when changes are detected.

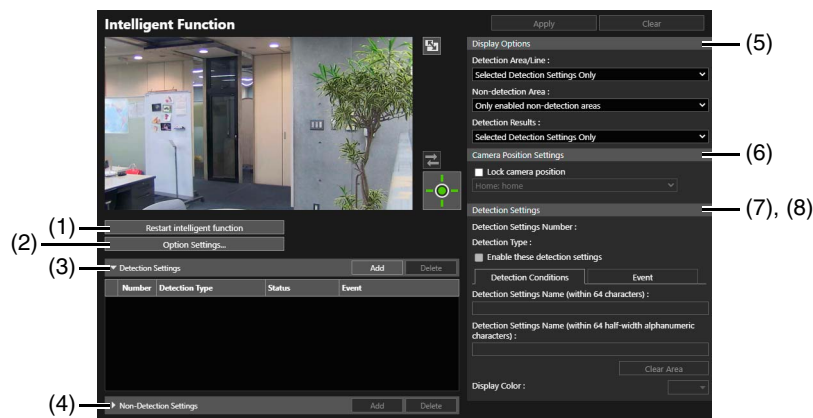

(1) [Restart intelligent function]

If the background image changes during setting of the Intelligent Function, or if the detection result does not match the settings, restart the Intelligent Function by clicking with the camera control privilege.

Important

- It may take tens of seconds to restart depending on the settings. No detection is performed during this time. For more information regarding restart settings, refer to [Option Settings] > (2) [Reset Processing] (P. 112).

(2) [Option Settings]

Change the option for the detection settings. For details, refer to “[Option Settings]” (P. 111).

(3) [Detection Settings]

Click [Add] to display [New Detection Settings] and add new detection settings. For details, refer to “Steps for Configuring Video Detection” (P. 112).

When a detection setting is added, [Number], [Detection Type], [Status] and [Event] appear as a list. Able to add up to

nine detection settings.

When the detection settings is at a detection applicable state, the event icon turns green. Able to check the detection status on the [Event and Input/Output Menu] of the Camera Viewer (P. 50).

Select the detection settings in the list and click [Delete] to delete the detection settings.

(4) [Non-Detection Settings]

Able to set an area where changes are not detected, to prevent mis-detection and non-detection.

If [Add] is clicked, it is possible to click the video display area to set the non-detection area. For details, refer to "Setting a Non-Detection Area" (P. 113).

When a non detection area is added, [Number], [Non-detection Area Name], and [Status] appear in a list. Up to four non-detection settings can be registered.

Select a Non-Detection Area in the list and click [Delete] to delete the Non-Detection Area.

(5) [Display Options]

Set the [Detection Area/Line], [Non-detection Area], and [Detection Results] displayed in the video display area. Able to select the following setting values:

- [Selected Detection Settings Only]: Displays only settings selected in the detection settings list.
- [Only selected non-detection areas]: Displays only settings selected in the non-detection settings list.
- [All Detection Settings]: Displays all settings in the selected detection settings list.
- [All non-detection areas]: Displays all settings in the non-detection settings list.
- [Detection Settings of the Same Type]: Displays the detection settings of the same type as the detection settings selected in the detection settings list.
- [Only enabled non-detection areas]: Displays the settings of the non-detection settings with [Status] set to [Enable] in the non-detection settings list.
- [Disable]: Displays none.

(6) [Camera Position Settings]

Select this check box to perform video detection when camera position is fixed.

HM4x S32VE S32D

Select the camera position for video detection from pre-registered presets.

If checked, video detection stops while the administrator changes the camera position from a preset position. When the administrator releases control, it returns to the preset position and resumes video detection. Also, the guest user will not be able to change the camera position.

If not checked, changing the camera position will cause intelligent function to restart and continue video detection.

S820D/S920F

If checked, video detection will be stopped while the administrator changes the zoom from the position set in [Video] > [Camera Angle]. When the administrator releases control, it returns to the zoom position set in [Video] > [Camera Angle] and resumes video detection.

If not checked, changing the zoom position will cause intelligent function to restart and continue video detection.

(7) [Detection Settings]

Able to check or set the contents of the detection settings selected in the detection settings list. For details, refer to "[Detection] > [Intelligent Function] - Detection Settings -" (P. 115).

(8) [Non-Detection Settings]

Able to check and set the contents of the non-detected area selected in the non-detected settings list. For details, refer to "Setting a Non-Detection Area" (P. 113).

■ [Option Settings]

Click [Option Settings] to display the following screen and adjust the Intelligent Function settings.

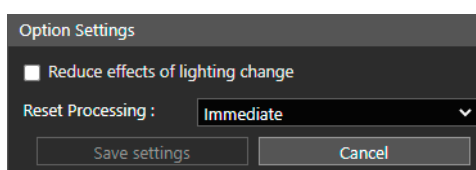

(1) [Reduce effects of lighting change]

The Intelligent Function may not work when the entire screen is exposed to sudden changes in brightness, for example, when indoor lights are turned on or off. Changing the settings of this item may reduce this effect.

Important

- Settings in [Reduce effects of lighting change] may not work correctly depending on the operating environment. Repeated sudden changes in brightness may also have the same effect. Perform an actual detection test to check whether the detection works correctly.

(2) [Reset Processing]

Able to select the Reset Processing method to generate the background image.

Select [Immediate] when there are no moving objects in the video during the Reset Processing. Reboots in seconds. If there is a moving object in the video, it will be included in the background image and will not be able to be detected correctly.

Select [Standard] when there are moving objects in the video during Reset Processing. Reboot takes about tens of seconds. Able to generate the background image even if there are moving objects in the video.

Select [High Precision] if there are moving objects or if there is a person stopping in the video during Reset Processing, or if the Rest Processing in [Standard] does not detect correctly. Reboot takes about 1 minute.

Important

- When set to [Immediate], the abandoned object detection or the removed object detection cannot be performed during tens of seconds after restarting.

(3) [Save settings]

Reflect settings and close the [Option Settings] screen.

(4) [Cancel]

Cancel settings and close the [Option Settings] screen.

Steps for Configuring Video Detection

The following are the basic settings for configuring a detection area. For the detailed settings of each detection settings, refer to “[Detection] > [Intelligent Function] - Detection Settings -” (P. 115).

Important

- It is recommended to configure the detection criteria in conditions as close as possible to the actual conditions in which the camera is used.

1 Select whether to perform video detection by fixing the camera position.

Select the [Lock camera position] checkbox in [Camera Position Settings], then select a preset. For details on how to preset settings, refer to “Registering a Preset” (P. 69). **HM4x S32VE S32D**

Select the [Lock camera position] in [Camera Position Settings]. **S820D/S920F**

Note **HM4x S32VE S32D**

- Able to select presets that meet the following conditions.
 - Set within the view restriction area
 - Presets with pan, tilt and zoom setting values (not blank) configured in [Register Preset]

2 Add Detection Settings

When [Add] in [Detection Settings] is clicked, [New Detection Settings] appears. Select [Detection Settings Number] (1 to 9) and [Detection Type], then click [OK].

The detection settings added to [Detection Settings] are displayed and [Enable these detection settings] is selected.

Note

- The number of detection settings that can be set depends on detection type. Camera tampering detection and face detection can each have one, passing detection can have up to three, and the rest can be set until all detection types add up to nine.

- To disable the detection settings, clear the [Enable these detection settings] checkbox.

3 Set Detection Conditions and Event

Detection conditions are set in the video display area and on the [Detection Conditions] tab, and events are set in the [Event] tab. The detection conditions differ according to the detection type. Operate and confirm the detection conditions to set for each type of detection in the video display area.

4 To register multiple detection settings, repeat steps 2 to 3.

5 Click [Apply].

The settings are saved in the camera.

Able to check the detection status of the configured detection settings in video display area, the [Event] column in [Detection Settings] or the [Event and Input/Output Menu] in the Camera Viewer (P. 50).

Note

- If wanting to redo the settings, click [Clear] before applying and it will revert to the settings saved on the camera. However, note that detection settings only added to the detection setting area will all be discarded.

■ Setting a Non-Detection Area

Able to set an area where changes are not detected, to prevent mis-detection and non-detection.

If there are too many objects in the screen preventing the detection of movement as intended in the targeted area, setting a non-detection area may suppress unnecessary detection and improve the detection status.

Important

- The contents set in the non-detection settings are reflected in detection settings excluding camera tampering detection and face detection.
- If the area in the detection settings and the area in the non-detection settings overlap, the non-detection settings are used.

1 Click [Non-Detection Settings] to display the list of non-detection settings and then click [Add].

The details of detection settings added to the non-detection settings list are displayed and [Enable non-detection area] is selected.

Note

- To disable non-detection area settings, clear the [Enable non-detection area] checkbox.
- Enter [Non-detection Area Name (within 64 characters)] or [Non-detection Area Name (within 64 half-width alphanumeric characters)] as necessary. If both are entered, [Non-detection Area Name (within 64 characters)] takes precedence.

2 Set a non-detection area in the video display area.

Click on the video display area to create a polygon. For instructions, refer to “Area Setting” (P. 116).

The non-detection area is shown in the video display area in black. The display color cannot be selected.

3 To register multiple non-detection areas, repeat steps 1 and 2.

4 Click [Apply].

The settings are saved in the camera.

The status of the specified non-detection settings can be checked in the video display area and the [Status] column in [Non-Detection Settings]. If the [Enable non-detection area] checkbox is cleared, [Disable] is displayed for the [Status] column in [Non-Detection Settings], and the non-detection area is not shown in the video display area.



Important

- Make sure to check the video display area to see whether the detection settings area and non-detection settings area are not unintentionally overlapped. If the detection setting area and non-detection setting area are set close to each other, detection may be performed incorrectly.



Note

- Click [Clear] to discard the settings and restore the settings saved in the camera. However, note that detection settings only added to the non-detection settings area are all discarded.

■ Right-Clicking Menu

When right-clicking on the video display area, detection settings list, or non-detection settings list, a menu appears that makes it possible to copy, paste, or clear the detection area/non-detection areas, detection line, and detection conditions. It is also possible to copy and paste settings value of the detection area or event. Unavailable functions will be grayed out when right-clicking.



Note

- Copying detection conditions settings value does not copy the detection settings name or display name.
- [Paste detection condition settings] is possible only if the source and the target are of the same detection type.

[Detection] > [Intelligent Function] - Detection Settings -

In [Detection Settings], detection conditions of each detection and action at detection are set.

[Detection Conditions]

Moving Object Detection

Abandoned Object Detection/Removed Object Detection

Camera Tampering Detection

Passing Detection

Intrusion Detection

Face Detection

The items that can be set vary depending on detection type.

	Moving Object Detection	Abandoned Object Detection	Removed Object Detection	Camera Tampering Detection	Passing Detection	Intrusion Detection	Face Detection
Detection Settings Name (within 64 characters)	✓	✓	✓	✓	✓	✓	✓
Detection Area	✓	✓	✓			✓	
Detection Line					✓		
Display Color	✓	✓	✓	✓	✓	✓	✓
Passing Direction					✓		
Duration (Sec)		✓	✓			✓	
Decision Point					✓	✓	
Object Height (%) Object Width (%)	✓	✓	✓		✓	✓	

	Moving Object Detection	Abandoned Object Detection	Removed Object Detection	Camera Tampering Detection	Passing Detection	Intrusion Detection	Face Detection
Change Ratio (%)				✓			
Detection Precision							✓

[Detection Settings Name (within 64 characters)], [Detection Settings Name (within 64 half-width alphanumeric characters)] Detection Settings Name is set. If both are entered, [Detection Settings Name (within 64 characters)] takes precedence.

Detection Area, Detection Line

Refer to “Setting Area or Line” (P. 116).

[Display Color]

Able to change the color of the detection area and detection line.

[Passing Direction]

Able to set which direction an object surpasses the detection line to consider it as passing. The selected passing direction is displayed as a preview on the detection line in the video display area.

[Duration (Sec)]

The elapsed time is set for the object’s placement in abandoned object detection, and the object’s intrusion in intrusion detection, before determining that it is abandoned/intrusion.

[Decision Point]

Set which position of the object is used to determine as passing or intrusion. The decision point is indicated by a cross on the detection frame of the object.

[Object Height (%)], [Object Width (%)]

The height and width of the object are used to set the size of the objects to be detected in the set detection area. When the setting values or slider is changed, an indicator representing the object size is shown for one second in the video display area allowing the user to check the size ratio while specifying the setting.

Note

- A ratio of up to 80% can be set in [Object Height (%)], [Object Width (%)] for passing detection.

[Change Ratio (%)]

Able to set the ratio of screen change for the entire video display area to determine as tampering detection. When the numerical value slider is changed, an indicator representing the ratio against the entire video display area is shown for one second in the center of the video display area allowing to check while specifying the setting.

Note HM4x S820D/S920F

- Review the [Change Ratio (%)] when the settings of [Video] > [Preset] > [Exposure/Compensation] > [Use WDR] are changed.

[Detection Precision]

Able to set the numeric value for determining the face likelihood of a person. The higher the number, the more difficult it is to identify the face as that of a person.

Setting Area or Line

The detection area, non-detection area and the line for passing detection are set by clicking video display area.

■ Area Setting

The detection and non-detection areas are specified by creating up to 8 vertex polygons.

Click on video display area to create polygon’s vertex. Place the vertices in order, then either click the first vertex again or double-click the last vertex to create the polygon detection area. Also, drag the area to move it, and drag the vertices to reshape it.

Click [Clear Area] to delete the detection area that has been set.

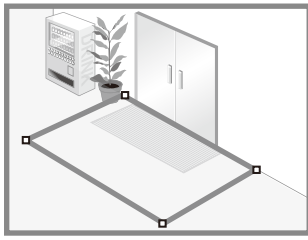

 **Note**

- It is not possible to set dented polygons (polygons with vertices with interior angles greater than 180 degrees) or overlapping edges as regions.

■ Line Setting

The line that detects passing is set between the points by clicking the starting point in the video display area and then clicking another point.

Click [Clear Line] to delete a detection line that was set.

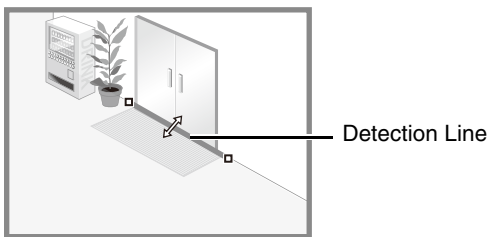

 **Note**

- Even after configuring a detection line, it is possible to drag each vertex to change the length or direction of the detection line or the line between vertices to move the entire detection line.

Displaying Detection Status

Able to check the detection status on the screen. This section describes how to display the detection status screen for each detection type.

■ Moving Object Detection

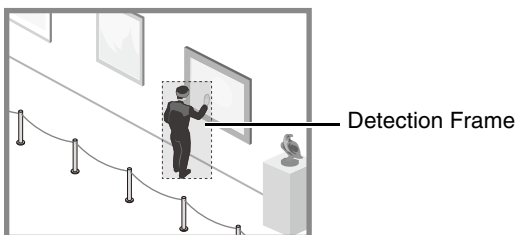

All moving objects detected are displayed with detection frames. If they do not meet the [Object Height (%)] and [Object Width (%)] conditions, detection frames are displayed as dotted white line, and if they do, detection frames are displayed with the same color as the detected area, indicating a "detected" state.

■ Abandoned Object Detection, Removed Object Detection

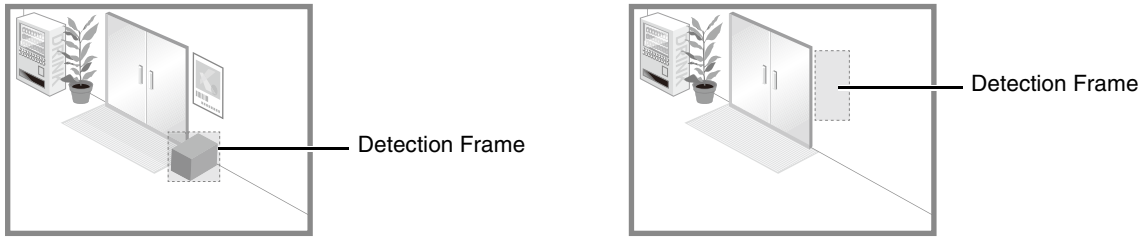

Detection frames appear on the objects that have been detected for movement and stayed still for five seconds. If [Object Height (%)], [Object Width (%)] and [Duration (Sec)] are not met, the detection frame is displayed with a white dot line. If [Object Height (%)], [Object Width (%)] and [Duration (Sec)] are all exceeded, the detection frame is displayed in the same color as the detection area to indicate that something has been detected.

🔒 Important

- A removed object may not be detected in the following cases.
 - When long and thin objects are removed
 - When the same object is placed continuously and some of the objects are removed
 - When objects of the same shape are placed together and some of the objects are removed
- If the video inside the detection area changes without an object being removed, it may be misdetected as a removed object.

■ Camera Tampering Detection

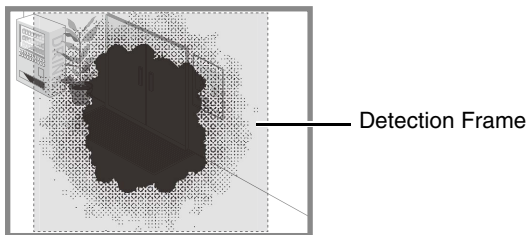

Moving objects detected are displayed with detection frames. If an object is smaller than [Change Ratio (%)], its detection frame is displayed with white dot line. If the obscured area in the video exceeds [Change Ratio (%)], the detection frame takes on the same color as the detection area, indicating that the camera has “detected” tampering.

🗨 Note

- Detection will not be possible for three seconds after the change ratio for camera tampering detection is changed, or when switching to camera tampering detection settings from settings for another detection mode.

■ Passing Detection

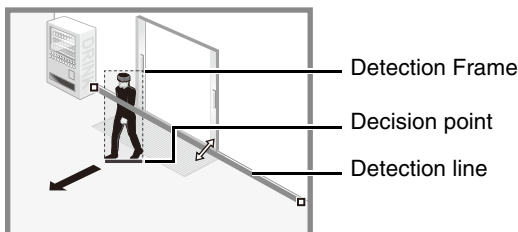

All moving objects detected are displayed with white detection frames.

When the [Decision Point] of an object that meets the [Object Height (%)] and [Object Width (%)] setting crosses a detection line in the direction set in [Passing Direction], the detection frame changes to the same color as the detection line, and the status becomes “detected”. Notification of a passing detection event occurs only when the decision line is crossed.

🔒 Important

- Perform a detection test after configuring passing detection to make sure the detection frame of a moving object continues to be displayed.

Intrusion Detection

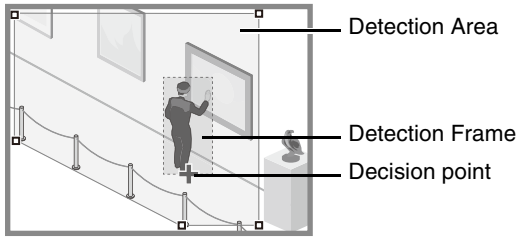

All moving objects detected are displayed with detection frames.

When [Decision Point] of an object that meets the [Object Height (%)] and [Object Width (%)] enters a detection area and exceeds [Duration (Sec)], the detection frame changes to the same color as the detection area, and the status becomes "detected".



Important

- After the Intrusion Detection is set, conduct a detection test to confirm that the detection frame of the object continues to be displayed.

Face Detection

A face frame appears on all faces which is detected.



Note

- In face detection, it is unable to specify the operation for "detected".
- The following are the main examples of failure to detect faces:
 - When the face is extremely small, large, dark, or bright relative to the entire screen
 - When the face is facing sideways or diagonally, or the face is upside down
 - When part of the face is hidden
- May detect a subject other than a person as a face by mistake.

[Event]

Set operations to be performed upon detection of changes in a subject.



Note

- In face detection, the [Event] tab is disabled.

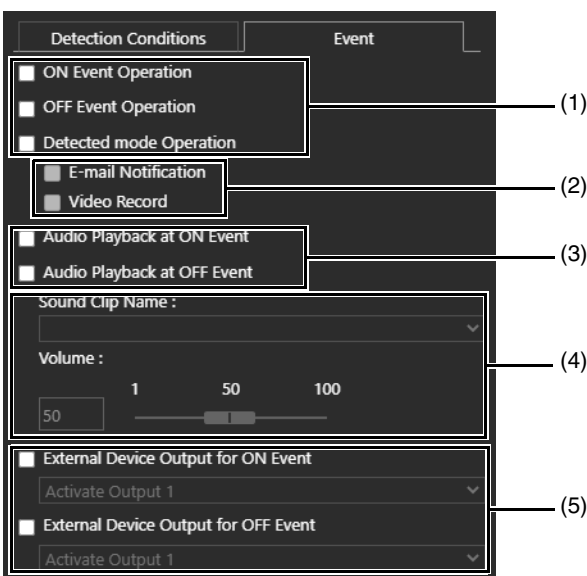

- (1) [ON Event Operation], [OFF Event Operation], [Detected mode Operation]
Specifies the operation timing. Multiple selections are possible.

If any of these are selected, the processing settings described in (2) will be performed when the status changes to "detected", when the operation is terminated, or while the status remains "detected".

(2) [E-mail Notification], [Video Record]

Specifies the event operation. Multiple selections are possible.

If [E-mail Notification] is selected, an e-mail notification will be sent at the timing set in (1) according to the setting in [Video Record] > [E-mail Notification] (P. 102).

If [Video Record] is selected, the video is recorded at the timing set in (1) according to the settings in [Video Record] > [Upload] > [Video Record Settings] (P. 95) or [Memory Card Recording] > [Video Record Settings] (P. 99).

(3) [Audio Playback at ON Event], [Audio Playback at OFF Event] **HM4x S32VE**

Specifies the audio playback timing.

When selected, the audio set in (4) is played back when the status becomes "detected" or when operation is terminated.

(4) [Sound Clip Name], [Volume] **HM4x S32VE**

Specifies the audio to playback at the timing set in (3).

Select an sound clip from audio registered in [Audio] > [Audio] sound clip file register 1 to 3 (P. 94) and set the volume for the sound clip.

(5) [External Device Output for ON Event], [External Device Output for OFF Event]

Specifies the external device output operation.

Select this to start or stop output to an external device when the status becomes "detected" or when operation is terminated, and select the operation (active or inactive).

[Event] > [External Device]

Operation settings for external device output and for external device input triggered events.

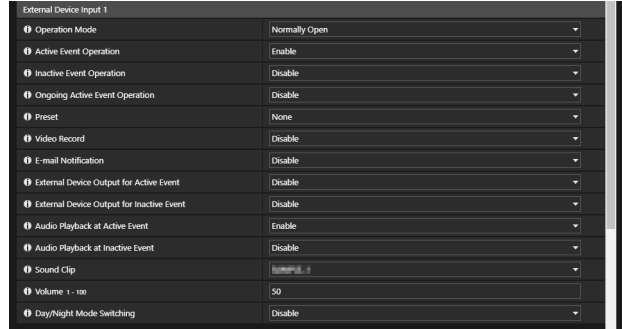
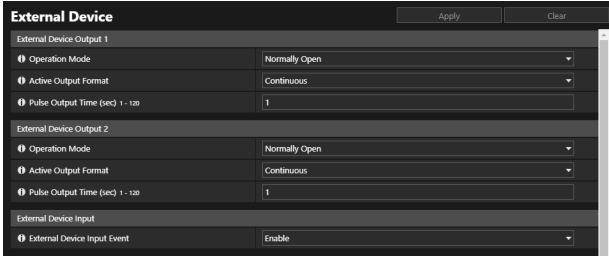

External Device Output

Set the operation for output to the external device.

The camera has two external device outputs. It is possible to set the output for each of them. **HM4x**

Note

- The output for an external device can be switched between active and inactive with [External Device Output] of the Camera Viewer (P. 50).

[Operation Mode]

Select whether the output terminals are normally open or closed.

If [Normally Open] is set, an active event occurs when the output terminal connection closes, and an inactive event occurs when the output terminal connection opens.

If [Normally Close] is set, an active event occurs when the output terminal connection opens, and an inactive event occurs when the output terminal connection closes.

Normally Open



Normally Close

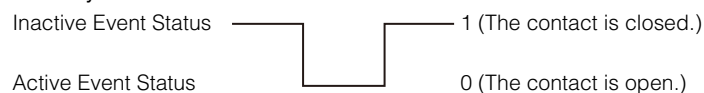

[Active Output Format]

Select the output format when the external device output is active.

[Pulse Output Time (sec)]

Enter the output duration time (sec.) when [Active Output Format] is set to [Pulse].

Important

- When [Active Output Format] is set to [Pulse] and a timer is used (P. 124), contact output is controlled only once when the timer starts.

External Device Input

[External Device Input Event]

Select whether to use the input from an external device, such as a connected sensor, as an event.

External Device Input 1, 2 (Title Is Displayed for HM4x Only)

Able to set the operation to be performed when an event is triggered by input from an external device.

The camera has two external device inputs. It is possible to set the input for each of them. HM4x

Able to set these if [Enable] is selected in [External Device Input Event].

Note

- An icon in the [Event and Input/Output Menu] of the Camera Viewer will indicate when there is an external device input event (P. 50).

[Operation Mode]

Select the circuit condition to suit the input signal from the connected external device.

When [Normally Open] is set, an active event occurs when the terminals of the external device close, and an inactive event occurs when the terminals open.

When [Normally Close] is set, an active event occurs when the terminals of the external device open, and an inactive event occurs when the terminals close.

[Active Event Operation]

Select the operation to be performed when an active event is triggered.

If [Enable] is set, [Preset] (HM4x S32VE S32D), [Video Record] and [E-mail Notification] will be executed according to their settings when an active event is triggered.

[Inactive Event Operation]

Select the operation to be performed when an inactive event is triggered.

If [Enable] is set, [Preset] (HM4x S32VE S32D), [Video Record] and [E-mail Notification] will be executed according to their settings when an inactive event is completed.

[Ongoing Active Event Operation]

Select the operation to be performed during an active event. This can only be set when [Active Event Operation] is set to [Enable].

If [Enable] is set, [Video Record] and [E-mail Notification] will be executed according to their settings during the active event.

[Preset] HM4x S32VE S32D

If a preset is specified, the camera angle will automatically move to the preset location when an external device input event is triggered.

It is necessary to set presets beforehand with [Video] > [Preset] (P. 61).

Important

- When the camera is moved to a preset position specified in the [Preset] settings, camera control privileges are released, even if the user has obtained those camera control privileges using the Camera Viewer or other camera control applications.

[Video Record]

Select whether to record video depending on the event.

If [Enable] is selected, when an external device input event is triggered, video will be transmitted to the recording destination specified in [Video Record] > [Upload] > [Video Record Settings] > [Video Record Action] (P. 95).

[E-mail Notification]

Select whether to send an e-mail notification depending on the event.

If [Enable] is selected, e-mail notification will be performed when an external device input event is triggered.

To use e-mail notification, it is necessary to set [Video Record] > [E-mail Notification] (P. 102) beforehand.

[External Device Output for Active Event]

Select the actions of the external device to output when an active event is triggered.

[External Device Output for Inactive Event]

Select the actions of the external device to output when an inactive event is triggered.

[Audio Playback at Active Event] HM4x S32VE

If [Enable] is selected, the sound clip specified in [Sound Clip] will playback at active events for the external device input.

[Audio Playback at Inactive Event] HM4x S32VE

If [Enable] is selected, the sound clip specified in [Sound Clip] will playback at inactive events for the external device input.

[Sound Clip]

Select the sound clip when [Audio Playback at Active Event] or [Audio Playback at Inactive Event] has been set to [Enable].

Sound clip must be registered as Sound Clip Upload 1 to 3 (P. 94) in [Audio] > [Audio] in advance.

[Volume]

Enter the volume for the sound clip.

[Day/Night Mode Switching]

Select the Day/Night Mode switching behavior when an external device input event is triggered.

When [Switch to Day Mode] is set, switches to Day Mode when an active event is triggered, and switches to Night Mode when an inactive event is triggered.

When [Switch to Night Mode] is set, switches to Night Mode when an active event is triggered, and switches to Day Mode when an inactive event is triggered.



Important

- When [Video] > [Preset] > [Exposure/Compensation] > [Day/Night] is set to [Auto] (P. 65), [Day/Night Mode Switching] will not run when an external device input event is triggered.
- When the [Day/Night Mode Switching] settings switch Day/Night Mode, camera control privileges are released, even if the user has obtained those camera control privileges using the Camera Viewer or other camera control applications.

[Event] > [Timer]

The timer function can generate events that can trigger operations, such as video recording and e-mail notifications, at regular intervals.

Able to set the following two types of timers.

- 24 hours continuous from specified time
- Within specified time only

Either type can be set to trigger timer events at regular intervals.

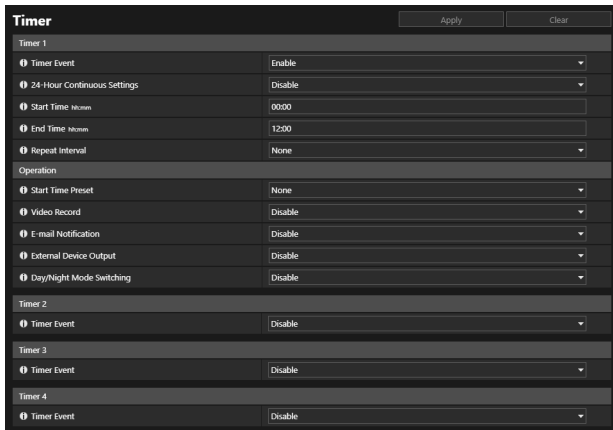

Timer 1 to 4

Able to register up to four timer events.

[Timer Event]

Select whether to use a timer event.

[24-Hour Continuous Settings]

If [Enable] is set and in the [Repeat Interval] is set to anything other than [None], the timer event repeats at every [Repeat Interval] regardless of [Start Time]. If [Repeat Interval] is set to [None], the timer event occurs only for [Start Time].

Note that only [Video Record] can be performed when [Enable] is set.

[Start Time]

Enter the start time of the timer event in 24-hour format. The timer event will be triggered at the start time.

[End Time]

When [24-Hour Continuous Settings] is set to [Disable], enter the end time of the timer event in the 24-hour format.

[Repeat Interval]

Select a repeat interval for timer events. The timer event will be triggered at the selected intervals.

■ Operation

Set the operations to be performed when timer events are triggered.

[Start Time Preset] **HM4x S32VE S32D**

When [24-Hour Continuous Settings] is set to [Disable] and a preset is specified, the camera angle will automatically move to the preset location at the time set in [Start Time].

It is necessary to set presets beforehand with [Video] > [Preset] (P. 61).

Important

- When the camera is moved to a preset position specified in the [Start Time Preset] settings, camera control privileges are released, even if the user has obtained those camera control privileges using the Camera Viewer or other camera control applications.

[Video Record]

Select whether to record video using the timer event.

If [Enable] is selected and a timer event is triggered, video will be transmitted to the recording destination specified in [Video Record] > [Upload] > [Video Record Settings] > [Video Record Action] (P. 95).

[E-mail Notification]

When [24-Hour Continuous Settings] is set to [Disable], select whether to send an e-mail notification using the timer event.

If [Enable] is selected, e-mail notification is performed when a timer event is triggered.

To use e-mail notification, it is necessary to set [Video Record] > [E-mail Notification] (P. 102) beforehand.

[External Device Output]

When [24-Hour Continuous Settings] is set to [Disable], select the external device output operation by [Start Time] and [End Time] of the timer.

[Repeat Interval] is not supported.

[Day/Night Mode Switching]

When [24-Hour Continuous Settings] is set to [Disable], select the Day/Night Mode switching operation when a timer event is triggered. This can only be set with [Timer 1].

Select [Switch to Day Mode] to switch to Day Mode at [Start Time], and Night Mode at [End Time].

Select [Switch to Night Mode] to switch to Night Mode at [Start Time], and Day Mode at [End Time].

[Repeat Interval] is not supported.



Important

- If [Start Time] and [End Time] are set and a preset with [Start Time Preset] is selected, the settings in [Day/Night] (P. 65) in [Video] > [Preset] > [Exposure/Compensation] is given priority. Therefore, even if [Day/Night Mode Switching] is set to [Switch to Day Mode] or [Switch to Night Mode], the [Day/Night Mode Switching] setting will be disabled if the opposite setting has been configured in [Day/Night]. **HM4x S32VE S32D**
- When [Video] > [Preset] > [Exposure/Compensation] > [Day/Night] is set to [Auto] (P. 65), [Day/Night Mode Switching] will not run when a timer event is triggered.
- When the [Day/Night Mode Switching] settings switch Day/Night Mode, camera control privileges are released, even if the user has obtained those camera control privileges using the Camera Viewer or other camera control applications.

[Event] > [Switch Day/Night]

When events trigger the switching of Day/Night Mode, presets registered in advance can be executed to change the camera angle or video quality settings.



Switch Day/Night

[Preset when Switching to Day Mode]

Executes the specified preset when switched to Day Mode.

[Preset when Switching to Night Mode]

Executes the specified preset when switched to Night Mode.



Important

- When the user has camera control privileges obtained using the Camera Viewer, the presets for [Preset when Switching to Day mode] and [Preset when Switching to Night Mode] will not run.



Note

- It is necessary to set presets beforehand with [Video] > [Preset] > [Register Preset] (P. 69).
- Able to set the timing for event-triggered Day/Night Mode switching in [Day/Night Mode Switching] in [External Device Input] (P. 122) or [Timer] (P. 124).

[Event] > [Linked Event]

By linking two types of events, a single event is triggered. Select AND/OR for the event linking method. Able to set the operations to perform, such as recording video or sending e-mail notifications, when a linked event is triggered.

Linked Event		Apply	Clear
Linked Event 1			
Linked Event	Enable		
Event Linking Method	AND		
Event Order	None		
Event Gap (seconds) 0 - 60	2		
Event 1			
Event Type	External Device Input		
External Device Input Status	Active		
Event 2			
Event Type	Intelligent Function		
Intelligent Function	Setting 1		
Intelligent Function Status	ON		
Operation			
ON Event Operation	Enable		
Ongoing ON Event Operation	Disable		
OFF Event Operation	Disable		
Video Record	Disable		
E-mail Notification	Disable		
External Device Output for ON Event	Disable		
External Device Output for OFF Event	Disable		

Linked Event 2	Disable
Linked Event 3	
Linked Event 4	Disable
Linked Event	Disable

Note

- Able to check the linked event status on the [Event and Input/Output Menu] of the Camera Viewer (P. 51).

Linked Event 1 to 4

Able to register up to four linked events.

It is possible to link the following events: [Volume Detection], [External Device Input], [Timer] and [Intelligent Function].

[Linked Event]

Select whether to use a linked event.

[Event Linking Method]

Select the event linking conditions.

When [AND] is set, a new linked event is triggered if both event types selected with [Event 1] and [Event 2] are triggered. In this case, set [Event Order] and [Event Gap].

When [OR] is set, a new linked event is triggered if either event type selected with [Event 1] or [Event 2] is triggered.

[Event Order]

Able to select the trigger order of two events when [Event Linking Method] is set to [AND].

If set to [None], the order will not be considered.

[Event Gap (seconds)]

Enter the trigger interval between two events when [Event Linking Method] is set to [AND].

A new linked event is triggered if the second event triggers within the specified interval after the first event was triggered.

Event 1, 2

Specify the two events to be linked. The settings are the same for both.

[Event Type]

Select the event type for linking.

[Volume Detection]

Select an ON event or an OFF event in [Volume Detection Status] to trigger a linked event .

[External Device Input]

For [External Device Input], select the external device input to use. **HM4x**

Select an active event or inactive event to trigger a linked event in [External Device Input Status].

[Timer]

Select the timer event number to use in [Timer].

[Intelligent Function]

Select the Intelligent Function detection setting number (P. 110) to use in [Intelligent Function], then select an ON event or OFF event to trigger a linked event in [Intelligent Function Status].

Note

- Unable to set the same event type for [Event 1] and [Event 2]. However, a combination of [Timer 1] to [Timer 4] can be specified for [Timer].
Also, a combination of [Input 1] and [Input 2] can be specified for [External Device Input]. **HM4x**

Operation

Set the operations to be performed when linked events are triggered.

[ON Event Operation]

If [Enable] is set, [Preset] (**HM4x S32VE S32D**), [Video Record] and [E-mail Notification] will be executed according to their settings when a linked event is triggered (ON event).

[OFF Event Operation]

If [Enable] is set, [Preset] (**HM4x S32VE S32D**), [Video Record] and [E-mail Notification] will be executed according to their settings when a linked event is completed (OFF event).

[Ongoing ON Event Operation]

Select the operation to be performed during an ON event.

If [Enable] is selected, [Video Record] and [E-mail Notification] will be executed according to their settings during the linked event.

[Preset] **HM4x S32VE S32D**

If a preset is specified, the camera angle will automatically move to the preset location when a linked event is triggered.

It is necessary to set presets beforehand with [Video] > [Preset] (P. 61).

Note

- [Preset] cannot be configured when [Intelligent Function] is included in [Event Type].

[Video Record]

Select whether to record video depending on the linked event.

If [Enable] is selected and a linked event is triggered, video will be transmitted to the recording destination specified in [Video Record] > [Upload] > [Video Record Settings] > [Video Record Action] (P. 95).

[E-mail Notification]

Select whether to send an e-mail notification by the linked event.

If [Enable] is selected and a linked event is triggered, an e-mail notification will be sent.

To use e-mail notification, it is necessary to set [Video Record] > [E-mail Notification] (P. 102) beforehand.

[External Device Output for ON Event]

Select the state of external device output when an ON event is triggered.

[External Device Output for OFF Event]

Select the state of external device output when an OFF event is triggered.

[Audio Playback at ON Event] **HM4x S32VE**

If [Enable] is selected, the sound clip specified in [Sound Clip] will playback when a linked event is triggered.

[Audio Playback at OFF Event] **HM4x S32VE**

If [Enable] is selected, the sound clip specified in [Sound Clip] will playback when a linked event completes.

Note

- [Audio Playback at ON Event] and [Audio Playback at OFF Event] can only be set when [External Device Input] and [Intelligent Function] is selected as [Event Type] in [Event 1] and [Event 2].

[Sound Clip] **HM4x S32VE**

Select the sound clip when [Audio Playback at ON Event] or [Audio Playback at OFF Event] has been set to [Enable]. Sound clip must be registered as Sound Clip Upload 1 to 3 (P. 94) in [Audio] > [Audio] in advance.

Enter the volume for the sound clip.

Linked Event Operation Examples

This shows linked event status examples according to the ON/OFF combinations for Event 1 and Event 2. In the examples below, [Event Gap] is four seconds and each cell in the figures below represents one second.

■ [Event Linking Method] Set to [OR]

Only One Event ON

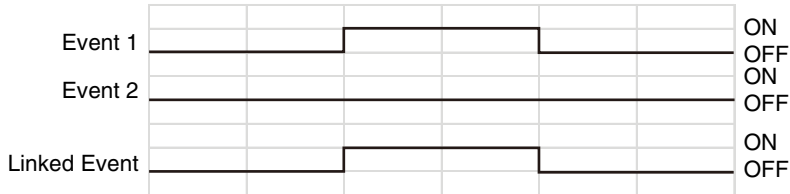

Both Events ON

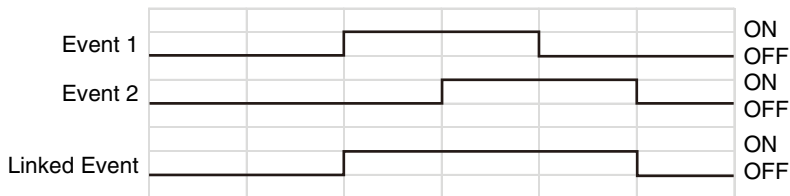

■ [Event Linking Method] is Set to [AND], [Event Order] is Specified

This shows examples when [Event Order] is set to [Event 1 -> 2].

When [Event Order] is set to [None] and [Event Linking Method] is set to [AND], linked events will be as in the examples, even if Event 1 and Event 2 are switched.

When Events Occur in Order 1 -> 2

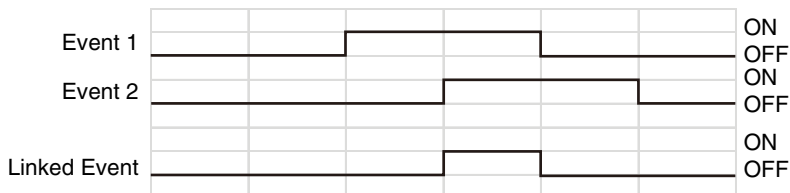

When Events Occur in Order 2 -> 1 -> 2

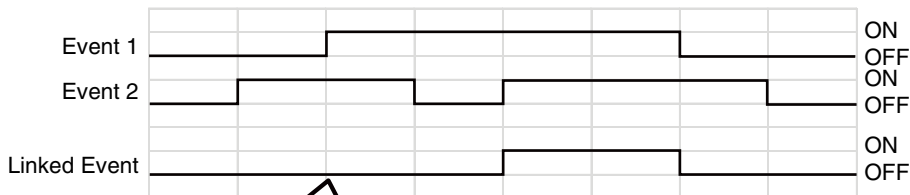

Both events are ON, but not in the right order. Therefore, a linked event does not occur here.

Event 2 Triggered but Event Gap Setting ([4] sec.) Exceeded

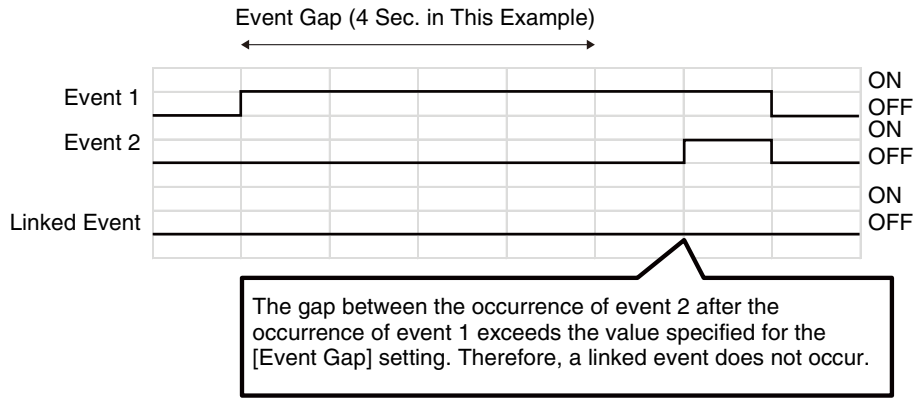

When the various status of Event 1 are set to [OFF] and Event 2 turns ON

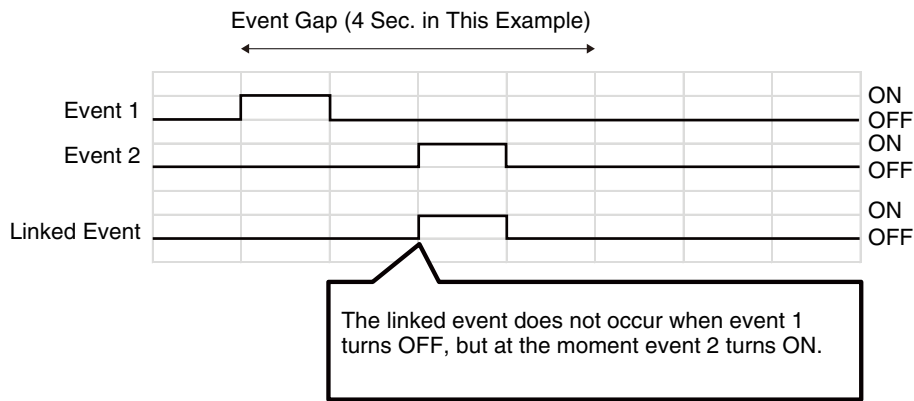

One Event Switches Between ON/OFF

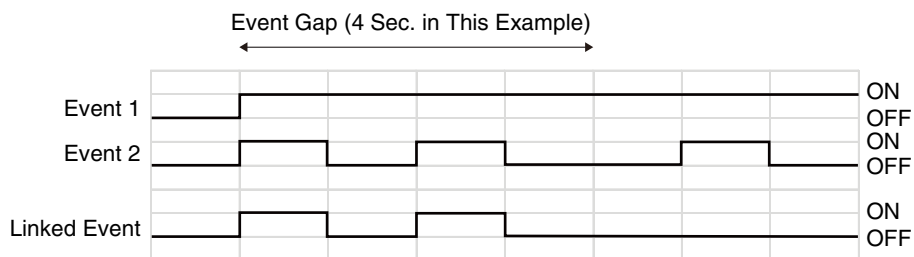

[Server] > [Server]

Set the use of HTTP and SNMP servers.

The screenshot shows a configuration window titled "Server" with three tabs: "Reboot", "Apply", and "Clear". The "Apply" tab is active. The configuration is organized into several sections:

- HTTP Server:**
 - Authentication Method: Digest Authentication
 - HTTP Port 80, 1024 - 65535: 80
 - HTTPS Port 441, 1024 - 65535: 443
- SNMP Server:**
 - Use SNMP v1 and v2c: Enable
 - Use SNMP v3: Enable
 - Administrator Contact Information: (empty field)
 - Administration Function Name: (empty field)
 - Installation Location: (empty field)
- SNMP v1 and v2c Server:**
 - Community Name: (masked with asterisks)
 - View: (checkbox)
- SNMP v3 Server:**
 - User Name: (empty field)
 - Security Level: Authentication and encryption
 - Authentication Algorithm: SHA1
 - Authentication Password: (masked with asterisks)
 - Encryption Algorithm: AES
 - Encryption Password: (masked with asterisks)

HTTP Server

Set the authentication method and HTTP port number.

Important

- If the setting of [HTTP Port] or [HTTPS Port] is changed and the camera may become inaccessible from the active web browser, a confirmation dialog box will be displayed. Click [OK] to apply the new setting.
If the camera is rebooted and cannot connect to the camera from the web browser, any available URI for connecting to the camera will be displayed in a message.
If unable to connect to the camera through the displayed URI, contact the system administrator.

[Authentication Method]

Select an authentication method for use by the HTTP server.

[HTTP Port]

Enter an HTTP port number.

[HTTPS Port]

Enter an HTTPS port number.

SNMP Server

Configure the necessary settings to use SNMP.

Note

- The camera information referenced from the SNMP Manager is read-only.
- Use an SNMP Manager that supports SNMP MIB2 (supporting RFC1213).

[Use SNMP v1 and v2c]

If [Enable] is selected, it is possible to use SNMP v1 and v2c to browse the camera information from an SNMP manager.

[Use SNMP v3]

If [Enable] is selected, it is possible to use SNMP v3 to browse the camera information from an SNMP manager.

[Administrator Contact Information]

Enter contact information (e-mail address, etc.) for the administrator of the camera. Setting information can be referenced by the SNMP Manager.

[Administration Function Name]

Enter the camera name used for administration. Setting information can be referenced by the SNMP Manager.
If left blank, the camera model name will be used.

[Installation Location]

Enter information regarding the installation location of this camera. Setting information can be referenced by the SNMP Manager.

SNMP v1 and v2c Server

[Community Name]

If [Enable] is selected for [Use SNMP v1 and v2c], enter the community name to use for SNMPv1 and v2c. The factory default setting is blank.

SNMP v3 Server

[User Name]

If [Enable] is selected for [Use SNMP v3], set the user name to use with SNMP v3.

[Security Level]

Select the security level to use for SNMP v3.

[Authentication Algorithm]

If [Authentication but no encryption] or [Authentication and encryption] is selected for [Security Level], the authentication algorithm will be displayed.

[Authentication Password]

If [Authentication but no encryption] or [Authentication and encryption] is selected for [Security Level], set the authentication password.

[Encryption Algorithm]

If [Authentication and encryption] is selected for [Security Level], the encryption algorithm will be displayed.

[Encryption Password]

If [Authentication and encryption] is selected for [Security Level], set the encryption password.

[Server] > [Video Server]

Settings for clients that can connect to a video server.

Video Server		Apply	Clear
Maximum Number of Clients 0 - 30	30		
Camera Control Queue Length 0 - 30	30		
Maximum Connection Time (sec) 0 - 65535	0		
Camera Control Time (sec) 1 - 3600	20		

Video Server

[Maximum Number of Clients]

Enter the maximum number of clients that can be connected to the camera at the same time.

If set to [0], only administrators will be able to connect.



Important

- When there are many clients or they are connected to the camera over an SSL/TLS connection, the video frame rate may slow down and the sound may drop out if audio reception from the camera is enabled.



Note

- Even if [Maximum Number of Clients] is set to 10 or more, the number of clients that can display H.264/H.265 video is limited up to 10.

[Camera Control Queue Length]

Enter the maximum queue length for clients requesting camera control privileges from the Camera Viewer.

If set to [0], only administrators can queue for camera control.

[Maximum Connection Time (sec.)]

Enter the maximum time in seconds during which an individual client can connect to the camera.

If set to [0], the connection time is unlimited.

[Camera Control Time (sec.)]

Enter the maximum time Camera Viewer can retain camera control privileges.

[Server] > [RTP Server]

Set the video and audio transmission using RTP.

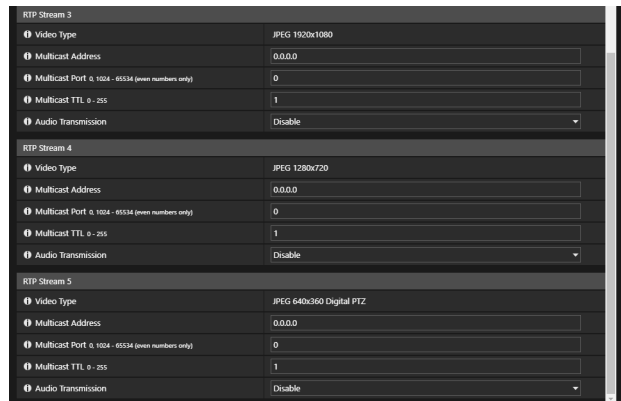

RTP Server

Enable RTP, and set the RTSP authentication method and port number.

[RTP]

Select this to enable or disable RTP.

[RTSP Authentication Method]

Select an authentication method for RTSP. Since the RTSP authentication method is configured independently of the HTTP authentication method, the user needs to configure each authentication method.

[RTSP Port]

Enter the RTSP port number.

Audio Settings 1, 2

Set multicast for audio transmission.

[Audio Compression Method]

Select the audio compression method for transmission.

[Multicast Address]

Enter the multicast address for audio transmission as follows.

IPv4: Range from 224.0.0.0 to 239.255.255.255.

IPv6: Address starting with ff00::8

Set IPv4 to [0.0.0.0] and IPv6 to [::0 (::)] to disable multicast.

[Multicast Port]

Enter the multicast port number for audio transmission.

If set to [0], multicast is disabled.

[Multicast TTL]

Enter the effective range for multicast transmission.

If set to [0], multicast is disabled.

The TTL (Time To Live), representing the effective range for multicast transmission, is decremented each time the signal passes through a router. When the value reaches 0, the signal can no longer pass through the router and be transmitted.

For example, if TTL is set to [1], multicast transmission is confined to the local segment only and cannot pass through the router to be transmitted.

RTP Stream 1 to 5

Set each stream for transmission of the RTP stream 1 to 5 (video stream 1 to 4, and digital PTZ) on a per-stream basis.

[Video Type]

[Video Compression Method] and [Video Size] are displayed as set in [Video] > [Video].

[Multicast Address]

Enter the multicast address for RTP streaming as follows.

IPv4: Range from 224.0.0.0 to 239.255.255.255.

IPv6: Address starting with ff00::/8

Enter [0.0.0.0] for IPv4 and [::0(::)] for IPv6 to disable multicast.

[Multicast Port]

Enter the multicast port number for RTP streaming.

If set to [0], multicast is disabled.

[Multicast TTL]

Enter the effective range for multicast transmission of RTP streaming.

If set to [0], multicast is disabled.

The TTL (Time To Live), representing the effective range for multicast transmission, is decremented each time the signal passes through a router. When the value reaches 0, the signal can no longer pass through the router and be transmitted. For example, if TTL is set to [1], multicast transmission is confined to the local segment only and cannot pass through the router to be transmitted.

[Audio Transmission]

Select whether to use audio transmission for RTP streaming.

[Enable] cannot be selected if [Audio] > [Audio] > [General Audio] > [Audio Input] is set to [Disable].

Note

- RTP Streaming URL
rtsp://IP Address:Port Number/rtpstream/config1(to 5)=m
[=m] is the multicast request and can be omitted.
Note that since the actual operation is dependent on the RTP client application, the specified method is not necessarily used for transmission.
- When H.264/H.265 video is selected, for bit rate control and video quality, settings respectively set in [Video] > [Video] > [Stream 1] or [Stream 2] (P. 58) are used.
- The [Video Distribution] and [Audio Distribution] settings in [Security] > [User Management] > [User Authority] are not used for RTP.
- RTP streaming video may not be displayed in an environment using a proxy server or firewall. If this occurs, contact the system administrator.
- If Host Access Restrictions are applied to a client while it is streaming using RTP over UDP, it may take from a few to tens of seconds until streaming ceases.
- Regardless of the [Audio] > [Audio] > [Audio Server] > [Audio Transmission from the Camera] setting, audio RTP streaming will be performed.

[ONVIF] > [ONVIF]

Set when using the camera with the ONVIF protocol.

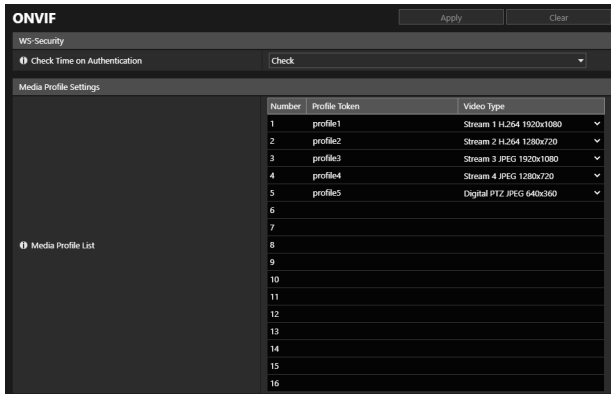

WS-Security

[Check Time on Authentication]

Select whether to check the time information of data transmitted by the client.

Media Profile Settings

[Media Profile List]

Select the video type for each Media Profile from the video streams set in [Video] > [Video].

[Security] > [Certificate Management]

Information about creating and managing certificates.

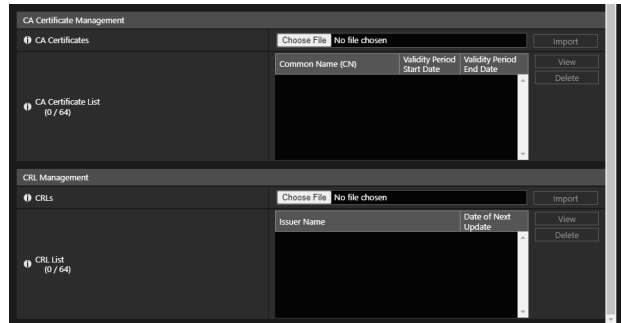
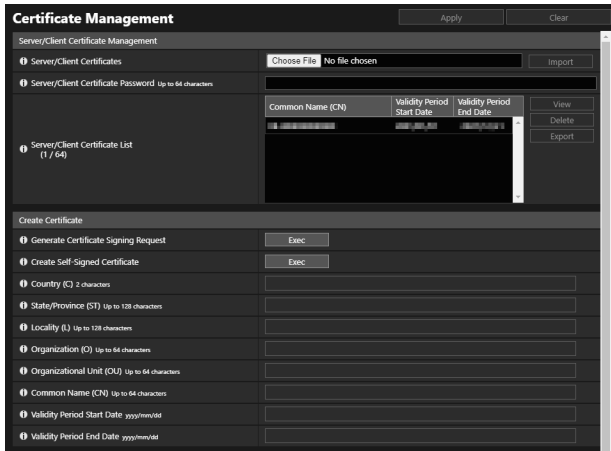

Server/Client Certificate Management

Manages the server/client certificates.

[Server/Client Certificates]

Imports the certificates.

Click [Choose File] and specify the certificate file to be imported, and then click [Import].

[Server/Client Certificate Password]

Set the password to use when importing and exporting the certificate.

[Server/Client Certificate List]

Here is the server/client certificate list for the installed cameras. Certificate's validity is displayed in GMT (Greenwich Mean Time).

After selecting a certificate, click either [View], [Delete], or [Export] to perform the following operation.

- [View]: View certificate information
- [Delete]: Delete certificate from the list
- [Export]: Export certificate information

Create Certificate

Create server certificates.

Important

- It is advised to use self-signed certificate for such as operation tests that do not require full security. It is recommended to acquire and install a server certificate issued from CA for a full-scale system operation.

[Generate Certificate Signing Request]

Click [Exec] to create a server private key and generate a certificate signing request.

Once processed, the certificate signing request will be displayed in a separate window.

[Create Self-Signed Certificate]

Enter the following items, click [Apply], and click [Exec] to create a self-signed certificate.

The certificate created will take effect after rebooting.

Note

- Since it takes time to generate certificate signing requests or certificates, it is recommended to stop the video distribution processes, or uploading etc.

[Country (C)]

Enter the ISO3166-1 alpha-2 country code.

[State/Province (ST)], [Locality (L)], [Organization (O)], [Organizational Unit (OU)], [Common Name (CN)]

Enter state/province name, locality, organization name, organizational unit and common name in alphanumeric characters (spaces or printable characters).

Enter an FQDN format host name, etc. to set the common name (required).

[Validity Period Start Date], [Validity Period End Date]

Set the validity period of the certificate to be created (required when creating a self-signed certificate).

CA Certificate Management

Manages the CA certificate.

[CA Certificates]

Imports CA certificates.

Click [Choose File] and specify the certificate file to be imported, and then click [Import].

[CA Certificate List]

List of the CA certificates. Certificate's validity is displayed in GMT (Greenwich Mean Time).

Select a certificate and then click [View] to view the certificate information. Click [Delete] to delete it from the list.

CRL Management

Manages the CRL (Certificate Revocation List).

[CRLs]

Imports CRL.

Click [Choose File] and specify the CRL file to be imported, and then click [Import].

[CRL List]

CRL list. The validity period in [Date of Next Update] is displayed in GMT (Greenwich Mean Time).

Select a CRL and then click [View] to display information about the CRL. Click [Delete] to delete it from the list.

Note

- CRL is applied to only [Verify Server Certificate] (P. 96, P. 97) for FTP or HTTP uploads.

[Security] > [SSL/TLS]

Settings for encrypted communications and server certificates is explained.

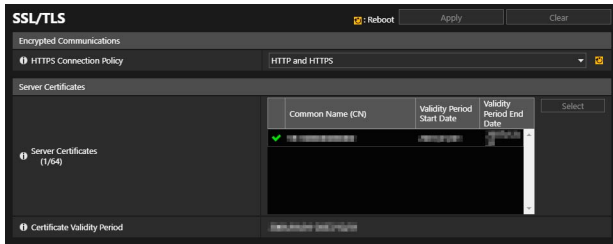

Encrypted Communications

Set encrypted communications.

[HTTPS Connection Policy]

Set SSL/TLS communication with HTTPS connections.

If not performing SSL/TLS communication, select [HTTP].

If not performing SSL/TLS communication, select [HTTPS] or [HTTP and HTTPS]. Connections using SSL/TLS are enabled after rebooting.

If [HTTPS] is selected, HTTP access is also redirected to HTTPS to perform SSL/TLS communication.

Important

- Video distribution performance decreases when performing SSL/TLS communication.

Server Certificates

Set the server certificate for use.

[Server Certificates]

Select a certificate to use from the certificates registered in [Security] > [Certificate Management] > [Server/Client Certificate Management], and click [Select].

[Certificate Validity Period]

Displays the validity period of the selected certificate.

Note

- Depending on the server certificate used by the camera and the computer connected to the camera, it may be necessary to install the root certificate, the intermediate CA certificate, or the certificate selected and exported in [Server/Client Certificate List].

[Security] > [802.1X]

Settings for 802.1X authentication and authentication status display, and for certificate management.

Common Name (CN)	Validity Period Start Date	Validity Period End Date	Select	Clear

802.1X Authentication

Display the 802.1X authentication enable/disable control and status.

[802.1X Authentication]

Select this to enable or disable 802.1X authentication.

[Authentication Status]

Display the status of 802.1X authentication. There are three types of status: [Authenticated], [Unauthenticated], and [Stop].

Authentication Method

Set the authentication method used for 802.1X authentication.

[Authentication Method]

Select [EAP-TLS], [EAP-TTLS], or [EAP-PEAP] as the authentication method to use for 802.1X authentication.

[User Name]

Enter the user name used for authentication.

[Password]

Enter the required password for authentication.

This is displayed only when [Authentication Method] is set to [EAP-TTLS], or [EAP-PEAP].

Client Certificates

This is displayed only when [Authentication Method] is set to [EAP-TLS].

[Client Certificates]

Settings for client certificate for use.

Select a client certificate to use from the certificates registered in [Security] > [Certificate Management] > [Server/Client Certificate Management], and click [Select]. The selected certificate takes effect after a reboot.

Select the client certificate in use and click [Clear] to uncheck it.

[Certificate Validity Period]

Displays the validity period of the client certificate selected in [Client Certificates].

[Security] > [User Management]

Able to change the administrator account, add new authorized users, and set the privileges for authorized users and guest users.

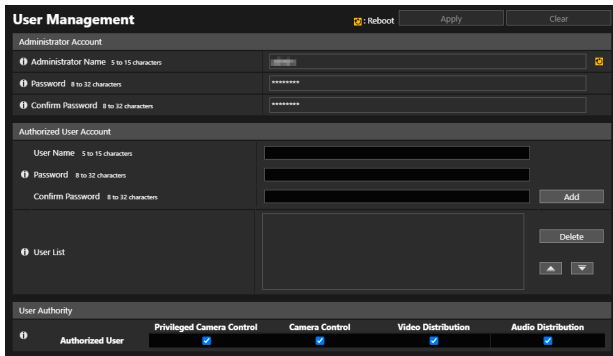

Administrator Account

Set this when changing the account information for the administrator.

Important

- To ensure system security, set the administrator password that should not be easily guessed by third parties. Do not forget the new password after setting.
- If the administrator or the administrator password is forgotten, restore the factory default settings (P. 181). Note, however, that this will reset all camera settings to factory default settings including the administrator account, the network information, date and time.

[Administrator Name]

Enter the administrator name using only alphanumeric characters, hyphens (-), and underscores (_). However, hyphens (-), and underscores (_) cannot be used at the beginning.

[Password]

Enter the administrator password.

If the Camera Viewer, etc., are connected, terminate the connection before changing the password.

[Confirm Password]

Enter the same password as above for confirmation.

Authorized User Account

Add authorized users.

[User Name], [Password], [Confirm Password]

To add the authorized user, enter the user name and password, then click [Add].

Enter the user name using only alphanumeric characters, hyphens (-), and underscores (_).

Up to 50 authorized users can be added.

[User List]

Displays a list of added authorized users.

The order of the list can be changed with the ▲▼ buttons on the right.

To delete an authorized user from the list, select the user and click [Delete].

User Authority

There are three types of users that can access the camera viewer.

Administrator:

The user assigned with all privileges.

Access the Viewer using the administrator name and password registered for the administrator account.

The administrator can disable all the privileges of an authorized user or a guest user, and completely prohibit authorized users and guest users from accessing the camera.

Authorized user:

An authorized user with higher privileges than a guest user.

It is necessary to register the user name and password (P. 141).

Guest user:

The user with a limited set of functions.

Can access the Viewer without performing user authentication.

To grant privileges to a guest user, [System] > [Viewer] > [Viewer Settings] > [User Authentication] must be set to [Do not authenticate].

Set the privileges for authorized users and guest users in [User Authority].

The four types of privileges for using the Viewers are privileged camera control, camera control, video distribution and audio distribution.

The scope of each privilege and whether it can be granted to a user is shown below.

Privilege	Privileged Camera Control	Camera Control	Video Distribution	Audio Distribution
Scope of Privilege	Perform the most operations after the administrator.	Perform some Viewer operations.	Display video with the Viewer	Receive audio with the Viewer
Authorized Users	Yes	Yes	Yes	Yes
Guest Users	No	Yes	Yes	Yes

If an item in [Privileged Camera Control], [Camera Control], or [Video Distribution] is set to [Enable] in the above table, all the items above and to the right of that item are also set to [Enable]. If an item is set to [Disable], all the items below and to the left of that item are also set to [Disable].

In the rows, more powerful privileges on the left are accompanied by less powerful privileges on the right. However, audio distribution can be set separately.

In the columns, authorized users have higher privileges than guest users.

Note

- With the factory default settings, authorized users are assigned with all the privileges.

[Security] > [Host Access Restrictions]

Separate access control from IPv4 and IPv6 addresses can be set.

The screenshot shows the 'Host Access Restrictions' window for IPv4. It has a title bar 'Host Access Restrictions' with 'Apply' and 'Clear' buttons. The main area is titled 'IPv4 Host Access Restrictions' and contains three sections: 'Apply Host Access Restrictions' (set to 'Enable'), 'Default Policy' (set to 'Authorize Access'), and a list of 20 rows for 'Network Address / Subnet'. Each row has input fields for the address and subnet, and a 'Yes' dropdown menu.

The screenshot shows the 'Host Access Restrictions' window for IPv6. It has a title bar 'IPv6 Host Access Restrictions' with 'Apply' and 'Clear' buttons. The main area is titled 'IPv6 Host Access Restrictions' and contains three sections: 'Apply Host Access Restrictions' (set to 'Enable'), 'Default Policy' (set to 'Authorize Access'), and a list of 20 rows for 'Prefix / Prefix Length'. Each row has input fields for the prefix and length, and a 'Yes' dropdown menu.



Important

- To prohibit access via a proxy server in HTTP connection, a proxy server address must be set.
- If host access restriction is set mistakenly, access to the Settings pages themselves may be prohibited, in which case restoring the factory default settings will become the only means of recovery.



Note

- If the same address is set, the address set higher in the list will be applied.

IPv4 Host Access Restrictions

Specify the hosts from which IPv4 access is permitted and prohibited.

[Apply Host Access Restrictions]

Select whether to apply IPv4 host access restrictions.

[Default Policy]

Select whether to allow or prohibit access from IPv4 addresses that have not been specified in [Network Address / Subnet].

[Network Address / Subnet]

Enter IPv4 network addresses into the list and select [Yes] or [No] for access for each address.

Able to specify the subnet to set access restrictions by network or host.

If set to [No], access to all ports is prohibited.

IPv6 Host Access Restrictions

Specify the hosts from which IPv6 access is permitted and prohibited.

[Apply Host Access Restrictions]

Select whether to apply IPv6 host access restrictions.

[Default Policy]

Select whether to allow or prohibit access from IPv6 addresses that have not been specified in [Prefix/Prefix Length].

[Prefix / Prefix Length]

Enter IPv6 addresses (prefixes) into the list and select [Yes] or [No] for access for each address.

Able to specify the prefix length to set access restriction by network or host.

If set to [No], access to all ports is prohibited.

[System] > [System]

Settings for the camera name and external input/output device name, and camera operation and installation settings.

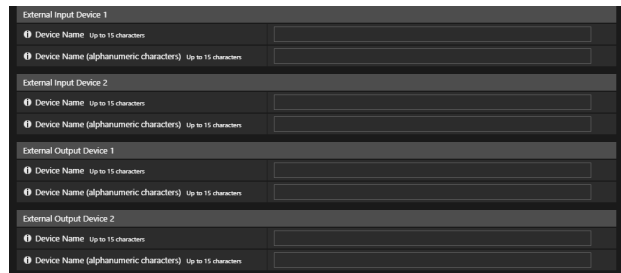
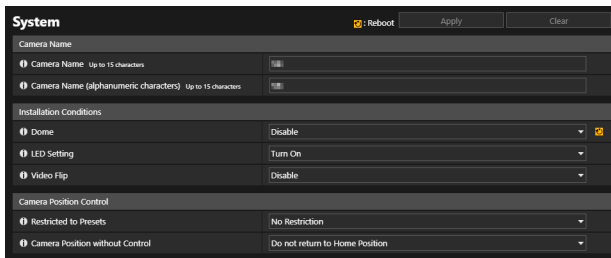

Camera Name

Set the camera name.

[Camera Name], [Camera Name (alphanumeric characters)]

Enter any camera name. Be sure to enter a name in the [Camera Name].

Installation Conditions

Configure settings for camera use suitable for the location the camera will be installed.

[Dome] **HM4x**

Select whether a dome is used. To use the camera with a dedicated indoor dome housing option for the camera, select [Enable].

[LED Setting]

Select whether to turn on the LED indicating the camera operation status.

If [Turn On] is selected, the LED will light up when turning the power on, rebooting, and during normal use.

When [Turn Off] is selected, the LED will light for several seconds during startup and then turn off.

Regardless of the setting, the LED will flash when initializing the settings.

Set to [Turn Off] if the dedicated indoor dome housing option for the camera is used, or if the reflected LED light interferes with image capture entering the capture area, etc. **HM4x**

[Video Flip]

Select whether to vertically flip the video.

Select the setting suited to the camera installation method, such as ceiling mounting or placing on a desk.

Camera Position Control

Settings for camera operation when there are no camera control restrictions for users or requests for camera control privileges.

[Restricted to Presets] **HM4x S32VE S32D**

Restricts the camera angle to the preset position including the home position, when users other than administrators control the camera with Camera Viewer, etc.

[Camera Position without Control]

Select the camera operation when there are no users with camera control privileges.

If [Return to Home Position] has been selected, the home position of the camera must be set in advance with [Video] > [Preset] > [Register Preset] (P. 61).

External Input Device

Enter each device name in order to identify the external input device which is connected.

There are two external input device terminals on the camera. **HM4x**

[Device Name], [Device Name (alphanumeric characters)]

Enter the name of the device connected to the external input device terminal.

If the [Device Name] is entered, the camera viewer's [Events and Input/Output Menu] will show the [Device Name] listed in preference.

External Output Device

Enter each device name in order to identify the corresponding external output device being connected.

There are two external output device terminals on the camera. **HM4x**

[Device Name], [Device Name (alphanumeric characters)]

Enter the name of the device connected to the external output device terminal.

If the [Device Name] is entered, the camera viewer's [Events and Input/Output Menu] will show the [Device Name] listed in preference.

[System] > [Viewer]

Configure the startup, authorization, and display of the Viewer.

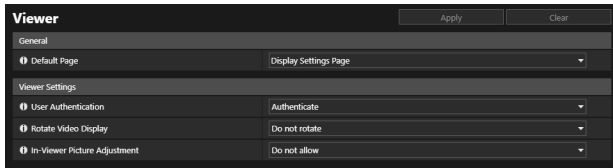

General

[Default Page]

Sets the Settings page or the Viewer as the first page to display when the camera is connected. If users other than the administrator use the Viewer, set [Default Page] to [Display Viewer].

Viewer Settings

[User Authentication]

Displays the user authentication screen when the camera is connected to the Viewer (P. 27). If [Authenticate] is selected, only the administrator or an authorized user (P. 141) can connect. When selecting [Do not authenticate], since guest users will also be able to connect, set the privileges to be granted to guest users in [Security] > [User Management] > [User Authority].

[Rotate Video Display] **S820D/S920F**

If [Rotate clockwise 90 degrees] or [Rotate counterclockwise 90 degrees] are selected, video is displayed in portrait orientation in the Camera Viewer. Use this to rotate the camera 90° to capture video in portrait orientation.



Note

- Rotation of the video display only affects the Viewer. The video in the video display area of the Settings page is not rotated. Uploads and video stored on the memory card are not rotated.
- If the video display is rotated, the on-screen display is also rotated.

[In-Viewer Picture Adjustment]

Choose whether to allow exposure, focus, and day/night adjustments from the Viewer.

[System] > [Date and Time]

Camera date and time settings.

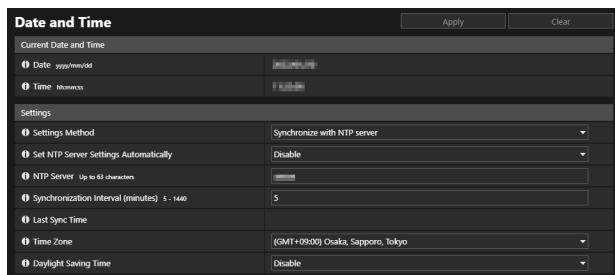

Current Date and Time

The date and time set in the camera are displayed.

Settings

Set the date and time setting method, time zone and daylight saving time for the camera.

[Settings Method]

Select the date and time setting method.

[Set manually]

Set the desired date and time in [Date] and [Time].

Set the time in 24-hour format in <hour:minute:second> order.

[Synchronize with NTP server]

Synchronize with the time of NTP server specified in the displayed [Set NTP Server Settings Automatically].

[Set NTP Server Settings Automatically]

Select one of the following setting methods.

[Disable]

Enter the IP address or host name of the NTP server in [NTP Server].

[Use DHCP]

Synchronizes with the time of the NTP server that acquired the address from the DHCP server. The acquired NTP server address is displayed in [NTP Server (DHCP)].

In order to set this, change [System] > [Network] > [IPv4] > [IPv4 Address Settings Method] to [Auto (DHCP)] (P. 150).

[Use DHCPv6]

Synchronizes with the time of the NTP server that acquired the address from the DHCPv6 server. The acquired NTP server address is displayed in [NTP Server (DHCPv6)].

In order to set this, change [System] > [Network] > [IPv6] > [IPv6] to [Enable], then set [Auto (DHCPv6)] to [Enable] (P. 151).

[Use DHCP/DHCPv6]

Synchronizes with the time of the NTP server that acquired the address from the DHCP/DHCPv6 server.

If the NTP server address can be acquired from both the DHCP server (IPv4) and DHCPv6 server, the NTP server address acquired from the DHCP server (IPv4) will be used.

[Synchronization Interval (minutes)]

Enter the synchronization interval for the specified NTP server.

[Last Sync Time]

The time last synchronized with the specified NTP server will be displayed.

[Synchronize with computer time]

The date and time will be synchronized with that of the computer currently accessing the camera. After clicking [Apply], [Settings Method] will change to [Set manually].
[Time Zone] is not automatically selected, so set it if necessary.

 **Note**

- When unable to connect to the NTP server due to incorrect NTP server IP address, etc., [Last Sync Time] will not be updated, or will be left blank.

[Time Zone]

Select the appropriate time zone.

When the time zone is changed and [Apply] is clicked, the date and time display will be automatically changed based on the selected time zone.

[Daylight Saving Time]

Select whether to automatically adjust for daylight saving time according to the time zone.

[System] > [Memory Card]

Executes memory card format set in the camera and re-creates the recorded video management file. It is also possible to see the status of the memory card.

For video recorded in the memory card setting, refer to [Video Record] > [Memory Card Recording] (P. 99).

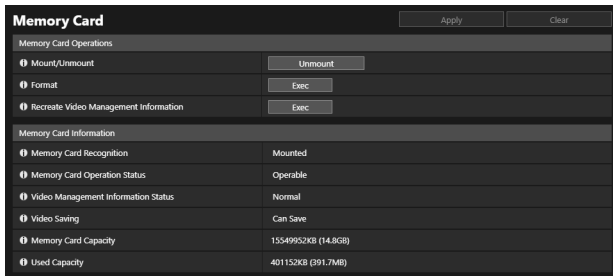

Memory Card Operations

The items will change depending on the memory card status (unmounted/mounted).

Important

- Be sure to perform the unmount process when turning off the power of the camera or removing the memory card. Failing to unmount first may result in management file problems or the memory card becoming inaccessible. Able to use the Camera Management Tool to batch mount/unmount memory cards from multiple cameras.

The memory card will be automatically mounted when inserted into the memory card slot. It will also be automatically mounted if it has been inserted in the camera when the camera starts up.

[Mount/Unmount]

Click [Unmount] to unmount the memory card.

Be sure to unmount the memory card when turning off the power of the camera or removing the memory card.

In the unmounted status, click [Mount] to mount memory card.

[Format]

Click [Exec] to format the memory card.

Formatting erases all files and directories on the memory card.

Note

- Formatting is performed using a quick format.

[Recreate Video Management Information]

If [Exec] is clicked, the management file on the memory card for recorded video will be recreated.

The memory card cannot be accessed during this process. It is also recommended that users refrain from streaming video or uploading from the camera during the recreation.

When recreating video management information files, the more files recreated, the longer the process will take; it may require several hours.

Memory Card Information

Displays the same information as [Video Record] > [Memory Card Recording] > [Memory Card Information] (P. 101).

[System] > [Network]

Network settings for connecting to the camera.

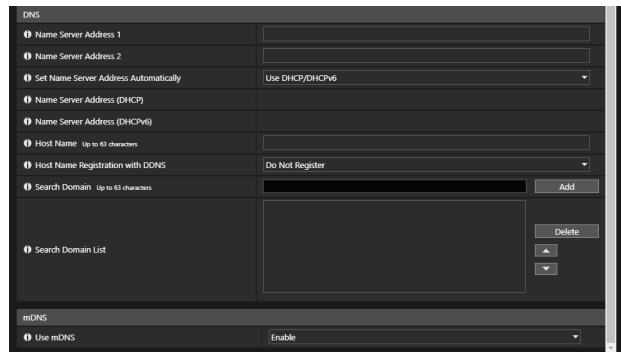
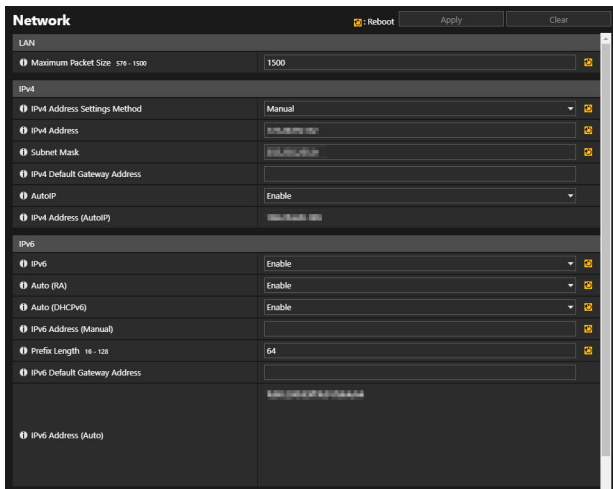

Important

- If any network settings are changed, the camera may become inaccessible from the active web browser. In this case, a confirmation dialog box will be displayed when clicking [Apply] or [Apply and reboot]. Click [OK] to apply the changed settings. If, after rebooting following the settings changes, connection cannot be established to the camera from the web browser, any candidate URI for connecting to the camera would be displayed in a message. If unable to connect to the camera through the displayed URI, contact the system administrator.

LAN

Settings for the transmission data size from the camera.

[Maximum Packet Size]

Enter the maximum packet size to be transmitted by the camera. Normally there is no need to change the default setting of 1500.

A setting of 1280 or greater is necessary when using IPv6.

When using ADSL, setting a slightly lower value may increase transmission efficiency.

IPv4

Settings for using IPv4 to connect to the camera. The IPv4 address can be acquired from the DHCP server automatically or set manually.



Important

- Contact the System Administrator for the [IPv4 Address], [Subnet Mask] and [IPv4 Default Gateway Address] if setting the IPv4 address manually.
- If any of the [IPv4 Address], [Subnet Mask] or [IPv4 Default Gateway Address] settings are wrong, the camera may become inaccessible via the network. If this occurs, use the Camera Management Tool to reset the address.

[IPv4 Address Settings Method]

Select the method for setting the IPv4 address.

For [Manual], enter a fixed IPv4 address into [IPv4 Address].

For [Auto (DHCP)], the values acquired from the DHCP server will be automatically set in [IPv4 Address], [Subnet Mask] and [IPv4 Default Gateway Address].

Important

- If [Auto (DHCP)] is selected as the IPv4 address setting method, the IPv4 address may not be assigned correctly in certain environments, such as when a router is present between the DHCP server and the camera. If this occurs, select [Manual] and set a fixed IPv4 address.

[IPv4 Address]

When [IPv4 Address Settings Method] is set to [Manual], enter a fixed IPv4 address.

[Subnet Mask]

When [IPv4 Address Settings Method] is set to [Manual], enter the designated subnet mask values for each network.

[IPv4 Default Gateway Address]

When [IPv4 Address Settings Method] is set to [Manual], enter a default gateway IP address. Be sure to set this when connecting the camera to a different subnet from that of the Viewer.

[AutoIP]

Select whether to enable or disable AutoIP.

[IPv4 Address (AutoIP)]

When [AutoIP] is set to [Enable], an automatically set IPv4 address is displayed.

IPv6

Settings for using IPv6 to connect to the camera. The IPv6 address can be assigned by the RA or DHCPv6 server automatically or set manually.

Important

- Contact the System Administrator for the [IPv6 Address (Manual)], [Prefix Length] and [IPv6 Default Gateway Address] if the IPv6 address is set manually.

[IPv6]

Select this to enable or disable IPv6.

[Auto (RA)]

Select [Enable] to set an address automatically using RA (Router Advertisement, network information automatically transmitted from a router).

[Auto (DHCPv6)]

Select [Enable] to use DHCPv6 to set an address automatically.

[IPv6 Address (Manual)]

Enter a fixed IPv6 address if setting the address manually.

[Prefix Length]

Enter a prefix length if setting the address manually.

[IPv6 Default Gateway Address]

Enter a default gateway address. Be sure to set this when connecting the camera to a different subnet from that of the Viewer.

[IPv6 Address (Auto)]

If [IPv6] is set to [Enable] and [Auto (RA)] and [Auto (DHCPv6)] to [Enable], then the automatically acquired address will be displayed.

Note

- In an environment where IPv6 cannot be used, if IPv6/Auto is set to [Enable], then only the link-local address will be displayed in the [IPv6 Address (Auto)] field.

DNS

Set the DNS server address. The DNS server address can be set manually or automatically acquired from a DHCP/DHCPv6 server.

[Name Server Address 1], [Name Server Address 2]

Enter the name server address to register. To register only one address, keep the [Name Server Address 2] field blank.

Note

- If [Name Server Address 1] is unavailable, [Name Server Address 2] will be accessed. However, [Name Server Address 2] must be set in advance.

[Set Name Server Address Automatically]

Select the server to use for automatically setting the name server address.

To set [Use DHCP], select [Auto (DHCP)] in [IPv4 Address Settings Method] (P. 150).

To set [Use DHCPv6], select [Enable] in [IPv6], then select [Enable] in [Auto (DHCPv6)] (P. 151).

[Name Server Address (DHCP)]

Select [Use DHCP] or [Use DHCP/DHCPv6] in [Set Name Server Address Automatically] to display the name server address acquired from the DHCP server.

[Name Server Address (DHCPv6)]

Select [Use DHCPv6] or [Use DHCP/DHCPv6] in [Set Name Server Address Automatically] to display the name server address acquired from the DHCPv6 server.

[Host Name]

Able to register the camera host name in the name server using alphanumeric characters.

[Host Name Registration with DDNS]

When a name is entered into [Host Name] in the FQDN format and [Register] is selected, the host name will be registered in the name server.

Registering the host name to DDNS is useful when operating with [IPv4 Address Settings Method] set to [Auto (DHCP)] (P. 150). DNS server registration settings must be set in advance. Contact the system administrator for the DNS server settings.

[Search Domain]

Enter a domain name and click [Add] to add the domain name to the Search Domain List.

When the domain names are specified in the Search Domain List, a host name, only by specifying with specified upload server without a domain name, will be handled in the form of host name + domain name.

[Search Domain List]

A list of domain names added using [Search Domain].

The function queries the DNS server for each domain name starting from the top of the list.

Use the ▲▼ buttons on the right to change the order of the domain names.

To delete a domain name, select the domain name from the list and then click [Delete].

mDNS

This will configure settings for using multicast DNS. If mDNS is used, the IP address and host name of the camera will be notified to other hosts on the network.

[Use mDNS]

Select whether to enable or disable mDNS.

[Maintenance] > [General]

Check camera information, such as the firmware version, and perform maintenance on the camera system.

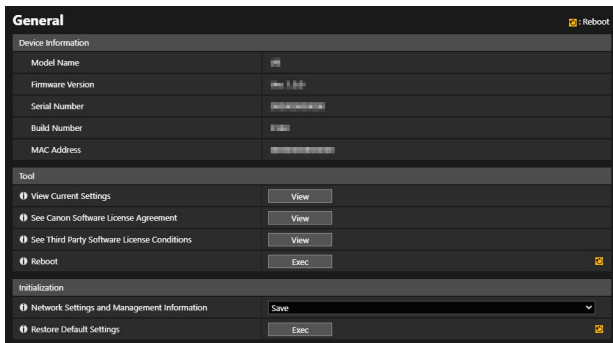

Device Information

[Model Name], [Firmware Version], [Serial Number], [Build Number] and [MAC Address]
Displays information about the camera.

Tool

Displays the camera settings and licenses and reboots the camera.

[View Current Settings]

Display list of current settings on the Settings page.

[See Canon Software License Agreement]

Display list of the license agreements for software products.

[See Third Party Software License Conditions]

Display information on the third-party software licenses.

[Reboot]

Reboot the camera.

Initialization

Initialize the camera.

Important

- Do not turn off the camera while [Restore Default Settings] is in operation. Turning off the camera at this stage may result in disabling its ability to start correctly.
- Once [OK] is clicked, it is not possible to stop the process of restoring the default settings.

[Network Settings and Management Information]

If this is set to [Save], the following settings are retained when initializing.

- HTTP Server
- Certificates
- SSL/TLS
- Administrator Name
- Administrator Password
- Host Access Restrictions
- NTP Server

- Time Zone
- Network Settings

When set to [Do not save], all the settings excluding camera's date and time will be initialized.

Since the network settings will be initialized, connection to the camera will not be enabled. Use the Camera Management Tool to configure the initial settings.

[Restore Default Settings]

After rebooting, follow the selection in [Network Settings and Management Information] to restore the default settings.



Note

- It is recommended that the user back up each of the current settings before clicking [Exec] in [Restore Default Settings].
- The camera can also be restored to factory default settings using the reset switch. Note, however, that this will reset all camera settings to factory default settings except for date and time (P. 181).

[Maintenance] > [Backup / Restore]

Able to save/restore all the camera settings.

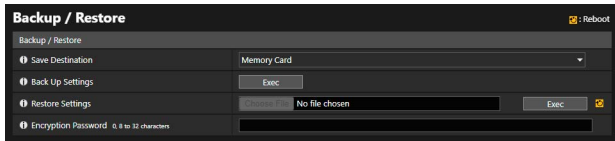

Backup / Restore

Configure the settings regarding backup and restoring.

Important

- Do not turn off the camera while [Back Up Settings] or [Restore Settings] are in operation. Turning off the camera at this stage may result in disabling its ability to boot correctly.

[Save Destination]

Select the destination for saving the camera settings when backing up.

[Back Up Settings]

All settings, except date and time, will be backed up. The administrator account, certificates used by SSL/TLS and 802.1X and private key files will also be backed up.

[Restore Settings]

Restores all settings, except date and time, from the backup file created with [Back Up Settings].

If [PC] is selected in [Save Destination], click [Browse] to specify the backup file.

The administrator account, IP address, certificates used by SSL/TLS and 802.1X and private key files will also be restored. After restore is completed, the camera will be rebooted.

Important

- Note that when restoring from the backup file of another camera, problems may occur, such as being unable to connect to the camera due to the network address conflicting or the administrator password being overwritten.
- When restoring the settings, do not use a backup file created with a firmware version later than that of the camera to restore.

[Encryption Password]

Set the password to use when backing up and restoring. This is the password for encrypting the backup data itself.

When restoring from encrypted backup data, enter the password set when backing up.

Note

- The settings are not restored if the password set when backing up and the password set when restoring do not match.

[Maintenance] > [Update Firmware]

Able to update the firmware.

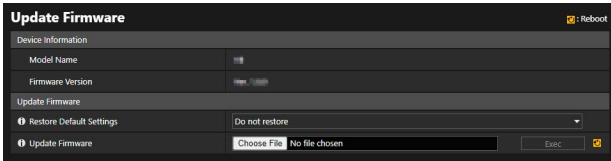

Device Information

[Model Name] and [Firmware Version]

Displays the information about the connected camera.

Update Firmware

Configure the settings related to firmware updates.

Important

- Do not turn off the camera while it is performing the [Update Firmware] operation. Turning off the camera at this stage may result in disabling its ability to boot correctly.

[Restore Default Settings]

The initial settings are restored when the firmware is updated.

If this is set to [Restore], the following settings are retained when initializing.

- HTTP Server
- Certificates
- SSL/TLS
- Administrator Name
- Administrator Password
- Host Access Restrictions
- NTP Server
- Time Zone
- Network Settings

[Update Firmware]

Click [Choose File], specify a firmware file for update, and click [Exec]. When the confirmation message is displayed, click [OK] to start the firmware update.

The camera is rebooted after the firmware is updated.

[Maintenance] > [Environment]

Set the system frequency, WDR, or intelligent function, or display the maximum value for frame rate.

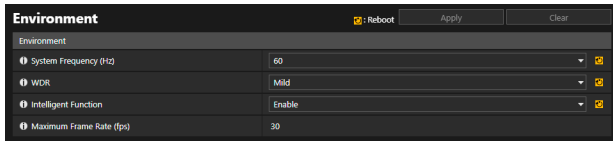

Environment

Able to change the settings of the [Environment] that is set in the initial settings.

[System Frequency (Hz)]

Able to change the system frequency.

If there is uneven brightness on the screen due to the effect of fluorescent light, etc., changing the system frequency may reduce the phenomenon. However, changing the system frequency changes frame rate's choices. Check the maximum frame rate value by [Maximum Frame Rate (fps)].

[WDR]

Able to change the strength of the effect of WDR.

With WDR, it is possible to capture videos with visibility of both bright and dark areas, even in a scene with a big contrast of brightness, by suppressing the effect of blown highlights and blocked up shadows.

If not set to [Disable], frame rate may be restricted. Check which frame rate can be set in [Maximum Frame Rate (fps)].

HM4x S820D/S920F

[Intelligent Function]

Able to select whether to use intelligent function or not. If intelligent function is used, frame rate could be limited. Check which frame rate can be set in [Maximum Frame Rate (fps)].

[Maximum Frame Rate (fps)]

Displays the maximum frame rate value, set in the [System Frequency (Hz)], [WDR], and [Intelligent Function].

Important

- If settings in [Environment] are changed, it is recommend to check each item of [Video], [Video Record], [Detection], and [Event].
- When [WDR] is set to [Disable], [Video] > [Picture (Option)] > [Image Stabilizer] is fixed to [Disable]. HM4x

Note

- Depending on the settings in [Environment], which frame rate can be set for H.264 or H.265 video stream.

[Maintenance] > [Log]

Able to check the camera operations and connection history, and set log message e-mail transmission.

View Logs

Display a history of camera operations and connections.

[System Log], [Error Log]

If [View] is clicked, the log messages saved since the camera was started are displayed.

When [Export] is clicked, the message list can be downloaded as a file.

For details on log messages, please refer to “List of Log Messages” (P. 166).

Log Notifications

Set the mail server and e-mail address to use for log notification.

[Use log notifications]

If [Enable] is selected, the following setting items for log notification are displayed.

[Notification Level]

Select the log notification level.

For details on levels of log messages, please refer to “Log Messages on the Camera” (P. 166).

[Copy E-mail Settings]

Copies the e-mail settings used in [Video Record] > [E-mail Notification] (P. 102). However, [Password] is not copied.

[Mail Server Name]

Enter the host name or IP address of the SMTP server.

[Mail Server Port]

Enter the port number for the SMTP server.

[Sender (From)]

Enter the e-mail address of the sender.

[Recipient (To)]

Enter the e-mail address of the recipient.

[Authentication]

Select an authentication method suited to the destination SMTP server.

[User Name], [Password], [POP Server]

Enter the user name and password needed for authentication, and host name or IP address of the POP server when e-mail authentication is set to [POP before SMTP].

Enter the user name and password needed for authentication when e-mail authentication is set to [SMTP-AUTH].

[Verify Server Certificate]

Select whether to verify the server certificate.

 **Note**

- To verify a server certificate, it is necessary to import the CA certificate required for verification in [Security] > [Certificate Management] > [CA Certificate Management] in advance.

[Subject]

Enter the subject of the e-mail in alphanumeric characters.

[Log Notification Test]

Clicking [Exec] initiates an log notification test based on the settings currently entered.

If [Authentication] is set to other than [None], click [Exec] before clicking [Apply] after entering the [Password].

Chapter 5

Appendix

This chapter provides supplementary information on camera functions, and explains the measures to take when trouble occurs or a message is displayed during camera use. It also explains how to reset the camera to the factory default setting state.

Modifiers

According to the setting item, it is possible to specify parameters using modifier “% characters”.

Modifier	Meaning	Description of the character string to be entered
%n	Reason for capture (number)	0 (test) HM4x 1 (External device input 1) 2 (External device input 2) S32VE S32D S820D/S920F 1 (External device input) 33 (Timer 1) 34 (Timer 2) 35 (Timer 3) 36 (Timer 4) 145 (Volume detection) 161 (Intelligent Function Detection Setting 1) 162 (Intelligent Function Detection Setting 2) 163 (Intelligent Function Detection Setting 3) 164 (Intelligent Function Detection Setting 4) 165 (Intelligent Function Detection Setting 5) 166 (Intelligent Function Detection Setting 6) 167 (Intelligent Function Detection Setting 7) 168 (Intelligent Function Detection Setting 8) 169 (Intelligent Function Detection Setting 9) 201 (Linked Event 1) 202 (Linked Event 2) 203 (Linked Event 3) 204 (Linked Event 4)
%N	Reason for capture (character string)	<External input device name (alphanumeric characters) > Intelligent Function Detection Setting name (alphanumeric characters) NULL (blank entry or interval timer test)
%O	Reason for capture (ON/OFF)	OFF ON
%X	Width of image	Number of pixels in horizontal direction
%Y	Height of image	Number of pixels in vertical direction
%C	Camera number	1
%D	Camera name	Setting for [Camera Name (alphanumeric characters)]
%P	Pan position	HM4x S32VE S32D -180.00 – 180.00 S820D/S920F 0
%T	Tilt position	HM4x S32VE S32D -90.00 – 90.00 S820D/S920F 0
%Z	Zoom position	0.01 – 300.00
%R	Rotation position	0
%V	Camera server	VB-H47/VB-M46/VB-S32VE/VB-S32D/VB-S820D/VB-S920F
%y	Year of capture time	2001 – 2031
%g	Year of the shooting time (last two digits)	01 – 31
%m	Month of capture time	01 – 12
%d	Day of capture time	01 – 31
%w	Day of week of capture time	0 – 6 (Sunday to Saturday)
%H	Hours of capture time	00 – 23
%M	Minutes of capture time	00 – 59
%S	Seconds of capture time	00 – 59
%s	Milliseconds of capture time	000 – 999
%z	Time zone of capture time	-1200 – +1300
%a	Weekday name of capture time	Sun Mon Tue Wed Thu Fri Sat
%b	Month name of capture time	Jan Feb Mar Apr May Jun Jul Aug Sep Oct Nov Dec
%h	Host Name	

Note

- If the character is not defined, “%” will be deleted.

■ Available Modifiers

The modifiers that can be used for each setting item are specified below.

[FTP Upload] (P. 96)

[Subdirectory Name to Create]

Only the modifiers %y, %m, %d, %w, %H, %h, %n can be used.

[File Name to Create]

Only the modifiers %y, %m, %d, %w, %H, %M, %S, %s, %n can be used.

[HTTP Upload] (P. 97)

[Parameter (query string)]

All modifiers can be used.

[E-mail Notification] (P. 102)

[Message Body]

All modifiers can be used.

Troubleshooting

Before contacting the dealer from whom users purchased the product or a Canon's sales representative, check the following items. If a log message is displayed, check the details of the message and the corresponding countermeasures in the log message list.

Note

- For information on troubleshooting for the Camera Management Tool, Recorded Video Utility, and Mobile Camera Viewer, refer to each individual manual.
- A security software may cause a problem. Configure to exclude the camera, or the software where the problem occurred, in the security software for use.

Problem	Countermeasures
The camera does not launch.	<ul style="list-style-type: none"> • If using a PoE hub, check if the LAN cable is connected correctly. • If using an AC adapter (sold separately), check if the AC adapter is connected correctly. HM4x • Turn the camera off and on again (refer to the "Installation Guide").
Cannot connect to the camera.	<ul style="list-style-type: none"> • Check if the LAN cable is connected correctly. • Check if the network to which the camera is connected is set up correctly. In particular, check if the settings of IP address, subnet mask and default gateway address are supported by the applicable network. • If the IP address was changed, the new address will not become effective until the camera is rebooted. • Check if the correct URI (camera IP address) is entered in the web browser. • Check whether the connection is from a computer whose access is prohibited in [Security] > [Host Access Restrictions] (P. 143) on the Settings page. • Ask the system administrator whether the authentication method set in [Security] > [802.1X] (P. 140) on the Settings page and the combination of [User Name], [Password] and certificates match the rules of the network to connect to. • Configure to exclude the camera, or the software where the problem occurred, in the security software for use.
The Camera Viewer does not launch.	<ul style="list-style-type: none"> • If the message "Your web browser is not supported." is displayed, use a version of Chrome verified for operation by Canon. • If the message "JavaScript is not available or disabled on your web browser." is displayed, click [Network and Internet] > [Internet Options] > [Security] > [Custom level] in [Control Panel], and set [Active scripting] to [Enable]. • To enable authorized users and guest users to use the Camera Viewer, configure the following settings on the Settings page. <ul style="list-style-type: none"> – Assign [Camera Control] or [Video Distribution] to authorized users/guest users in [Security] > [User Management] > [User Authority]. – Set [System] > [Viewer] > [General] > [Default Page] to [Display Viewer]. – To also enable guest users to use the Camera Viewer, set [System] > [Viewer] > [Viewer Settings] > [User Authentication] to [Do not authenticate]. • When starting the Camera Viewer in the internet connection environment and a file block security warning is displayed because of an unverified publisher, restart the Camera Viewer after executing Windows Update to the latest version.
Cannot use some functions of the Camera Viewer.	<ul style="list-style-type: none"> • Follow the procedure in "Adding the Camera IP Address as a Trusted Site" (P. 21) to add this website to the [Trusted sites] in [Security] settings, and disable the protected mode for the trusted sites (Follow the same steps even if not using Windows Server.)
Video is not displayed.	<ul style="list-style-type: none"> • There are limits on the number of clients that can access the camera simultaneously (up to 30) and the number of clients that can display H.264/H.265 video (P. 133). If this restriction is exceeded, a message is shown and video is not displayed. • Authorized users or guest users cannot display the video if they are not granted the [Video Distribution] privileges. Ask the administrator to assign [Video Distribution] privileges in [Security] > [User Management] > [User Authority]. • If "Cannot display the set video in this environment. Adjust the video settings on the settings page." is displayed, refer to "Operating Environment" (P. 17). It is also required to use HTTPS to display H.265 video. • Configure to exclude the camera, or the software where the problem occurred, in the security software for use.

Problem	Countermeasures
There is no audio.	<ul style="list-style-type: none"> • If there is no audio, check the settings in [Audio] > [Audio] on the Settings page as well as the sound and audio device settings for the computer. • Authorized users or guest users cannot use the audio if they are not granted the [Audio Distribution] privileges. Ask the administrator to assign [Audio Distribution] privileges in [Security] > [User Management] > [User Authority]. • Audio input from the microphone will not be received because there is no sound sent from the camera in the following cases. HM4x S32VE <ul style="list-style-type: none"> – While Camera's pan/tilt is being operated when [Mute During Pan/Tilt] is set to [Mute] in [Audio] > [Audio] > [General Audio] on the Settings page. S32VE – While audio is being transmitted from the Viewer to the camera or while an audio file is being played back when [Audio Communication Method] is set to [Half Duplex] in [Audio] > [Audio] > [General Audio] on the Settings page. • Configure to exclude the camera, or the software where the problem occurred, in the security software for use.
The camera cannot be controlled.	<ul style="list-style-type: none"> • If connecting to the Camera Viewer as an administrator, the user will have exclusive possession of the camera control privileges. If connecting to the Viewer as an authorized user or guest user, the user cannot control the camera unless the administrator releases camera control privileges (P. 28). Consult the administrator. • After exceeding the durability limit for pan/tilt operations, the camera may not be able to perform pan/tilt, focus, or zoom operations correctly (P. 36). S32VE S32D
The viewer gets disconnected.	<ul style="list-style-type: none"> • Check the network and computer for abnormality. • Reboot the computer and connect again. • Connections from authorized users and guest users are disconnected while creating a panorama image. HM4x S32VE S32D • Configure to exclude the camera, or the software where the problem occurred, in the security software for use.
Forgot the account information of administrator.	<ul style="list-style-type: none"> • Able to initialize all settings of the camera excluding date and time using the reset switch (P. 181). After initialization, use the Camera Management Tool to register the administrator account again. Because the network settings are also initialized, the IP address and subnet mask, etc. will also need to be set again.
Data cannot be uploaded.	<ul style="list-style-type: none"> • Check that the upload destination of [Video Record] > [Upload] and the upload operation upon an event of the [Event] menu are both set correctly. • The settings for an upload destination that has been applied can be checked by executing a server upload test in [Video Record] > [Upload] on the Settings page (P. 95). • Check logs in [System Log] in [Maintenance] > [Log] > [View Logs], [Error Log] or logs on the server to check the detailed operating environment. For details on viewing logs, please refer to "Uploader Error" (P. 169), "Uploader Warning" (P. 173), or "Uploader Notification" (P. 177) of "List of Log Messages". Also, refer to "Important" on P. 95. • For the server settings, contact your system administrator.
Video cannot be recorded on a memory card.	<ul style="list-style-type: none"> • Check [Video Record] > [Memory Card Recording] or [System] > [Memory Card] > [Memory Card Information] (P. 101, P. 149) on the Settings page. • Video cannot be recorded if the memory card has insufficient space and [Video Record] > [Memory Card Recording] > [Memory Card Operations] > [Overwrite videos] is set to [Disable] on the Settings page (P. 100). Set [Overwrite videos] to [Enable] or use the Recorded Video Utility to delete unnecessary videos. • To record video to a memory card when an event occurs, check the [Video Record Action] settings under [Video Record] > [Memory Card Recording] > [Video Record Settings] on the Settings page. When [Video Record Action] is set to [Upload], change it to [Record to Memory Card]. • When recording-mode stream video that could not be transmitted due to network errors or video for which the FTP/HTTP upload failed is not stored on the memory card, check [Operation Settings] under [Video Record] > [Memory Card Recording] > [Memory Card Operations] on the Settings page. When [Operation Settings] is set to [Save Log], change it to [Save Logs and Videos]. • To manually save recordings to a memory card, obtain camera control privileges.
Files cannot be saved.	<ul style="list-style-type: none"> • Since Windows prohibits saving to certain folders, there are cases where saving files may fail. Specify other folders such as [Documents], [Pictures], etc.
The video and audio are not in sync.	<ul style="list-style-type: none"> • This might be reduced by taking the following measures: <ul style="list-style-type: none"> – Disable settings if using intelligent function – Reduce the number of concurrent streams – Reduce the frame rate or make video size smaller • The following measures may reduce the discrepancy between the video and audio on camera Viewer. <ul style="list-style-type: none"> – Display video in H.265 or JPEG – Adjust the frame rate or video size for H.264 video stream

Problem	Countermeasures
Flickering (uneven brightness on the screen due to fluorescent light, etc.) occurs.	<ul style="list-style-type: none"> • This might be reduced by the following measures: <ul style="list-style-type: none"> – Change the exposure mode to [Auto (Flickerless)] or [Auto (Flickerless2)] S32D S820D/S920F (P. 63). – When the exposure mode is [Auto (Shutter-priority AE)] or [Manual], shutter speed is locked to power supply frequency (power supply frequency fixed at 1/120 sec for 60 Hz, 1/100 sec for 50 Hz) (P. 64). – Change the system frequency (P. 157)
Video is temporarily interrupted.	<ul style="list-style-type: none"> • When the network load is high, or depending on the stream settings, the video may be temporarily interrupted. Revise the video settings (P. 58).
There is an afterimage of the moving subject.	<ul style="list-style-type: none"> • It may be reduced by setting [Noise Reduction] to [Mild] in the Settings page under [Video] > [Preset] > [Image Adjustment].

List of Log Messages

Log Messages on the Camera

This is the list of log messages displayed in [Maintenance] > [Log] > [View Logs] on the Settings page (P. 158). Log messages are categorized as follows.

Category	Level	Code	Fault level
crit	Error	4xx	Software-level failure (Task operations will stop)
err	Error	3xx	Operational error (Operations will continue)
warning	Warning	2xx	Non-operational error
notice	Warning	1xx	Error external to the system
info	Information	0xx	Information on normal operation

Note

- If no content is recorded in the log for approximately two hours, "-- MARK --" will be recorded in the message area.

Error Log

■ System Error

S302 Error on saving settings [err]

Description	Can't update system settings (S302)
Meaning	An error generated while the system was saving a setting. Setting could not be saved.
Countermeasure	Provide enough memory space by deleting unnecessary files in the user memory area, etc.

S303 Error on saving settings [err]

Description	Can't update files of system settings (S303)
Meaning	An error generated while the system was saving a setting. Setting could not be saved.
Countermeasure	Provide enough memory space by deleting unnecessary files in the user memory area, etc.

S307 Error on saving settings [err]

Description	(vbadm.c XXX) Can't update system settings (S307)
Meaning	An error generated while the settings were being saved by the settings protocol. Setting could not be saved.
Countermeasure	Provide enough memory space by deleting unnecessary files in the user memory area, etc.

S310 Operation error in event service [err]

Description	cannot work event [%1][%2][%3] (S310)
%1	Error number
%2	Cause of error
%3	Error information
Meaning	An error occurred while the event service was running.
Countermeasure	If the problem persists after rebooting, the camera could be faulty. Contact a Canon's sales/service representative.

S311 Operation error in external input/output service [err]

Description	cannot work extio [%1][%2][%3] (S311)
%1	Error number
%2	Cause of error
%3	Error information
Meaning	An error occurred while the external input/output device service was running.
Countermeasure	If the problem persists after rebooting, the camera could be faulty. Contact a Canon's sales/service representative.

S312 Operation error in timer service [err]

Description	cannot work timer [%1][%2][%3] (S312)
%1	Error number
%2	Cause of error
%3	Error information
Meaning	An internal error occurred in the timer service.
Countermeasure	If the problem persists after rebooting, the camera could be faulty. Contact a Canon's sales/service representative.

S320 PAN/TILT operation error [err]

Description	%1 error occurred. [%2] (S320)
%1	PAN TILT
%2	Warning details
Meaning	An error occurred while PAN/TILT was running or stopped.
Countermeasure	Check that the camera is not touching the dome, etc. If the error is not caused by problems such as contact with peripheral items, the camera could be faulty. Contact a Canon's sales/service representative.

S391 Imaging system error [err]

Description	input 0: [%1] time asserted: code [%2] (S391)
%1	Number of detection
%2	Cause of error
Meaning	Image may not have been captured correctly, recovery processing was performed.
Countermeasure	If the problem persists, the camera could be faulty. Contact a Canon's sales/service representative.

S410 Event service initialization error [crit]

Description	event initialization error [%1][%2] (S410)
%1	Error number
%2	Cause of error
Meaning	An error occurred in the initialization of the event service.
Countermeasure	If the problem persists after rebooting, the camera could be faulty. Contact a Canon's sales/service representative.

S411 External input/output service initialization error [crit]

Description	extio initialization error [%1][%2] (S411)
%1	Error number
%2	Cause of error
Meaning	An error occurred in the initialization of the external input/output device service.
Countermeasure	If the problem persists after rebooting, the camera could be faulty. Contact a Canon's sales/service representative.

S412 Timer service initialization error [crit]

Description	timer initialization error [%1][%2] (S412)
%1	Error number
%2	Cause of error
Meaning	An error occurred in the initialization of the timer service.
Countermeasure	If the problem persists after rebooting, the camera could be faulty. Contact a Canon's sales/service representative.

S413 Timer service runtime error [crit]

Description	timer working error [%1] (S413)
%1	Error number
Meaning	An error occurred while the timer service was running.
Countermeasure	If the problem persists after rebooting, the camera could be faulty. Contact a Canon's sales/service representative.

S420 External I/O controller has failed [crit]

Description	external io controller is broken.(S420)
Meaning	The external I/O controller has failed.
Countermeasure	The external I/O controller firmware must be updated. If the problem persists after updating the firmware, the camera could be faulty. Contact a Canon's sales/service representative.

S490 Imaging system error [crit]

Description	input1: [%1] time asserted: code [%2] (S490)
%1	Number of detection
%2	Cause of error
Meaning	Images may not have been captured correctly.
Countermeasure	If the problem persists, the camera could be faulty. Contact a Canon's sales/service representative.

■ Audio Server Error

B301 Audio device error [err]

Description	cannot use audio device for %1[%2:%3] (B301)
%1	Send/Receive type (rx tx)
%2	Error handling (open write flush)
%3	Error number
Meaning	Detected an error in the audio device
Countermeasure	If the problem persists, contact a Canon's sales/service representative.

B402 Audio server initialization failed [crit]

Description	wvaudio initialization error [%1] (B402)
%1	Error number
Meaning	The audio server could not be initialized. The audio server stops.
Countermeasure	If the problem persists after rebooting, the camera could be faulty. Contact a Canon's sales/service representative.

B403 Settings change failed [crit]

Description	cannot set config [%1:%2] (B403)
%1	Error serial number
%2	Error number
Meaning	The settings could not be updated. The audio server stops.
Countermeasure	If the problem persists after rebooting, the camera could be faulty. Contact a Canon's sales/service representative.

■ Camera Application Error

C301 Day/Night mode switching error [err]

Description	Detect IRCF error %1 (C301)
%1	Error number
Meaning	An error occurred while switching the Day/Night mode (during the insertion or the removal of infrared cut filter).
Countermeasure	If the problem persists after rebooting, the camera could be faulty. Contact a Canon's sales/service representative.

■ Video Error

V300 Video input error [err]

Description	video %1 warning - %2 (V300)
%1	Video number
%2	Error number
Meaning	An error in the video input was detected that may adversely affect the operation of the camera.
Countermeasure	If the problem persists after rebooting, the camera could be faulty. Contact a Canon's sales/service representative.

V320 Internal error in intelligent service [err]

Description	cannot work intelligent [%1][%2][%3]. (V320)
%1	Error number
%2	Cause of error
%3	Error information
Meaning	An internal error occurred in intelligent service.
Countermeasure	If the problem persists after rebooting, the camera could be faulty. Contact a Canon's sales/service representative.

V321 Tentative setting mode error in intelligent service [err]

Description	pseudo mode setting fail. (V321)
Meaning	An error occurred in changing the tentative setting mode of intelligent service.
Countermeasure	If the problem persists after rebooting, the camera could be faulty. Contact a Canon's sales/service representative.

V400 Video input initialization error [crit]

Description	video %1 initialization failure - %2(%3) (V400)
%1	Video number
%2	Process description
%3	Error details
Meaning	The video input function was stopped because the video input system could not be initialized.
Countermeasure	If the problem persists after rebooting, the camera could be faulty. Contact a Canon's sales/service representative.

V401 Video input command error [crit]

Description	video %1 command error - %2(%3) (V401)
%1	Video number
%2	Process description
%3	Error details
Meaning	The video input function was stopped because a video input command could not be processed.
Countermeasure	If the problem persists after rebooting, the camera could be faulty. Contact a Canon's sales/service representative.

V402 Video input stopped [crit]

Description	video %1 stalled (V402)
%1	Video number
Meaning	The video input function was stopped because video generation from the video input stopped.
Countermeasure	If the problem persists after rebooting, the camera could be faulty. Contact a Canon's sales/service representative.

V403 Video input error [crit]

Description	video %1 fatal error - %2 (V403)
%1	Video number
%2	Error number
Meaning	The video input function was stopped because an error for which the video input cannot be recovered was detected.
Countermeasure	If the problem persists after rebooting, the camera could be faulty. Contact a Canon's sales/service representative.

V420 Could not start intelligent service [crit]

Description	intelligent initialization error [%1][%2]. (V420)
%1	Error number
%2	Cause of error
Meaning	Failed to initialize intelligent service.
Countermeasure	If the problem persists after rebooting, the camera could be faulty. Contact a Canon's sales/service representative.

V421 Intelligent service error [crit]

Description	intelligent working error [%1][%2]. (V421)
%1	Error number
%2	Cause of error
Meaning	An error that does not allow recovery occurred while intelligent service was running.
Countermeasure	If the problem persists after rebooting, the camera could be faulty. Contact a Canon's sales/service representative.

■ Uploader Error

A470 Uploader initialization failed [crit]

Description	uploader initialization failure - %1 (A470)
%1	Error number
Meaning	The uploader could not be initialized.
Countermeasure	If the problem persists after rebooting, the camera could be faulty. Contact a Canon's sales/service representative.

■ Memory Card Error

M301 Memory card control module error [err]

Description	%1 process failure (M301)
%1	mount or unmount
Meaning	Mount or unmount process failed.

M302 Cannot remove invalid file [err]

Description	Invalid file (%1) can not remove. (M302)
%1	Name of removed file
Meaning	The invalid file could not be removed.

M303 Cannot process directory [err]

Description	Can not open directory(%1)(M303)
%1	Directory name
Meaning	Could not open directory to be processed.

M304 Failed to recreate management information [err]

Description	Fail updating management file(%1)(M304)
%1	Management information identification number
Meaning	Process to recreate management information failed.

M305 Error when writing a video file [err]

Description	write error %1 (%2) (M305)
%1	Video file path
%2	Reason for error
Meaning	An error occurred when writing a video file.

M400 Failed to initialize a memory card [crit]

Description	Fail SD card initialization(%1).(M400)
%1	Card initialization NG (det), power supplies control NG (proc)
Meaning	Process to initialize a memory card failed.

■ ONVIF Error (RTP)

R301 Distribution communication error [err]

Description	message queue open error. %1 (R301)
%1	Modules that generate errors RTP_CTRL_QUEUE RTP_DATA_QUEUE VIDEO_CTRL_QUEUE VIDEO_DATA_QUEUE AUDIO_CTRL_QUEUE AUDIO_DATA_QUEUE EVENT_CTRL_QUEUE RECVQ_META SENDQ_MEDIA
Meaning	A communication error occurred between modules.
Countermeasure	If the problem persists after repeated attempts to output and rebooting, the camera could be faulty. Contact a Canon's sales/service representative.

R302 Parameter acquisition failure [err]

Description	cannot get parameter: %1 (R302)
%1	user_account: User account IP_address: IP address of the camera profile_media_configuration: MediaConfiguration information RTSP_port_number: RTSP port number
Meaning	Parameter acquisition has failed.

R303 Metadata distribution initialization failure [err]

Description	metadata initialization error (R303)
Meaning	Metadata distribution initialization has failed.

R304 Abnormal termination of client [err]

Description	delete session from some kind of error: client_IP=%1, session_ID=%2 (R304)
%1	Client IP address
%2	Session ID
Meaning	The client session terminated abnormally.

R304 Client disconnected [err]

Description	connection reset by peer: client_IP=%1 (R304)
%1	Client IP address
Meaning	Disconnected from client.

R304 Client disconnected [err]

Description	RTP/HTTP connection closed by client (R304)
Meaning	Disconnected from client.

R305 RTSP processing error [err]

Description	RTSP Error: error_code=500: Internal Server Error (R305)
Meaning	An RTSP processing error occurred.

Warning Log

■ System Warning

S220 PAN/TILT operation warning [warning]

Description	%1 warning detected. [%2] (S220)
%1	PAN TILT
%2	Warning details
Meaning	An error occurred during operation or stopping of PAN/TILT.
Countermeasure	Check that the camera is not touching the dome, etc.

■ HTTP Server Warning

H143 User name specification error [notice]

Description	(http_auth.c.XXX) get_password failed, IP:%1 (H143)
%1	IP address
Meaning	An unknown user was specified in user authentication. This log message may also be displayed during normal operations when using a web browser other than Microsoft Edge.

H144 Password specification error [notice]

Description	(http_auth.c.XXX) password doesn't match for %1 username%2, IP:%3 (H144)
%1	URL XSS vulnerability countermeasure implementation (process equivalent to ftpd)
%2	User Name
%3	IP address
Meaning	A wrong password was specified in user authentication.

H201 Disconnected due to timeout [warning]

Description	a request for %1 timed out after writing %d seconds (H201)
%1	Request URI
%d	360 (Timeout time)
Meaning	Disconnected due to HTTP server timeout (360 sec.).

■ wvhttp Warning

W101 Invalid user name [notice]

Description	user <User name> not found (W101)
Meaning	The camera was accessed by an unauthorized user.

W102 Invalid password [notice]

Description	user <User name> password mismatch (W102)
Meaning	The password is invalid.

W130 Buffer recovered [notice]

Description	stream buffer recovered (W130)
Meaning	Image buffer for stream recording has recovered.

W201 Invalid panorama image [warning]

Description	corrupt panorama image - ignored (W201)
Meaning	Panorama image information acquisition failed.

W230 Buffer overflow [warning]

Description	stream buffer overflowed (W230)
Meaning	The video buffer for the stream recording overflowed and videos were discarded.

■ Audio Server Warning

B101 Received unusual request [notice]

Description	%1 unusual request[%2] (B101)
%1	Client host's IP address
%2	Unusual type (400 404)
Meaning	Refused due to command error (400) and parameter error (404).

B102 Client connection denied [notice]

Description	%1 request denied[%2] (B102)
%1	Client host's IP address
%2	Denial type (41 43 ...)
Meaning	Client connection was denied due to an authentication error (41), time specification error (42), insufficient resource (43), specification of unsupported codec (45), specification of unpermitted user level (47), too many clients (49) or invalid operation mode (4a).
Countermeasure	41: Check user name, password or user list used when connecting. 42: Check playtime or maximum connection time settings used when connecting. 43: Reconnect or restart. 45: Use supported client software. 47: Check user level used when connecting. 49: Check client number settings. 4a: Check if usage of audio server is enabled.

B103 Client forcibly disconnected [notice]

Description	%1 access denied[%2] (B103)
%1	Client host's IP address
%2	Denial type (41 42 4a)
Meaning	Connection was initially permitted, but the setting has subsequently been changed to prohibit access, thereby triggering a forced disconnection (the denial type is the same with B102).

B201 Event notification failure [warning]

Description	cannot notify %1 event [%2] (B201)
%1	Event type (ald)
%2	Error number
Meaning	Failed to notify event.

B202 Event receive failure [warning]

Description	cannot recv event [%1] (B202)
%1	Error number
Meaning	Failed to receive event.

B203 Audio message send failure [warning]

Description	audio message send error %1 [%2] (B203)
%1	Message type
%2	Error number
Meaning	Failed to send audio message.

B204 Audio message receive failure [warning]

Description	audio message recv error [%1:%2] (B204)
%1	Error serial number
%2	Reason for error
Meaning	Failed to receive audio message.

■ Camera Application Warning

C201 Day/Night Mode switching warning [warning]

Description	Can't switch Day/Night mode, because current mode is Auto.(C201)
Meaning	Day/Night Mode could not be switched.
Countermeasure	Set Day/Night Mode to manual.

C211 Camera control command overflow [warning]

Description	command queue overflowed (C211)
Meaning	The camera control command queue overflowed, and some commands were discarded.
Countermeasure	Allow a longer interval (200 ms) for sending the camera control command.

■ Video Warning

V200 Video input warning [warning]

Description	video %1 warning - %2 (V200)
%1	Video number
%2	Error number
Meaning	An error for which the video input can be recovered was detected.
Countermeasure	Change video size or video quality to decrease data size for each JPEG image.

■ Uploader Warning

A120 Resolution of upload destination name failed [notice]

Description	uploader cannot resolve the server name (A120)
Meaning	The name of the upload destination could not be resolved.

A121 Connection to upload destination failed [notice]

Description	uploader cannot connect to the server (A121)
Meaning	Connection to upload destination failed.

A122 Connection to upload destination failed [notice]

Description	uploader cannot connect to the server (A122)
Meaning	Connection to the upload destination failed due to a reason other than A120 and A121.

A134 Invalid upload settings (FTP/HTTP mode) [notice]

Description	ftp/http mode invalid. uploader set <none> forcibly (A134)
Meaning	Invalid settings of upload method. The upload function was forcibly disabled.

A135 Invalid upload settings (FTP PORT/PASV mode) [notice]

Description	ftp port/pasv mode invalid. uploader set <pasv> forcibly (A135)
Meaning	Invalid PORT/PASV mode settings in connection with FTP upload. The PASV mode was forcibly set.

A136 Invalid upload settings (HTTP notification only/image mode) [notice]

Description	http notice/image mode invalid. uploader set <image> forcibly (A136)
Meaning	Invalid notification only/image mode setting in connection with HTTP upload. The image mode was forcibly set.

A137 Invalid upload settings (E-mail notification) [notice]

Description	mode invalid. uploader set <none> forcibly (A137)
Meaning	Invalid e-mail notification settings. E-mail notification was forcibly disabled.

A138 Invalid upload settings (E-mail notification authentication mode) [notice]

Description	authentication mode invalid. uploader set <smtp auth> forcibly (A138)
Meaning	Invalid settings for e-mail notification authentication mode. "SMTP_AUTH" was forcibly set.

A274 Event buffer for upload overflowed [warning]

Description	event queue is full (A274)
Meaning	Event buffer for upload overflowed.
Countermeasure	Make adjustments to reduce the number of event occurrences.

A275 Video buffer for upload overflowed [warning]

Description	buffer queue is full (A275)
Meaning	Video buffer for upload overflowed.
Countermeasure	Make adjustments to reduce the number of event occurrences. Also adjust the video quality, video size and frame rate for upload.

■ Memory Card Warning

M201 Memory card is write-protected [warning]

Description	Readonly filesystem (M201)
Meaning	A write-protected memory card is inserted.

M203 Insufficient space on memory card [warning]

Description	There is not available space (M203)
Meaning	Insufficient memory card capacity.

M204 Invalid file removed [warning]

Description	Invalid file (%1) was removed. (M204)
%1	Name of removed file
Meaning	An invalid file was removed.

M205 Checking management information file [warning]

Description	%1 checking management file (M205)
%1	Start Finish
Meaning	The memory card may have been removed without being unmounted. Start/finish checking management information file.

M206 Invalid management information removed [warning]

Description	Invalid db information(%1)(%2) was removed(M206)
%1	Name of management information file containing invalid information
%2	ID of invalid information
Meaning	Invalid management information was removed.

M207 Memory card removed without unmounting [warning]

Description	Memory card was pulled before unmount. (M207)
Meaning	Memory card was removed when mounted.

■ ONVIF Warning (RTP)

R101 RTP session timeout [notice]

Description	session timeout: session ID=%1 (R101)
%1	Session ID
Meaning	RTP session has timed out.

R102 Information acquisition failure (RTP payload size) [notice]

Description	cannot get parameter: RTP_payload_size (R102)
Meaning	Information acquisition has failed (RTP payload size).

R102 Information acquisition failure (IP address) [notice]

Description	cannot get parameter: IP_address (R102)
Meaning	Information acquisition has failed (IP address).

R103 RTSP authentication failure [notice]

Description	RTSP authorization error (R103)
Meaning	RTSP authentication has failed.

R107 RTSP connection failure [notice]

Description	RTSP Error: error_code=%d: Service Unavailable (R107)
%d	400: Invalid value for specifying RTSP option. 401: RTSP authentication failure or missing valid authentication information. 457: Invalid value for specifying playback time for RTSP. 501: Unsupported RTSP option was specified. 503: Failure to provide service, due to insufficient resources. Cases such as exceeding maximum number of RTP connection.
Meaning	RTSP connection has failed.

■ System Notification

S001 System started [info]

Description	starting paramd (S001)
Meaning	Parameter management module started.

S002 System settings changed [info]

Description	Updated system settings. (S002)
Meaning	Settings not requiring rebooting were changed.

S010 Event service started [info]

Description	starting event (S010)
Meaning	The event service was started.

S011 Event service shut down [info]

Description	shutdown event (S011)
Meaning	The event service was shut down.

S012 External device service started [info]

Description	starting extio (S012)
Meaning	The external device input/output service was started.

S013 External device service shut down [info]

Description	shutdown extio (S013)
Meaning	The external device input/output service was shut down.

S014 Timer service started [info]

Description	starting timer (S014)
Meaning	The timer service was started.

S015 Timer service shut down [info]

Description	shutdown timer (S015)
Meaning	The timer service was shut down.

S017 qtimer service started or shut down [info]

Description	%1 qtimer (S017)
%1	starting stopping
Meaning	The qtimer service was started or shut down.

S050 IPv4 address assigned to wired LAN interface [info]

Description	IPv4 Address %1 %2 was assigned to the wired I/F (S050)
%1	Set IPv4 address
%2	"from router" for DHCPv4 address
Meaning	IPv4 address is set for wired LAN.

S051 IPv6 address assigned to wired LAN interface [info]

Description	IPv6 Address %1 %2 was assigned to the wired I/F (S051)
%1	Set IPv6 address
%2	"from router" for DHCPv6/RA address
Meaning	IPv6 address is set for wired LAN.

S054 IPv4 address for wired LAN interface is released [info]

Description	IPv4 Address %1 %2 was released from the wired I/F (S054)
%1	Released IPv4 address
%2	"from router" for DHCPv4 address
Meaning	IPv4 address assigned to wired LAN is released.

S055 IPv6 address for wired LAN interface is released [info]

Description	IPv6 Address %1 %2 was released from the wired I/F (S055)
%1	Released IPv6 address
%2	"from router" for DHCPv6/RA address
Meaning	IPv6 address assigned to wired LAN is released.

S070 Changes on certificate [info]

Description	ssl: succeeded to %1 certificate (S070)
%1	generate import delete export
Meaning	A certificate was generated/imported/deleted/exported

■ wvhttp Notification

W001 Starting and stopping of system [info]

Description	%1 webview (W001)
%1	starting stopping
Meaning	wvhttp server (webview) has started or stopped.

W030 Startup and shutdown of WebView Livescope Client [info]

Description	%1%2 host=<Host>, user=<User>, prio=<Priority>(W030)
%1	W: WebView session, V: Session-less video client, N: Session-less event client
%2	+: Connect, -: Disconnect
Meaning	The camera server client was connected or disconnected.

W031 Transmitted video data size [info]

Description	%1= host=<Host>, user=<User>,video=<jpg h264>:<Number of frames> (W031)
%1	W: WebView session, V: Session-less video client
Meaning	When a client disconnected, the total data that was sent to the client is displayed in number of frames.

W040 Saving to external memory [info]

Description	%1 the image storing - %2 (W040)
%1	starting stopping
%2	Reason for starting/stopping
Meaning	Started or stopped saving the recording stream to external memory.

■ Audio Server Notification

B001 Starting and stopping of audio server [info]

Description	%1 audio. (B001)
%1	starting stopping
Meaning	The audio server was started/stopped.

B011 Audio client connected [info]

Description	[%1] %2 connected n=%3 (B011)
%1	Client type (send recv)
%2	Client host's IP address
%3	Total number of clients
Meaning	An audio client was connected.

B012 Audio client closed [info]

Description	[%1] %2 closed n=%3 (B012)
%1	Client type (send recv)
%2	Client host's IP address
%3	Total number of clients
Meaning	An audio client was disconnected.

■ Camera Application Notification

C001 Starting and stopping of camera control module [info]

Description	%1 camerad (C001)
%1	starting stopping
Meaning	The camera control module started/stopped.

C002 Camera application started and stopped [info]

Description	starting cameraappl (C002)
Meaning	The camera application started.

■ Video Notification

V001 Starting and stopping of video server [info]

Description	%1 video (V001)
%1	starting stopping
Meaning	The video server was started/stopped.

V020 Starting intelligent service [info]

Description	starting intelligent. (V020)
Meaning	Intelligent service was started.

V021 Stopping intelligence service [info]

Description	shutdown intelligent. (V021)
Meaning	Intelligent service was stopped.

■ Uploader Notification

A004 Starting and stopping of uploader [info]

Description	%1 uploader (A004)
%1	starting stopping
Meaning	The uploader was started or stopped.

A040 Number of uploads (MAIL) [info]

Description	uploader mail: normal=%1 test=%2 (A040)
%1	Number of normal uploads.
%2	Number of test uploads.
Meaning	Shows the number of uploads executed.

A041 Number of uploads (FTP) [info]

Description	uploader ftp: normal=%1 test=%2 (A041)
%1	Number of normal uploads.
%2	Number of test uploads.
Meaning	Shows the number of uploads executed.

A042 Number of uploads (HTTP) [info]

Description	uploader http: normal=%1 test=%2 (A042)
%1	Number of normal uploads.
%2	Number of test uploads.
Meaning	Shows the number of uploads executed.

■ Memory Card Notification

M001 Starting and stopping of memory card control module [info]

Description	%1 sdctrl (M001)
%1	starting stopping
Meaning	The memory card control module (sdctrl) has started or stopped.

M002 Valid management information inserted [info]

Description	Valid db information (%1)(%2)(%3) was inserted (M002)
%1	Name of management information file with inserted valid information
%2	Directory number of valid information
%3	File number of valid information
Meaning	Added to management information as it appears to be a valid video file.

M003 Started/finished recreation of management information [info]

Description	%1 updating management file (%2)(M003)
%1	Start Finish
%2	Management information identification number
Meaning	Process to recreate management information finished.

■ ONVIF notification (RTP)

R001 Starting RTP distribution module [info]

Description	starting media_plane (R001)
Meaning	RTP distribution module started.

R002 Stopping RTP distribution module [info]

Description	stopping media_plane (R002)
Meaning	RTP distribution module stopped.

R003 RTSP PLAY request received [info]

Description	PLAY received: client_IP=%1, profile=%2, num_of_sessions=%3(V=%4, A=%5, M=%6,BC=%7) (R003)
%1	Client IP address
%2	Name of profile having received PLAY request
%3	Total number of client sessions
%4	Total distribution count of Video stream
%5	Total distribution count of Audio stream
%6	Total distribution count of Metadata stream
%7	Total distribution count of AudioBackChannel
Meaning	RTSP PLAY request was received.

R004 RTSP TEARDOWN request received [info]

Description	TEARDOWN received: client_IP=%1, profile=%2, num_of_sessions=%3(V=%4, A=%5, M=%6,BC=%7) (R004)
%1	Client IP address
%2	Profile name of requested TEARDOWN
%3	Total number of client sessions
%4	Total distribution count of Video stream
%5	Total distribution count of Audio stream
%6	Total distribution count of Metadata stream
%7	Total distribution count of AudioBackChannel
Meaning	RTSP TEARDOWN request was received.

R005 Starting multicast [info]

Description	start multicast: profile=%1, num_of_sessions=%2(V=%3, A=%4, M=%5,BC=%6) (R005)
%1	Client IP address
%2	Name of profile having received MulticastStreaming START request
%3	Total distribution count of Video stream
%4	Total distribution count of Audio stream
%5	Total distribution count of Metadata stream
%6	Total distribution count of AudioBackChannel
Meaning	Multicast was started.



R006 Stopping multicast [info]

Description	stop multicast: profile=%1, num_of_sessions=%2(V=%3, A=%4, M=%5,BC=%6) (R006)
%1	Client IP address
%2	Name of profile having received MulticastStreaming STOP request
%3	Total distribution count of Video stream
%4	Total distribution count of Audio stream
%5	Total distribution count of Metadata stream
%6	Total distribution count of AudioBackChannel
Meaning	Multicast was stopped.

List of Viewer Messages

Messages Shown in the Information Display

Messages shown in the information display of the Camera Viewer are categorized into the following three types.

Icon	Category	Explanation
	Information Message	Displays help messages related to various buttons, pull-down lists, etc., as well as frame rate and other information.
	Warning Message	Displays a message alerting the user when camera control privileges cannot be obtained, the audio session stops, etc.
	Error Message	Displayed when a system error occurs in the Viewer.

Warning Message

Message	Explanation
JavaScript is not available or disabled on your web browser.	JavaScript in the web browser could not be used.
Recreating video management information.	The video management information on the memory card is being recreated.
You do not have video reception permission.	A user without video reception privileges tried to connect to the camera.
No audio device.	The [Audio Reception] button or [Audio Transmission] button was clicked while the computer audio device was unavailable or disabled.
Audio reception is restricted.	Clicked the [Receive Audio] button when [Audio] > [Audio] > [Audio Server] > [Audio Transmission from the Camera] was set to [Disable]. Clicked the [Audio Distribution] button while receiving audio when [Audio Communication Method] was set to [Half Duplex]. S32VE
Audio transmission is restricted. HM4x S32VE	Clicked the [Audio Transmission] button when [Audio] > [Audio] > [Audio Server] > [Audio Reception from Viewer] was set to [Disable]. Clicked the [Audio Distribution] button while receiving audio when [Audio Communication Method] was set to [Half Duplex] in [Audio] > [Audio] > [General Audio].
Currently in the process of starting or ending audio transmission and receiving.	Attempted to start or stop audio transmission and reception while process is running for starting or stopping of audio transmission and reception.
Please get camera control privileges.	An attempt was made to operate the camera without camera control privileges.
Failed to get camera control privileges.	The request for camera control privileges was denied because the camera was being used exclusively by the administrator, etc.
You are not connected to the camera.	An attempt was made to operate the camera when the camera was not connected.
Cannot display the set video in this environment.	An attempt was made to display H.265 video while connecting via HTTP using the web browser that cannot display H.264/H.265 video.
Your web browser is not supported.	Started the Camera Viewer with a web browser that does not support the operating environment.
Another user is already connected as an administrator.	The administrator is already connected to the camera.
Waiting for control privileges.	A guest user enters a state of waiting to obtain control privileges.
Cannot display the selected video in this environment. Changed to a video that can be displayed.	In the case selected video stream cannot be displayed in the current environment

Message	Explanation
The camera is busy.	Exceeded the set [Maximum Number of Clients].
The camera is busy. Changed to a video that can be displayed.	Exceeded the number of clients that can display H.264/H.265 video.
Start Digital PTZ or Viewer PTZ. S820D/S920F	Clicked the pan/tilt slider, zoom slider, or video display area with the Digital PTZ and Viewer PTZ disabled.
You cannot control the camera unless you exit Digital PTZ and Viewer PTZ. HM4x S32VE S32D	The video display area was clicked with the Digital PTZ or Viewer PTZ enabled.
You cannot control the camera unless you exit Viewer PTZ. HM4x S32VE S32D	The video display area was clicked with the Viewer PTZ enabled.
Cannot be controlled, because it is set to manual mode.	Attempted to operate the [Back Light Compensation] button or exposure compensation when [Exposure] was set to [Manual].
Cannot be controlled, because it is set to fixed at infinity mode. HM4x S32VE S32D	Attempted to operate the focus when [Focus] was set to [Fixed at infinity].
Insufficient memory card capacity.	An attempt was made to manually record to a memory card with insufficient capacity.
Recording to memory card is not allowed.	Recording to the memory card failed because [Memory Card Operations] > [Operation Settings] was not set to [Save Logs and Videos].
User authentication failed.	User authentication failed, or when connected as an authorized user, the [Audio Transmission] button was clicked after [Audio Distribution] for the authorized user being disabled in [User Authority].

Restoring Factory Default Settings

If settings have been forgotten and wanting to set the camera from the beginning, restore the factory default settings first. It is recommended to create a backup file before restoring the factory default settings using [Maintenance] > [Backup / Restore] on the Settings page (P. 155).

Important

- If restored to the factory default settings, it will become impossible to connect to the camera because the administrator account is also initialized. Use the Camera Management Tool to configure the initial settings.

Note

- Settings can also be backed up using the Camera Management Tool. For details on using the Camera Management Tool, refer to “Camera Management Tool User Manual”.
- For factory default settings, refer to P. 183.

Restoring the Initial Settings from a Web Browser

Use [Maintenance] > [General] > [Initialization] > [Network Settings and Management Information] > [Do not save] on the Settings page to restore (P. 153).

Restoring Factory Default Settings with the Reset Switch on the Camera

If the IP address of the camera or the account information of the administrator is forgotten or unknown, users cannot operate the camera via the network. In this case, press the reset switch of the camera to initialize.

Prepare the camera in advance to be reset.

1 Remove the top cover. **S32VE**

For top cover removal, refer to the “Installation Guide”.

2 Turn off the camera.

The camera does not have a power switch. Turn the camera on and off by plugging in or unplugging the LAN cable (PoE power supply) or the power cable **HM4x**.

3 Turn on the power while pushing the reset switch, confirm that the LED lights up, and then release the reset switch after five seconds.

The reset switch is located in the back of the hole. Push the switch using the tip of a slender object such as a clip. When the LED stops flashing, the reset procedure is complete.

All settings of the camera, except for the date and time, are restored to the factory default settings.

VB-H47, VB-M46

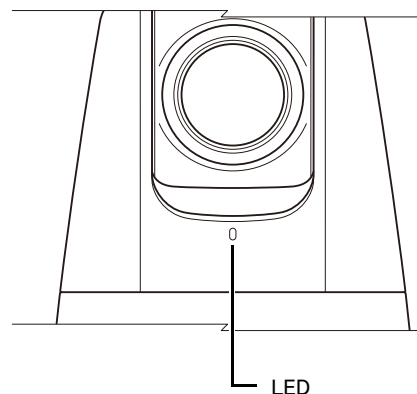
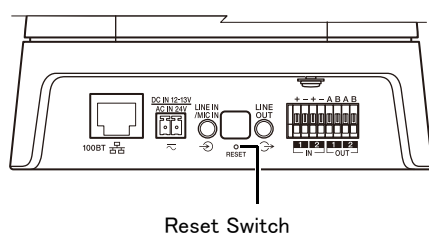

VB-S32VE

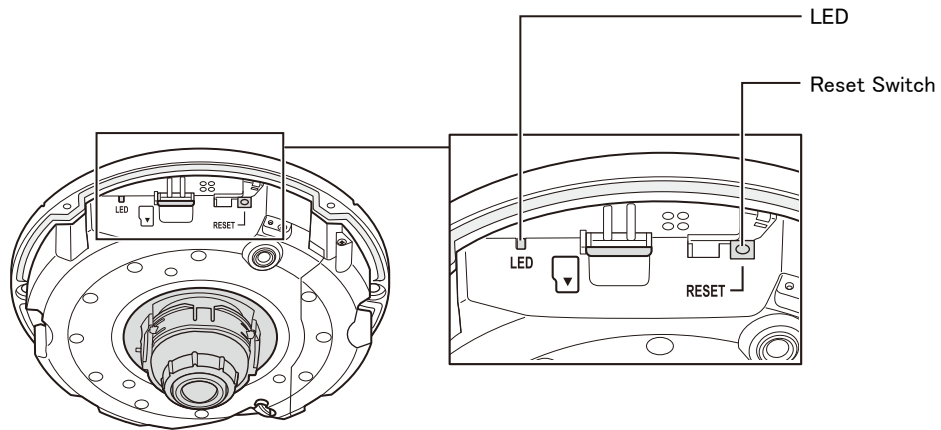

VB-S32D, VB-S820D

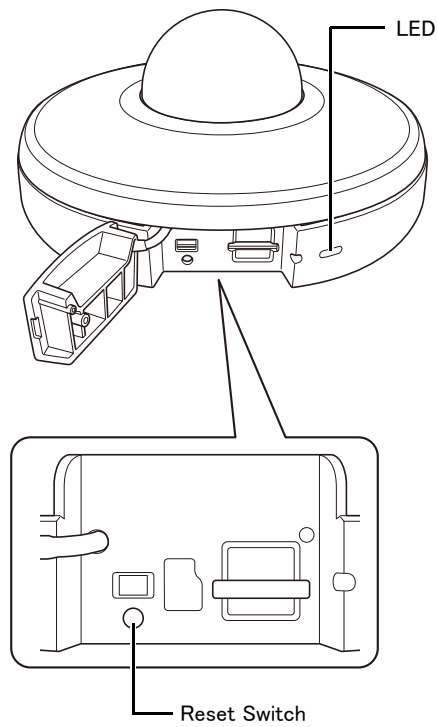

VB-S920F

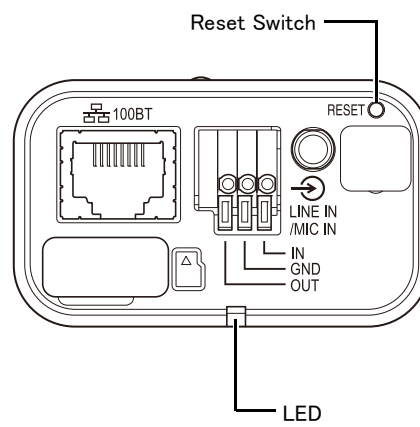

4 Attach the top cover. **S32VE**

For top cover attachment, refer to the "Installation Guide".

List of Factory Default Settings

[Video] > [Video]

Stream 1	
Video Compression Method	H.264
Video Size	1920 x 1080
Frame Rate (fps)	30
Profile	High
Bit Rate Control	MBR
Video Quality	6
Maximum Bit Rate (kbps)	2048
Target Bit Rate (kbps)	2048
I Frame Interval (sec)	1
Stream 2	
Video Compression Method	H.264
Video Size	1280 x 720
Frame Rate (fps)	30
Profile	High
Bit Rate Control	MBR
Video Quality	6
Maximum Bit Rate (kbps)	2048
Target Bit Rate (kbps)	2048
I Frame Interval (sec)	1
Stream 3	
Video Compression Method	JPEG
Video Size	1920 x 1080
Maximum Transmitted Frame Rate (fps)	30.0
Video Quality	6
Stream 4	
Video Compression Method	JPEG
Video Size	1280 x 720
Maximum Transmitted Frame Rate (fps)	30.0
Video Quality	6
Digital PTZ	
Video Compression Method	JPEG
Video Size	640x360
Frame Rate (fps)	30
Profile	High
Bit Rate Control	MBR
Maximum Transmitted Frame Rate (fps)	30.0

Video Quality	6
Maximum Bit Rate (kbps)	128
Target Bit Rate (kbps)	128
I Frame Interval (sec)	1

[Video] > [Preset Tour] **HM4x** **S820D/S920F**

Route List HM4x	
Conditions to Enable Settings	Disable
Route Name	
Route Name (alphanumeric characters)	
Specify Active Time	Not Specified
Start Time	00:00
End Time	00:00
Reverse Route	Disable
Speed (PT)	1 (Slow)
Speed (Z)	1 (Slow)
Pause (sec)	1
Route S820D/S920F	
Conditions to Enable Settings	Disable
Specify Active Time	Not Specified
Start Time	00:00
End Time	00:00
Pause (sec)	1

[Video] > [Picture (Option)]

Camera Control	
Digital Zoom HM4x S32VE S32D	Enable
Enhanced Digital Zoom HM4x	Disable
Maximum Digital Zoom Magnification HM4x	5
Image Stabilizer HM4x	Disable
Smart Shade Control Strength (Auto)	Medium
Haze Compensation Strength (Auto)	Medium
Motion-Adaptive Noise Reduction	Disable
Pan/Tilt Speed Control HM4x S32VE S32D	Control at set speed
AF Response HM4x S32VE S32D	High
Day/Night	
Day/Night Mode Focus Control HM4x	One-shot AF
Switching Brightness	Standard

Response (sec.)	20
-----------------	----

[Video] > [ADSR]

General ADSR	
Data Size Reduction Level	Medium
Enable in Stream 1	Disable
Enable in Stream 2	Disable

[Video] > [On-screen display]

Date display	
Date display	Disable
Format of date display	YYYY/MM/DD
Time display	
Time display	Disable
Text display	
Text display	Disable
Text string display	
Position of text display	Top
Common Settings	
Font Size	Medium
Color of text	White
Background color	Black
Color depth of text and background	Fill text and background color
Text Outline	Disable
Position of date/time display	Top

[Video] > [Privacy Mask]

Mask area	
Color	Black

[Video] > [View Restriction] **HM4x** **S32VE** **S32D**

View Restrictions	
View Restrictions	Disable

[Audio] > [Audio]

General Audio	
Audio Input	Disable
Input Volume	50
Low-Cut Filter S32VE	Disable
Mute During Pan/Tilt S32VE	Do Not Mute
Output Volume HM4x S32VE	50
Audio Communication Method HM4x S32VE	Full Duplex
Audio Input Mode HM4x S32D S820D/S920F	Line In

AAC-LC	
Sampling Frequency (kHz)	48
Bit Rate (kbps)	128
Audio Server	
Audio Transmission from the Camera	Disable
Voice Activity Detection	Disable
Audio Reception from Viewer HM4x S32VE	Disable

[Video Record] > [Upload]

Video Record Settings	
Video Record Action	Upload
Video Type	Stream 1 H.264 1920x1080
General Upload	
Upload	Upload Disabled
Frame Rate	1
Pre-event Buffer (number of frames)	0
Post-event Buffer (number of frames)	0
Pre-event Buffer (sec)	0
Post-event Buffer (sec)	0
FTP Upload	
Notification	Video
SSL Connection	Disable
Verify Server Certificate	Verify
FTP Server	
User Name	
PASV Mode	Enable
File Upload Path	
File Naming	YYYYMMDDHHMMSS ms
Subdirectory Name to Create	
File Name to Create	image.jpg
File Name to Create	video.mp4
Maximum Number of Loops	0
HTTP Upload	
Notification	Notification
SSL Connection	Disable
Verify Server Certificate	Verify
URI	
User Name	
Proxy Server	
Proxy Port	80
Proxy User Name	
Parameter (query string)	

[Video] > [Memory Card Recording]

Video Record Settings	
Video Record Action	Upload
Video Type	Stream 1 H.264 1920x1080
Memory Card Operations	
Operation Settings	Save Logs and Videos
Continuous Recording	Disable
Pre-event Buffer (number of frames)	0
Post-event Buffer (number of frames)	0
Pre-event Buffer (sec)	0
Post-event Buffer (sec)	0
Overwrite videos	Enable
Auto Video Delete	Disable
Days Saved	30
Delete Time	00:00

[Video Record] > [E-mail Notification]

E-mail Notification	
Notification	Text Only
Mail Server Name	
Mail Server Port	25
Sender (From)	
Recipient (To)	
Authentication	None
User Name	
Verify Server Certificate	Verify
POP Server	
Subject	
Message Body	

[Detection] > [Audio Detection]

Volume Detection	
Volume Detection Event	Disable
Detection Conditions	The reference volume level or above
Reference Volume Level	50
Detection Condition Duration (sec)	0
ON Event Operation	Disable
OFF Event Operation	Disable
Ongoing ON Event Operation	Disable
Preset	None
Video Record	Disable
E-mail Notification	Disable
External Device Output for ON Event	Disable

External Device Output for OFF Event	Disable
--------------------------------------	---------

[Event] > [External Device]

External Device Output S32VE S32D S820D/S920F	
Operation Mode	Normally Open
Active Output Format	Continuous
Pulse Output Time (sec)	1
External Device Output 1, 2 HM4x	
Operation Mode	Normally Open
Active Output Format	Continuous
Pulse Output Time (sec)	1
External Device Input	
External Device Input Event	Enable
External Device Input 1 (Title is displayed for HM4x only)	
Operation Mode	Normally Open
Active Event Operation	Disable
Inactive Event Operation	Disable
Ongoing Active Event Operation	Disable
Preset HM4x S32VE S32D	None
Video Record	Disable
E-mail Notification	Disable
External Device Output for Active Event	Disable
External Device Output for Inactive Event	Disable
Audio Playback at Active Event HM4x S32VE	Disable
Audio Playback at Inactive Event HM4x S32VE	Disable
Sound Clip HM4x S32VE	
Volume HM4x S32VE	50
Day/Night Mode Switching	Disable
External Device Input 2 HM4x	
Operation Mode	Normally Open
Active Event Operation	Disable
Inactive Event Operation	Disable
Ongoing Active Event Operation	Disable
Preset	None
Video Record	Disable
E-mail Notification	Disable
External Device Output for Active Event	Disable
External Device Output for Inactive Event	Disable
Audio Playback at Active Event	Disable
Audio Playback at Inactive Event	Disable

Sound Clip	
Volume	50
Day/Night Mode Switching	Disable

[Event] > [Timer]

Timer 1	
Timer Event	Disable
24-Hour Continuous Settings	Disable
Start Time	00:00
End Time	00:00
Repeat Interval	None
Operation	
Start Time Preset HM4x S32VE S32D	None
Video Record	Disable
E-mail Notification	Disable
External Device Output	Disable
Day/Night Mode Switching	Disable
Timer 2 to 4	
Timer Event	Disable
24-Hour Continuous Settings	Disable
Start Time	00:00
End Time	00:00
Repeat Interval	None
Operation	
Start Time Preset HM4x S32VE S32D	None
Video Record	Disable
E-mail Notification	Disable
External Device Output	Disable

[Event] > [Switch Day/Night]

Switch Day/Night	
Preset when Switching to Day Mode	None
Preset when Switching to Night Mode	None

[Event] > [Linked Event]

Linked Event 1 to 4	
Linked Event	Disable
Event Linking Method	AND
Event Order	Not Specified
Event Gap (seconds)	2
Event 1, 2	
Event Type (Event 1)	External Device Input
Event Type (Event 2)	Intelligent Function

Volume Detection Status	ON
External Device Input HM4x	Input 1
External Device Input Status	Active
Timer	Timer 1
Intelligent Function	Setting 1
Intelligent Function Status	ON
Operation	
ON Event Operation	Disable
Ongoing ON Event Operation	Disable
OFF Event Operation	Disable
Preset HM4x S32VE S32D	Not Specified
Video Record	Disable
E-mail Notification	Disable
External Device Output for ON Event	Disable
External Device Output for OFF Event	Disable
Audio Playback at ON Event HM4x S32VE	Disable
Audio Playback at OFF Event HM4x S32VE	Disable
Sound Clip HM4x S32VE	
Volume HM4x S32VE	50

[Server] > [Server]

HTTP Server	
Authentication Method	Digest Authentication
HTTP Port	80
HTTPS Port	443
SNMP Server	
Use SNMP v1 and v2c	Disable
Use SNMP v3	Disable
Administrator Contact Information	
Administration Function Name	(Model Name)
Installation Location	
SNMP v3 Server	
User Name	
Security Level	No authentication and no encryption
Authentication Algorithm	SHA1
Encryption Algorithm	AES

[Server] > [Video Server]

Video Server	
Maximum Number of Clients	30
Camera Control Queue Length	30

Maximum Connection Time (sec.)	0
Camera Control Time (sec.)	20

[Server] > [RTP Server]

RTP Server	
RTP	Enable
RTSP Authentication Method	Digest Authentication
RTSP Port	554
Audio Settings 1	
Audio Compression Method	G.711
Multicast Address	0.0.0.0
Multicast Port	0
Multicast TTL	1
Audio Settings 2	
Audio Compression Method	AAC-LC
Multicast Address	0.0.0.0
Multicast Port	0
Multicast TTL	1
RTP Stream 1 to 5	
Multicast Address	0.0.0.0
Multicast Port	0
Multicast TTL	1
Audio Transmission	Disable

[ONVIF] > [ONVIF]

WS-Security	
Check Time on Authentication	Check
Media Profile Settings	
Media Profile List	profile1 - Stream 1 H.264 1920x1080 profile2 - Stream 2 H.264 1280x720 profile3 - Stream 3 JPEG 1920x1080 profile4 - Stream 4 JPEG 1280x720 profile5 - Digital PTZ JPEG 640x360

[Security] > [SSL/TLS]

Encrypted Communications	
HTTPS Connection Policy	HTTP and HTTPS
Server Certificates	
Certificate Validity Period	2001/01/01 - 2037/12/31

[Security] > [802.1X]

802.1X Authentication	
802.1X Authentication	Disable

Authentication Status	Stop
Authentication Method	
Authentication Method	EAP-TLS
User Name	
Client Certificates	
Certificate Validity Period	Not selected

[Security] > [User Management]

Administrator Account	
Administrator Name	
Authorized User Account	
User List	
User Authority	
Authorized User Camera Control	Video Distribution and Privileged Camera Control
Guest User Camera Control	No access privileges
Authorized User Audio Distribution	Yes
Guest User Audio Distribution	No

[Security] > [Host Access Restrictions]

IPv4 Host Access Restrictions	
Apply Host Access Restrictions	Disable
Default Policy	Authorize Access
IPv6 Host Access Restrictions	
Apply Host Access Restrictions	Disable
Default Policy	Authorize Access

[System] > [System]

Camera Name	
Camera Name	(Model Name)
Camera Name (alphanumeric characters)	(Model Name)
Installation Conditions	
Dome HM4x	Disable
LED Setting	Turn On
Video Flip	Disable
Camera Position Control	
Restricted to Presets HM4x S32VE S32D	No Restriction
Camera Position without Control	Do not return to Home Position
External Input Device S32VE S32D S820D/S920F External Input Device 1, 2 HM4x	
Device Name	
Device Name (alphanumeric characters)	

External Output Device S32VE S32D S820D/S920F External Output Device 1, 2 HM4x	
Device Name	
Device Name (alphanumeric characters)	

[System] > [Viewer]

General	
Default Page	Display Settings Page
Viewer Settings	
User Authentication	Authenticate
Rotate Video Display S820D/S920F	Do not rotate
In-Viewer Picture Adjustment	Do not allow

[System] > [Date and Time]

Settings	
Settings Method	Set manually
Set NTP Server Settings Automatically	Disable
NTP Server	
NTP Server (DHCP)	
NTP Server (DHCPv6)	
Synchronization Interval (minutes)	5
Last Sync Time	
Time Zone	(GMT+09:00) Osaka, Sapporo, Tokyo
Daylight Saving Time	Disable

[System] > [Network]

LAN	
Maximum Packet Size	1500
IPv4	
IPv4 Address Settings Method	Auto (DHCP)
IPv4 Address	192.168.100.1
IPv4 Address (DHCP)	
Subnet Mask	255.255.255.0
IPv4 Default Gateway Address	
IPv4 Default Gateway Address (DHCP)	
AutoIP	Enable
IPv4 Address (AutoIP)	
IPv6	
IPv6	Enable
Auto (RA)	Enable
Auto (DHCPv6)	Enable
IPv6 Address (Manual)	

Prefix Length	64
IPv6 Default Gateway Address	
IPv6 Address (Auto)	
DNS	
Name Server Address 1	Use DHCP/DHCPv6
Name Server Address 2	
Set Name Server Address Automatically	
Name Server Address (DHCP)	
Name Server Address (DHCPv6)	
Host Name	
Host Name Registration with DDNS	Do Not Register
mDNS	
Use mDNS	Enable

[Maintenance] > [Environment]

Environment	
System Frequency (Hz)	60
WDR	Mild
Intelligent Function	Disable

[Maintenance] > [Log]

Log Notifications	
Use log notifications	Disable
Notification Level	Error
Mail Server Name	
Mail Server Port	25
Sender (From)	
Recipient (To)	
Authentication	None
User Name	
Verify Server Certificate	Verify
POP Server	
Subject	

Cleaning the Camera

Confirmation of Video Image

Regularly check to make sure the set capture area is not misaligned, and is still in focus.
If necessary, re-adjust it.

Cleaning Method

Before beginning any work, turn off the power.

■ Cleaning the Dome Cover, Top Cover, and Lens Protector

- 1** Wash off foreign substances such as dust and sand using a soft cloth dampened with clean water*.
* Outdoor cameras **S32VE** can also be flushed with clean water (such as tap water).
- 2** If they are dirty with something that cannot be removed with water, such as fingerprints or oil, gently wipe them clean with a soft sponge or cloth dampened with a neutral dishwashing detergent diluted to approximately 1% with water.
- 3** Wipe them clean with a soft cloth that has been dampened with clean water to ensure that water droplets and detergent do not remain.

Warning

Do not use flammable solvents such as alcohol, paint thinner or benzine when cleaning the camera.
Failure to follow these precautions could result in fire or electric shock.

Caution

Periodically inspect the parts and screws for rust and loosening. For inspections, contact a Canon's sales representative.
Failure to follow these precautions could result in injuries and equipment damage due to falling.



Important

- By performing an incorrect cleaning method, the dome cover or top cover, or lens protector could become scratched and will need to be replaced for a fee. Therefore, follow the next set of instructions carefully.
 - Because of dust, dirt, or fingerprints etc. the auto focus may not work properly, or the reflection of backlight or infrared illumination could cause the image to become white and cloudy. In order to preserve the level of image quality, it is necessary to regularly clean the protective window.
 - Do not wipe with a dry cloth. Never wipe with a cloth especially without removing the attached grime. This may result in scratches to the dome cover, top cover and/or lens protector.

■ Cleaning the Lens

Use a commercial lens cleaner to remove grime on the lens surface.

- Scratches on the lens surface may result in poor video capture.
- If the lens surface is dusty or dirty, the autofocus may not function properly. **HM4x S32VE S32D**

Camera Disposal

Dispose of the camera in accordance with local laws and regulations.

When disposing the camera, initialize the camera and delete all setting information of the camera (P. 181). Be sure to remove the memory card from the camera before the disposal.

Numerics

802.1X Authentication Method 140

A

Access Restrictions 28
 Administrator 142
 Administrator Account 141
 Administrator Password 141
 ADSR 78
 AGC Limit 63
 Aperture 64
 Area Zoom 37
 Audio Communication Method 93
 Audio Detection 50, 104
 Audio Distribution 142
 Audio Input 92
 Audio Input Mode 93
 Audio Multicast 134
 Audio Reception 48, 94
 Audio Server 93
 Audio Transmission 49, 93
 Authentication Method 131, 140
 Authority 142
 Authorized User 141, 142
 Auto Video Delete 100
 AutoIP 151

B

Back Light Compensation 40
 Back Up Settings 155
 Backup 155

C

Camera Control 142
 Camera Control Privileges 35
 Camera Control Queue Length 133
 Camera Control Time 133
 Camera Management Tool 15
 Camera Name 144

Camera Operation

Day/Night 40
 Exposure Compensation 40
 Focus 40
 Pan/Tilt 38
 Pan/Tilt Speed 39
 Zoom 39
 Zoom Speed 39

Camera Position 61
 Camera Viewer 26, 27
 Color Saturation 68
 Control Privileges 35
 Current Volume Level 104

D

Date 147
 Day Mode 40, 65
 Day/Night 40, 65, 76
 Day/Night Mode Switching 123, 125
 Daylight Saving Time 148
 Default Gateway Address 151
 Default Page 146
 Detection Conditions 104
 Device Name 145
 DHCP 150
 DHCPv6 151
 Digital PTZ 44
 Digital Zoom 36
 Display Size 32
 DNS 152
 Dome 144
 Drag to Move 38

E

E-mail Notification 102, 105, 122, 125, 128
 Enhanced Digital Zoom 36
 Error Message 179
 Event and Input/Output
 Audio Detection 50
 External Device Input 50
 External Device Output 50
 Linked Events 51
 Video Detection 50
 Event Display 50
 Exposure 63
 Exposure Compensation 40, 64

External Device Input	50, 121
External Device Output	121
External Input Device	145
External Output Device	145

F

Face Detection	109, 119
Factory Default Settings	181, 183
Firewall	21
Firmware	156
Focus	40, 66, 67
Format	149
Full Screen Display	33

G

Gain	64, 68
Guest user	142

H

H.264/H.265 Video	16
Haze Compensation	65
Home Position	41, 69
Host Access Restrictions	143
HTTP Port	131
HTTP Server	131
HTTPS Port	131

I

Information Message	179
Infrared Cut Filter	65
Input Volume	92
Installation	20
Installation Guide	11
IPv4	150
IPv4 Address	151
IPv6	151

J

JPEG	32
------------	----

L

LAN	150
Language Switch Button	54
LED	144
Linked Event	51, 127
Log	158

Log Messages	166
Low-Cut Filter	92

M

Main	
Language	30
Mobile Camera Viewer	30
Settings Page	29
Switch Users	30
Maintenance	153
Maximum Bit Rate	59
Maximum Connection Time	133
Maximum Number of Clients	133
Maximum Packet Size	150
mDNS	152
Memory Card	14, 149
Memory Card Capacity	101
Memory Card Information	101, 149
Message	
Error Message	179
Information Message	179
Log Message	166
Warning Message	179
Metering Mode	64
Mobile Camera Viewer	11, 15, 17
Modifiers	161
Mount	149
Multicast DNS	152
Mute During Pan/Tilt	93

N

Name Server Address	152
Network	150
Network Address / Subnet	143
Night Mode	40, 65
Noise Reduction	68
Notification	102
NTP Server	147

O

One-shot AF	67
One-shot WB	68
On-screen display	80
Operation Mode	121, 122
Operation Settings	100
Output Volume	93
Overwrite videos	100

P

Pan	36, 38
Panorama	89
Panorama Display Panel	39
Panorama Screen	56, 73
Parameter	161
Password	141
Post-event Buffer	100
Pre-event Buffer	100
Prefix	143, 151
Preset	41, 45, 61, 69, 105, 122, 128
Start Time Preset	124
When switching Day/Night Mode	126
Preset Name	70
Preset Selection Menu	41
Preset Tour	71
Privacy Mask	82
Privileged Camera Control	142
Pulse	121

R

Reconnect	56
Recorded Video Utility	11, 15, 47
Recording Manually	47
Recording to a Memory Card	47
Reference Volume Level	104
Reset Switch	181
Restore	155
Restore Settings	155
Rotate Video Display	146
RTP	134
RTSP	134

S

Settings Menu	54
Settings Page	52
Sharpness	68
Shutter Speed	64
Shutter Speed Limit	63
Simple Camera Settings	61
Smart Shade Control	65
Snapshot	46, 56
SNMP Server	131
Sound Clip Upload	94
Still Image	46
Subnet Mask	151
Switch Day/Night	126

T

Tilt	36, 38
Time	147
Time Zone	148
Timer	124
Tour Route Settings	73
Troubleshooting	163
Trusted Sites	21

U

Unmount	149
Upload	95
User Account	141
User Authentication	146
User Authority	142
User List	141
User Management	141
User Name	141

V

Video and Audio	
Display Size Setting	32
Maximum Frame Rate	32
Video Size	32
Video Detection	50
Video Display Area	29, 55
Video Distribution	142
Video Flip	144
Video Management Information	149
Video Record	105, 122, 125, 128
Video Record Action	95, 99
Video Saving	101
Video Server	133
Video Size	32, 135
Video Stream	58
View restriction	85
Viewer	
Camera Viewer	15, 26
Mobile Camera Viewer	11, 15
Viewer Message	179
Viewer PTZ	42
Voice Activity Detection	93
Volume	48, 49, 123
Volume Detection	104

W

Warning Message	179
White Balance	67

Z

Zoom 36, 38

FCC NOTICE

Network Camera, Model Name: VB-H47/VB-M46/VB-S32D

This device complies with Part 15 of the FCC Rules. Operation is subject to the following two conditions: (1) This device may not cause harmful interference, and (2) this device must accept any interference received, including interference that may cause undesired operation.

Note: This equipment has been tested and found to comply with the limits for a Class A digital device, pursuant to Part 15 of the FCC Rules.

These limits are designed to provide reasonable protection against harmful interference when the equipment is operated in a commercial environment. This equipment generates, uses, and can radiate radio frequency energy and, if not installed and used in accordance with the user manual, may cause harmful interference to radio communications. Operation of this equipment in a residential area is likely to cause harmful interference in which case the user will be required to correct the interference at his own expense.

Do not make any changes or modifications to the equipment unless otherwise specified in the manual. If such changes or modifications should be made, you could be required to stop operation of the equipment.

Canon U.S.A., Inc.

One Canon Park, Melville, New York 11747, U.S.A.

Tel No. 1-800-OK-CANON (1-800-652-2666)

Only for European Union and EEA (Norway, Iceland and Liechtenstein) and United Kingdom



These symbols indicate that this product is not to be disposed of with your household waste, according to the WEEE Directive (2012/19/EU), the Battery Directive (2006/66/EC) and/or national legislation implementing those Directives and the UK Waste Electrical and Electronic Equipment Regulations and the UK Batteries and Accumulators Regulations.

■
If a chemical symbol is printed beneath the symbol shown above, in accordance with the Battery Directive and the UK Batteries and Accumulators Regulations, this indicates that a heavy metal (Hg = Mercury, Cd = Cadmium, Pb = Lead) is present in this battery or accumulator at a concentration above an applicable threshold specified in the Battery Directive and the UK Batteries and Accumulators Regulations.

This product should be handed over to a designated collection point, e.g., on an authorized one-for-one basis when you buy a new similar product or to an authorized collection site for recycling waste electrical and electronic equipment (EEE) and batteries and accumulators. Improper handling of this type of waste could have a possible impact on the environment and human health due to potentially hazardous substances that are generally associated with EEE. Your cooperation in the correct disposal of this product will contribute to the effective usage of natural resources.

For more information about the recycling of this product, please contact your local city office, waste authority, approved scheme or your household waste disposal service or visit www.canon-europe.com/sustainability/approach/.