

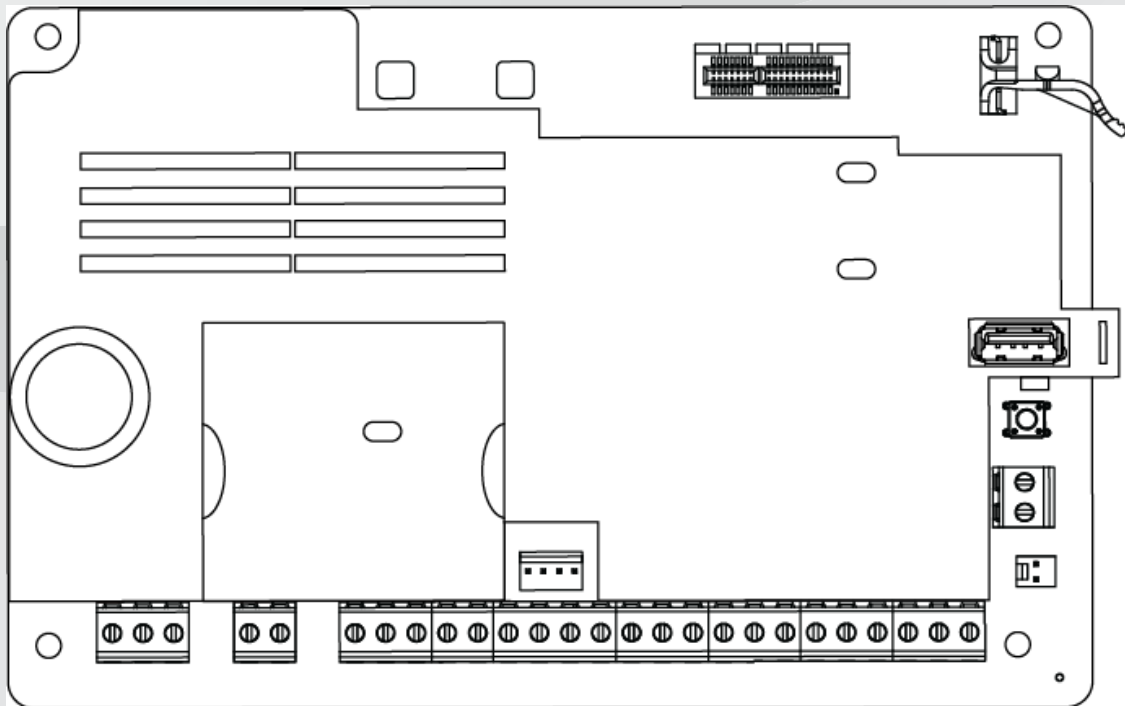

**BOSCH**

## Control panels

B6512/B5512/B4512/B3512



en

UL Installation manual



## Table of contents

<b>1</b>	<b>Introduction</b>	<b>4</b>
1.1	About documentation	4
1.1.1	Related documentation	4
1.2	Bosch Security Systems, Inc. product manufacturing dates	5
<b>2</b>	<b>System overview</b>	<b>6</b>
2.1	Parts list	6
2.2	Control panel capacities	6
<b>3</b>	<b>Control panel installation</b>	<b>7</b>
3.1	Installing the enclosure and wiring label	7
3.2	Installing the control panel	7
3.2.1	Earth ground	9
3.2.2	OUTPUT A jumper	9
3.3	Control panel to module wiring overview	9
<b>4</b>	<b>Power supply</b>	<b>11</b>
4.1	Primary (AC) power	11
4.2	Secondary (DC) power	11
4.2.1	Install the battery	11
4.2.2	Battery maintenance	13
4.2.3	Battery supervision	13
4.2.4	Battery discharge and recharge schedule	13
4.3	B520 aux power supply	13
4.3.1	SDI2 address settings	14
4.3.2	Supervision	14
4.3.3	Auxiliary power supply trouble conditions	14
4.3.4	Installation and control panel wiring (B520)	14
4.3.5	Powered device and battery wiring	16
<b>5</b>	<b>On-board outputs</b>	<b>19</b>
5.1	Circuit protection	19
5.2	Total available power	19
5.3	Open collector outputs	20
<b>6</b>	<b>Control panel board overview</b>	<b>21</b>
<b>7</b>	<b>System wiring diagrams</b>	<b>22</b>
7.1	System wiring overview	22
7.2	Battery lead supervision wiring	23
7.3	2-wire smoke wiring (B201)	24
7.4	2-wire smoke wiring (D125B)	25
7.5	Input point wiring, dual EOL resistor circuit style	26
7.6	Notification appliance circuit wiring	26
7.7	Keyswitch wiring	28
7.8	SDI2 devices general system wiring	28
7.8.1	SDI2 bus wiring recommendations	29
7.9	Wiring label	32
<b>8</b>	<b>Specifications</b>	<b>33</b>
8.1	Wire requirements	34

# 1 Introduction

This section includes an introduction to documents for this product and other document-related instructions.

## 1.1 About documentation

This document has instructions for a trained installer to install, configure, and operate this control panel, and optional peripheral devices.

(Bosch Security Systems, Inc. recommends that installers follow good wiring practices such as those described in NFPA 731, Standard for the Installation of Electronics Premises Security Systems.)

Throughout this document, the words “control panel” refer to all control panels covered by this document (B6512/B5512/B4512/B3512).

### Notifications

This document uses Notices, Cautions, and Warnings to draw your attention to important information.



#### Notice!

These include important notes for successful operation and programming of equipment, or indicate a risk of damage to the equipment or environment.



#### Caution!

These indicate a hazardous situation which, if not avoided, could result in minor or moderate injury.



#### Warning!

These indicate a hazardous situation which, if not avoided, could result in death or serious injury.

### Copyright

This document is the intellectual property of Bosch Security Systems, Inc. and is protected by copyright. All rights reserved.

### Trademarks

All hardware and software product names used in this document are likely to be registered trademarks and must be treated accordingly.

### 1.1.1

## Related documentation

### Control panel documents

Control Panels (B6512/B5512/B4512/B3512) Release Notes*
Control Panels (B6512/B5512/B4512/B3512) Installation Manual <sup>†</sup>
Control Panels (B9512G/B8512G/B6512/B5512/B4512/B3512) Operation Manual* <sup>†</sup>
Control Panels (B5512/B4512/B3512) Program Entry Guide <sup>†</sup>
Control Panel (B6512) Program Entry Guide
Control Panels (B6512/B5512/B4512/B3512) UL Installation Manual* <sup>†</sup>

Control Panels (B6512/B5512/B4512/B3512) SIA Quick Reference Guide* +
Control Panels (B9512G/B8512G/B6512/B5512/B4512/B3512) ULC Installation Manual*
*Shipped with the control panel.
*Located on the documentation CD shipped with the control panel.

### Keypad documents

Basic Keypad (B915) Installation Guide*
Two-line Alphanumeric Keypad (B920) Installation Guide*
Two-line Capacitive Keypad with Inputs (B921C) Installation Guide*
ATM Style Alphanumeric Keypad (B930) Installation Guide*
B940W Touch screen KP, White Quick installation guide*
Touch Screen Keypad (B942/B942W) Installation Guide*
*Shipped with the keypad.

### Optional module documents

2-wire Powered Loop Module (B201) Installation and Operation Guide*
Octo-input Module (B208) Installation and Operation Guide*
Octo-output Module (B308) Installation and Operation Guide*
Conettix Ethernet Communication Module (B426) Installation and Operation Guide* +
Plug-in Telephone Communicator (B430) Installation Guide Installation Guide*
Conettix Plug-in GPRS Cellular Communicator (B442) Installation and Operation Guide*
Conettix Plug-in HSPA+ Cellular Communicator (B443) Installation and Operation Guide*
Conettix Cellular Communicators B44x Installation Manual
B444-A   B444-V Quick installation guide*
Conettix Plug-in Communicator Interface (B450) Installation and Operation Guide* +
Auxiliary Power Supply (B520) Installation and Operation Guide*
RADION receiver SD (B810) Installation Guide*
SDI2 Inovonics Interface Module (B820) Installation Guide*
*Shipped with the module.
*Located on the documentation CD shipped with the module.

## 1.2

### Bosch Security Systems, Inc. product manufacturing dates

Use the serial number located on the product label and refer to the Bosch Security Systems, Inc. website at <http://www.boschsecurity.com/datecodes/>.

## 2 System overview

This section has the following information:

- *Parts list, page 6*
- *Control panel capacities, page 6*
- Accessories
- Features

### 2.1 Parts list

Control panels ship assembled from the factory with the following parts:

#### Literature

- Control Panels (B6512/B5512/B4512/B3512) UL Installation Manual
- Control Panels (B6512/B5512/B4512/B3512) Operation Manual
- Control Panels (B6512/B5512/B4512/B3512) SIA Quick Reference Guide
- Control Panels (B6512/B5512/B4512/B3512) Documentation CD
- Enclosure Wiring Label (B6512/B5512/B4512/B3512)

#### HW pack

- Mounting clips
- 1 k $\Omega$  EOL resistors
- Battery wires
- Four #6 x 3/4 in self threading screws

#### Assembly

- PC board

### 2.2 Control panel capacities

Features	B6512	B5512	B4512	B3512
Number of users	100	50	32	10
Number of custom functions	6	4	2	1
Number of areas	6	4	2	1
Number of points	96	48	28	16
Number of outputs	91	43	27	3
Number of keypads	12	8	8	4
Number of doors	4	0	0	0
Number of octo-input modules (B208)	9	4	2	0
Number of octo-output modules (B308)	9	5	3	0
Number of on-board Ethernet ports	1	1	1	1
Number of B426 or B450 modules	1	1	1	1
Number of plug-in modules (B430, B442/B443/B444-A/B444-V)	1	1	1	1
Number of auxiliary power supply modules (B520)	4	4	2	2
Number of wireless receivers (B810/B820)	1	1	1	1

### 3 Control panel installation

Refer to Enclosures to determine if the application requires a specific enclosure.

#### Enclosure overview

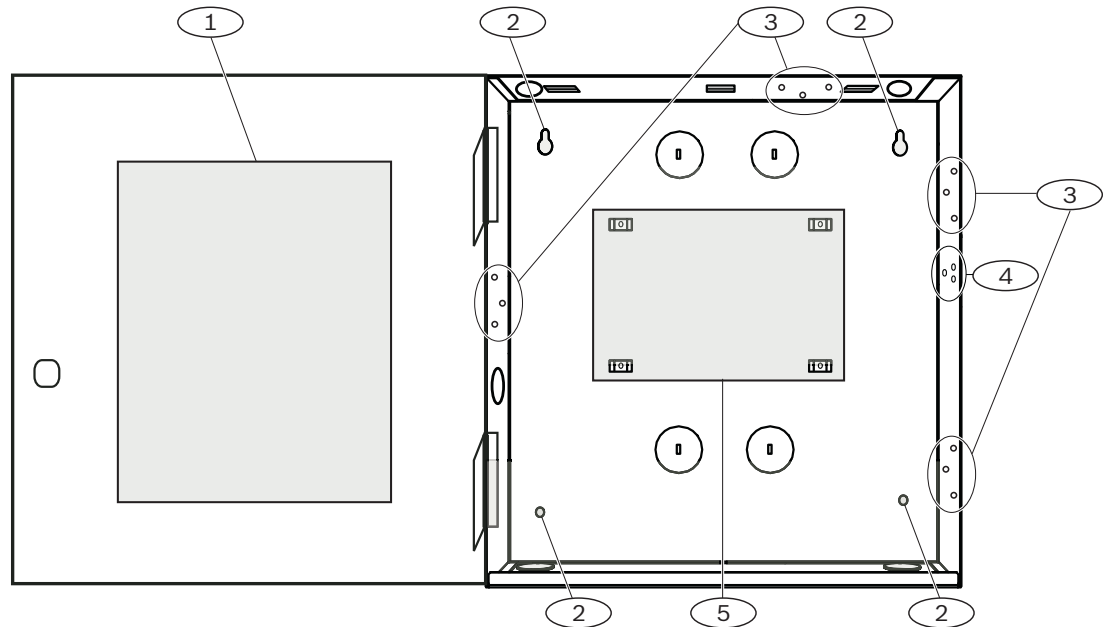

#### Callout — Description

1	— Control panel wiring label
2	— Enclosure mounting holes (4)
3	— Three-hole pattern for mounting modules (4)
4	— Mounting location for the tamper switch
5	— Mounting location for the control panel

#### 3.1 Installing the enclosure and wiring label



##### Notice!

##### Electromagnetic interference (EMI)

EMI can cause problems on long wire runs.

1. Remove the knockouts.
2. Mount the enclosure. Use all enclosure mounting holes. Refer to the mounting instructions supplied with the selected enclosure.
3. Pull the wires into the enclosure through the knockouts.
4. Position the supplied enclosure wiring label on the inside of the enclosure door.

#### 3.2 Installing the control panel

1. Identify the control panel mounting location in the enclosure.

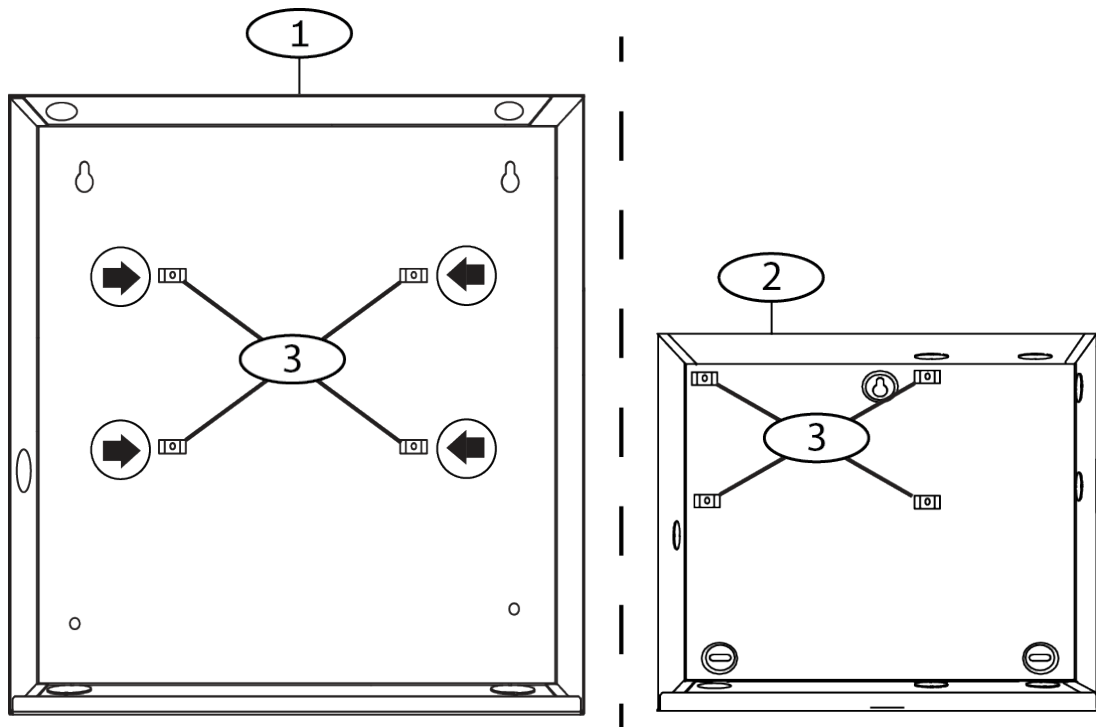
**Callout — Description**

- |   |
|---|
| 1 — B10 Medium Control Panel Enclosure            |
| 2 — B11 Small Control Panel Enclosure             |
| 3 — Mounting clip locations for the control panel |

2. Snap the four plastic standoffs onto the four enclosure support posts. If you install a B12, attach the standoffs to the plate support posts. Do not attach the standoff screws.

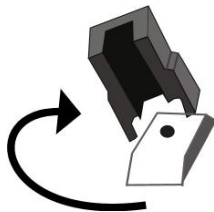

3. Position the control panel on top of the standoffs.
4. Align the holes in the corners of the control panel with the openings at the top of each standoff.
5. Attach and tighten the control panel to the standoffs with the supplied screws.

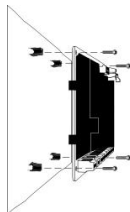

6. If you install a B12, rest the hook tabs on the mounting plate hooks within the enclosure. Secure the lock-down tab to the plate mounting hole with the screw provided.



### 3.2.1 Earth ground

To help prevent damage from electrostatic discharges or other transient electrical surges, connect the system to earth ground before making other connections. The earth ground icon identifies the earth ground terminal. Recommended earth ground references are a grounding rod or a cold water pipe. Make the connection using 14 AWG (1.8 mm) to 16 AWG (1.5 mm) wire.

### 3.2.2 OUTPUT A jumper

OUTPUT A is a form C relay.

- ▶ Choose one of the following uses before you install and configure OUTPUT A:
- +12 VDC (AUX power)
- COM terminal (parallel to all COM terminals)
- Dry contact (no voltage, not common)

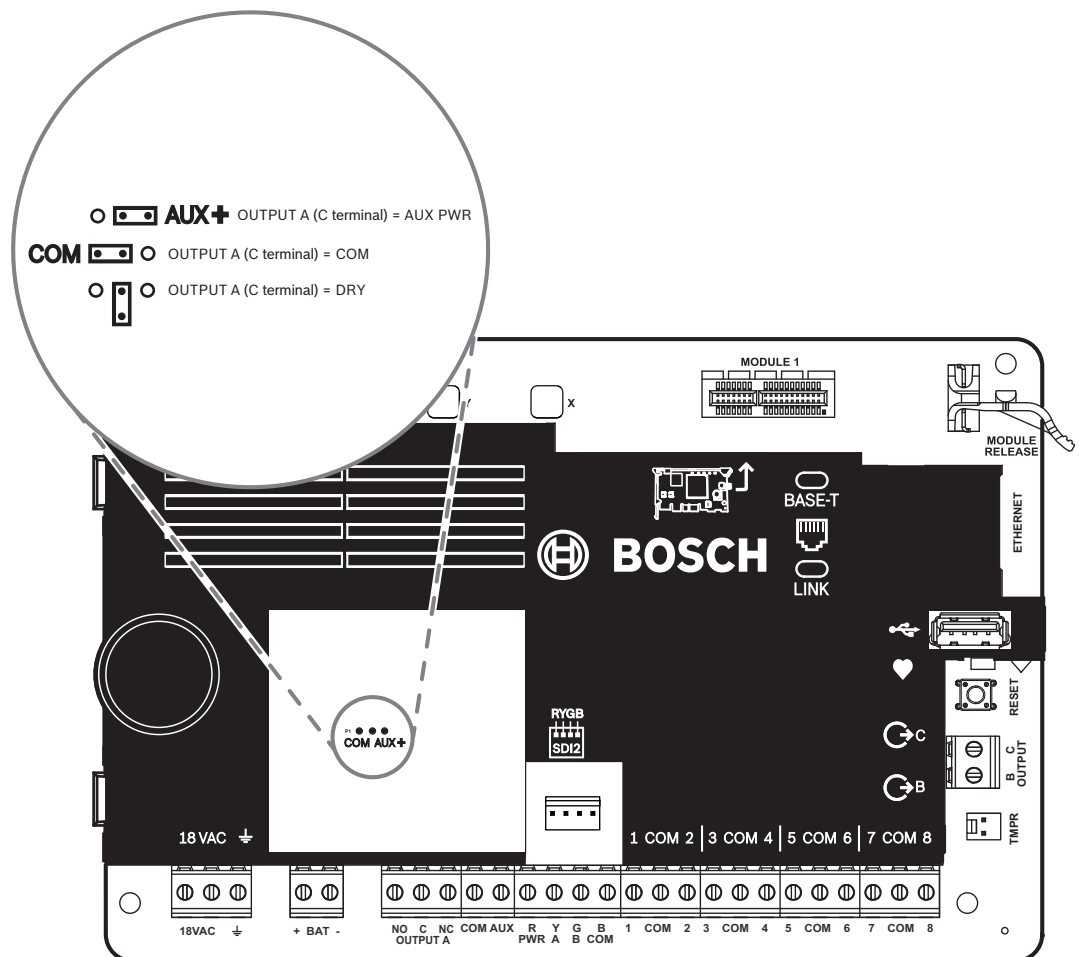

The control panel ships with the jumper in the default position, AUX power. (OUTPUT A, 'C' terminal providing AUX PWR).

- ▶ To reconfigure the 'C' terminal as a COM terminal (parallel to all COM terminals), remove the door covering the jumper pins, and move the jumper to the left two pins.
- ✓ The OUTPUT A LED lights when OUTPUT A is active.

## 3.3 Control panel to module wiring overview

You can use interconnect or terminal wiring to connect devices to the control panel.

### Using terminal wiring in parallel



**Notice!**

**Wire size**

For terminal wiring, use 18 AWG to 22 AWG (1.0 mm to 0.6 mm) wire.

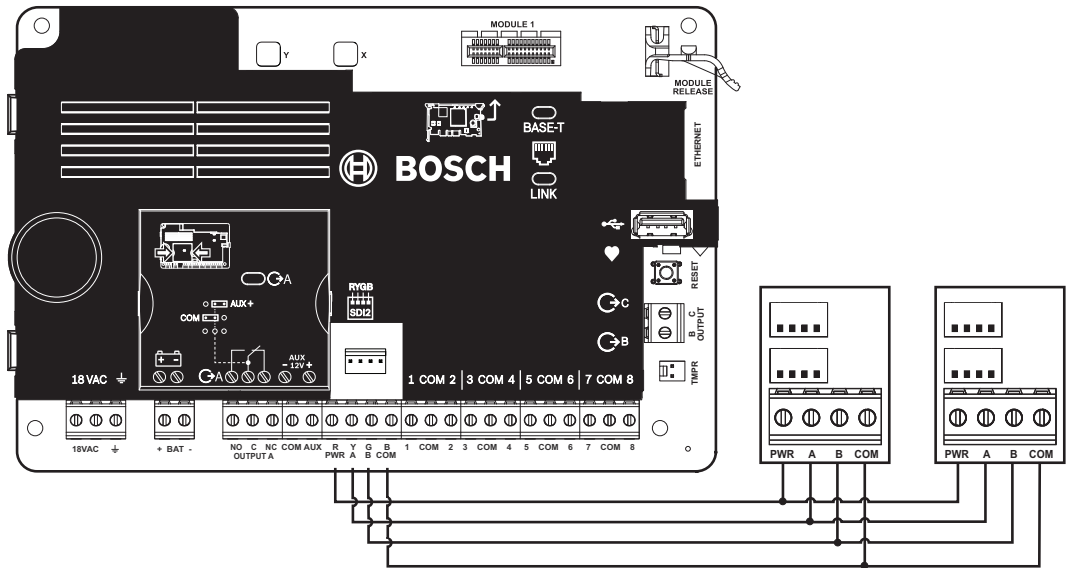

### Using interconnect wiring



**Notice!**

**More information**

For more information on interconnect wiring, refer to SDI2 interconnect wiring.

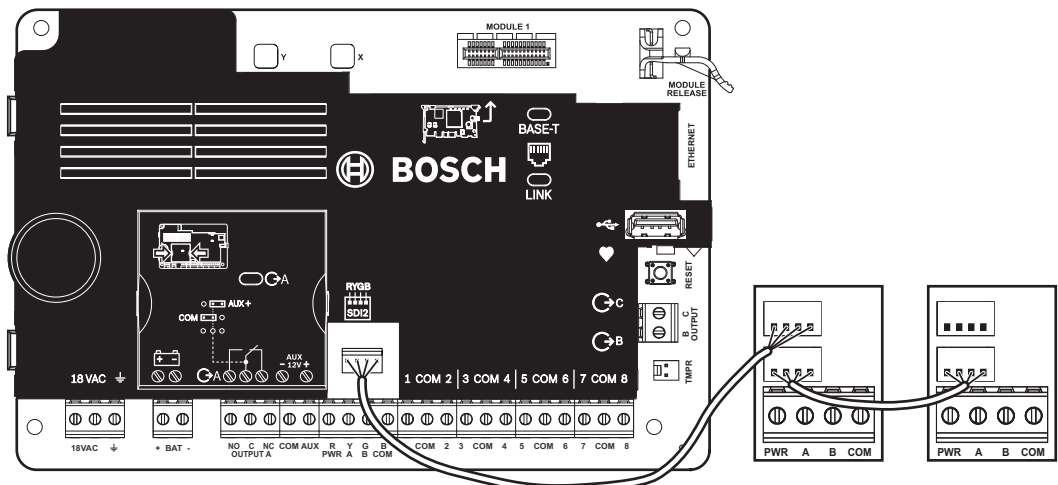

## 4 Power supply

This section provides information on installing and maintaining primary power, batteries, and auxiliary power.

### 4.1 Primary (AC) power

#### Surge protection

Transient suppressors and spark gaps protect the circuit from power surges. This protection relies on the ground connection at the earth ground terminal marked with the  $\perp$  icon. Ensure that you connect the terminal to a proper ground.

Refer to *Earth ground*, page 9.

#### AC power fail

The system indicates an AC power failure when the following terminals do not have sufficient voltage: transformer input: The AC Fail Time parameter sets the amount of time without AC power before the control panel reports the failure. It also sets the amount of time after the power returns before the control panel reports restored power.

#### Self diagnostics at power up and reset

The system performs a series of self-diagnostic tests of hardware, software, and programming at power up and at reset. The self-diagnostics tests complete in approximately 10 to 30 seconds.

If the control panel fails any test, a System Trouble message appears on the keypads.

### 4.2 Secondary (DC) power

#### + BAT -

A 12 V sealed lead-acid rechargeable battery (such as the D126/D1218) supplies secondary power to maintain system operation during interruptions of primary (AC) power.



#### Notice!

##### Use sealed lead acid batteries only

The charging circuit is calibrated for lead-acid batteries. Do not use gel-cell or NiCad batteries.

#### Extra batteries

To increase battery back-up time, connect a second 12 V battery in parallel to the first battery. Use a D122/D122L Dual Battery Harness to ensure proper and safe connection.

#### D1218 Battery

The D1218 is a 12 V, 18 Ah battery for use in applications requiring extended battery standby time. The control panel does not support more than 38 Ah of battery.

#### 4.2.1 Install the battery

1. Put the battery upright in the base of the enclosure.
2. Locate the red and black leads supplied in the hardware pack.
3. Connect the black battery lead to 4 .
4. Connect the other end to the negative (-) side of the battery.
5. Connect the red battery lead to 5.
6. Connect the other end to the positive (+) side of the battery.



**Warning!**

**High current arcs are possible**

The positive (red) battery lead and the terminal labeled 5 can create high current arcs if shorted to other terminals or the enclosure. Use caution when you touch the positive lead and the terminal labeled 5. Always disconnect the positive (red) lead from the battery before you remove it from the terminal labeled 5.



**Caution!**

**Battery terminals and wire are not power limited**

Maintain a 0.250 in (6.4 mm) space between the battery terminals, battery wiring, and all other wiring. Battery wiring cannot share the same conduit, conduit fittings, or conduit knockouts with other wiring.

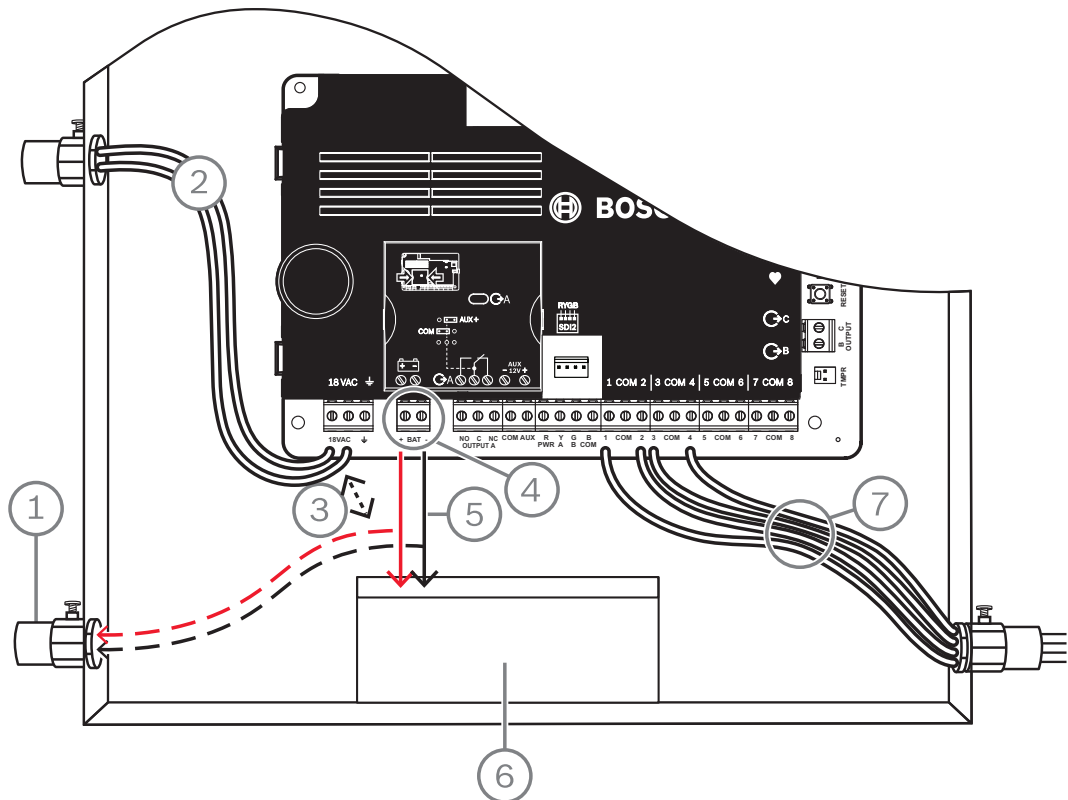

**Figure 4.1:** Non-power-limited wiring (B5512 shown)

Callout — Description
1 — Conduit required for use with external batteries
2 — To UL listed class 2 transformer 18 VAC 22 VA 60 Hz
3 — 0.25 in (6.4 mm) minimum
4 — Battery terminals. BAT+ is non-power limited
5 — Battery wires
6 — 12 V sealed lead-acid rechargeable battery (D126/D1218)
7 — Sensor loop wires

### Charging the battery

1. Connect the battery
2. Connect the transformer.
3. Allow the control panel to charge the battery while you complete the installation.

## 4.2.2

### Battery maintenance

Use 12 VDC sealed lead-acid rechargeable battery (7 Ah, 18 Ah, or 38 Ah). The control panel supports up to 38 Ah of battery. If you use two batteries, they must have the same capacity, and you use a D22/D122L to connect them.

Replace the batteries every 3 to 5 years. If you install two batteries, replace them both at the same time.

Record the date of installation directly on the battery.



### Caution!

#### Heavy discharges possible

The system can have heavy discharges if you exceed the maximum output ratings or install the transformer in an outlet that is routinely switched off. Routine heavy discharges can lead to premature battery failure.

## 4.2.3

### Battery supervision

The battery charging float level occurs at 13.65 VDC. If the battery voltage drops below 12.1 VDC, the control panel sends a LOW BATTERY report and shows keypad messages, if programmed to do so.

The control panel (if programmed for power supervision) sends a Battery Low report in the Conettix Modem4 format. It sends a Low System Battery (302) report in the Conettix ANSI-SIA Contact ID format.

When battery voltage returns to 13.4 V, the keypads stop showing the low battery messages. If the control panel is programmed for power supervision, it sends a BATTERY RESTORAL report in the Conettix Modem4 format or a Control Panel Battery Restored to Normal (302) report in the Conettix ANSI-SIA Contact ID format.

If programmed for power supervision, the control panel adds a missing battery event to the event log. If programmed for battery fault reports, the control panel sends a Battery Missing/Dead report in the Conettix Modem4 format, or Control Panel Battery Missing (311) report in the Conettix ANSI-SIA Contact ID format.

## 4.2.4

### Battery discharge and recharge schedule

#### Discharge cycle

- 13.65 VDC - Charging float level.
- 12.1 VDC - Low Battery Report, if programmed.
- 10.2 VDC - Minimum operational voltage.

#### Recharge cycle

- AC ON - Battery charging begins and AC Restoral Reports sent.
- 13.4 V - Battery Restoral Report sent. Battery float charged.

## 4.3

### B520 aux power supply

The optional B520 provides up to 2 A of 12 VDC standby power for Fire and Burglar applications. For Burglar applications, an additional 2 A of alarm power is available, allowing 2 A of standby current and up to 4 A of alarm current.

The control panels support the following number of B520 modules:

- B6512. 4

- B5512. 4
- B4512. 2
- B3512. 2

The power supply draws approximately 15 mA (+/- 1 mA) from the control panel. For detailed instructions, refer to the corresponding document listed in *Related documentation, page 4*.

### 4.3.1 SDI2 address settings



#### Notice!

The module reads the address switch setting only during module power up. If you change the setting after you apply power to the module, you must cycle the power to the module in order for the new setting to take effect.

If multiple B520 modules reside on the same system, each B520 module must have a unique address.

### 4.3.2 Supervision

The control panel supervises any B520 on the SDI2 bus.

With any failure to receive an expected response from a B520, all keypads show a system fault. The control panel sends a module trouble report to the central station (if configured for module trouble reports).

### 4.3.3 Auxiliary power supply trouble conditions

Each auxiliary power supply module on the SDI2 bus monitors several conditions including AC status, battery status, over current status, and a tamper input. Each of these conditions produces a unique system trouble condition at all keypads. The control panel sends a module trouble report to the central station (if configured for module trouble reports).

### 4.3.4 Installation and control panel wiring (B520)

#### Calculate power consumption

Make sure that there is enough power for the module and the other powered devices that you want to connect to the system.

Refer to *On-board outputs, page 19*.



#### Caution!

Remove all power (AC and battery) before making any connections. Failure to do so might result in personal injury and/or equipment damage.

#### Installing the module

1. Set the module address.
2. Insert the plastic mounting clips onto the standoff locations inside the enclosure or on a mounting skirt, when required.
3. Mount the module onto the plastic mounting clips.
4. Tighten the supplied mounting screws.

#### Wiring to earth ground

- ▶ To help prevent damage from electrostatic charges or other transient electrical surges, connect the system to earth ground before making other connections.

**Notice!****Earth ground reference**

Do not use telephone or electrical ground for the earth ground connection. Use 14 AWG (1.8 mm) to 16 AWG (1.5 mm) wire when making the connection

Use a grounding rod or a cold water pipe.

Run wire as close as possible to grounding device.

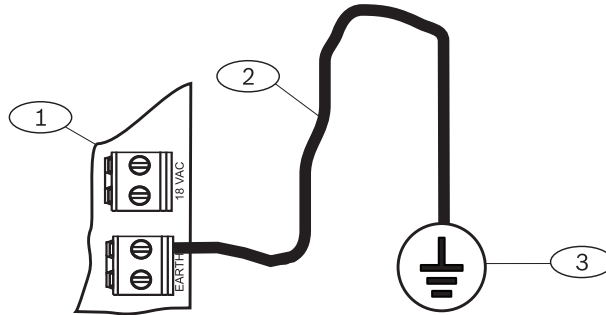
**Callout — Description**

1 — B520 Auxiliary Power Supply Module

2 — 14 AWG - 16 AWG (1.8 mm - 1.5 mm) wire

3 — Ground device (grounding rod or cold water pipe)

**Wiring to the control panel****Notice!****Terminal wiring**

Use the terminal strip labeled with PWR, A, B, and COM for SDI2 IN to wire to corresponding control panel SDI2 terminals. Do not use interconnect wiring.

Use 12 AWG to 22 AWG (2.0 mm to 0.6 mm) wire.

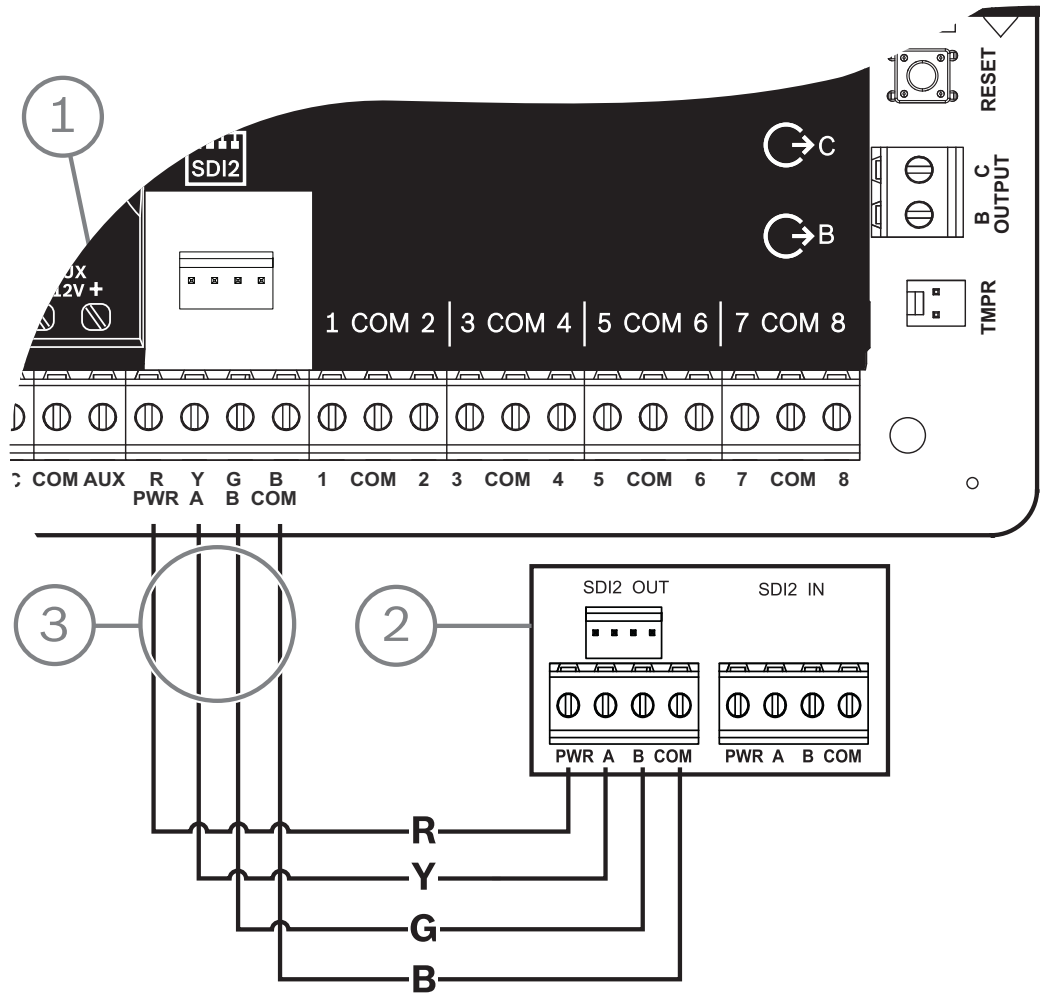

Callout — Description
1 — Control panel
2 — B520 Auxiliary Power Supply Module
3 — Terminal strip wiring

### 4.3.5 Powered device and battery wiring

When you wire the output of a B520 to a SDI2 module, the B520 provides power to the module while passing through data between the control panel and the module.



**Wiring SDI2 modules**

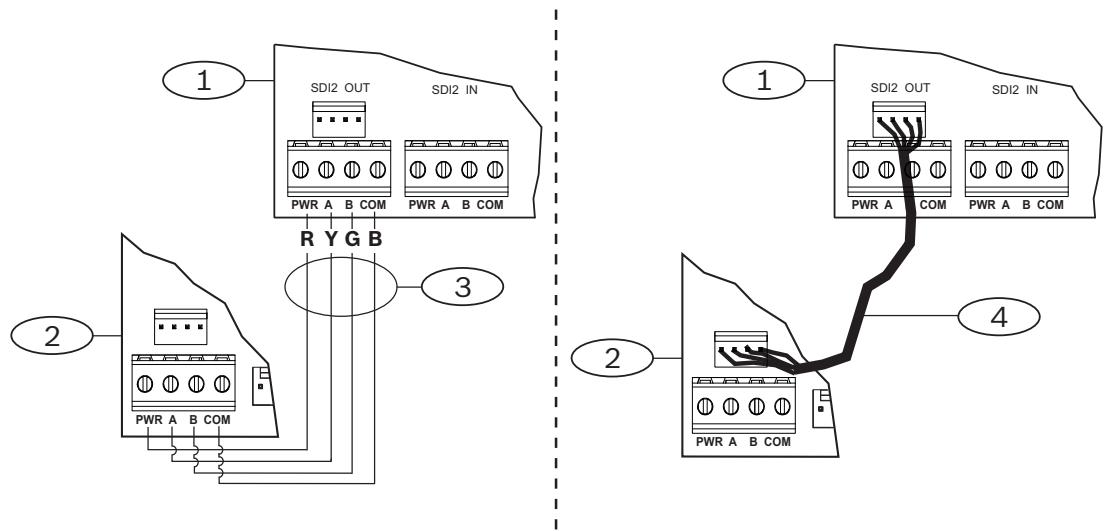

Callout — Description
1 — B520 Auxiliary Power Supply Module
2 — Powered device (SDI2 module)
3 — Terminal strip wiring
4 — Interconnect wiring (P/N: F01U079745)

- Do one of the following:  
Use terminal wiring to connect the SDI2 OUT terminal strip labeled with PWR, A, B, and COM on the B520 to the terminals labeled PWR, A, B, and COM on the first module.  
Connect an interconnect wiring cable (included) to the SDI2 OUT interconnect connector on the B520 to the interconnect connector on the first module.
- Connect additional modules in series with the first module.

**Wiring to batteries**



**Notice!**

**Battery wiring requirements**

You must wire BATT 1. You must wire BATT 2 if you configure the B520 for two batteries. When you use BATT 2, both batteries must have the same rating. Maximum standby power cannot exceed 36 Ah.

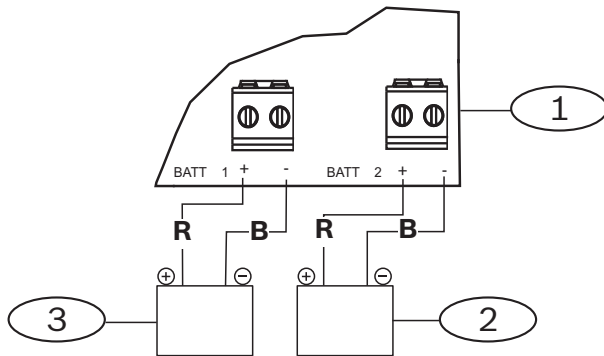

Callout — Description
-----------------------

1 — B520 Auxiliary Power Supply Module
2 — Battery 2 (BATT 2) - (12 V nominal lead acid)
3 — Battery 1 (BATT 1) - (12 V nominal lead acid)

## 5 On-board outputs

The control panel provides one configurable (power, common, dry) and two open collector on-board outputs.

### 5.1 Circuit protection

The powered outputs come with circuit protection.

Three self-resetting circuit breakers protect the control panel from short circuits on the continuous and programmable power outputs. Each breaker protects a separate terminal:

- AUX (auxiliary power) terminal.
- C terminal of OUTPUT A.
- PWR/R terminal (power) of the SDI2 terminal block.



#### Notice!

#### UL requirement

Supervise devices powered from a power output.

### 5.2 Total available power

The control panel produces up to 800 mA of combined power at 12.0 VDC nominal to power peripheral devices. The outputs listed below and OUTPUT A share the available power.

#### AUX terminal (auxiliary power)



Power devices requiring continuous power (for example, motion detectors).

#### R/PWR terminal and power output of the interconnect connector (SDI2 power)

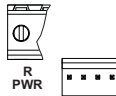

Power SDI2 devices such as keypads and octo-input modules.

#### Plug-in module connector

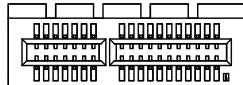

Connect plug-in modules such as the B444-A or B444-V.

#### OUTPUT A



Configure Output A as a dry contact (contact rating is 3 Amps), switched common (sink current), or a powered output. As a powered output, it can provide alarm power or switched auxiliary power. The default configuration for Output A makes it a powered output providing alarm power. Use OUTPUT PARAMETERS in RPS or in the Installer Services Portal programming tool (available in Europe, Middle East, Africa, and China) to configure programmable outputs.

### 5.3 Open collector outputs

#### OUTPUT B and C



Outputs B and C are open collector outputs that can sink up to 50 mA of power (+12 VDC), when activated.

As an example, the figure below shows using Outputs B and C to trigger the relays of a D134.

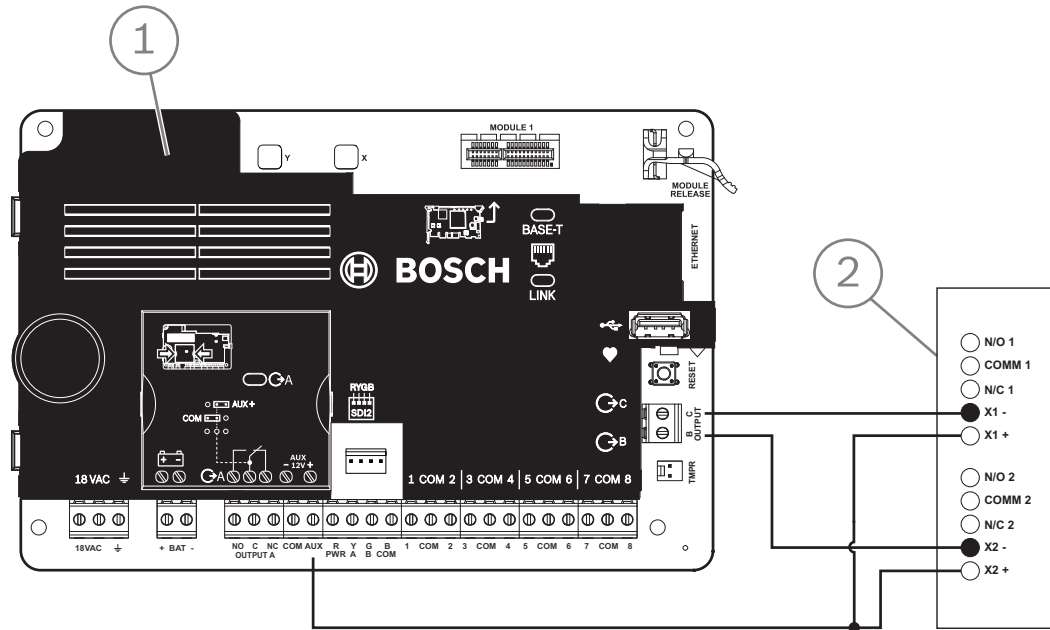
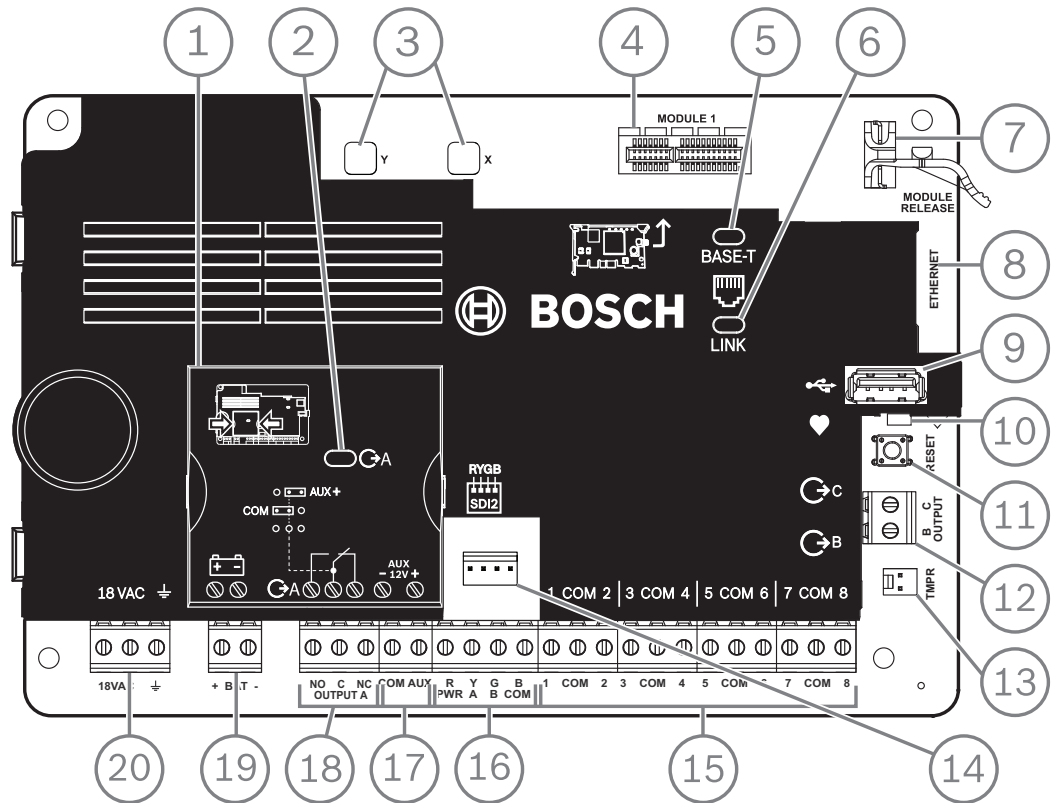

Figure 5.1: OUTPUT B and C wiring (B5512 shown)

Callout — Description
1 — Control panel
2 — D134 Dual Relay Module

- ▶ Use OUTPUT PARAMETERS in RPS or in Installer Services Portal programming tool (available in Europe, Middle East, Africa, and China) to configure programmable outputs.

## 6 Control panel board overview



Callout — Description	Callout — Description
1 — Jumper cover. Remove to configure Output A	11 — RESET button
2 — OUTPUT A LED	12 — Terminals for Output B and Output C
3 — Holes to stabilize plug-on modules	13 — Tamper switch connector
4 — Plug-in module connector	14 — SDI2 interconnect wiring connector
5 — Green 100Mb LED	15 — Sensor loop terminals for points 1 to 8
6 — Yellow LINK LED	16 — SDI2 terminals (power and data)
7 — Plug-in module retention clip	17 — Auxiliary power terminals
8 — On-board Ethernet connector (optional)	18 — Terminals for Output A
9 — USB connector	19 — Battery terminals
10 — Heartbeat LED (blue)	20 — 18 VAC power input terminals

# 7 System wiring diagrams

## 7.1 System wiring overview

**Notice!**

**UL Certificated accounts**



Additional power can be obtained using only a UL Listed auxiliary 12.0 VDC regulated, power-limited power supply, such as the B520.

All terminals are power limited except BAT+ (battery positive).

All terminals are supervised except OUTPUT A, OUTPUT B, and OUTPUT C.

For proper supervision, do not loop wire under terminals. Break the wire run to provide supervision of connections.

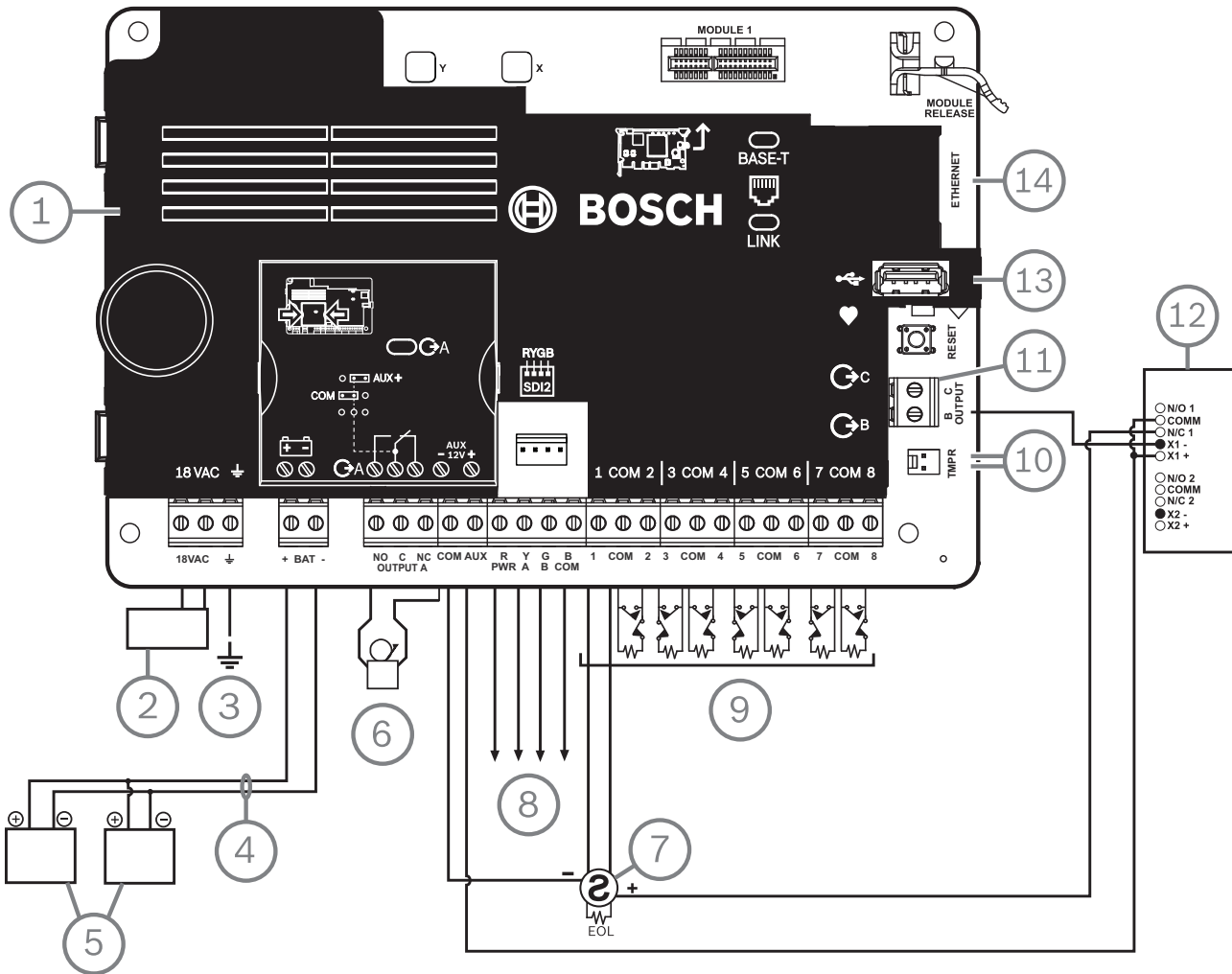

Callout — Description	Callout — Description
1 — Control panel	8 — SDI2 wiring
2 — UL listed class 2 transformer 18 VAC 22 VA 60 Hz (Canada: an ICP-TR1822-CA Plug-in Transformer 120 VAC primary, 18 VAC 22 VA secondary)	9 — Supervised sensor loops, points 1 to 8 (Initiating Device Circuits)
3 — To earth ground	10 — To ICP-EZTS Tamper Switch

Callout — Description	Callout — Description
4 — D122/D122L, as required	11 — Programmable outputs
5 — Batteries (unsupervised)	12 — External relay
6 — Audible signaling device	13 — USB connector
7 — UL Listed four-wire smoke detectors with EOL resistor	14 — RJ-45 modular jack for Ethernet (optional)

## 7.2 Battery lead supervision wiring

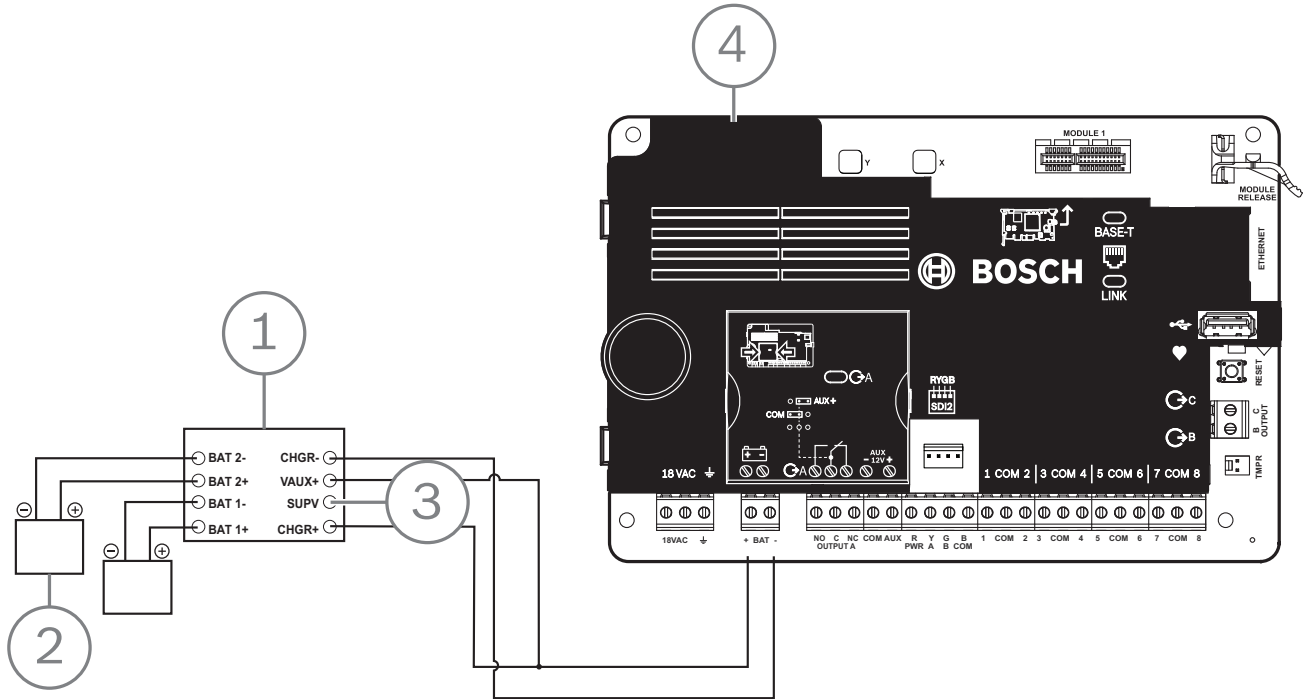

Callout — Description
1 — D113 Supervision module, battery lead, if required
2 — Batteries
3 — To supervision point
4 — Control panel

### 7.3 2-wire smoke wiring (B201)

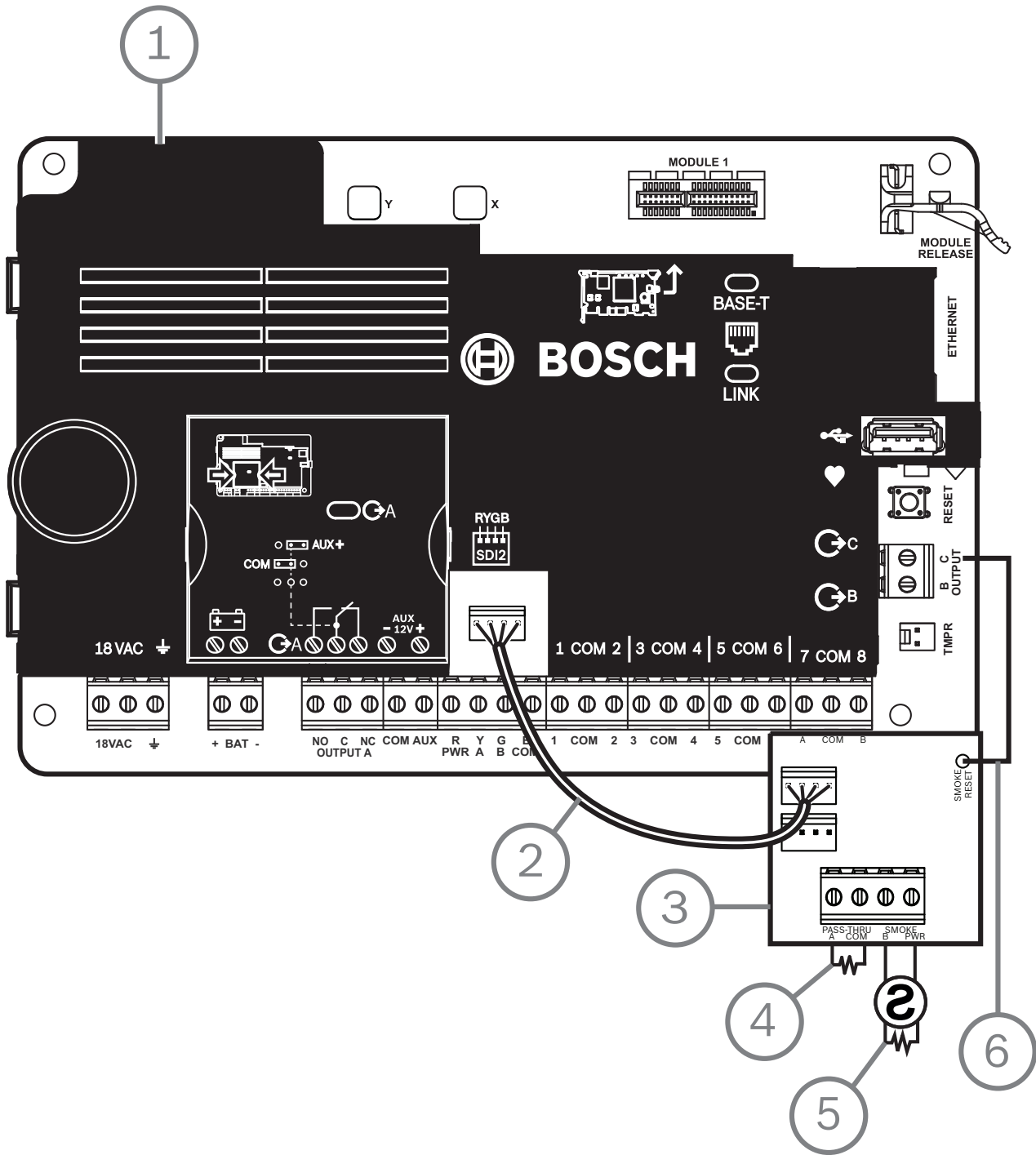

Callout — Description
1 — Control panel
2 — Interconnect wiring cable
3 — B201
4 — EOL resistor



Callout — Description
5 — 1.8 kΩ EOL resistor (P/N: F01U009011) (included with the module)
6 — Smoke reset wire

## 7.4 2-wire smoke wiring (D125B)

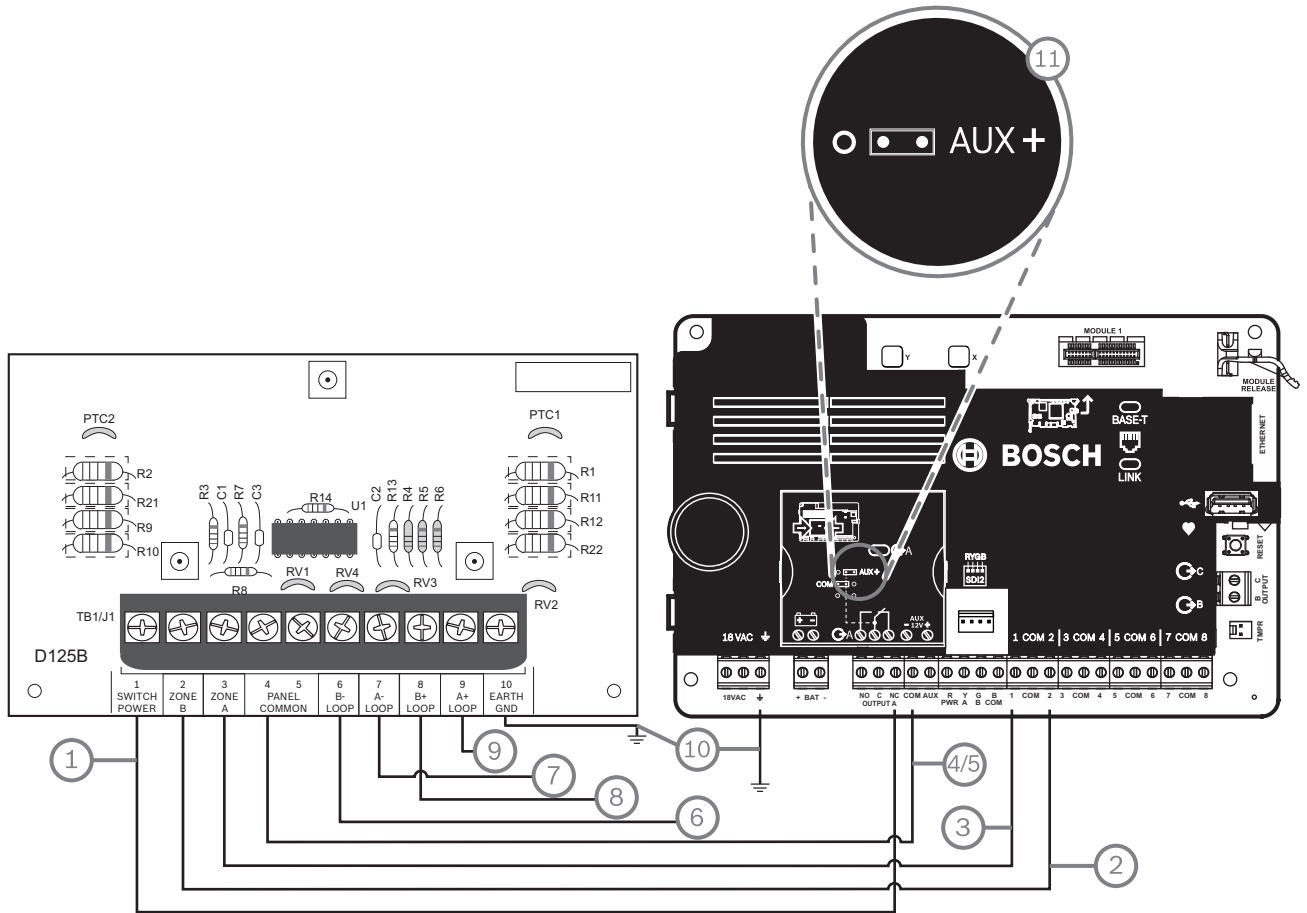

Callout — Description	Callout — Description
1 — Switched auxiliary power from Output A (NC) <sup>1</sup> of the control panel	7 — Supervised smoke detector to A LOOP negative
2 — Connection from an on-board point on the control panel to Zone B	8 — Supervised smoke detector to B LOOP positive
3 — Connection from an on-board point on the control panel to Zone A	9 — Supervised smoke detector to A LOOP positive
4/5 — Connection to common on the control panel (one connection only)	10 — Earth ground
6 — Supervised smoke detector to B LOOP negative	11 — Output A jumper (under cover) set to AUX PWR

<sup>1</sup> You can also use Output B or C in conjunction with a D133 or D134 relay module.

## 7.5 Input point wiring, dual EOL resistor circuit style



**Notice!**

**EOL resistors**

For the dual EOL resistor circuit style order ICP-1K22AWG-10, package of 10 1.0 kΩ EOL resistors.

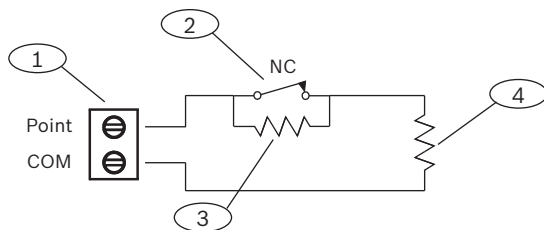

Callout - Description
1 - Point sensor loop terminals
2 - Normally closed device (contact)
3 - 1.0 kΩ resistor at device
4 - 1.0 kΩ resistor at EOL (end-of-line)

## 7.6 Notification appliance circuit wiring

The control panel does not have an on-board NAC. For systems requiring a NAC, use a D192G.



**Notice!**

**UL requirement**

For UL Listed fire alarm applications, install a D192G.

For detailed instructions, refer to the corresponding document listed in *Related documentation, page 4*.

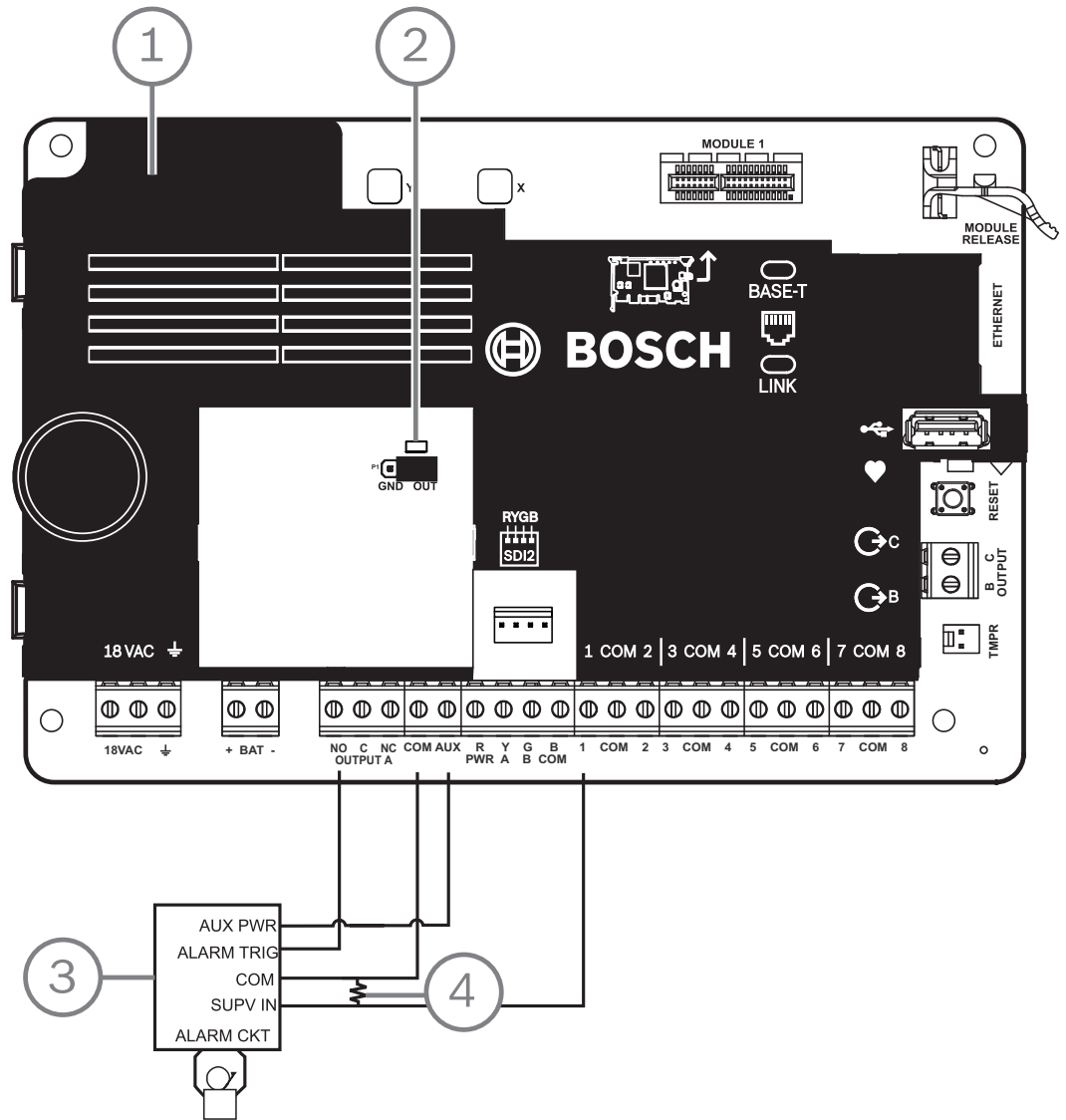

Callout — Description
1 — Control panel
2 — Output jumper set to configure OUTPUT A terminal C for AUX POWER (jumper cover removed)
3 — D192G
4 — 1k Ω EOL resistor (P/N: F01U033966)

## 7.7 Keyswitch wiring

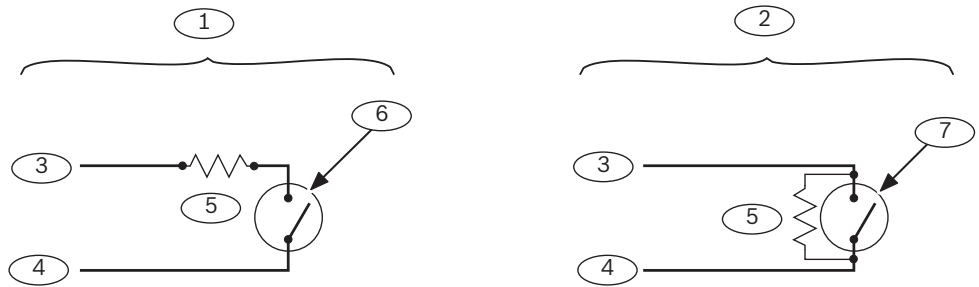

Callout — Description	Callout — Description
1 — Maintained keyswitch	5 — EOL (End of Line) resistor
2 — Momentary keyswitch	6 — Open on the circuit arms the area
3 — Common	7 — Momentary short on the circuit toggles the arming state
4 — Point input	



**Notice!**

**UL requirement**

Keyswitches are not intended for use in UL listed systems.

## 7.8 SDI2 devices general system wiring

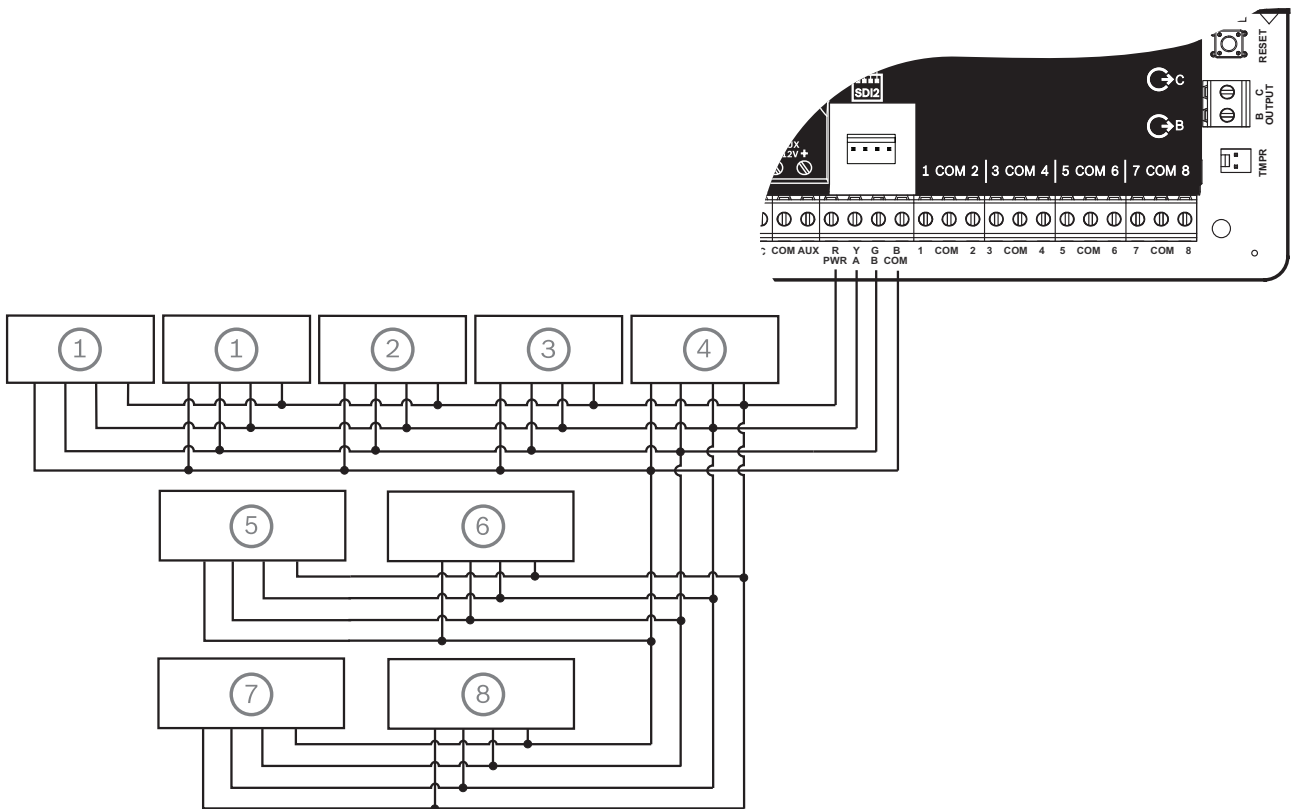

Callout — Description	B6512 capacity	B5512 capacity	B4512 capacity	B3512 capacity
1 — B208	9	4	2	0
2 — B308	9	5	3	0
3 — B426	1	1	1	1
4 — B450	1	1	1	1
5 — B520	4	4	2	2
6 — B810 or B820	1	1	1	1
7 — Compatible keypads	12	8	8	4
8 — B901	4	0	0	0

**Notice!**

The SDI2 power terminal (R/PWR) is power limited. The SDI2 terminals are supervised.

**7.8.1****SDI2 bus wiring recommendations**

Use the following SDI2 bus wiring recommendations for SDI2 installation. The control panel and SDI2 modules use the SDI2 bus to communicate with one another.

You can wire modules via home run, daisy chain, or single level T-tap anywhere on the SDI2 bus.

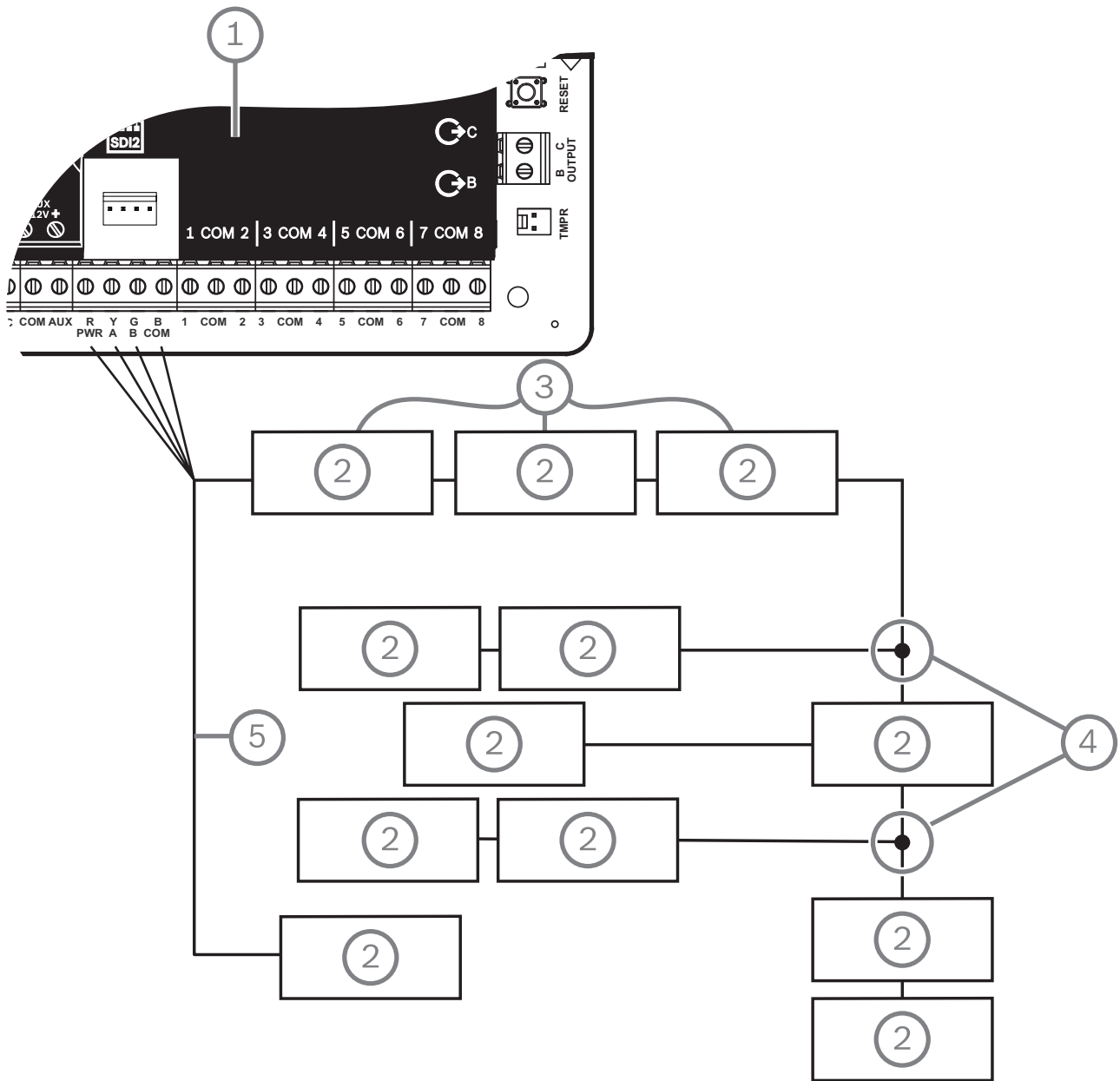

**Figure 7.1:** SDI2 bus wiring recommendations (B5512 shown)

Callout — Description
1 — Control panel
2 — SDI2 device (module or keypad)
3 — Daisy chain wiring
4 — Single-level T-tapped wiring
5 — Home run wiring

**Notice!**

There can only be a difference of 2 volts (maximum) between the AUX power terminals of the control panel or power supply and the device for the modules and keypads to work properly under all conditions.

**Maximum cable lengths**

Follow these rules when wiring the SDI2 bus:

- The SDI2 bus requires the use of **unshielded** cable from 12 AWG to 22 AWG (0.65 mm to 2 mm).
- Refer to the SDI2 device or keypad documentation for the allowable maximum distance from the control panel.
- Maximum overall cable lengths are listed in the following table:

Cable capacitance	Overall cable length		Cable capacitance	Overall cable length	
	ft	m		ft	m
< 17	7500	2286	27	5185	1580
18	7500	2286	28	5000	1524
19	7350	2240	29	4828	1472
20	7000	2134	30	4700	1433
21	6666	2032	31	4516	1376
22	6363	1939	32	4400	1341
23	6086	1855	33	4242	1293
24	5800	1768	34	4100	1250
25	5600	1707	35	4000	1219
26	5385	1641	36	3800	1158

**Table 7.1: Maximum cable length**

**Notice!**

Use unshielded cable only.

Maximum capacitance of 140nF (140,000 pF) per system. Contact the wire manufacturer for the capacitance ratings of the wire being used.

## 7.9 Wiring label

# BOSCH

## B6512/B5512/B4512/B3512

This equipment should be installed in accordance with the NFPA 70 (National Electrical Code), the NFPA 72 (National Fire Alarm Code), and the local authority having jurisdiction. Depending on the application, the installation is to be in accordance with one or more of the following UL standards: UL681 Installation and Classification of Mercantile and Bank Burglar Alarm Systems; UL1076 Proprietary Burglar Alarm Systems and Units; UL1641 Installation and Classification of Residential Burglar Alarm Systems. Printed information describing proper installation, operation, testing, maintenance, repair service and response to an alarm is to be provided with this equipment. Warning: Owner's Instruction Notice (P/N: F01U287181): Not to be removed by anyone except occupant. Avertissement : guide de l'utilisateur (ref. : F01U287181) : seul l'occupant est autorisé à le retirer.

Bosch Security Systems, Inc. recommends testing the entire system at least once a week, and having a qualified technician check the system at a minimum of once every 3 years.

Minimum system requirements for Classification in accordance with ANSI/SIA CP-01-2010  
 UL Listed and Classified control unit Model B5512, B4512 or B3512;  
 UL Listed and Classified keypad Model B915/B915i, B920, B921C, B930, B940W, B942, or B942W  
 UL Listed Local Bell

Suitable for the following applications: 1) Household Burglar Alarm System Units, 2) Household Fire Warning System Units, 3) Police Station connect, Mercantile Premise alarm system, Mercantile Safe and Vault alarm system. For all Police Station applications, Model D8108A Attack Resistant Enclosure with a UL Listed local sounding device is required. 4) Local, Mercantile Premise alarm system and Mercantile Safe and Vault alarm system. 5) Central Station, suitable as a dual signal line transmission system. 6) Proprietary Burg. 7) Holdup Alarm Units and System.

This equipment has been type tested and found to comply with the specifications in Part 15 of FCC rules for Class B Computing Devices. Operation is subject to the two following conditions (1) this device may not cause any interference, and (2) this device must accept any interference received including interference that may cause undesired operation.

**POWER SUPPLY REQUIREMENTS**  
 The Power Supply provides a maximum of 800 mA for the Control Panel and all Accessory Devices.  
 All external connections are inherently power limited, Class 2.  
 Requirements for battery standby time might reduce allowable output.

Model number B430 complies with Part 68, FCC Rules, FCC Registration Number: ESVAL00BB430 Ringer Eq 0.0B  
 Model number B430 complies with CS-03, IC Rules, IC: 1249A-B430 REN 0.0

For ULC installations, refer to the ULC Installation Guide (P/N: F01U321698 for en and for fr).

Incorrect wiring might damage this equipment.

Do not connect to a receptacle controlled by a switch. Do not share with other equipment.

B6512/B5512/B4512/B3512 use a CX4010 UL Listed Class 2 Transformer 18 VAC 22 VA 60 HZ, or in Canada, an ICP-TR1822-CAN Plug-in Transformer 120 VAC primary, 18 VAC 22 VA secondary.

**CAUTION! AVERTISSEMENT!**  
 Avoid damage to Panel. Do not connect 24 V to terminals. Pout éviter d'endommager la centrale : Ne pas raccorder l'alimentation électrique de volts aux bornes.

Maximum charging current is 1 A auxiliary power at 12 VDC. BATTERY: Replace every 3 to 5 years with one or two D126 or one D1218 12 V Lead Acid Batteries for Burglary or Combination Fire and Burglary Systems.

**WARNING! ATTENTION!**  
 Multi-Battery installation requires Model D122 or D122L Dual Battery Harness. Improper installation can be a fire hazard. Le installations à plusieurs batteries nécessitent un faisceau de câbles de Batterie double de modèle D122 ou D122L. Toute installation inadéquate peut causer un risque d'incendie.

For UL Listed fire alarm applications, use a D192G Notification Appliance Circuit module.

**Supervised Loops**

Open 3.7 to 5.0 VDC  
 Normal 2.0 to 3.0 VDC  
 Short 0.0 to 1.3 VDC  
 With 1 kΩ EOL Resistor (P/N: 15093130-004). For other EOL options, refer to the UL Installation Guide (P/N: F01U287185).  
 Typical Initiating Devices are Door Contacts NO/NC, Floor Mats, Motion Detectors, Glass Break Detectors, etc.

An EOL power supervision module might be required for use with 4-wire smoke detectors.

For a list of 2-wire smoke detectors compatible with the B201 Installation Guide (P/N: F01U296412).

For a list of 2-wire smoke detectors compatible with the D125B Dual Class B Initiating Module, refer to the D125B Installation Instructions (P/N: F01U036340).

**WARNING**  
 THIS UNIT INCLUDES AN ALARM VERIFICATION FEATURE THAT WILL RESULT IN A DELAY OF THE SYSTEM ALARM SIGNAL FROM THE INDICATED CIRCUITS. THE TOTAL DELAY (CONTROL PANEL PLUS SMOKE DETECTORS) SHALL NOT EXCEED 60 SECONDS. NO OTHER SMOKE DETECTOR SHALL BE CONNECTED TO THESE CIRCUITS UNLESS APPROVED BY THE LOCAL AUTHORITY HAVING JURISDICTION.

**ATTENTION!**  
 CETTE UNITÉ COMPREND UNE FONCTIONNALITÉ DE VÉRIFICATION DES ALARMES QUI CONDUIT À UN RETARD DU SIGNAL D'ALARME DU SYSTÈME PROVENANT DES CIRCUITS INDIQUÉS. LA RETARD TOTAL (CENTRALE + DÉTECTEURS DE FUMÉE) NE DOIT PAS DÉPASSER 60 SECONDES. NE CONNECTER AUCUN AUTRE DÉTECTEUR DE FUMÉE À CES CIRCUITS, SAUF SI CELA EST PERMIS PAR LES RÉGLEMENTATIONS LOCALES EN VIGUEUR

* Circuit (point)	Control panel delay, seconds	Smoke detector	
		Model	Delay, seconds

Include detector data or the following or equivalent statement: "Use the delay (power-up/start-up) time marked on the installation wiring diagram of the smoke detector or on the installed smoke detector(s)."

Auxiliary Powered Devices 11.5 to 12.4 VDC. Below 10.2 VDC, the B6512/B5512/B4512/B3512 stops processing Loop inputs.

This equipment should be installed in accordance with the CSA C22.1, Canadian Electrical Code, Part 1, Safety Standard for Electrical Installations.

B6512\_B5512\_B4512\_B3512\_ULLD-05

Communication:  
 Standard Line Security: Cellular or IP  
 A4: Cellular or IP  
 P3: DACT

F01U287186-09A



## 8 Specifications

### Control panel power supply specifications

Voltage input (power supply)	Primary	18 VAC terminals	18 VAC 22 VA class 2 transformer
	Secondary	BAT terminals	12 Volt Sealed Lead Acid Rechargeable Battery (D126 or D1218)
Current requirements	Control Panel: Idle 125 mA; Alarm 155 mA Refer to the Standby battery requirements and calculations section in the control panel Installation and System Reference Guide for the current draw requirements of other system components.		
Power outputs	All external connections are power-limited. The battery terminals are not power limited.		
	SDI2 terminals and interconnect connector	PWR/R and COM/B terminals	800 mA for continuously powered devices. Shared with AUX power terminal.
	Alarm power output	OUTPUT A terminal	1.3 A for Burglary applications. Output can be steady or one of four pulsed patterns depending on programming. Refer to Outputs in RPS Help, in the Installer Services Portal programming tool (available in Europe, Middle East, Africa, and China) Help, or in the control panel Program Entry Guide.
	Aux power	AUX and COM terminals	800 mA for continuously powered devices. Shared with SDI2 R/PWR terminal and interconnect connector.
	Fire and Fire/Burglary Systems	Alarm power output for OUTPUT A cannot exceed 500 mA.	
Minimum operating voltage	10.2 VDC (The control panel might operate below this voltage, but it will cease to operate as an alarm panel.)		
SDI2 bus	12 VDC nominal (7500 ft combined length) maximum		
Ethernet connection (optional)	10BASE-T 100BASE-TX		
Battery discharge/recharge schedule	Discharge cycle	13.65 VDC - Charging float level. 12.1 VDC - Low Battery Report, if programmed. 10.2 VDC - Minimum operational voltage.	
	Recharge Cycle	AC ON - Battery charging begins and AC Restoral Reports sent. 13.4 V - Battery Restoral Report sent. Battery float charged.	
Environmental	Temperature	0°C to +49°C (+32°F to 122°F)	
	Relative Humidity	5% to 93% at +32°C (+90°F) non-condensing	
Arming stations	B940W, B942/B942W, B930, B921C, B920, B915/B915I, Keyswitch		

Point thresholds (Single EOL resistor circuit style) On-board points 1 to 8	With 1 kΩ resistors	Open - 3.7 to 5.0 VDC Normal - 2.0 to 3.0 VDC Short - 0.0 to 1.3 VDC Short circuit current - 5 mA
	With 2 kΩ resistors	Open - 4.1 to 5.0 VDC Normal - 3.0 to 4.1 VDC Short - 0.0 to 3.0 VDC Short circuit current - 5 mA
	No EOL	Open - 2.6 to 5.0 VDC Short - 0.0 to 2.4 VDC Short circuit current - 5 mA
Point thresholds (Dual EOL on-board points)	Dual EOL (1 kΩ + 1 kΩ)	Short - 0 to 1.67 VDC Open - 4.12 to 4.95 VDC Normal - 1.69 to 2.94 VDC Fault - 2.95 to 4.10 VDC Short circuit current - 5 mA
Compatible enclosures	B10 Medium Control Panel Enclosure, B11 Small Control Panel Enclosure, D2203 Enclosure, D8103 Universal Enclosure, D8108A Attack Resistant Enclosure, D8109 Fire Enclosure	

## 8.1 Wire requirements

Terminal label	Terminal description	Requirements
18VAC	AC	18 AWG to 12 AWG (1.02 mm to 2 mm)
⊕	Earth ground	16 AWG to 14 AWG (1.5 mm to 1.8 mm)
BAT +	Battery +	Bosch supplied wire lead, included with control panel..
BAT -	Battery -	
OUTPUT A NO	Output A normally open	22 AWG to 12 AWG (0.65 mm to 2 mm)
OUTPUT A C	Output A common	
OUTPUT A NC	Output A normally closed	
COM	Common	
AUX	+ AUX power	
PWR/R	SDI2 power	
A/Y	SDI2 data bus A	
B/G	SDI2 data bus B	
COM/B	SDI2 common	
1	Point 1	
COM	Point 1/2 common	
2	Point 2	
3	Point 3	

COM	Point 3/4 common
4	Point 4
5	Point 5
COM	Point 5/6 common
6	Point 6
7	Point 7
COM	Point 7/8 common
8	Point 8
OUTPUT B	Output B
OUTPUT C	Output C







**Bosch Security Systems B.V.**

Torenallee 49  
5617 BA Eindhoven  
Netherlands

**[www.boschsecurity.com](http://www.boschsecurity.com)**

© Bosch Security Systems B.V., 2020

## 2 | Specifications

Dimensions	37 cm x 32 cm x 8.9 cm (14.5 in x 12.5 in x 3.5 in)
Color	White
Compatible Lockset (optional)	D101 Lock and Key Set
Compatible Tamper Switch (optional)	ICP-EZTS Tamper Switch D110 Tamper Switch
Material	1.0 mm (20 gauge) cold-rolled steel

DE-de: Für Dokumentation in Ihrer Sprache, klicken Sie hier <https://de.boschsecurity.com/de>  
El-gr: Μεταβείτε στη διεύθυνση <https://gr.boschsecurity.com/el/> για την τεκμηρίωση σε αυτήν τη γλώσσα.  
Es-es: Visite <https://es.boschsecurity.com/es/> para obtener documentación en este idioma.  
Fr-fr: Accédez à l'adresse <https://fr.boschsecurity.com/fr/> pour obtenir la documentation dans cette langue.  
Hu-hu: A honosított dokumentációt lásd a <https://hu.boschsecurity.com/hu/> oldalon.  
It-it: Andare a <https://it.boschsecurity.com/it/> per la documentazione in questa lingua.  
Nl-nl: Voor de documentatie in uw taal, ga naar <https://www.boschsecurity.com/nl/nl>  
Pl-pl: Dokumentacja w tym języku znajduje się w witrynie <https://pl.boschsecurity.com/pl/>  
Pt-br: Acesse <http://pt.boschsecurity.com/pt/> para obter a documentação neste idioma.  
SE-sv: For documentation in this language, go to <https://www.boschsecurity.com/xn/en/>

### Reading Bosch Security Systems, Inc. Product Date Codes

For Product Date Code information, refer to the Bosch Security Systems, Inc. Web site at: <http://www.boschsecurity.com/datecodes/>.



## Medium Control Panel Enclosure B10



en Installation Guide



# 1 | Overview

This enclosure is compatible with select Bosch intrusion products, and can hold up to two batteries.

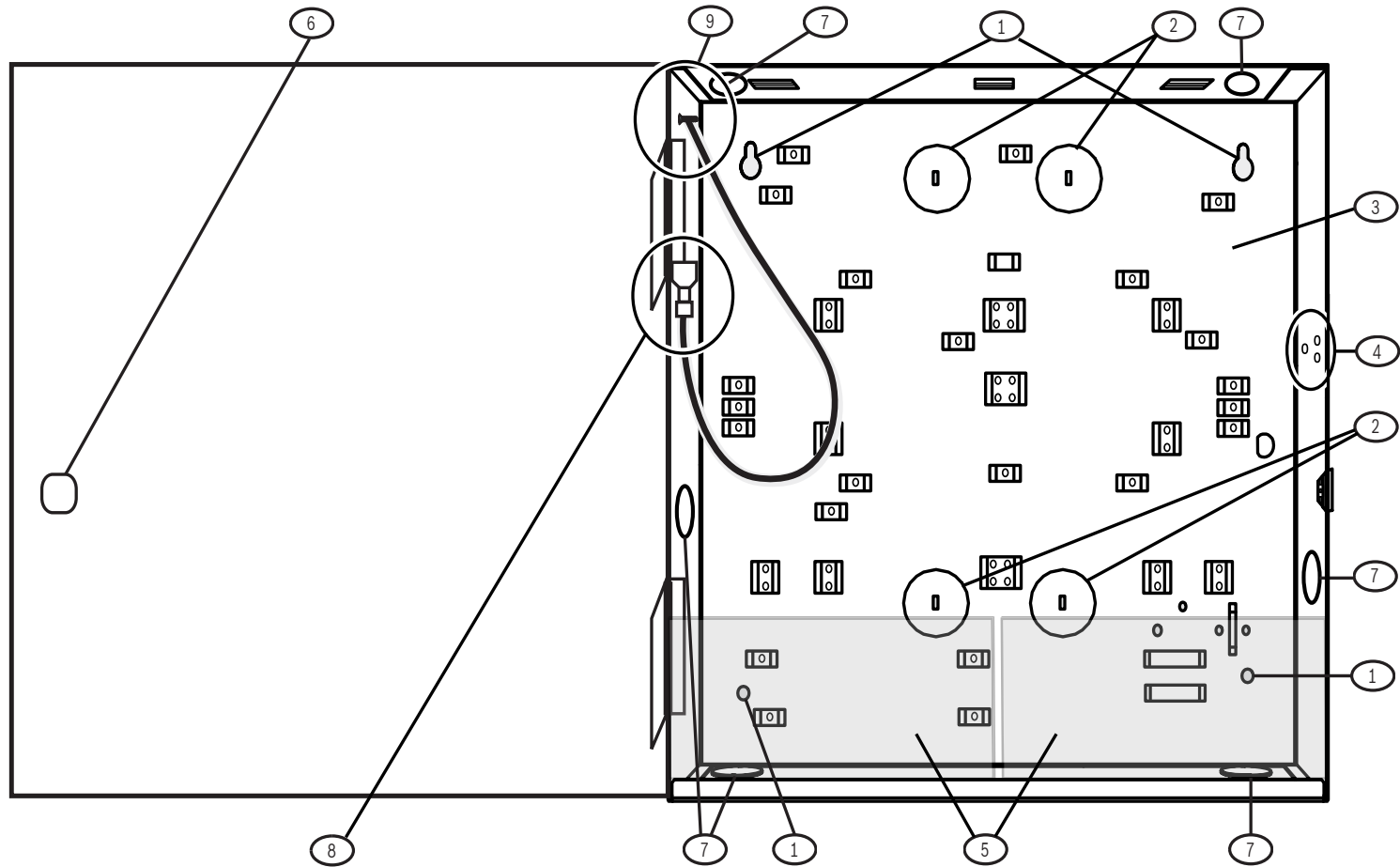

Callout	Description
1	Enclosure mounting holes (4). Bosch recommends using #10 screws and wall anchors to install.
2	Wire knockouts (4)
3	Control panel mounting location
4	Tamper switch mounting location
5	Battery mounting location (up to 2 - 7Ah batteries)
6	Lockset mounting location
7	Conduit knockouts (6) 4 - 12.7mm (1/2in), 2 - 19.05mm (3/4 in)
8	Grounding (bonding) connection to enclosure door
9	Grounding (bonding) connection for door only. Do not connect any other wires to this lug.