

B Series Control Panel

Installer Quick Start Guide



Use this guide to quickly install a Bosch B6512/B5512/B4512/B3512 security system. Additional information is found in the Control Panels Installation Manual.

 When you see this icon, use your smart phone with a QR code reader app to view helpful videos.

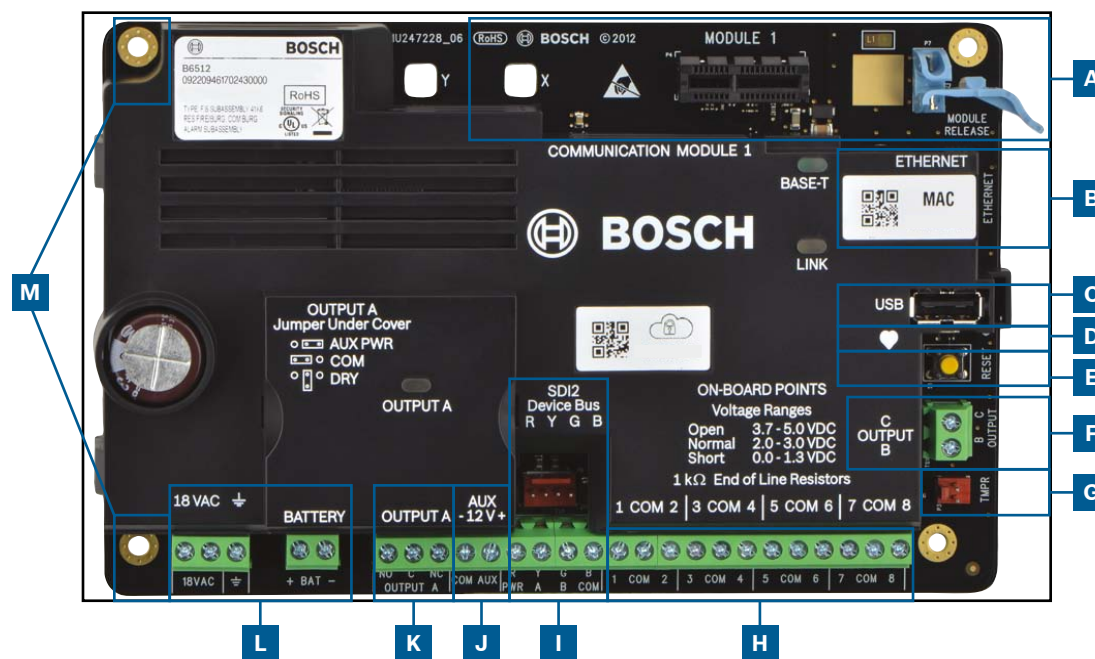
Control panel component layout



Control panel connection location

Location	Item	Description	Specification
A	MODULE 1	Plug-in comm module	Communication module options
B	ETHERNET	Ethernet port	built-in on-board Ethernet connection (10Base-T/100Base-T)
C	USB	USB port	USB connector (for firmware updates and RPS connection)
D		Heartbeat LED	Slow=normal, rapid=service mode
E	Reset	Reset switch	Hold five seconds to enter or exit service mode
F	B C	Outputs B(2) C(3)	Open collector, 50mA, active low
G	TMPR	Tamper	Optional tamper switch connector (ICP-EZTS)
H	1 COM 2 to 7 COM 8	Alarm inputs	End Of Line (EOL) resistor supervised alarm inputs
I	R Y G B	SDI2 bus	SDI2 device bus
J	COM AUX	Aux power	12 VDC, 800mA
K	NO C NC	Output A(1)	Programmable relay output
L	+ BAT - 18 VAC, 	Battery, Earth ground, 18 VAC	Primary/Secondary power and Earth Ground connections
M	Mounting	Mounting holes	Mounting holes for control panel

For additional training:

Bosch YouTube channel:

1. Scan QR code.
2. Scroll down.
3. Locate and select your region for additional videos.

B Series Installer's Site:



Installation sequence:

Scan and follow these videos in sequential order to the steps listed below.



Step 1 Mounting the control panel M

Bosch tips:

- ▶ Mount the enclosure prior to mounting the control panel.
- ▶ Mount control panel into enclosure with hardware provided.

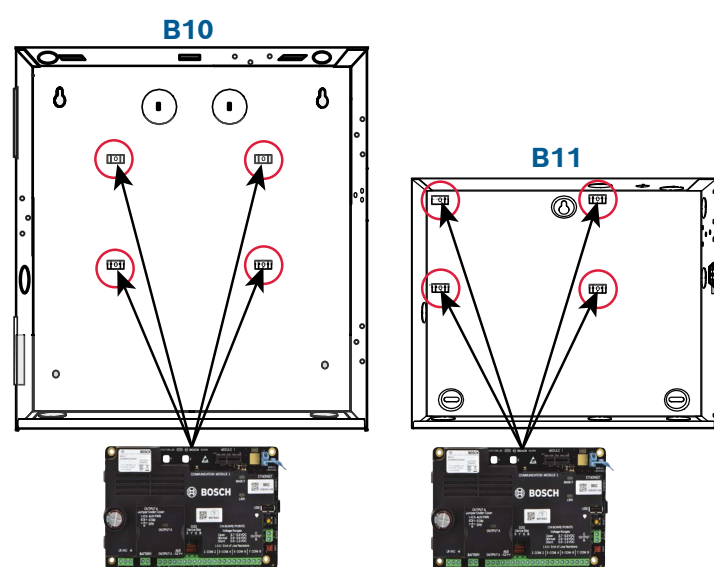

Step 2 Installing a communication module A

Bosch tips:

- ▶ Insert leg of module into slot marked "x."
- ▶ **Cellular:** Place antenna on top of enclosure and run cable inside, then connect to module.
- ▶ **PSTN:** Connect module to a D166 (RJ31x) jack using a D161/D162 cable.

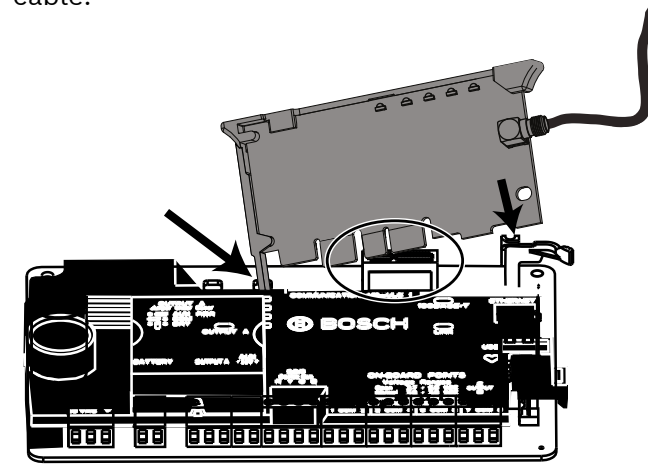

Step 3 Installing a keypad I

Bosch tips:

- ▶ When installing a compatible Bosch keypad, refer to keypad installation guide for specific wiring diagrams. Basic keypad wiring is shown below.
- ▶ When installing more than one keypad, refer to keypad installation guide for unique address settings.

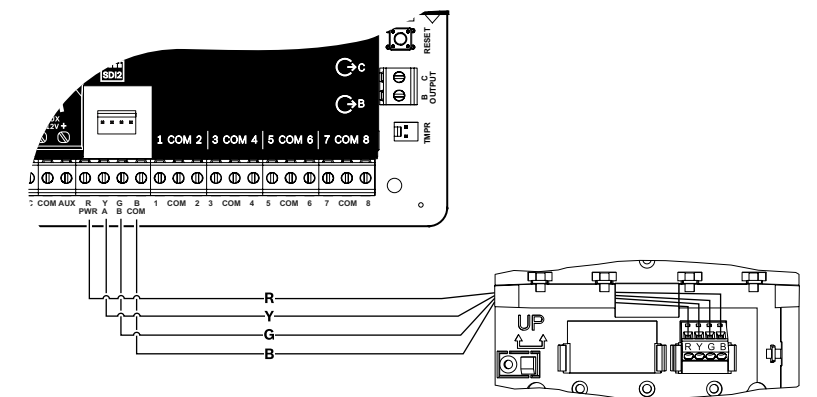

Step 4 Installing expansion modules I

Bosch tips:

- ▶ If installing more than one device that is similar, refer to the module's installation guide for address settings (for example, two of the same device).
- ▶ If installing a RADION B810 wireless receiver, use address 1 only.

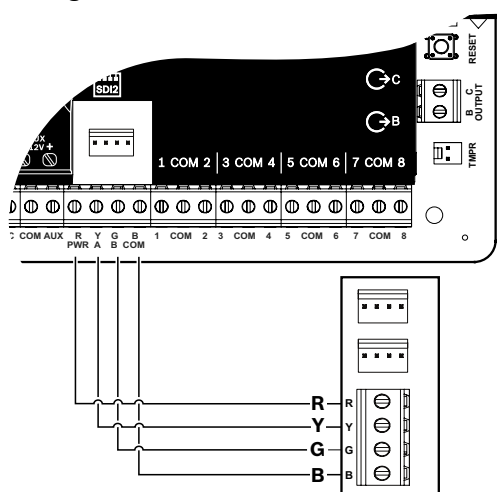

Step 5 Installing wired inputs H

Bosch tips:

- ▶ If using a dual EOL, 2K EOL, or no EOL, refer to control panel installation guide for control panel settings.
- ▶ If using 2-wired powered devices, use a B201 or D125B.

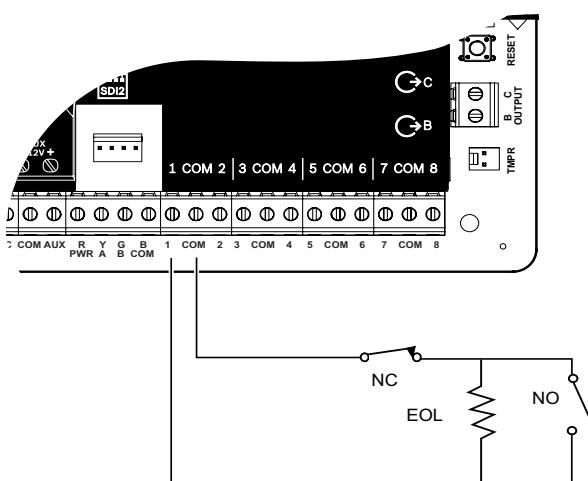

NOTE: Not all modules are available in all regions.

Step 6 Installing a bell or siren J K

Bosch tips:

- ▶ Output A can supply up to 1 A at 12 VDC when sourced from a control panel (jumper in AUX PWR position).
- ▶ Output A can support up to 3 amps at 12 VDC when using a separate power supply (jumper in DRY position).
- ▶ Output B and C are open collectors and are limited to 50 mA at 12 VDC.

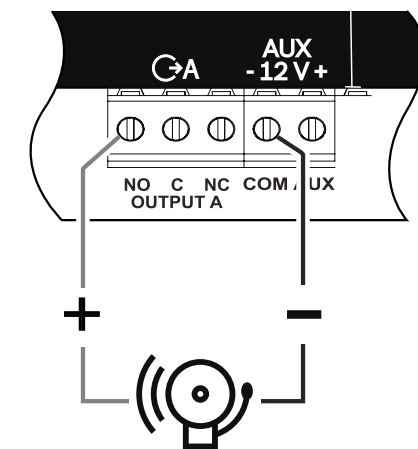

Step 7 Powering the control panel L

Bosch tips:

- ▶ Connect wires to control panel before applying battery or AC power.
- ▶ Connect earth ground to a cold water pipe (copper) or other solid connection to ground.

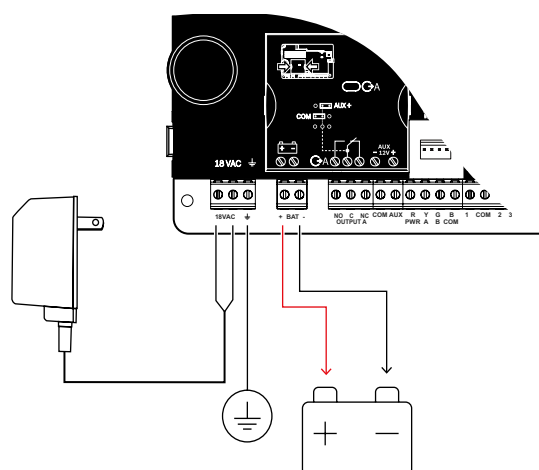

Step 8 Create panel accounts using RPS B C

Bosch tips:

- ▶ If configuring using the Installer Services Portal, go to **Step 11**.
- ▶ Install Remote Programming Software (RPS) v6.06 or later. You can download RPS from the RPS product page.
- ▶ Follow the RPS Account Assistant instructions to create new control panel accounts. The Account Assistant helps you create a new panel account.
- ▶ If RPS is not available, keypad programming is an option. Refer to keypad installation instructions.

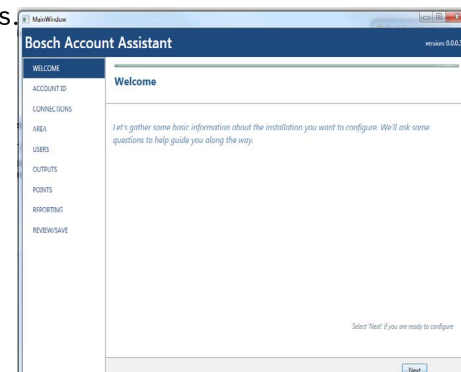

Step 9 Connecting the control panel using RPS B C

Bosch tips:

- ▶ Connect a computer with RPS installed. Direct RPS connections can be done through a USB connection or Ethernet connection.
- ▶ The Account Assistant automatically launches when you create a new account.
- ▶ For USB direct connection, use a B99 USB cable.

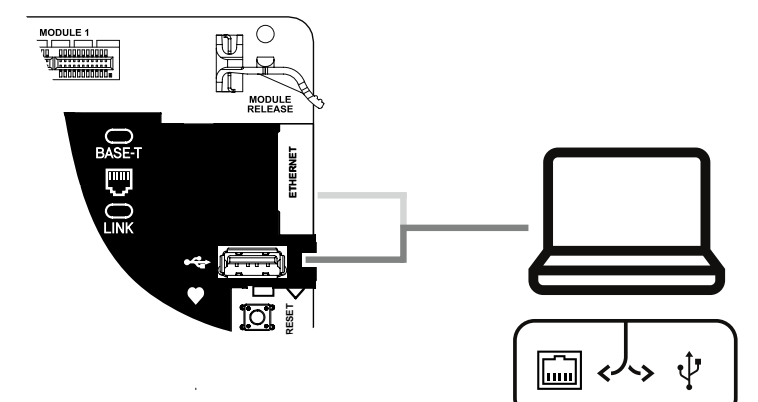

B Series Control Panel

Installer Quick Start Guide

Step 10 Configure and send to control panel using RPS

Bosch tips:

- ▶ Program your configuration information using Account Assistant.
- 1. Press **close Account Assistant, and connect to control panel.** This opens the **Panel Communication** window.
- 2. Press **Connect** and send configuration programming to control panel.

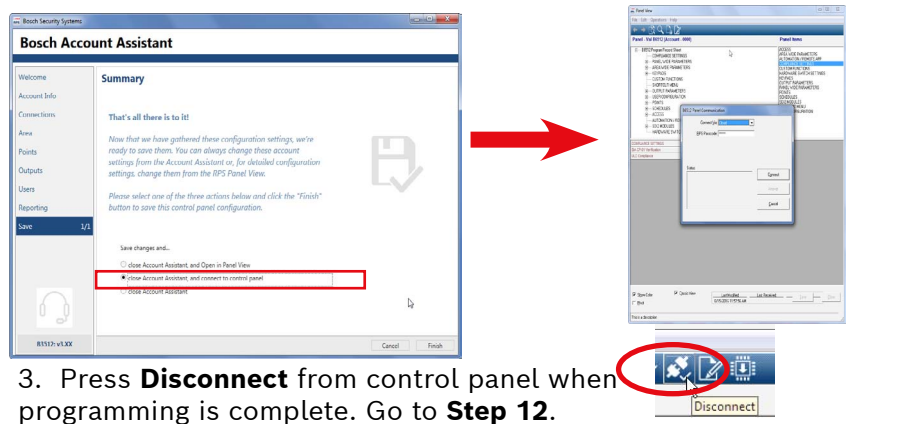

- 3. Press **Disconnect** from control panel when programming is complete. Go to **Step 12.**

Step 11a Accessing the Installer Service Portal and create panel account

Bosch tips:

Using the Installer Services Portal: (Not in all regions)

- ▶ Before you can use Installer Services Portal you must register for services at: <https://sp.boschsecurity.com>.
- ▶ Make sure the control panel is connected to the network.
- 1. Log into the Installer Services Portal.
- 2. Click on **New** and select **Device** to create a panel account.
- 3. Add panel account information.
- 4. Activate CloudID. ISP searches database for registered ID.
- 5. Select **Activate**.
- 6. Click **Add Panel**.

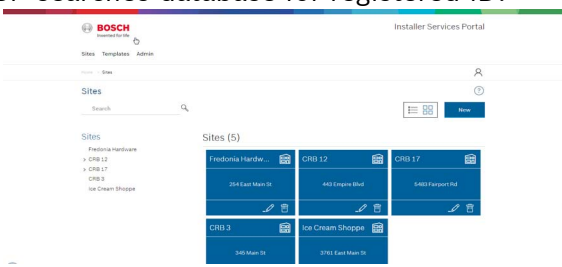

Step 11b Connect and send using the Installer Service Portal

Bosch tips:

Using the Installer Services Portal:

- ▶ Search or select device to connect to a control panel. Type in panel account name in the Search field to locate new account.
- 1. Select the panel account.
- 2. Click **Connect**.
- 3. Click **Configuration**. Program your configuration information.
- 4. Click the 3 vertical dots and select **Push Pending Changes to Panel** to send configuration.
- 5. Click **Disconnect** when configuration is complete.

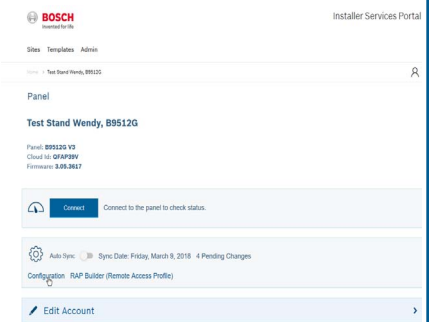

B Series control panel accessories (partial list)

Note: Not all products and features are available in all regions. Consult your Bosch representative or product datasheets for details.

Control panel

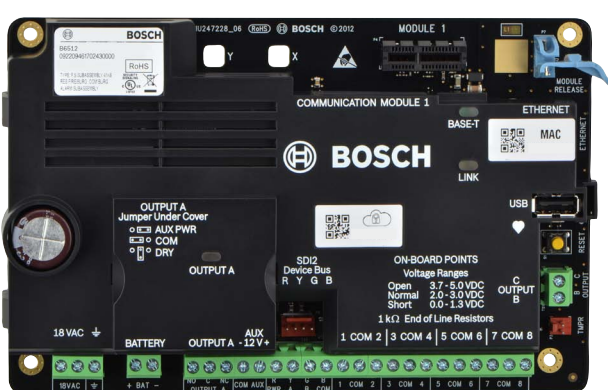

Power

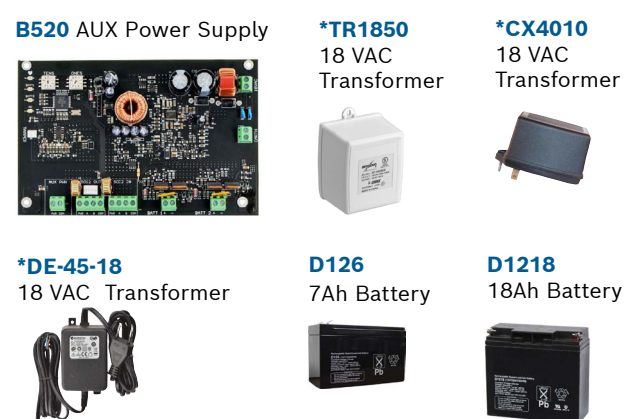

D135A Low-Battery Disconnect Module

*Country specific, variants will apply

Communicators

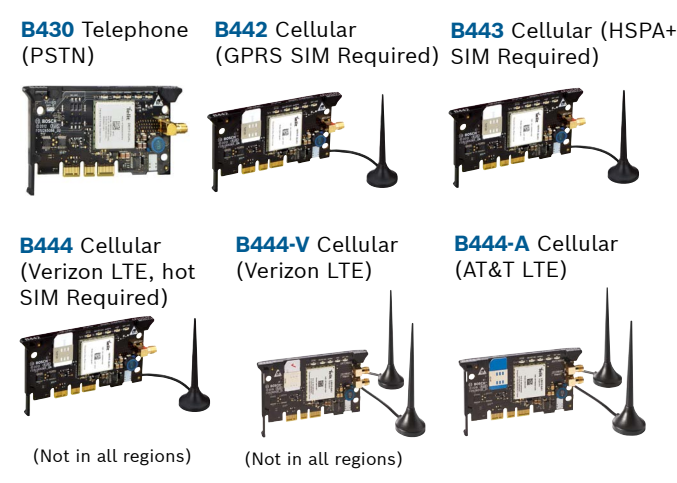

(Not in all regions)

(Not in all regions)

B450 Remote Cellular Interface



RADION wireless devices

-A versions of RADION devices are used in North and South America. Non -A versions are used in Europe, Africa, and Australia.

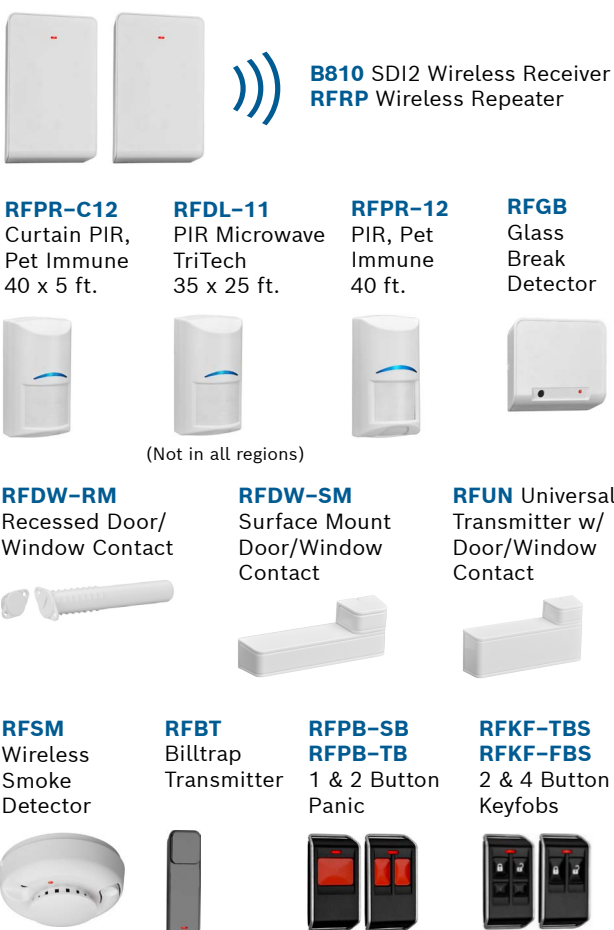

Keypads



(Not in all regions)

(Not in all regions)

RFID tags (for Readers & B942 Keypads)



IP camera integration

Any Bosch IP camera



Enclosures & accessories

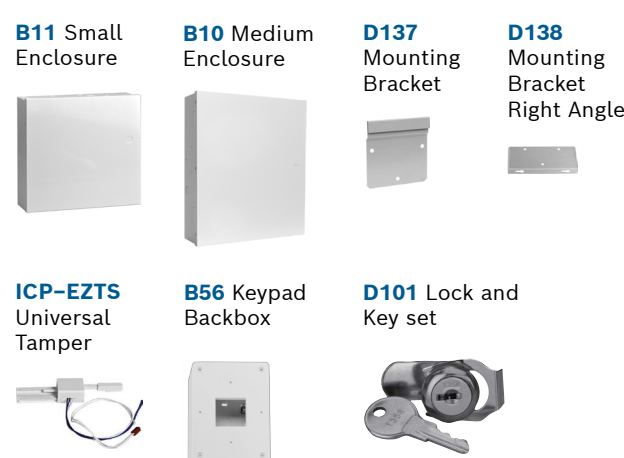

Residential fire

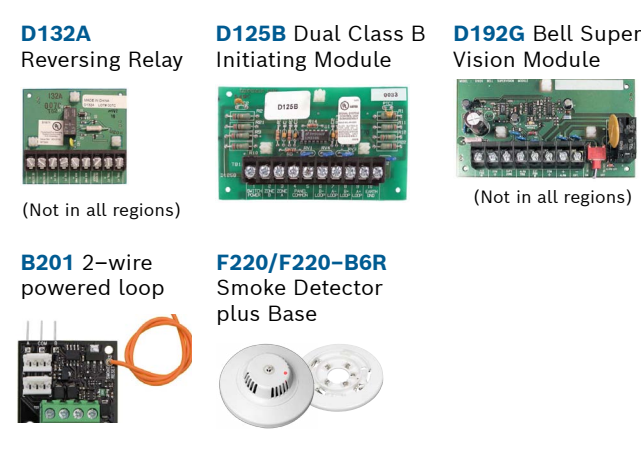

(Not in all regions)

(Not in all regions)

Access modules



I/O expansion modules

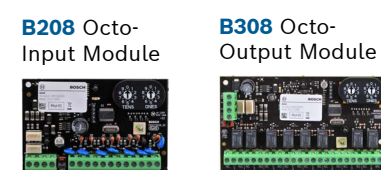

*Home automation

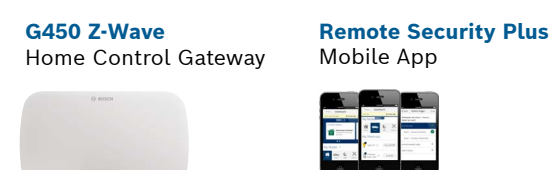

*Home automation may not be available in all regions. Consult your Bosch representative for details.

Wired motion detectors



Step 12 Test the system

After system installation and control panel programming, you must perform a complete system test. A complete system test includes testing the control panel, all devices, and communication destinations for proper operation.

Bosch tips:

- ▶ Perform a Walk Test
 1. Select **Actions**.
 2. Select **Test**.
 3. Select **Walk Test**.
 4. Choose a test to run.
- ▶ Send a test report

(B942 is keypad shown)



FAQs

What is my default code?

User Code: **123456**
Installer Code: **123**

How do I use Output B and C?

Outputs B and C are Open Collector Outputs. Wiring can be found in control panel installation manual, section heading **Open Collector Outputs**.

How do you remotely turn on and turn off the control panel?

This can be done through the use of the Remote Security Control App.

How do I connect directly to the control panel with Ethernet?

By default, the control panel is set up to auto detect and negotiate a connection to RPS when an ethernet cable is connected between them.

What do I need to be able to send personal notifications?

SMS (Text) messages require the use of a cellular module and emails can be sent by either an Ethernet or Cellular connection.

How do I enter "Service Mode"?

Press and hold the yellow reset button on the control panel for 5 seconds (repeat to exit).

Where can I go for additional information?

www.boschsecurity.com

Bosch Security Systems B.V.
Torenallee 49
5617 BA Eindhoven
Netherlands

2 | Specifications

Dimensions	27.8 cm x 25.9 cm x 8.32 cm (10.9 in x 10.2 in x 3.3 in)
Color	White
Compatible Lockset (optional)	D101 Lock and Key Set
Compatible Dual Tamper Switch (optional)	ICP-EZTS Tamper Switch D110 Tamper Switch
Material	0.7 mm (22 gauge) cold-rolled steel

Small Control Panel Enclosure B11



en Installation Guide



Reading Bosch Security Systems B.V. Product Date Codes

For Product Date Code information, refer to the Bosch Security Systems B.V. Web site at: <http://www.boschsecurity.com/datecodes/>.

Bosch Security Systems B.V.

Torenallee 49
5617 BA Eindhoven
Netherlands

www.boschsecurity.com

© Bosch Security Systems B.V., 2019



1 | Overview

This enclosure is compatible with select Bosch intrusion products, and can hold one batteries.

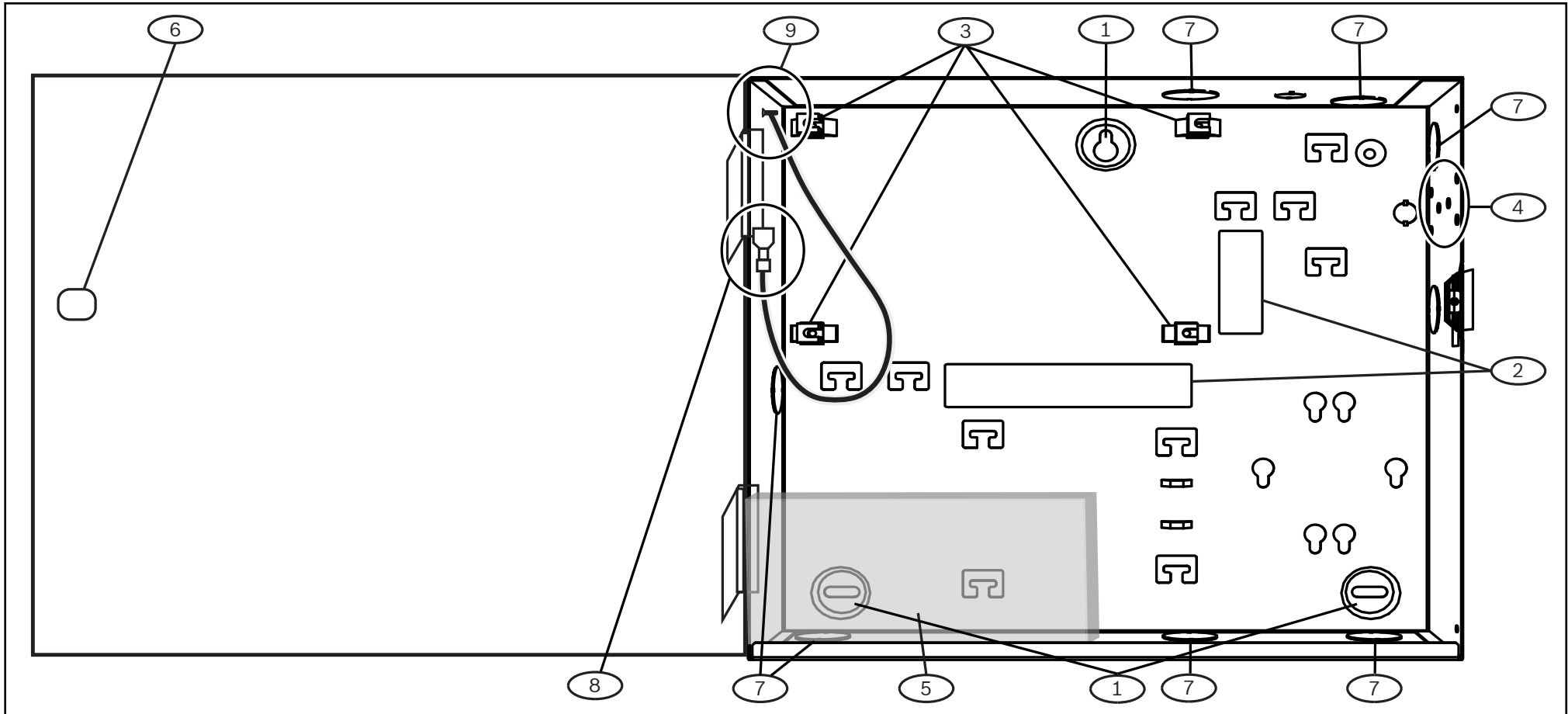

Callout	Description
1	Enclosure mounting holes (3) Bosch recommends using #8 screws and wall anchors to install.
2	Wire knockouts (9)
3	Control panel mounting location
4	Tamper switch mounting location
5	Battery mounting location (size 7Ah)
6	Lockset mounting location
7	Conduit knockouts (8) 12.7 mm (1/2 in)
8	Grounding (bonding) connection to enclosure door
9	Grounding (bonding) connection for door only. Do not connect any other wires to this lug.

1 | Overview

The B430 connects to the control panel for communication over the PSTN (Public Switched Telephone Network).

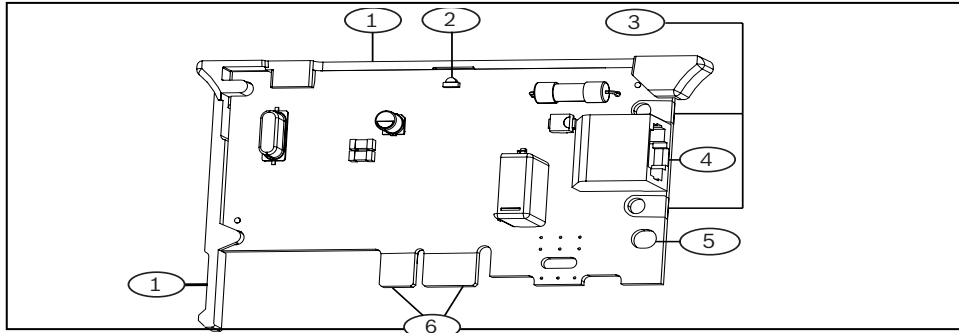

Callout – Description	Callout – Description
1 – Module handle and support leg	4 – RJ45 phone connector
2 – Line seize/ring LED	5 – Plug-in module retention clip opening
3 – Test phone pads	6 – PCB metal contacts

2 | Install or remove the module



NOTICE!

Remove all power (AC and battery) before making any connections. Failure to do so might result in personal injury and/or equipment damage.

2.1 | Install the module

1. Insert the support leg into the support hole labeled X.
2. Align the PCB metal contacts with the on-board connector.
3. Push the module into place until it is tight.

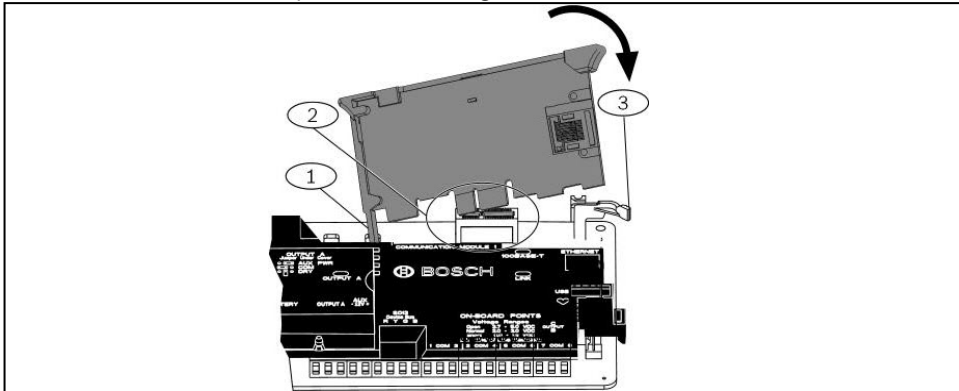

Callout – Description	Callout – Description
1 – Support leg	3 – Plug-in module retention clip
2 – PCB metal contacts	

2.2 | Wire the module

1. Connect one end of a telephone cord to the B430.
2. Connect the other end to an RJ31X or RJ38X phone jack. The module has pads on both sides of the board to connect a telephone test set. Refer to the following illustration.

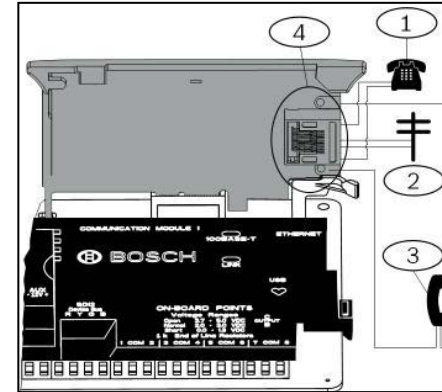

Callout – Description
1 – Premises telephone
2 – Incoming Telco line
3 – Installer telephone test set
4 – RJ45 phone connector

2.3 | Remove the module

1. Open the retention clip.
2. Hold the top corners of the support handle.
3. Pull out the module.

3 | LED descriptions

Refer to the following table.

Flash pattern	Function
OFF Steady 	Standby
ON Steady 	Line seize
Flash 	Ring detect

4 | Configuration

Use Remote Programming Software (RPS) or an SDI2 keypad to program.

For programming parameter descriptions, options, and defaults refer to *RPS Help* or the *Program Entry Guide* for your control panel.

5 | Certifications

Region	Certification
US	UL 365 - Police Station Connected Burglar Alarm Units and Systems UL 636 - Holdup Alarm Units and Systems UL 864 - Control Units and Accessories for Fire Alarm Systems (Commercial Fire) UL 985 - Household Fire Warning System Units UL 1023 - Household Burglar Alarm System Units UL 1076 - Proprietary Burglar Alarm Units and Systems UL 1610 - Central Station Burglar Alarm Units FCC Part 15 FCC Part 68 FCC Registration Number: ESVAL00BB430 Ringer Eq: 0.0B
Canada	CAN/ULC S303 - Local Burglar Alarm Units and Systems CAN/ULC S304 - Signal Receiving Centre and Premise CAN/ULC S545 - Residential Fire Warning System Control CAN/ULC S559 - Fire Signal Receiving Centres and Systems ICES-003 - Information Technology Equipment (ITE) ULC-ORD C1023 - Household Burglar Alarm System Units ULC-ORD C1076 - Proprietary Burglar Alarm Units and System

6 | Specifications

Dimensions	2 in x 3.68 in x 0.60 in (50 mm x 93.5 mm x 15.25 mm)
Voltage (operating)	12 VDC nominal
Current (maximum)	Standby: 24 mA Alarm: 24 mA
Operating temperature	+32°F to +120°F (0°C to +49°C)
Relative humidity	5% to 93% at +90°F (+32°C)
Communication speed	2400 baud maximum
Compatibility	B9512G/B9512G-E B8512G/B8512G-E B6512 B5512/B5512E B4512/B4512E B3512/B3512E

DE-de: Für Dokumentation in Ihrer Sprache, klicken Sie hier <https://de.boschsecurity.com/de>

El-gr: Μεταβείτε στη διεύθυνση <https://gr.boschsecurity.com/el/> για την τεκμηρίωση σε αυτήν τη γλώσσα.

Es-es: Visite <https://es.boschsecurity.com/es/> para obtener documentación en este idioma.

Fr-fr: Accédez à l'adresse <https://fr.boschsecurity.com/fr/> pour obtenir la documentation dans cette langue.

Hu-hu: A honosított dokumentációt lásd a <https://hu.boschsecurity.com/hu/> oldalon.

It-it: Andare a <https://it.boschsecurity.com/it/> per la documentazione in questa lingua.

Nl-nl: Voor de documentatie in uw taal, ga naar <https://www.boschsecurity.com/nl/nl>

Pl-pl: Dokumentacja w tym języku znajduje się w witrynie <https://pl.boschsecurity.com/pl/>

Pt-br: Acesse <http://pt.boschsecurity.com/pt/> para obter a documentação neste idioma.

SE-sv: For documentation in this language, go to <https://www.boschsecurity.com/xn/en/>

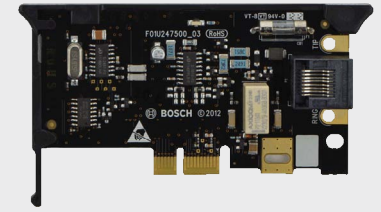

Plug-in Telephone Communicator B430



en Installation Guide

Bosch Security Systems, B.V.
 Torenallee 49
 5617 BA Eindhoven
 Netherlands
www.boschsecurity.com

Copyright

This document is the intellectual property of Bosch Security Systems, Inc. and is protected by copyright. All rights reserved.

Trademarks

All hardware and software product names used in this document are likely to be registered trademarks and must be treated accordingly.

Bosch Security Systems, Inc. product manufacturing dates

Use the serial number located on the product label and refer to the Bosch Security Systems, Inc. website at <http://www.boschsecurity.com/datecodes/>.

