

EN
FR
ES

5-037-017-11(1)



STR-AZ7000ES

Supplied accessories:
Accessoires fournis :
Accesorios suministrados:

- Remote control (1)
Télécommande (1)
Mando a distancia (1)
- Calibration microphone (1)
Microphone de calibrage (1)
Micrófono de calibración (1)
- Front cover (1)
Capot avant (1)
Cubierta frontal (1)
- R03 (size AAA) batteries (2)
Piles R03 (taille AAA) (2)
Pilas R03 (tamaño AAA) (2)
- Mic stand top (1)*1
Partie supérieure du socle pour micro (1)*1
Partie supérieur del soporte del micrófono (1)*1
- Mic stand pillar (1)*1
Colonne du socle pour micro (1)*1
Columna del soporte del micrófono (1)*1
- AC power cord (mains lead) (1)
Cordon d'alimentation secteur (1)
Cable de alimentación de CA (1)
- FM wire antenna (aerial) (1)
Antenne fil FM (1)
Antena FM de cable (1)
- Mic stand bottom (1)*1
Partie inférieure du socle pour micro (1)*1
Base del soporte del micrófono (1)*1

*1 For how to assemble the calibration mic stand, refer to the Operating Instructions.
*1 Pour savoir comment assembler le socle pour micro de calibrage, reportez-vous au mode d'emploi.
*1 Para ver cómo montar el soporte del micrófono de calibración, consulte el manual de instrucciones.

You will also need (not supplied):
Autres accessoires nécessaires (non fournis) :
También necesitará (no suministrado):

- Speaker cables
Câbles d'enceinte
Cables de altavoz
- Monaural audio cable
Câble audio mono
Cable de audio monofónico
- HDMI cables*2
Câbles HDMI*2
Cables HDMI*2
- Optical digital cable*3
Câble optique numérique*3
Cable digital óptico*3
- LAN cable*3
Câble LAN*3
Cable LAN*3

*2 For the types of HDMI cables to use, visit the Help Guide.
*2 Pour les types de câbles HDMI à utiliser, consultez le Guide d'aide.
*2 Para ver los tipos de cables HDMI que se pueden utilizar, visite la Guía de ayuda.
*3 These cables may not be needed depending on your connection.
*3 Il est possible que ces câbles ne soient pas nécessaire selon votre connexion.
*3 Puede que estos cables no sean necesarios dependiendo del tipo de conexión.

1 Installing and connecting the speakers Installation et raccordement des enceintes Instalación y conexión de los altavoces

Example of a 7.1.6 channel speaker system configuration
Exemple d'une configuration de systèmes d'enceintes 7.1.6 canaux
Ejemplo de configuración de un sistema de altavoces de 7.1.6 canales

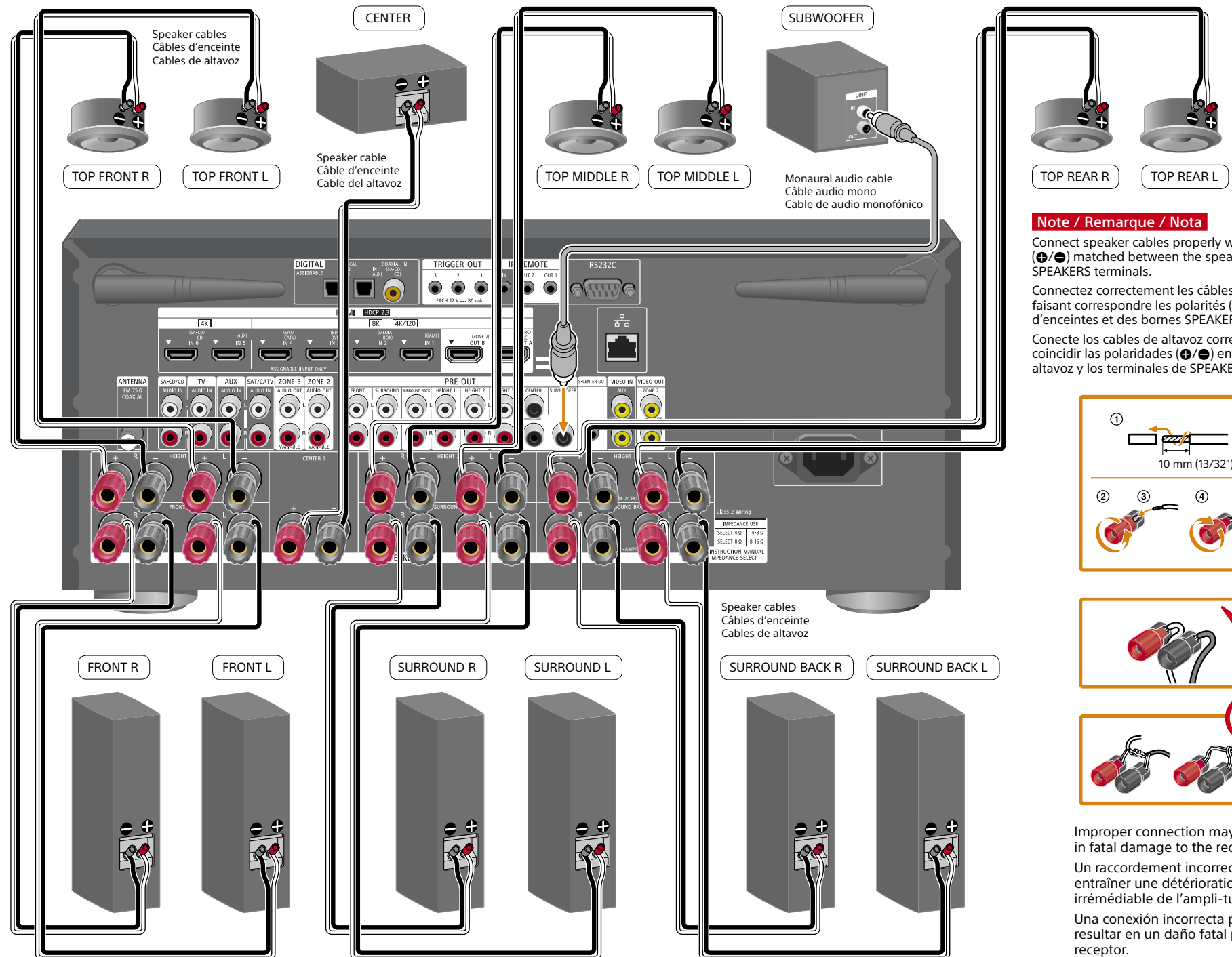
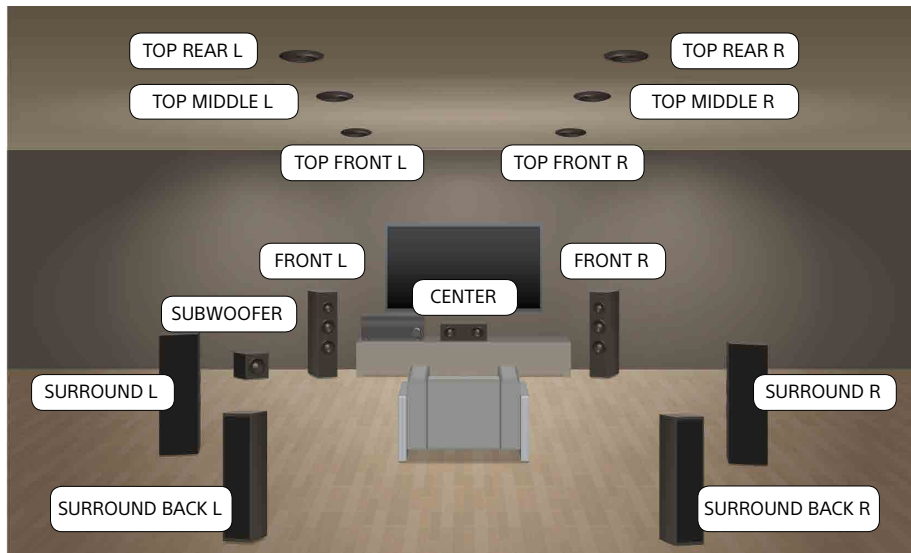

Go to back page for step 2.
Consultez le verso pour l'étape 2.
Vaya al dorso para consultar el paso 2.

Note / Remarque / Nota
Connect speaker cables properly with the polarities (+/-) matched between the speaker cables and the SPEAKERS terminals.
Connectez correctement les câbles d'enceintes en faisant correspondre les polarités (+/-) des câbles d'enceintes et des bornes SPEAKERS.
Conecte los cables de altavoz correctamente haciendo coincidir las polaridades (+/-) entre los cables de altavoz y los terminales de SPEAKERS.

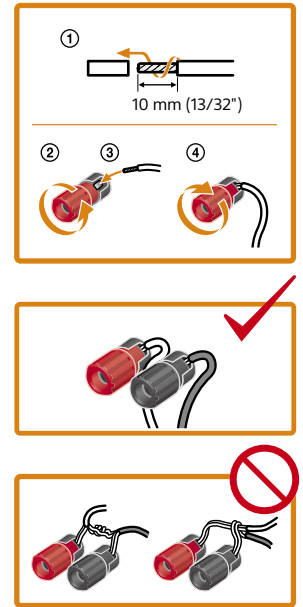

Improper connection may result in fatal damage to the receiver.
Un raccordement incorrect peut entraîner une détérioration irréversible de l'ampli-tuner.
Una conexión incorrecta puede resultar en un daño fatal para el receptor.

Visit the Help Guide for complete instructions and information including more examples of speaker system configurations and connections.
Consultez le Guide d'aide pour des instructions et des informations complètes, notamment des exemples supplémentaires de configurations et de connexions de systèmes d'enceintes.
Visite la Guía de ayuda para ver instrucciones completas e información incluyendo más ejemplos de configuraciones y conexiones del sistema de altavoces.

https://rd1.sony.net/help/ha/straz305070/h_uc/



Connecting to a TV and AV devices Raccordement d'un téléviseur et de périphériques AV Conexión de un televisor y dispositivos AV

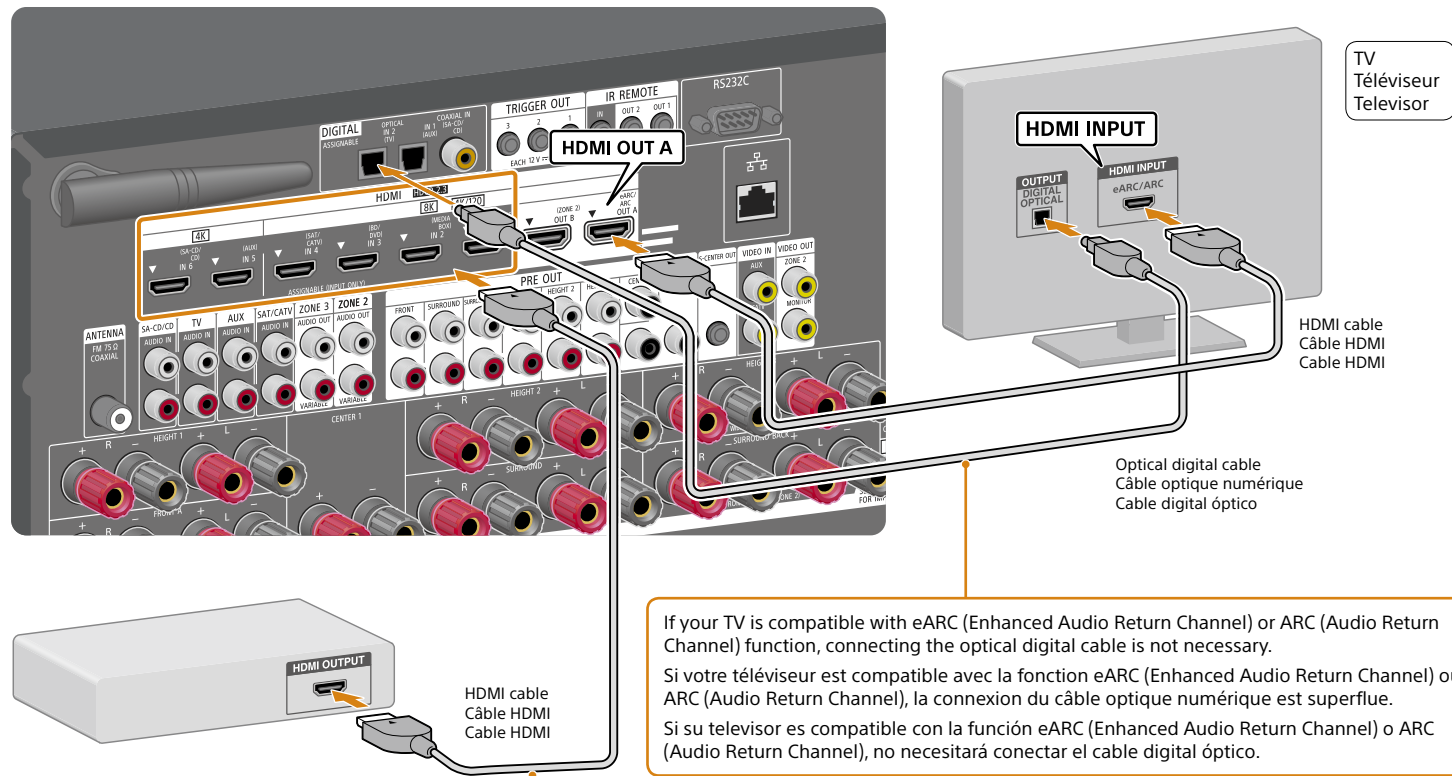

HDMI IN jack/Prise HDMI IN/Toma HDMI IN	Devices to be connected/Appareils à connecter/Dispositivos que conectar
IN 1	Connect a device that supports video signals of 8K or up to 4K/120p. Connectez un appareil qui prend en charge les signaux vidéo de 8K ou jusqu'à 4K/120p. Conecte un dispositivo que admita señales de video de 8K o de hasta 4K/120p.
IN 2	
IN 3	
IN 4	Connect a device that supports video signals up to 4K/60p. Connectez un appareil qui prend en charge les signaux vidéo jusqu'à 4K/60p. Conecte un dispositivo que admita señales de video de hasta 4K/60p.
IN 5	
IN 6	
IN 7 (Front panel/Panneau avant/Panel frontal)	

- Select [HDMI Signal Format] settings suitable for the video formats of the connected devices in the menu on the receiver. For details, visit the Help Guide.
- Sélectionnez les paramètres [Format du signal HDMI] adaptés aux formats vidéo des appareils connectés dans le menu sur l'ampli-tuner. Pour des informations détaillées, consultez le Guide d'aide.
- Seleccione en el menú del receptor los ajustes de [Formato de señal HDMI] apropiados para los formatos de video de los dispositivos conectados. Para obtener detalles, consulte la Guía de ayuda.

Connecting to a network Connexion à un réseau Conexión a una red

- When using a wired connection
- Avec une connexion filaire
- Cuando se utiliza una conexión con cable

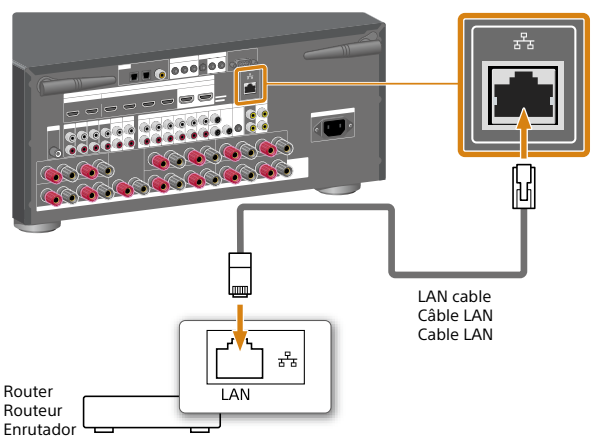

- When using a wireless connection
- Avec une connexion sans fil
- Cuando se utiliza una conexión inalámbrica

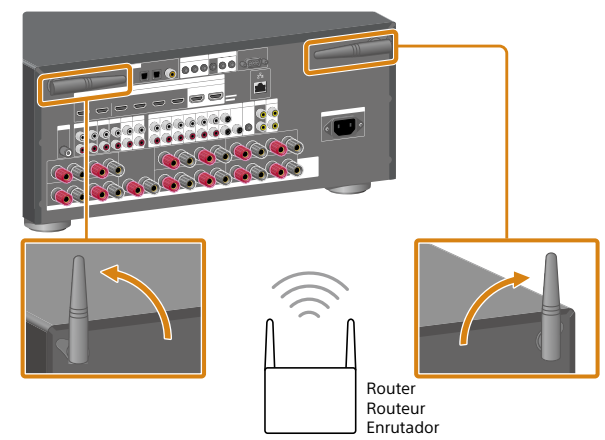

GUI Menu List/Liste du menu de la GUI/Lista del menú de la interfaz gráfica de usuario

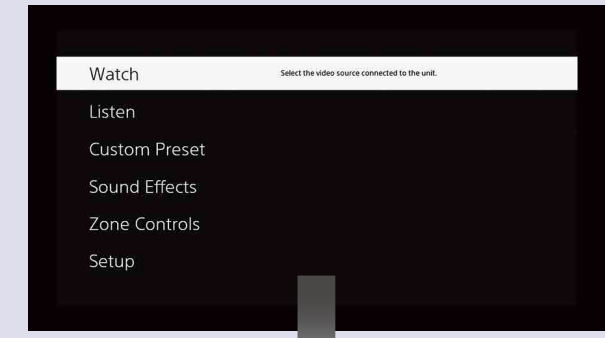

Note / Remarque / Nota

- The item names shown below are examples in English.
- Les noms des éléments indiqués ci-dessous sont des exemples en anglais.
- Los nombres de elementos mostrados a continuación son ejemplos en inglés.

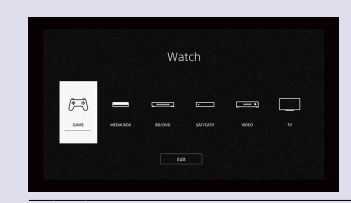

- ▶ GAME
- ▶ MEDIA BOX
- ▶ BD/DVD
- ▶ SAT/CATV
- ▶ VIDEO
- ▶ TV

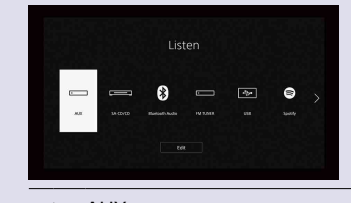

- ▶ AUX
- ▶ SA-CD/CD
- ▶ Bluetooth Audio
- ▶ FM TUNER
- ▶ USB
- ▶ Spotify
- ▶ Chromecast built-in
- ▶ 360 Reality Audio

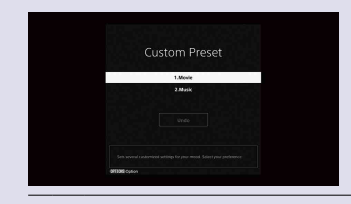

- ▶ 1: Movie
- ▶ 2: Music

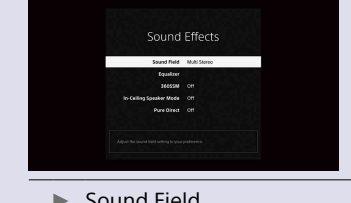

- ▶ Sound Field
- ▶ Equalizer
- ▶ 360SSM
- ▶ In-Ceiling Speaker Mode
- ▶ Pure Direct

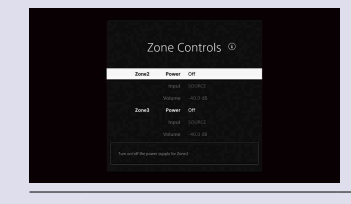

- ▶ Zone2 Power
- ▶ Zone2 Input
- ▶ Zone2 Volume
- ▶ Zone3 Power
- ▶ Zone3 Input
- ▶ Zone3 Volume

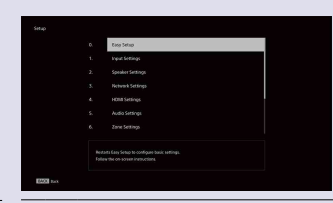

- ▶ Easy Setup
- Language, Auto Calibration, Internet Settings

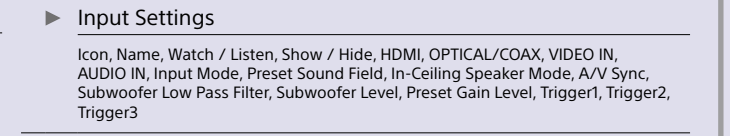

Icon, Name, Watch / Listen, Show / Hide, HDMI, OPTICAL/COAX, VIDEO IN, AUDIO IN, Input Mode, Preset Sound Field, In-Ceiling Speaker Mode, A/V Sync, Subwoofer Low Pass Filter, Subwoofer Level, Preset Gain Level, Trigger1, Trigger2, Trigger3

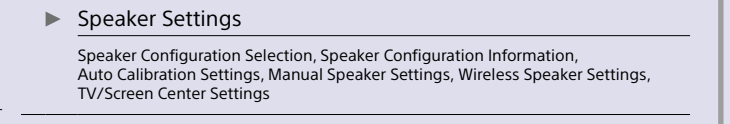

Speaker Configuration Selection, Speaker Configuration Information, Auto Calibration Settings, Manual Speaker Settings, Wireless Speaker Settings, TV/Screen Center Settings

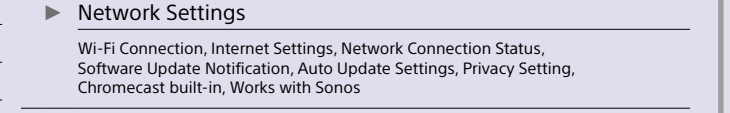

Wi-Fi Connection, Internet Settings, Network Connection Status, Software Update Notification, Auto Update Settings, Privacy Setting, Chromecast built-in, Works with Sonos

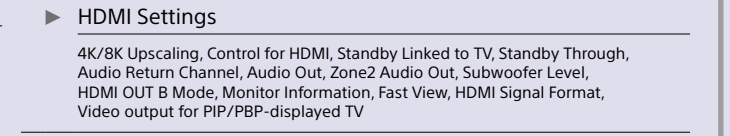

4K/8K Upscaling, Control for HDMI, Standby Linked to TV, Standby Through, Audio Return Channel, Audio Out, Zone2 Audio Out, Subwoofer Level, HDMI OUT B Mode, Monitor Information, Fast View, HDMI Signal Format, Video output for PIP/PBP-displayed TV

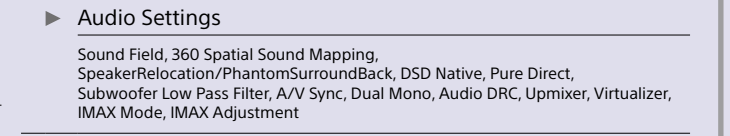

Sound Field, 360 Spatial Sound Mapping, SpeakerRelocation/PhantomSurroundBack, DSD Native, Pure Direct, Subwoofer Low Pass Filter, A/V Sync, Dual Mono, Audio DRC, Upmixer, Virtualizer, IMAX Mode, IMAX Adjustment

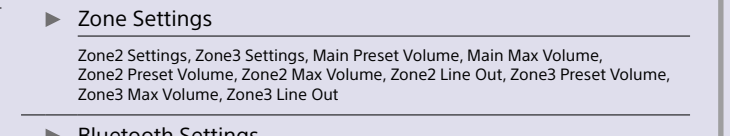

Zone2 Settings, Zone3 Settings, Main Preset Volume, Main Max Volume, Zone2 Preset Volume, Zone2 Max Volume, Zone2 Line Out, Zone3 Preset Volume, Zone3 Max Volume, Zone3 Line Out



Bluetooth Mode, Device List, Bluetooth Connection Quality, Wireless Playback Quality

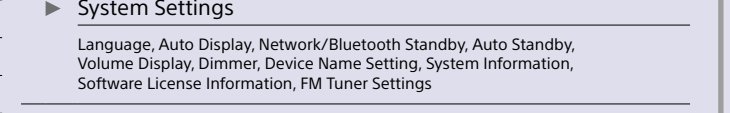

Language, Auto Display, Network/Bluetooth Standby, Auto Standby, Volume Display, Dimmer, Device Name Setting, System Information, Software License Information, FM Tuner Settings

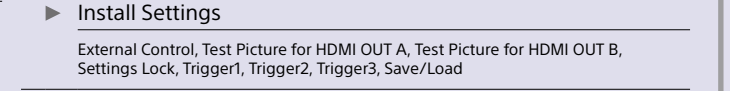

External Control, Test Picture for HDMI OUT A, Test Picture for HDMI OUT B, Settings Lock, Trigger1, Trigger2, Trigger3, Save/Load

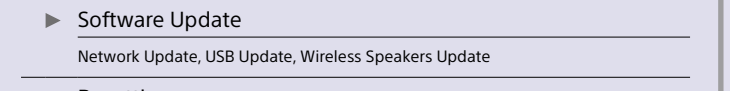

Network Update, USB Update, Wireless Speakers Update

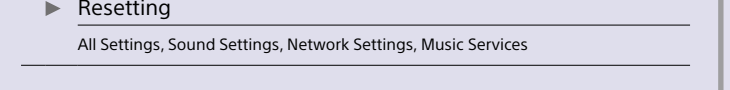

All Settings, Sound Settings, Network Settings, Music Services