

# GV-PFER12800

---

## *User's Manual*



Before attempting to connect or operate this product,  
please read these instructions carefully and save this manual for future use.

MFE-UM-A



© 2023 GeoVision, Inc. All rights reserved.

Under the copyright laws, this manual may not be copied, in whole or in part, without the written consent of GeoVision.

Every effort has been made to ensure that the information in this manual is accurate. GeoVision, Inc. makes no expressed or implied warranty of any kind and assumes no responsibility for errors or omissions. No liability is assumed for incidental or consequential damages arising from the use of the information or products contained herein. Features and specifications are subject to change without notice.

GeoVision, Inc.  
9F, No. 246, Sec. 1, Neihu Rd.,  
Neihu District, Taipei, Taiwan  
Tel: +886-2-8797-8377  
Fax: +886-2-8797-8335  
<http://www.geovision.com.tw>

Trademarks used in this manual: *GeoVision*, the *GeoVision* logo and *GV* series products are trademarks of GeoVision, Inc. *Windows* is the registered trademark of Microsoft Corporation.

September 2023

**Scan the following QR codes for product warranty and technical support policy:**



[Warranty]



[Technical Support Policy]

## Contents

Chapter 1. Introduction .....	1
<i>Safety Instruction</i> .....	1
Chapter 2. Product Description .....	2
2.1 <i>Product Overview</i> .....	2
2.2 <i>Key Features</i> .....	2
2.3 <i>System Requirements</i> .....	4
Chapter 3. Configuration Flow .....	5
Chapter 4. Network Connection .....	7
4.1 <i>Setting the Camera over the LAN</i> .....	7
4.1.1 <i>Connect via a Switch or a Router</i> .....	7
4.2 <i>Dynamic IP Connection</i> .....	8
Chapter 5. Accessing the Network Camera .....	9
5.1 <i>Assigning An IP Address</i> .....	9
5.1.1 <i>Assigning An IP Address Using GV-IP Device Utility</i> .....	9
5.1.2 <i>Assign An IP Address via Browser</i> .....	10
5.2 <i>Accessing from the Web Browser</i> .....	13
Chapter 6. Live View .....	14
6.1 <i>Fisheye Mode</i> .....	14
6.1.1 <i>Operations on Live View Page</i> .....	15
6.1.2 <i>Set / Call a Preset / Patrol</i> .....	22
Chapter 7. Playback .....	27
Chapter 8. Settings .....	31
8.1 <i>Media</i> .....	31
8.1.1 <i>Video</i> .....	31
8.1.2 <i>Image</i> .....	35
8.1.3 <i>Audio</i> .....	49
8.2 <i>Network</i> .....	52
8.2.1 <i>Basic</i> .....	52
8.2.2 <i>Advanced</i> .....	63
8.3 <i>Storage</i> .....	77
8.3.1 <i>Storage Management</i> .....	78
8.3.2 <i>Record Settings</i> .....	78

8.3.3 Snapshot Settings .....	81
8.3.4 Explorer.....	83
8.4 Event .....	84
8.4.1 Basic Event .....	84
8.4.2 VCA Event.....	92
8.4.3 Object Counting .....	116
8.4.4 Heat Map.....	135
8.5 Fisheye .....	143
8.6 System.....	145
8.6.1 System Setting .....	145
8.6.2 Security .....	146
8.6.3 Logs .....	153
8.6.4 Maintenance.....	155
Appendix .....	158
A. Optional Installation .....	158
1. GV-Mount211-7 .....	158
2. GV-Mount430 .....	161
3. GV-Mount508 .....	163
B. Note for Fisheye Camera with IR LED .....	166

# Chapter 1. Introduction

## *Safety Instruction*

These instructions are intended to ensure that user can use the product correctly to avoid danger or property loss. The precaution measures are divided into “Warnings” and “Cautions”

**Warnings:** Serious injury or death may be caused if any of these warnings is neglected.

- This installation must be conducted by a qualified service person and should strictly comply with the electrical safety regulations of the local region
- To avoid risk of fire and electric shock, do keep the product away from rain and moisture before installed.
- Do not touch components such as heat sinks, power regulators, and processors, which may be hot
- Source with DC/AC 12V or PoE
- Please make sure the plug is firmly inserted into the power socket
- When the product is installed on a wall or ceiling, the device should be firmly fixed
- If the product does not work properly, please contact your dealer. Never attempt to disassemble the camera by yourself

**Cautions:** Injury or equipment damage may be caused if any of these cautions are neglected.

- Make sure that the power supply voltage is correct before using the camera
- Do not store or install the device in extremely hot or cold temperatures, dusty or damp locations, and do not expose it to high electromagnetic radiation
- Only use components and parts recommended by manufacturer
- Do not drop the camera or subject it to physical shock
- To prevent heat accumulation, do not block air circulation around the camera
- Laser beams may damage image sensors. The surface of image sensors should not be exposed to where a laser beam equipment is used
- Use a blower to remove dust from the lens cover
- Use a soft, dry cloth to clean the surface of the camera. Stubborn stains can be removed using a soft cloth dampened with a small quantity of detergent solution, then wipe dry
- Do not use volatile solvents such as alcohol, benzene or thinners as they may damage the surface finishes
  
- Save the package to ensure availability of shipping containers for future transportation

# Chapter 2. Product Description

## 2.1 Product Overview

GeoVision provides a consistent range of cost-effective and reliable network cameras to fully meet your requirements. Based on embedded Linux operating system, GeoVision's fisheye IP camera could be easily accessed and managed either locally or remotely with great reliability. With built-in high-performance DSP video processing modules, the cameras pride on low power consumption and high stability. They support state-of-the-art H.265/ H.264 video compression algorithm and industry-leading HD dual-stream technology to achieve the highest level of video image quality under the limited network resources. It is fully functional, supporting for flexible and comprehensive alarm linkage mechanism, day and night auto switch and privacy masking, etc.

In practical applications, GeoVision's fisheye IP camera could either work independently in the LAN, or be networked to form a powerful safety monitoring system. It is widely used in fields such as finance, education, industrial production, civil defense, health care for security's sake.

## 2.2 Key Features

### System

- Built-in WEB server, support IE/ Firefox/ Chrome/ Safari browser
- Based on Linux OS with high reliability
- Support Plugin- Free mode
- Support activation and set-up of the security questions for cameras
- Support ONVIF Profile G & S & T & M
- Three- privilege levels of users for flexible management
- Micro SD/SDHC/SDXC card local storage support, expand the edge storage

### Image

- 0.005Lux Ultra Low Light
- Smart IR II technology
- 12 MP Video Viewing Experience
- Support HLC
- Support BLC
- ICR filter with auto switch, true day/night
- H.265/ H.264 video compression capability
- 70% ~ 80% bandwidth saved by 10-level adjustable H.265+
- Support Primary Stream/ Secondary Stream/ Tertiary Stream
- Real-time video electronic amplification

## **Audio**

- G.711 audio compression capability
- Support Audio I/O

## **Network**

- UPnP protocol for the easy management of camera
- Support DDNS
- FTP upload, SMTP upload, SD card record and SIP phone

## **Advanced Function**

- Motion Detection, Privacy Masking, Network Fault Detection and ROI
- Support AI Video Content Analysis
- Support People Counting function
- Support Heat Map function

## **Hardware**

- Support PoE for power supply
- Support Alarm I/O
- Built-in microphone
- IK10-rated vandal-proof metal cover, and IP67-rated weather-proof housing

## **Fisheye**

- Up to 30fps @ 4000 × 3000
- Support Hardware Dewarping and Software Dewarping
- Support Auto Tracking function
- 11 display modes to meet various needs
- Equipped with Audio I/O and Alarm I/O
- IK10-rated vandal-proof metal cover, and IP67-rated weather-proof housing
- Streamlined design, exquisite appearance
- Easy to blend in with the installation environment

## *2.3 System Requirements*

**Operating System:** Windows XP/Vista/7/8/10/Server 2000/Server 2008

**CPU:** 1.66GHz or higher

**RAM:** 1G or higher

**Graphic memory:** 128MB or more

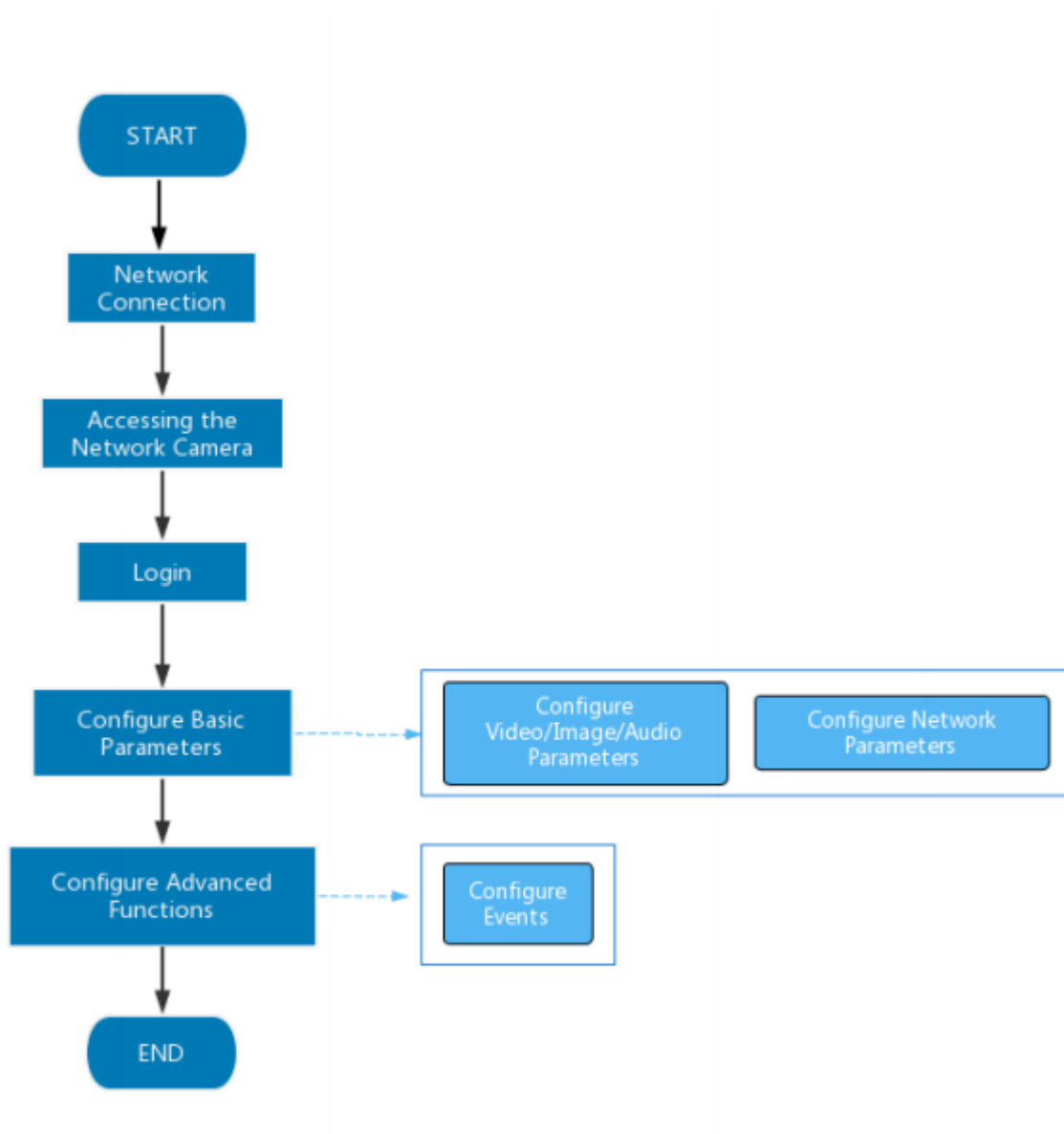
**Internet protocol:** TCP/IP (IPv4/IPv6)

**Web Browsers:** Internet Explorer 8.0 and above version, Mozilla Firefox, Google Chrome and Safari.



## Chapter 3. Configuration Flow

The configuration flow of cameras is shown in the following figure.



**Note:** The configuration must be based on the actual situation of different models.

More configuration details are shown in the following table.

**Table 1. Description of flow**

<b>Configuration</b>	<b>Description</b>	<b>Reference</b>
<b>Network Connection</b>	Connect the network camera. You can set the camera over the LAN or dynamic IP connection.	<i>4.1 Setting the Camera over the LAN</i>
<b>Accessing the Network Camera</b>	Accessing from IP address, web browser and back-end software are available.	<i>5.1 Assigning An IP Address</i>
<b>Configure Basic Parameters</b>	After login the camera, you can adjust the video/image/audio/network parameters as needed.	<i>8.1 Media 8.2 Network</i>
<b>Configure Advanced Functions</b>	Configure the advanced functions, such as VCA and people counting.	<i>8.4 Event</i>

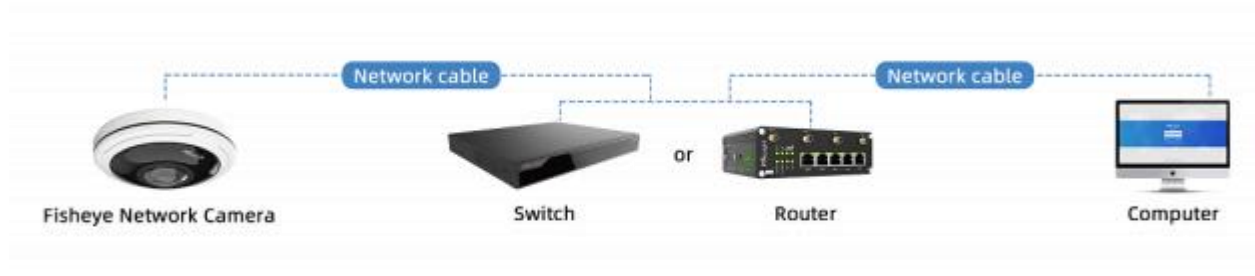
## Chapter 4. Network Connection

### 4.1 *Setting the Camera over the LAN*

Connecting the camera to a switch or a router is the most common connection method. The camera must be assigned an IP address that is compatible with its LAN.

#### 4.1.1 *Connect via a Switch or a Router*

Refer to the following figure to set network camera over the LAN via the switch or router.



## 4.2 Dynamic IP Connection

Step 1: Connect the network camera to a router;

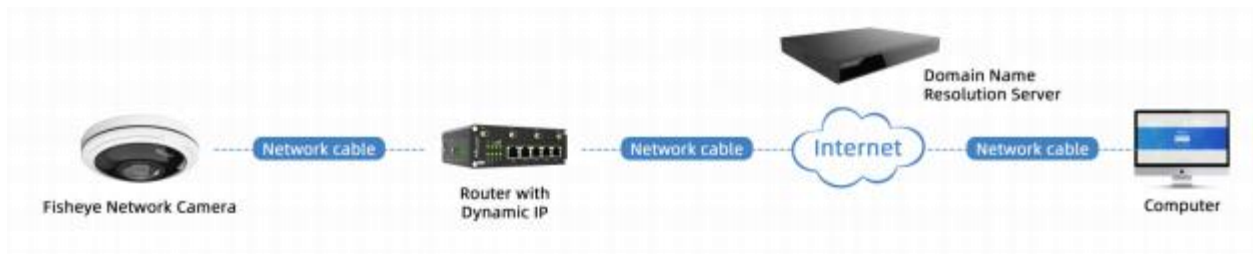
Step 2: On the camera, assign a LAN IP address, the Subnet mask and the Gateway;

Step 3: On the router, set port forwarding. E.g., 80, 8000 and 554 ports. The steps for port forwarding vary depending on different routers. Please look up the router's user manual for assistance with port forwarding;

Step 4: Apply a domain name from a domain name provider;

Step 5: Configure the DDNS settings in the setting interface of the router;

Step 6: Visit the camera via the domain name.



## Chapter 5. Accessing the Network Camera

### *5.1 Assigning An IP Address*

The Network Camera must be assigned an IP address to be accessible. The default IP address of GeoVision fisheye IP cameras is 192.168.0.10.

You can either change the IP address of the camera via Smart Tools or browser. Please connect the camera in the same LAN of your computer.

#### *5.1.1 Assigning An IP Address Using GV-IP Device Utility*

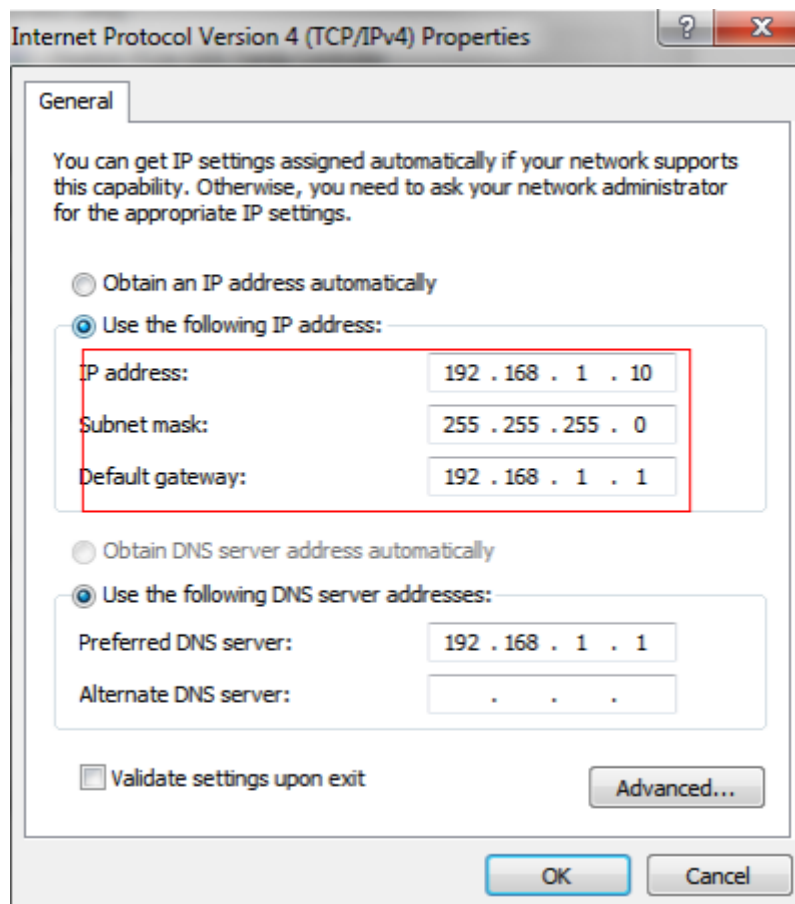
See *Chapter 5 Advanced Settings* [here](#) for assigning an IP address using GV-IP Device Utility. Note that this function is only applicable on GV-IP Device Utility V8.9.9 or later.

## 5.1.2 Assign An IP Address via Browser

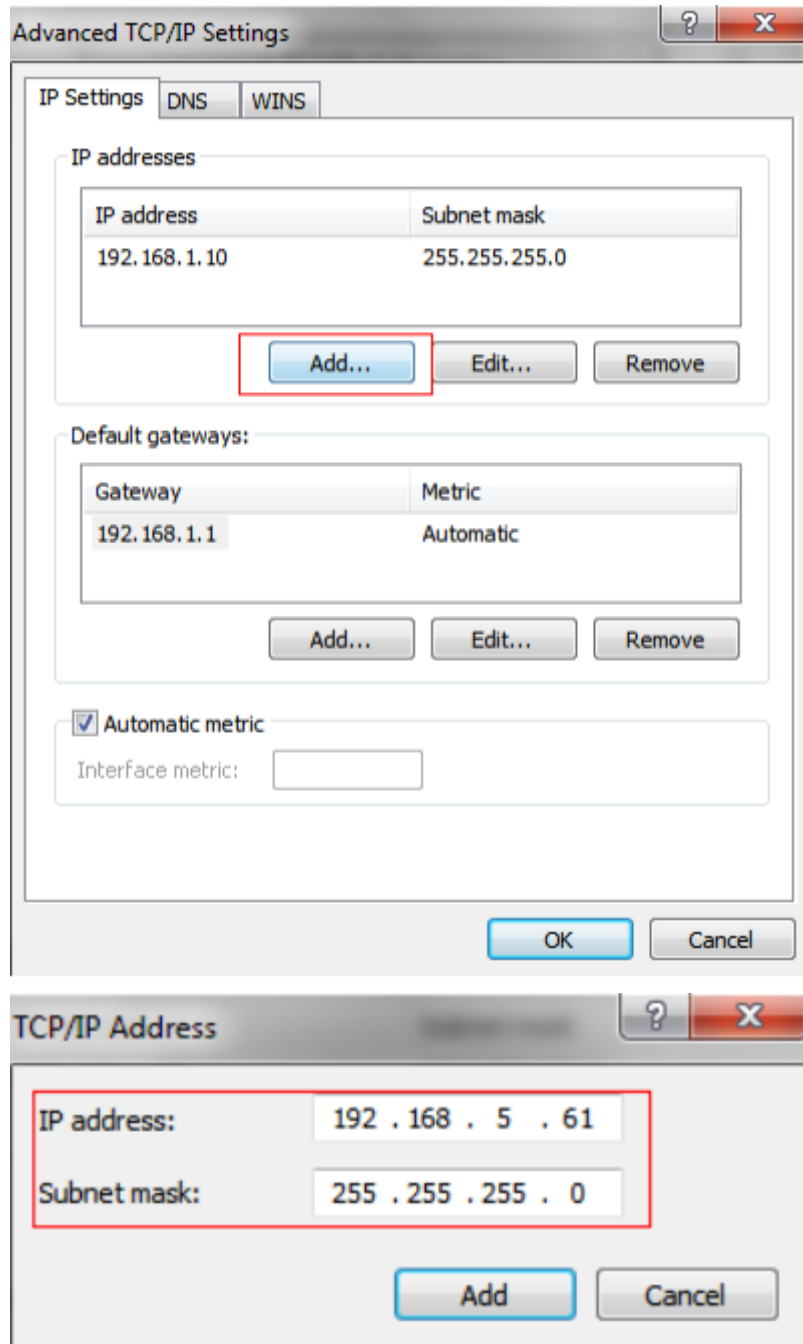
If the network segment of the computer and that of the camera are different, please follow the steps to change the IP address:

**Step 1:** Change the IP address of computer to 192.168.0.10 segment, here are two ways as below:

- a. Start→Control Panel→Network and Internet Connection→Network Connection→Local Area Connection, and double click it;



- b. Click “Advanced”, and then click “IP settings”--> “IP address”--> “Add”. In the pop-up window, enter an IP address that in the same segment with the camera (e.g., 192.168.5.61, but please note that this IP address shall not conflict with the IP address on the existing network);



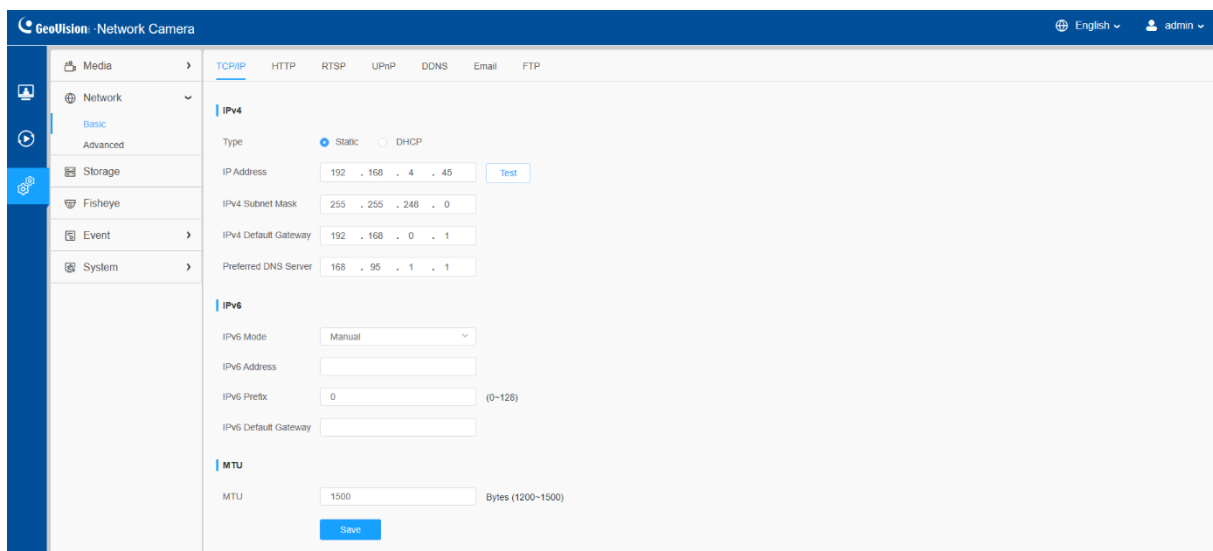
**Step 2:** Start the browser. In the address bar, enter the default IP address of the camera: <http://192.168.0.10>;

**Step 3:** You need to set the password first when using it for the first time. And you can also set three security questions for your device after activation. Then you can log in to the camera with the user name (admin) and a custom password.

**Note:**

- Password must be 8 to 32 characters long, contain at least one number and one letter.
- You can click the “forget password” in login page to reset the password by answering three security questions when you forget the password, if you set the security questions in advance.

**Step 4:** After login, please select “Settings” → “Network” → “Basic” → “TCP/IP”. The Network Settings page appears (shown as the figure below);



**Step 5:** Change the IP address or other network values. Then click “**Save**” button;

**Step 6:** The change of default IP address is completed.



## *5.2 Accessing from the Web Browser*

The camera can be used with the most standard operating systems and browsers. And the camera supports Plugin-Free Mode. In Plugin-Free Mode, you can preview the video on the browser without plugin. Currently Plugin-Free Mode is supported in Firefox & Google Chrome & Safari & Edge browser for Windows system, MAC system, iOS system and Android system. Both H.265 & H.264 video codecs are supported in Plugin-Free Mode for camera, and it will play the secondary stream by default.

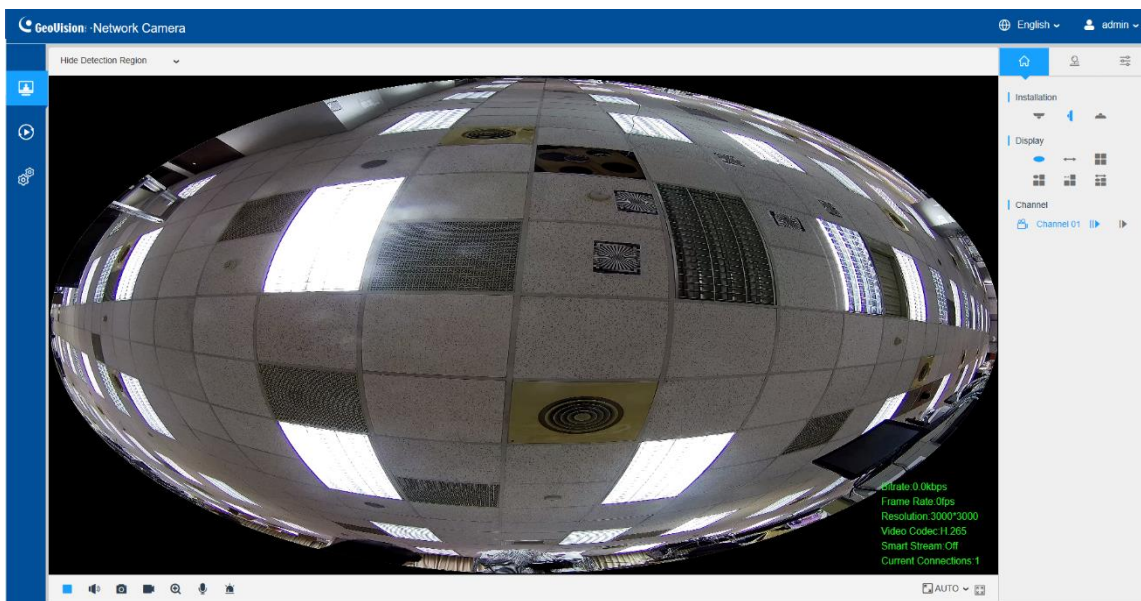
**Note:** Currently you can only use the dewarping mode of fisheye cameras with plugin via Internet Explorer.

# Chapter 6. Live View

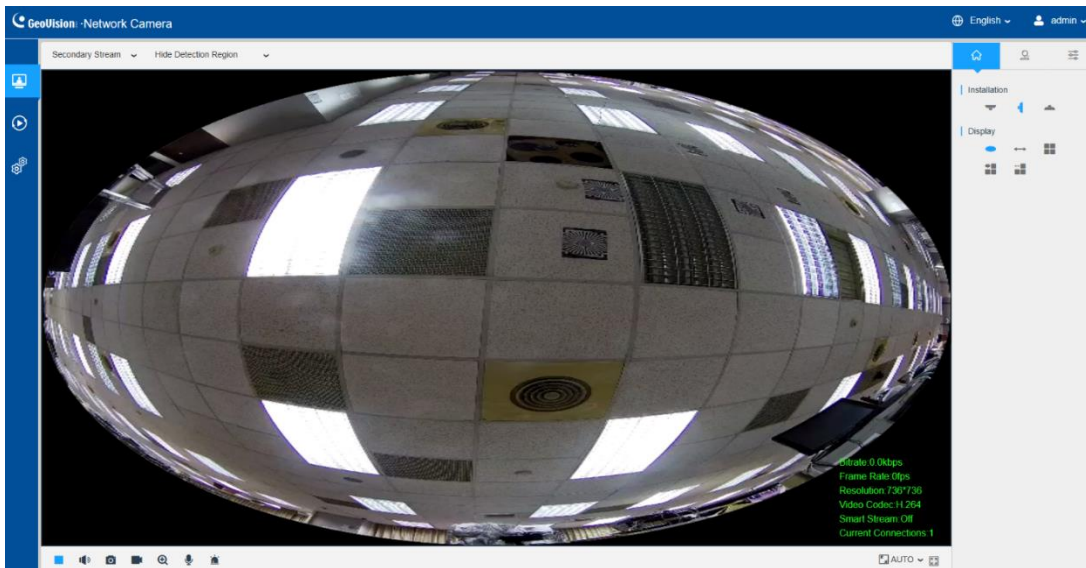
## 6.1 Fisheye Mode

After logging in the network camera web GUI successfully, user is allowed to view live video as follows.

*Live view interface (Multi-Channel Mode):*



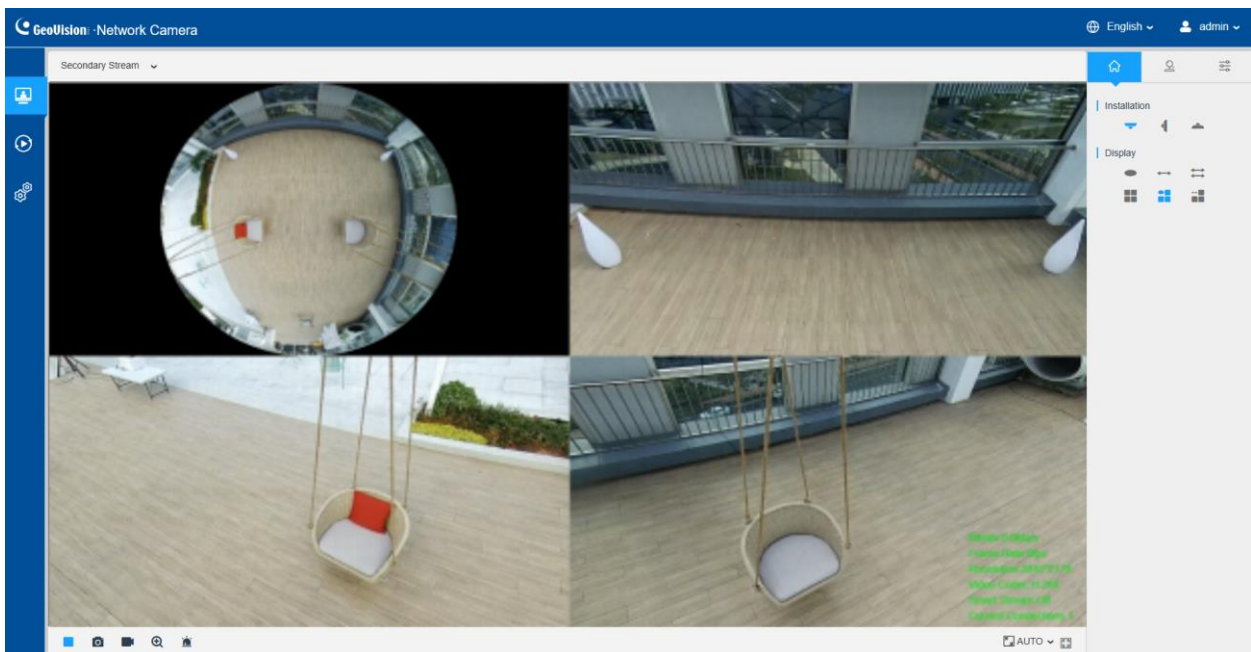
Live view interface (Bundle-Stream Mode):















### 6.1.1 Operations on Live View Page










#### [Display Control]

Display Control allows you to select install type, display mode, window screen and channel of live view.



**Table 2. Description of Display Control buttons**

Item	Parameter	Description
<b>Dewarping Rule</b>	 Hardware Dewarping	Click to select on-board dewarping mode.
	 Software Dewarping	Click to select client-side dewarping mode.
<b>Installation</b>	 Ceiling Mounting	Click to select ceiling mounting.
	 Wall Mounting	Click to select wall mounting.
	 Flat Mounting	Click to select flat mounting.
<b>Display</b>	 1O	Select live view of original fisheye view.
	 1P	Select live view of 360° panoramic view.
	 2P	Select live view of two 180° panoramic views.
	 4R	Select live view of four regional views.
	 1O3R	Select live view of one original fisheye view and three regional views.
	 1P3R (Only for Hardware Dewarping)	Select live view of one 360° panoramic view and three regional views.
<b>Display</b>	 1P3R (Only for Multi-Channel Mode of Hardware Dewarping)	Select live view of one original fisheye view, one 360° panoramic view and three regional views.

	 <b>1P1R</b> (Only for Software Dewarping)	Select live view of one 360° panoramic view and one regional view.
	 <b>1P4R</b> (Only for Software Dewarping)	Select live view of one 360° panoramic view and four regional views.
	 <b>1P6R</b> (Only for Software Dewarping)	Select live view of one 360° panoramic view and six regional views.
	 <b>1O8R</b> (Only for Software Dewarping)	Select live view of one original fisheye view and eight regional views.
<b>Channel</b>	 (Only for Multi-Channel Mode)	Click to play this channel on any window of live view.
<b>Window</b>	 Window Layout (Only for Multi-Channel Mode)	Click to set window layout to “1*1”/ “2*2”/ “1+4”.
	 Window Size	Click to display images at a window size.
<b>Display</b>	 Real Size	Click to display images at a real size.
	 Full Screen	Click to display images at full-screen.

**Note:**

- Original fisheye view: The whole wide-angle view of the fisheye camera is displayed.




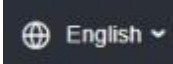
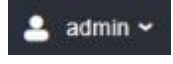
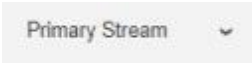
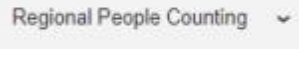

- Panoramic view: The round fisheye image is transformed to rectangular image by certain calibration methods.
- Regional view: The close-up view of defined area in the original fisheye view or panoramic view.
- Select the Installation, Display mode and the most appropriate Window Layout in sequence.






### [Live View Window]







Display live video on the window.

**Note:** It will capture images and record videos of first channel by default, you can also capture images and record videos of specified channel manually.

**Table 3. Description of the buttons**

No.	Parameter	Description
1	 Live Video	Click to access the live view page.
2	 Playback	Click to access the playback page.
3	 Settings	Click to access the configuration page.
4	 English	Click to select system language.
5	 admin	Display the user name and click to logout.
6	 Primary Stream	Choose the stream ( <b>Primary/Secondary/Tertiary</b> ) to show on the current video window.
7	 Regional People Counting	Choose the options ( <b>Hide Detection Region/Region Entrance/Region Exiting/Advanced Motion/Line Crossing/Loitering/People Counting/Object Left/Object Remove/Regional People Counting</b> ) to hide/display detection region on the current video window.
8	 Recording	When recording, the icon appears.

9	 Alarm	When an alarm of VCA event was triggered, the icon appears.
10	 Alarm	When an alarm of people counting was triggered, the icon appears.
11	 Alarm	When an alarm of Motion Detection was triggered, the icon appears.
12	 Alarm	Except for the three kinds of alarms above, when other alarms were triggered, the icon appears.
13	 Stop/Play	<b>Stop/Play</b> live view.








No.	Parameter	Description
14	 Snapshot	Click to capture the current image and save to the configured path. The default path is: C:\VMS\+-1\IMAGE-MANUAL.
15	 Start/Stop Recording	Click to <b>Start Recording</b> video and save to the configured path. The default path is C:\VMS\+-1\MS_Record. Click again to <b>Stop Recording</b> .
16	 Digital Zoom	When enabled, you can zoom in a specific area of video image with your mouse wheel.
17	 Manual Output	Manually trigger Camera Alarm Output.
	 	<p><b>Brightness:</b> Adjust the Brightness of the scene.</p> <p><b>Contrast:</b> Adjust the color and light contrast.</p> <p><b>Saturation:</b> Adjust the Saturation of the image. Higher Saturation makes colors appear “purer” while lower one appears more “wash-out”.</p> <p><b>Sharpness:</b> Adjust the Sharpness of image. Higher Sharpness sharpens the pixel boundary and makes the image looks “clearer”.</p> <p><b>2D DNR/3D DNR:</b> Adjust the noise reduction level.</p> <p><b>Default:</b> Restore brightness, contrast and saturation to default settings.</p>



**[PTZ Control]**

PTZ Control allows you to use pan/tilt/zoom/preset/patrol function of PTZ, and set PTZ speed.

**Table 4. Description of the buttons**

No.	Parameter	Description
	 <p>PTZ Control</p>	<p>Navigation key is used to control the direction. The rotation key is used for auto-rotation.</p>
	 <p>PTZ Speed</p>	<p>To adjust the speed of pan/tilt movements, from 1 to 10.</p>
	 <p>Zoom-/Zoom+</p>	<p>Click to zoom in and zoom out.</p>
		<p><b>Auto Tracking:</b> With this option enabled, the camera can perform the digital Pan/Tilt/Zoom to track the moving objects automatically.</p> <p><b>Note:</b></p> <ul style="list-style-type: none"> <li>• Auto Tracking is only supported in <b>regional views</b>.</li> <li>• Auto Tracking is only supported in <b>ceiling mounting mode of hardware dewarping mode</b>.</li> </ul>
		<p>Enable to set the preset positions for each regional view channel.</p>
		<p>Enable to set the patrol paths for each regional view channel.</p>

## 6.1.2 Set / Call a Preset / Patrol

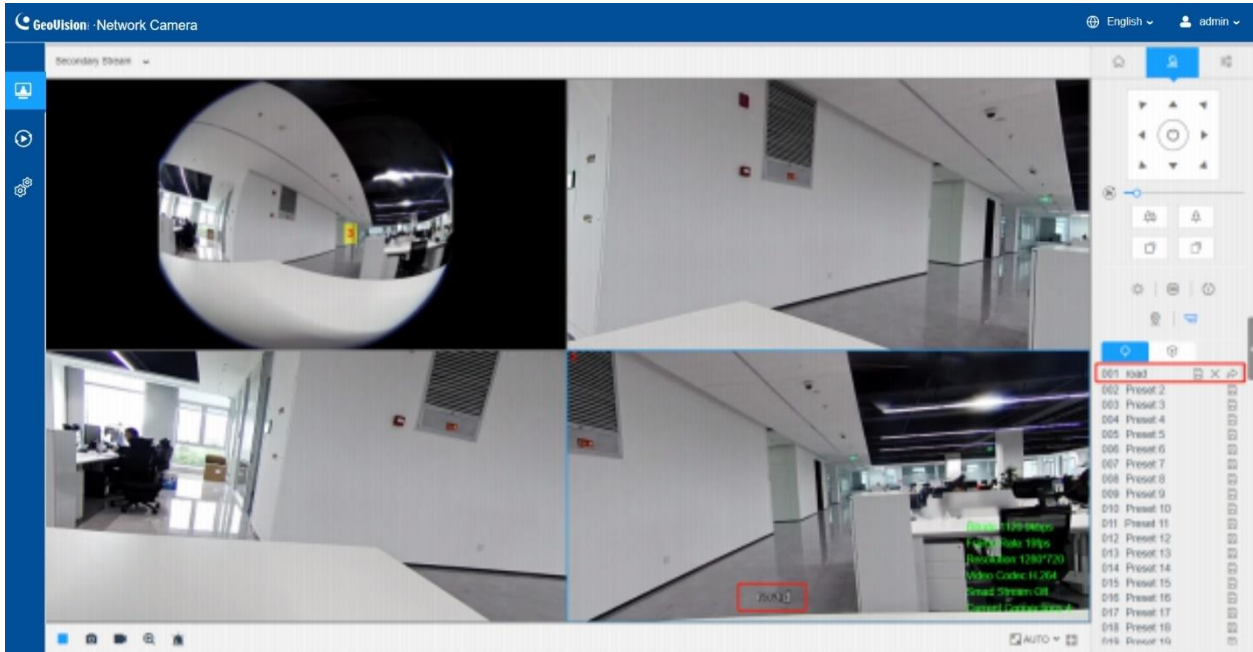
A preset is a predefined image position. You can click the call button from the preset list to quickly go to the desired image position.

### Set a preset:

**Note:** The Preset only can be set while the display is 4R.

**Step1:** In the PTZ control panel, select a preset number from the preset list, and you can also customize the preset name displayed on the screen. The patrol name displayed on the screen will also be customized if you customize preset name and set a patrol as shown below;






Path 1 + X ↑ ↓

	Preset	Speed	Time
01	1	30	15
02	2	30	15
03	3	30	15

Save Cancel



**Step2:** Use the PTZ control buttons to move the lens to the interested position;

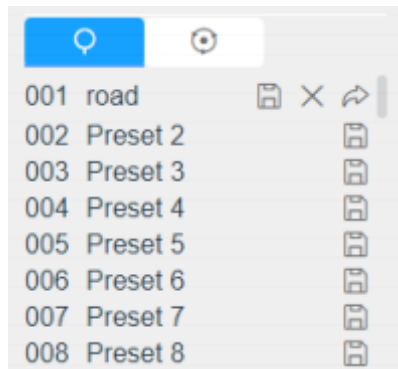
**Step3:** Click  to save the setting of the current preset;

**Step4:** Click  to delete the chosen preset.

**Note:** Up to 300 presets can be configured (18 presets are not modifiable). Up to 300 presets can be configured (for each regional view channel).

### Calling a preset:

Select a defined preset from the preset list and click  to call the preset.





## Set / Call a patrol

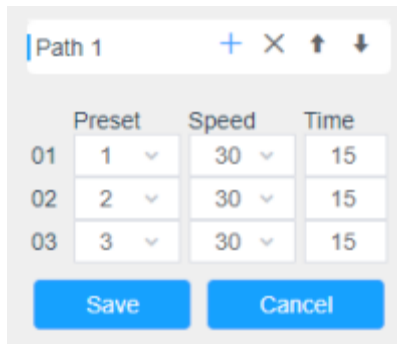
A patrol is a memorized series of preset function. It can be configured and called on the patrol setting list. You can customize up to 8 patrols and it can be configured with 48 presets. Before configuring the patrol, you should make sure that the presets you want to add to the patrol have been defined.

### Set a patrol:

**Step 1:** In the PTZ control panel, click  to enter the patrol settings interface;

**Step 2:** Select a patrol number, the setting icon will appear , click it;

**Step 3:** Click  to add presets to this patrol, as shown in the figure below;



	Preset	Speed	Time
01	1	30	15
02	2	30	15
03	3	30	15

Save Cancel

**Step 4:** Configure the preset number, patrol speed and patrol time;

**Table 5. Description of Patrol Settings**


Name	Description
Patrol Speed	The speed of moving from one preset to another.
Patrol Time	The duration staying on one patrol point. The PTZ camera moves to another patrol point after the set patrol time.

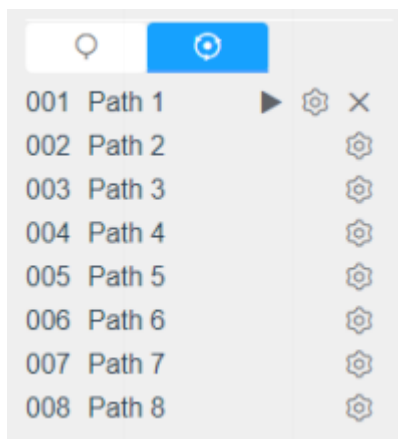
**Step 5:** Click  to save the patrol settings.

**Note:**

- Patrol Speed only works in Patrol mode.
- Patrol Time should be 15~120s for PTZ Bullet and 0~120s for Speed Dome.


**Call a patrol:**

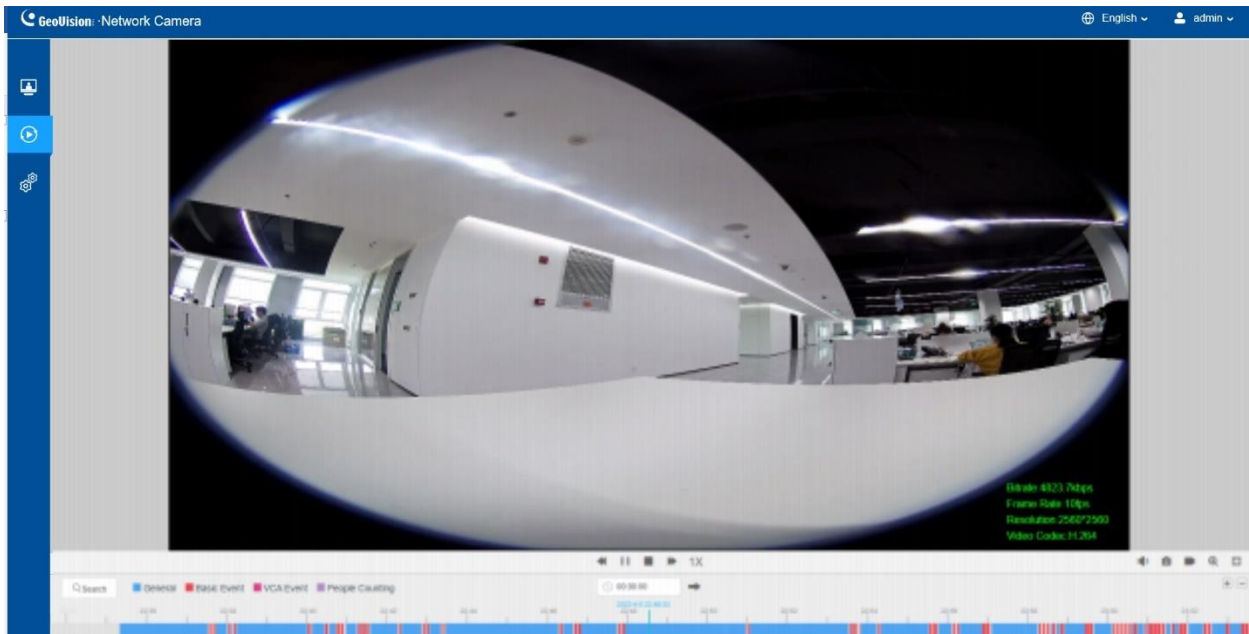
In the PTZ control panel, select a defined patrol from the patrol list, and click  to call the patrol, as shown below.



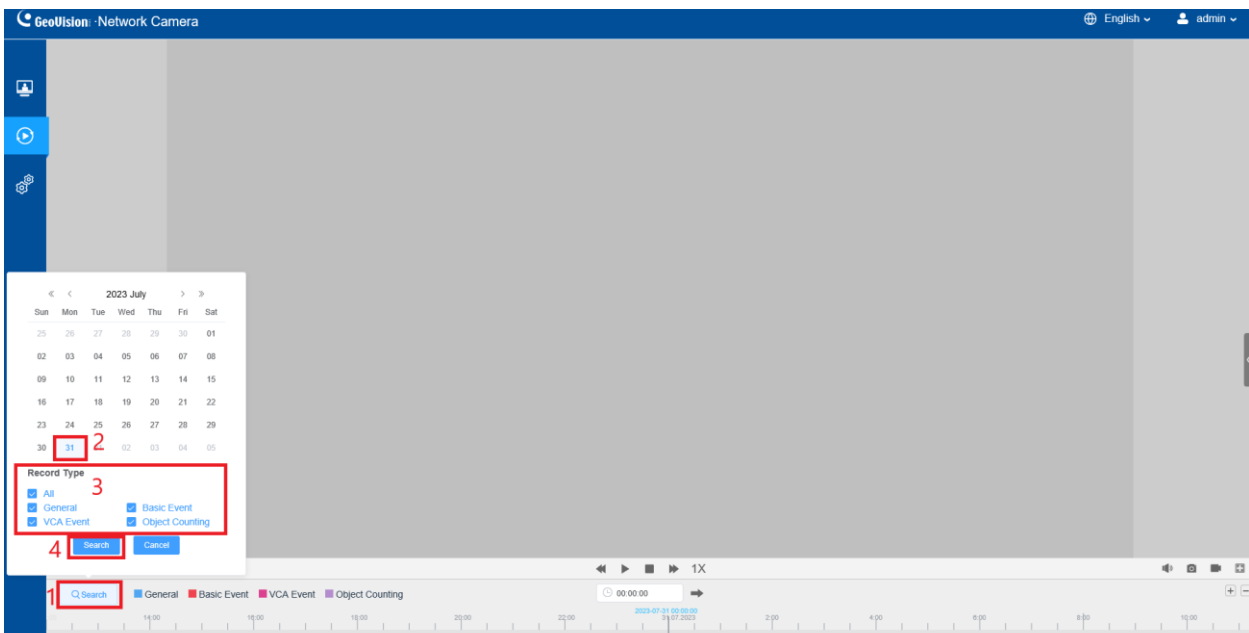
**Note:** The three buttons behind the Patrol list means: Play, Set and Delete.

# Chapter 7. Playback




Click  to enter playback interface. In this part, you can search and playback the recorded video files stored in SD cards or NAS. The Playback interface is as below:




**Step 1:** Click the “**Search**” button, choose the data and record type when the window pops up.

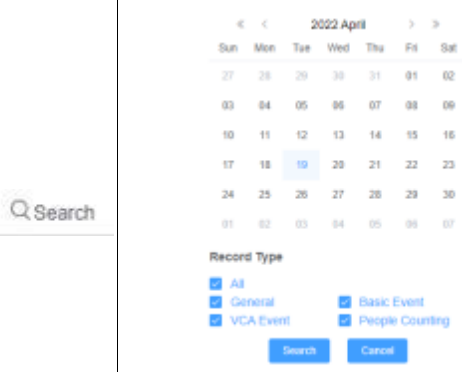







**Step 2:** The timeline displays the video files for the day and show different colors according to selected record type. Drag the progress bar with the mouse to locate the exact playback point as needed.


**Note:** You can also input the time and click  to locate the playback point in the  filed. You can also click   to zoom out/in the progress bar.

**Step:** Click  to play the video files found on this date. The toolbar on the button of playback interface can be used to control playing progress.







**Table 6. Description of the buttons**

No.	Parameter	Description
		<p>Choose date to search recorded videos.</p> <p>Search the recorded videos by record type (<b>All/General/Basic Event/VCA Event/People Counting</b>). The timeline will show different colors according to selected record type as below:</p> 
1	 Speed Down/Speed Up/Speed	<p>Adjust the speed of video playback.</p> <p><b>Speed Down:</b> Includes 0.5X and 0.25X for Play.</p> <p><b>Speed Up:</b> Includes 2X and 4X for Play.</p> <p><b>Speed:</b> The default playback speed is 1X</p>
2	 Play/Pause	<p>Play/Pause the video.</p>
3	 Stop	<p>Stop the video.</p>
4	 Search Time	<p>Select the time that want to locate.</p>

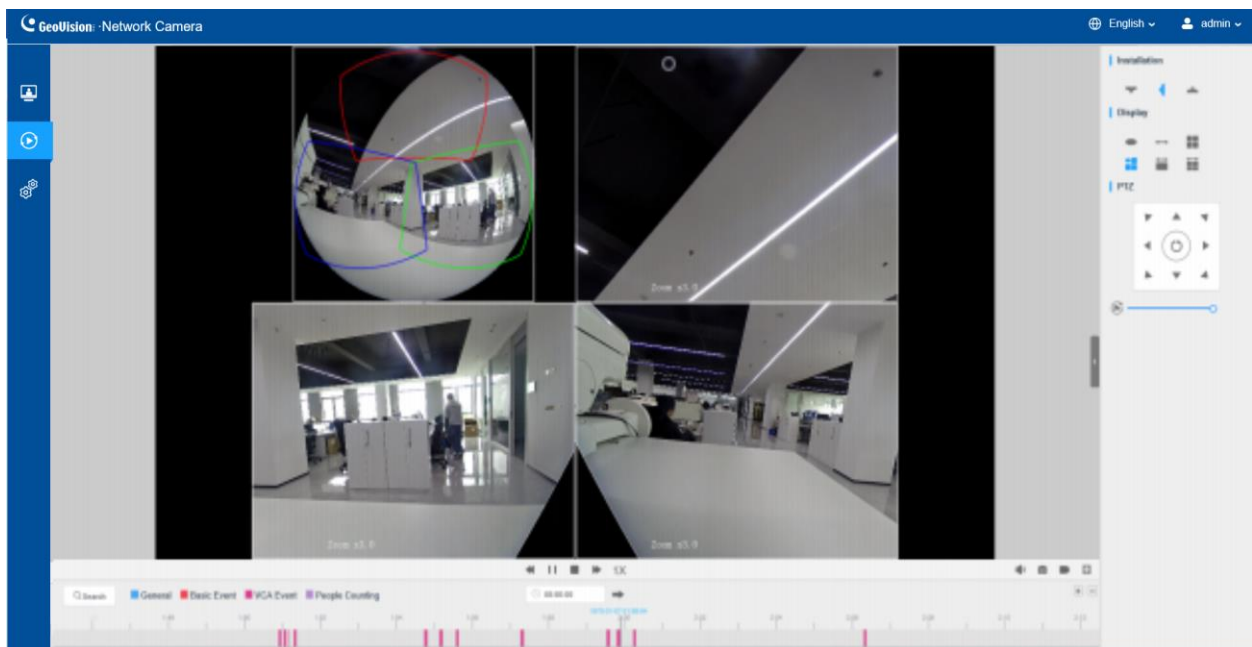
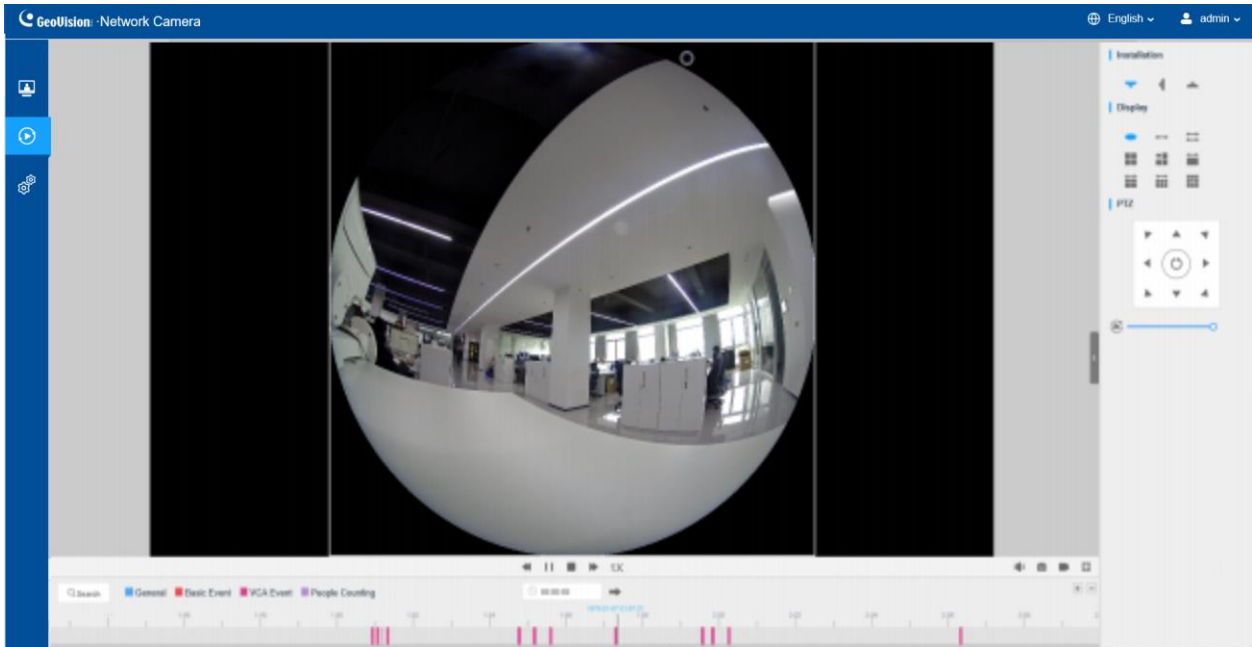


5	 Jump	Go To.
---	---	--------

**Table 7. Description of the buttons**

No.	Parameter	Description
1	 Mute	Click to enable the audio.
2	 Snapshot	Click to take a snapshot.
3	 Start/Stop recording	Click to start/stop recording.
4	 Digital Zoom	Click to zoom on/off.
5	 Full Screen	Full Screen.
6	 Time Expand/Narrow	Time narrow/expand.

**Step 4:** If the recording contains the original fisheye view (10), it supports client-side dewarping based on the original view in the playback interface. Click to play the video files, then you can select different installation modes and display modes as shown below. It also supports PTZ function for panoramic view and regional views.



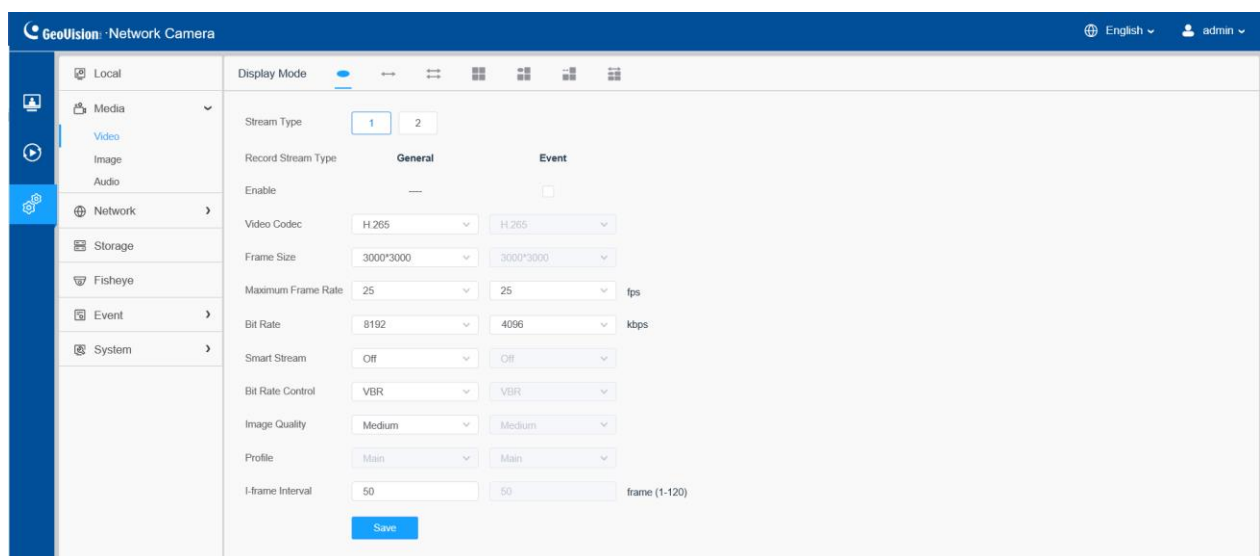
# Chapter 8. Settings

## 8.1 Media

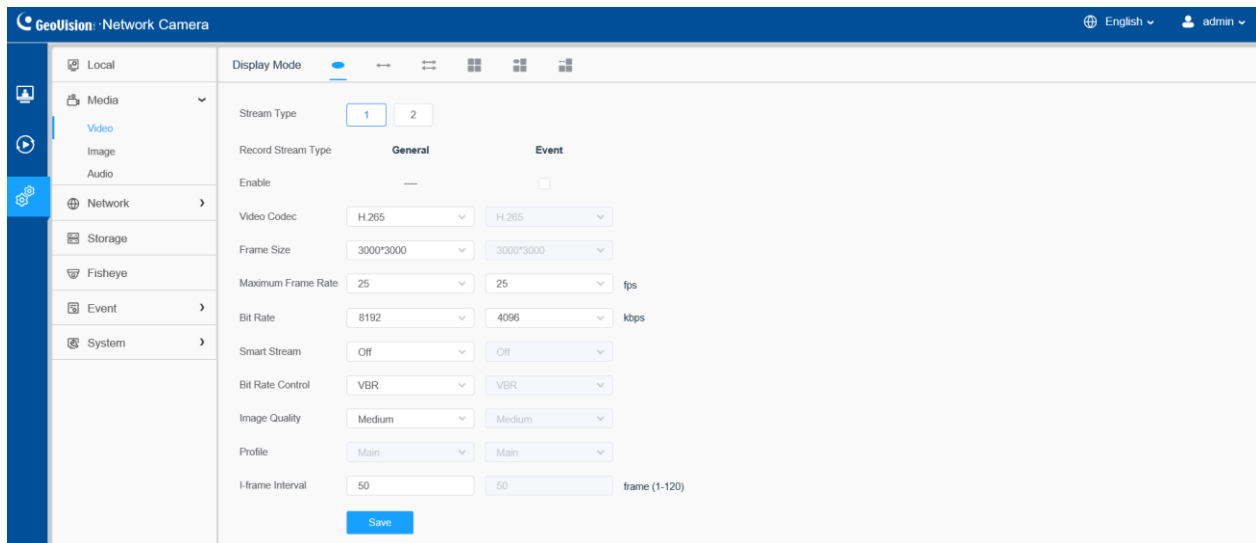
### 8.1.1 Video

Stream parameters can be set in this module, adapting to different network environments and demands.

*Multi-Channel Mode:*



*Bundle-Stream Mode:*



**Table 8. Description of the buttons**

Parameters	Function Introduction
<b>Channel</b> (Only for Multi-Channel Mode)	The number of channels is variable according to the selected display mode. 1O and 1P display one channel. 2P displays two channels. 4R, 1O3R and 1P3R display four channels. 1O1P3R displays five channels.
<b>Display Mode</b>	1O/1P/2P/4R/1O3R/1P3R are available
<b>Stream Type</b> (Only for Multi-Channel Mode)	Primary Stream/Secondary Stream are available.
<b>Record Stream Type</b>	<p><b>General &amp; Event</b> are available only for <b>Primary Stream</b>. <b>General</b> refers to continuous record video, while <b>Event</b> includes events that can trigger alarms, such as Motion, Exception, LPR and so on.</p> <p>This item can separately set different bit rate and frame rate for different Recording Stream Types. If user chooses <b>Event</b>, video will be recorded according to the configuration of video stream type when an event happens, thereby greatly reducing the recording storage space.</p>

Parameters	Function Introduction
------------	-----------------------

<b>Enable Event Stream</b>	This item is optional only if you selected the Event.
<b>Video Codec</b>	H.265/H.264 are available.
<b>Frame Size</b>	<p><b>For Multi-Channel Mode:</b></p> <p>4000*3000, 3000*3000, 2560*2560, 1920*1920, 1280*1280, 1280*960, 1024*1024, 720*720, 320*320 are available frame size for original fisheye view in 1O.</p> <p>2560*2560, 2560*640, 1920*1920, 1920*480, 1280*1280 are available frame size for original fisheye view in 1O3R and 1O1P3R.</p> <p>3000*752, 2560*, 2560*640, 1920*480, 1280*320, 960*240 are available frame size for 360° panoramic view in 1P, 1P3R and 1O1P3R.</p> <p>2560*640, 1920*480 are available frame size for 360° panoramic view in 1O1P3R.</p> <p>3000*1680, 2688*1520, 2592*1460, 1920*1080, 1280*720 are available frame size for two 180° panoramic views in 2P.</p> <p>1920*1080, 1280*720, 640*480 are available frame size for regional view.</p> <p><b>For Bundle-Stream Mode:</b></p> <p>4000*3000, 3000*3000, 2560*2560, 2592*1944, 1944*1944, 1920*1920, 1536*1536, 1280*1280 are available frame size for 1O.</p> <p>3000*752, 2592*648, 2560*640, 1920*480, 1280*320 are available frame size for 1P.</p> <p>3000*1680, 2688*1520, 2592*1460, 1920*1080, 1280*720 are available frame size for 2P.</p> <p>4000*3000, 3840*2160, 3072*1728, 2592*1944, 2304*1296 are available frame size for 4R, 1O3R and 1P3R.</p> <p><b>Note:</b> The camera supports up to 3000*3000 (12MP fisheye model) of Frame Size.</p>
<b>Maximum Frame Rate</b>	Maximum refresh frame rate of per second and it is variable according to the mode.

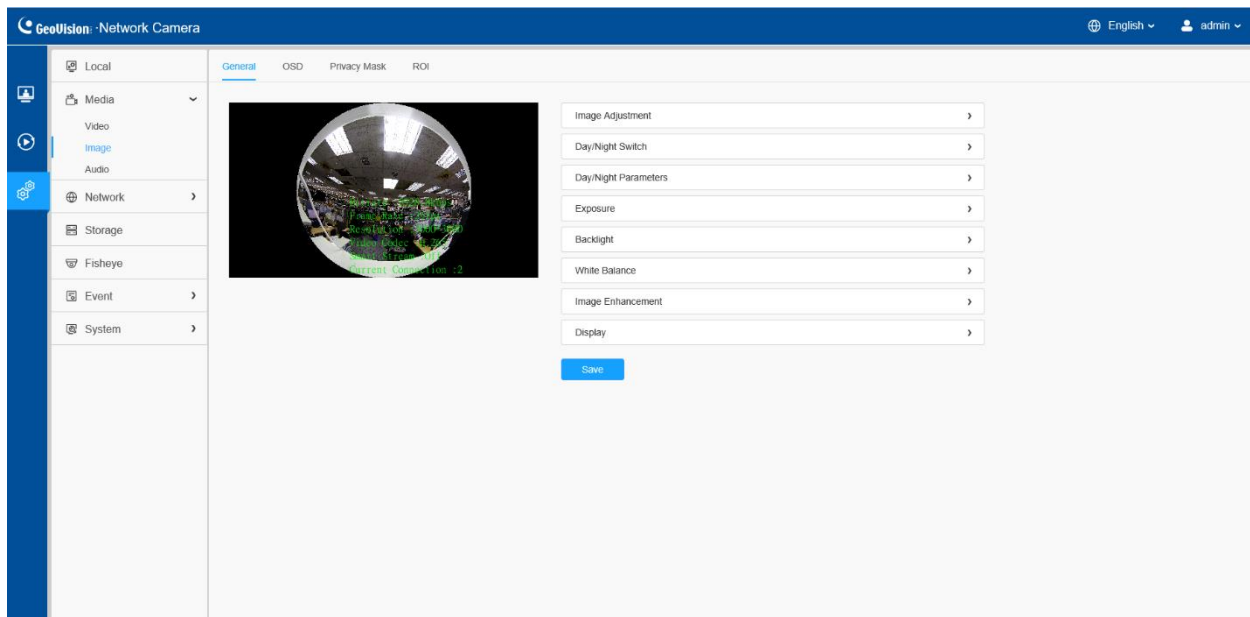
Parameter	Function Introduction
<b>Bit Rate</b>	<p>Transmitting bits of data per second, this item is optional only if you select the H.265/H.264</p> <p>Set the bitrate to 32~16384 Kbps. The higher value corresponds to the higher video quality, and the higher bandwidth is required as well.</p>
<b>Smart Stream</b>	<p>Optional to turn On/Off Smart Stream mode. Smart Stream mode remarkably reduces the bandwidth and the data storage requirements for network cameras while ensuring the high quality of images, and it is a 10-level adjustable codec.</p> <p><b>Level:</b> Level 1~10 is available as needed.</p>
<b>Bit Rate Control</b>	<p><b>CBR:</b> Constant Bitrate. The rate of CBR output is constant.</p> <p><b>VBR:</b> Variable Bitrate. VBR files vary the amount of output data per time segment.</p>
<b>Image Quality</b>	<p><b>Low/Medium/High</b> are available, this item is optional only if you select VBR.</p>
<b>Profile</b>	<p>The option is for H.264, Main/High/Base can be selected as needed.</p>
<b>I-frame Interval</b>	<p>Set the I-frame interval to 1~120, 50 for the default. This item is optional only if you select the H.265/H.264. The number must be a multiple of the number of frames.</p>

## 8.1.2 Image

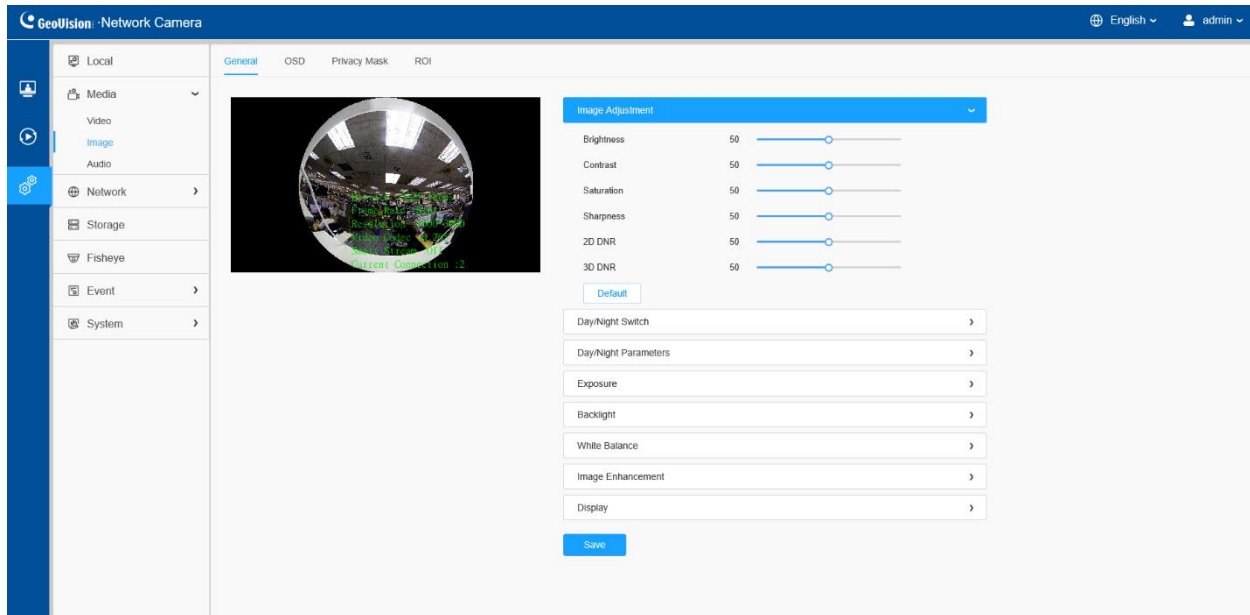
General settings of image including the image adjustment, day/night setting and image enhancement can be set in this module. OSD (On Screen Display) content, privacy mask and video time can be displayed to rich the image information.

### 8.1.2.1 General


General settings of image including the image adjustment, day/night switch, day/night parameters, exposure, backlight, white balance, image enhancement and Display can be set in this module.



## [Image Adjustment]

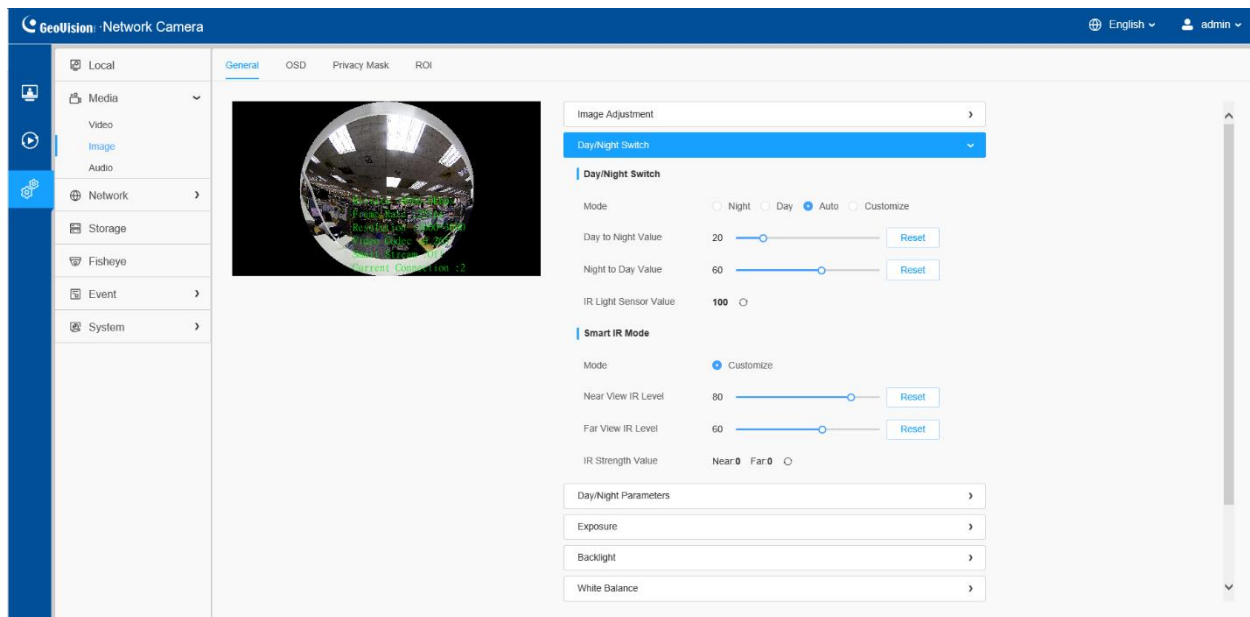


**Table 9. Description of the buttons**



Parameters	Function Introduction
<b>Brightness</b>	Adjust the Brightness of the scene.
<b>Contrast</b>	Adjust the color and light contrast.
<b>Saturation</b>	Adjust the Saturation of the image. Higher Saturation makes colors appear “purer” while lower one appears more “wash-out”.
<b>Sharpness</b>	Adjust the Sharpness of image. Higher Sharpness sharpens the pixel boundary and makes the image looks “clearer”.
<b>2D DNR</b>	Adjust the noise reduction level.
<b>3D DNR</b>	Restore brightness, contrast and saturation to default settings.
	Adjust the Brightness of the scene.




## [Day/Night Switch]

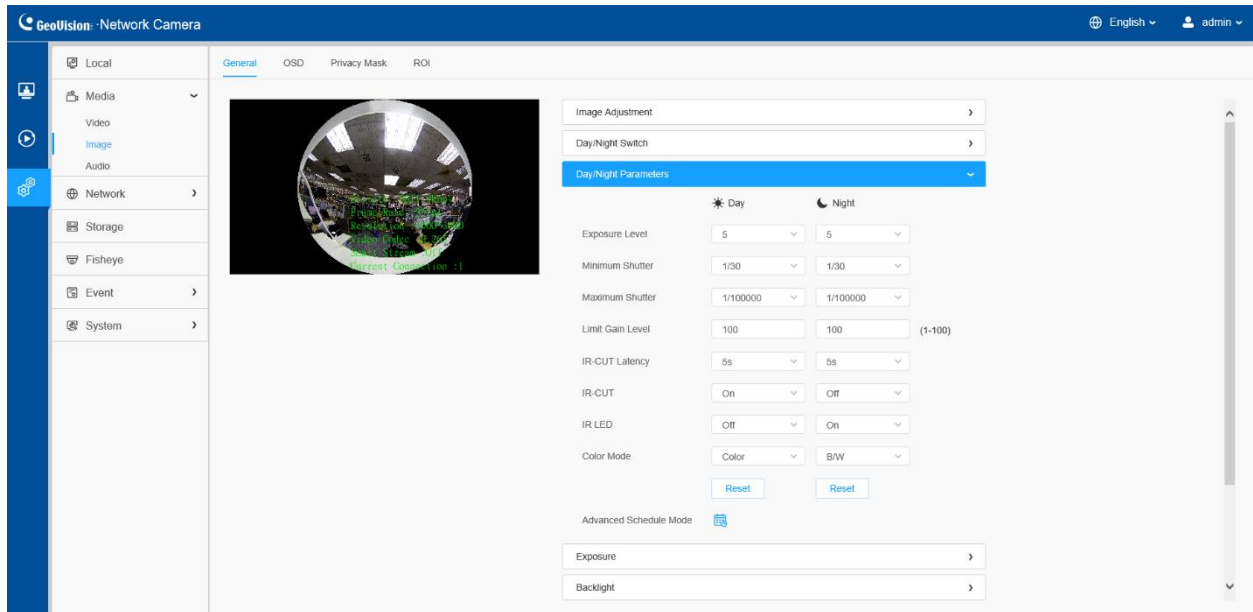


**Table 10. Description of the buttons**

Parameters	Function Introduction
Day/Night Switch	<p><b>Night Mode:</b> Shown in live view based on Night Mode settings.</p> <p><b>Day Mode:</b> Shown in live view based on Day Mode settings.</p>
Day/Night Switch	<p><b>Auto Mode:</b> Shown in live view based on environment, set the sensitivity for switching Day Mode to Night Mode, or Night Mode to Day Mode.</p> <p><b>Customize:</b> Shown in live view based on your own settings' time to start/end Night Mode.</p> <p><b>Note:</b> There are several parameters such as Exposure Level, Maximum Exposure Time and IR-CUT Interval, etc., associated with the modes.</p> <p><b>Day to Night Value:</b> You can set the sensitivity for switching Day Mode to Night Mode. When IR Light Sensor Current Value is lower than this value, it will switch Day Mode to Night Mode. You can click  to reset the value to 36.</p> <p><b>Night to Day Value:</b> This is the sensitivity for switching Night Mode to Day Mode. When IR Light Sensor Current Value is higher than this value, it will switch Night Mode to Day Mode. You can click  to reset the value to 82.</p> <p><b>IR Light Sensor Value:</b> The current value of the IR light sensor.</p>


	<p><b>Note:</b> The three buttons are optional only if you select Auto Mode.</p> <p><b>Start Time of Night:</b> You can set the time for start the Night Mode.</p> <p><b>End Time of Night:</b> You can set the time for start the Day Mode.</p> <p><b>Note:</b> Start/End Time of Night are optional only if you select Customize Mode.</p>
<b>Smart IR Mode</b>	<p>Support to set the strength of the IR to <b>Customize</b> to achieve the best effect.</p> <p><b>Near View IR Level:</b> Adjust the light strength of Low-Beams LED light level from 0 to 100.</p> <p><b>Far View IR Level:</b> Adjust the light strength of High-Beams LED light level from 0 to 100.</p> <p><b>Note:</b></p> <ul style="list-style-type: none"> <li>• Near/Far View IR Level are optional only if you select Customize Mode of Smart IR.</li> <li>• Click  to reset the light strength to 50.</li> </ul> <p><b>IR Strength Value:</b> The current value of Low-Beams LED and High-Beams LED light value.</p>

## [Day/Night Parameters]



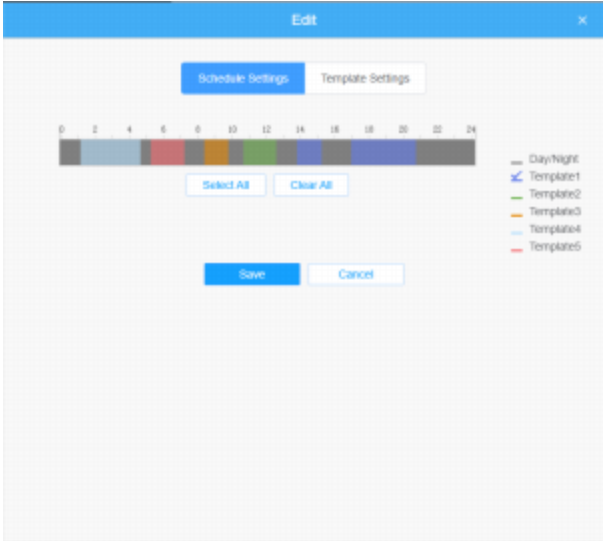
**Table 11. Description of the buttons**

Parameters	Function Introduction
<b>Exposure Level</b>	Level 0~10 is available to meet your need.
<b>Minimum Shutter</b>	Minimum Shutter is the same as Maximum Exposure Time. Set the minimum Shutter to 1~1/100000s.
<b>Maximum Shutter</b>	Maximum Shutter is the same as Minimum Exposure Time. Set the maximum Shutter to 1~1/100000s.
<b>IR-CUT Latency</b>	The interval time of switching one mode to another.
<b>Limit Gain Level</b>	Set the Limit Gain Level to 1~100.
<b>IR-CUT</b>	Turn on/off IR-CUT.
<b>IR LED</b>	Turn on/off IR-LED.
<b>Color Mode</b>	Select B/W or Color mode.

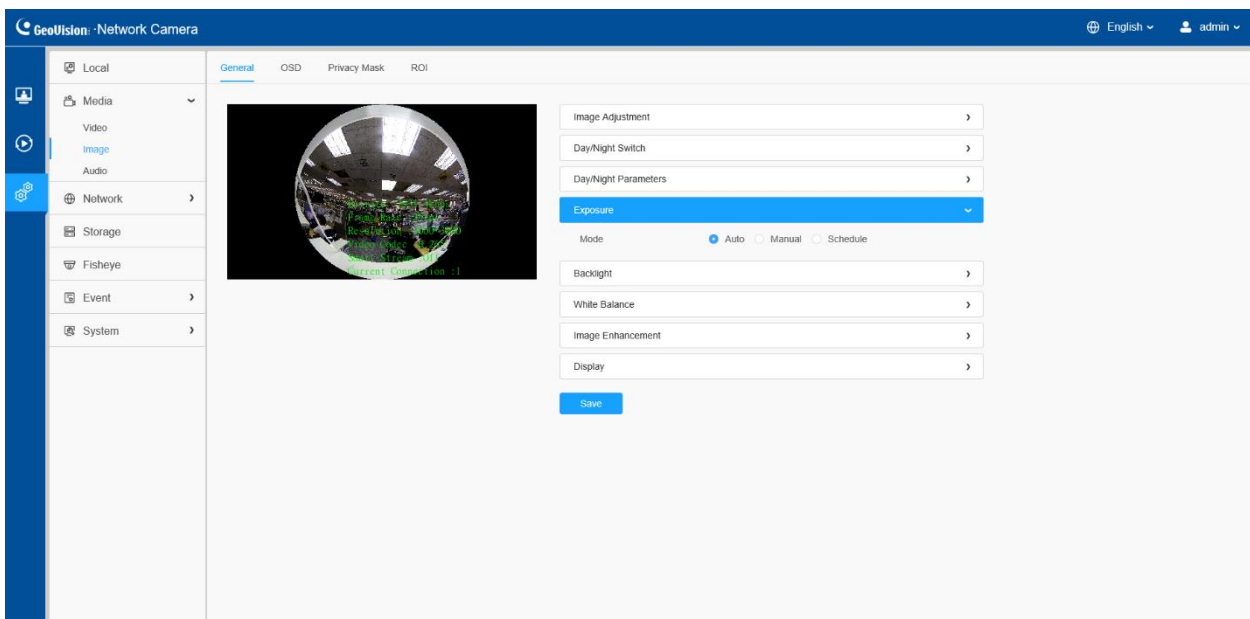


**Advanced Schedule Mode**

Here you can customize your special demands for different time, then the Day mode and Night mode will switch automatically according to your settings.



**[Exposure]**



**Table 12. Description of the buttons**

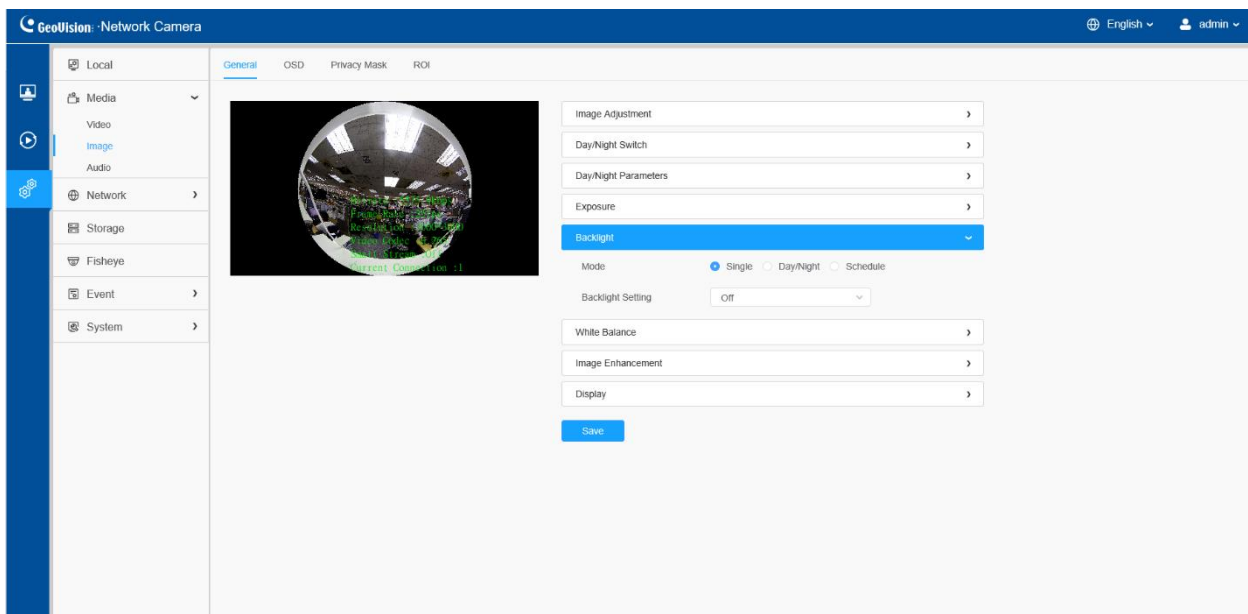
Parameters	Function Introduction
<b>Exposure Mode</b>	<p>Auto Mode, Manual Mode and Schedule Mode are available.</p> <p><b>Auto Mode:</b> The camera will adjust the brightness according to the light environment automatically.</p>

**Manual Mode:** The camera will adjust the brightness according to the value you set, you can set the exposure time from 1~1/100000s, the higher the value is, the brighter the image is.

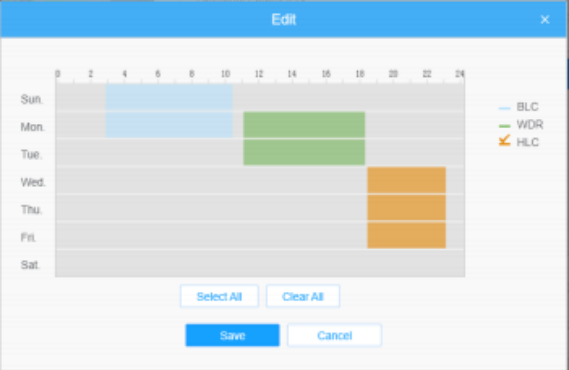
**Schedule Mode:** You can customize the schedule to enable/disable Auto Mode and Manual Mode.



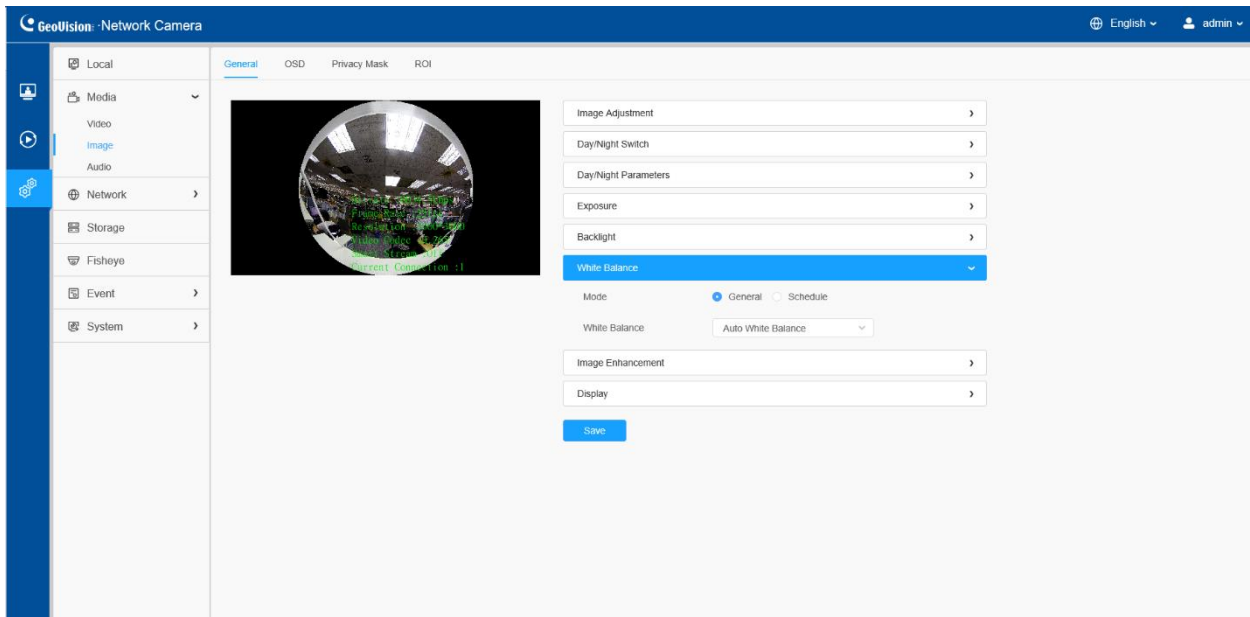
## [Backlight]



**Table 13. Description of the buttons**

Parameters	Function Introduction
<p><b>Backlight Mode</b></p>	<p><b>Single Mode:</b> Set single mode for BLC/WDR/HLC.</p> <p><b>Day/Night Mode:</b> Support BLC/WDR/HLC on Day Enhancement Mode/Night Enhancement Mode separately.</p> <p><b>Schedule Mode:</b> Set schedule mode for BLC/WDR/HLC. You can customize the schedule to enable/disable BLC/WDR/HLC mode.</p> 

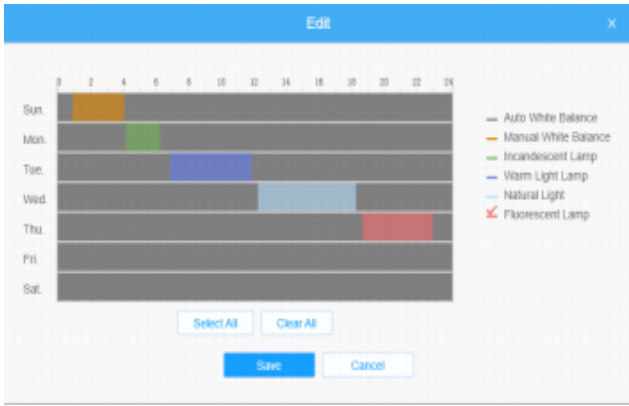
## [White Balance]



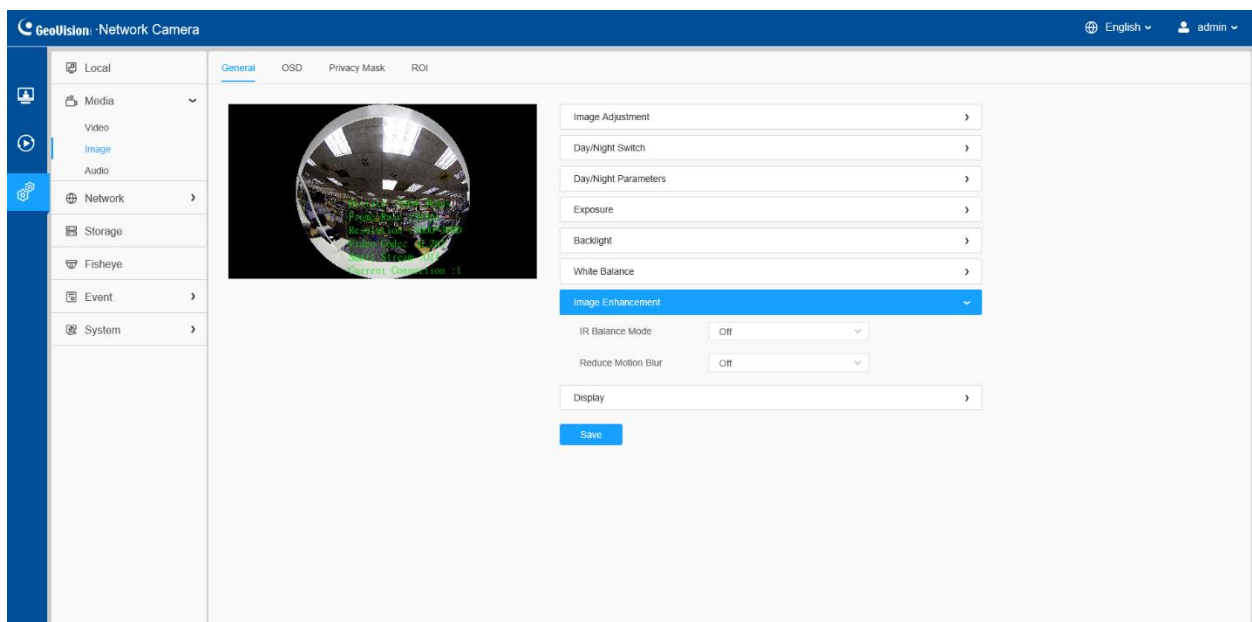
**Table 14. Description of the buttons**

Parameters	Function Introduction
<p style="text-align: center;"><b>White Balance</b></p>	<p>To restore white objects, removed color distortion caused by the light of the environment.</p> <p><b>Auto White Balance:</b> This option will automatically enable the White Balance function.</p> <p><b>Manual White Balance:</b> Set Red Gain Level and Blue Gain Level manually.</p> <p><b>Incandescent Lamp:</b> Select this option when light is similar with incandescent lamp.</p> <p><b>Warm Light Lamp:</b> Select this option when light is similar with warm light lamp.</p> <p><b>Natural Light:</b> Select this option when there is no other light but natural light.</p> <p><b>Fluorescent Lamp:</b> Select this option when light is similar with Fluorescent Lamp.</p>

**Schedule mode:** Select this option that you can customize the schedule to enable/ disable above modes.



**[Image Enhancement]**



**Table 15. Description of the buttons**

Parameters	Function Introduction
<b>IR Balance Mode</b>	There is an option to turn On/Off the IR LED. IR Balance Mode would avoid the problem of overexposure and darkness, and the IR LED will change according to the actual illumination.
<b>Reduce Motion Blur</b>	Enable this function to reduce the motion blur of objects effectively. You can adjust the deblur level from 1 to 100.



[Display]

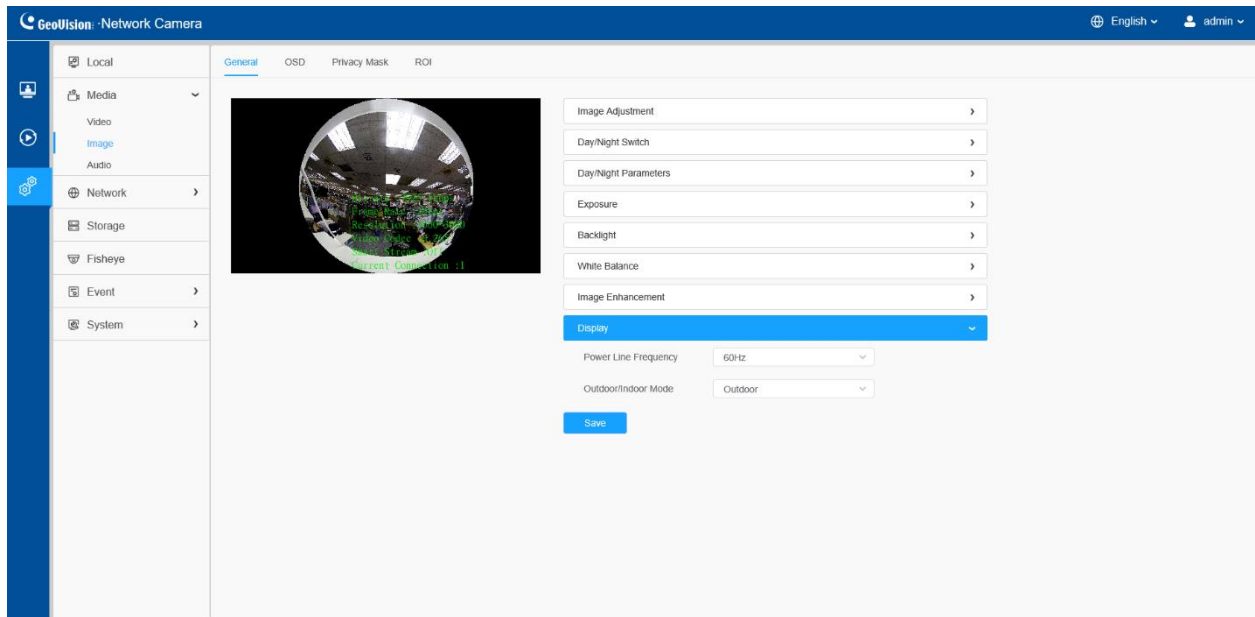
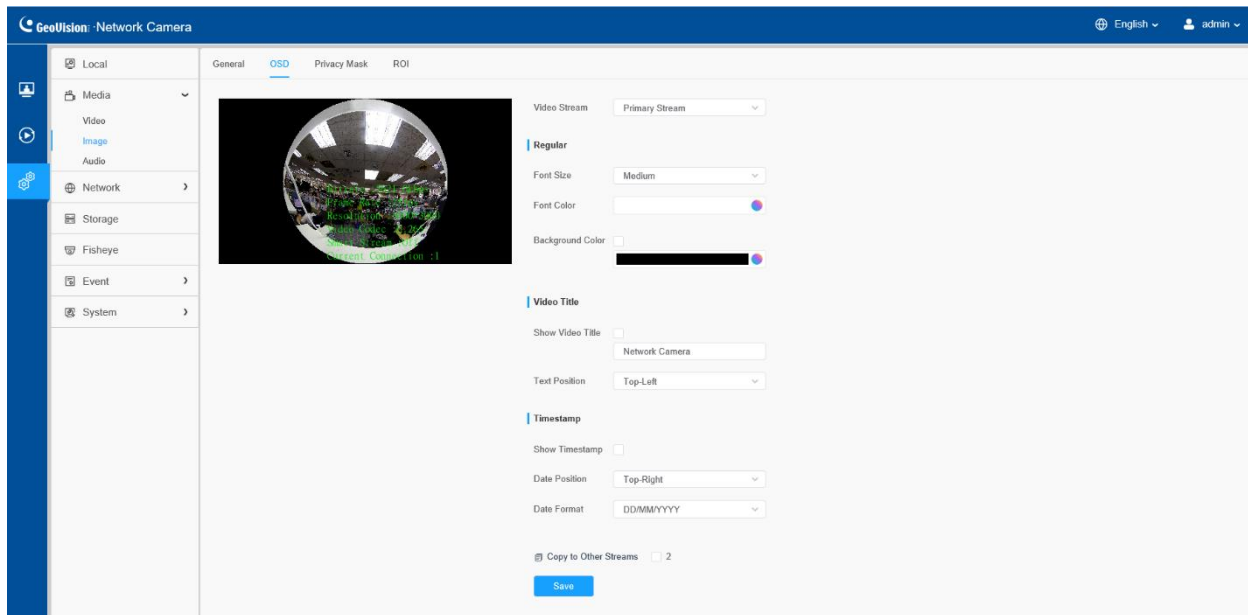


Table 16. Description of the buttons

Parameters	Function Introduction
<b>Power Line Frequency</b>	60Hz and 50Hz are available.
<b>Outdoor/Indoor Mode</b>	Select indoor or outdoor mode to meet your needs.

## 8.1.2.2 OSD



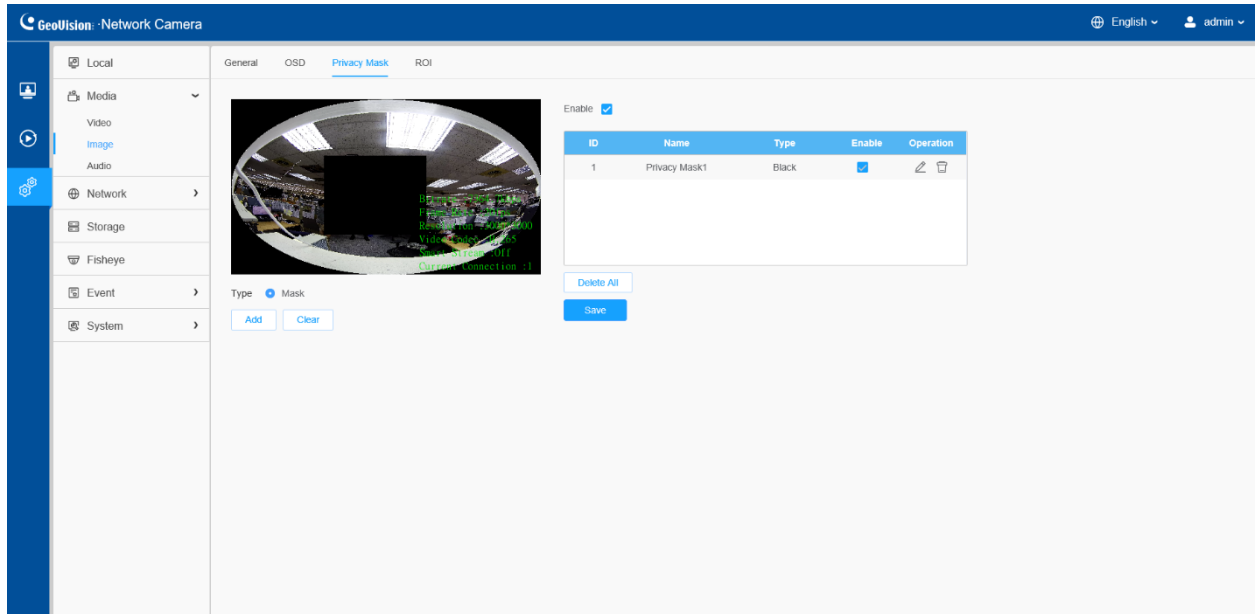
**Table 17. Description of the buttons**

Parameters	Function Introduction
<b>Video Stream</b>	Enable to set OSD for primary stream and secondary stream.
<b>Font Size</b>	Smallest/Small/Medium/Large/Largest/Auto are available for title and date.
<b>Font Color</b>	Enable to set different color for title and date.
<b>Background Color</b>	Enable to set different colors for display information background on screen. You can set different colors for font and background of image, then the image OSD will show as below:
<b>Show Video Title</b>	Check the check box to show video title.
<b>Video Title</b>	Customize the OSD content.
<b>Text Position</b>	OSD display position on the image.
<b>Show Timestamp</b>	Check the checkbox to display date on the image.
<b>Date Position</b>	Date display position on the image.
<b>Date Format</b>	The format of date.
<b>Copy to Other Streams</b>	Copy the settings to other streams.

### 8.1.2.3 Privacy Mask

Privacy mask enables to cover certain areas on the live video to prevent certain spots in the surveillance area from being viewed and recorded.

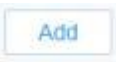

#### [Privacy Mask]



#### Note:

- For the fisheye model, it only supports black color for Privacy Mask.

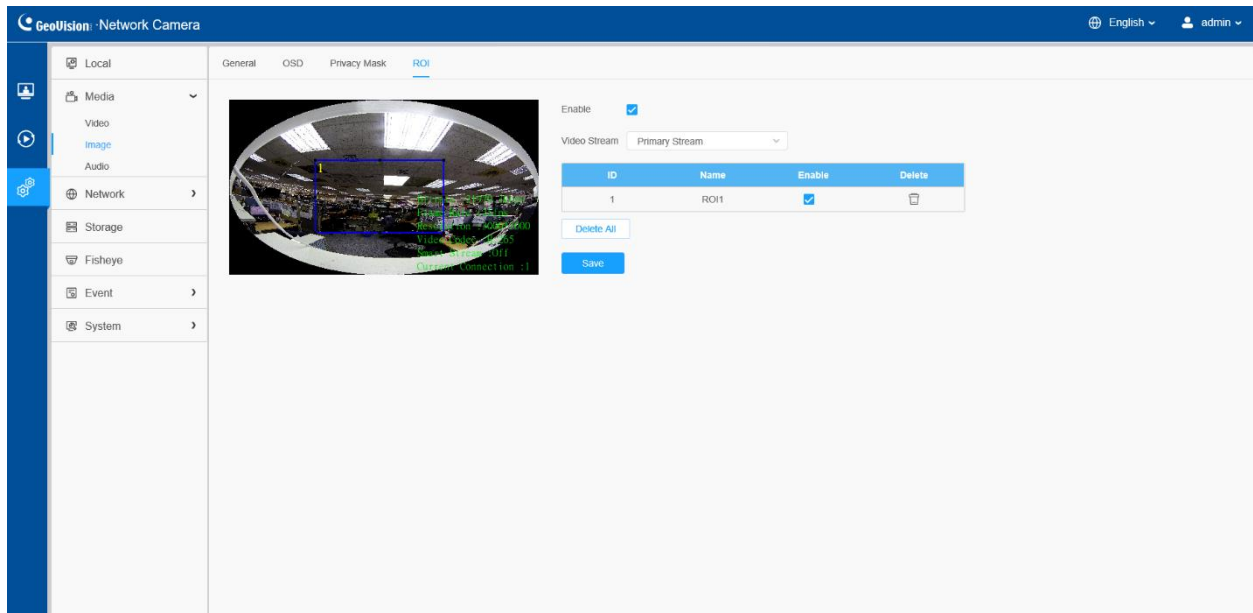
**Table 18. Description of the buttons**

Parameters	Function Introduction
<b>Enable</b>	Check the check box to enable the Privacy Mask function.
<b>Type</b>	Black mask type is available for fisheye camera.
	Drew a privacy area on the live video as needed.
	Clear the area you drew on the live video.
<b>Delete All</b>	Clear all areas you drew before.



### 8.1.2.4 ROI

Region of interest (often abbreviate ROI), is a selected subset of samples within a dataset identified for a particular purpose. Users can select up to 8 key regions of a scene to transmit through separate streams for targeted preview and recording.

By using ROI technology, more than 50% of bit rate can be saved and therefore less bandwidth demanded and the storage usage reduced. So according to this, you can set a small bit rate for high resolution.



**Table 19. Description of the buttons**

Parameters	Function Introduction	
<b>Enable</b>	Check the checkbox to enable the ROI function.	
<b>Video Stream</b>	Choose the Video Stream.	
<b>ROI</b>		Enable/disable the selected ROI areas.
		Delete the selected ROI areas.
<b>Delete All</b>	Clear all areas you drew before.	

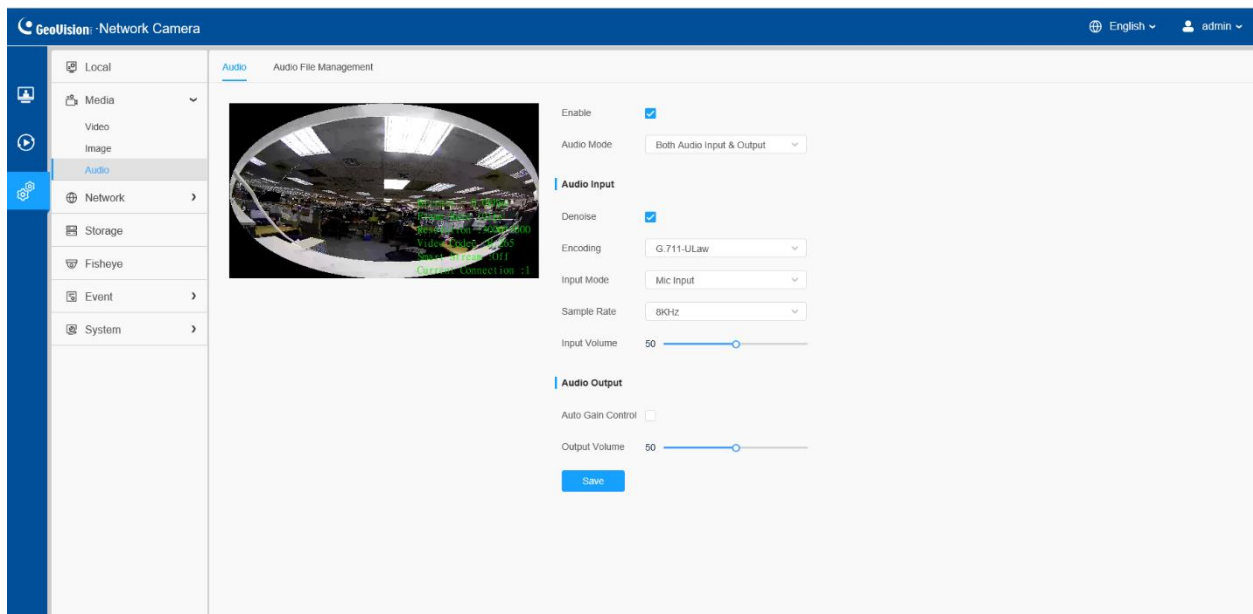
**Note:**

- You can set a low bit rate. For example, you can set a bit rate with 512 Kbps and a resolution with 1080P, then you can see the image quality of ROI is clearer and more fluent than the other region.
- ROI function will be disabled when the resolution of fisheye camera is 4K and above.

## 8.1.3 Audio

### 8.1.3.1 Audio

This audio function allows you to hear the sound from the camera or transmit your sound to the camera side. A two-way communication is also possible to be achieved with this feature. Alarm can be triggered when the audio input is above a certain alarm level you set, and configured audio can be played when an alarm occurs.

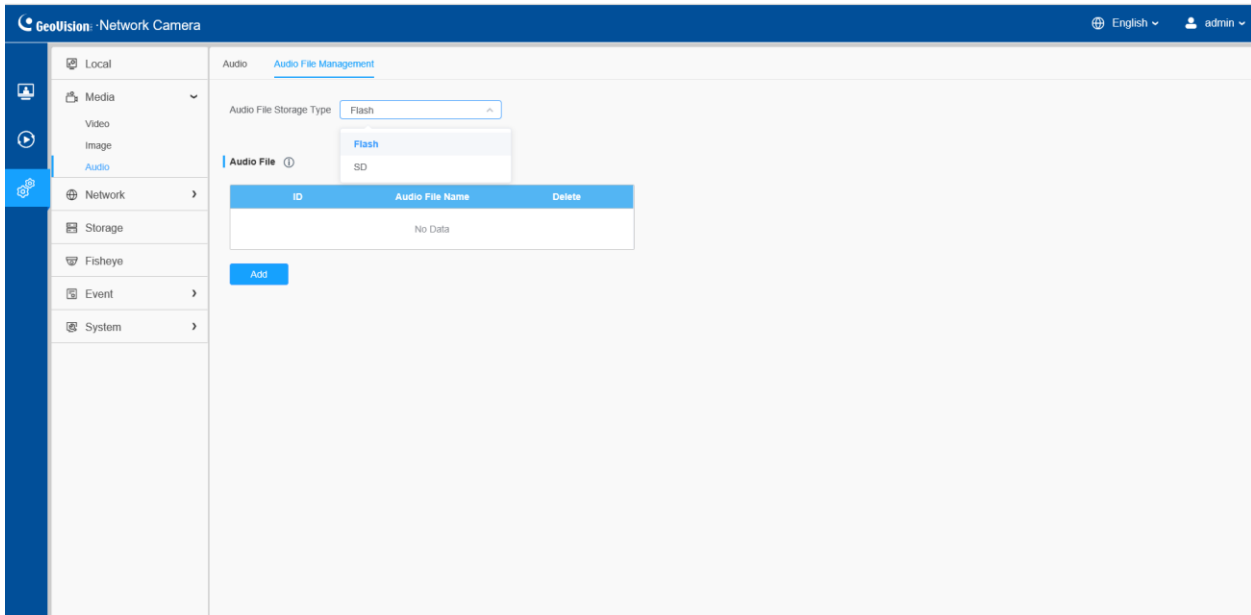


**Table 20. Description of the buttons**

Parameters	Function Introduction
<b>Enable</b>	Check on the checkbox to enable audio feature.
<b>Audio Mode</b>	<b>Audio Input/Audio Output/Both Audio Input &amp; Output</b> are optional.
<b>Audio Input</b>	<p><b>Denoise:</b> Set it as On/Off. When you set the function on, the noise detected can be filtered.</p> <p><b>Encoding:</b> G.711-ULaw and G.711-ALaw are available</p> <p><b>Sample Rate:</b> 8KHz, 16KHz, 32KHz, and 48KHz are available.</p> <p><b>Input Volume:</b> Input audio gain level, 0-100.</p>
<b>Audio Output</b>	<p><b>Auto Gain Control:</b> This function is only for H.265 series, improve the quality of audio.</p> <p><b>Output Volume:</b> Adjust volume of output.</p>

### 8.1.3.2 Auto File Management

You can upload up to 5 audio files manually to Flash or SD Card on the Audio web page and you can also edit the audio file's name when upload.



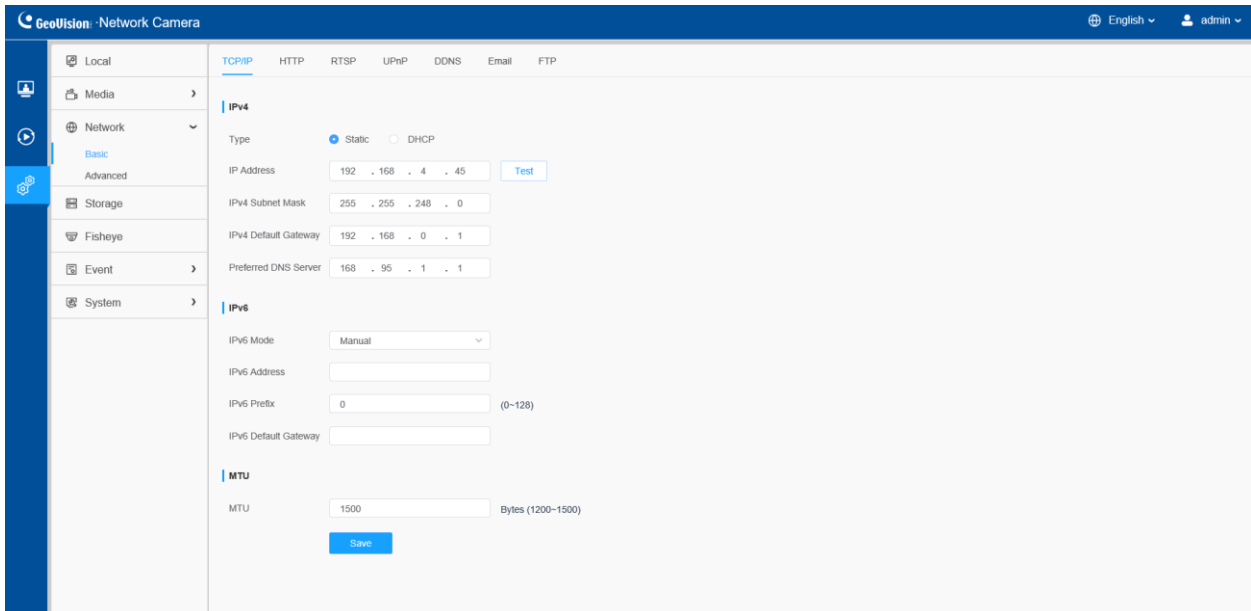
**Note:**

- Only support '.wav' audio files with codec type PCM/PCMU/PCMA, 64kbps or 128 kbps and no more than 500k.

## 8.2 Network

### 8.2.1 Basic


#### 8.2.1.1 TCP/IP



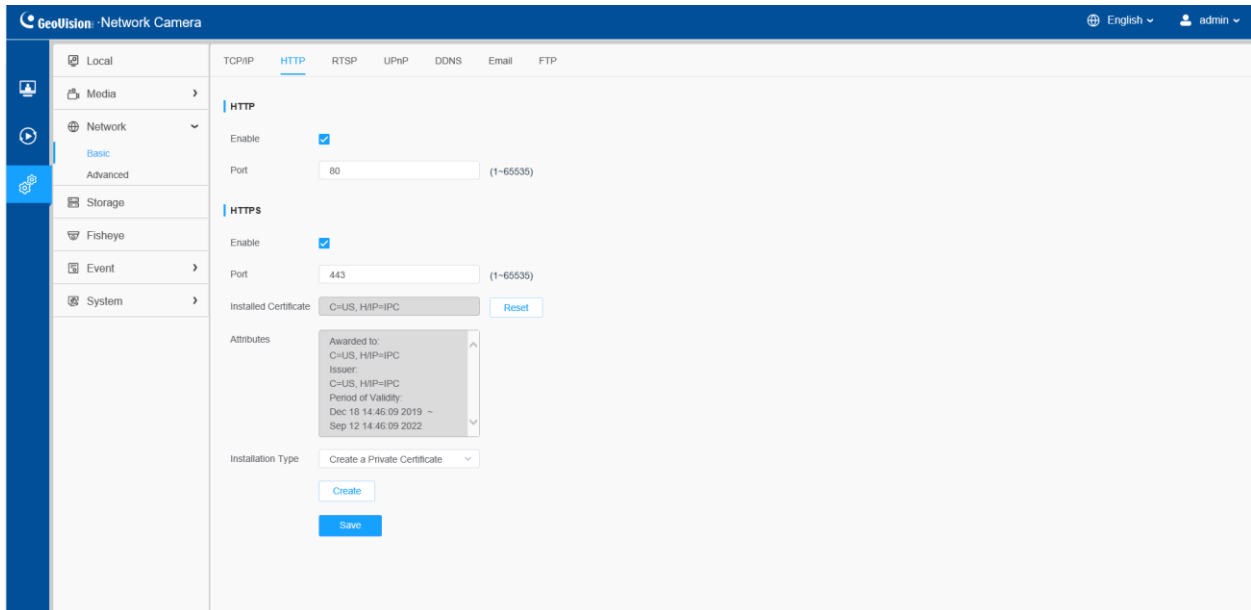
**Table 21. Description of the buttons**

Parameters	Function Introduction
<p><b>IPv4</b></p>	<p><b>Type:</b> Static Type and DHCP Type are optional for user to get IPv4 address automatically or use fixed IP address.</p> <p><b>IPv4 Address:</b> An address that used to identify a network camera on the network.</p> <p><b>Note:</b> The <b>Test</b> button is used to test if the IP is conflicting.</p> <p><b>IPv4 Subnet Mask:</b> It is used to identify the subnet where the network camera is located.</p> <p><b>IPv4 Default Gateway:</b> The default router address.</p> <p><b>Preferred DNS Server:</b> The DNS Server translates the domain name to IP address.</p>




<p><b>IPv6</b></p>	<p><b>IPv6 Mode:</b> Choose different modes for IPv6: Manual/Route Advertisement/ DHCPv6</p> <p><b>IPv6 Address:</b> IPv6 Address used to identify a network camera on the network</p> <p><b>IPv6 Prefix:</b> Define the prefix length of IPv6 address</p> <p><b>IPv6 Default Gateway:</b> The default router IPv6 address</p>
<p><b>MTU</b></p>	<p>Maximum Transmission Unit. The default value is 1500. You can customize the value from 1200 to 1500 as needed.</p>
<p></p>	<p>Save the configuration.</p>

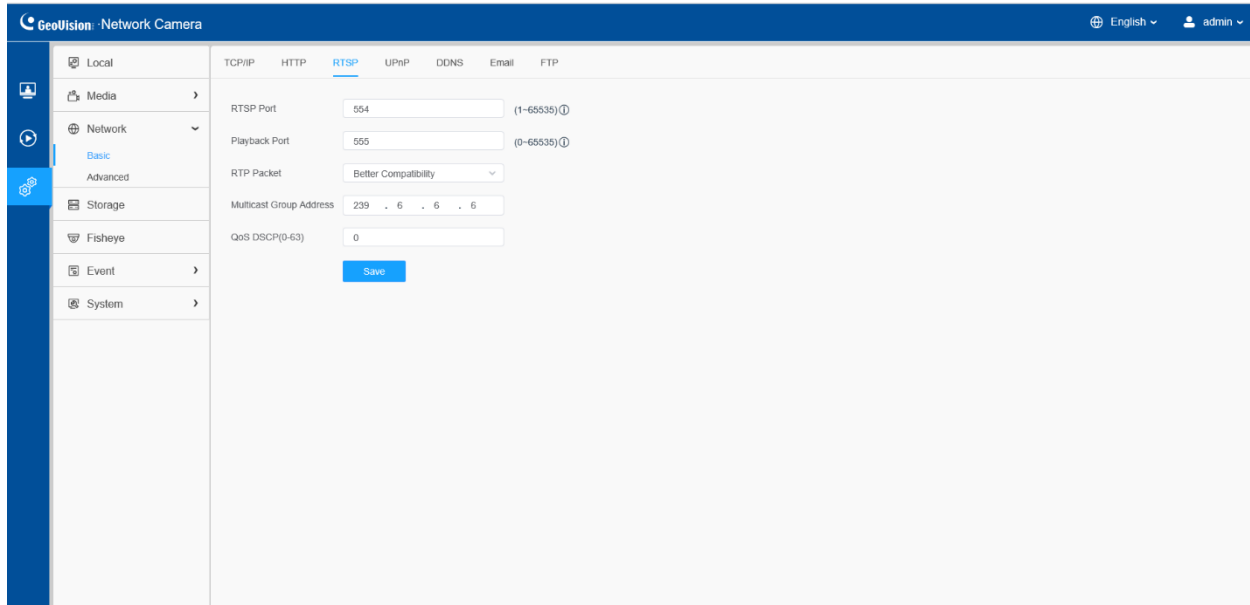
## 8.2.1.2 HTTP




**Table 22. Description of the buttons**

Parameters	Function Introduction
<b>HTTP</b>	<b>Enable:</b> Start or stop using HTTP. <b>Port:</b> Web GUI login port, the default is 80, the same with ONVIF port.
<b>HTTPSs</b>	<b>Enable:</b> Start or stop using HTTPSs. <b>Port:</b> Web GUI login port via HTTPS, the default is 443.
<b>Installed Certificate</b>	Upload and set the SSL certificate.
<b>Attributes</b>	
<b>Installation Type</b>	
	Save the configuration.

### 8.2.1.3 RTSP



**Table 23. Description of the buttons**

Parameters	Function Introduction
<b>RTSP Port</b>	The port of RTSP, the default is 554.
<b>Playback Port</b>	Playback Port The port of playback, the default is 555. <b>Note:</b> Port 0 means closing playback function.
<b>RTP Packet</b>	There are Better Compatibility and Better Performance two options, if your camera's image mess up, please switch this option.
<b>Multicast Group Address</b>	Support multicast function.
<b>QoS DSCP</b>	The valid value range of the DSCP is 0-63.
	Save the configuration.

**Table 24. RTSP URL are as below:**

Stream	URL
<b>Primary Stream</b>	rtsp://IP:RTSP Port/main
<b>Secondary Stream</b>	rtsp://IP:RTSP Port/sub
<b>Channel 01</b>	rtsp://IP:RTSP Port/main
<b>Channel 02</b>	rtsp://IP:RTSP Port/sub

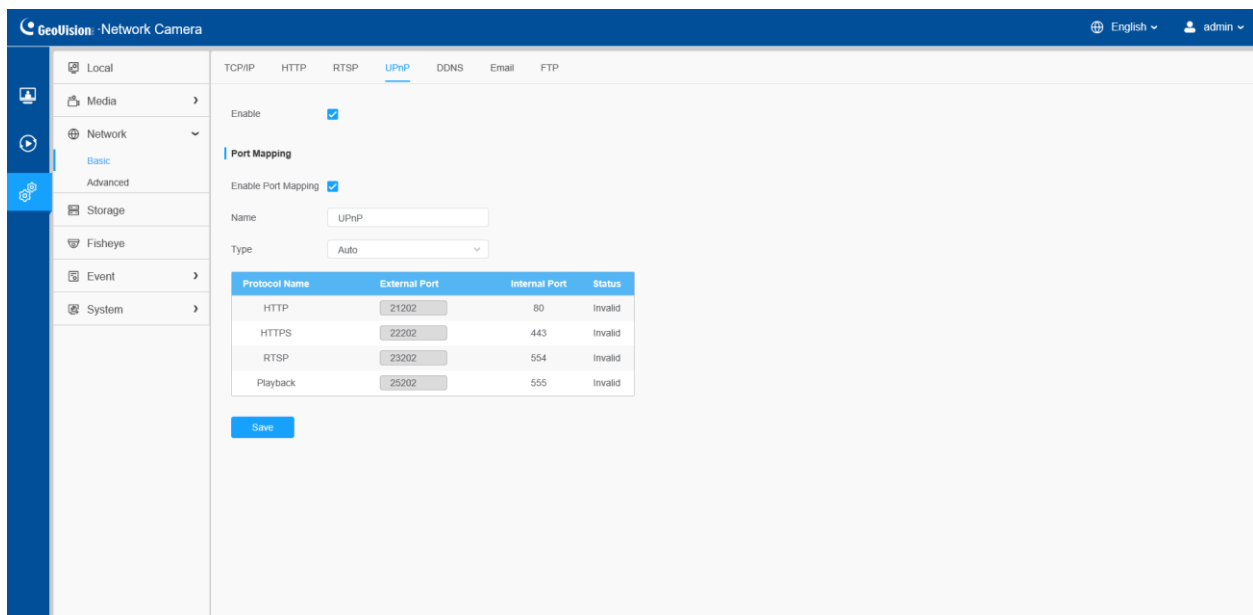
<b>Channel 03</b>	rtsp://IP:RTSP Port/third
<b>Channel 04</b>	rtsp://IP:RTSP Port/fourth
<b>Channel 05</b>	rtsp://IP:RTSP Port/fifth

**Note:**

- The RTSP URL for Primary Stream and Secondary Stream of fisheye camera is optional when transfer mode is bundle-stream mode.
- The RTSP URL for Channel 01/02/03/04/05 of fisheye camera is optional when transfer mode is multi-channel mode.
- DSCP refers to the Differentiated Service Code Point; and the DSCP value is used in the IP header to indicate the priority of the data.
- A reboot is required for the settings to take effect.


### 8.2.1.4 UPnP

Universal Plug and Play (UPnP) is a networking architecture that provides compatibility among networking equipment, software and other hardware devices. The UPnP protocol allows devices to connect seamlessly and to simplify the implementation of networks in the home and corporate environments. With the function enabled, you don't need to configure the port mapping for each port, and the camera is connected to the Wide Area Network via the router.



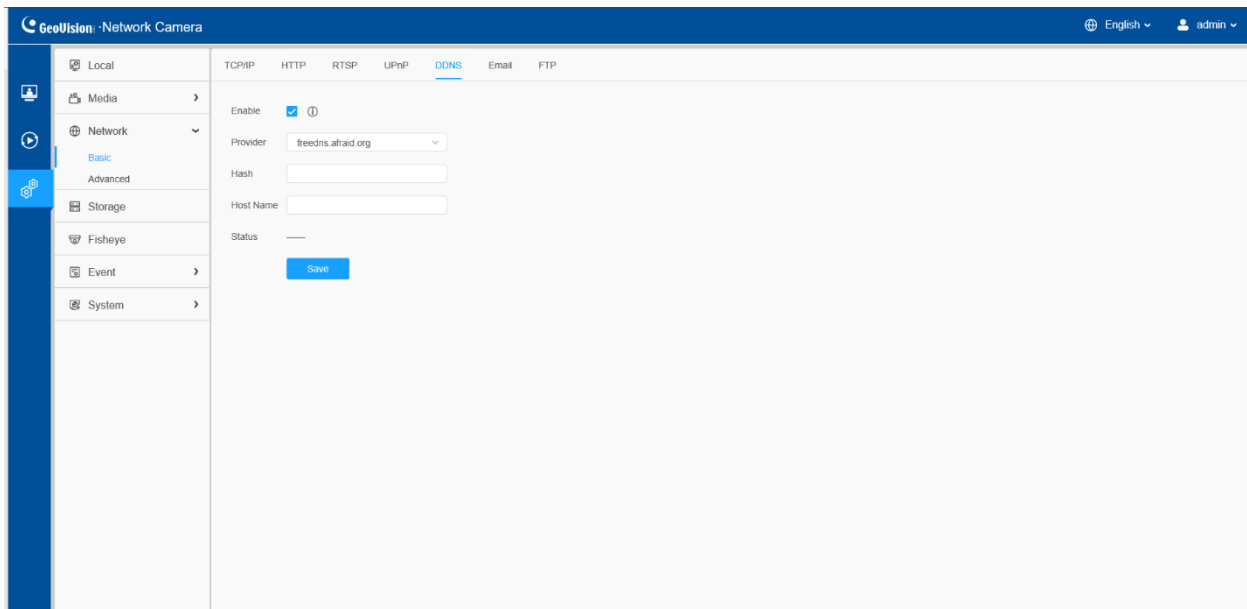
**Table 25. Description of the buttons**

Parameters	Function Introduction
<b>Enable</b>	Check the checkbox to enable the UPnP function.

<b>Enable Port Mapping</b>	Check the checkbox to enable the Port Mapping
<b>Name</b>	The name of the device detected online can be edited
<b>Type</b>	<b>Auto:</b> Automatically obtain the corresponding HTTP and RTSP port, without any settings <b>Manual:</b> Need to manually set the appropriate HTTP port and RTSP Port. When choose Manual, you can customize the value of the port number by yourself
	Save the configuration.


### 8.2.1.5 DDNS

DDNS allows you to access the camera via domain names instead of IP address. It manages to change IP address and update your domain information dynamically. You need to register an account from a provider.



**Table 26. Description of the buttons**

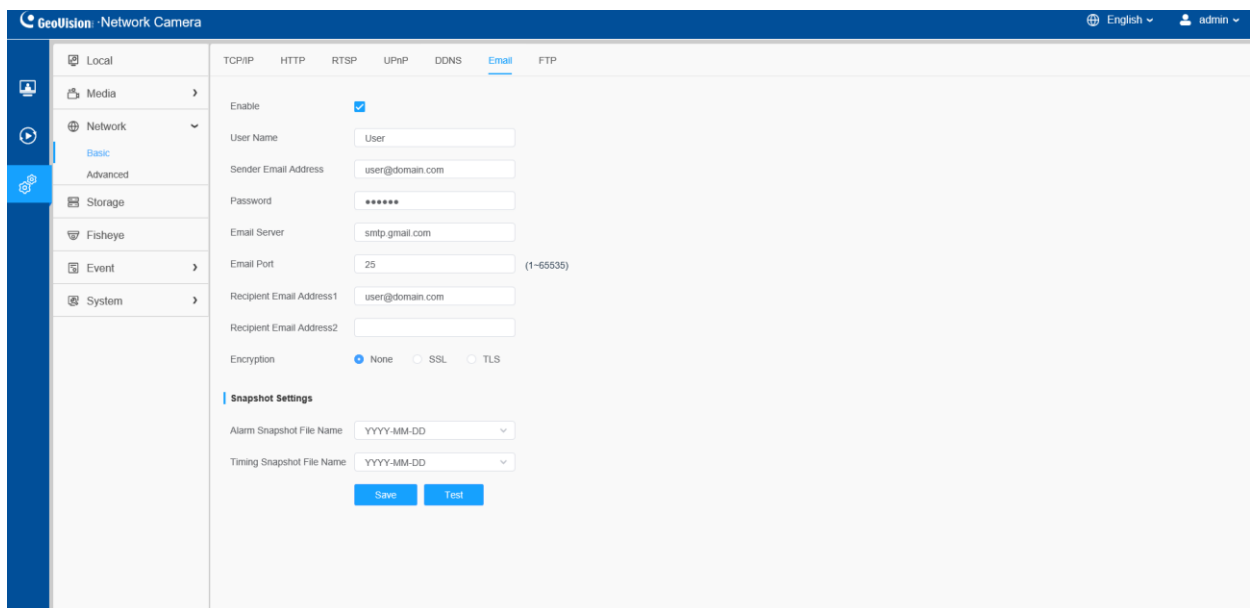
Parameters	Function Introduction
<b>Enable DDNS</b>	Check the checkbox to enable DDNS service. <b>Note:</b> Recommend to enable and configure UPnP ports which can be used directly in DDNS.
<b>Provider</b>	Get support from DDNS provider: freedns.afraid.org, dyndns.org, www.no-ip.com, www.zoneedit.com. You can also customize the provider for DDNS.
<b>Hash</b>	A string used for verifying, only for "freedns.afraid.org".
<b>User name</b>	Account name from the DDNS provider, unavailable for "freedns.afraid.org".

Parameters	Function Introduction
<b>Password</b>	Account password, unavailable for "freedns.afraid.org".
<b>Host name</b>	DDNS name enabled in the account.
<b>Status</b>	Display DDNS running status.
	Save the configuration.

**Note:** Make sure that the internal and the external port number of RTSP are the same.



### 8.2.1.6 Email

Alarm video files can be sent to specific mail account through SMTP server. You must configure the email settings correctly before using it.



**Table 27. Description of the buttons**

Parameters	Function Introduction
<b>Enable</b>	Check the checkbox to enable Email function.
<b>User Name</b>	The sender's name. It is usually the same as the account name.
<b>Sender Email Address</b>	Email address to send video files attached emails.
<b>Password</b>	The password of the sender.

<b>Email Server</b>	The email server IP address or host name (e.g., smtp.gmail.com).
<b>Email Port</b>	The default TCP/IP port for SMTP is 25 (not secured). For SSL/TLS port, it depends on the mail you use.
<b>Recipient Email Address1</b>	Email address to receive video files.
<b>Recipient Email Address2</b>	Email address to receive video files.
<b>Encryption</b>	Check the checkbox to enable SSL or TLS if it is required by the SMTP server.
<b>Snapshot Settings</b>	<p><b>Alarm Snapshot File Name:</b> Default (YYYY-MM-DD) /MM-DD-YYYY/ DD- MM-YYYY/ Add prefix/ Overwrite with the base file name/ Customize are available.</p> <p><b>Timing Snapshot File Name:</b> Default (YYYY-MM-DD) /MM-DD-YYYY/ DD- MM-YYYY/ Add prefix/ Overwrite with the base file name/ Customize are available.</p>
	Save the configuration.
	Test whether the configuration is successful.

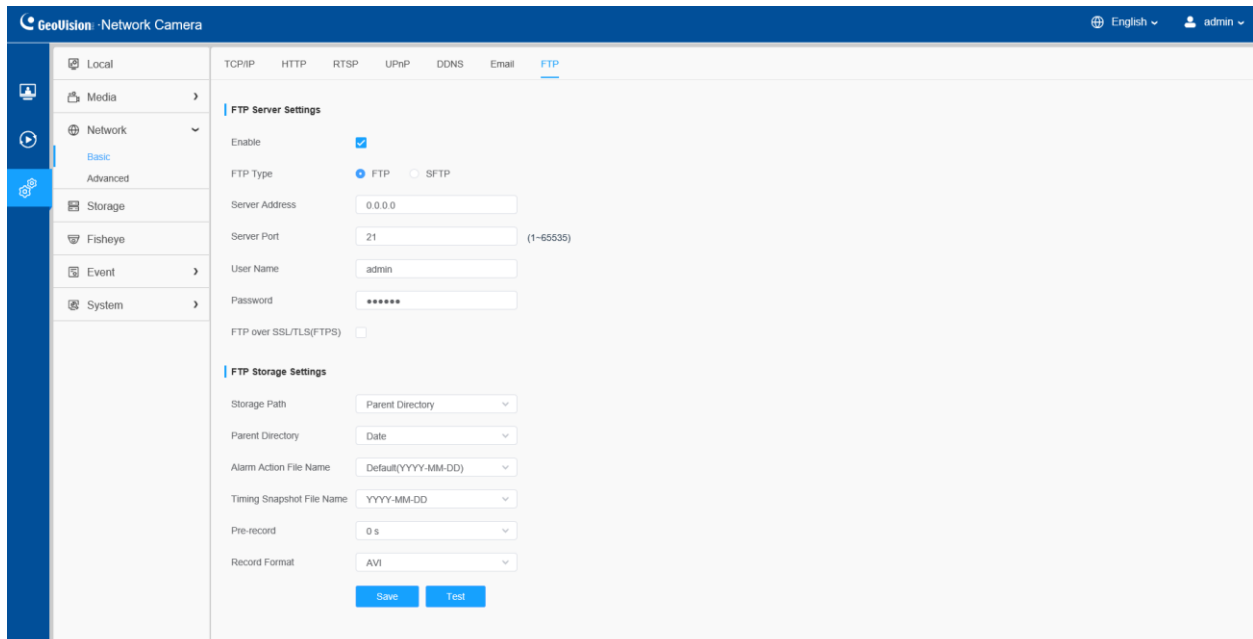
**Note:** You can refer to the following file name tip to customize the file name.

File Name Tip  
 &Device - Device Name  
 &Y - Year  
 &M - Month  
 &D - Day  
 &h - hour  
 &m - minute  
 &s - second  
 &ms - millisecond  
 && - &





## 8.2.1.7 FTP

Alarm video files can be sent to specific FTP server. You must configure the FTP settings correctly before using it.



**Table 28. Description of the buttons**

Parameters		Function Introduction
<b>FTP Server Settings</b>	<b>FTP Type</b>	FTP and SFTP are optional.
	<b>Server Address</b>	FTP/SFTP server address.
	<b>Server Port</b>	The port of the FTP server. Generally, it is 21. The port of the SFTP server. Generally, it is 22.
	<b>User Name</b>	User name used to log in to the FTP/SFTP sever.
	<b>Password</b>	User password.
<b>FTP Storage Settings</b>	<b>Storage Path</b>	Storage Path where video and image will be uploaded to the FTP server. Four FTP storage path types are available, including Root Directory, Parent Directory, Child Directory and Customize.
<b>FTP Storage Settings</b>	<b>Parent Directory</b>	Choose IP Address/ Device Name/ Date as the folder name of Parent Directory, or customize the folder name.

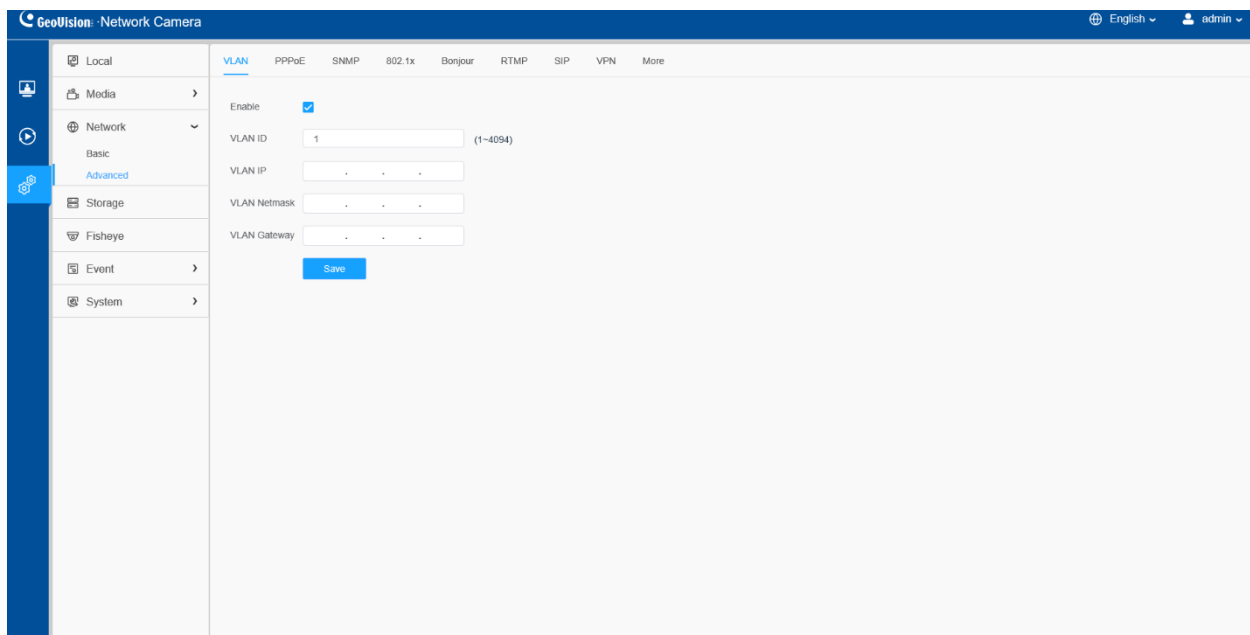
	<b>Child Directory</b>	Choose IP Address/ Device Name/ Date as the folder name of Child Directory, or customize the folder name.
	<b>Multilevel Folder Name</b>	If the storage path is more than two levels, enter Multilevel FTP storage path here manually.
	<b>Alarm Action File Name</b>	Choose the default (YYYY-MM-DD) or customize the alarm action file name.
	<b>Video File Name</b>	If you choose to customize the alarm action file name, YYYY-MM- DD/ MM-DD-YYYY/ DD-MM-YYYY/ Add prefix are available.
	<b>Image File Name</b>	If you choose to customize the alarm action file name, YYYY-MM- DD/ MM-DD-YYYY/ DD-MM-YYYY/ Add prefix are available.
	<b>Timing Snapshot File Name</b>	Default (YYYY-MM-DD) /MM-DD-YYYY/ DD-MM-YYYY/ Add prefix/ Overwrite with the base file name are available.
	<b>Pre Second</b>	Reserve the record time before alarm, 0~10 sec.
	<b>Record Format</b>	Choose <b>AVI / MP4</b> as the default record file format.
		Save the configuration, 0s ~ 10s are optional.
		Test whether the configuration is successful.

**Note:** Parent Directory will be under Root Directory, and Child Directory will be under Parent Directory.

## 8.2.2 Advanced

### 8.2.2.1 VLAN

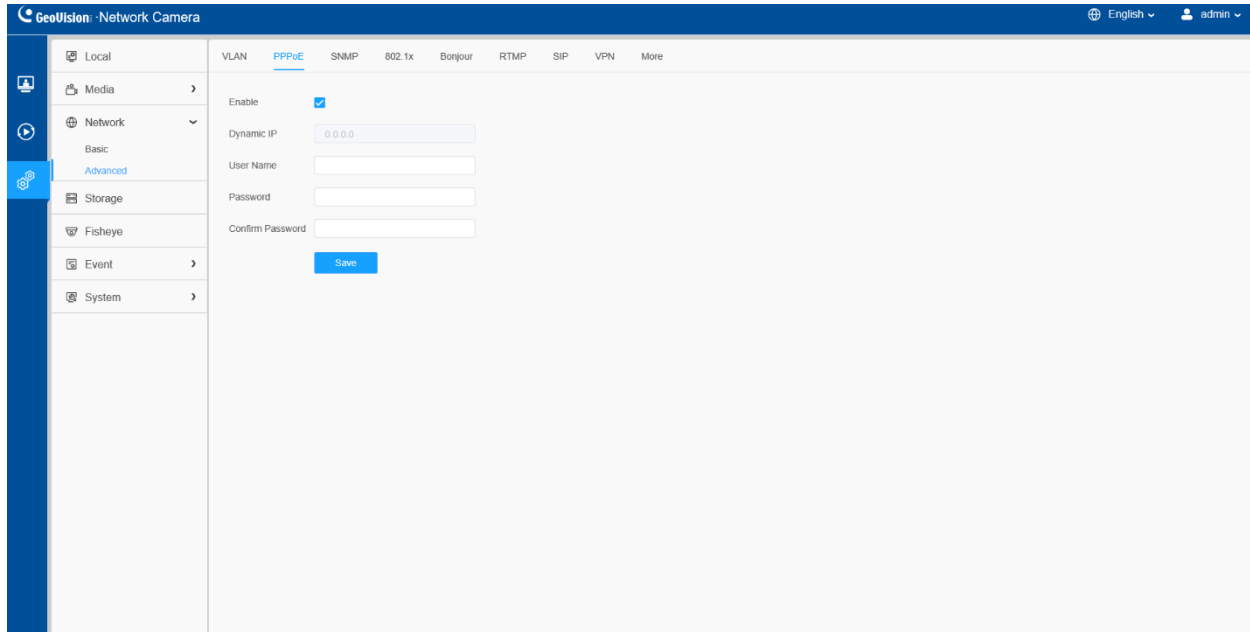
A virtual LAN (VLAN) is any broadcast domain that is partitioned and isolated in a computer network at the data link layer (OSI layer 2). LAN is an abbreviation of local area network. VLANs allow network administrators to group hosts together even if the hosts are not on the same network switch. This can greatly simplify network design and deployment, because VLAN membership can be configured through software. Without VLANs, grouping hosts according to their resource needs necessitates the labor of relocating nodes or rewiring data links.



**Note:** About how to set up VLAN in switches, please refer to your switch user manual.

### 8.2.2.2 PPPoE

This camera supports the PPPoE auto dial-up function. The camera gets a public IP address by ADSL dial-up after the camera is connected to a modem. You need to configure the PPPoE parameters of the network camera.



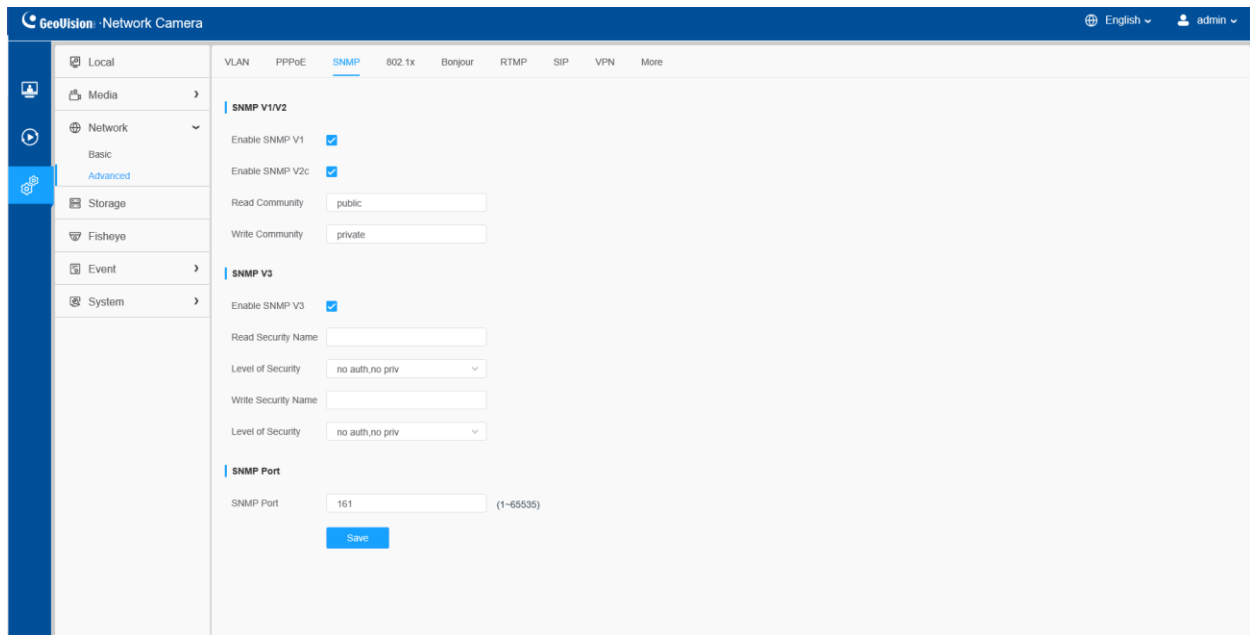
#### Note:

- The obtained IP address is dynamically assigned via PPPoE, so the IP address always changes after rebooting the camera. To solve the inconvenience of the dynamic IP, you need to get a domain name from the DDNS provider (e.g., DynDns.com).
- The user name and password should be assigned by your ISP.

### 8.2.2.3 SNMP


You can set the SNMP function to get camera status, parameters and alarm related information and manage the camera remotely when it is connected to the network.

Before setting the SNMP, please download the SNMP software and manage to receive the camera information via SNMP port. By setting the Trap Address, the camera can send the alarm event and exception messages to the surveillance center.



**Table 29. Description of the buttons**

Parameters	Function Introduction
<p><b>SNMP v1/v2</b></p>	<p>The version of SNMP, please select the version of your SNMP software.</p> <p><b>Enable SNMP v1:</b> Provide no security.</p> <p><b>Enable SNMP v2:</b> Require password for access.</p> <p><b>Write Community:</b> Input the name of Write Community.</p> <p><b>Read Community:</b> Input the name of Read Community</p>
<p><b>SNMP v3</b></p>	<p><b>Enable SNMP v3:</b> Provide encryption and the HTTPS protocol must be enabled.</p> <p><b>Read Security Name:</b> Input the name of Read Security Community.</p> <p><b>Level of Security:</b> There are three levels available: (auth, priv), (auth, no priv) and (no auth, no priv).</p> <p><b>Write Security Name:</b> Input the name of Write Security Community.</p> <p><b>Level of Security:</b> There are three levels available: (auth, priv), (auth, no priv) and (no auth, no priv).</p>

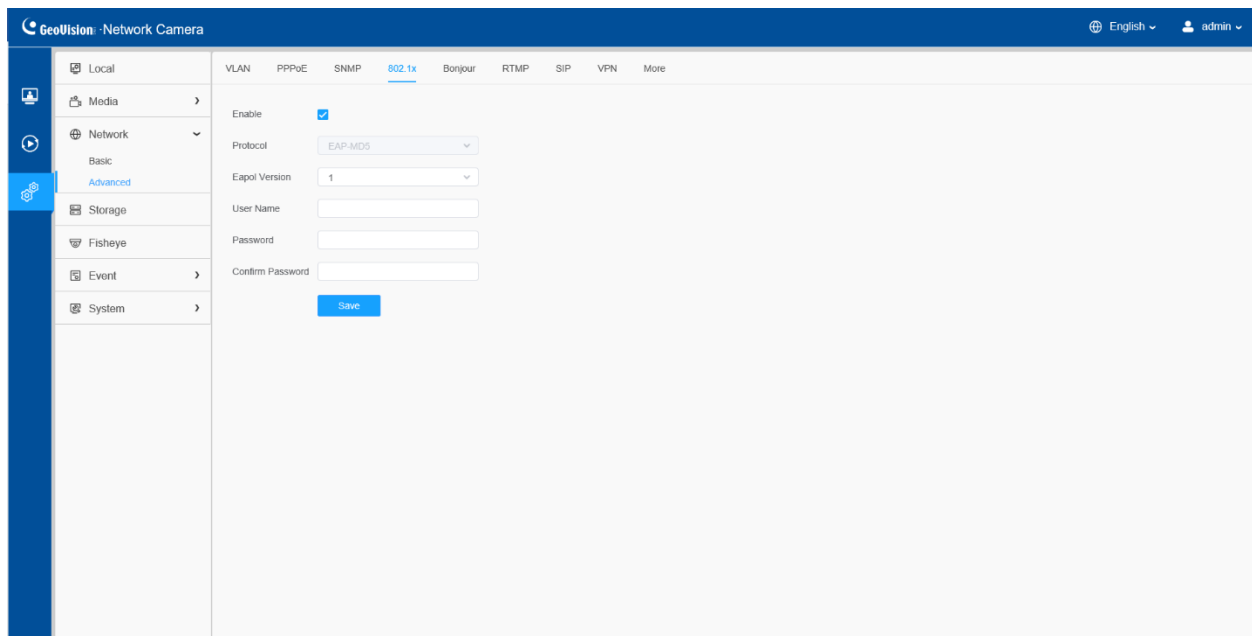
<b>SNMP Port</b>	The port of SNMP, the default is 161.
	Save the configuration.

**Note:**

- The settings of SNMP software should be the same as the settings you configure here;
- A reboot is required for the settings to take effect.

### 8.2.2.4 802. 1x

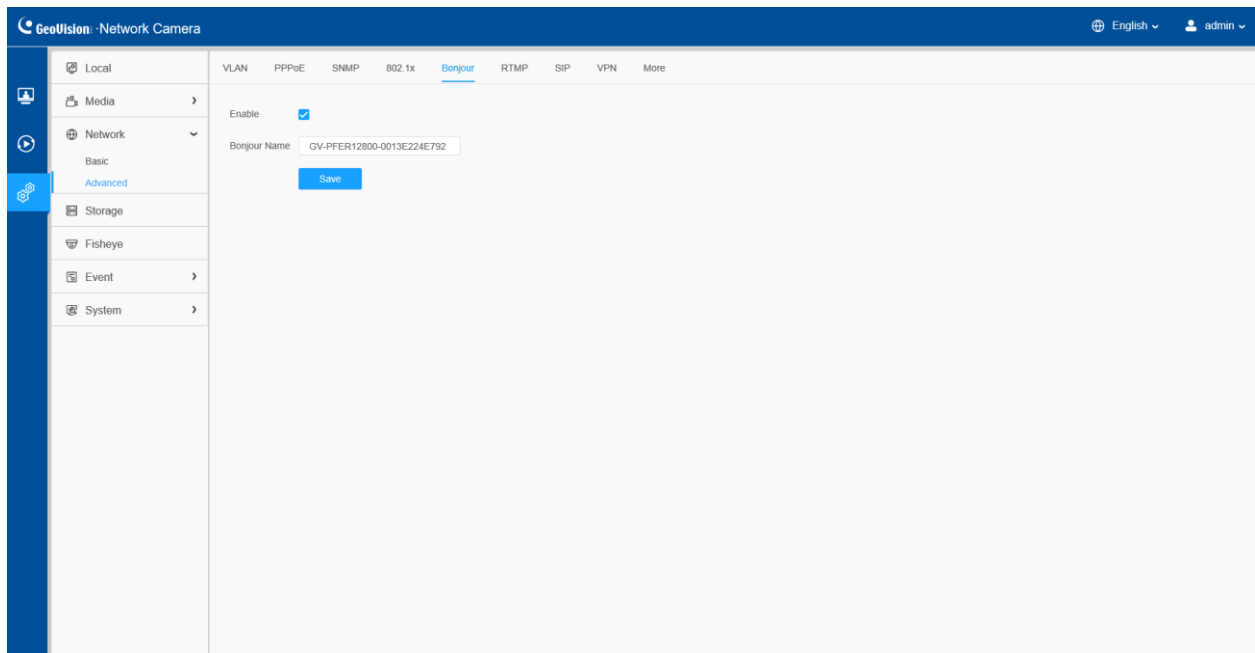
The IEEE 802. 1X standard is supported by the network cameras, and when the feature is enabled, the camera data is secured and user authentication is needed when connecting the camera to the network protected by the IEEE 802. 1X.



### 8.2.2.5 Bonjour

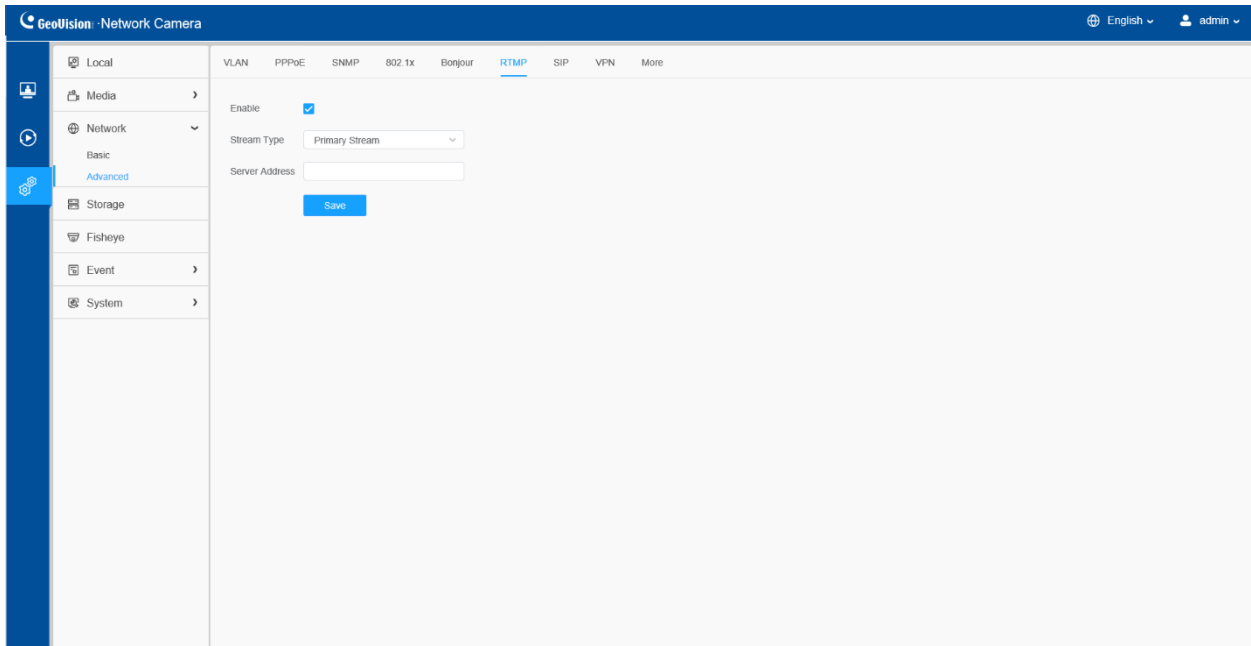
Bonjour is based on Apple's multicast DNS service. Bonjour devices can automatically broadcast their service information and listen to the service information of other devices.

If you don't know the camera information, you can use the Bonjour service on the same LAN to search for network camera devices and then to access the devices.



### 8.2.2.6 RTMP

Real-Time Messaging Protocol (RTMP) was initially a proprietary protocol for streaming audio, video and data over the Internet, between a Flash player and a server. RTMP is a TCP-based protocol which maintains persistent connections and allows low-latency communication. It can realize the function of live broadcast so that customers can log in to the camera wherever there is a network.



**Note:**

- Server Address in Network Camera RTMP interface needs to be filled with the format: `rtmp://< Server URL >/< Stream key >`. Remember it needs `'/'` to connect between `< Server URL >` and `< Stream key >`.



### 8.2.2.7 SIP

The Session Initiation Protocol (SIP) is a signaling communications protocol, widely used for controlling multimedia communication sessions such as voice and video calls over Internet Protocol (IP) networks. This page allows user to configure SIP related parameters. The camera can be configured as SIP endpoint to call out when alarm triggered; or allow permitted number to call in to check the video if the video IP phone is used.

To use this function, the settings in SIP page must be configured properly. There are two ways to get video through SIP, one is to dial the IP address directly, the other is account registration mode. The details are as follows:

#### **Method 1:** IP Direct mode

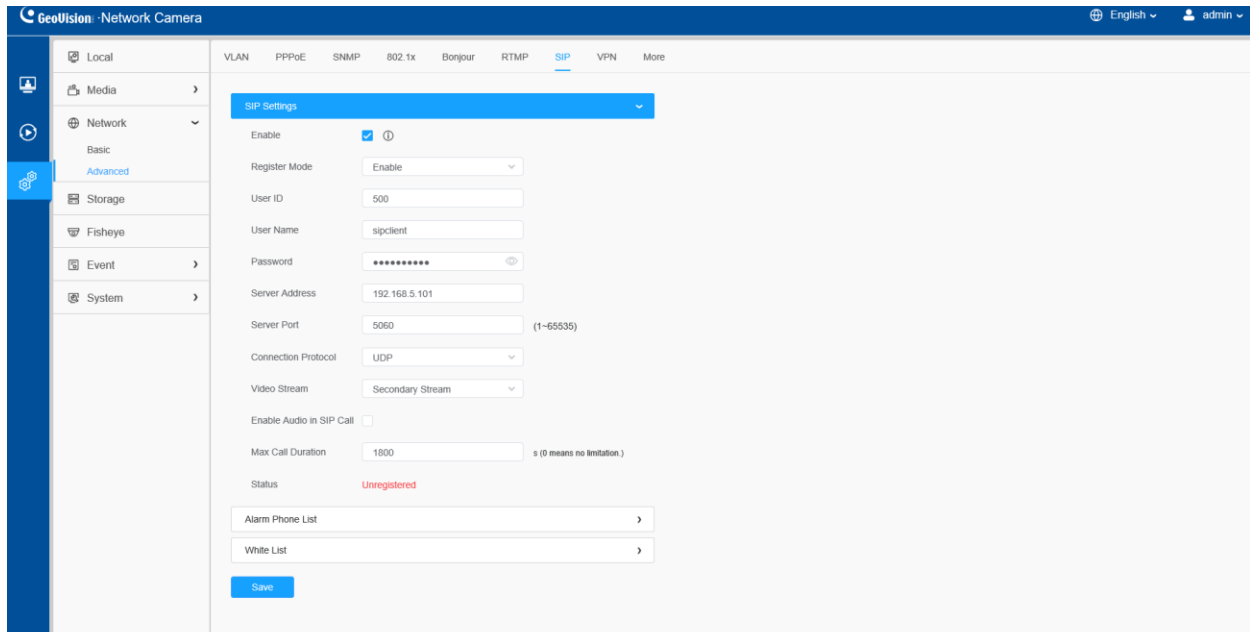
Dial on the camera's IP address directly through SIP phone, so you can see the video.

**Note:** SIP phone and the camera should in the same network segment.

#### **Method 2:** Account registration mode

- Before using the SIP, you need to register an account for the camera from the SIP server;
- Register another user account for the SIP device from the same SIP server;
- Call the camera User ID from the SIP device, you will get the video on the SIP device.

## [SIP Settings]

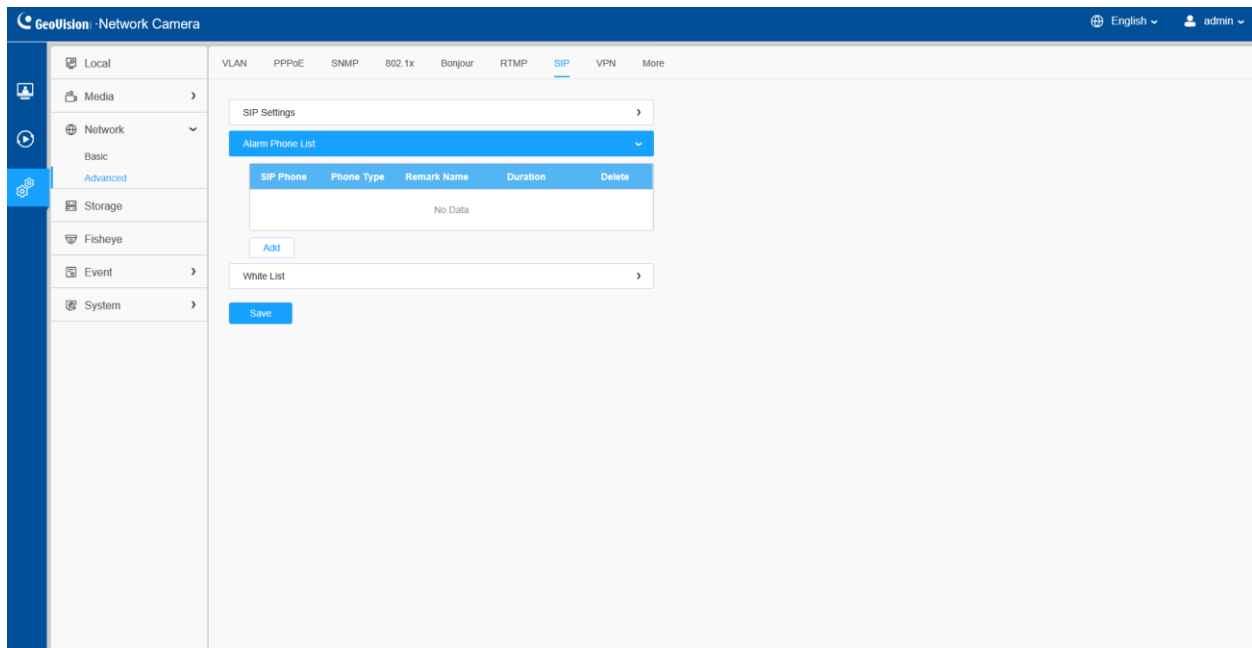


**Table 30. Description of the buttons**

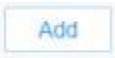


Parameters	Function Introduction
<b>Enable</b>	Start or stop using SIP. <b>Note:</b> SIP supports Direct IP call.
<b>Register Mode</b>	Choose to use Enable mode or Disable mode. Enable mode means to use SIP with register account. Disable mode refers to use SIP without register account, just use the IP address to call.
<b>User ID</b>	SIP ID.
<b>User Name</b>	SIP account name.
<b>Password</b>	SIP account password.
<b>Server Address</b>	Server IP address.
<b>Server Port</b>	Server port.
<b>Connection Protocol</b>	UDP/TCP.
<b>Video Stream</b>	Choose the video stream.
<b>Enable Audio in SIP Call</b>	Enable/disable audio in SIP call.

<b>Max Call Duration</b>	The max call duration when use SIP.
<b>Status</b>	SIP registration status. Display “Unregistered” or “Registered”.

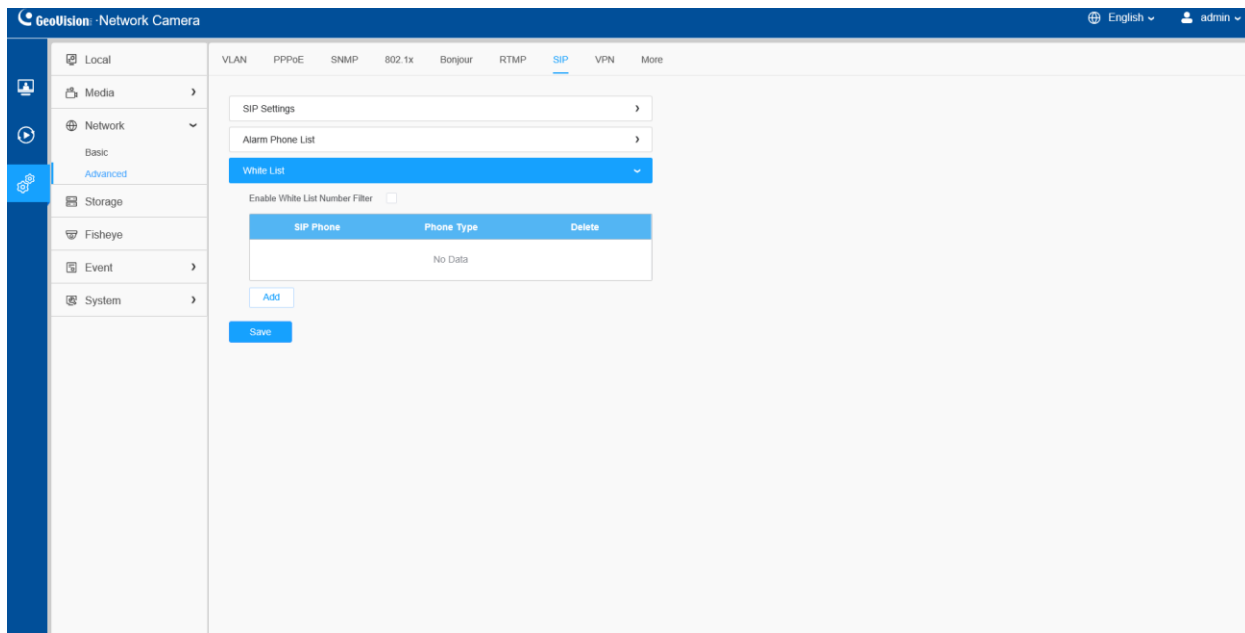
### [Alarm Phone List]




**Table 31. Description of the buttons**

Parameters	Function Introduction
	Add alarm phone to the camera. <b>Phone Type:</b> Phone Number (Call by phone number) & Direct IP Call (Check to accept peer to peer IP call). <b>To Phone Number/IP Address:</b> Call by phone number or IP address. <b>Remark Name:</b> Display name. <b>Duration:</b> The time schedule to use SIP.
	Delete the selected alarm phone.
	Delete all added alarm phone.

### [White List]



**Table 32. Description of the buttons**

Parameters	Function Introduction
<b>Enable White List Number Filter</b>	When enabled, only the designated phone number or IP address can visit
	<p><b>Phone Type:</b> Phone Number (Call by phone number) &amp; Direct IP Call.</p> <p><b>Phone Number/IP Address:</b> Including the phone number or IP address on the white list.</p>

#### 8.2.2.8 VPN

VPN stands for Virtual Private Network. It is a network protocol that can provide you secure encrypted connection over the public Internet. It is a significant technology in surveillance industry. Imagine that you have a network camera connected via public IP address, it's possible for others to log in or listen illegally if someone knows the specific IP address and the forwarded port. Via VPN the camera streams and data will be transferred through an encrypted tunnel. This encrypted VPN tunnel makes it appear as though you are directly connected to the private network, keeping your online activity (including your browsing history) hidden. VPN feature allows users to log in to the camera via a virtual IP, which makes it easier to configure the camera remotely.

General VPN mode allows users to upload OpenVPN configuration file directly. Please note that the General VPN mode is working under OpenVPN protocol. You can take the camera as an OpenVPN client.

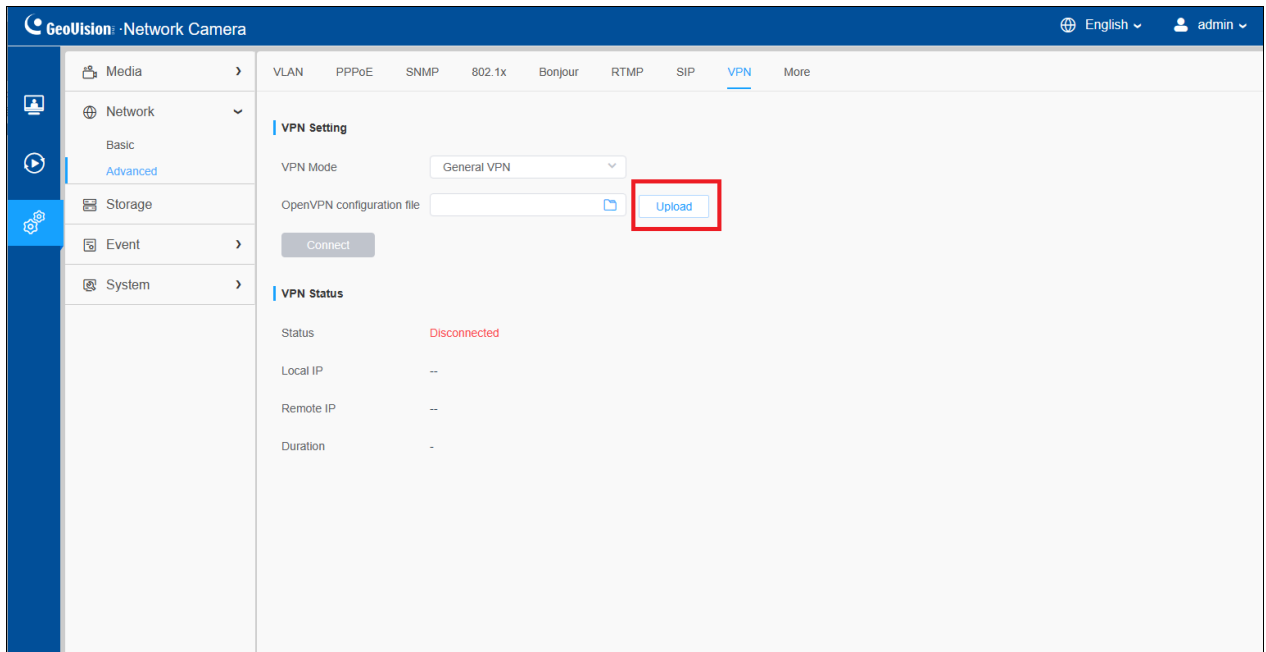
#### **Exporting an OpenVPN configuration file**

First we need to prepare an OpenVPN configuration file. Configuration file (also known as connection profile) is an .ovpn text file that contains the directives, parameters, and certificates required to establish the server-client connection. Refer to the official instruction regarding the configuration file exporting:

<https://openvpn.net/vpn-server-resources/create-connection-profiles-and-connect-client-installers/>

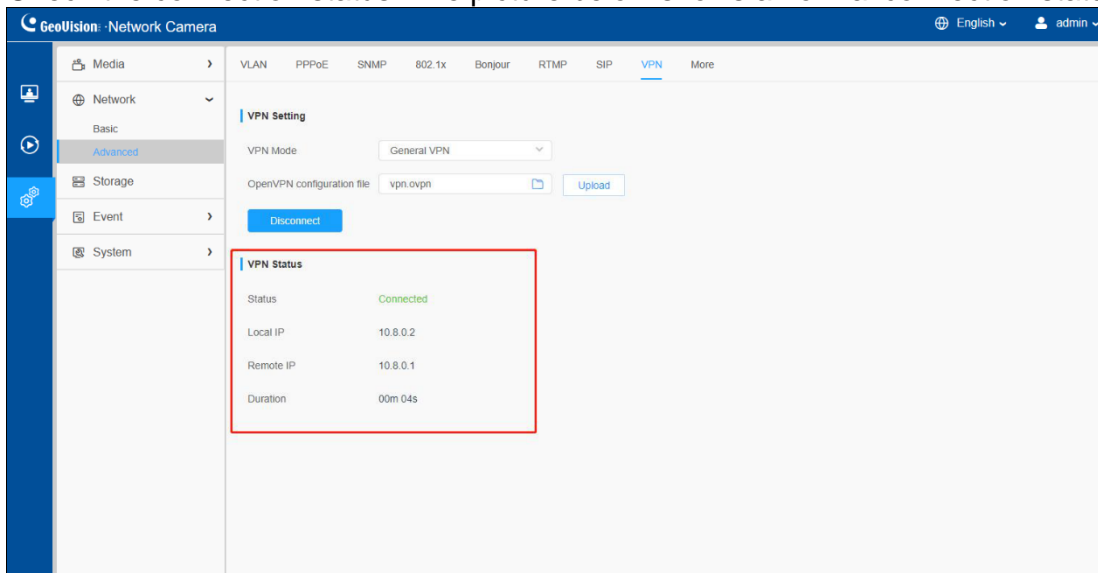
## Uploading the OpenVPN configuration file

Next, we need to upload the configuration file. The connection will start automatically once the uploading is done:



**Note:** If you disconnect the VPN manually or the connection is broken due to network error, to restore connection you need to upload the configuration file on this page again.

Check the connection status. The picture below shows a normal connection status:



## Connecting camera via VPN on the web browser

After the VPN connection is established, we can log in the camera via virtual IP

address.

**VPN Status**

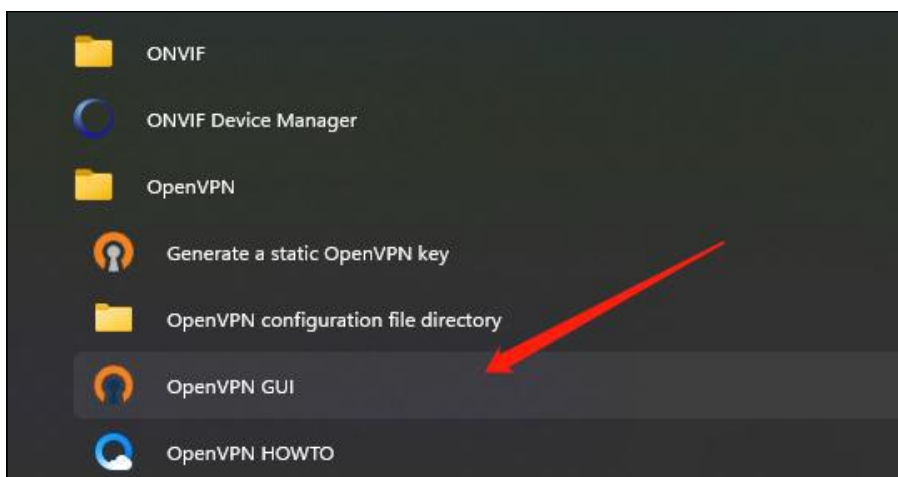
Status	Connected
Local IP	10.8.0.4
Remote IP	10.8.0.1
Duration	04h 31m 32s

Parameters	Definition
Status	Status of VPN connection
Local IP	Camera virtual IP
Remote IP	VPN virtual IP
Duration	Connection duration

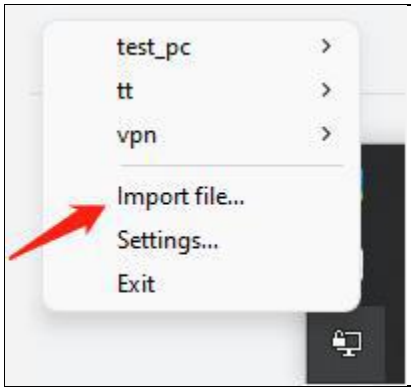
## Connecting camera via VPN on OpenVPN application

Optionally, you can also connect the camera via VPN on OpenVPN application. First please make sure your computer is also connected to VPN. For example, you can download OpenVPN client for Windows from: <https://openvpn.net/client-connect-vpn-for-windows/>

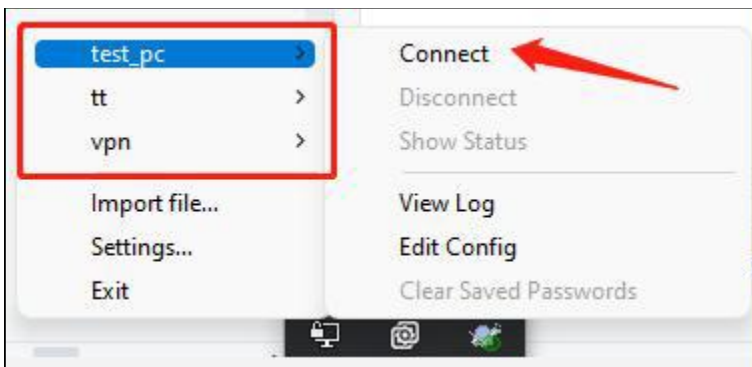
After installation, you can see the application in Start menu. Open the app




Right click the VPN connection icon on tool bar and select *Import file*. Please prepare another OpenVPN configuration file that is different from camera's.



In this area, you can see all the configuration file you've uploaded. Select the corresponding file to connect:

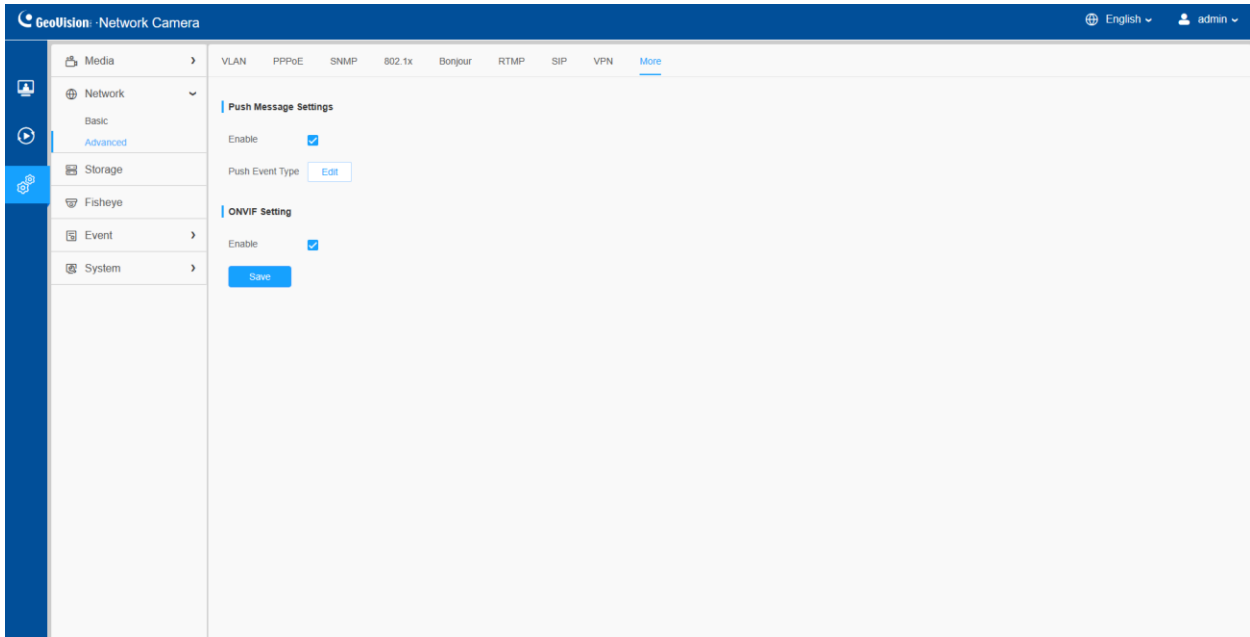


When the connection is done, your computer will show this icon:  Open the Web browser and enter virtual IP address to log in the camera via Web.


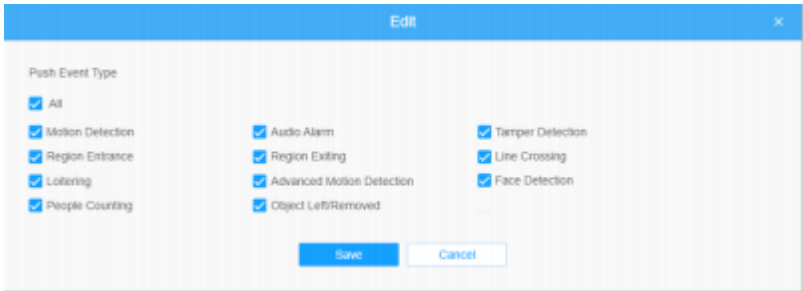


### 8.2.2.9 More

Here you can set more functions, like Push Message Settings and ONVIF Settings.

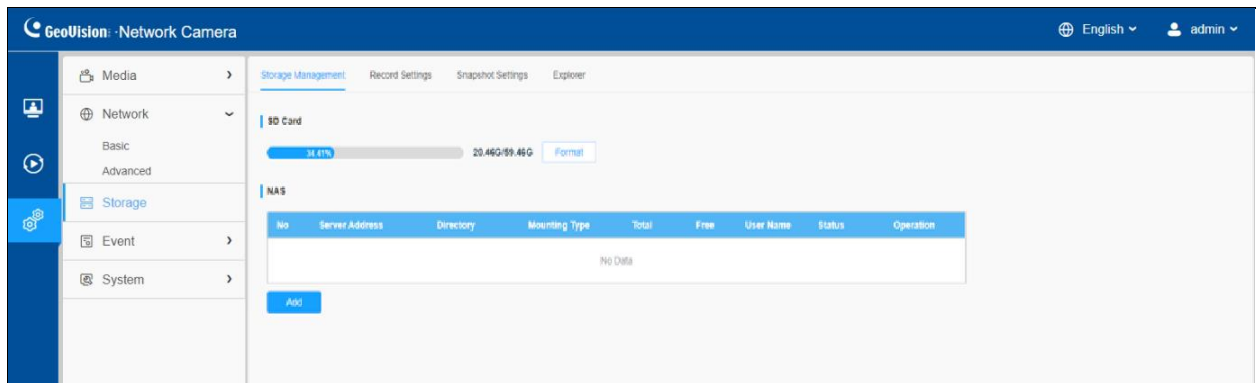


**Table 33. Description of the buttons**

Parameters	Function Introduction
<p><b>Push Message Settings</b></p>	<p><b>Enable:</b> Enable/disable the Push Message function</p> <p><b>Push Event Type:</b> You can click  to choose the types of Events' message which will be pushed to M-sight Pro App as shown below:</p> 
<p><b>ONVIF Setting</b></p>	<p>Here you can choose whether to enable or disable camera ONVIF function. If camera ONVIF function is enabled, it can be searched out, added and connected by third-party software through ONVIF protocols. Generally, the default status of ONVIF function is enabled.</p>

## 8.3 Storage

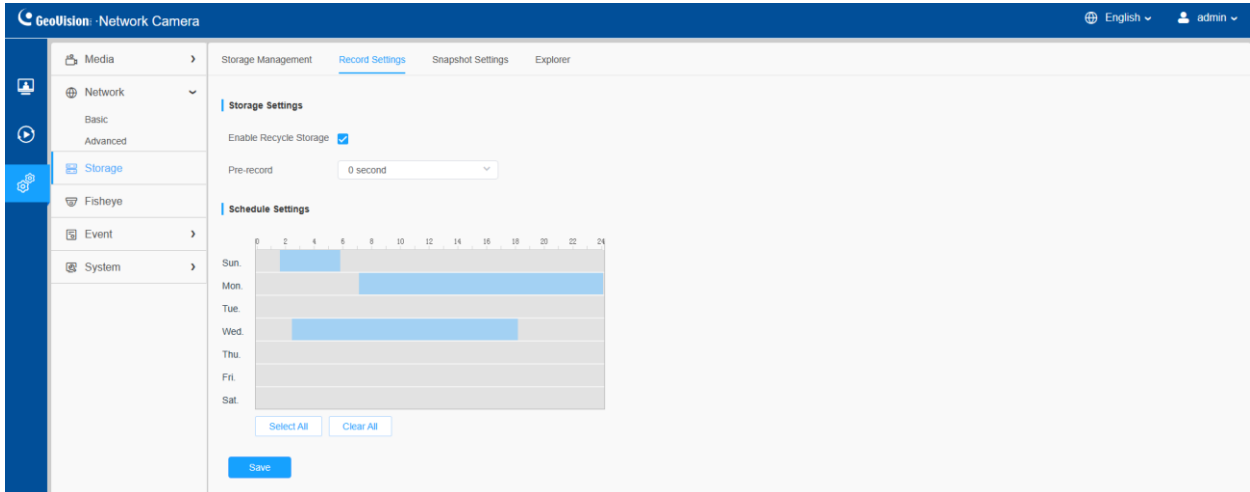
### 8.3.1 Storage Management



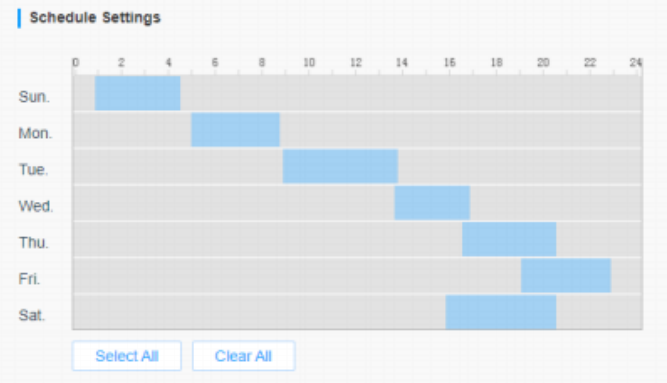
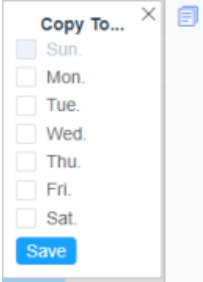

**Table 34. Description of the buttons**



Parameters	Function Introduction
<p style="text-align: center;"><b>SD Card</b></p>	<p><b>Format:</b> Format SD card, the files in SD card will be removed.</p> <p><b>Mount/UnMount:</b> Mount/Dismount SD card.</p> <p><b>Delete:</b> Enable cyclic storage, when the free disk space reach at a certain value, it will automatically delete the files at certain percentage according to your settings.</p>
<p style="text-align: center;"><b>Nas</b></p>	<p>The network disk should be available within the network and properly configured to store the recorded files, etc.</p> <p>NAS (Network-Attached Storage), connecting the storage devices to the existing network, provides data and files services.</p> <p><b>Server Address:</b> IP address of NAS server.</p> <p><b>Directory:</b> Input the NAS directory, e.g., “\path”.</p> <p><b>Mounting Type:</b> NFS and SMB/CIFS are available. And you can set the user name and password to guarantee the security if SMB/CIFS is selected.</p> <p><b>Note:</b></p> <ul style="list-style-type: none"> <li>• Up to 5 NAS disks can be connected to the camera.</li> </ul>

### 8.3.2 Record Settings



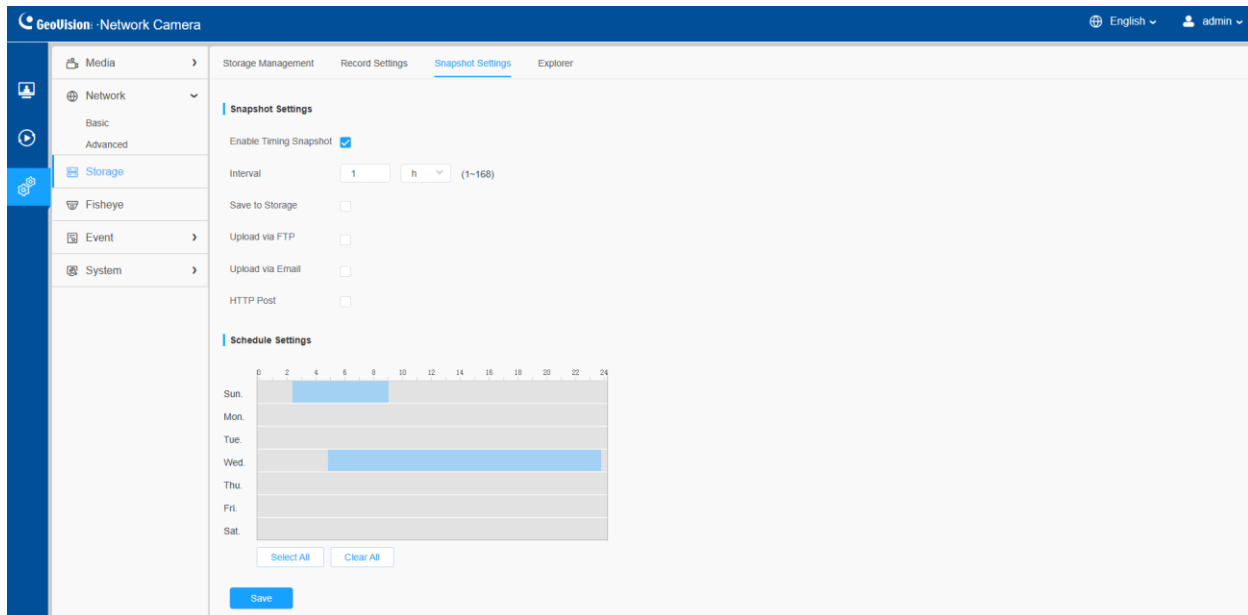
**Table 35. Description of the buttons**

Parameters	Function Introduction	
<b>Enable Recycle Storage</b>	Enable/Disable Recycle Storage, if you enable this option, it will delete the files when the free disk space reaches a certain value.	
<b>Pre Second</b>	Reserve the record time before alarm, 0~10 sec.	
<b>Schedule Settings</b>	<p>Edit record schedule as needed. Intuitive scheduling by drawing the time bar directly.</p> 	
<b>Schedule Settings</b>		Copy the schedule area to another date.
<b>Schedule Settings</b>		Select all schedule.

		Clear all schedule.
	Save the configuration.	

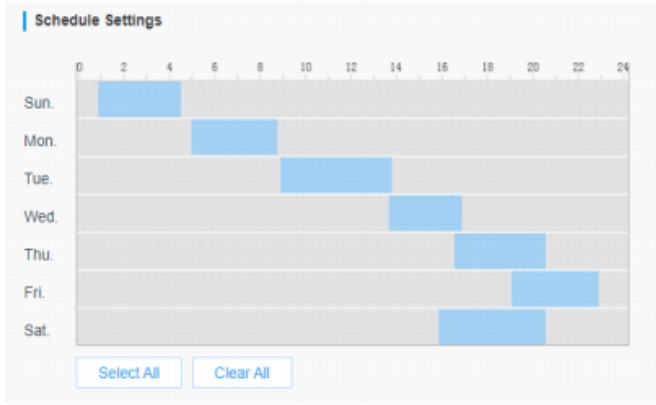
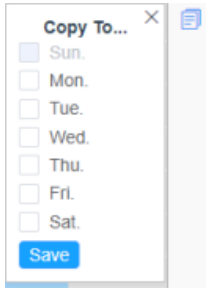



**Note:** SD Card or NAS are available.

### 8.3.3 Snapshot Settings



**Table 36. Description of the buttons**

Parameters	Function Introduction
<p><b>Snapshot Settings</b></p>	<p><b>Enable Timing Snapshot:</b> Check the checkbox to enable the Timing Snapshot function</p> <p><b>Interval:</b> Set the snapshots interval, input the number and choose the unit (millisecond, second, minute, hour, day).</p> <p><b>Save Into Storage:</b> Save the snapshots into SD card or NAS, and choose the file name to add time suffix or overwrite the base file name.</p> <p><b>Save Into NAS:</b> Save the snapshots into NAS, and choose the file name to add time suffix or overwrite the base file name.</p> <p><b>Upload Via FTP:</b> Upload the snapshots via FTP.</p> <p><b>Upload Via Email:</b> Upload the snapshots via email.</p> <p><b>Note:</b> If you choose to add time suffix, every snapshot picture will be saved, but if you choose to overwrite the base file name, only one latest picture will be saved. When you choose add overwrite the base file name to SD Card or NAS, it will create a file named “Snapshot” to place the snapshot.</p> <p><b>HTTP Post:</b> Upload the snapshots via HTTP Post. Support uploading the snapshots to specified HTTP URL.</p>

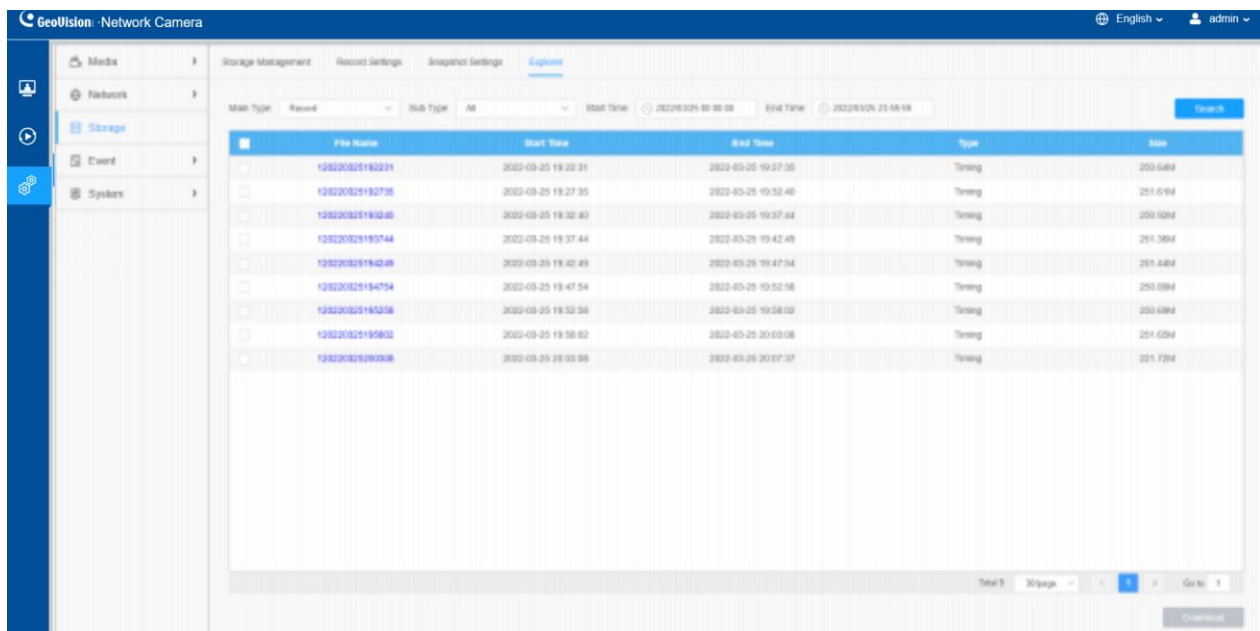
<p><b>Schedule Settings</b></p>	<p>Edit record schedule as needed. Intuitive scheduling by drawing the time bar directly.</p> 	
<p><b>Schedule Settings</b></p>		<p>Copy the schedule area to another date.</p>
		<p>Select all schedule.</p>
		<p>Clear all schedule.</p>
	<p>Save the configuration.</p>	

### 8.3.4 Explorer

Files will be seen on this page when they are configured to save into SD card or NAS. You can set time schedule every day for recording videos and save video files to your desired location.

**Note:** Files are visible once SD card is inserted. Don't insert or pull out SD card when power on

Video files are arranged by date. Set file type and start/end time to search out files. Each day files will be displayed under the corresponding date, from here you can copy and delete files etc. You can visit the files in SD card by ftp, for example, ftp://username:password@192. 168.5. 190 (user name and password are the same as the camera account and the IP followed is the IP of your device.).



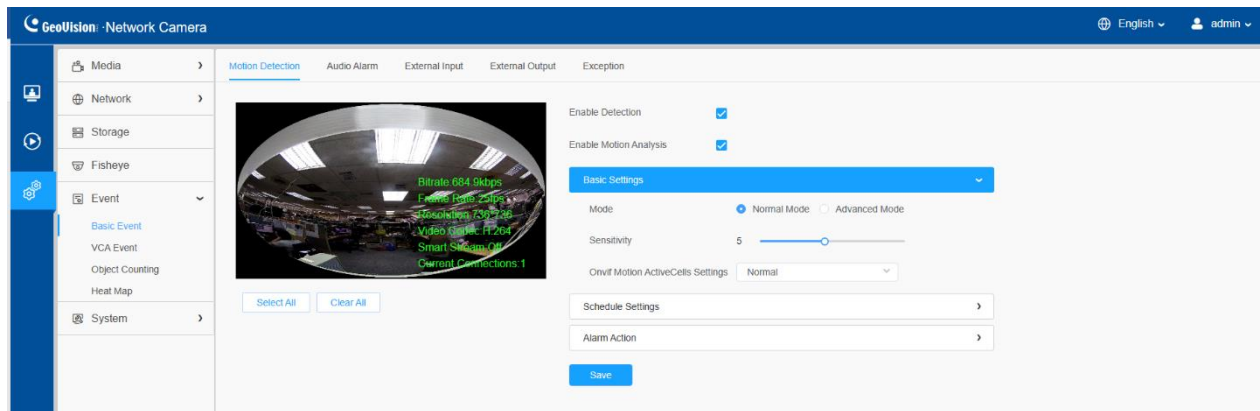
The screenshot shows the 'Explorer' tab in the GeoVision Network Camera web interface. The interface includes a sidebar with navigation options (Media, Network, Storage, Event, System) and a main content area displaying a table of video files. The table has columns for File Name, Start Time, End Time, Type, and Size. The files listed are all 'Timing' type and are sorted by date and time.

File Name	Start Time	End Time	Type	Size
12822025182231	2022-03-25 19:22:31	2022-03-25 19:27:35	Timing	251.64K
12822025182735	2022-03-25 19:27:35	2022-03-25 19:32:40	Timing	251.61K
12822025183240	2022-03-25 19:32:40	2022-03-25 19:37:44	Timing	250.92K
12822025183744	2022-03-25 19:37:44	2022-03-25 19:42:49	Timing	251.36K
12822025184249	2022-03-25 19:42:49	2022-03-25 19:47:54	Timing	251.64K
12822025184754	2022-03-25 19:47:54	2022-03-25 19:52:58	Timing	250.99K
12822025185258	2022-03-25 19:52:58	2022-03-25 19:58:02	Timing	250.68K
12822025185802	2022-03-25 19:58:02	2022-03-25 20:03:06	Timing	251.69K
12822025190306	2022-03-25 20:03:06	2022-03-25 20:07:37	Timing	221.72K

## 8.4 Event

### 8.4.1 Basic Event

#### 8.4.1.1 Motion Detection



Settings steps are shown as follows:

**Step1:** Check the checkbox to enable the motion detection.

**Step2:** Check the check box to enable the motion analysis.

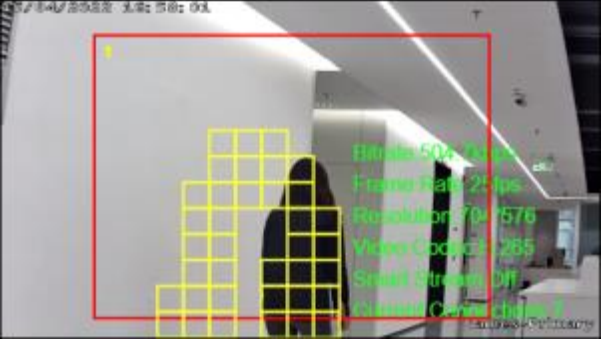
**Step3:** Select the detection mode;

**Step4:** Set motion region;

**Table 37. Description of the buttons**

Parameters	Function Introduction
Enable Detection	Check the checkbox to enable Motion Detection function.



<p><b>Enable Motion Analysis</b></p>	<p>When Motion Analysis is enabled, the moving region will turn yellow so that the user can know exactly where the motion occurred.</p> <p><b>Note:</b> Only support when HTTP is selected in Live View.</p> 
<p>Select All</p>	<p>Click the button, the motion in the area will be detected.</p>
<p>Clear All</p>	<p>Click the button, the area drawn before will be removed.</p>
<p>Save</p>	<p>Save the configuration.</p>

## [Basic Settings]

Enable Detection

Enable Motion Analysis

Basic Settings

Mode  Normal Mode  Advanced Mode

Sensitivity 5

Onvif Motion ActiveCells Settings

Schedule Settings

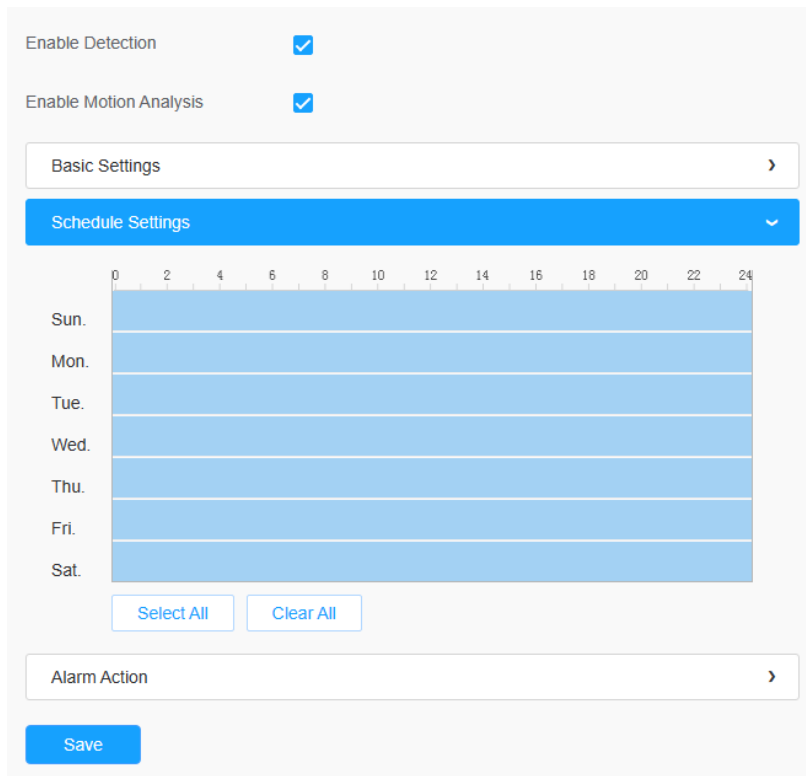
Alarm Action

**Table 38. Description of the buttons**

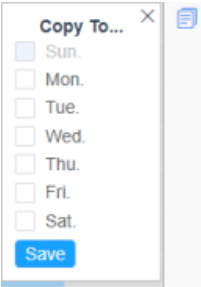


Parameters	Function Introduction
<b>Detection Mode</b>	Normal Mode and Advanced Mode are available for the option. When Advanced Mode is selected, users can configure up to 4 detection regions and sensitivity for each detection region.
<b>Sensitivity</b>	Sensitivity level, 1~10
<b>Onvif Motion ActiveCells Settings</b>	Normal and Compatible are available for the option. If the setting of motion region of the third-party software is different from ours, please set this option to Compatible

**[Schedule Settings]**

**Step5:** Set motion detection schedule;

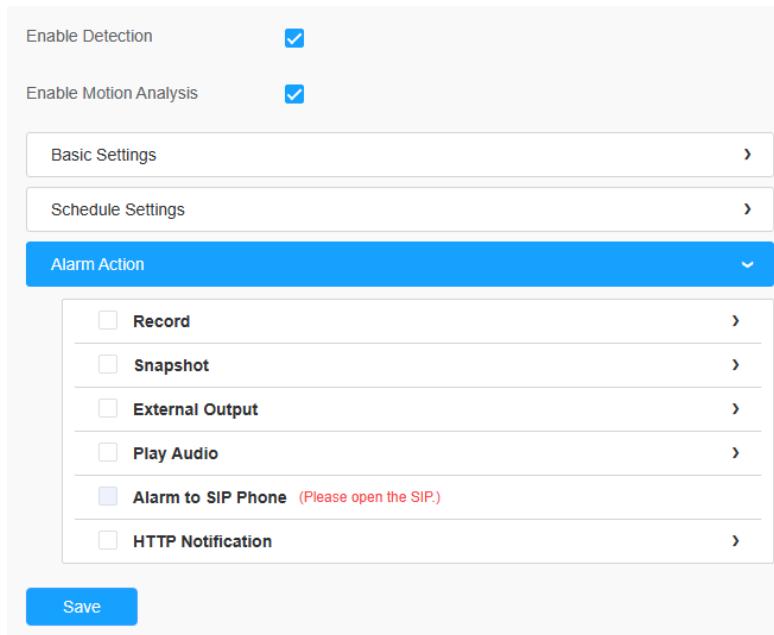


**Table 39. Description of the buttons**

Parameters	Function Introduction
	Copy the schedule area to another date.
	Select all schedule.
	Clear all schedule.

## [Alarm Action]

**Step6:** Set alarm action;



Enable Detection

Enable Motion Analysis

Basic Settings >

Schedule Settings >

**Alarm Action** v

- Record >
- Snapshot >
- External Output >
- Play Audio >
- Alarm to SIP Phone (Please open the SIP.)
- HTTP Notification >

Save

**Table 40. Description of the buttons**

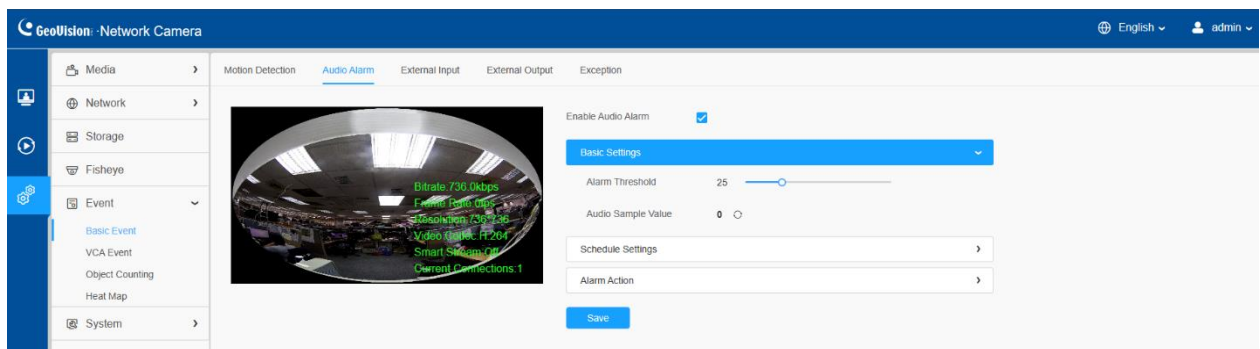
Parameters	Function Introduction
<b>Record</b>	<p><b>Duration:</b> Selected the duration time of alarm. 5s/10s/15s/20s/25s/30s are available.</p> <p><b>Linkage:</b> Save alarm recording files into SD Card or NAS or Upload the recording files via FTP.</p>
<b>Snapshot</b>	<p><b>Number:</b> The number of snapshots. 1~5 is available.</p> <p><b>Interval:</b> This cannot be edited unless you choose more than 1 to Snapshot.</p> <p><b>Linkage:</b> Save alarm recording files into SD Card or NAS, Upload the recording files via FTP and send alarm email.</p>
<b>External Output</b>	<p>If the camera equips with External Output, you can enable the action after configuring the trigger duration.</p>
<b>Play Audio</b>	<p>Auto/10 seconds/30 seconds/1 minute/5 minutes/10 minutes are available.</p> <p><b>Note:</b> Please enable the Audio Speaker.</p>

<b>Alarm to SIP Phone</b>	Support to call the SIP phone after enable the SIP function.
<b>HTTP Notification</b>	Support to pop up the alarm news to specified HTTP URL. <b>Note:</b> <ul style="list-style-type: none"> <li>• Three HTTP notifications at most can be added to the same event.</li> <li>• HTTP Notification supports Basic &amp; Digest authentication</li> </ul>

### 8.4.1.2 Audio Alarm

Check the check box to enable the Audio Alarm function.

**Note:** Enable the Audio Mic before using Audio Alarm function.



#### [Basic Settings]

**Table 41. Description of the buttons**

Parameters	Function Introduction
<b>Alarm Threshold</b>	Audio Alarm will be triggered when the threshold reaches to a certain value from 0 to 100.
<b>Audio Sample Value</b>	The current value of the audio sample.

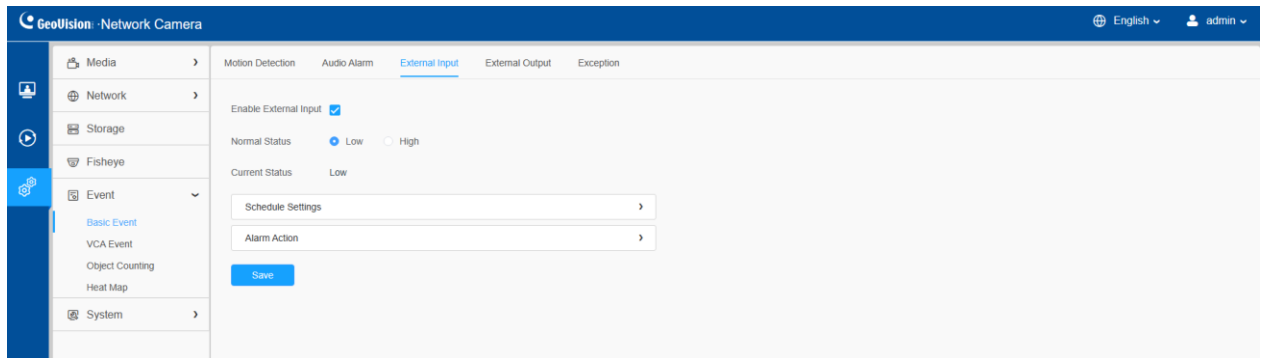
#### [Schedule Settings]

Refer to *Schedule Settings* in 8.4.1.1 *Motion Detection* for details.

#### [Alarm Action]

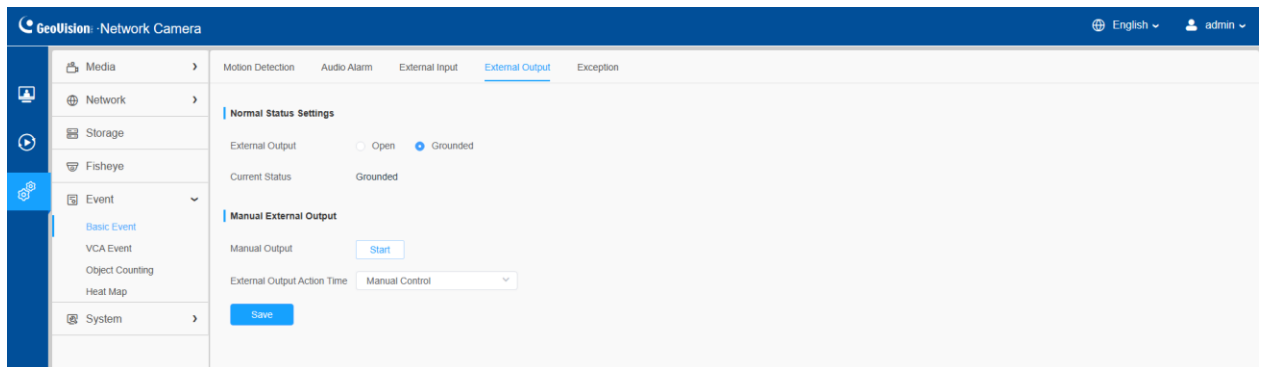
Refer to *Alarm Action* in 8.4.1.1 *Motion Detection* for details.

### 8.4.1.3 External Input



Refer to *Alarm Action* in 8.4.1.1 *Motion Detection* for details.

### 8.4.1.4 External Output



Please set the **Normal Status** firstly, when the **Current Status** is different with **Normal Status**, it will lead to the alarm.

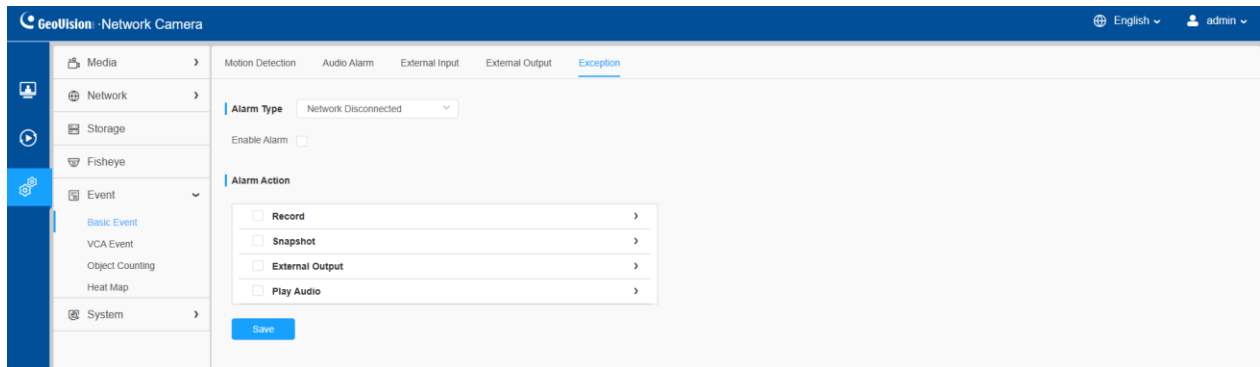
#### [Manual External Output]

You can set the manual external output.

**Table 42. Description of the buttons**

Parameters	Function Introduction
<b>Manual Output</b>	Click to Start/Stop manual external output.
<b>External Output Action Time</b>	Manual Control/Customize/10 s/1 min./5 min./10 min. are available.

### 8.4.1.5 Exception



**Table 43. Description of the buttons**

Parameters	Function Introduction
<p><b>Alarm Type</b></p>	<p><b>Network Disconnected, IP Address Conflicted, Record Failed, SD Card Full, SD Card Uninitialized, SD Card Error and No SD Card</b> are available Check the checkbox to enable the alarm type you selected</p>
<p><b>Alarm Action</b></p>	<p>Refer to <i>Alarm Action</i> in <i>8.4.1.1 Motion Detection</i> for details.</p>

## 8.4.2 VCA Event

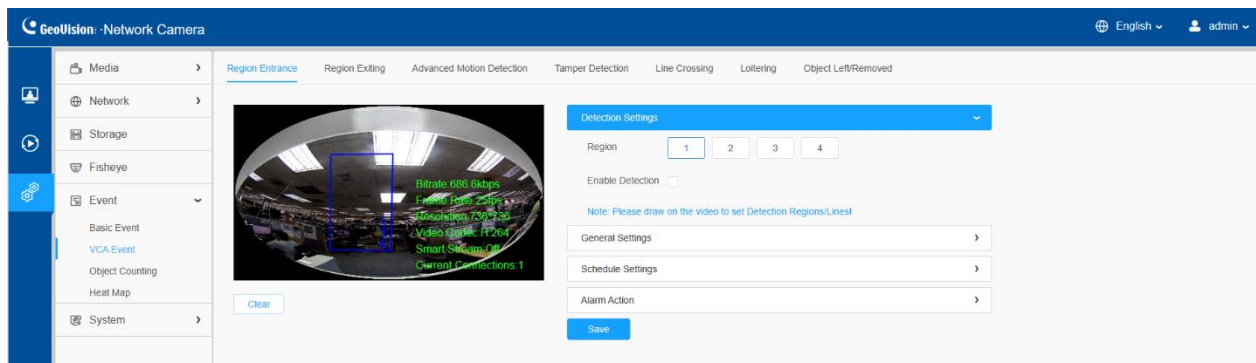
Smart Event uses VCA (Video Content Analysis) technology, which provides advanced, accurate smart video analysis for network cameras. Powered by AI chip, the new generation video analytics is capable of recognizing vast attributes of human and object pattern recognition models. As related events are very important in security monitoring, the filtering is supported to better optimize the efficiency.

### Note:

- Smart Event of fisheye camera only supports in 1O mode of Bundle-Stream mode and 1O, 1O3R, 1O1P3R mode of Multi-Channel mode.
- Vehicle recognition is currently not applicable.
- It is suggested to install the camera at the height of 3 – 5 m for **ceiling mount** and 2.5 – 4 m for **wall mount**.
- The applicable object size for detection is 3 x 3 – 320 x 240 pixels.
- For optimal detection results, ensure the entire object is within the screen boundaries and does not appear partially or is cut off.

### 8.4.2.1 Region Entrance

Region entrance helps to protect a special area from potential threat of suspicious person's or object's entrance. An alarm will be triggered when objects enter the selected regions by enabling region entrance.



Settings steps are shown as follows:

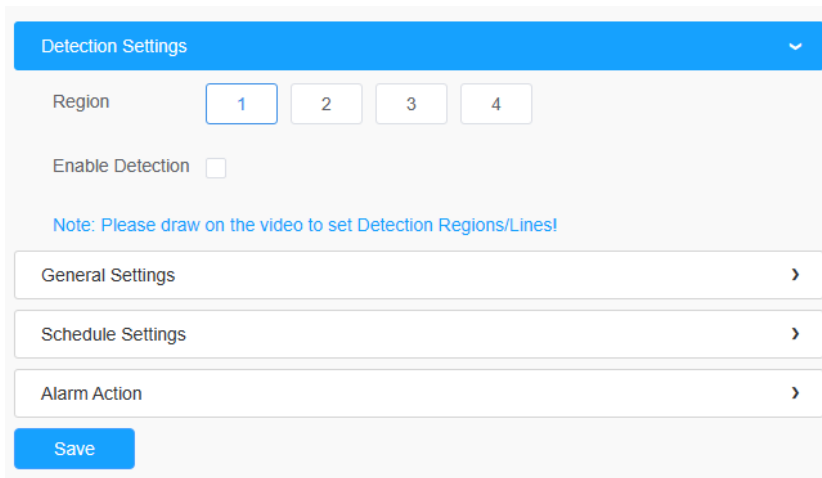
### [Detection Settings]

**Note:** General Settings will take effect in all detection regions/lines!

**Step 1:** Selected detection region.

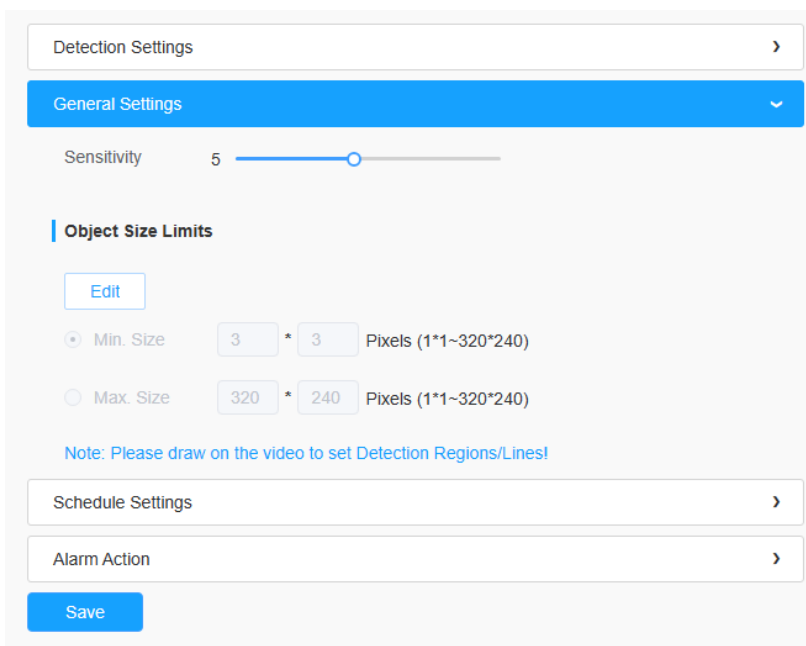


**Step 2:** Enable region entrance detection.



**[General Settings]**

**Step 3:** Set detecting sensitivity and object size limits;

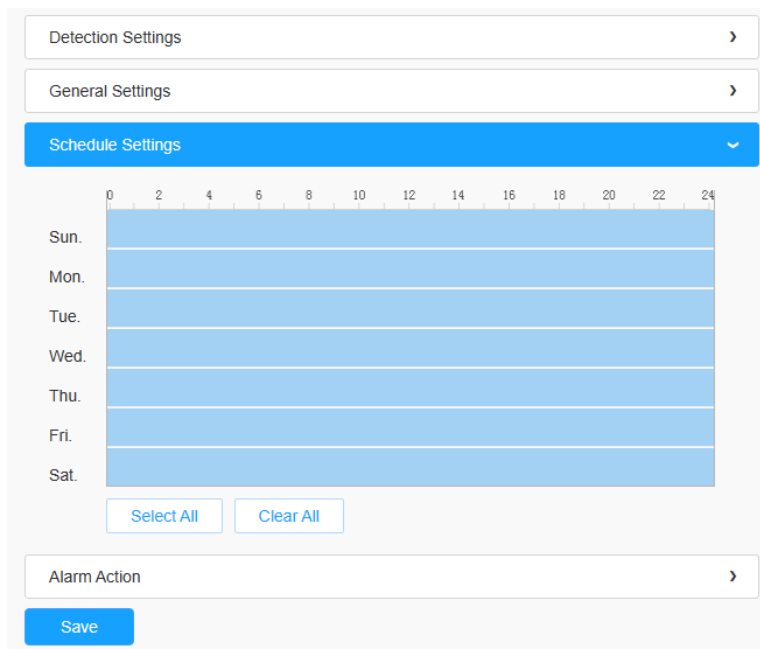


**Table 44. Description of the buttons**

Parameters	Function Introduction
<b>Sensitivity</b>	Level 1~10 is available, the default level is 5. The higher the sensitivity, the easier it is for moving objects to be recorded in the results.
<b>Min. Size</b>	Draw the screen or input pixel number to set the minimum size of the detected object. When the object is smaller than this size, it will not be detected. The default minimum size is 3*3.
<b>Max. Size</b>	Draw the screen or input pixel number to set the maximum size of the detected object. When the object is larger than this size, it will not be detected. The default maximum size is 320*240.

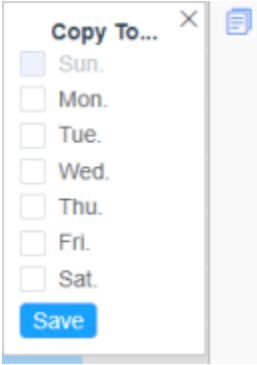


**[Schedule Settings]**

**Step 4:** Set detection schedule;



The screenshot shows a web interface for 'Schedule Settings'. At the top, there are three tabs: 'Detection Settings', 'General Settings', and 'Schedule Settings' (which is highlighted in blue). Below the tabs is a 24-hour timeline grid with columns labeled from 0 to 24 in increments of 2. The rows represent the days of the week: Sun., Mon., Tue., Wed., Thu., Fri., and Sat. The entire grid is filled with a light blue color, indicating that the detection schedule is set for all days and all hours. Below the grid are two buttons: 'Select All' and 'Clear All'. At the bottom of the interface, there is an 'Alarm Action' dropdown menu and a blue 'Save' button.

**Table 45. Description of the buttons**

Parameters	Function Introduction
	<p>Copy the schedule area to another date.</p>
	<p>Select all schedule.</p>
	<p>Clear all schedule.</p>

**[Alarm Action]**

**Step 5:** Set alarm action;

Detection Settings >

General Settings >

Schedule Settings >

Alarm Action >

Record >

Snapshot >

External Output >

Play Audio >

Alarm to SIP Phone (Please open the SIP.)

HTTP Notification >

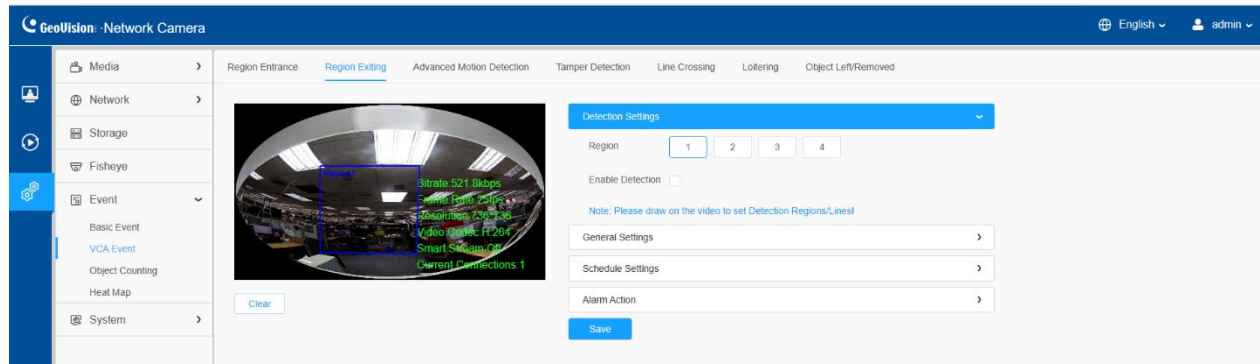
Save

**Table 46. Description of the buttons**

<b>Parameters</b>	<b>Function Introduction</b>
<b>Record</b>	<p><b>Duration:</b> Selected the duration time of alarm. 5s/10s/15s/20s/25s/30s are available.</p> <p><b>Linkage:</b> Save alarm recording files into SD Card or NAS or Upload the recording files via FTP.</p>
<b>Snapshot</b>	<p><b>Number:</b> The number of snapshots. 1~5 is available.</p> <p><b>Interval:</b> This cannot be edited unless you choose more than 1 to Snapshot.</p> <p><b>Linkage:</b> Save alarm recording files into SD Card or NAS, Upload the recording files via FTP and send alarm email.</p>
<b>External Output</b>	<p>If the camera equips with External Output, you can enable the action after configuring the trigger duration.</p>
<b>Play Audio</b>	<p>Auto/10 seconds/30 seconds/1 minute/5 minutes/10 minutes are available.</p> <p><b>Note:</b> Please enable the Audio Speaker.</p>
<b>Alarm to SIP Phone</b>	<p>Support to call the SIP phone after enabling the SIP function.</p> <p><b>Note:</b> Please open the SIP.</p>
<b>HTTP Notification</b>	<p>Support to pop up the alarm news to specified HTTP URL.</p>

### 8.4.2.2 Region Exiting

Region exiting is to make sure that any person or object won't exit the area that is being monitored. Any exit of people or objects will trigger an alarm.



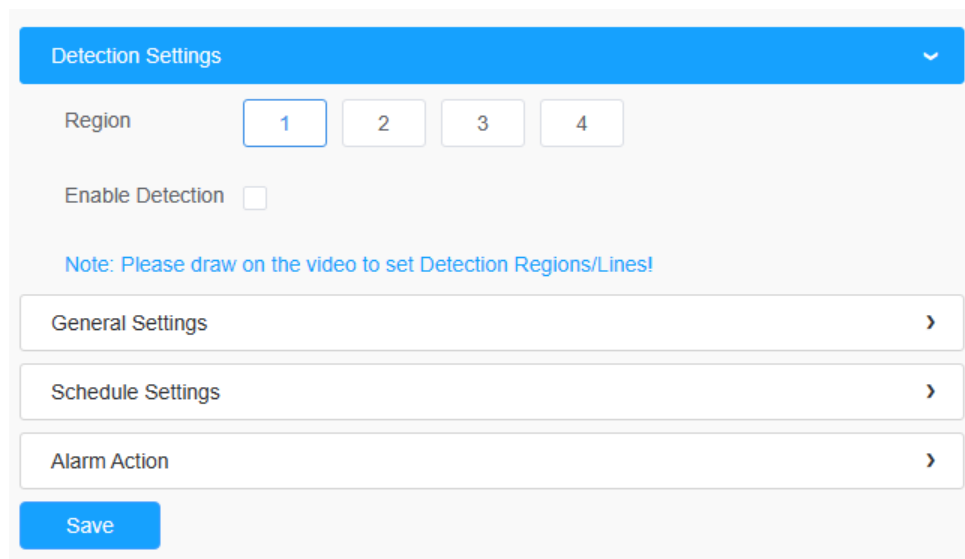
Settings steps are shown as follows:

#### [Detection Settings]

**Note:** General Settings will take effect in all detection regions/lines!

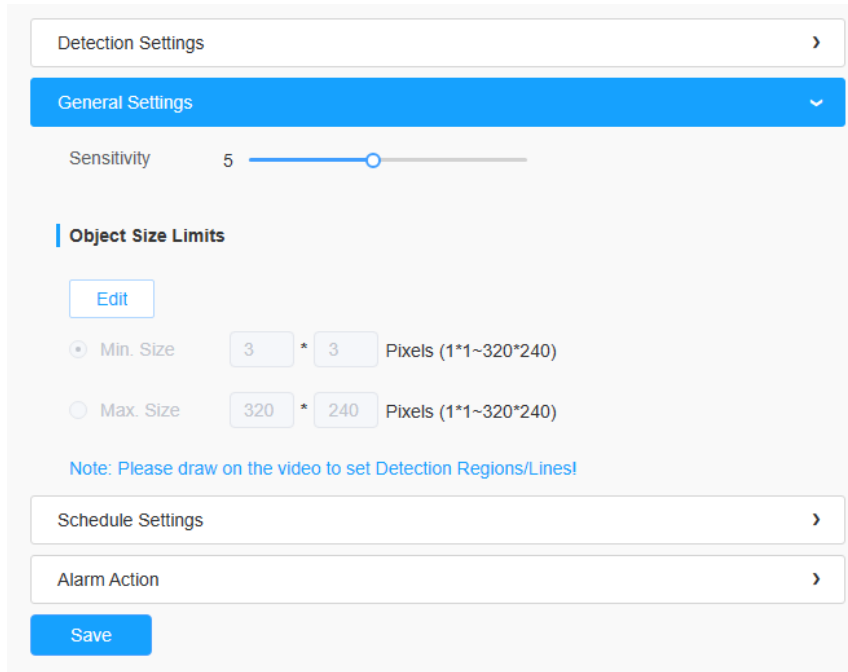
**Step 1:** Selected detection region.

**Step 2:** Enable region exiting detection.



## [General Settings]

**Step 3:** Set detecting sensitivity and object size limits;

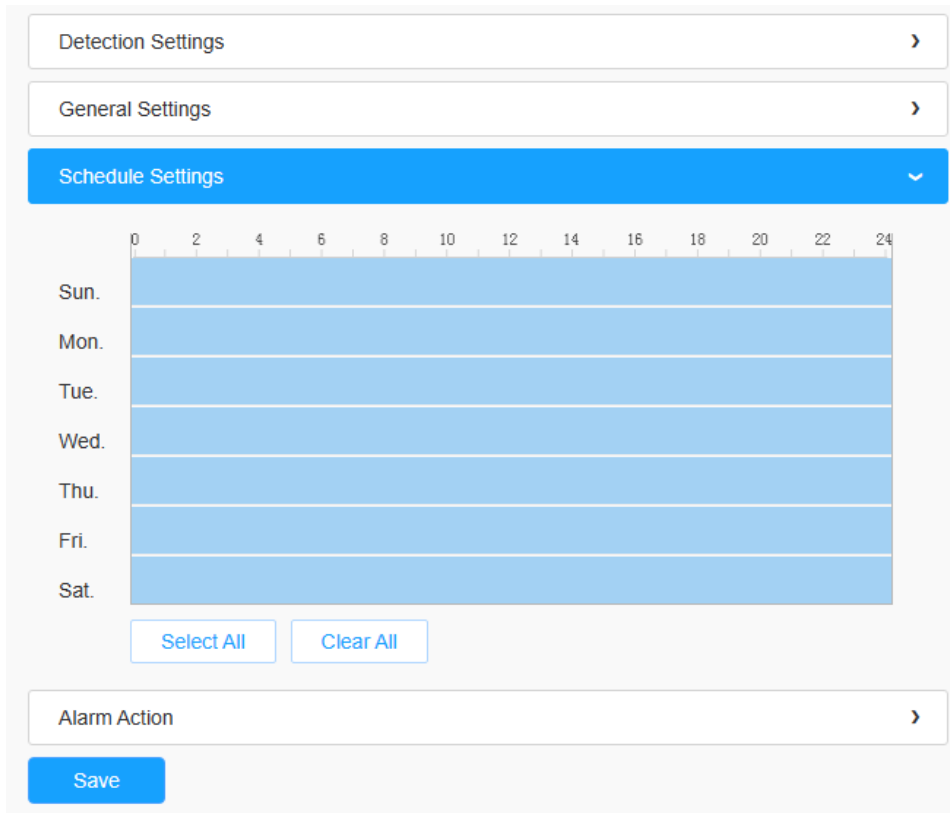


**Table 47. Description of the buttons**

Parameters	Function Introduction
<b>Sensitivity</b>	Level 1~10 is available, the default level is 5. The higher the sensitivity, the easier it is for moving objects to be recorded in the results.
<b>Min. Size</b>	Draw the screen or input pixel number to set the minimum size of the detected object. When the object is smaller than this size, it will not be detected. The default minimum size is 3*3.
<b>Max. Size</b>	Draw the screen or input pixel number to set the maximum size of the detected object. When the object is larger than this size, it will not be detected. The default maximum size is 320*240.

## [Schedule Settings]

**Step 4:** Set detection schedule;



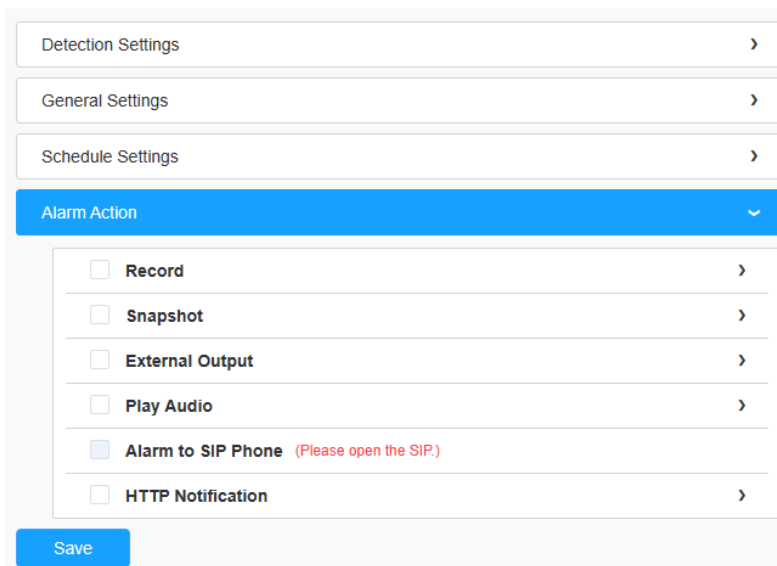
The screenshot shows a settings interface with the following elements:

- Three menu items at the top: "Detection Settings", "General Settings", and "Schedule Settings". "Schedule Settings" is highlighted in blue.
- A 24-hour time scale at the top of the schedule grid, with markers every 2 hours from 0 to 24.
- A grid with 7 rows representing the days of the week (Sun. to Sat.) and 24 columns representing hours. All cells in the grid are filled with a light blue color, indicating that the detection schedule is set for all days and all hours.
- Two buttons below the grid: "Select All" and "Clear All".
- An "Alarm Action" menu item at the bottom of the settings area.
- A "Save" button at the very bottom.

**Note:** This part is the same as the regular schedule settings. You can refer to *8.4.2.1 Region Entrance*.

## [Alarm Action]

**Step 5:** Set alarm action;



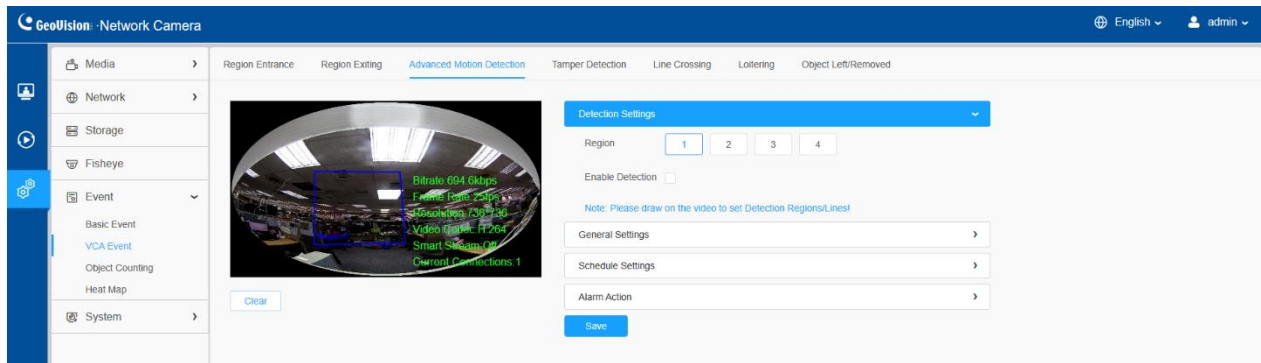
The screenshot shows a settings interface with a sidebar on the left containing five menu items: 'Detection Settings', 'General Settings', 'Schedule Settings', 'Alarm Action', and 'HTTP Notification'. The 'Alarm Action' menu item is highlighted in blue. The main content area displays a list of six alarm actions, each with an unchecked checkbox and a right-pointing chevron: 'Record', 'Snapshot', 'External Output', 'Play Audio', 'Alarm to SIP Phone (Please open the SIP.)', and 'HTTP Notification'. A blue 'Save' button is located at the bottom left of the main content area.

**Note:** This part is the same as the regular alarm settings.



### 8.4.2.3 Advanced Motion Detection

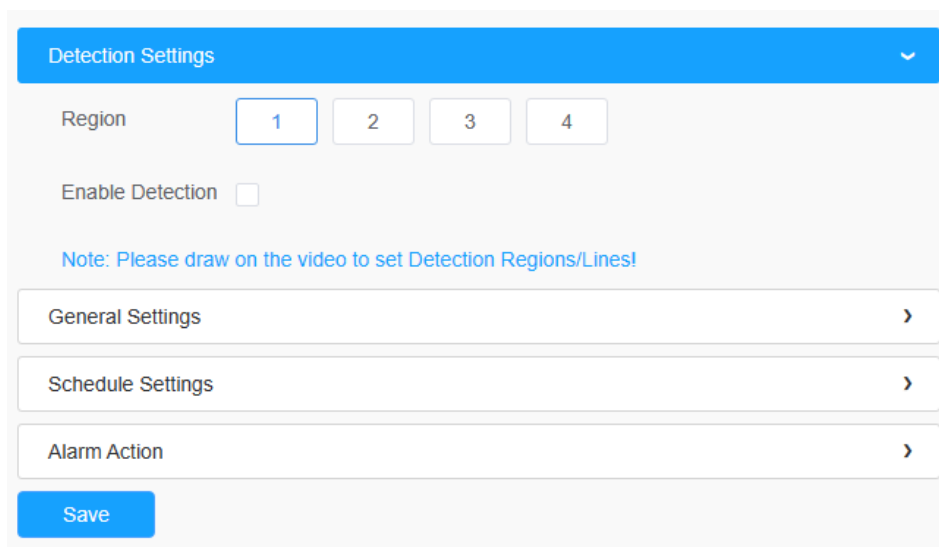
Different from traditional motion detection, advanced motion detection can filter out “noise” such as lighting changes, natural tree movements, etc. When an object moves in the selected area, it will trigger alarm.



Settings steps are shown as follows:

**Step 1:** Selected detection region.

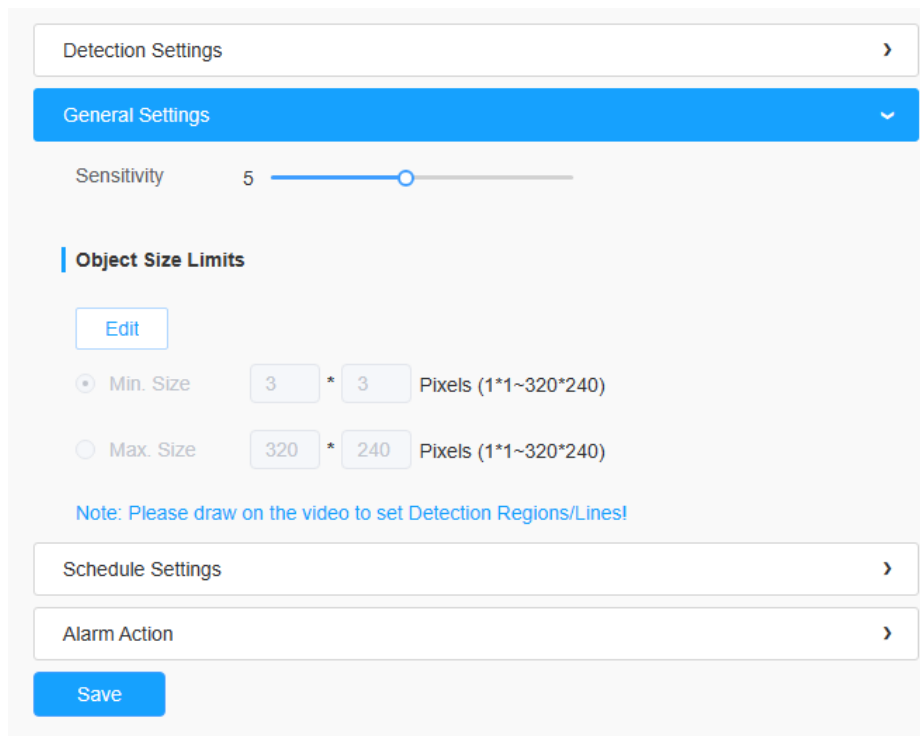
**Step 2:** Enable advanced motion detection.



**[General Settings]**

**Step 3:** Set Ignore Short-Lived Motion time. If you set the time, when the moving duration of an object is within the setting time, the alarm will not be triggered;

**Step 4:** Set detecting sensitivity and object size limits;



**Table 48. Description of the buttons**

Parameters	Function Introduction
<b>Ignore Short-Lived Motion</b>	<p>The alarm will not be triggered when the moving duration of an object is within the setting time. Off/1s/2s/3s/4s/5s are available.</p> <p><b>Note:</b> Ignore Short-Lived Motion time is to avoid false alarm caused by instant object movement within time setting.</p>
<b>Sensitivity</b>	<p>Level 1~10 is available, the default level is 5. The higher the sensitivity, the easier it is for moving objects to be recorded in the results.</p> <p><b>Note:</b> The sensitivity can be configured to detect various movement according to different requirements. When the level of sensitivity is low, slight movement won't trigger the alarm.</p>

<b>Min. Size</b>	Draw the screen or input pixel number to set the minimum size of the detected object. When the object is smaller than this size, it will not be detected. The default minimum size is 3*3.
<b>Max. Size</b>	Draw the screen or input pixel number to set the maximum size of the detected object. When the object is larger than this size, it will not be detected. The default maximum size is 320*240.

### [Schedule Settings]

**Step 5:** Set detection schedule;

**Note:** This part is the same as the regular schedule settings. You can refer to *8.4.2.1 Region Entrance*.

### [Alarm Action]

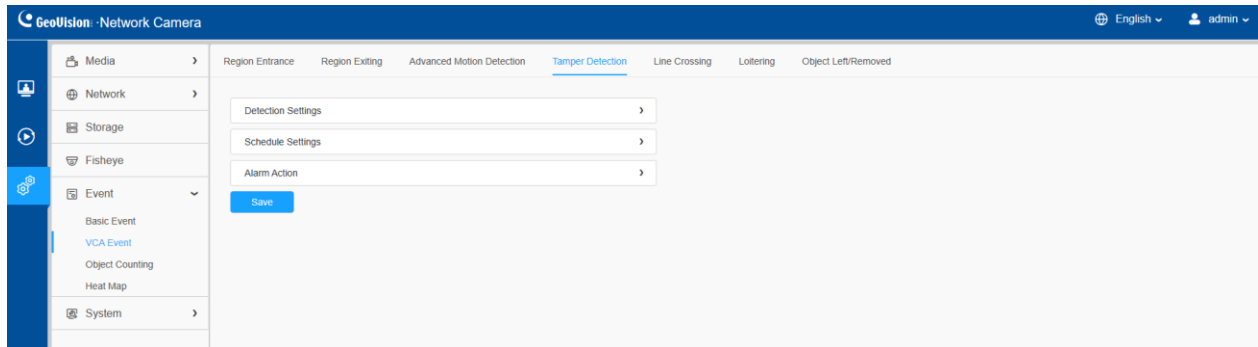
**Step 6:** Set alarm action;

**Note:**

- This part is the same as the regular alarm settings.
- If you enable External Output and choose Constant External Output Action Time, when object motion time is longer than the Ignore Short-Lived Motion time which you set in the selected regions, External Output Action alarm time will be always constant till the alarm is released.

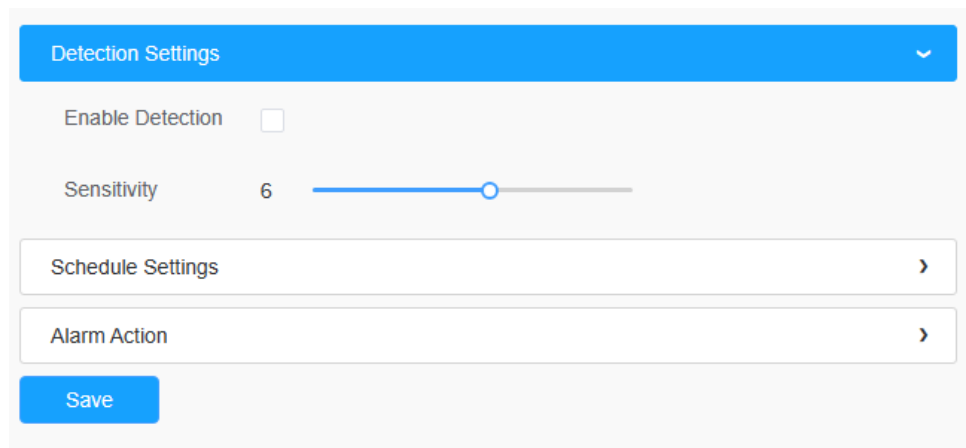
### 8.4.2.4 Tamper Detection

Tamper Detection is used to detect possible tampering like the camera being unfocused, obstructed or moved. This functionality alerts security staff immediately when any above-mentioned actions occur.



Settings steps are shown as follows:

**Step 1:** Enable Tamper Detection and set detecting sensitivity;



#### [Schedule Settings]

**Step 2:** Set detection schedule;

**Note:** This part is the same as the regular schedule settings. You can refer to [8.4.2.1 Region Entrance](#).

## [Alarm Action]

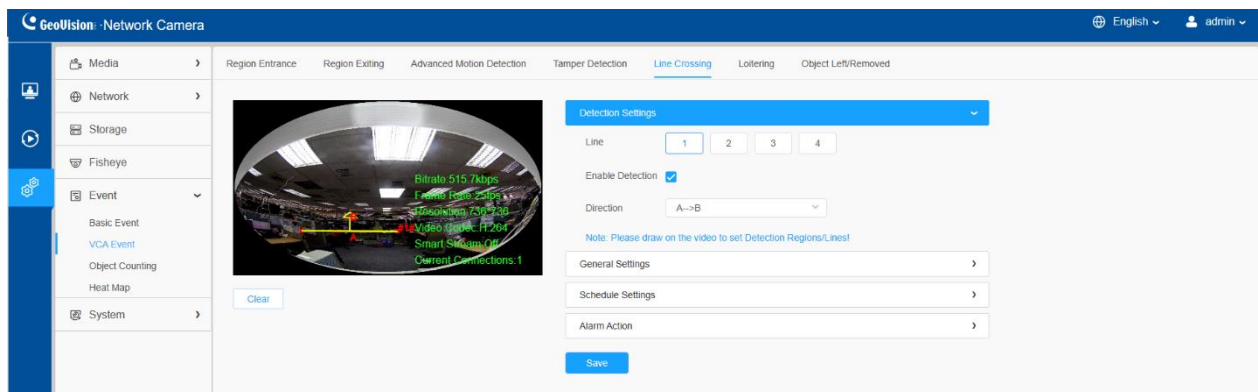
**Step 3:** Set alarm action;

### Note:

- This part is the same as the regular alarm settings.
- If you enable External Output and choose Constant External Output Action Time, when possible tampering is detected, External Output Action alarm time will be always constant till the alarm is released.
- The algorithm supports defocus detection in Tamper Detection function.

### 8.4.2.5 Line Crossing

Line Crossing detection is designed to work in most indoor and outdoor environment. An event will be triggered every time when the camera detects objects crossing a defined virtual line.

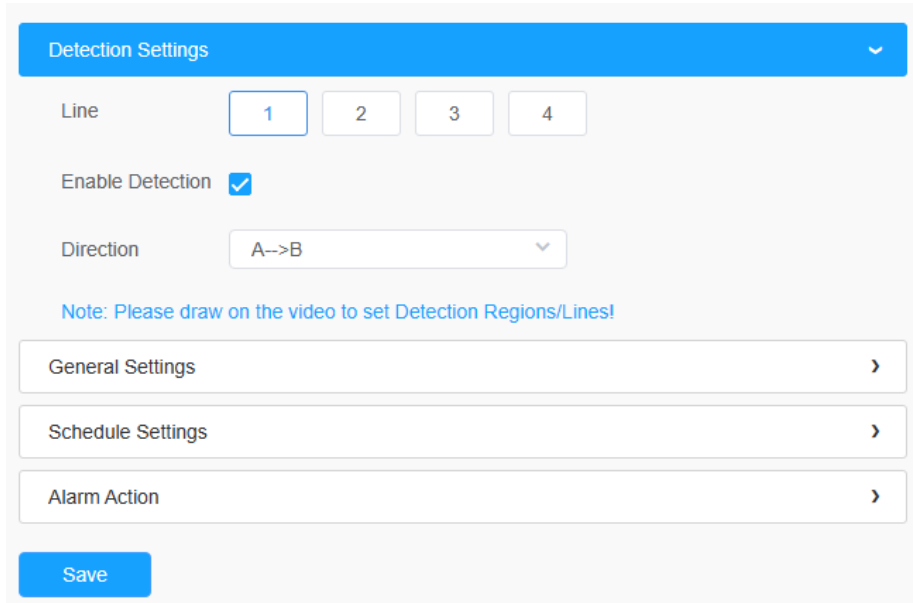


Settings steps are shown as follows:

## [Detection Settings]

**Step 1:** Selected detection line.

**Step 2:** Enable line crossing detection and define its direction.



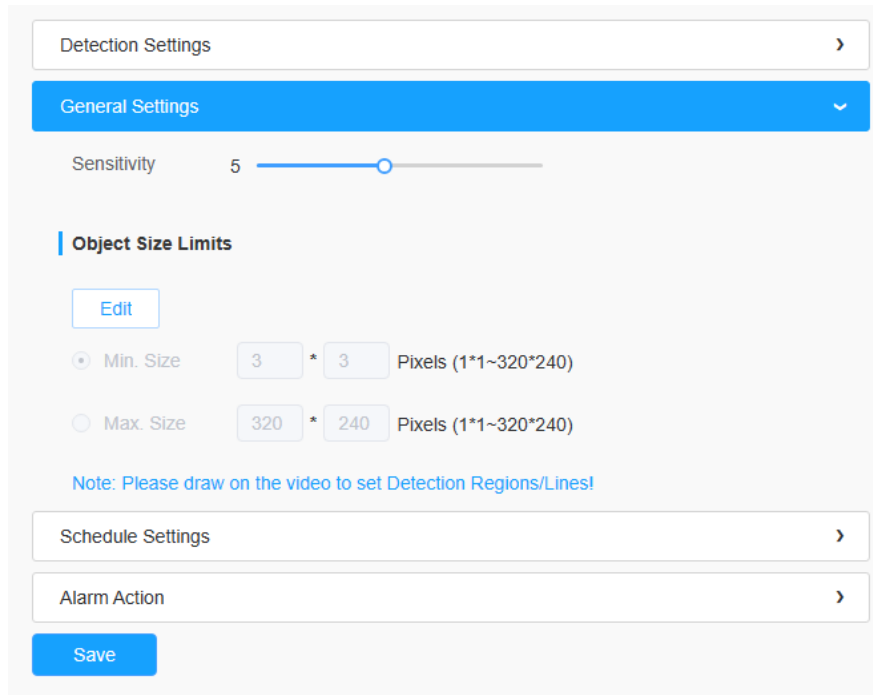
The screenshot shows the 'Detection Settings' interface. At the top is a blue header with the text 'Detection Settings' and a downward arrow. Below the header, there are four buttons labeled '1', '2', '3', and '4' for selecting a line. The '1' button is highlighted. Underneath, there is a checkbox labeled 'Enable Detection' which is checked. Below that is a dropdown menu labeled 'Direction' with 'A-->B' selected. A blue note below the dropdown reads: 'Note: Please draw on the video to set Detection Regions/Lines!'. At the bottom of the settings area, there are three expandable sections: 'General Settings', 'Schedule Settings', and 'Alarm Action', each with a right-pointing arrow. A blue 'Save' button is located at the very bottom of the interface.

### Note:

- Allows to set up to four lines at a time. There are three direction modes to choose for triggering alarm. “A→B” means when there is any object crossing the line from the “A” side to the “B” side, the alarm will be triggered. “B→A” vice versa. “A ↔ B” means that the alarm will be triggered when objects cross line from either side.

**[General Settings]**

**Step 3:** Set detecting sensitivity and object size limits;

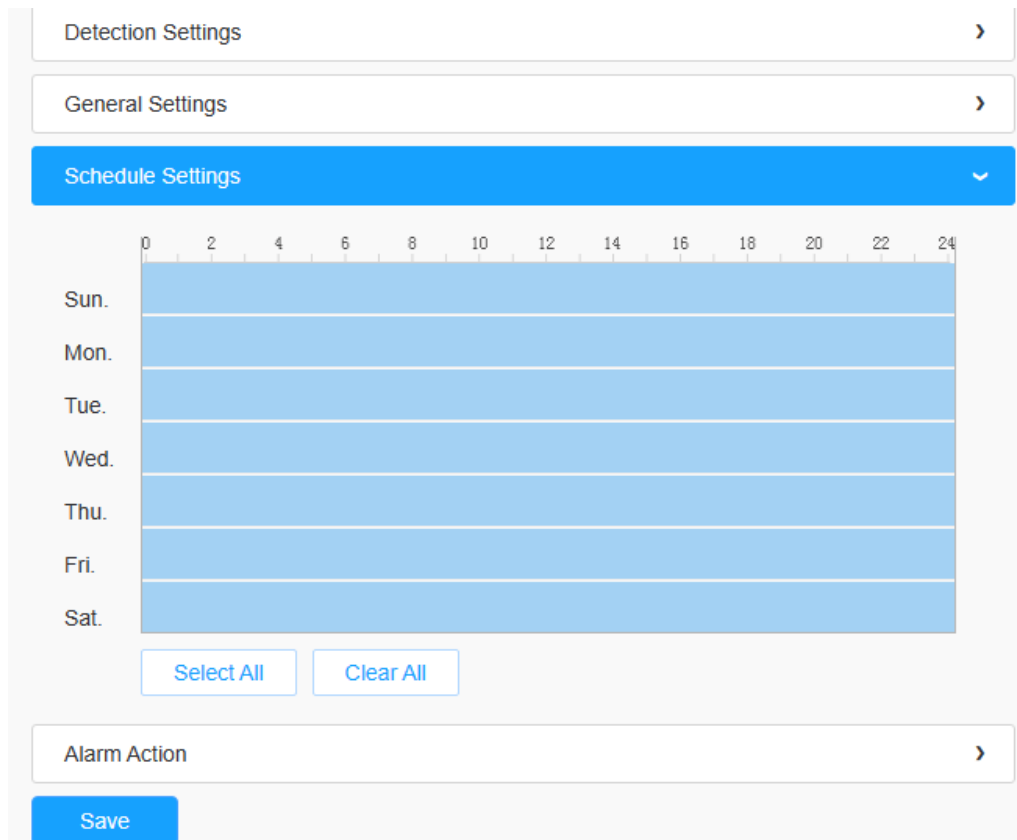


**Table 49. Description of the buttons**

Parameters	Function Introduction
<b>Sensitivity</b>	Level 1~10 is available, the default level is 5. The higher the sensitivity, the easier it is for moving objects to be recorded in the results.
<b>Min. Size</b>	Draw the screen or input pixel number to set the minimum size of the detected object. When the object is smaller than this size, it will not be detected. The default minimum size is 3*3.
<b>Max. Size</b>	Draw the screen or input pixel number to set the maximum size of the detected object. When the object is larger than this size, it will not be detected. The default maximum size is 320*240.

## [Schedule Settings]

**Step 4:** Set detection schedule;



Detection Settings >

General Settings >

Schedule Settings ▾

0 2 4 6 8 10 12 14 16 18 20 22 24

Sun.

Mon.

Tue.

Wed.

Thu.

Fri.

Sat.

Select All Clear All

Alarm Action >

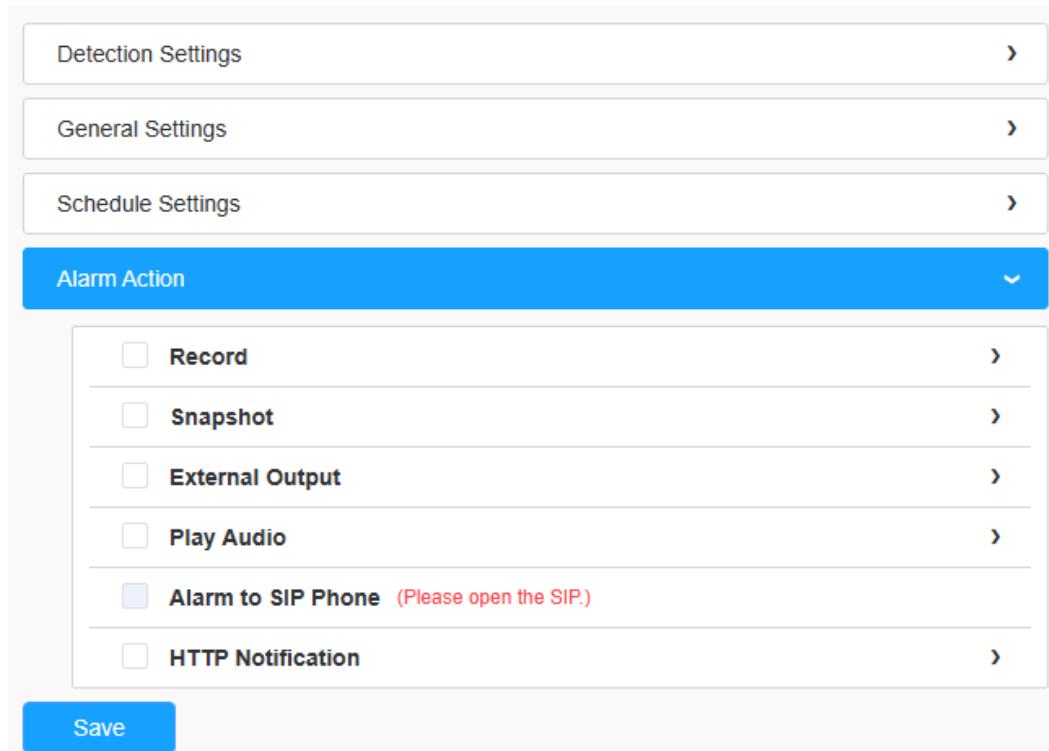
Save

**Note:** This part is the same as the regular schedule settings. You can refer to 8.4.2.1 *Region Entrance*.



## [Alarm Action]

**Step 5:** Set alarm action;



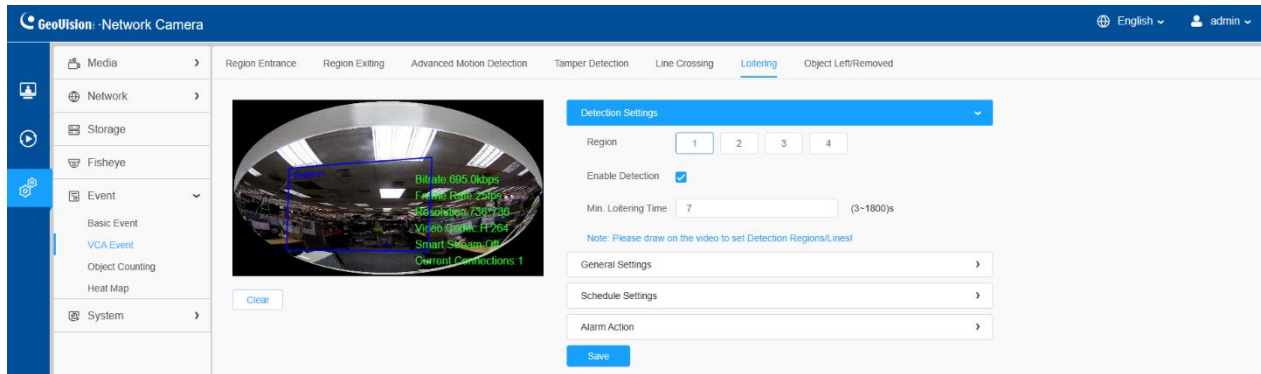
The screenshot shows a configuration interface for alarm actions. It features a vertical list of settings categories: Detection Settings, General Settings, Schedule Settings, and Alarm Action. The Alarm Action category is highlighted in blue and expanded to show a list of actions: Record, Snapshot, External Output, Play Audio, Alarm to SIP Phone (with a red note "(Please open the SIP.)"), and HTTP Notification. Each action has a checkbox and a right-pointing arrow. A blue Save button is located at the bottom left of the configuration area.

### Note:

- This part is the same as the regular alarm settings.
- If you enable External Output and choose Constant External Output Action Time, when objects cross a defined virtual line, External Output Action alarm time will be always constant till the alarm is released

### 8.4.2.6 Loitering

When objects are loitering in a defined area for a specific period of time, it would trigger an alarm.



Settings steps are shown as follows:

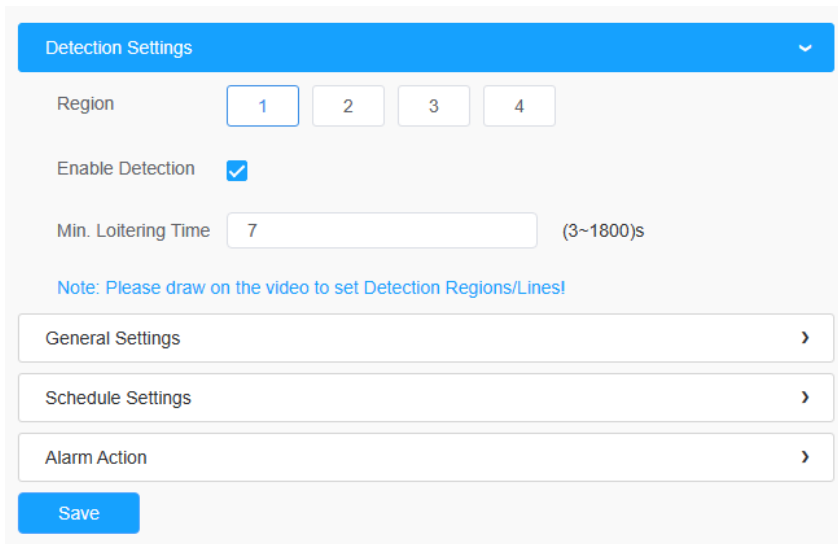
#### [Detection Settings]

**Note:** General Settings will take effect in all detection regions/lines!

**Step 1:** Selected detection region.

**Step 2:** Enable loitering detection.

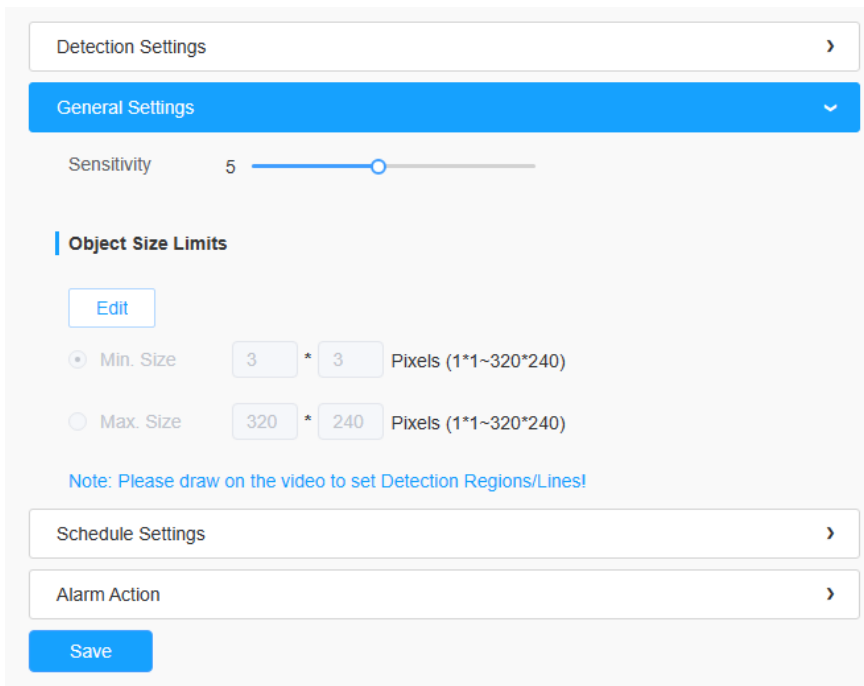
**Step 3:** Set Min. Loitering Time. After setting minimum loitering time from 3s to 1800s, any objects loitering in the selected area over the minimum loitering time will trigger the alarm;



The screenshot shows the 'Detection Settings' interface. At the top, there is a blue header with the text 'Detection Settings' and a dropdown arrow. Below this, there are four buttons labeled '1', '2', '3', and '4' for selecting a region. The 'Enable Detection' checkbox is checked. The 'Min. Loitering Time' is set to '7' with a range of '(3~1800)s'. A note below reads: 'Note: Please draw on the video to set Detection Regions/Lines!'. At the bottom, there are three expandable sections: 'General Settings', 'Schedule Settings', and 'Alarm Action', each with a right-pointing arrow. A blue 'Save' button is located at the very bottom.

### [General Settings]

**Step4:** Set object size limits;



The screenshot shows the 'General Settings' interface. At the top, there is a blue header with the text 'General Settings' and a dropdown arrow. Below this, there is a 'Sensitivity' slider set to '5'. A section titled 'Object Size Limits' contains an 'Edit' button and two radio button options: 'Min. Size' (selected) and 'Max. Size'. The 'Min. Size' is set to '3 \* 3' Pixels (1\*1~320\*240). The 'Max. Size' is set to '320 \* 240' Pixels (1\*1~320\*240). A note below reads: 'Note: Please draw on the video to set Detection Regions/Lines!'. At the bottom, there are two expandable sections: 'Schedule Settings' and 'Alarm Action', each with a right-pointing arrow. A blue 'Save' button is located at the very bottom.

**Table 50. Description of the buttons**

Parameters	Function Introduction
<b>Min. Size</b>	Draw the screen or input pixel number to set the minimum size of the detected object. When the object is smaller than this size, it will not be detected. The default minimum size is 3*3.
<b>Max. Size</b>	Draw the screen or input pixel number to set the maximum size of the detected object. When the object is larger than this size, it will not be detected. The default maximum size is 320*240.

**[Schedule Settings]**

**Step 4:** Set detection schedule;

**Note:** This part is the same as the regular schedule settings. You can refer to *8.4.2.1 Region Entrance*.

**[Alarm Action]**

**Step 5:** Set alarm action;

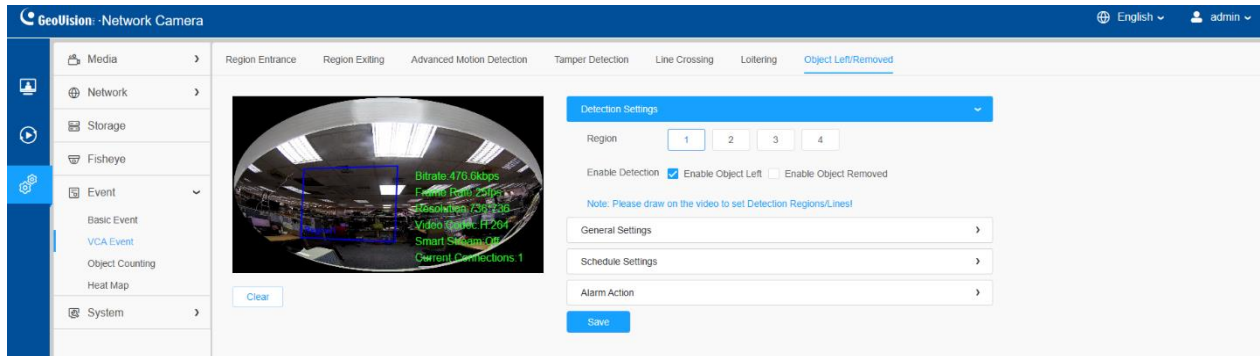
**Note:**

- This part is the same as the regular alarm settings.
- If you enable External Output and choose Constant External Output Action Time, when objects loiter in the selected regions, External Output Action alarm time will be always constant till the alarm is released.

**Step 5:** Set alarm settings. If you enable External Output and choose Constant External Output Action Time, when objects loiter in the selected regions, External Output Action alarm time will be always constant till the alarm is released.

### 8.4.2.7 Object Left/Removed

Object Left can detect and prompt an alarm if an object is left in a pre-defined region. Object Removed can detect and prompt an alarm if an object is removed from a pre-defined region.

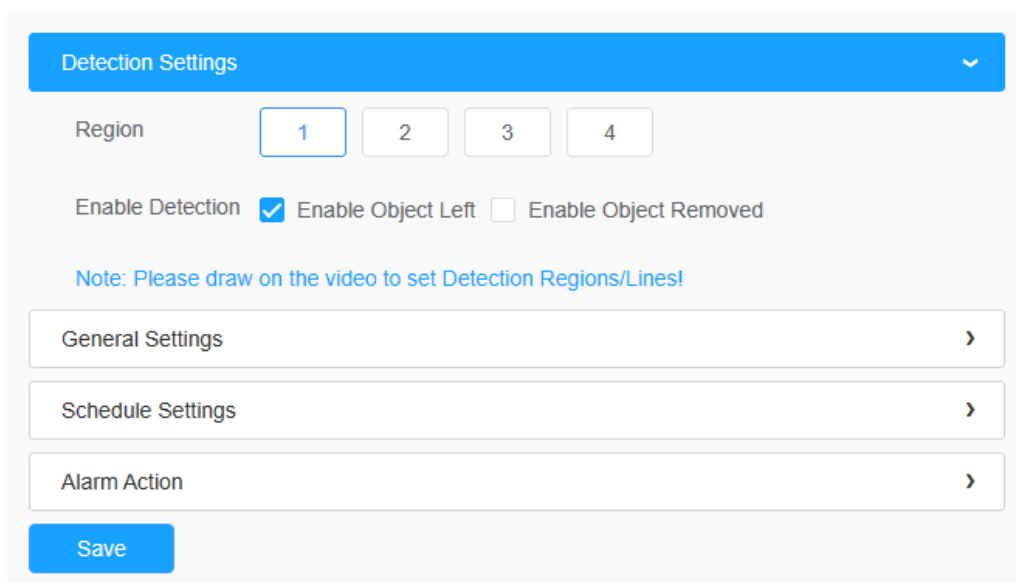


Settings steps are shown as follows:

#### [Detection Settings]

**Note:** General Settings will take effect in all detection regions/lines!

**Step 1:** Selected detection region and enable object left/removed detection (Or you can enable both features at the same time);



## [General Settings]

**Step 2:** Set Min. time, detecting sensitivity and object size limits.

Detection Settings
>

General Settings
v

Min. Time  (5~1800)s

Sensitivity 5

**Object Size Limits**

Min. Size  \*  Pixels (1\*1~320\*240)

Max. Size  \*  Pixels (1\*1~320\*240)

Note: Please draw on the video to set Detection Regions/Lines!

Schedule Settings
>

Alarm Action
>

**Table 51. Description of the buttons**

Parameters	Function Introduction
<b>Min. Time</b>	After setting Min. time from 5s to 1800s, any objects are left in the selected area or removed from the selected area over the minimum time will trigger the alarm.
<b>Sensitivity</b>	Level 1~10 is available, the default level is 5. The higher the sensitivity, the easier it is for moving objects to be recorded in the results. <b>Note:</b> The sensitivity can be configured to detect various movement according to different requirements. When the level of sensitivity is low, slight movement won't trigger the alarm.
<b>Min. Size</b>	Draw the screen or input pixel number to set the minimum size of the detected object. When the object is smaller than this size, it will not be detected. The default minimum size is 3*3.
<b>Max. Size</b>	Draw the screen or input pixel number to set the maximum size of the detected object. When the object is larger than this size, it will not be detected. The default maximum size is 320*240.

### [Schedule Settings]

**Step 5:** Set detection schedule;

**Note:** This part is the same as the regular schedule settings. You can refer to *8.4.2.1 Region Entrance*.

### [Alarm Action]

**Step 6:** Set alarm action;

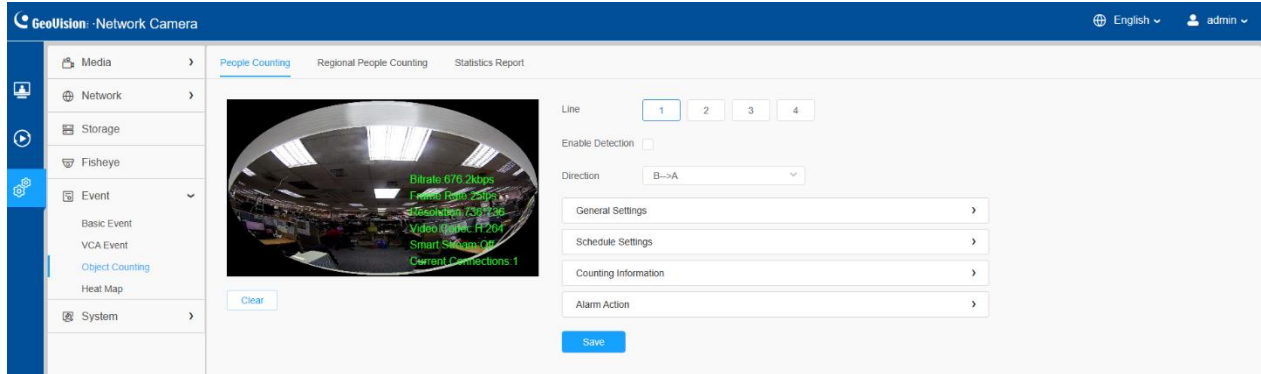
**Note:**

- This part is the same as the regular alarm settings.
- If you enable External Output and choose Constant External Output Action Time, when an object is left/removed from the selected regions, External Output Action alarm time will be always constant till the alarm is released.

## 8.4.3 Object Counting

### 8.4.3.1 People Counting

People Counting is able to count how many people enter or exit during the setting period.



Settings steps are as shown below:

**Step 1:** Enable People Counting;

**Step 2:** Set detection line and direction.

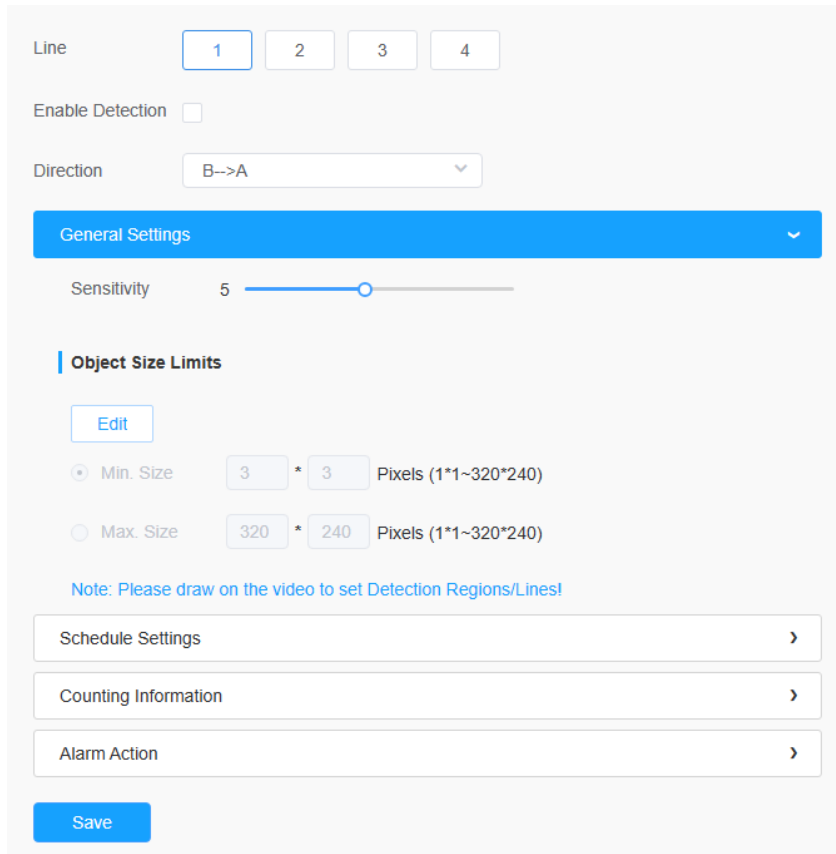
**Note:**

- Crossing along the direction of the arrow will record as “In”, opposite is “Out”.
- Support up to 4 detection lines.



## [General Settings]

**Step 3:** Set sensitivity and object size limits.



**Table 52. Description of the buttons**

Parameters	Function Introduction
<b>Sensitivity</b>	Level 1~10 is available, the default level is 5. The higher the sensitivity, the easier it is for moving objects to be recorded in the results.
<b>Min. Size</b>	Draw the screen or input pixel number to set the minimum size of the detected object. When the object is smaller than this size, it will not be detected. The default minimum size is 3*3.
<b>Max. Size</b>	Draw the screen or input pixel number to set the maximum size of the detected object. When the object is larger than this size, it will not be detected. The default maximum size is 320*240.

## [Schedule Settings]

**Step 4:** Set detection schedule;

**Note:** This part is the same as the regular schedule settings. You can refer to *8.4.2.1 Region Entrance*.

## [Counting Information]

**Step 5:** Set counting information;

### Counting Information

Count Type  All  
 In  Out  Sum  Capacity

**Total Counting** ⓘ

Show OSD

Font Size

Font Color

Text Position

**Single Counting**

Show Information

Manual Reset   
 Reset the statistics report together?

Auto Reset

Day

Time

Alarm Action

**Table 53. Description of the buttons**

<b>Parameters</b>	<b>Function Introduction</b>
<b>Count Type</b>	Users can choose the information they want to display in Live Video.
<b>Total Counting</b>	<p>Set counting OSD.</p> <p><b>Note:</b> The Total Counting OSD configuration is linked in all detection lines. <b>Show OSD:</b> Click to enable/disable the OSD shown.</p> <p><b>Font Size:</b> The font size of the OSD display.  <b>Font Color:</b> The font color of the OSD display.  <b>Text Position:</b> The text position of the OSD display.</p>
<b>Single Counting</b>	<p>Set Single Counting.</p> <p><b>Note:</b> The Total Counting OSD configuration is linked in all detection lines.</p> <p><b>Show Information:</b> Click to show the information.  <b>Manual Reset:</b> Reset the counting of each single line. You can choose to reset the statistics report together.  <b>Auto Reset:</b> It is used to automatically clear the single counting information. <b>Day:</b> The day of Auto Reset.  <b>Time:</b> The time of Auto Reset.</p>

## [Alarm Action]

**Step6:** Set alarm trigger and alarm action;

**Alarm Action** ▼

**Alarm Trigger**

Thresholds  In   Out

Capacity   Sum

**Alarm Action**

<input type="checkbox"/> Record	›
<input type="checkbox"/> Snapshot	›
<input type="checkbox"/> External Output	›
<input type="checkbox"/> Play Audio	›
<input checked="" type="checkbox"/> Alarm to SIP Phone <small>(Please open the SIP.)</small>	
<input type="checkbox"/> HTTP Notification	›

**Table 54. Description of the buttons**

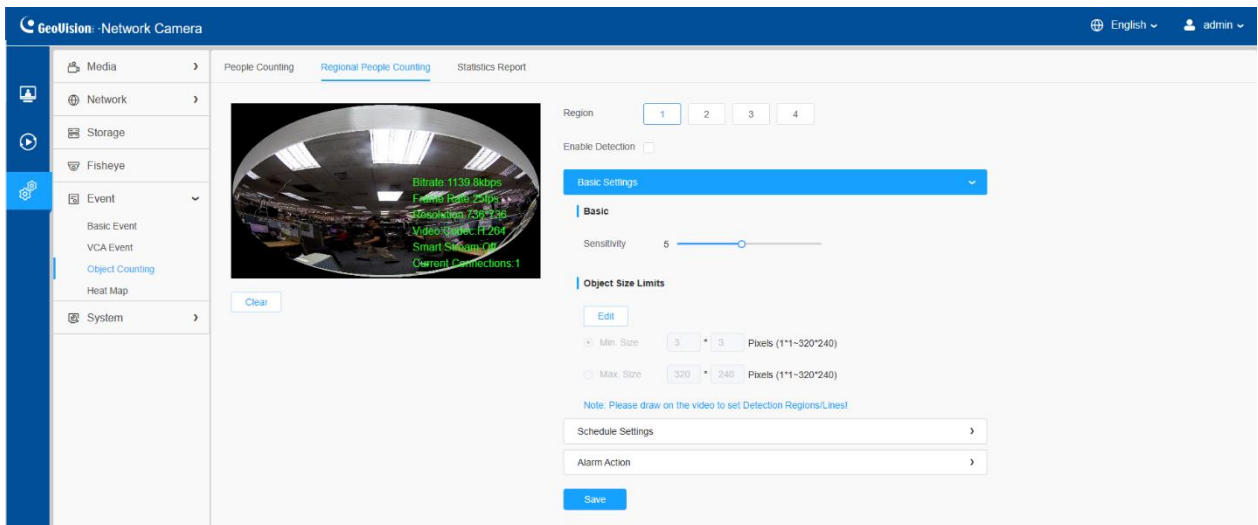
<b>Parameters</b>	<b>Function Introduction</b>
<b>Alarm Trigger</b>	<p>Alarm will be triggered when the threshold reaches to a certain value from 1 to 9999. Total Counting and Single Counting are available. You can set the Alarm Thresholds of In/Out/Capacity/Sum.</p> <p><b>Note:</b></p> <ul style="list-style-type: none"> <li>• For Total Counting, the thresholds are the sum of the total number of 4 detection lines.</li> <li>• For Single Counting, the threshold is for the selected detection line.</li> </ul>
<b>Alarm Action</b>	<p>This part is the same as the regular alarm settings.</p> <p><b>Note:</b></p> <ul style="list-style-type: none"> <li>• The alarm action is effective on 4 detection lines simultaneously.</li> <li>• If you enable External Output and choose Constant External Output Action Time, when the thresholds reach to a certain value you set, External Output Action alarm time will be always constant till the alarm is released.</li> </ul>

#### 8.4.3.2 Regional People Counting

When enabling Regional People Counting, users can check the real-time number of people and the time of each person's stay in the detection region.

**Note:**

- Support up to 4 detection regions for regional people counting.
- Users can check the real-time number of people and the time of each person's stay in the detection region on Live View interface.



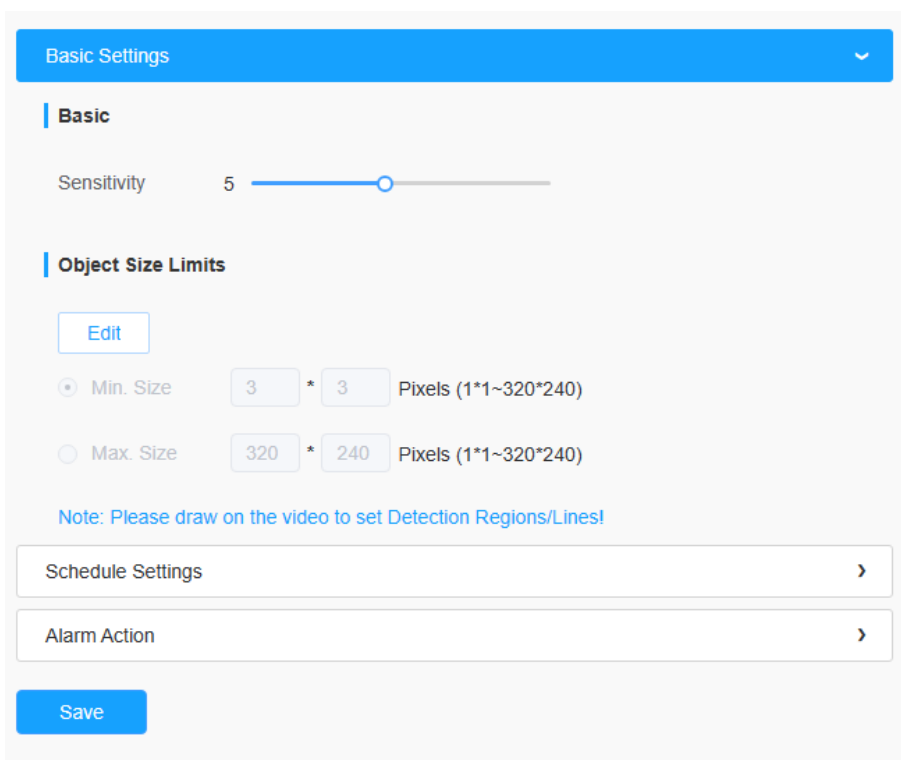
Settings steps are as shown below:

**Step 1:** Select Detection Region and enable regional people counting detection;

**Note:** Support up to 4 detection regions.

### [Basic Settings]

**Step 2:** Set sensitivity and object size limits.



**Table 55. Description of the buttons**

Parameters	Function Introduction
<b>Sensitivity</b>	Level 1~10 is available, the default level is 5. The higher the sensitivity, the easier it is for moving objects to be recorded in the results.
<b>Min. Size</b>	Draw the screen or input pixel number to set the minimum size of the detected object. When the object is smaller than this size, it will not be detected. The default minimum size is 3*3.
<b>Max. Size</b>	Draw the screen or input pixel number to set the maximum size of the detected object. When the object is larger than this size, it will not be detected. The default maximum size is 320*240.

**[Schedule Settings]**

**Step 4:** Set detection schedule;

**Note:** This part is the same as the regular schedule settings. You can refer to *8.4.2.1 Region Entrance*.

## [Alarm Action]

**Step 6:** Set alarm trigger and alarm action;

Alarm Action ▾

**Alarm Trigger**

Thresholds  Max.Stay  (1~60)

Min.Stay  (1~60)

Max.Length of Stay  s (1~1800)

**Alarm Action**

<input type="checkbox"/> Record	▸
<input type="checkbox"/> Snapshot	▸
<input type="checkbox"/> External Output	▸
<input type="checkbox"/> Play Audio	▸
<input checked="" type="checkbox"/> Alarm to SIP Phone <small>(Please open the SIP.)</small>	
<input type="checkbox"/> HTTP Notification	▸

**Save**

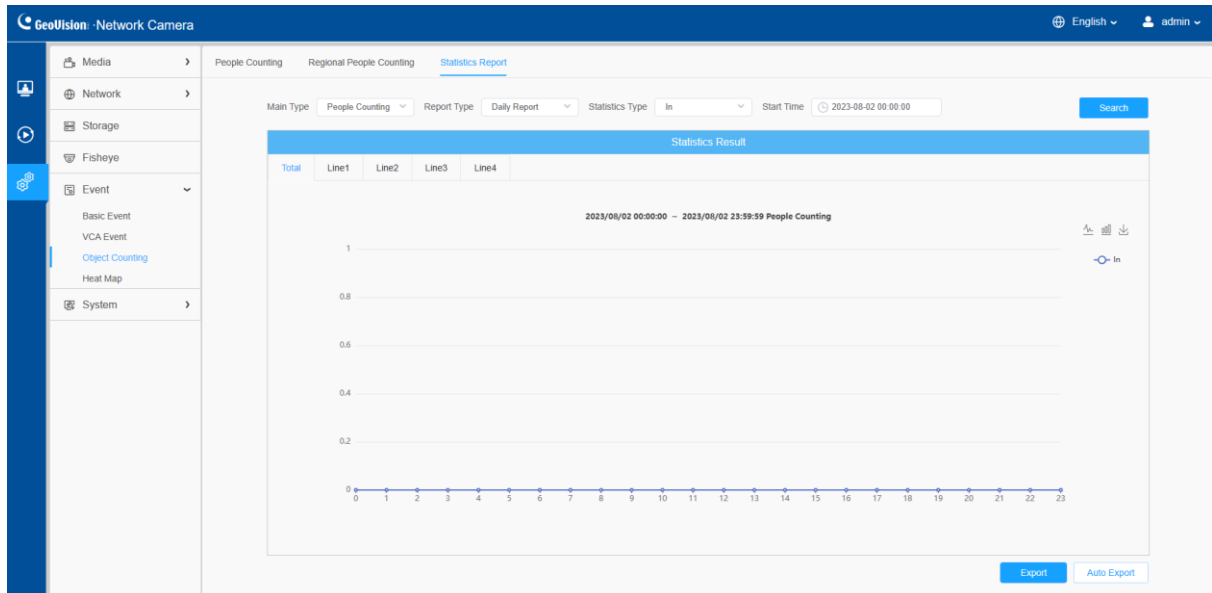


**Table 56. Description of the buttons**

<b>Parameters</b>	<b>Function Introduction</b>
<b>Alarm Trigger</b>	Alarm will be triggered when the Max./Min. Stay/Max. Length of Stay thresholds reaches to the value. <b>Note:</b> The value must be in the range of 1 to 60.
<b>Alarm Action</b>	This part is the same as the regular alarm settings. <b>Note:</b> <ul style="list-style-type: none"> <li>• The alarm action is effective on 4 detection regions simultaneously.</li> <li>• If you enable External Output and choose Constant External Output Action Time, when the thresholds reach to a certain value you set, External Output Action alarm time will be always constant till the alarm is released.</li> </ul>

### 8.4.3.3 Statistics Report

The results during the enabling period will be displayed on “**Statistics Report**” interface.



**Step 1:** Select Main Type;

**Step 2:** Select Report Type including Daily Report, Weekly Report, Monthly Report and Annual Report;

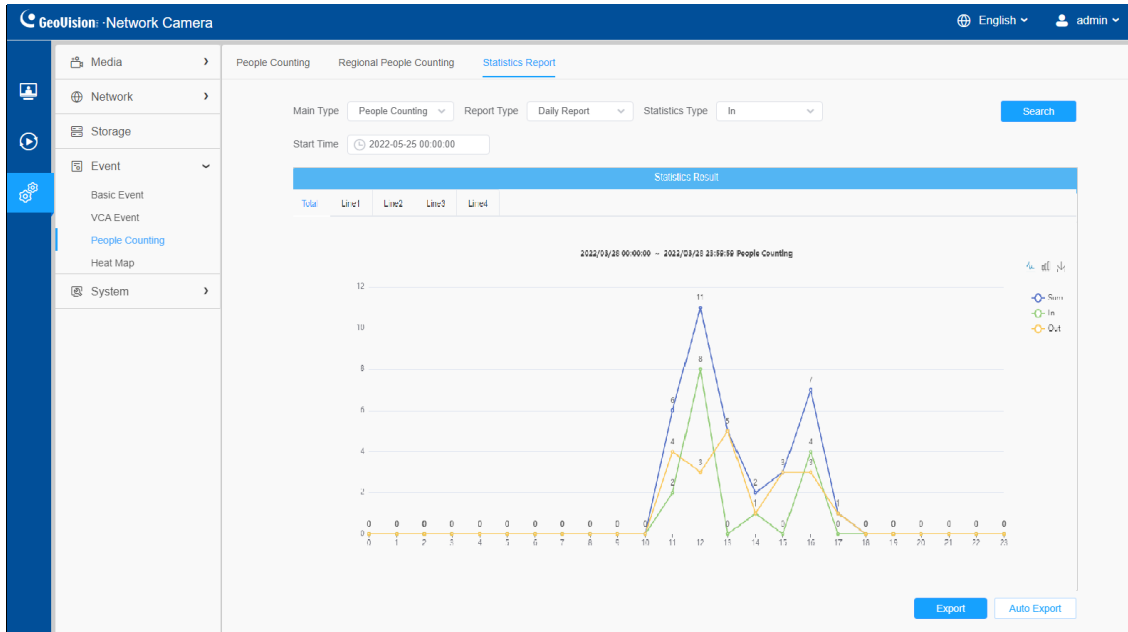
**Step 3:** For people counting, select Statistics Type including In, Out and Sum. For regional people counting, select Length of Stay including All, More Than and Less Than and set the time.

**Note:** For regional people counting, check the check box to search the report of regions as needed.

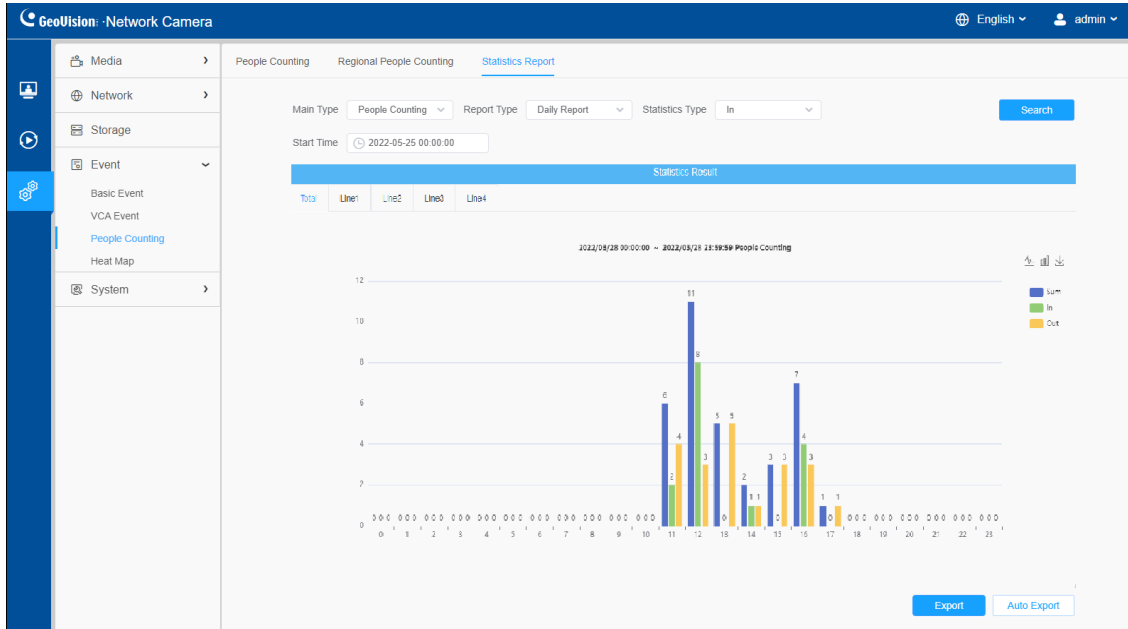
**Step 4:** Select Start Time, then click "Search" button, the camera will automatically count the data for the day/ week/ month/ year (based on the report type selected by the user) from the start time and generate the corresponding report.

**Step 5:** Moreover, you can also click "Line Chart" or "Bar Chart" to switch display mode of Statistics Report as shown below.

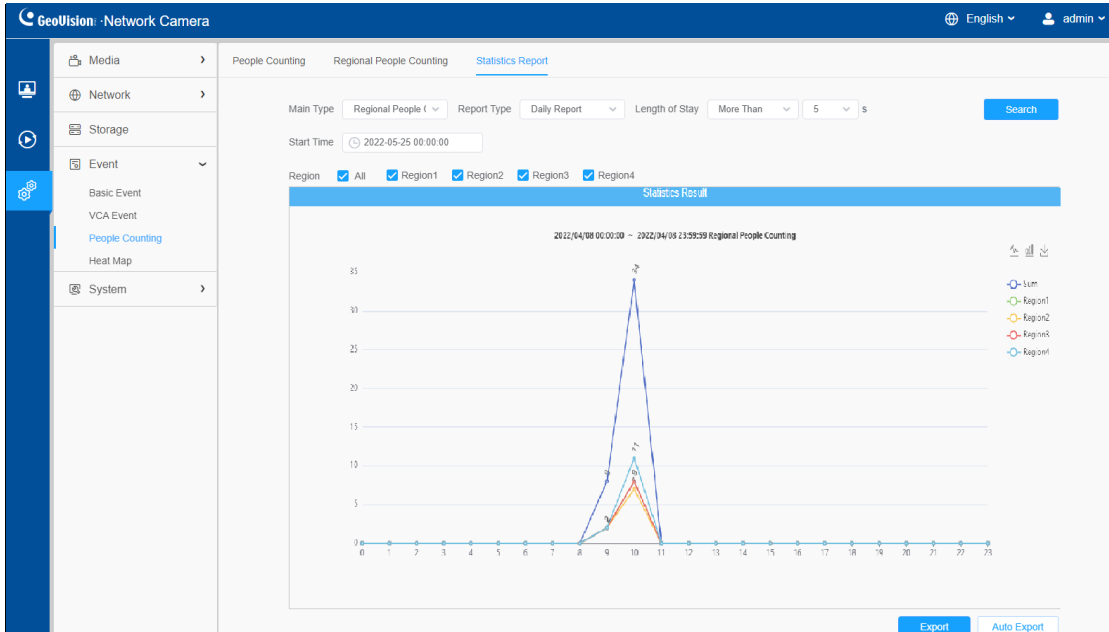
### People Counting-Statistics Report (Line Chart)



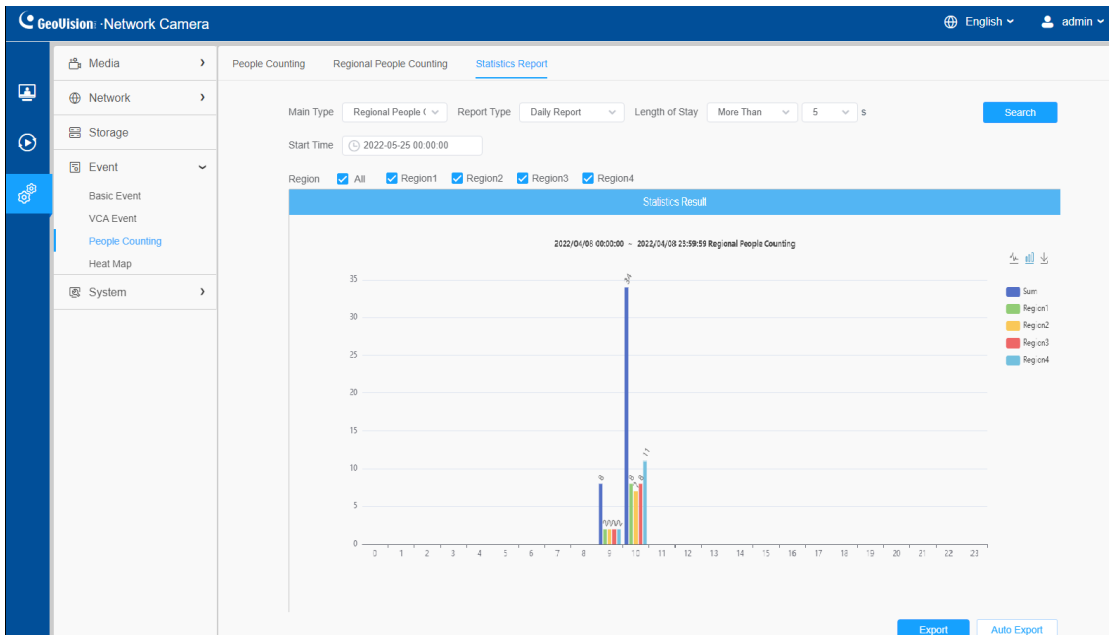
### People Counting-Statistics Report (Bar Chart)



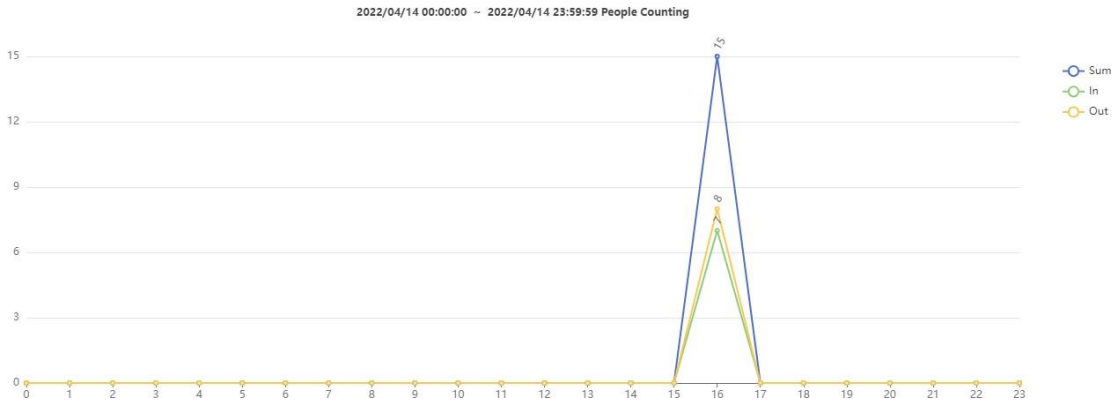
### Regional People Counting-Statistics Report (Line Chart)



### Regional People Counting-Statistics Report (Bar Chart)

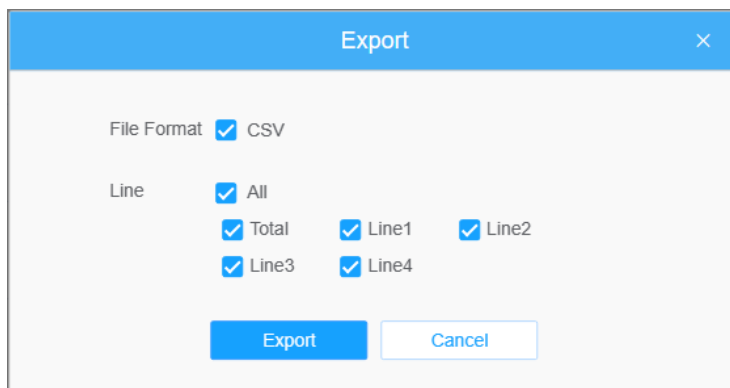


**Step 6:** Click "Download" button to download the screenshot of the statistical report chart.

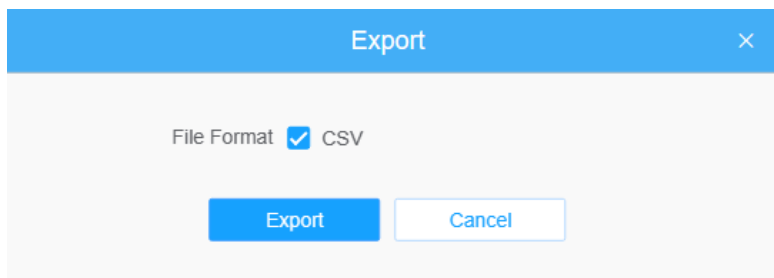


**Step 7:** Click "Export" button to pop up the Export window as shown below, and you can choose File Format to export the report to local. For people counting Statistics Report, you can check the check box to export the report of different lines as needed.

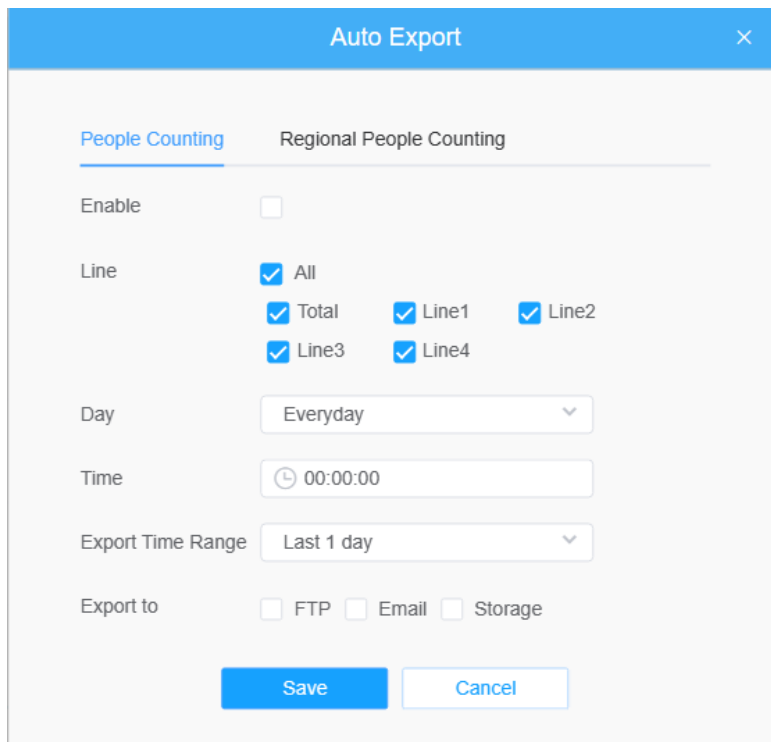
*People Counting-Export*



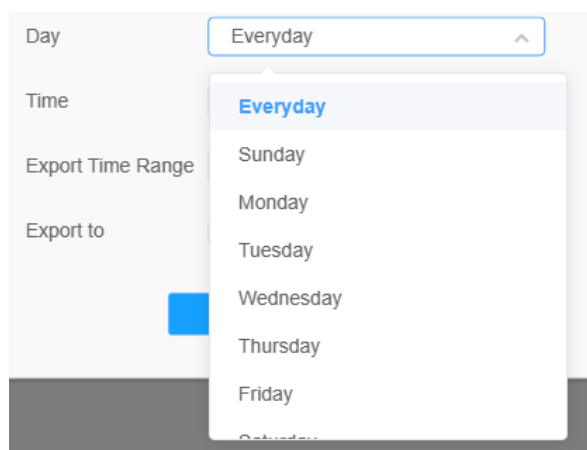
*Regional People Counting-Export*



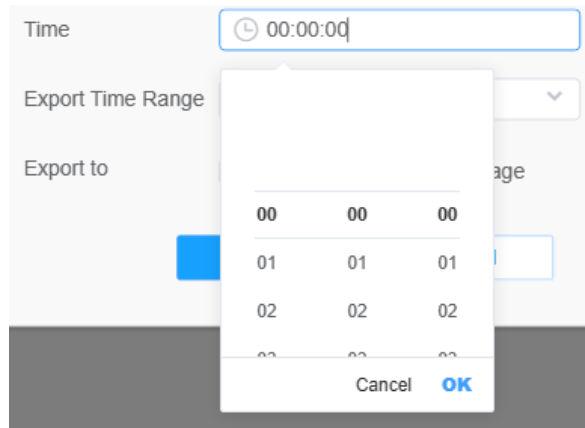
**Step 8:** Click "Auto Export" button to pop up the Statistics Report Settings as shown below.



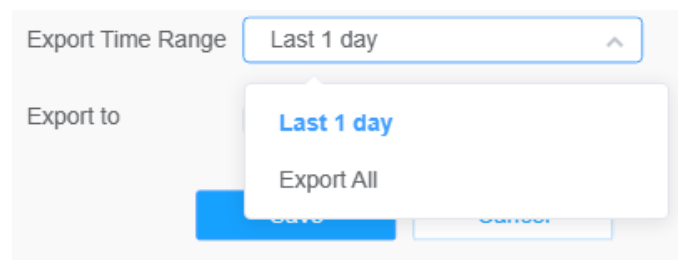
- Check the check box to enable the auto export of people counting, then select the lines as needed.
- Set Day. User can choose Everyday to export daily reports, while choosing others to export reports on a specific day of the week;



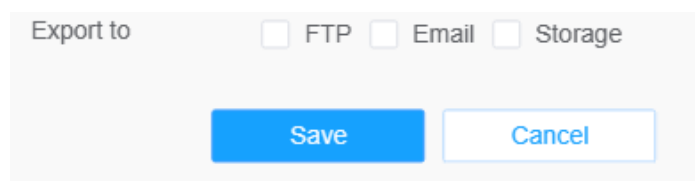
- Set Time. User can choose the time of day to export the Statistics Report automatically, click the calendar icon to pop up the following Quick Selection;



- Set Export Time Range;

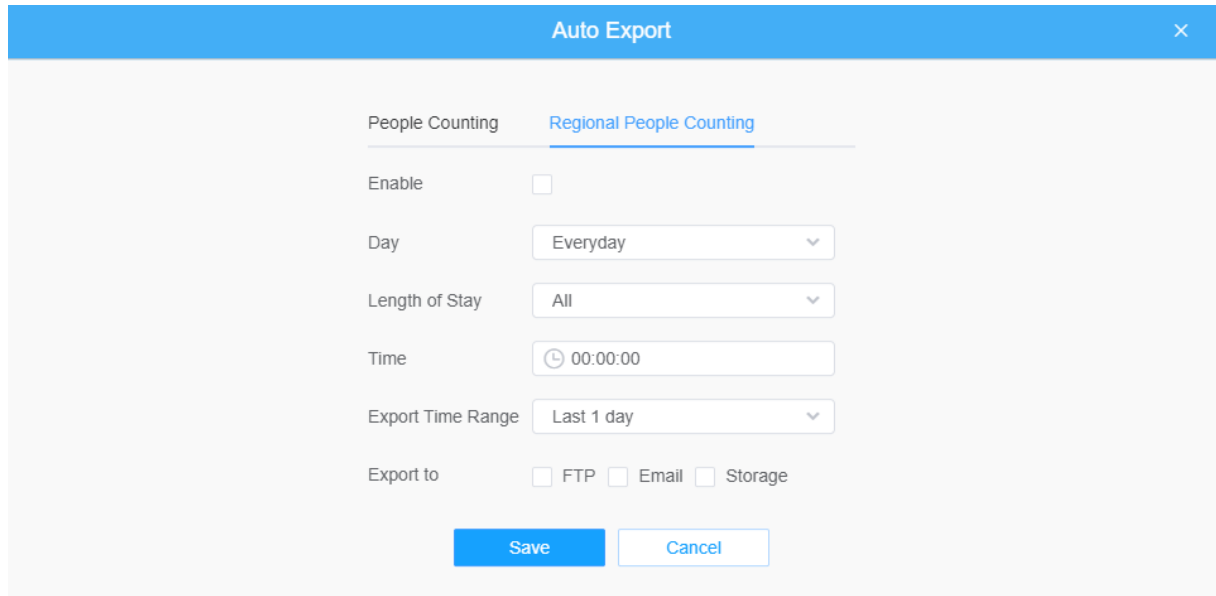


- Set the destination path of the automatically exported report. The report can be exported to FTP/ Email/Storage automatically as the form of an Excel spreadsheet according to the day, time and export time range you set. Then click "Save".



**Note:** If the current Statistics Report is generated, it will be saved as a csv form.

## Regional People Counting-Auto Export

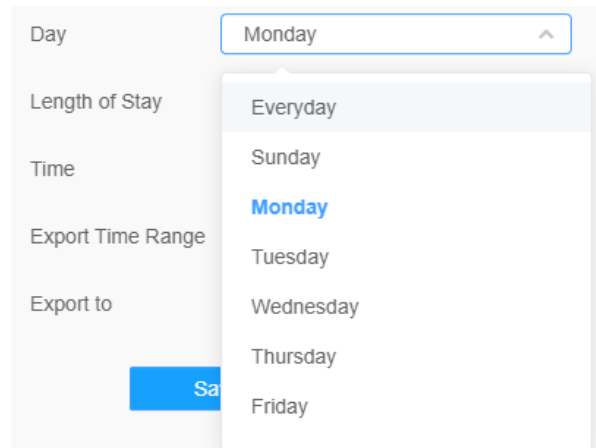


The screenshot shows a configuration window titled "Auto Export" with a close button (X) in the top right corner. The window is divided into two tabs: "People Counting" and "Regional People Counting", with the latter being the active tab. The configuration options are as follows:

- Enable:** A checkbox that is currently unchecked.
- Day:** A dropdown menu set to "Everyday".
- Length of Stay:** A dropdown menu set to "All".
- Time:** A time input field set to "00:00:00".
- Export Time Range:** A dropdown menu set to "Last 1 day".
- Export to:** Three checkboxes for "FTP", "Email", and "Storage", all of which are unchecked.

At the bottom of the window, there are two buttons: a blue "Save" button and a white "Cancel" button with a blue border.

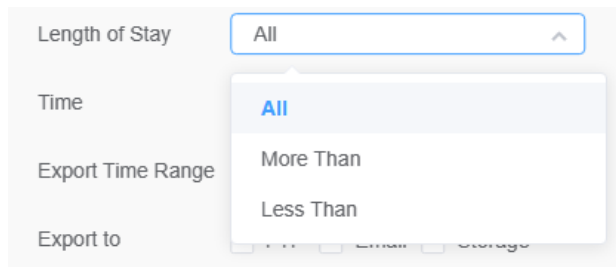
- Check the check box to enable the auto export of regional people counting.
- Set Day. User can choose Everyday to export daily reports, while choosing others to export reports on a specific day of the week;



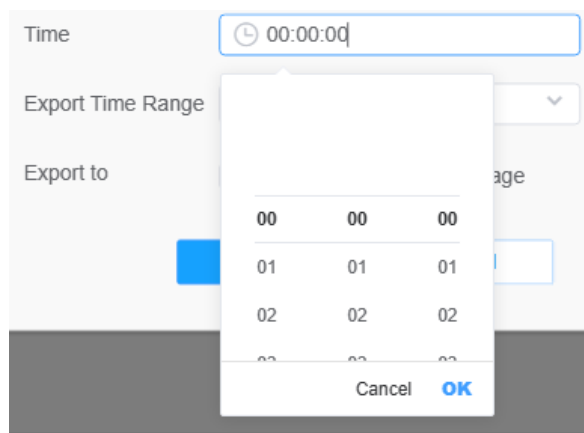
This image is a close-up of the "Day" dropdown menu from the configuration window. The dropdown is open, showing a list of days of the week. The "Monday" option is highlighted in blue, indicating it is the selected value. The other options listed are "Everyday", "Sunday", "Tuesday", "Wednesday", "Thursday", and "Friday". A "Save" button is partially visible at the bottom left of the dropdown menu.



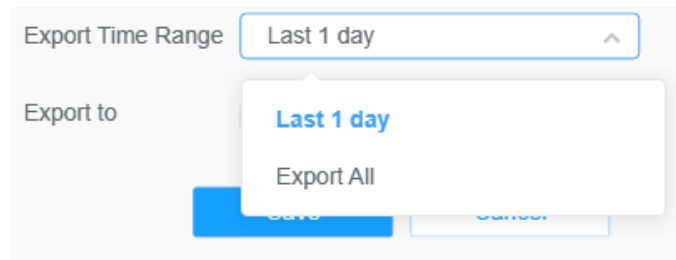
- Set Length of Stay.



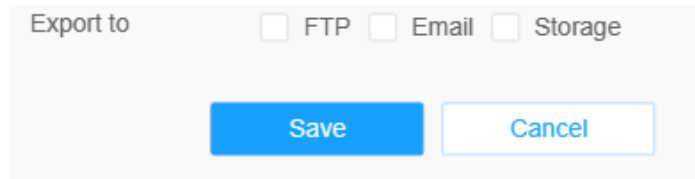
- Set Time. User can choose the time of day to export the Statistics Report automatically, click the calendar icon to pop up the following Quick Selection;



- Set Export Time Range;



- Set the destination path of the automatically exported report. The report can be exported to FTP/ Email/Storage automatically as the form of an Excel spreadsheet according to the day, time and export time range you set. Then click “Save”.

A dialog box titled 'Export to' with three radio button options: 'FTP', 'Email', and 'Storage'. Below the options are two buttons: 'Save' (a solid blue button) and 'Cancel' (a white button with a blue border).

**Note:** If the current Statistics Report is generated, it will be saved as a csv form.

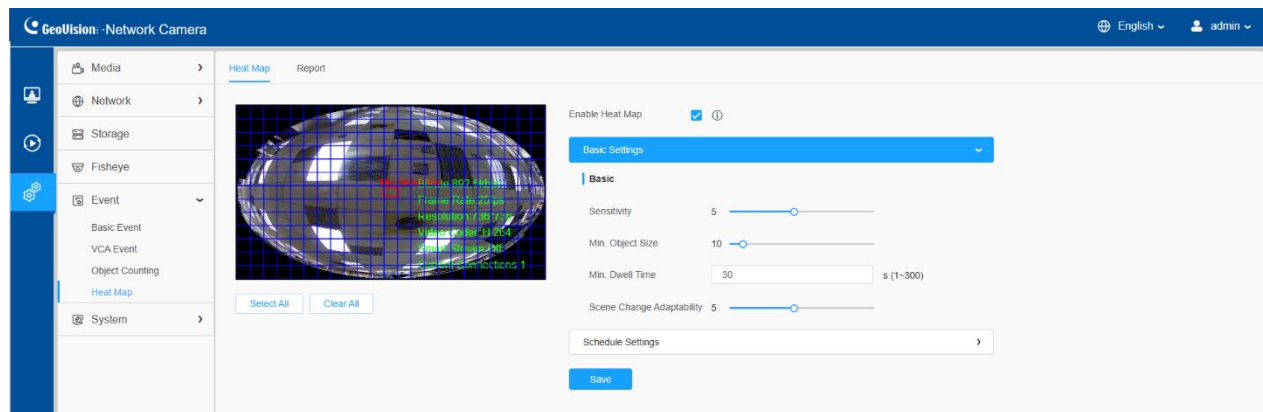
## 8.4.4 Heat Map

Heat Map function can analyze customers movement to reveal insights for better business management with the intuitive and accurate statistical analysis results in time or space pattern as needed.

### 8.4.4.1 Heat Map

**Note:**

- Only allowed to view reports within 7 days without a SD card or NAS.



**Step 1:** Enable Heat Map function.

## [Basic Settings]

Enable Heat Map  ⓘ

Basic Settings
▾

**Basic**

Sensitivity 5

Min. Object Size 10

Min. Dwell Time  s (1~300)

Scene Change Adaptability 5

Schedule Settings
▸

Save

**Table 57. Description of the buttons**

Parameters	Function Introduction
<b>Sensitivity</b>	Level 1~10 is available, the default level is 5. The higher the sensitivity, the easier it is for moving objects to be recorded in the results.
<b>Min. Object Size</b>	Set the minimum object size from 1 to 100, the default value is 10. Objects smaller than this value will not be recorded in the result.
<b>Min. Dwell Time</b>	Set the minimum dwell time from 1 to 300, the default value is 30. If the object stays in the area longer than the set "Minimum Dwell Time", it will not be recorded in the result.
<b>Scene Change Adaptability</b>	Level 1~10 is available, the default level is 5. Scene Change Adaptability indicates the camera's adaptability to scene changes, which can increase the accuracy of detection. The camera better adapts to faster changing scenes if the value is higher.

**Step 2:** Set Heat Map Region. Draw the screen to set the detection area. You can click "**Select All**" button to select all areas, or "**Clear All**" button to remove the current drawn area.

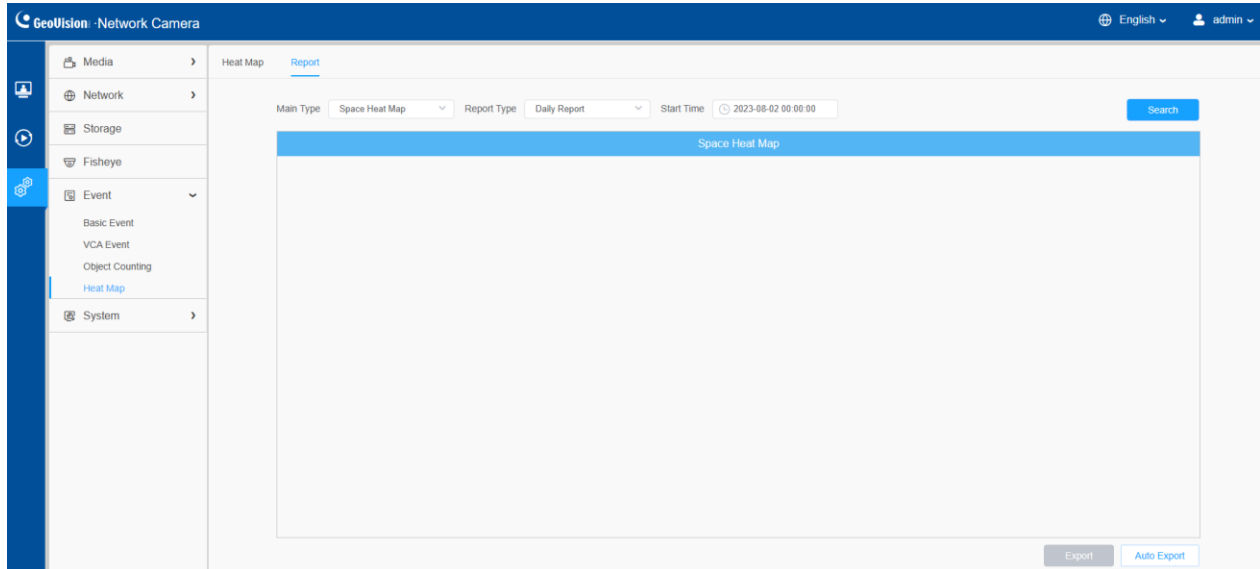
**[Schedule Settings]**

**Step 3:** Schedule Settings.

**Note:** This part is the same as the regular schedule settings. You can refer to *8.4.2.1 Region Entrance*.

## 8.4.4.2 Report

The heat map results will be displayed on this interface.



**Step 1:** Select Main Heat Map Type.

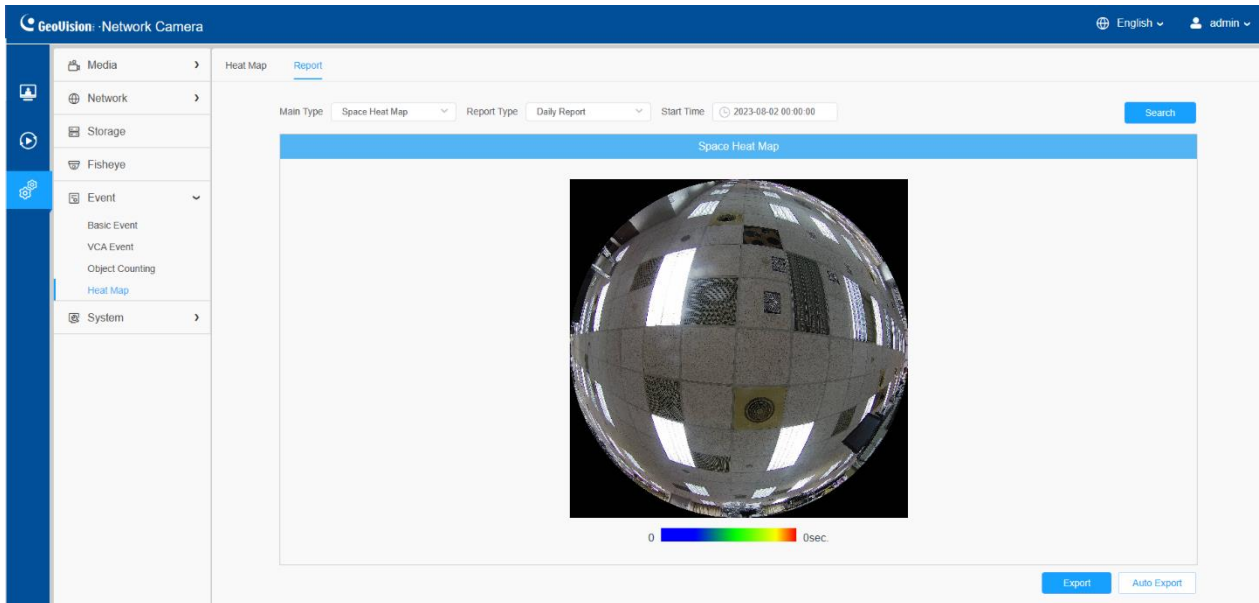
**[Space Heat Map]:** Space Heat Map will be presented as a picture with different colors. Different colors represent different heat values. Red represents the highest and blue represents the lowest.

**[Time Heat Map]:** Time heat map will be presented as a line chart to show the heat at different times.

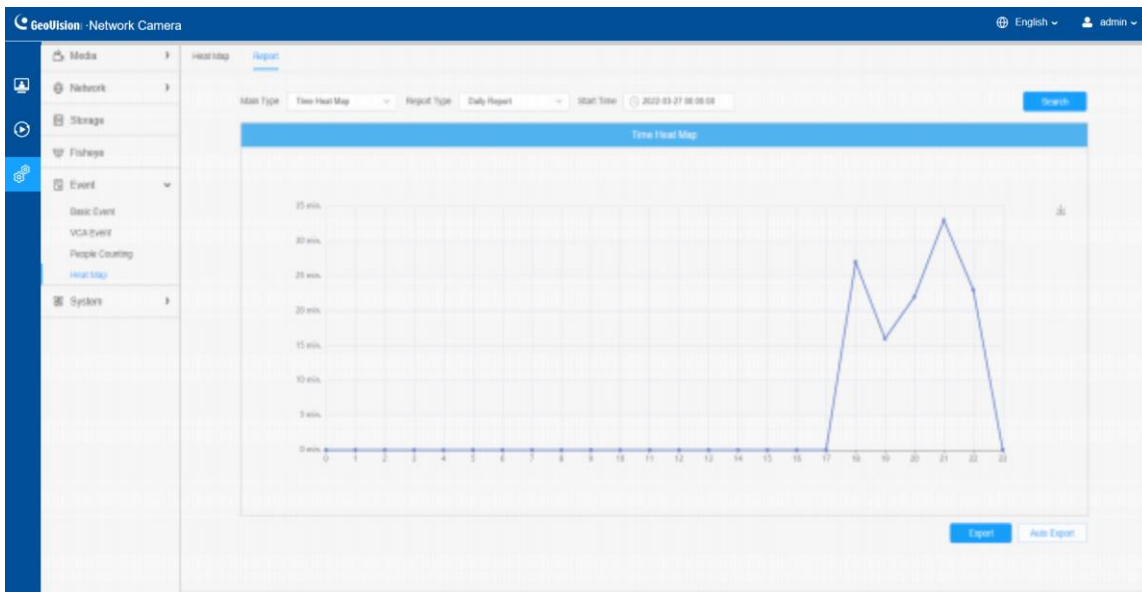
**Step 2:** Select Report Type including Daily Report, Weekly Report, Monthly Report and Annual Report.

**Step 3:** Select Start Time, then click the "**Search**" button, the camera will automatically count the data for the day/ week/ month/ year (based on the report type selected by the user) from the start time and generate the corresponding report as shown below.

## Space Heat Map

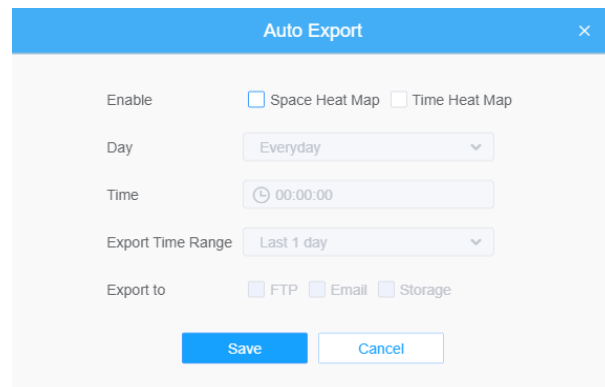


## Time Heat Map

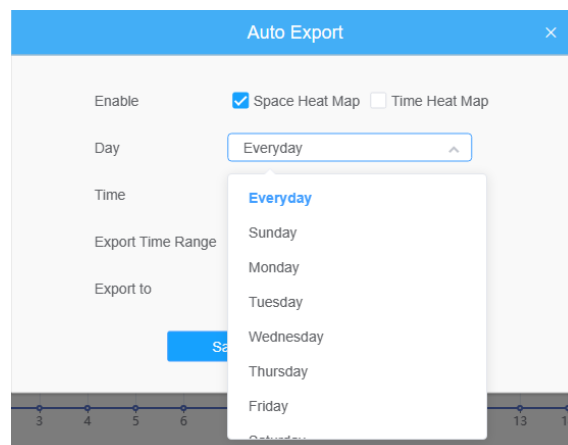


**Step 4:** Click the "Report Export" button to export the report to local.

**Step 5:** Click the "Auto Export" button to pop up the Heat Map Report Settings as shown below.

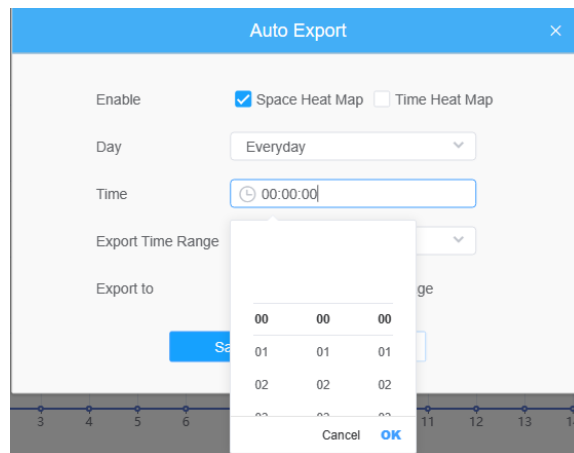


- Set Export Type. User can check Space Heat Map or Time Heat Map or both. When either Space Heat Map or Time Heat Map is checked, the gray item becomes editable as shown below;
- Set Day. User can choose Everyday to export daily reports, while choosing others to export reports on a specific day of the week;

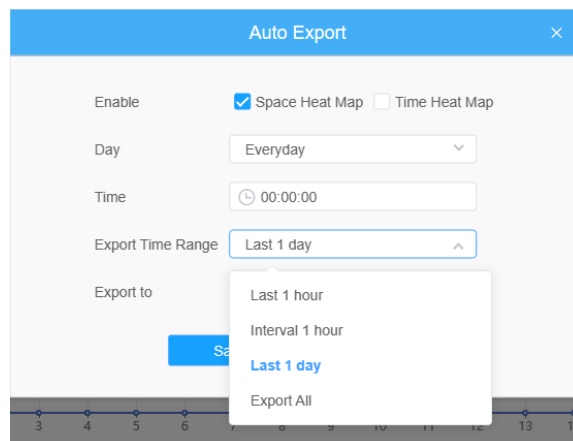




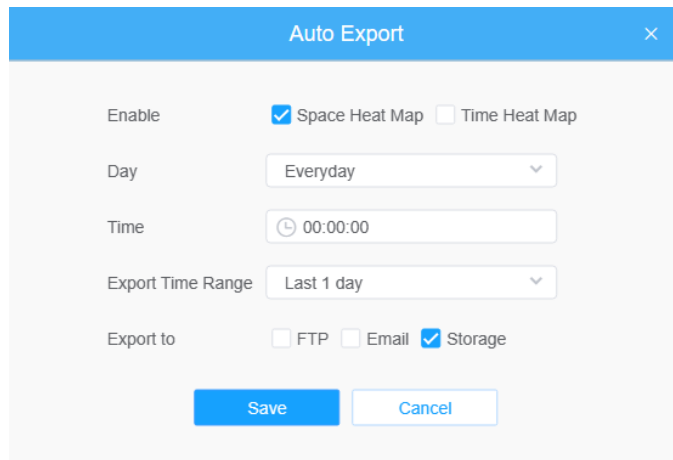
- Set Time. User can choose the time of day to export the heat map automatically, click the calendar icon to pop up the following Quick Selection;



- Set Export Time Range.



- Set the destination path of the automatically exported report. The report can be exported to FTP/ Email/Storage automatically as the form of an Excel spreadsheet or a picture according to the day, time and export time range you set. Then click “Save”.



The screenshot shows a dialog box titled "Auto Export" with a close button (X) in the top right corner. The dialog contains the following settings:

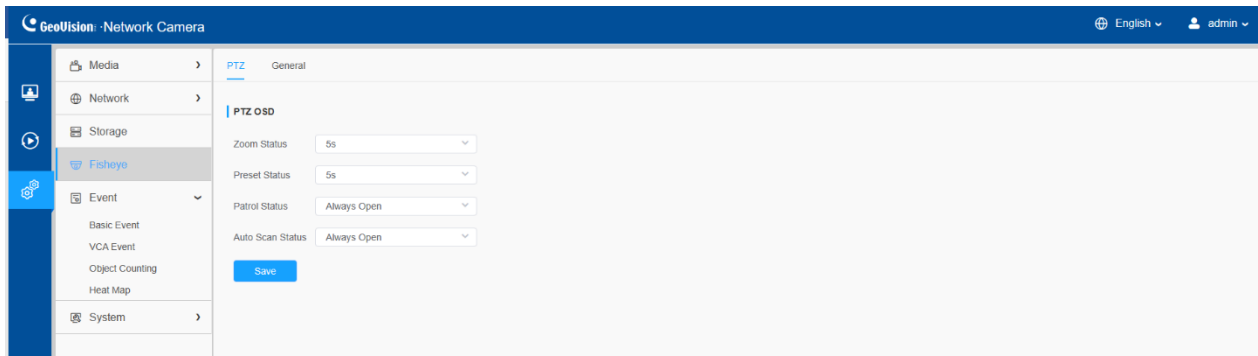
- Enable:**  Space Heat Map  Time Heat Map
- Day:** Everyday (dropdown menu)
- Time:** 00:00:00 (clock icon)
- Export Time Range:** Last 1 day (dropdown menu)
- Export to:**  FTP  Email  Storage

At the bottom of the dialog are two buttons: "Save" (highlighted in blue) and "Cancel".

If the current Space Heat Map is generated, it will be saved as a png image. If the current Time Heat Map is generated, it will be saved as a csv form.

## 8.5 Fisheye

[PTZ]



**Table 58. Description of the buttons**

Parameters	Function Introduction
<b>Zoom Status</b>	Support to set display time of Zoom Status OSD. 2 seconds/5 seconds/10 seconds/Always Open/Always Close are available.
<b>Preset Status</b>	Support to set display time of Preset Status OSD. 2 seconds/5 seconds/10 seconds/Always Open/Always Close are available.
<b>Patrol Status</b>	Support to set display time of Patrol Status OSD. Always Open/Always Close are available.
<b>Auto Scan Status</b>	Support to set display time of Auto Scan Status OSD. Always Open/Always Close are available.

[General]

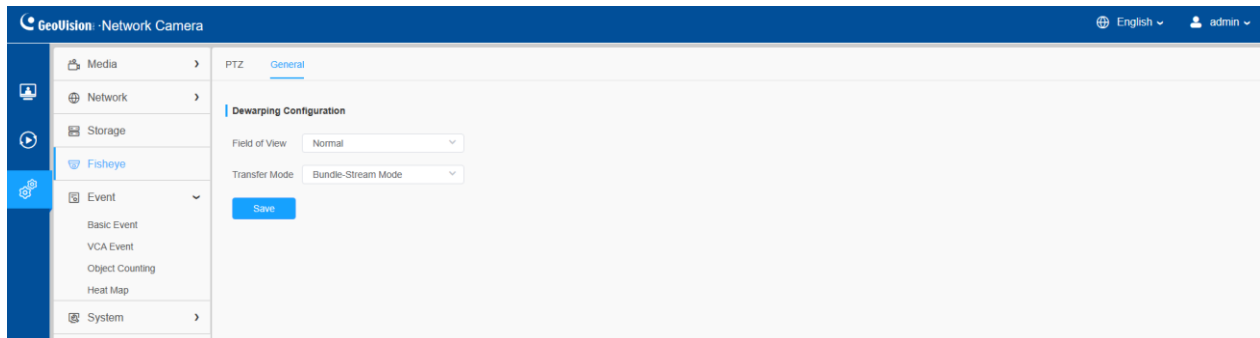


Table 59. Description of the buttons

Parameters	Function Introduction
<p><b>Field of View</b></p>	<p>Support optional Field of View on fisheye camera.</p> <p><b>Normal:</b> With this option enabled, all views will maintain the original viewing angle.</p> <p><b>Original View Larger:</b> With this option enabled, the original view(10) will have a larger viewing angle, and the other views will maintain the original viewing angle.</p> <p><b>All View Larger:</b> With this option enabled, all views will have a larger viewing angle.</p>
<p><b>Transfer Mode</b></p>	<p>Support to choose Bundle-Stream Mode or Multi-Channel Mode to meet different needs.</p> <p><b>Bundle-Stream Mode:</b> The Bundle-Stream Mode combines all the channels into one and sends to NVR or VMS, which is easy for compatibility.</p> <p><b>Multi-Channel Mode:</b> The Multi-Channel Mode sends all the original channels to NVR or VMS, so the channels can be modified separately.</p>

## 8.6 System

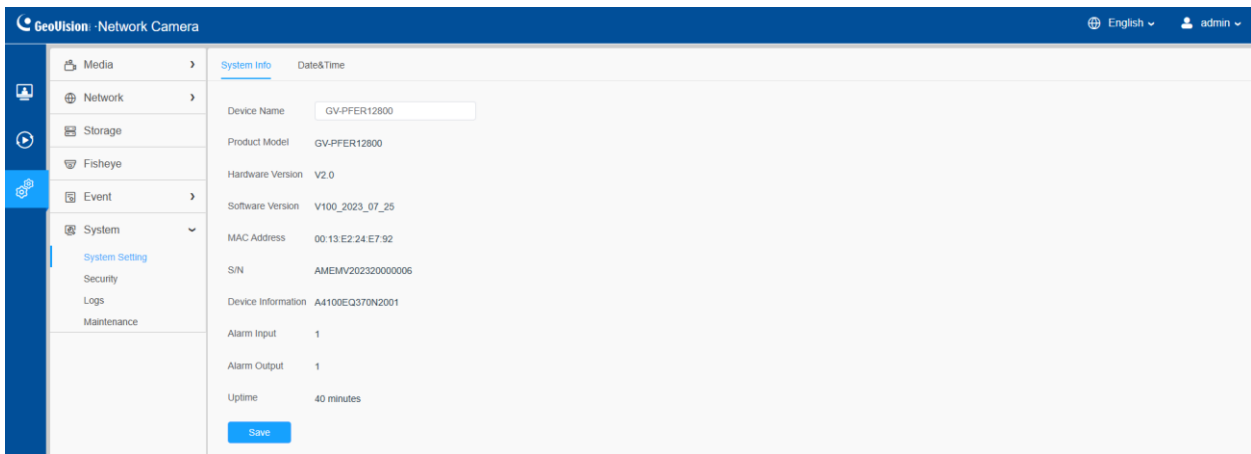
Here you can configure System Setting, Security, Logs and Maintenance.

### 8.6.1 System Setting

Here you can check System information and Date & Time.


#### 8.6.1.1 System info

All information about the hardware and software of the camera can be checked on this page.

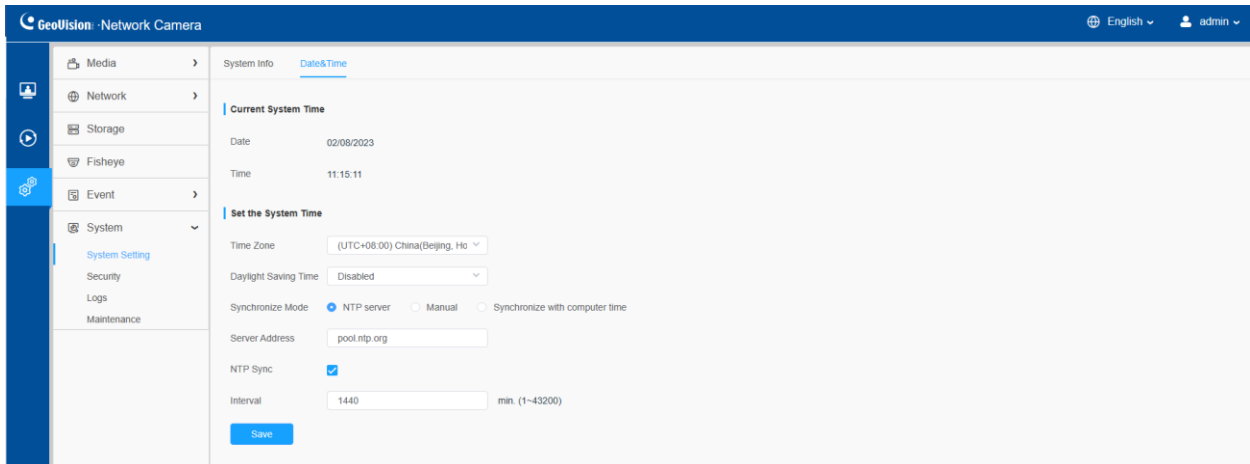


**Table 60. Description of the buttons**


Parameters	Function Introduction
<b>Device Name</b>	The device name can be customized. It will be seen in file names of video files.
<b>Product Model</b>	The product model of the camera.
<b>Hardware Version</b>	The hardware version of the camera.
<b>Software Version</b>	The software version of the camera can be upgraded.
<b>MAC Address</b>	Media Access Control address.
<b>S/N</b>	Stock Number.
<b>Device Information</b>	The device information, including information about alarm I/O and clipper chip.
<b>Alarm Input</b>	The number of Alarm Input interface. <b>Note:</b> The Alarm Input will appear only when the camera has alarm input/output interface.
<b>Alarm Output</b>	The number of Alarm Output interface. <b>Note:</b> The Alarm Output will appear only when the camera has alarm input/output interface.

<b>Uptime</b>	The elapsed time since the last restarted of the device.
	Save the configuration.

### 8.6.1.2 Date & Time



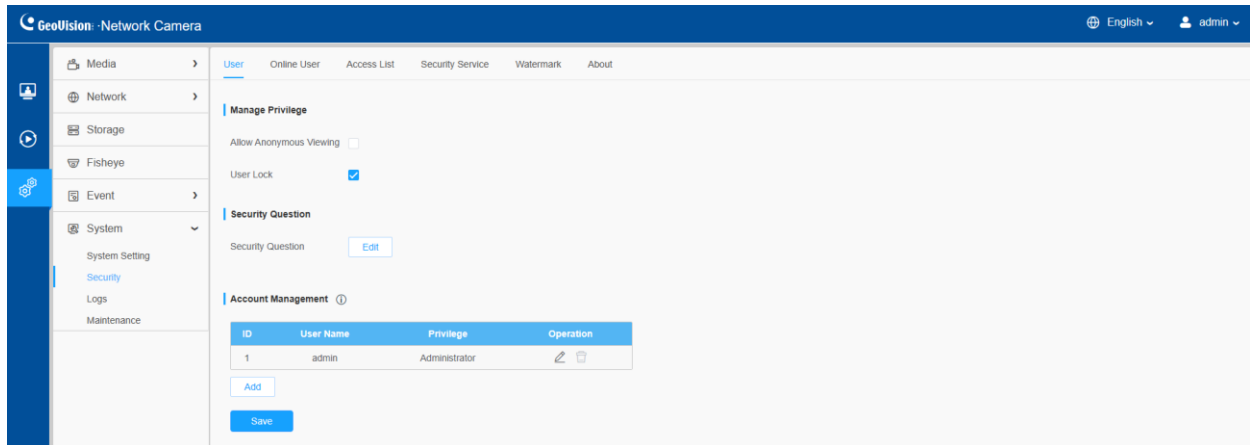
**Table 61. Description of the buttons**

Parameters	Function Introduction
<b>Current System Time</b>	Current date & time of the system.
<b>Set the System Time</b>	<b>Time Zone:</b> Choose a time zone for your location.
	<b>Daylight Saving time:</b> Enable the daylight-saving time.
	<b>Synchronize Mode:</b> NTP server, Manual and Synchronize with computer time are optional.
	<b>NTP server:</b> Input the address of NTP server.
	<b>NTP Sync:</b> Regularly update your time according to the interval time.
	<b>Manual:</b> Set the system time manually.
	<b>Synchronize with computer time:</b> Synchronize the time with your computer.
	Save the configuration.

## 8.6.2 Security

Here you can configure User, Access List, Security Service, Watermark, etc.

### 8.6.2.1 User



**Table 62. Description of the buttons**

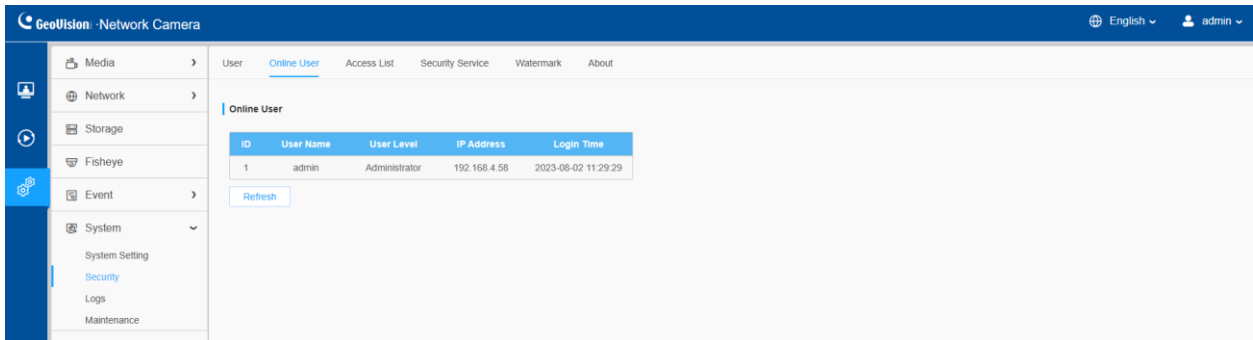
Parameters	Function Introduction
<b>Manage Privilege</b>	<b>Allow anonymous viewing:</b> Check the checkbox to enable visit from whom doesn't have account of the device.
<b>Security Question</b>	<p>Click "Edit" button to set three security questions for your camera. In case that you forget the password, you can click "Forget Password" button on login page to reset the password by answering three security questions correctly.</p> <p>There are twelve default questions below, you can also customize the security questions.</p>
<b>Account Management</b>	<p>Click "<b>Add</b>" button, it will display Account Management page. You can add an account to the camera by entering Admin Password, User Level, User Name, New Password, Confirm, and edit user privilege by clicking. The added account will be displayed in the account list.</p> <p><b>Admin Password:</b> You can add an account only after you enter the correct admin password.</p> <p><b>User Level:</b> Set the privilege for the account.</p> <p><b>User Name:</b> Input user name for creating an account.</p> <p><b>New Password:</b> Input password for the account.</p> <p><b>Confirm:</b> Confirm the password.</p> <p>You can edit and delete the account in the account list under the admin account. For the default admin account, you can only change the password, and it cannot be deleted.</p> <p><b>Note:</b></p>

- Support up to 20 users, including a default user and 19 custom added users.
- The operator privilege is all checked by default.



### 8.6.2.2 Online User

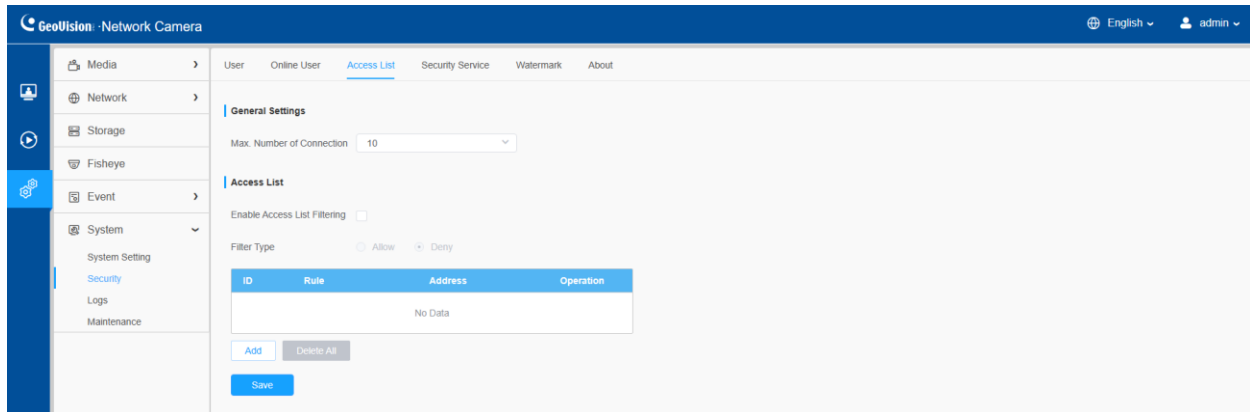
Here real-time status of user logging in camera will be shown.








**Table 63. Description of the buttons**

Parameters	Function Introduction
<b>Refresh</b>	Click to get latest status of user accessing to camera.
<b>ID</b>	Record serial number of user logging in camera. <b>Note:</b> <ul style="list-style-type: none"> <li>• There are at most 30 records shown at the list.</li> <li>• There is only one record if the same user logging on camera by the same IP address.</li> </ul>
<b>User Name</b>	Name of user logging in camera.
<b>User Level</b>	Level of user logging in camera.
<b>IP Address</b>	Device IP address where user logging in camera web located.
<b>Login Time</b>	Camera system time of user logging in camera.

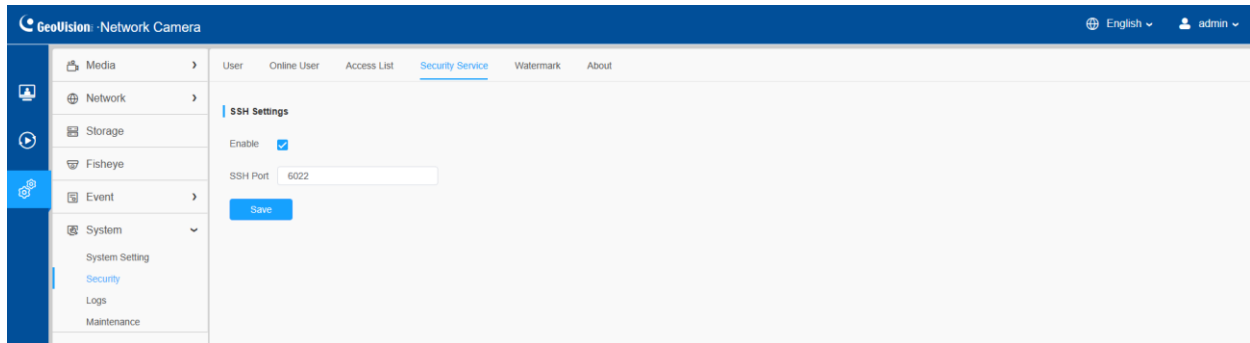
### 8.6.2.3 Access List



**Table 64. Description of the buttons**

Parameters	Function Introduction	
<b>General Settings</b>	<b>Max. Number of Connection:</b> Select the maximum number of concurrent streaming. Options include No Limit, 1~10.	
<b>Access List</b>	<b>Enable Access List Filtering:</b> Able to access or restrict access for some IP address.	
<b>Access List</b>	<b>Filter type:</b> Allow or deny access.	
		<b>Rule:</b> <b>Single, Network and Range</b> are available. <b>IP address:</b> Input the address to get the access to the device.
		Delete all the access list.
		Edit the selected IP on access list.
		Delete the selected IP on access list.
	Save the configuration.	

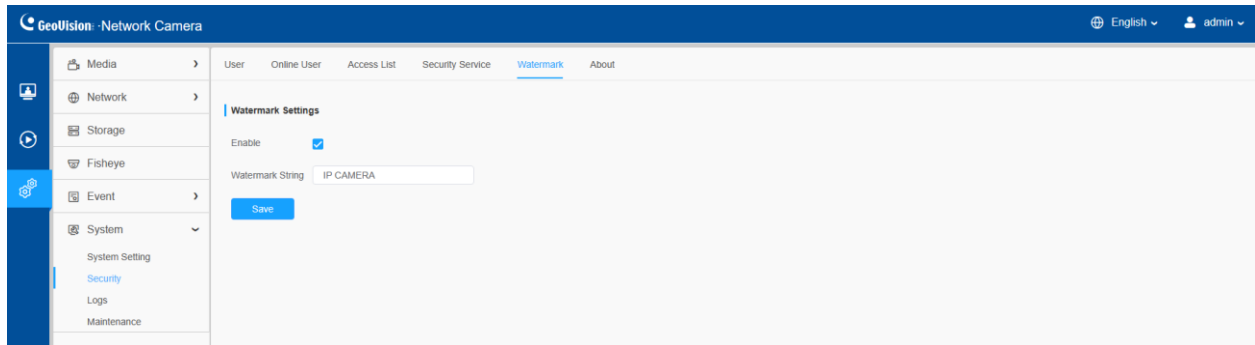
## 8.6.2.4 Security Service



**Table 65. Description of the buttons**

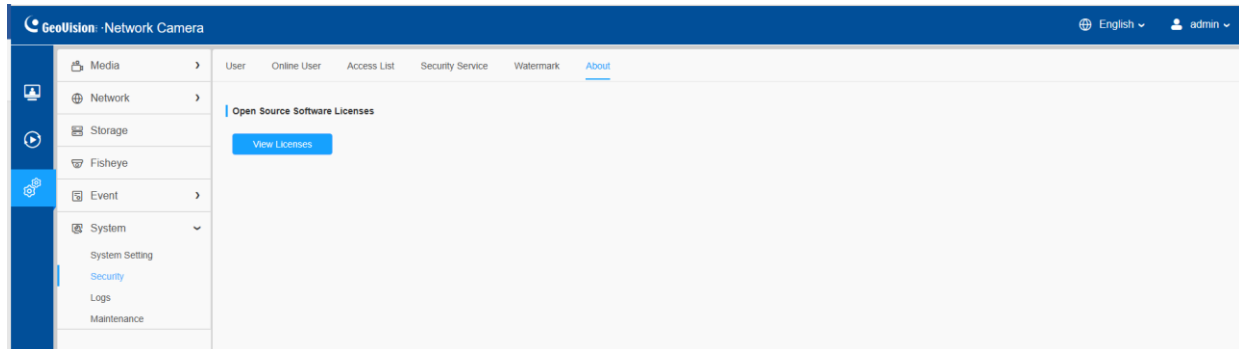
Parameters	Function Introduction
<p><b>SSH Settings</b></p>	<p>Secure Shell (SSH) has many functions: it can replace Telnet and also provides a secure channel for FTP, POP, even for PPP.</p>

## 8.6.2.5 Watermark



Watermarking is an effective method to protect information security, realizing anti-counterfeiting traceability and copyright protection. Watermark function is supported to ensure information security.

## 8.6.2.6 About

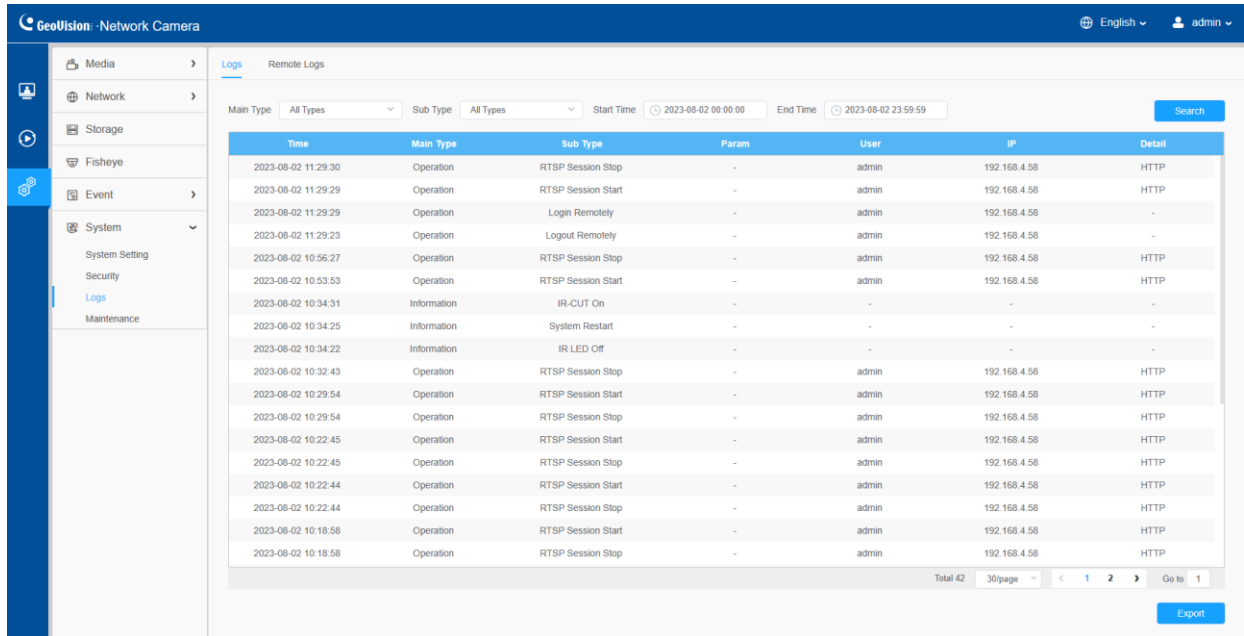


User can view some open-source software licenses about the camera by clicking the View Licenses button.

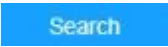

## 8.6.3 Logs

### 8.6.3.1 Logs

The logs contain the information about the time and IP that has accessed the camera through web.

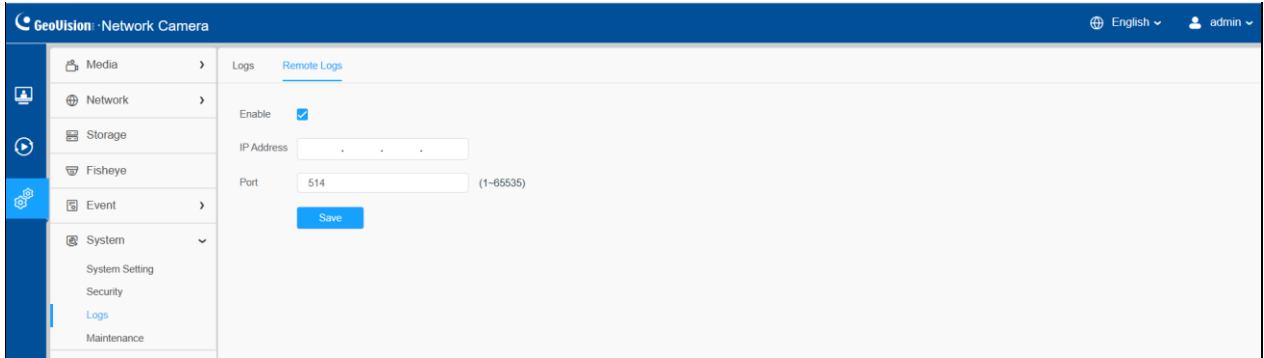


**Table 66. Description of the buttons**

Parameters	Function Introduction
<b>Main Type</b>	There are five main log types: <b>All Type</b> , <b>Event</b> , <b>Operation</b> , <b>Information</b> , <b>Exception</b> and <b>Smart</b> .
<b>Sub Type</b>	On the premise that main type has been selected, select the sub type to narrow the range of logs.
<b>Start Time</b>	The time log starts.
<b>End Time</b>	The time log ends.
	Search the logs.
	Export the logs.
<b>Go to</b>	Input the number of logs' page.

### 8.6.3.2 Remote Logs

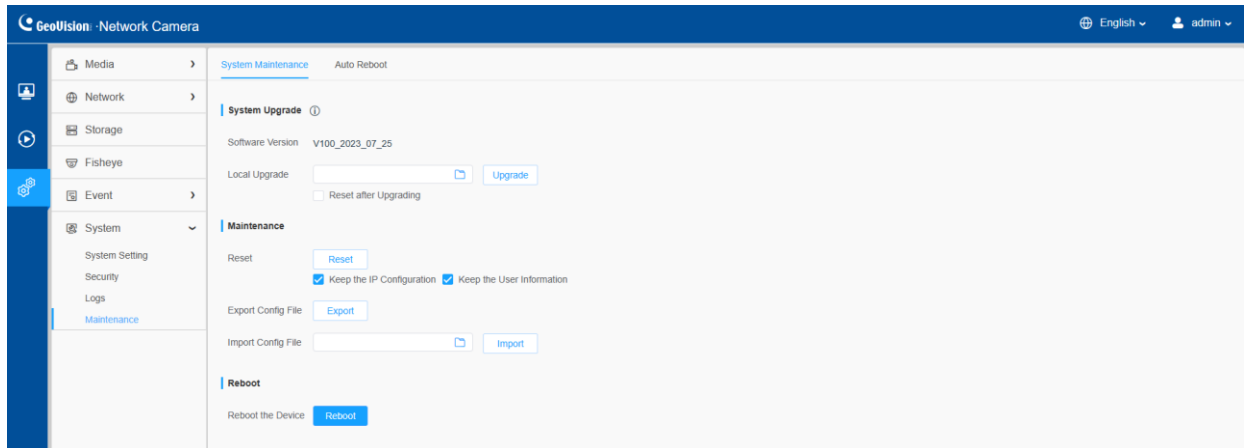
By [installing rsyslog on Ubuntu](#), users are allowed to remotely access the camera's logs, including activities such as login/logout, RTSP start/stop, and fisheye camera PTZ control, etc.



## 8.6.4 Maintenance

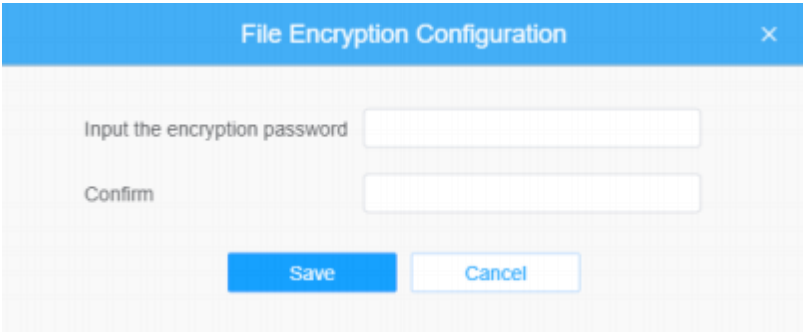
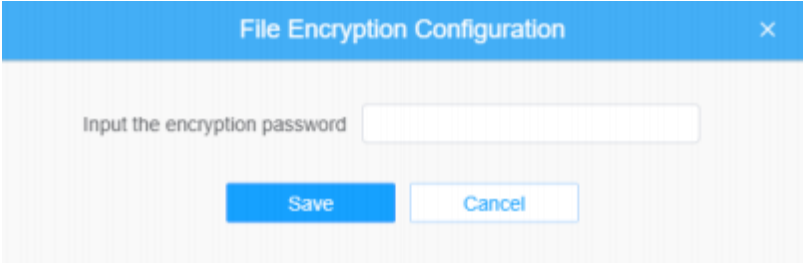
Here you can configure System Maintenance and Auto Reboot.

### 8.6.4.1 System Maintenance



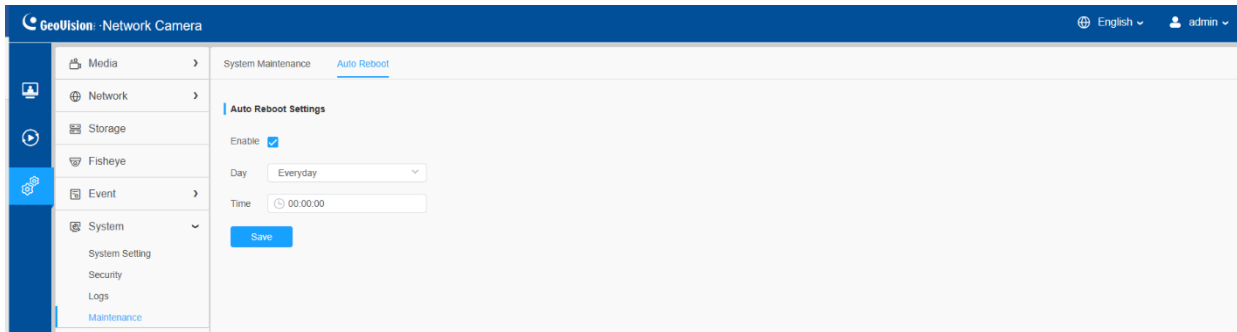
**Table 67. Description of the buttons**

Parameters	Function Introduction
<p><b>System Upgrade</b></p>	<p><b>Software Version:</b> The software version of the camera.</p> <p><b>Local Upgrade:</b> Click the “Browse” button and select the upgrading file, then click the “Upgrade” button to upgrade. After the system reboots successfully, the update is done. You can check “<b>Reset after Upgrading</b>” to reset the camera after upgrading it.</p>
<p><b>Maintenance</b></p>	<p><b>Reset:</b> Click “Reset” button to reset the camera to factory default settings.</p> <p><b>Keep the IP Configuration:</b> Check this option to keep the IP configuration when resetting the camera.</p> <p><b>Keep the User information:</b> Check this option to keep the user information when resetting the camera.</p>

	<p><b>Export Config File:</b> Click this button and a window will pop up as shown below:</p>  <p>You need to enter and confirm password again, then click save button to export configuration file.</p> <p><b>Import Config File:</b> Click this button, then a window will pop up and you can click "OK" to update the configuration.</p> <p>It will pop up a window to prompt "Input the password of config file", then enter password and click save button to import configuration file.</p>  <p><b>Note:</b> Export and import the same configuration file. Password must be the same.</p>
<b>Reboot</b>	Click "Reboot" button to restart the device immediately.



## 8.6.4.2 Auto Reboot



Set the date and time to enable Auto Reboot function, the camera will reboot automatically according to the customized time in case that camera overload after running a long time.

# Appendix

## A. Optional Installation

### 1. GV-Mount211-7

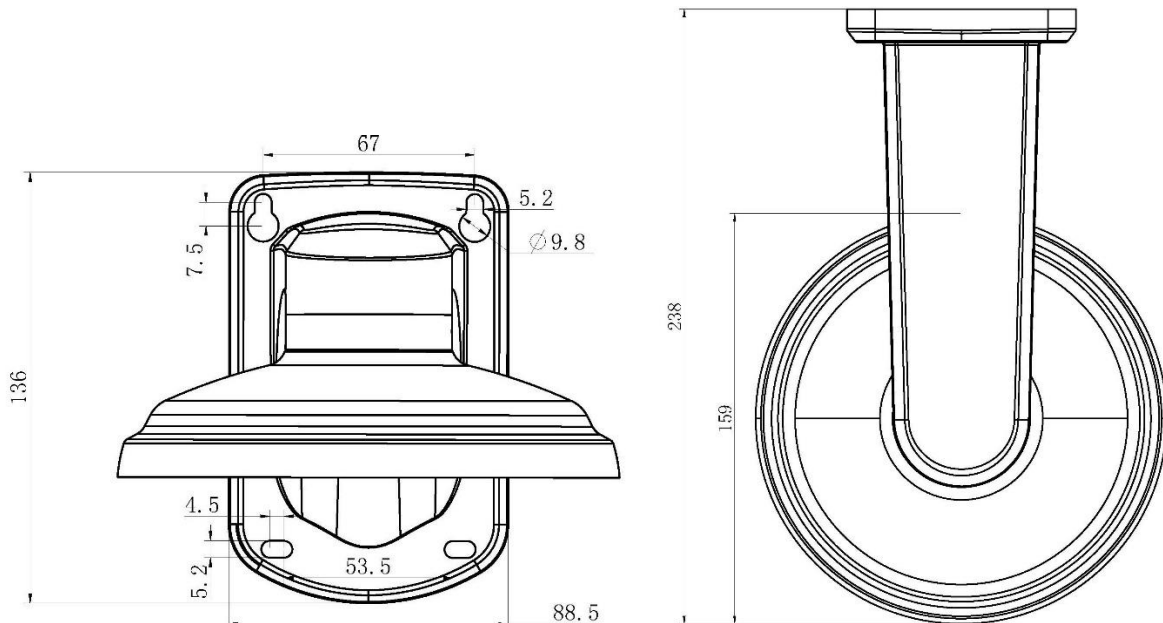


#### GV-Mount211-7 Packing List

1. GV-Mount211-7	2. M4 Screw (40 mm) x 4
3. M4 Screw (6 mm) x 4	4. Hex Key

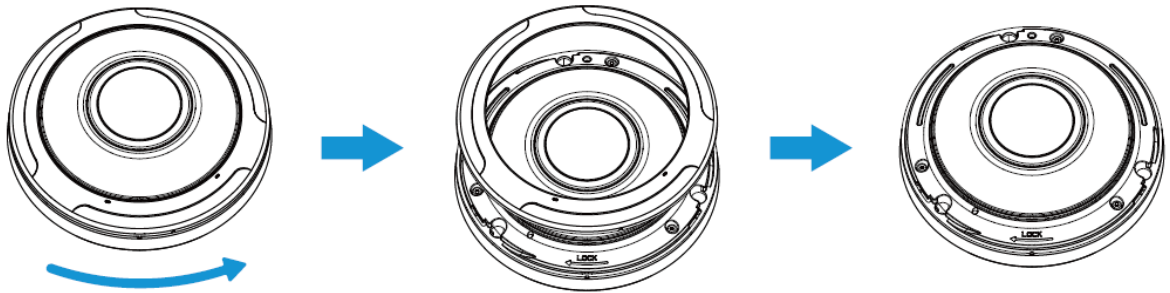
#### Dimension

Unit: mm

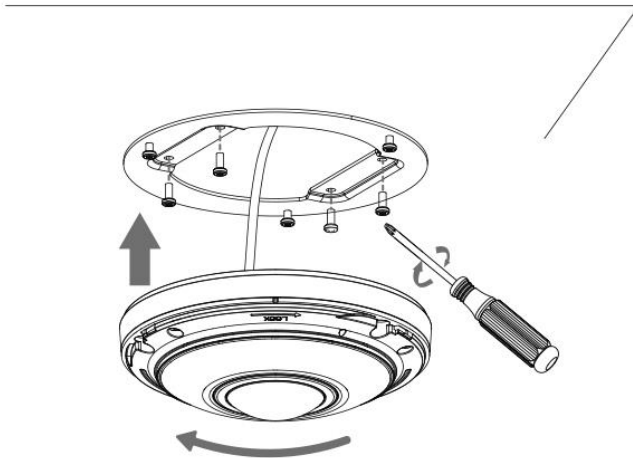


### Install with Wall Mount Bracket GV-Mount211-7

1. Hold the camera and turn the top cover anticlockwise, then take it off.

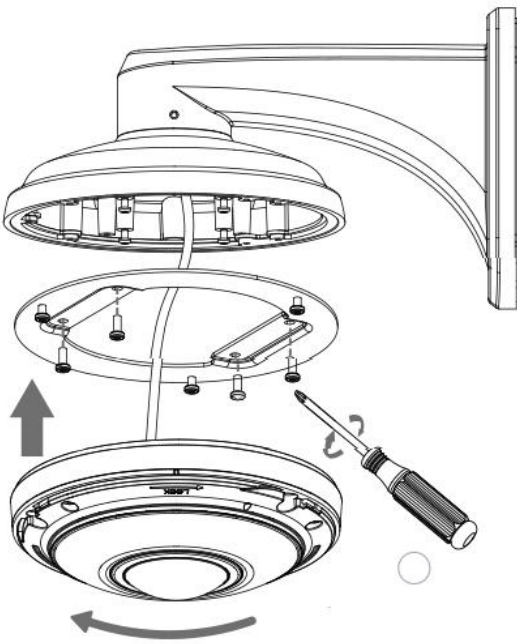


2. Remove the base plate from the camera.

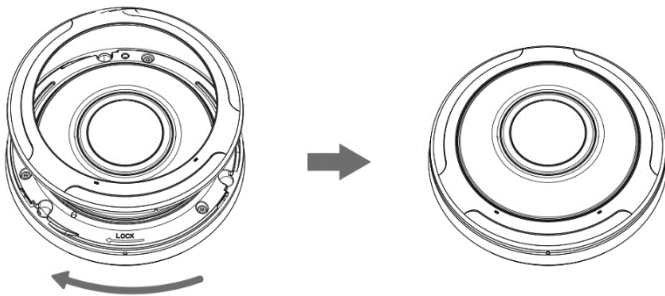


3. Fix GV-Mount211-7 on the wall where the camera is intended to be installed.

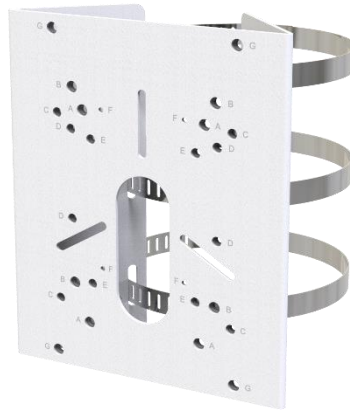
4. Secure the base plate onto GV-Mount211-7, thread the cables of the camera, and fix the camera onto the base plate.



5. Turn the top cover clockwise till the anchor points are aligned.



## 2. GV-Mount430

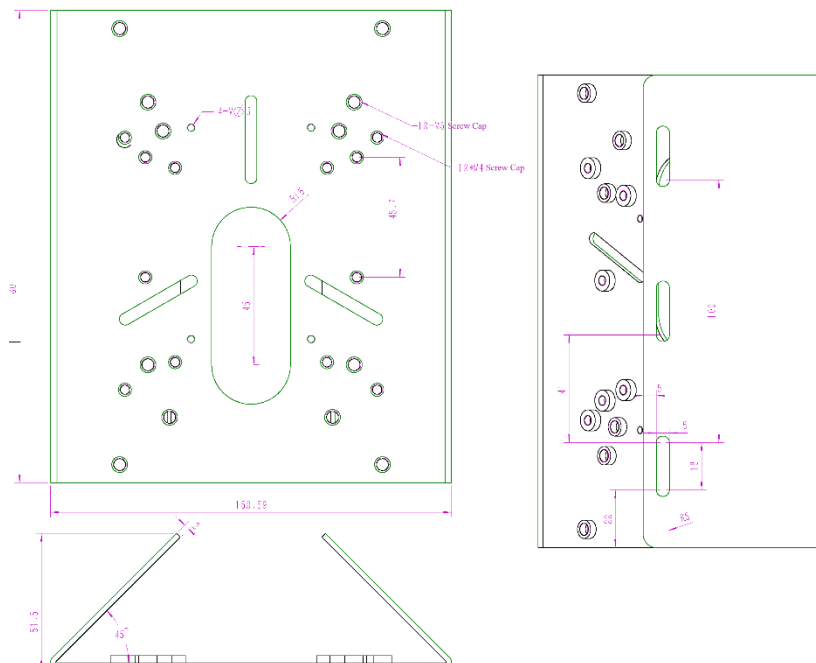


### GV-Mount430 Packing List

1. GV-Mount430	2. Steel Strap (Ø 102 ~ 107; 4.1" ~ 5") x 3
3. Plain Washer (Ø 6 x 18 x 1.5 mm) x 4	4. M4 Plain Washer (10 x 1 mm) x 4
5. M3 Screw (12 mm) x 3	6. M4 Screw (12 mm) x 4
7. M4 Screw (20 mm) x 4	8. M5 Screw (25 mm) x 4
9. M3 Screw Cap x 3	10. M4 Screw Cap x 4

### Dimension

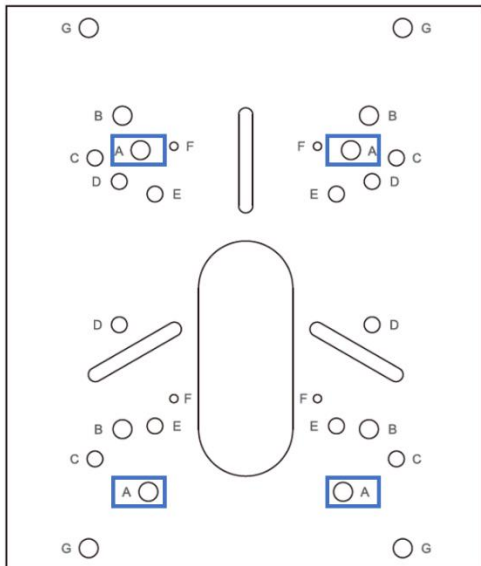
Unit: mm



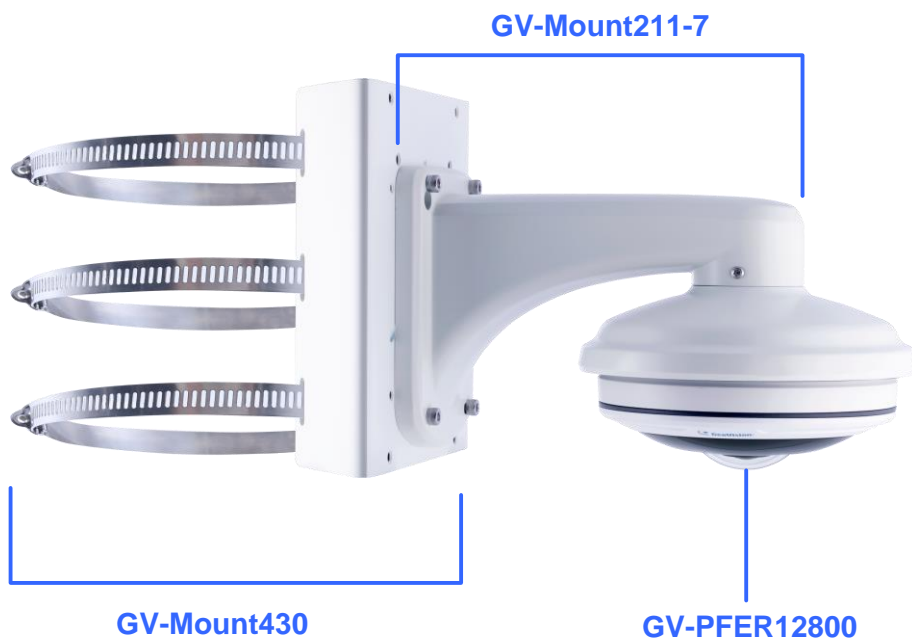
### Install with Pole Mount Bracket GV-Mount430

**Note:** It is required to use GV-Mount211-7 with GV-Mount430 to complete pole mounting of GV-PFER12800.

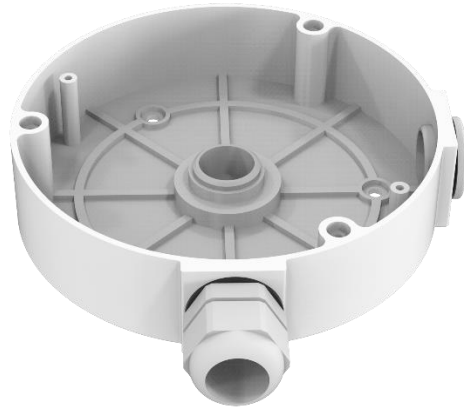
1. Secure GV-Mount211-7 onto GV-Mount430 according to the holes indicated below.



2. Follow the installation instruction in 1. *GV-Mount211-7* to finish the installation of the camera and *GV-Mount211-7*.



### 3. GV-Mount508

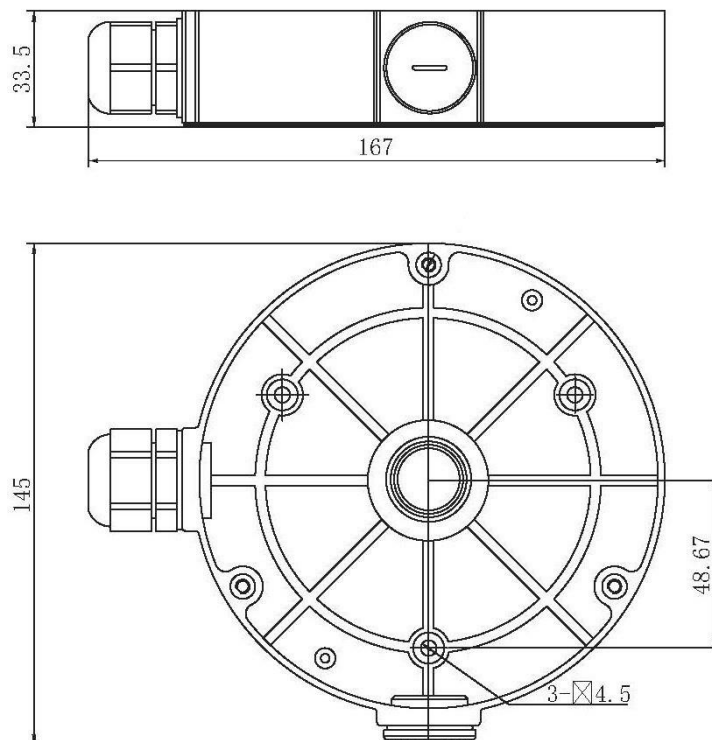


#### GV-Mount508 Packing List

1. GV-Mount508	2. M4 Screw (30 mm) x 3
3. M4 Screw (8 mm) x 3	4. Drill Template Paster

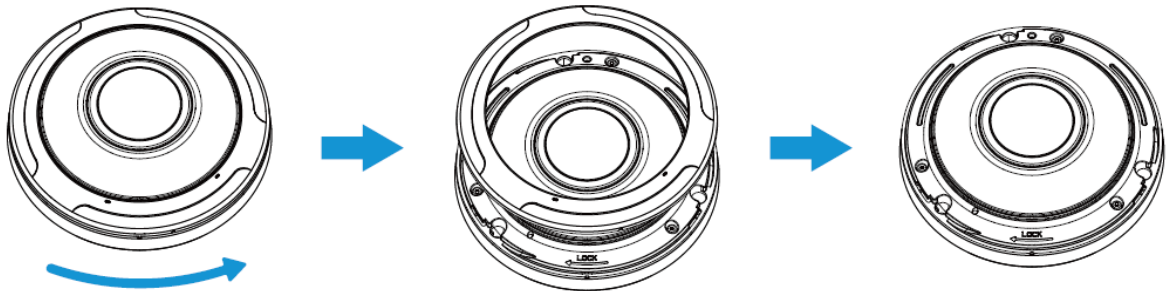
#### Dimension

Unit: mm

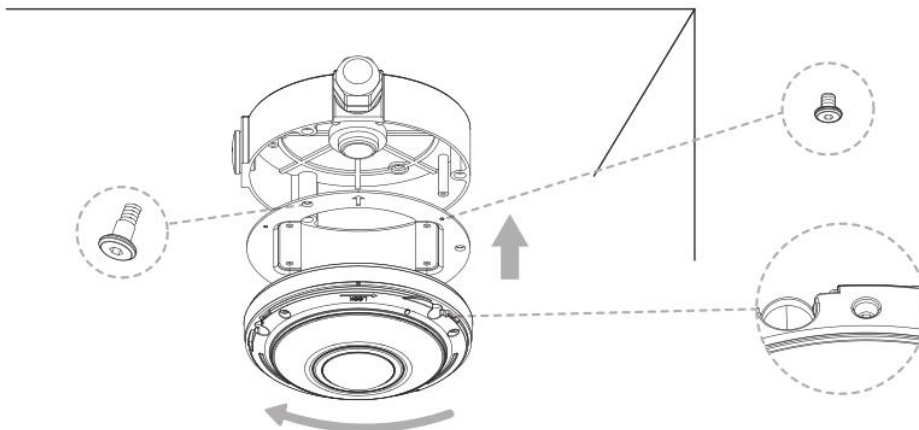


### Install with Junction Box GV-Mount508

1. Hold the camera and turn the top cover anticlockwise, then take it off.

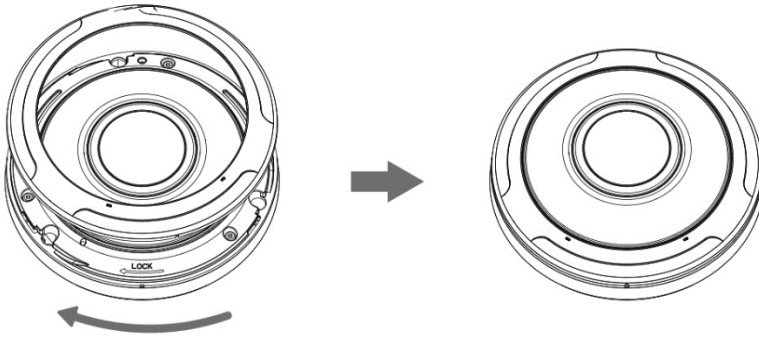


2. Remove the base plate from the camera.
3. Fix GV-Mount508 in the position where the camera is intended to be installed.
4. Secure the base plate to GV-Mount508. Pay attention that the two marks on the junction box and the bracket shall be aligned. Then connect the cables and rotate the camera to GV-Mount508 and secure them.





5. Turn the top cover clockwise till the anchor points are aligned.



**GV-PFER12800 + GV-Mount508**



## B. Note for Fisheye Camera with IR LED

When installing GV-Mount211-7 / 508 / 430 to GV-PFER12800, leave a distance of 1 M (3.28 ft) or more between the camera body and nearby walls to avoid reflected glare by IR LED.

