



CAM8PRO Mixer

Installation and Use Manual

Notice

Every effort was made to ensure that the information in this guide was complete and accurate at the time of printing. However, this information is subject to change.

Important Safety Information

Always follow these basic safety precautions when installing and using the unit:

1. Read all instructions before installing or operating the unit.
2. Follow all warnings and instructions marked on the product.
3. DO NOT block or cover the ventilation slots and openings. They prevent the product from overheating. DO NOT place the product in a separate enclosure or cabinet, unless proper ventilation is provided.
4. Never spill liquid on the product or drop objects into the ventilation slots and openings. Doing so may result in serious damage to the components.
5. Repair or service must be performed by a factory authorized repair facility.
6. DO NOT use the product near water or in a wet or damp place (such as a wet basement).
7. DO NOT use extension cords. The product must be installed within 6 feet of a grounded outlet receptacle.
8. DO NOT install telephone wiring during a lightning storm.
9. DO NOT install telephone jacks in a wet location unless the jack is specifically designed for wet locations.
10. Never touch uninsulated wires or terminals, unless the line has been disconnected at the paging or controller interface.
11. Use caution when installing or modifying paging or control lines.

Maintenance & Service

Caution

There are no user-serviceable parts within the unit. Have all internal servicing performed by a qualified technician. The warranty will become void if repairs are made by other than the Bogen Service Department or an authorized service agency.

Our Applications Engineering Department is available to help you troubleshoot problems with your Bogen equipment. Engineers are available from 8:30 AM to 6:00 PM, Eastern Standard Time. Phone 1-800-999-2809.

Service can be obtained from our factory service department. No merchandise may be returned for repair without prior written authorization. Please contact our factory service department at 1-800-999-2809 for a RA number. Only merchandise specified in the return authorization form can be returned to obtain warranty or non-warranty repair. When shipping your unit, pack your system well using the original shipping carton or a similar container and filler material to prevent damage in transit. Send the unit fully insured and prepaid via UPS or other responsible carrier.

Contents

INTRODUCTION	4
Safety Instructions	5
QUICK START	6
PANEL DESCRIPTIONS	7-9
Front Panel	7
Rear Panel	8
Helpful Hints	9
INSTALLATION	10-11
OPERATION	12-18
Troubleshooting Gain Structure	13
Recommended Input Wiring Methods	14
Fine Tuning	15
Compressor/Limiter	16
Special Features Activation	17
Jumper Options	18
TROUBLESHOOTING TIPS	19
GLOSSARY	20
TECHNICAL INFORMATION	21-22
Specifications	21
Block Diagram	22

Introduction

CAM8PRO

CAM8PRO Front View

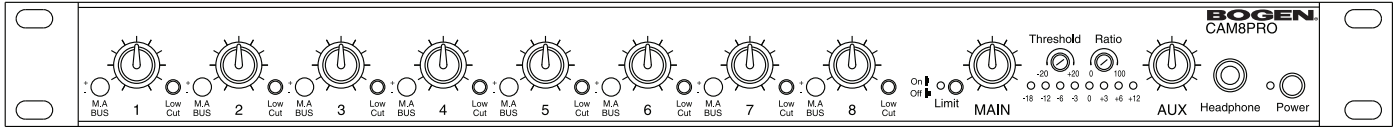

CAM8PRO Rear View

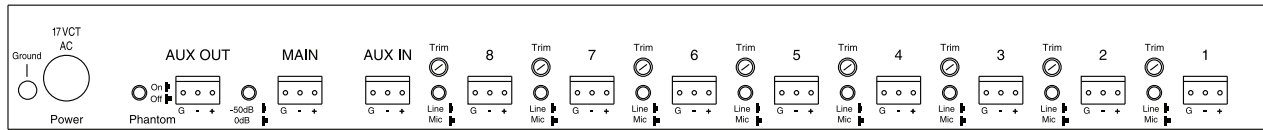

This manual covers installation of the CAM8PRO. It was manufactured to ensure the highest quality audio signal production and control, while still incorporating simple-to-use features.

This manual is designed to familiarize you with the features of your new Bogen CAM8PRO mixer and to guide you through its installation and operation.

Safety Instructions

Bogen's CAM8PRO mixer is electrical equipment, so take all the precautions usually taken when installing and using electrical equipment (see inside front cover). To protect both the users and the equipment, pay particular attention to:

- **Grounding** - Make sure both the mixer and the devices connected to it are properly grounded.
- **Power Supply** - Use only the power supply provided or one that meets the manufacturer's specifications.
- **Cords and Cables** - Route all cords and cables so that they will not be tripping hazards or subject to damage (from being run over or pinched) that could cause them to become shock hazards. Pay particular attention to cords at plugs, convenience receptacles, and the point where they enter the mixer.

Quick Start

1. **Unpack and Connect** *(See page 10 for more details).*

A. Check mixer for shipping damage.

Rack Mounting: To mount the CAM8PRO to a 19" rack, lift the unit up to the front of the rack and secure it to the front of the rack with the necessary screws (not included with this unit).

B. If special features (see page 17) are to be used, they must be set before the mixer is mounted.

C. Turn off both mixer and amplifier and turn all volume controls to zero.

D. Connect inputs and set the input pad switch for each channel at the appropriate level (either MIC or line). Make sure that the bus selector is set for Main Out.

E. Connect output(s) and set the main output pad switch at the appropriate level (either MIC or line). (Auxiliary output is line-level only.)

2. **Power and Set Up** *(See pages 10-14 for details.)*

A. Connect mixer AC power supply.

B. Turn volume controls down, then power up mixer and amplifier.

Note: Mixer will produce signal transients on power up and power down. Always turn the mixer on first before turning on the amplifier and always turn the amplifier off first before turning off the mixer.

C. Adjust Main/AUX out controls to the 2 o'clock position. Then turn amp up to normal level while performing audio test.

D. Adjust input gain/trim control for each channel to get a meter reading within the green area.

E. Adjust individual channel volume controls to the 2 o'clock position.

3. **Fine Tuning** *(See page 15 for details).*

A. In the event of excessive bass, press Low Cut filter switch(es) "on."

B. If condenser mics are used, press phantom power switch "on" (turns phantom power on for all inputs set to MIC position).

C. In the event of occasional excessive output level, press Compressor/Limiter switch "on".

Front Panel Descriptions

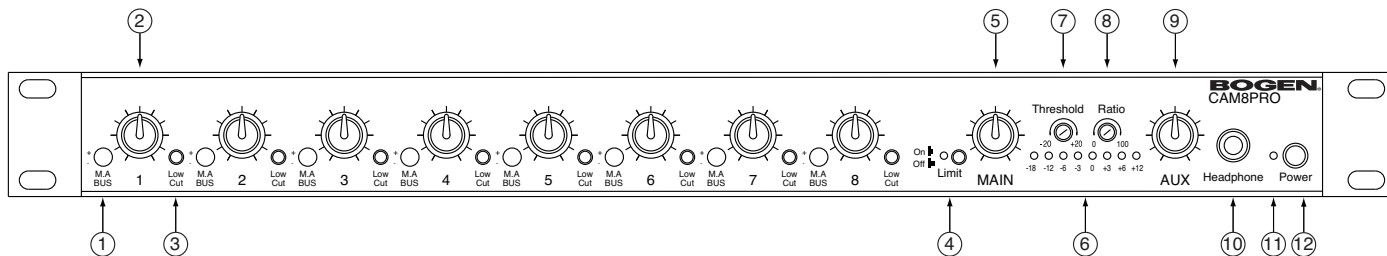

CAM8PRO Front Panel

1. Main/Auxiliary Bus Selector (one per channel)

A 4-position switch which selects destination of channel input. Input can be routed to: a) the main bus (M-up, A-down); b) the auxiliary bus (M-down, A-up-shown at right); c) both the main and auxiliary buses (both up); or d) neither bus (both down).



2. Channel Volume Control Knob (one per channel)

Controls the volume of the channel input to any and all outputs simultaneously.

3. Low Cut Switch

Helps eliminate low frequency noise (100 Hz 18 dB/octave).

4. Main Output Compressor/Limiter Switch and LED

Note: Works only on main bus. Reduces distortion of the main output (due to clipping) by controlling its dynamic range. When the LED (red) is lit, the Compressor/Limiter is on. The brighter the LED, the more the signal is being compressed.

5. Main Output Volume Control Knob

Controls the output signal volume of the main bus.

6. LED Bar Graph Output Meter

Displays output signal level in decibels, ranging from -18 (green) to +12 (red) VU. 0 VU = +4 dBm. This meter can be set to indicate the signal level of either the main or auxiliary bus and to indicate either the average or peak signal. (See page 18 for details.)

7. Threshold Control

Screw-pot adjustment sets the signal level (-20 to +20 VU; factory setting is 0 VU) at which the Compressor/Limiter becomes active.

8. Ratio Control

Screw-pot adjustment sets the amount of compression (0-100%; factory setting is 100%) of the signal above the threshold.

9. Auxiliary Output Volume Control Knob

Controls the output signal volume of the auxiliary bus output and to the headphones. (There is no connection between this bus and the Compressor/Limiter.)

10. Headphone Jack

A 1/4 inch-diameter TRS mono-only jack for the connection of headphones. (Only monitors AUX bus.)

11. Power Indicator LED

LED displays mixer's powered state. Lit when power is on. Not lit when power is off.

12. Power Switch Button

Push button to turn unit on ("in" position); push again to turn unit off ("out" position).

Rear Panel Descriptions

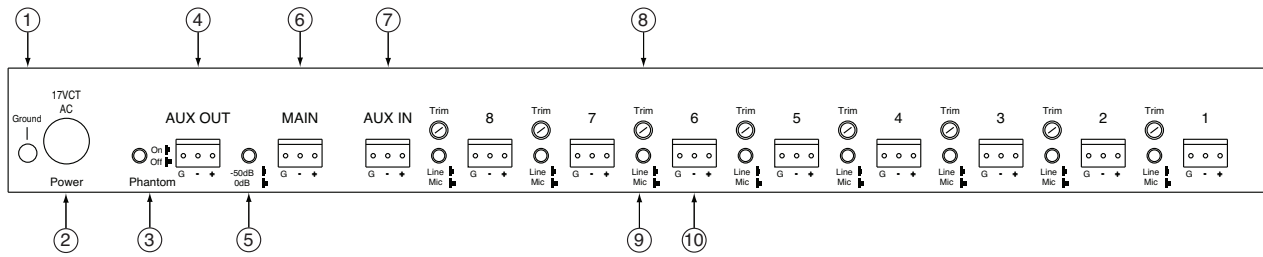

CAM8PRO Rear Panel

1. Ground Connection on Rear Panel

Access to ground.

2. AC Power Jack

Mixer power supply input.
Accepts a 4-pin DIN connection from a 17V CT 1.5 Amp transformer.

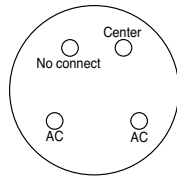

3. Phantom Power Switch

When activated, supplies 30V DC power to all inputs set to MIC level.

4. Auxiliary Bus Output

Balanced, line-level, connection to auxiliary output bus.

5. Main Output Microphone/Line Switch

Selects main output to be either MIC (-50 dB μ) or line (0 dB μ) level.

6. Main Bus Output

Balanced connection to main output bus.

7. Auxiliary Input

Balanced, buffered, uncontrolled, line-level terminals for additional (ninth) input connection directly to the summing buses selected by internal jumpers. The factory default is both jumpers installed. (See page 18 for details.)

8. Input Gain/Trim Control Screw

Adjusts gain of input stage, over a range of 40 dB.

9. Input Pad Microphone/Line Switch

Selects either MIC (-50 dB μ) or line (0 dB μ) level for corresponding input connection.

10. Input

Balanced input connection (pluggable terminal strip).

Helpful Hints

Electrical equipment operates best in a clean, dry, well-ventilated environment free of vibration and electromagnetic fields. The following are some guidelines to achieve optimal performance.

Avoid placing the mixer and cables near heat sources. Be particularly aware of other audio equipment, such as amplifiers, which can produce a great deal of heat when operating.

To minimize hum in the system, avoid placing the mixer and cables near radio frequency devices and other electromagnetic field sources such as:

- Fluorescent lights
- Electrical motors
- SCR dimmers
- AC power lines, etc.

Note: Always use 2-conductor shielded cable to reduce EMI or RF interference to the Line/MIC inputs.

Keep the mixer and other equipment clean and free of dust by wiping occasionally with a soft, damp cloth.

Protect the mixer from electrical damage by disconnecting it from the power source whenever it will be unused for a week or longer.

The Bogen mixer is easy to install and adjust. The only tools needed are:

1. Slotted screwdriver
2. Phillips-head screwdriver

Installation

Note: Take the mixer out of the box and inspect for shipping damage. If there is obvious physical damage to the outside of the mixer, contact the supplier of the mixer **before you begin installation.**

Rack Mounting: To mount the CAM8PRO to a 19" rack, lift the unit up to the front of the rack and secure it to the front of the rack with the necessary screws (not included with this unit).

A. Turn all mixer Volume Control Knobs [Channel(s) (1), Main (2), and Auxiliary (3)] to zero.

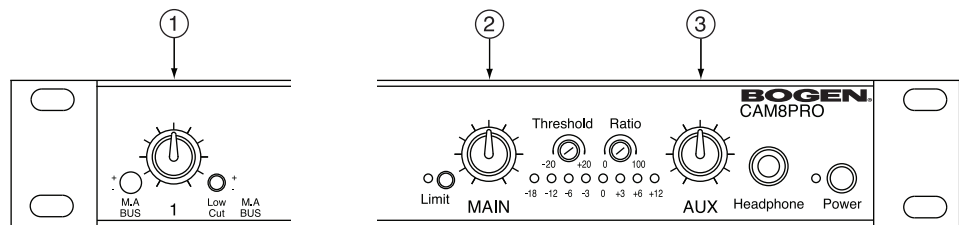

Turn amplifier(s) volume controls to the 7 o'clock position.

B. Connect Inputs.

Connect lead into desired pluggable terminal strip (6) on rear panel.

Press **Input Pad Microphone/Line Switch** (5) to appropriate position: "in" for line input or "out" for MIC input. Note that the input from some mics is actually close to line level (-20 dB) and for such mics the switch should be at "Line." Set switch for all unused channels at Line level. The **Auxiliary Input** (4) is Line level only.

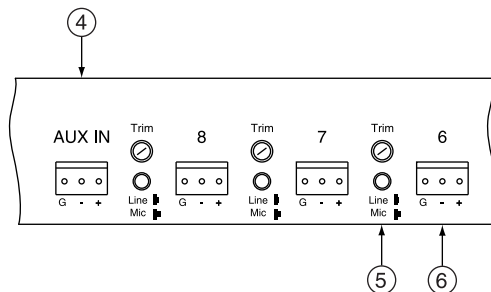

C. Connect Output: Make a connection between **Main Bus Output Terminals (3)** and an input jack of an amplifier. Press **Main Output Microphone/Line Switch (2)** to appropriate position: “in” for line-level output (0 dB μ) or “out” for mic-level (-50 dB μ) output.

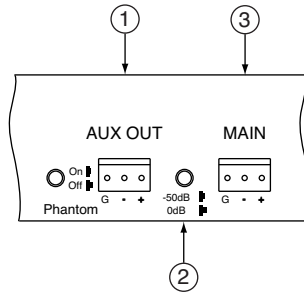

If desired, also connect **Auxiliary Bus Output Terminals (1)** to a second destination device. The auxiliary output is line-level only.

D. Connect mixer power supply to an AC power outlet and to the **AC Power Jack (4)** (located on far left side of rear panel).

E. Power up mixer:

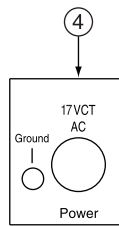

Press **Power Switch (8)** to “in” position. [**Power Indicator LED (7)** will be lit if mixer is powered.] Set **Main Output Volume Control Knob (5)** to 2 o’clock. If auxiliary output is desired, also set **Auxiliary Output Volume Control Knob (6)** to 2 o’clock.

Power up amplifier.

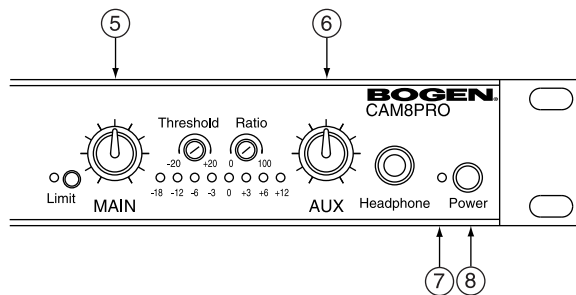

Note: Mixer will produce signal transients on power up and power down. Always turn the mixer on first before turning on the amplifier and always turn the amplifier off first before turning off the mixer.

Operation

The primary goal when establishing the gain settings of the mixers is to have each channel operating at the maximum gain without clipping, while leaving adequate headroom on the volume control knob.

The channel **Input Gain/Trim Control** (1) on the rear panel of the mixers directly controls the microphone pre-amplifier gain available at each channel.

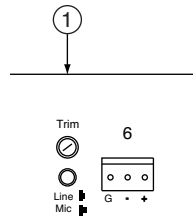

The **Volume Control** (2) on the front panel controls how much of the gain is routed to the main output stage. The front panel controls should optimally operate between the 9 and 2 o'clock position when gain structure is correct (see example on page 13).

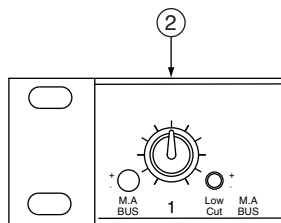

The **Main Output Volume Control Knob** (3) on the front panel controls the mixer's final amplifier stage to the master output. This control should optimally operate between the 9 and 2 o'clock positions when gain structure is correct.

With all channels operating, the main output meter should show a signal output range between 0 and +6 VU. Adjust the main output control accordingly. If the output occasionally peaks in the range of +6 and +12 VU, activate the Compressor/Limiter (see page 16).

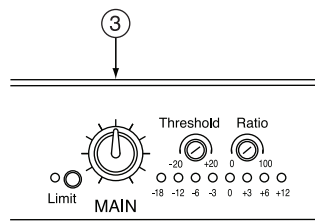

The amplifier for the loudspeakers should be the final control for establishing volume levels.

Note: The channel **Input Gain/Trim Controls** are factory preset to produce a 0 dB μ signal level at the master output when the front panel volume controls are set at the 2 o'clock position. This setting is optimal with most input devices.

Troubleshooting Gain Structure

If the procedure followed to this point does not give satisfactory results, follow the appropriate adjustment sequence below:

If channel clipping occurs

If the signal is clipping or producing audible distortion, the gain is too high. Reduce the Input Gain/Trim Control (rear panel) by turning it counterclockwise until clipping does not occur. Also make sure that the new setting of the gain control offers a usable control range between the 9 o'clock and 2 o'clock positions on the front panel volume control knob.

If channel volume is too low

If a channel must be set above the 2 o'clock position to provide adequate volume, the input gain setting is too low. Turn the volume control knob to the 1 o'clock position and increase the input gain by turning the input gain/trim control clockwise until clipping occurs, or VU meter is over 0 VU. Then adjust the gain to a setting just below the clipping level.

If channel volume is too high

If a channel is not clipping but must be set below the 9 o'clock position to achieve the proper volume level, the input gain control setting is too high. Reduce the Input Gain/Trim Control by turning it counterclockwise. Set the volume control knob to the 9 o'clock position and continue to adjust the gain control until the desired volume level is achieved.

Range for optimal volume control operation settings (indicator positions).

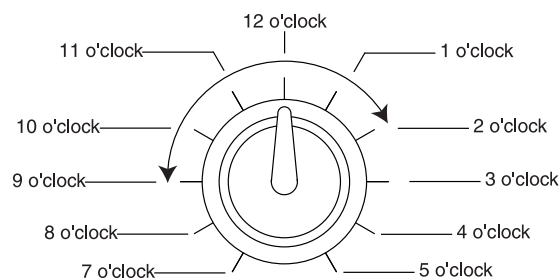

Recommended Input Wiring Methods

These are the best ways to connect sources to the mixer. The mixer input is always balanced. From the drawings below choose the wiring method for your input device (either balanced or unbalanced).

Balanced Source to Balanced Input - Method 1 (Normal)

Shown below is the normal wiring method for a balanced source device. It has +6 dB gain and excellent ground current and noise rejection.

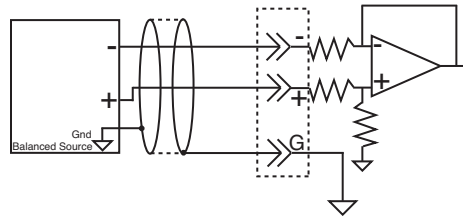

Balanced Source to Balanced Input - Method 2

If the method above does not work in your application, use the wiring shown below. This method can solve certain ground loop problems. It has +6 dB gain and good noise and ground loop rejection.

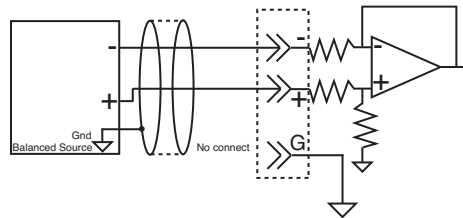

Unbalanced Source to Balanced Input - Method 1

For an unbalanced source device, the drawing below shows the best wiring method. Because of the design of the mixer, this wiring provides a slight (+6 dB) boost, and moderate noise and ground loop rejection.

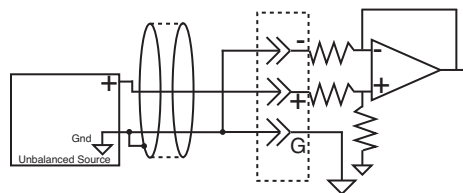

Unbalanced Source to Balanced Input - Method 2

For an unbalanced source device, the drawing below shows an alternative wiring method. Because the grounding of the minus input is not to the mixer ground, this method does not provide the +6 dB boost. Ground current and noise rejection is good.

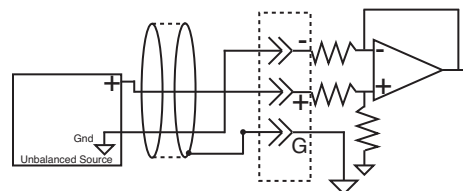

Fine Tuning

Low Cut Switch

To remove excessive bass from an individual channel, press the **Low Cut Switch** (1) for that channel.

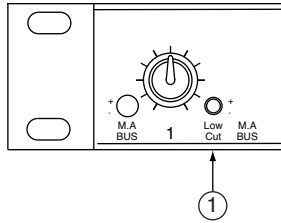

This feature helps eliminate low frequency noise (signals of 100 Hz and below, such as background rumble from ventilation systems, etc.) and is used primarily with mic-level input. It is particularly effective when handheld mics are used.

Phantom Power

If a condenser microphone(s) is not independently powered, press **Phantom Power Switch** (2) to the “on” position.

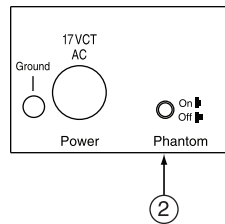

The phantom power switch will power condenser (capacitor) mics through the mic cable. Depressing the button simultaneously applies phantom power to all channels set to mic-level.

Compressor/Limiter

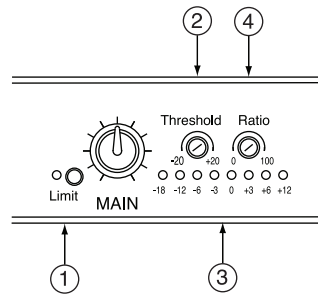

The **Compressor/Limiter** (1) is a dynamic range controller that can be used to compensate for signals that may sound unnatural or cause audible distortion. This is indicated by the **LED Bar Graph Output Meter** (3) occasionally exceeding +12 VU (red).

Note: The Compressor/Limiter only affects the main channel.

A Compressor is used to slightly reduce the dynamic range of a signal. This effect is perceived to quiet loud sounds and boost quiet sounds. A compressor smooths transients.

A Limiter is used to prevent a signal from exceeding a certain level. This function guards against amplifier or recording level overloads. The Compressor/Limiter is activated by pressing the Main Output Compressor/Limiter Switch.

This dynamic controller allows for compression and limiting functions by controlling threshold and ratio.

The **Threshold Control** (2) is a screw potentiometer that sets what signal level will activate the Compressor/Limiter. It has a range of -20 to +20 dB.

The **Ratio Control** (4) is a screw potentiometer that sets the compression ratio that will be applied when the signal exceeds the threshold. It has a range from 0% to 100%. A Compressor becomes a Limiter when the compression ratio is 10:1 or greater.

The factory setting for the threshold is 0 VU (+4 dB), but this is variable (from -20 dB to +20 dB) and can be changed by adjusting the Threshold Control. Likewise, the factory setting for the compression ratio is 100% (at this maximum setting, the circuit performs the limiter function), but can be set to between 0 and 100% by adjusting the Ratio Control.

Note: The LED Bar Graph Output Meter can be used to view the effects of adjusting the Compressor/Limiter controls. Turn off power amplifiers while performing these adjustments.

Warning: If the amplifier/speaker combination being used is such that the speaker(s) can be overdriven to failure, always operate the mixer with the Output Limit Switch in the "on" position and the ratio should be set at 100%.

Special Features Activation

The CAM8PRO mixer has several built-in features which are easily activated by making adjustments inside the mixer chassis. Changing the selection of all built-in features requires only the correct placement of internal jumpers or varying the settings of an internal potentiometer.

Note: All the internal components — jumpers and potentiometers — to which adjustments are needed for built-in features are highlighted within dashed areas in the drawing below.
Warning: Adjustments made to any other internal components may void the warranty.

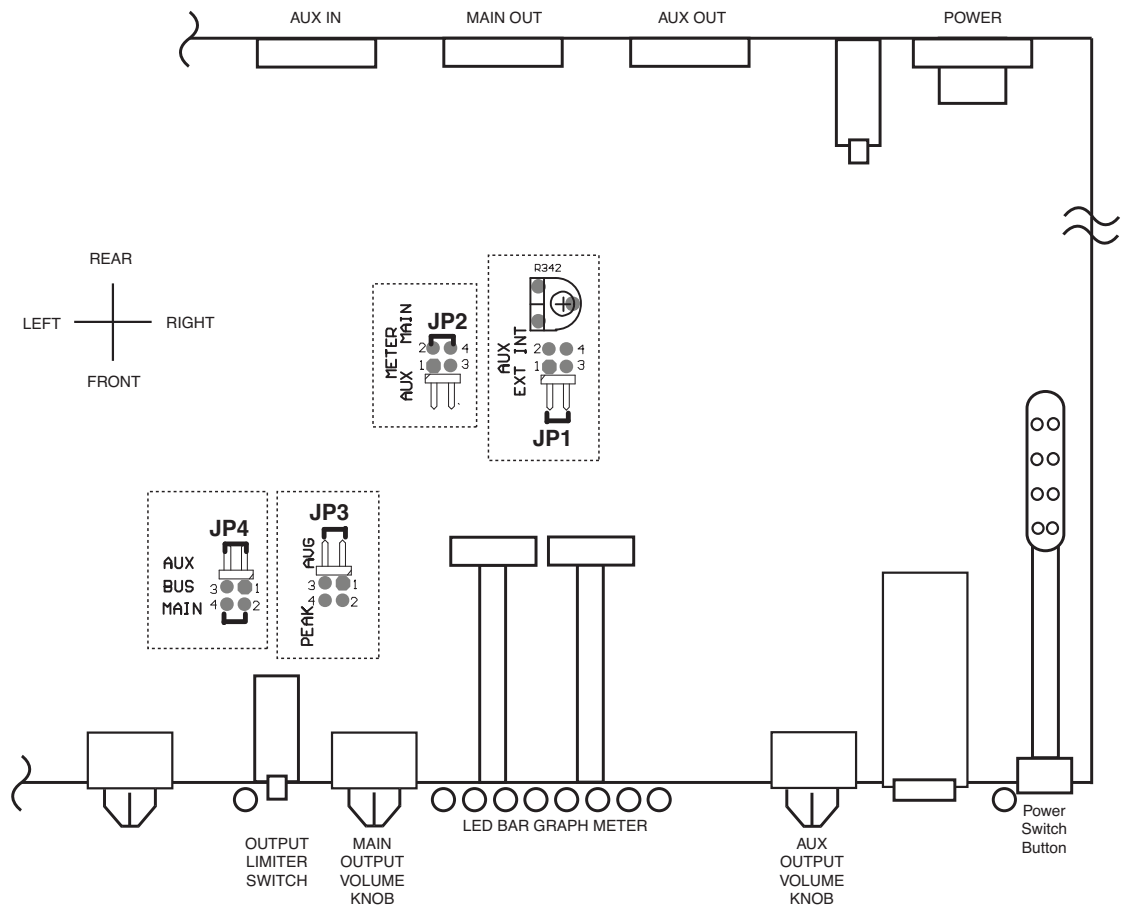

Jumper Options

Changing Jumper Settings

To change a jumper setting, remove the ten screws secured to the top of the mixer. After removing the top of the mixer, locate the jumper to be changed by referring to the drawing on page 17. Jumpers are included from the factory in positions: JP1: 1-3, JP2: 2-4, JP3: 1-3, JP4: 1-3, 2-4..

Warning: Disconnect AC Power before opening case.

Bar Graph Options

The mixer's meter can be configured to meter the output of either the main or auxiliary bus. In addition, the bar graph can be configured to register either the peak or average level of the audio signal.

JP2

The **LED Bar Graph Output Meter** can be set to register either the main or auxiliary bus output audio signal. The choices are:

MAIN installed: The Bar Graph meters the main bus output. This is the factory default.

AUX installed: The Bar Graph meters the auxiliary bus output.

Note: The meter will operate only when a jumper is in one of these two positions.

JP3

The **LED Bar Graph Output Meter** can be set to register either the peak or average level of the output audio signal. The choices are:

PEAK installed: The Bar Graph meter registers the peak level of the audio output.

AVG installed: The Bar Graph registers the average level of the audio output. This is the factory default.

Note: The meter will operate only when a jumper is in one of these two positions.

Bus Routing Options

AUX In Jumpers: JP4

These jumpers determine the destination of the Auxiliary Input. The choices are:

MAIN installed: Auxiliary Input is routed to Main Output.

AUX installed: Auxiliary Input is routed to Auxiliary Output.

MAIN and **AUX** both installed: Auxiliary Input is routed to both Main and AUX outputs. This is the factory default setting.

AUX Source Jumpers: JP1

These jumpers determine which of two gain controls are used to control the level of the **AUX** output. The choices are:

INT installed: AUX output gain is controlled by the internal pot, "AUX Pregain Pot" R342 (see page 17 for location). The front panel AUX output volume knob continues to independently control the gain of the headphone amplifier jack on the front panel. This setting is typically used in a linking situation where the output from a mixer must remain fixed, since JP1 makes the output of that mixer tamperproof (from the front panel). With **INT** installed, the front panel AUX volume knob controls only the headphone level.

EXT installed: AUX output gain is controlled by AUX volume knob on front panel. The 1/4-inch Headphone amp is also controlled by the AUX volume knob, but not independently of the AUX output.

This is the Factory Default.

Note: Never install jumpers in both positions **INT** and **EXT**.

Troubleshooting Tips

NO POWER

Check the connections between the mixer and the power supply and the external AC power supply. Examine the 4-pin connector as shown on page 22.

Check the wall outlet.

NO SOUND

- Make sure the MIC/Line switch is in the proper position. (This is the most likely cause.)
- Make sure both the master and channel input controls are turned up.
- Check that the source signal cable(s) is properly connected and undamaged.
- Adjust Input Gain/Trim Control potentiometer(s) to increase gain.
- If there is still no sound, try changing input source(s) to different channel(s).

DISTORTED SOUND

- Turn down the master volume control. If distortion persists, input channel(s) gain is the likely cause.
- Check position of all line/MIC switches.
- Determine the distorting input channel(s) by checking them one at a time.
- Decrease gain of input channel(s) causing distortion by turning the screw on the rear panel.

EXCESSIVE HISS or HUM

Hiss: Make sure the volume control knobs for all the unused channels are turned all the way off (i.e., at the 7 o'clock position).

- Make sure that all unused input channels have the MIC/Line switch in the Line position.
- Make sure the MIC/Line switch is in the correct position for both the inputs and the main output.

Hum: MIC lines can easily cause hum. Make sure to locate them away from vibration and magnetic field sources (motors, power supplies and lines, and data lines).

Check MIC lines, especially the shield, for damage.

Another common source of hum is a ground loop, which can result from connecting two or more powered devices together.

Turn both the Main and Auxiliary volume controls down. If the hum is still present, the ground loop or other cause is not in the mixer, but in the devices that come after it in the audio path or in the connection between the mixer and following equipment. (If the hum disappears, then the cause is either in the mixer or in one of the inputs to the mixer. Turn each of the volume controls [both the individual input channels and the two buses] down independently, to determine which one is the source of the hum.)

Check for unbalanced connections; use balanced connections, if possible. For all unbalanced connections, try disconnecting the signal line ground to eliminate multiple ground paths.

Glossary

Auxiliary Input - Accepts only a balanced, line-level input (unlike the 8 channels); the auxiliary input has no volume control.

Compression Ratio - The ratio of the output level above the threshold level to the input level above the threshold.

Compression Threshold - The volume level, in dB, which is set as the optimum device operating level, and above which the Compressor/Limiter begins to operate.

Compressor - A special type of limiting device, which controls the total volume level of a signal by compressing the part of the signal which exceeds a predetermined threshold. The threshold can be varied.

Gain/Trim Control - Gain is the ratio between the input and output signal levels. Trim is the adjustment of the gain of the input stage to offset the differences between input signal levels.

Ground Loop - A condition which can occur when several ground pathways exist between two or more devices and which can cause hum in the audio signal.

Jumper - A short length of conductor used to connect pins electrically.

Limiter - A device that severely (at rates greater than 10:1) restricts the upper dynamic range of a signal, by regulating the rate of increase of an input signal's amplitude so that it will not exceed a predetermined threshold.

Line/Microphone Level - The two signal level ranges at which the mixer accepts input. MIC level is usually -50 dB μ and Line level is usually +4 dB.

Low Cut Switch - Removes the lower-frequency (<100 Hz) components, which cause rumble, from a signal.

Phantom Power - A method of powering condenser microphones by sending DC current over the same MIC cable that carries the audio signal. Called "Phantom" as there is no visible power cord and the voltage is not perceptible in the audio signal.

Pot - Potentiometer.

RCA Connector - An unbalanced line level connection, also known as "phono connector."

Summing Junction - The point in the CAM8PRO circuitry where the audio signals are mixed.

Technical Information

SPECIFICATIONS

Signal-to-Noise	Ref +26 dBV @ 54 dB sys gain = 90 dB
MIC Pre-amp Equivalent Input Noise	-129 dB @ 150 ohm, 20 Hz to 20 kHz
Maximum Voltage Gain	96 dB
Frequency Response	± 1 dB from 20 Hz to 20 kHz; +0, -3 dB from 10 Hz to 30 kHz
Crosstalk (adjacent channels).....	better than -90 dB
Phantom Power.....	+30V DC

INPUTS 1-8

Input Impedance	3.5k ohm MIC; 15k ohm Line
Nominal Source Impedance	150 ohm
Line Pad	-50 dB
Input Gain/Trim Range	40 dB
Nominal Level (input trim pot mid-range)	-50 dB μ line pad off; 0 dB μ line pad on
Minimum Level (input trim pot max gain)	-70 dB μ line pad off; -20 dB μ line pad on
Maximum Level (input trim pot min gain plus +20 dB headroom)	-30 dB μ line pad off; +20 dB μ line pad on

AUXILIARY INPUT

Input Impedance	20k ohm balanced
Nominal Input Level	0 dB μ

OUTPUTS

Output Impedance.....	220 ohm unbalanced, 440 ohm balanced
Nominal Load Impedance	> 600 ohm
Nominal Level	+4 dB μ RMS
Maximum Level.....	+26 dB μ RMS Balanced
Main Output MIC Pad	-50 dB

AUXILIARY CIRCUITS

LED Bar Graph	-18, -12, -6, -3, 0, +3, +6, +12VU (0 VU = +4 dB) Average or Peak reading
---------------------	--

LIMITER/COMPRESSOR

Threshold Adj. Range	-20 dB to +20 dB
Ratio Adj. Range	0 to 100%
Low Cut Filter	18 dB/octave at 100 Hz

UNIT SPECIFICATIONS

Power Requirements.....	17V AC center-tapped; 120V AC, 60 Hz
Dimensions	19" W x 1-3/4" H x 7-1/2" D
Product Weight	7 lb.

Block Diagram

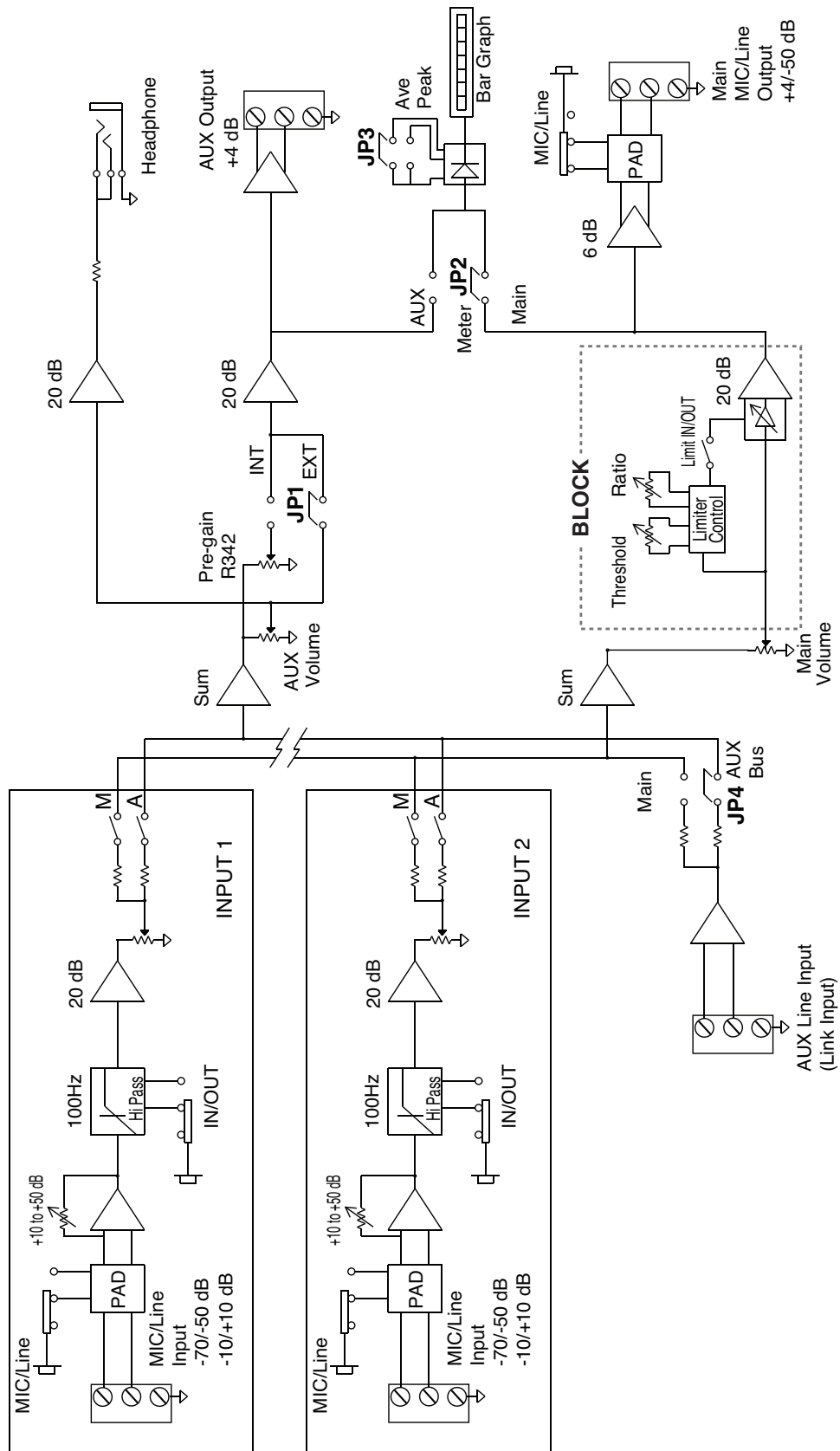

Notes

Warranty; Exclusion of Certain Damages

The **Bogen CAM8PRO Mixer** is warranted to be free from defects in material and workmanship for two (2) years from the date of sale to the original purchaser. Any part of the product covered by this warranty that, with normal installation and use, becomes defective (as confirmed by Bogen upon inspection) during the applicable warranty period, will be repaired or replaced by Bogen, at Bogen's option, provided the product is shipped insured and prepaid to: Bogen Factory Service Department, 50 Spring Street, Ramsey, NJ 07446, USA. Repaired or replacement product will be returned to you freight prepaid. This warranty does not extend to any of our products that have been subjected to abuse, misuse, improper storage, neglect, accident, improper installation or have been modified or repaired or altered in any manner whatsoever, or where the serial number or date code has been removed or defaced.

THE FOREGOING LIMITED WARRANTY IS BOGEN'S SOLE AND EXCLUSIVE WARRANTY AND THE PURCHASER'S SOLE AND EXCLUSIVE REMEDY. BOGEN MAKES NO OTHER WARRANTIES OF ANY KIND, EITHER EXPRESS OR IMPLIED, AND ALL IMPLIED WARRANTIES OF MERCHANTABILITY OR FITNESS FOR A PARTICULAR PURPOSE ARE HEREBY DISCLAIMED AND EXCLUDED TO THE MAXIMUM EXTENT ALLOWABLE BY LAW. Bogen's liability arising out of the manufacture, sale or supplying of products or their use or disposition, whether based upon warranty, contract, tort or otherwise, shall be limited to the price of the product. **IN NO EVENT SHALL BOGEN BE LIABLE FOR SPECIAL, INCIDENTAL OR CONSEQUENTIAL DAMAGES (INCLUDING, BUT NOT LIMITED TO, LOSS OF PROFITS, LOSS OF DATA OR LOSS OF USE DAMAGES) ARISING OUT OF THE MANUFACTURE, SALE OR SUPPLYING OF PRODUCTS, EVEN IF BOGEN HAS BEEN ADVISED OF THE POSSIBILITY OF SUCH DAMAGES OR LOSSES.** Some States do not allow the exclusion or limitation of incidental or consequential damages, so the above limitation or exclusion may not apply to you. This warranty gives you specific legal rights, and you may also have other rights which vary from State to State.

Products that are out of warranty will also be repaired by the Bogen Factory Service Department – same address as above or call 201-934-8500. The parts and labor involved in these repairs are warranted for 90 days when repaired by the Bogen Factory Service Department. All shipping charges in addition to parts and labor charges will be at the owner's expense. All returns require a Return Authorization number. For most efficient warranty or repair service, please include a description of the failure.

12/2008

BOGEN[®]
COMMUNICATIONS, INC.

www.bogen.com