

# REQUEST-TO-EXIT DETECTOR FULLY PROGRAMMABLE INSTALLATION INSTRUCTIONS



0E-RXD

## APPLICATIONS

The ADI PRO 0E-RXD combines a passive-infrared detector with relay output to allow control of door ingress and egress in request-to-exit (REX) applications. It is UL Listed as an access control device under the UL 294 standard. It is for indoor use only. 0E-RXD is not designed for use as the primary means of exit for emergency egress.

0E-RXD can be ceiling or wall mounted over the door and the detection pattern can be tailored via vertical aim adjustment and/or masking of the detection pattern.

The relay output consists of two form "C" contacts that can be adjusted to latch from 0.5 second to 64 seconds. Resettable or non-resettable can be selected for the latch time. The relay can also be programmed to fail safe (doors unlocked) or fail secure (doors locked) mode in the event of a power loss.

An optional trim plate – ADI PRO model 0E-TP (not evaluated by UL) – is available for easy and attractive installation using a standard single gang electrical box oriented horizontally.

## SPECIFICATIONS

- Voltage input:** 12VDC or 12VAC; 24VDC or 24VAC
- Current draw:** 16mA @ 12VDC (see Current Ratings on page 4)
- NO INTERNAL BATTERY.** Budget 38mAh per hour standby
- REX detector output:** 2 Form C relay contacts rated 2A 30VDC/VAC maximum for DC resistive loads
- Indicator:** Green LED for PIR detection
- Relay latch duration:** Adjustable from 0.5 second to 64 seconds
- Timer modes:** Selectable for resettable (cumulative) or non-resettable (counting)
- Power loss operation modes:** Selectable for fail safe (doors unlocked) or fail secure (doors locked)
- Mounting locations:** Above door(s) controlled on door frame, wall or ceiling
- Mounting height:** 7' to 15'
- Housing:** High impact ABS plastic
- Dimensions:** 7"W x 1.75"H x 1.88" D (178W x 44H x 48Dmm)
- Operating temperature:** -20°F to 120°F (-29°C to 49°C); RH: 0-85%
- RFI immunity:** 26 MHz to 1000 MHz @ 50 V/m (FCC)

## WIRING

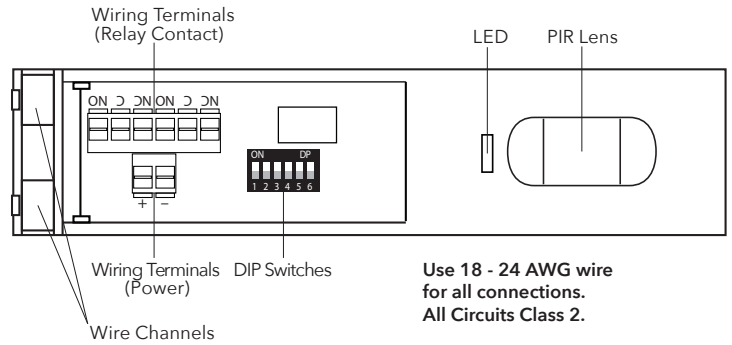

**NOTE:** All wiring connections should be made and verified before any power is connected to the detector. All power, including standby battery if used, should be disconnected.

Connect wires to terminals as follows:

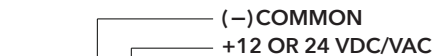

**Use EMF (voltage) spike-protected relay** when connecting inductive loads to the detector to protect against possible harmful EMF spikes.

**Use Non EMF (voltage) spike-protected relay** for non-inductive loads. When connecting an inductive load to the detector that is not spike-protected (such as a magnetic lock), use either a 1kV 1A diode or 100V, 4A bridge rectifier. Otherwise relay life may be shortened.

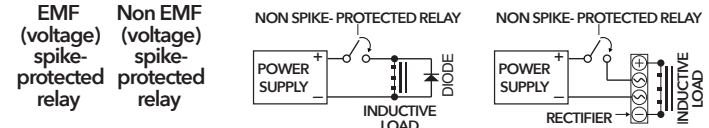

Most UL1034 listed magnetic locks are already EMF spike-protected and therefore do NOT require a diode or bridge rectifier, and adding either could cause response delays. Check magnetic lock specifications.

Choose either Fail Safe or Fail Secure operation and wire to either EMF or Non EMF contacts as follows:

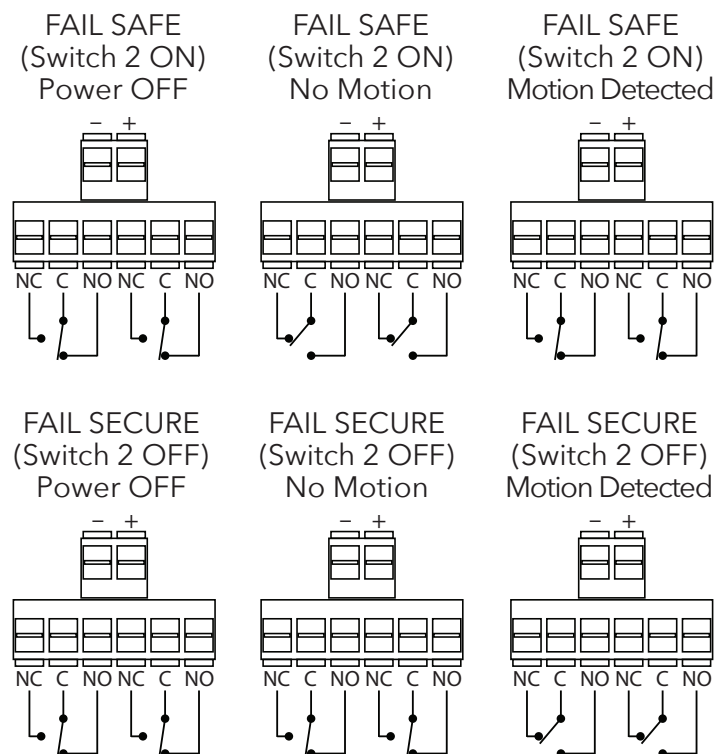

ACCESS CONTROL  
UL LISTED  
UL 294 LISTED  
ACCESS CONTROL SYSTEM UNITS  
Edition 6

**ADI PRO TECHNICAL SUPPORT**  
1.833.574.9124  
ADIPRO@adiglobal.com

**WEBSITE**  
adiglobal.com/adiexclusivebrands



## DIP SWITCH SETTINGS

Selectable operational settings for the detector are programmed via the six (6) DIP switches on the circuit board and accessible with the detector cover removed. Switches are in the ON position when the raised part (shown as white below) is in the upward position toward the word "ON," and are in the OFF position when the raised part is in the downward position toward the switch number. Shown below are switches 1-5 in the ON position and switch 6 in the OFF position:

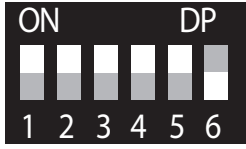

The following operational settings must be selected:

### DIP SWITCH 1 – Resettable/Non-resettable timer selection

DIP Switch 1 selects either relay reset at the end of latch time ("Resettable") or latch time extension upon additional motion ("Non-Resettable").

**Resettable – switch ON:** After motion initially activates the relay, each additional detection of motion causes the latch timer to restart. Only when there is no longer motion and the latch time is allowed to expire will the relay deactivate. This setting is suitable for bypassing a 24-hour contact.

**Non-resettable – switch OFF:** After motion initially activates the relay, the relay will deactivate when the latch time ends even if there is additional motion. This setting is suitable for use with access control systems.

### DIP SWITCH 2 – Fail Safe/Fail Secure relay mode selection

DIP Switch 2 selects either Fail Safe (doors unlocked) or Fail Secure (doors locked) operation in the event of a power failure. Setting selected must comply with all applicable regulations and be verified by local AHJ (Authority Having Jurisdiction).

**Fail Safe – switch ON:** In the event of a power failure, the relay causes the locking mechanism (such as door strike or magnetic lock) to unlock.

**Fail Secure – switch OFF:** In the event of a power failure, the relay causes the locking mechanism (such as door strike or magnetic lock) to remain locked. Use this setting only with AHJ approval as life safety can be affected. In addition, ensure there is no interference with functioning of any panic devices associated with the system 0E-RXD is connected to.

### DIP SWITCH 3 – LED Enable/LED Disable selection

DIP Switch 3 selects either the LED to light upon detection of motion or remain off. It is recommended not to select disable prior to walk testing the detector as it can provide visual feedback of detector coverage pattern.

**LED Enable – switch ON:** LED lights upon detection of motion.

**LED Disable – switch OFF:** LED remains off.

### DIP SWITCHES 4, 5 and 6 – Latch Time selection

DIP Switch 4, 5 and 6 are used in combination to select the duration of the relay latch time after the relay is activated by motion detection. Use the following chart to select a latch time from 0.5 second to 64 seconds:

TIME (seconds)	SWITCH 4	SWITCH 5	SWITCH 6
0.5 (default)	OFF	OFF	OFF
1	OFF	OFF	ON
2	OFF	ON	OFF
4	OFF	ON	ON
8	ON	OFF	OFF
16	ON	OFF	ON
32	ON	ON	OFF
64	ON	ON	ON

## INSTALLATION

Remove the cover of the detector by inserting a flat head screwdriver into the slot on the back of the detector (at the opposite end from the lens) and prying it off. Follow instructions for wiring and DIP switch settings.

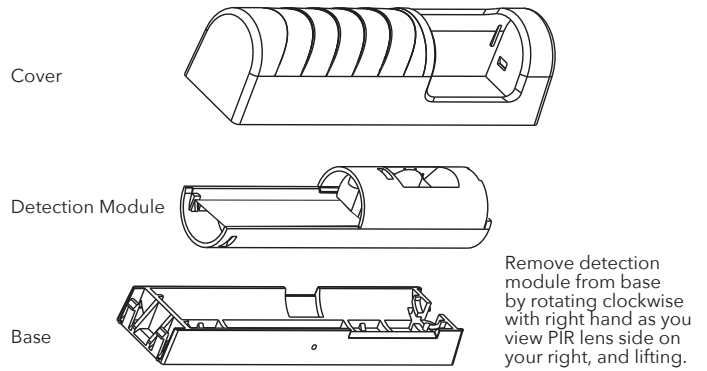

Remove detection module from base by rotating clockwise with right hand as you view PIR lens side on your right, and lifting.

Route wires through the wiring entrances on the left side of the detector. For surface wiring, carefully cut out the breakaway notch provided on the cover at the same end as the wire entrances appear on the base.

The detector can be mounted from 7' to 15' (2.1m to 4.6m) above the floor. Mounting height affects the detection pattern, generally expanding it as the height increases.

Mount the base to the mounting surface using mounting screws supplied. **The word "DOOR" on the base must be right side up (and arrows pointing down toward door) for correct mounting.**

Re-insert the detection module into the base (turning counter-clockwise, opposite of removal shown above). Aim the detector for coverage desired. Tighten detector module lock screw to prevent movement of the detector module and disruption of coverage pattern due to vibration, etc.

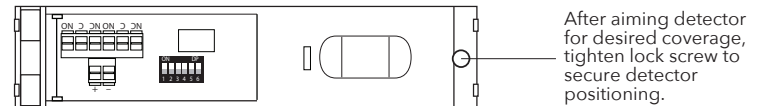

After aiming detector for desired coverage, tighten lock screw to secure detector positioning.

To mask the PIR detection pattern, insert masking wedges using small holes at top and bottom of PIR lens on outside surface of detector. Masking can reduce unintended activation by persons not intending egress.



Masking wedge inserted to block part of detection pattern

After verifying detection coverage pattern by walk test, make sure all wiring and DIP switch settings are correct and that detection module aim is locked. Replace cover and press firmly to snap in place.

## OPTIONAL TRIM PLATE

0E-RXD is not tall enough to cover a single gang box. For a neat, attractive installation, mount the detector using the optional trimplate (0E-TP):

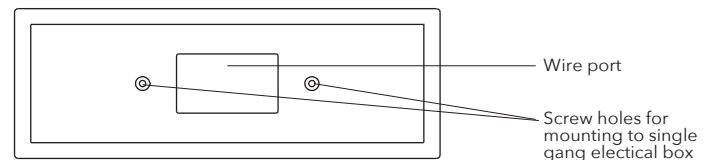

Wire port

Screw holes for mounting to single gang electrical box

Route wires through trim plate, into channels on back of detector base and through wiring channels on left side. When mounting detector base as described above, after inserting screws through holes in detector base, pass them through trim plate holes and into mounting holes on installed single gang box. Tighten screws. **Model 0E-TP not evaluated by UL.**

# DETECTION COVERAGE PATTERN

The ideal installation of 0E-RXD provides responsiveness to the motion of persons attempting to exit while minimizing unintended triggering of the detector. Persons moving at a normal pace toward the door(s) to exit should be able to push the door open without waiting for the door to unlock. Persons in areas not close to the door and not moving toward the door to exit should generally not cause the door to unlock by triggering the detector. Achieving the proper balance of ensuring responsiveness while minimizing unintended triggering is mostly a function of the following factors affecting the coverage pattern:

- Choice of wall (including door frame) or ceiling mount
- Mounting height
- Aiming of the detector (vertical only)
- Masking of the PIR lens (see "Installation" on previous page)

In general, the further from the floor the detector is located the larger the detection pattern becomes. The higher the detector is aimed, the further the pattern extends (when wall mounted) though detection range is limited to about 20' (about 6 meters) maximum. Aiming the detector lower to bring the coverage pattern closer to the door can help eliminate triggering from persons moving in the vicinity of the door without intending to exit. When selecting Non-resettable latch time (DIP switch 2 OFF), adjust latch time (DIP switches 4, 5 and 6) to allow persons intending to exit to reach the door in time after triggering the detector.

The Fresnel lens of the PIR detector is segmented to provide six (6) dual detection zones. The body heat (IR energy) of a person moving through a zone triggers the detector. When wall mounted at a height of 7' with the detector aimed downward by 14° (-14°), 0E-RXD produces approximately the following coverage pattern on the floor as seen from above:

Aiming the detector lower brings coverage closer to the door, possibly reducing unintended triggering of the detector. When wall mounted at a height of 7' with the detector aimed downward by 14° (-14°), 0E-RXD produces approximately the following coverage pattern on the floor as seen from above:

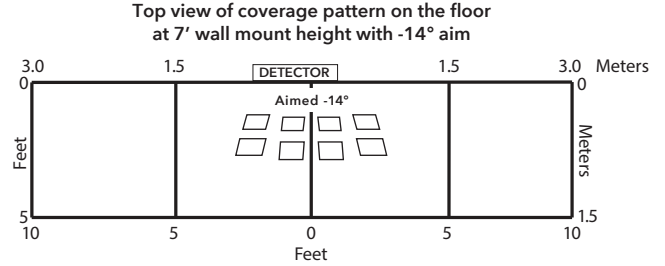

When wall mounted at a height of 15' with the detector aimed downward by 14° (-14°), 0E-RXD, produces approximately the following expanded coverage pattern on the floor as seen from above:

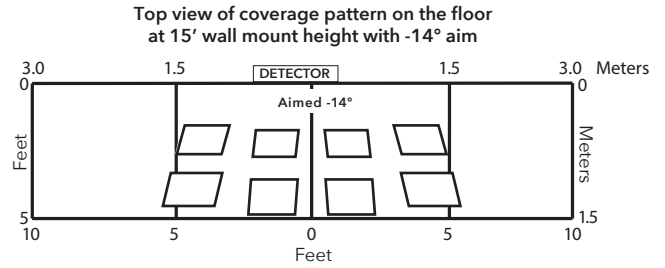

Viewed from the side, the coverage range is approximately as follows:

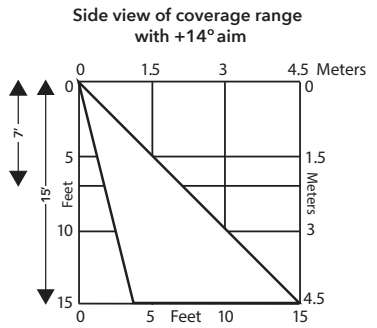
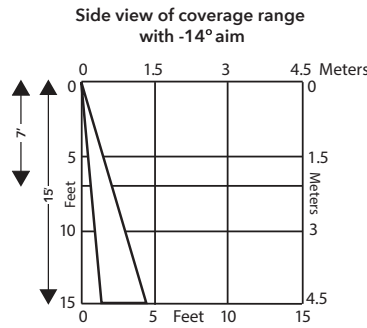
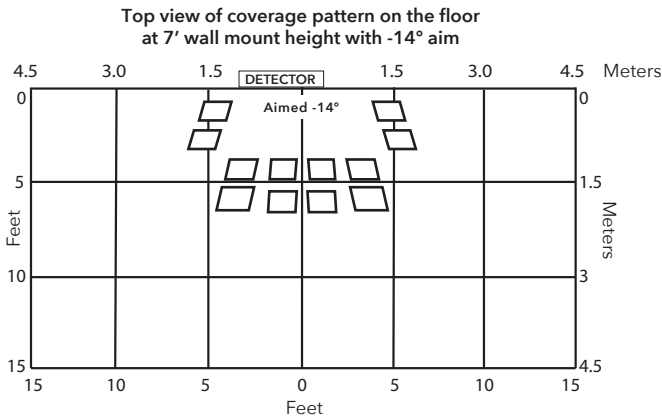

When wall mounted at a height of 15' with the detector aimed upward by 14° (+14°), 0E-RXD produces approximately the following expanded coverage pattern on the floor as seen from above:

To provide responsive egress for double doors, mount one 0E-RXD above the center of each door and wire the outputs so that detection of motion by either detector will unlock the doors. In most cases, masking the inside zones on both detectors will not affect responsiveness yet may reduce the possibility of triggering from insertion of an object between the two doors.

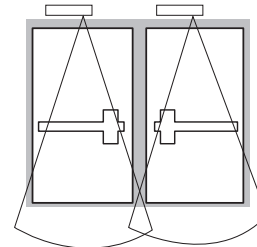
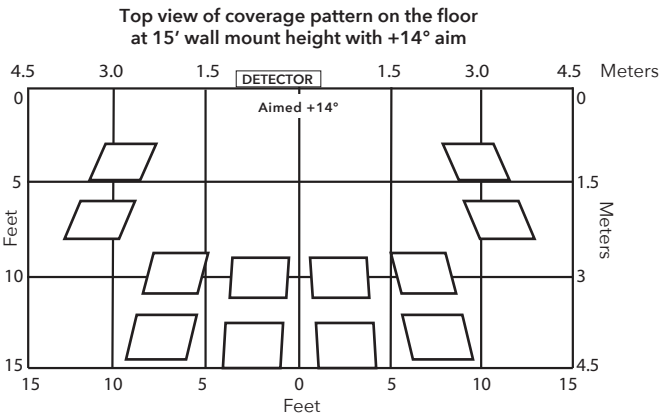

The gap between double doors without a center post may allow intruders to trigger the motion detector by inserting a hot or cold object into the detection pattern. An alternative mounting option should be chosen to avoid this possibility, such as ceiling mounting away from the door.

## INSTALLATION TESTING

**NOTE:** All wiring connections should be made and verified before any power is connected to the detector. All power, including standby battery if used, should be disconnected.

**Do not replace detector cover before the following have been completed:**

- All wiring connections have been made and verified
- Detector has been properly mounted
- A walk test has been conducted to confirm coverage and proper functioning of the system

Apply power to the unit after determining all wiring connections have been properly made and that no hazards exist. The detector's green LED will initially flash on and off unless it has been disabled (DIP switch 3 set to OFF position). The LED should be enabled (DIP switch 3 set to ON position) to conduct a proper walk test and can be disabled afterward if required prior to replacing detector cover.

Allow the detector to stabilize for five (5) minutes. Conduct a walk test by approaching the door from all angles that persons can normally be expected to approach from and verify responsiveness. Adjust the detector aim up or down as necessary to optimize the detection pattern. Also verify that traffic not intending to exit does not typically trigger the detector. If necessary, adjust the detector aim. Mask the PIR lens if necessary.

Be sure to tighten the lock screw for the detector aim after detection coverage has been finalized.

Ensure that latch duration allows enough time to reach the door after detection and adjust if necessary.

Verify Fail-Safe or Fail-Secure operation by temporarily disconnecting power to the unit and determining that door is unlocked (Fail-Safe) or locked (Fail-Secure). Reset DIP switch 2 if necessary and repeat test. Setting selected must comply with all applicable regulations and be verified by local AHJ (Authority Having Jurisdiction).

After confirming the detector is operating as required (including leaving LED enabled or disabling it following final walk test), replace the cover and perform one final walk test to ensure proper operation.

The detector should be tested at least once a year to ensure proper operation of all functions.

### **Important Note:**

**0E-RXD is designed for installation by properly trained, experienced and qualified technicians only. It should be installed in compliance with all applicable local, regional and national electrical and safety codes.**

## PERFORMANCE LEVEL

0E-RXD meets the following performance levels for Access Control (UL294 6th Edition):

<u>Feature</u>	<u>Level</u>
Destructive Attack	I
Line Security	I
Endurance	IV
Standby Power	I

### **Current Ratings**

**The following are the maximum current ratings for each input voltage:**

<u>Input Voltage</u>	<u>Maximum Current</u>
12VDC	16mA
12VAC	18mA
24VDC	20mA
24VAC	22mA

**NOTE:** Install in accordance with National Electric Code (NEC 70) and the applicable National Fire Protection Association (NFPA) Installation Standards, local codes and the local Authority Having Jurisdiction (AHJ).

### **All Circuits Class 2**

# WARRANTY

## 1. Limited Warranty

### a. General

Subject to the terms and conditions of this Limited Warranty, from the date of sale through the period of time for product categories specified in Section 1(b), ADI warrants its ADI PRO products to be free from defects in materials and workmanship under normal use and service, normal wear and tear excepted. Except as required by law, this Limited Warranty is only made to Buyer and may not be transferred to any third party.

ADI shall have no obligation under this Limited Warranty or otherwise if:

- (i) The product is improperly installed, applied or maintained;
- (ii) The product is installed outside of stated operating parameters, altered, or improperly services or repaired;
- (iii) Damage is caused by outside natural occurrences, such as lightning, power surges, fire, floods, acts of nature, or the like.
- (iv) Defects resulting from unauthorized modification, misuse, vandalism, or other causes unrelated to defective materials or workmanship, or failures related to batteries of any type used in connection with the products sold hereunder.

ADI only warrants those products branded as ADI PRO products and sold by ADI. Any other products branded by third parties are warranted by the third-party manufacturer for a period as defined by the third party manufacturer, and ADI assigns to Buyer those warranties and only those warranties extended by such third party manufacturers or vendors for non-ADI branded products. ADI does not itself warrant any non-ADI branded product and sells only on an as is basis in accordance with ADI's terms and conditions of sale.

### b. Specific Warranties for product categories are as follows:

Product Category	Warranty Period
Request-to-Exit Detector	2 Years

## 2. EXCLUSION OF WARRANTIES, LIMITATION OF LIABILITY

THERE ARE NO WARRANTIES OR CONDITIONS, EXPRESS OR IMPLIED, OF MERCHANTABILITY, OR FITNESS FOR A PARTICULAR PURPOSE OR OTHERWISE, WHICH EXTEND BEYOND THE DESCRIPTION ON THE FACE HEREOF. TO THE FULLEST EXTENT PERMITTED BY LAW, IN NO CASE SHALL ADI BE LIABLE TO ANYONE FOR ANY (I) CONSEQUENTIAL, INCIDENTAL, INDIRECT, SPECIAL, OR PUNITIVE DAMAGES ARISING OUT OF OR RELATING IN ANY WAY TO THE PRODUCT AND/OR FOR BREACH OF THIS OR ANY OTHER WARRANTY OR CONDITION, EXPRESS OR IMPLIED, OR UPON ANY OTHER BASIS OF LIABILITY WHATSOEVER, EVEN IF THE LOSS OR DAMAGE IS CAUSED BY ADI'S OWN NEGLIGENCE OR FAULT AND EVEN IF ADI HAS BEEN ADVISED OF THE POSSIBILITY OF SUCH LOSSES OR DAMAGES. Any product description (whether in writing or made orally by ADI or ADI's agents), specifications, samples, models, bulletin, drawings, diagrams, engineering sheets, or similar materials used in connection with the Buyer's order are for the sole purpose of identifying ADI's products and shall not be construed as an express warranty or condition. Any suggestions by ADI or ADI's agents regarding use, applications or suitability of the products shall not be construed as an express warranty or condition unless confirmed to be such in writing by ADI. ADI does not represent that the products it sells may not be compromised or circumvented; that the products will prevent any personal injury or property loss by burglary, robbery, fire or otherwise, or that the products will in all cases provide adequate warning or protection. Buyer understands and will cause its customer to understand that a properly installed and

maintained product is not insurance or guarantee that such will not cause or lead to personal injury or property loss. CONSEQUENTLY ADI SHALL HAVE NO LIABILITY FOR ANY PERSONAL INJURY, PROPERTY DAMAGE OR OTHER LOSS BASED ON ANY CLAIM AT ALL INCLUDING A CLAIM THAT THE PRODUCT FAILED TO GIVE WARNING. However, if ADI is held liable whether directly or indirectly for any loss or damage with respect to the products it sells, regardless of cause or origin, its maximum liability shall not in any case exceed the purchase price of the product, which shall be fixed as liquidated damages and not as a penalty and shall be the complete and exclusive remedy against ADI.

## 3. Limitation on Liability to Buyer's Customers

Buyer agrees to limit liability to its customers to the fullest extent permitted by law. Buyer acknowledges that ADI shall only be deemed to give consumers of its products such statutory warranties as may be required by law and at no time shall Buyer represent to its customers and/or users of ADI products that ADI provides any additional warranties. By accepting the products, to the fullest extent permitted by law, Buyer assumes all liability for, and agrees to indemnify and hold ADI harmless against and defend ADI from, any and all suits, claims, demands, causes of action and judgments relating to damages, whether for personal injury or to personal property, suffered by any person, firm, corporation or business association, including but not limited to, Buyer's customers and/or users of the products because of any failure of the products to detect and/or warn of the danger for which the goods were designed or any other failure of the products whether or not such damages are caused or contributed to by the sold or joint concurring negligence or fault of ADI.

## 4. Returns

Subject to the terms and conditions listed below, during the applicable warranty period, ADI will replace Product or provide a credit at purchase at its sole option free of charge any defective products returned prepaid. Any obligations of ADI to replace Limited Lifetime warranty products pursuant to this warranty which result from defect are limited to the availability of replacement product. ADI reserves the right to replace any such products with the then currently available products, or provide a credit in its sole discretion. In the event Buyer has a problem with any ADI product, please call your local ADI branch for return instructions:

For US call 1-800-233-6261

For Canada call 877-234-7378

For Puerto Rico call 787-793-8830

Be sure to have the model number and the nature of the problem available. In the event of replacement, the return product will be credited to Buyer's account and a new invoice issued for the replacement item. ADI reserves the right to issue a credit only in lieu of replacement.

If any ADI PRO product is found to be in good working order or such product's inability to function properly is a result of user damage or abuse, the product will be returned to Buyer in the same condition as received and Buyer shall be responsible for any return freight changes.

## 5. Governing Law

The laws of State of New York apply to this Limited Warranty.

## 6. Miscellaneous

Where any term of this Limited Warranty is prohibited by such laws, it shall be null and void, but the remainder of the Limited Warranty shall remain in full force and effect.