



5-Port Industrial Gigabit PoE+ Wall-Mounted Front Access Switch

TI-PG50F (v2.0R)

- 4 x Gigabit PoE+ ports
- 1 x Gigabit port
- 120W PoE power budget
- 10Gbps switching capacity
- Supports jumbo frames up to 9KB
- Hardened IP30 rated metal housing
- Includes DIN-Rail bracket and magnetic wall mount kit
- Operating temperature range of -40° – 75° C (-40° – 167° F)
- Redundant power inputs with overload current protection
- Alarm relay triggered by power failure
- Power supply sold separately (models: TI-S12048, TI-S24048, and 48VDC3000)
- Lifetime Warranty

TRENDnet's Industrial Gigabit PoE+ Wall-Mounted Front Access Switch Series are well suited for IP surveillance, IoT, and automation networks for homes and businesses. These hardened industrial gigabit flat switches provide front access to ports and power interfaces for easier installation. The flat and compact size make them ideal for cabinet installations where space is limited. Each hardened industrial front access switch features gigabit PoE+ ports for connecting devices such as wireless access points, IP cameras, and IoT appliances. These hardened front access switches come equipped with an IP30 rated metal enclosure, designed to withstand a high degree of vibration and shock, while operating within a wide temperature range of -40° – 75° C (-40° – 167° F) for industrial environments.

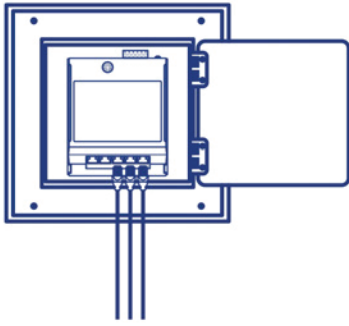

Wall-Mounted Front Access Switch

The wall mountable flat switch provides front access to ports and power interfaces for easier installation. Its flat and compact size make it ideal for cabinet installations where space is limited.

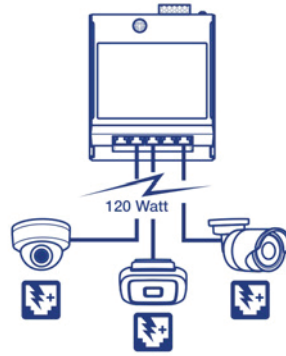

PoE+ Power

A 120W PoE power budget supplies PoE power from the hardened industrial front access switch to up to five Power over Ethernet devices.



Hardened Industrial Design

Equipped with an IP30 rated metal enclosure, this front access switch is designed to withstand a high degree of vibration and shock, while operating within a wide temperature range of -40° – 75° C (-40° – 167° F) for industrial environments.

NETWORKING SOLUTION

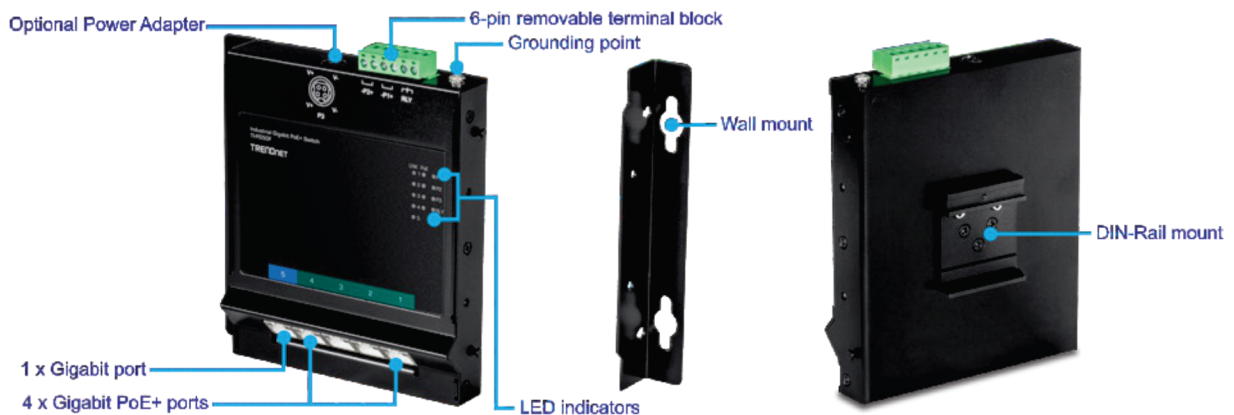
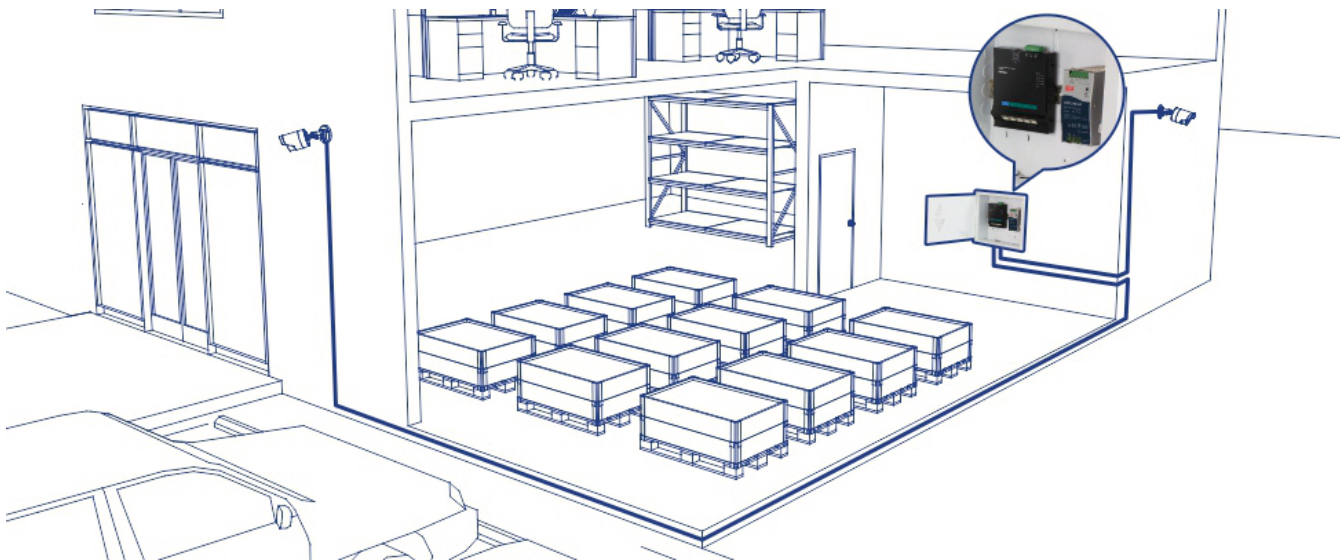

FEATURES



Network Ports

4 x Gigabit PoE+ ports and 1 x Gigabit port



PoE Power

Supplies up to 30W of PoE+ power per port with a 120W power budget



Hardware Design

Wall mountable hardware design provides front access to ports and power interfaces for easier installation



Compact

The flat and compact size makes the front access switch ideal for cabinet installations where space is limited



Mounting Hardware

Includes DIN-Rail bracket and magnetic wall mount kit



Switching Capacity

10Gbps switching capacity



Redundant Power

Dual power inputs provide redundant power with overload current protection, and an output alarm relay to indicate input power failure. (power supply sold separately: TI-S12048, TI-S24048, and 48VDC3000)



Alarm Relay

Alarm relay output triggered by power failure of primary or secondary power inputs



Jumbo Frames

Sends larger packets, or jumbo frames (up to 9KB), for increased performance



Wide Temperature Range

Hardened industrial housing offers a wide operating temperature range of -40° – 75° C (-40° – 167° F), allowing for installations in extreme hot and cold environments



Shock and Vibration Resistant

Hardened design rated for shock (EN 60068-2-27), freefall (EN 60068-2-32), and vibration (EN 60068-2-6) for industrial settings



Grounding Point

Grounding point protects equipment from external electrical surges



LED Indicators

Front access switch with LED indicators that convey power and port status

SPECIFICATIONS

Standards

- IEEE 802.3
- IEEE 802.3u
- IEEE 802.3ab
- IEEE 802.3x
- IEEE 802.3af
- IEEE 802.3at

Device Interface

- 4 x Gigabit PoE+ ports
- 1 x Gigabit port
- 6-pin removable terminal block
- LED indicators
- DIN-Rail mount
- Wall mount
- Grounding point

Data Transfer Rate

- Ethernet: 10Mbps (half duplex), 20Mbps (full duplex)
- Fast Ethernet: 100Mbps (half duplex), 200Mbps (full duplex)
- Gigabit: 2000Mbps (full duplex)

Performance

- Data RAM Buffer: 1024KB
- Switching Fabric: 10Gbps
- MAC Address Table: 2K entries
- Jumbo Frame: 9KB
- Forwarding rate: 7.44Mpps (64-byte packet size)

Special Features

- Hardened components rated for extreme temperatures
- Dual redundant power inputs
- Auto-Negotiation
- Auto store and forward architecture
- Automatic address learning and address aging
- ESD 8KV support

DC Power

- Input: 48 – 56V DC
- Compatible power supply: TI-S24048 (sold separately)
- Max. consumption: 5W (no PoE)

AC Power

- Input: 100 – 240V AC, 50/60Hz, 2A
- Compatible power adapter: 48VDC3000 (sold separately)
- Output: 48V DC, 3.34A 160W max.

PoE

- PoE budget: 120W @56V DC

Terminal Block

- Redundant power inputs, alarm relay contact, 6 pin
- Wire range: 0.34mm² to 2.5mm²
- Solid wire (AWG): 12-24/14-22
- Stranded wire (AWG): 12-24/14-22
- Torque: 5 lb. – In / 0.5Nm / 0.56 Nm
- Wire strip length: 7-8mm

Alarm Relay Contact

- Relay outputs with current carrying capacity of 1A, 24V DC
- Open circuit mode when two power sources are connected
- Short circuit mode when only one power source is connected

MTBF

- 454,556 hours

Housing

- IP30 metal case
- DIN-Rail mount
- Wall mount
- Magnet mount
- Grounding point

Operating Temperature

- -40° – 75° C (-40° – 167° F)

Operating Humidity

- Max. 95 % non-condensing

Dimensions

- 120 x 145 x 25mm (4.7 x 5.7 x 1 in.)

Weight

- 510g (1.2 lb.)

Certifications

- CE
- FCC
- Shock (IEC 60068-2-27)
- Freefall (IEC 60068-2-32)
- Vibration (IEC 60068-2-6)

Warranty

- Lifetime

Package Contents

- TI-PG50F
- Quick Installation Guide
- Removable terminal block
- DIN-Rail, wall and magnet mount kit

TRENDnet offers a lifetime warranty for all of its metal-enclosed network switches that have been purchased in the United States/Canada on or after 1/1/2015. Cooling fan and internal power supply carry a one-year warranty.

All references to speed are for comparison purposes only. Product specifications, size, and shape are subject to change without notice, and actual product appearance may differ from that depicted herein.