

TRENDnet®



Quick Installation Guide

TI-IG30 / TI-IG60 / TI-IG90 (V1)

Table of Contents

1 English

1. Before You Start
2. Quick Reference
3. Hardware Installation
4. Additional Information

1. Before You Start

Package Contents

- TI-IG30 / TI-IG60 / TI-IG90
- Quick Installation Guide
- Removable terminal block
- DIN-rail mount
- Wall mount kit

Minimum Requirements

- Existing network
- Power Supply (TI-S12048)

2. Quick Reference

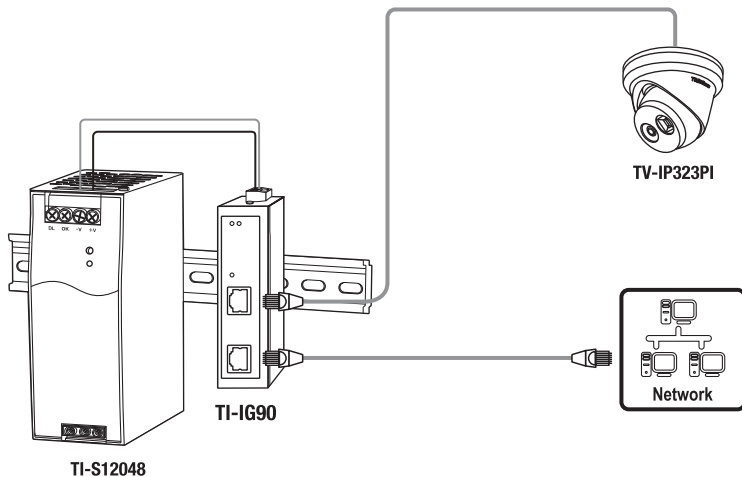

3. Hardware Installation

The PoE+ injector can be placed on a desktop, wall, or mounted to a DIN-Rail.

DIN-rail Mounting Instructions

1. Attach the DIN-Rail mount to the PoE+ injector.

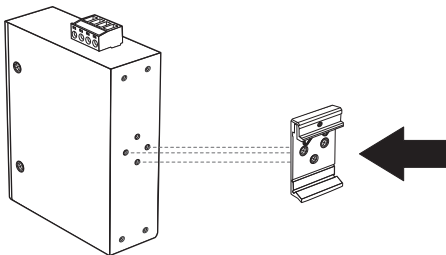

2. Position the unit in front of the DIN-Rail and hook the mount bracket over the top of the rail.

3. Rotate the injector downward towards the rail to lock it into place. You will know it is secure when you hear the click.

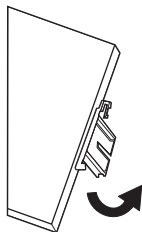

Mounting the unit

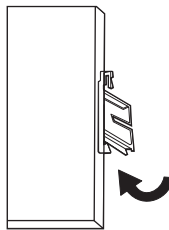

Releasing the unit

4. To remove the unit, pull down to clear the bottom of the DIN-Rail and rotate up, away from the rail.

Wall Mounting Instructions

1. Attach the wall mount plates to PoE+ injector.
2. Mount the injector.

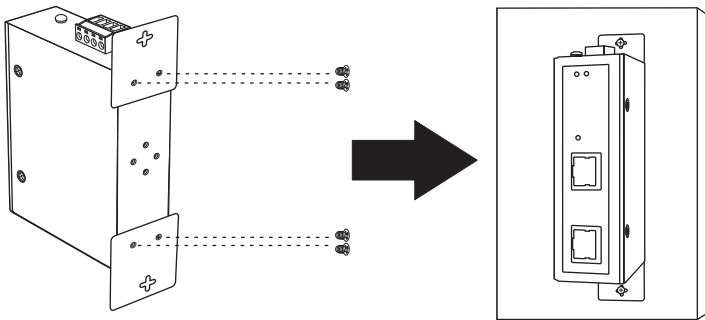

Safety Note



- Turn off the power before connecting any module or wire. The correct power supply voltage (48 - 56V DC) is listed on the product label. Check the voltage of your power source to make sure that you are using the correct part. Do NOT use voltage greater than 48 - 56V DC, the product label. (TI-IG90 power supply voltage 52-56V DC)
- Calculate the maximum possible current in each power wire and common wire. Observe all electrical codes dictating the maximum current allowable for each wire size. If the current surpasses the maximum ratings, the wiring could overheat, causing serious damage to your equipment.

Applying Power

1. Connect the power supply (sold separately) to the included terminal block (as shown below) and secure with the screws.

Note: Polarities must match.

2. Attach the terminal block to the unit, connect the neutral wire to the ground, and supply power to the power adapter.

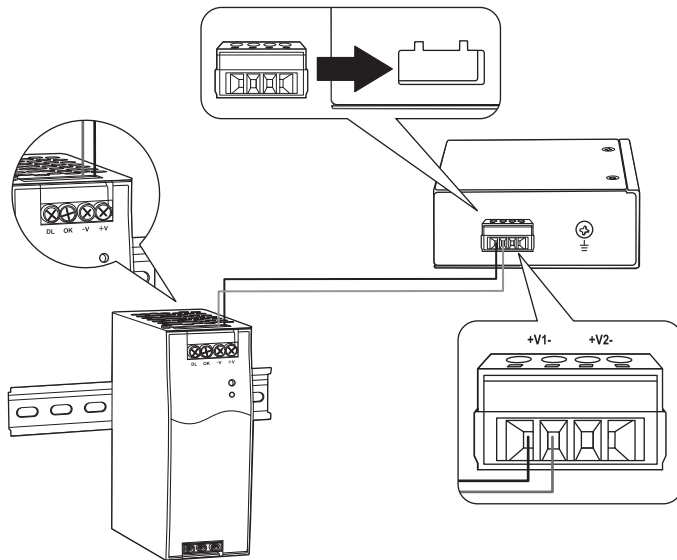

3. Connect a network source and devices to the injector. Check the LEDs to confirm the connections are established. Your installation is completed.

4. Additional information

DIP Switch (TI-IG60 ONLY)

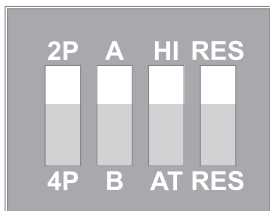

Dip 1	2P	2 pairs 30 / 36 watts
	4P	4 pairs 60 / 72 watts
Dip 2	A	Mode A End-Span is selected (Default)
	B	Mode B Mid-Span is selected
Dip 3	HI	High power 36w
	AT	IEEE802.3at 30w
Dip 4	RES	Reserved (default)
	RES	Reserved

Declaration of Conformity

TRENDNET®

Manufacturer's Name and Address

TRENDnet, Inc.
20675 Manhattan Place
Torrance, CA 90501 USA
Zwolsestraat 156 2587 WB
The Hague The Netherlands



Product Information:

Model Number: TI-IG30 / TI-IG60 / TI-IG90
Product Name: Hardened Industrial Gigabit PoE+ Injector
Hardened Industrial 60 Watt Gigabit UPoE Injector
Hardened Industrial 90W Gigabit PoE++ Injector

Trade Name: TRENDnet

TRENDnet hereby declare that the product is in compliance with the essential requirements and other relevant provisions under our sole responsibility.

Safety EN 62368-1: 2014
EMC Standard EN 55022: 2010 + AC: 2011 Class A (TI-IG30, TI-IG60)
AS/NZS CISPR 22: 2009 + A1: 2010 Class A (TI-IG30, TI-IG60)
CISPR 22: 2008 Class A (TI-IG30, TI-IG60)
EN 55024: 2010 (TI-IG30, TI-IG60)
EN 55032: 2015 (TI-IG90)
EN 55024: 2010/A1 : 2015 (TI-IG90)
CISPR 32:2015 (TI-IG90)

This product is herewith confirmed to comply with the Directives.

Directives: EMC Directive 2014/30/EU
Low Voltage Directive 2014/35
RoHS Directive 2011/65/EU
RoHS 3 Directive 2015/863/EU
REACH Regulation (EC) NO. 1907/2006
WEEE Directive 2011/65/EU

Person responsible for this declaration.
Place of Issue: Torrance, California, USA
Date: June 14, 2021
Name: Sonny Su
Title: VP of Technology

Signature: _____

A handwritten signature in black ink, appearing to read 'Sonny Su', is written over a horizontal line.



Declaration of Conformity

TRENDNET[®]

Manufacturer's Name and Address

TRENDnet, Inc.
20675 Manhattan Place
Torrance, CA 90501 USA

Authorized Representative:
Office: +44 (0) 1635 887 399
Unit 4 Rivermead Business Park,
Pipers Way, Thatcham, RG19 4EP England



Product Information:

Model Number: TI-IG30 / TI-IG60 / TI-IG90
Product Name: Hardened Industrial Gigabit PoE+ Injector
Hardened Industrial 60 Watt Gigabit UPoE Injector
Hardened Industrial 90W Gigabit PoE++ Injector

Trade Name: TRENDnet

TRENDnet hereby declare that the product is in compliance with the essential requirements and other relevant provisions under our sole responsibility.

Safety EN 62368-1: 2014
EMC Standard EN 55022: 2010 + AC: 2011 Class A (TI-IG30, TI-IG60)
AS/NZS CISPR 22: 2009 + A1: 2010 Class A (TI-IG30, TI-IG60)
CISPR 22: 2008 Class A (TI-IG30, TI-IG60)
EN 55024: 2010 (TI-IG30, TI-IG60)
EN 55032: 2015 (TI-IG90)
EN 55024: 2010/A1 : 2015 (TI-IG90)
CISPR 32:2015 (TI-IG90)

This product is herewith confirmed to comply with the Directives.

Directives: Electromagnetic Compatibility Regulations 2016
Electrical Equipment (Safety) Regulations 2016
The Restriction of the Use of Certain Hazardous Substances in Electrical and Electronic Equipment Regulations 2012
The REACH Enforcement Regulations 2008 (as amended)
The Waste Electrical and Electronic Equipment Regulations 2013 (as amended)

Person responsible for this declaration.
Place of Issue: Torrance, California, USA
Date: June 14, 2021
Name: Sonny Su
Title: VP of Technology

Signature: _____

A handwritten signature in black ink, appearing to read 'Sonny Su', written over a horizontal line.



TRENDnet[®]

Certifications

This device complies with Part 15 of the FCC Rules. Operation is subject to the following two conditions:
(1) This device may not cause harmful interference.
(2) This device must accept any interference received. Including interference that may cause undesired operation.



Waste electrical and electronic products must not be disposed of with household waste. Please recycle where facilities exist. Check with your Local Authority or Retailer for recycling advice.

- This equipment has been tested and found to comply with the limits for a Class A digital device, pursuant to part 15 of the FCC Rules. These limits are designed to provide reasonable protection against harmful interference when the equipment is operated in a commercial environment. This equipment generates, uses, and can radiate radio frequency energy and, if not installed and used in accordance with the instruction manual, may cause harmful interference to radio communications. Operation of this equipment in a residential area is likely to cause harmful interference in which case the user will be required to correct the interference at his own expense.
- FCC Caution: Any changes or modification not expressly approved by the party responsible for compliance could void the user's authority to operate this equipment.

Technical Support

If you have any questions regarding the product installation, please contact our Technical Support.
Toll free US/Canada: **1-855-373-4741**
Regional phone numbers available at www.trendnet.com/support

TRENDnet

20675 Manhattan Place
Torrance, CA 90501
USA

Applies to PoE Products Only: This product is to be connected only to PoE networks without routing to the outside plant.

Note

The Manufacturer is not responsible for any radio or TV interference caused by unauthorized modifications to this equipment. Such modifications could void the user's authority to operate the equipment.

Advertencia

En todos nuestros equipos se mencionan claramente las características del adaptador de alimentación necesario para su funcionamiento. El uso de un adaptador distinto al mencionado puede producir daños físicos y/o daños al equipo conectado. El adaptador de alimentación debe operar con voltaje y frecuencia de la energía eléctrica domiciliar existente en el país o zona de instalación.

Power supply connected caution

The equipment power supply cord shall be connected to a socket-outlet with earthing connection.

Advertencia

Le cordon d'alimentation de l'appareil doit être raccordé à une prise de courant avec mise à la terre.

If the Optical Transceiver doesn't ship with the unit, the user manual shall have description as below or equivalent: "This product is intended to be used with a UL Listed Optical Transceiver product, Rated DC3.3V, Laser Class I."

Wall-mounted instructions

The Unit has two wall-mount slots on its bottom panel. Before you begin, make sure you have two screws that indicate a diameter measurement of 0.265748 inches (6.75mm).

- (1) Determine where you want to mount the modem.
- (2) Maneuver the modem so the wall-mount slots line up with the two screws.
- (3) Place the wall-mount slots over the screws and slide the modem down until the screws fit snugly into the wall-mount slots.
- (4) Screw type P3.5 x 16mm x 2

Product Warranty Registration

Please take a moment to register your product online. Go to TRENDnet's website at: www.trendnet.com/register