

# TRENDnet®

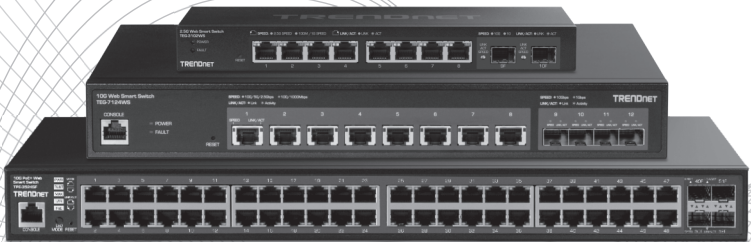

## Quick Installation Guide

---

### Non-PoE Multi-Gig Web Smart Switch Series

# Table of Contents

---

## **1 English**

1. Before You Start
2. Quick Reference
3. Hardware Installation and Configuration

<https://www.trendnet.com/qig/1010>



## 1. Before You Start

### Package Contents

- Quick Installation Guide
- Power cord (1.8m / 6 ft.) (TEG-3524S, TEG-7124WS)
- Console Cable (1m / 3.28ft.) (TEG-3524S, TEG-7124WS)
- Power adapter (12V DC, 1.5A) (TEG-3102WS)

### Minimum Requirements

- Computer with an Ethernet port and web browser
- Network cable

### Optional Equipment

- EIA standard 19" rack
- SFP modules (e.g. TE100-MGBFX, TEG-MGBSX, TEG-MGBS10, TEG-MGBS40, TEG-MGBS80, TEG-MGBS10D3, TEG-MGBS10D5, TEG-MGBS40D3, TEG-MGBS40D5)

## 2. Quick Reference

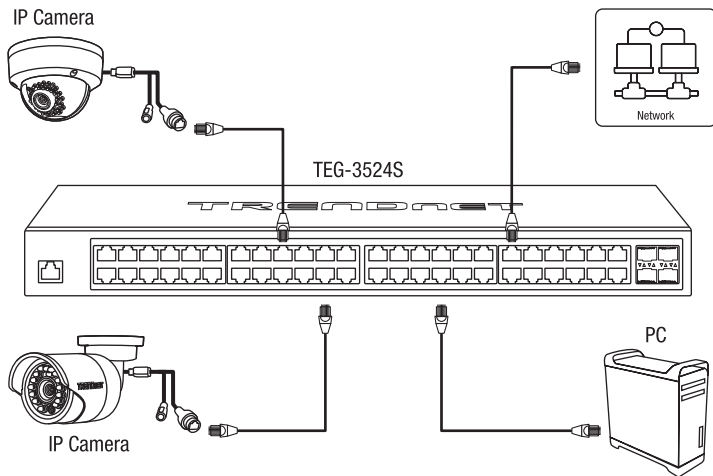

**Note:** The switch may be different than the one shown in the examples.

### 3. Hardware Installation and Configuration

1

Power



TEG-3524S

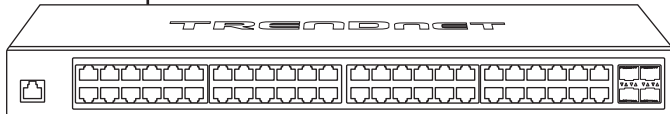

2

PC



3. Assign a Static IP address to your computer's network adapter in the subnet of 192.168.10.x (e.g. 192.168.10.25) and a subnet mask of 255.255.255.0.
4. Open your web browser, type the IP address of the switch in the address bar, and then press **Enter**. The default IP address is 192.168.10.200.

http://192.168.10.200



http://192.168.10.200

5. Enter the **User name** and **Password**, and then click **Login**. By default:

User Name: **admin**

Password: **admin**

**Note:** User Name and Password are case sensitive.

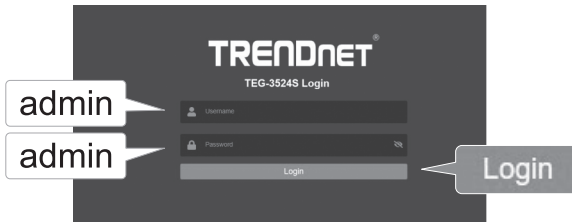

6. Click **System** and then click **IP Settings**.

7. Configure the switch to match the requirements of your network. Then click **Apply**.



**Note:** To download the latest version of the user's guide and the utility, please go to <https://www.trendnet.com/support> and select the **Switch Model** from the products drop down list.

# Declaration of Conformity

TRENDNET®

## Manufacturer's Name and Address

TRENDnet, Inc.  
20675 Manhattan Place  
Torrance, CA 90501 USA  
  
Zwolsestraat 156 2587 WB  
The Hague The Netherlands



## Product Information:

**Model Number:** TEG-3524S  
**Product Name:** 52-Port Gigabit Web Smart Switch with 10G SFP+ slots  
**Trade Name:** TRENDnet

TRENDnet hereby declare that the product is in compliance with the essential requirements and other relevant provisions under our sole responsibility.

**Safety** EN 62368-1:2014/A11:2017  
**EMC** EN 55032: 2015 + A11: 2020:CLASS A  
EN 55035: 2015 + A11: 2020  
EN IEC 61000-3-2:2019  
EN 61000-3-3:2013/A1:2019

This product is herewith confirmed to comply with the Directives.

**Directives** EMC Directive 2014/30/EC  
RoHS Directive 2011/65/EU  
WEEE Directive 2012/19/EU  
REACH Regulation (EC) No. 1907/2006  
Low Voltage Directive 2014/35/EC  
Ecodesign Directive 2009/125/EC

Person responsible for this declaration.

Place of Issue: Torrance, California, USA

Date: December 01, 2022

Name: Sonny Su

Title: Director of Technology

Signature:

A handwritten signature in black ink, appearing to read 'Sonny Su', is written over a horizontal line.



# Declaration of Conformity

TRENDNET®

## Manufacturer's Name and Address

TRENDnet, Inc.                      Authorized Representative:  
20675 Manhattan Place        Office: +44 (0) 1635 887 399  
Torrance, CA 90501 USA        Unit 4 Rivermead Business Park,  
   Pipers Way, Thatcham, RG19 4EP  
   England



## Product Information:

**Model Number:**    TEG-3524S  
**Product Name:**    52-Port Gigabit Web Smart Switch with 10G SFP+ slots  
**Trade Name:**        TRENDnet

TRENDnet hereby declare that the product is in compliance with the essential requirements and other relevant provisions under our sole responsibility.

**Safety**                      EN 62368-1:2014/A11:2017  
**EMC**                        BS EN 55032: 2015 + A11: 2020:CLASS A  
                                      BS EN 55035: 2015 + A11: 2020  
                                      BS EN IEC 61000-3-2:2019  
                                      BS EN 61000-3-3:2013/A1:2019

This product is herewith confirmed to comply with the Directives.

**Directives**                Electromagnetic Compatibility Regulations 2016  
                                      The Restriction of the Use of Certain Hazardous Substances in Electrical and  
                                      Electronic Equipment Regulations 2012  
                                      The Waste Electrical and Electronic Equipment Regulations 2013 (as amended)  
                                      The REACH Enforcement Regulations 2008 (as amended)  
                                      Electrical Equipment (Safety) Regulations 2016  
                                      The Ecodesign for Energy-Related Products and Energy Information (Amendment)  
                                      (EU Exit) Regulations 2019

Person responsible for this declaration.  
Place of Issue: Torrance, California, USA  
Date: December 01, 2022  
Name: Sonny Su  
Title: Director of Technology

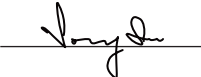
Signature: 



## UL Warning

- 1) Elevated Operating Ambient Temperature - If installed in a closed or multi-unit rack assembly, the operating ambient temperature of the rack environment may be greater than room ambient. Therefore, consideration should be given to installing the equipment in an environment compatible with the manufacturer's maximum rated ambient temperature (T<sub>ma</sub>).
- 2) Reduced Air Flow - Installation of the equipment in a rack should be such that the amount of air flow required for safe operation of the equipment is not compromised.
- 3) Mechanical Loading - Mounting of the equipment in the rack should be such that a hazardous condition is not achieved due to uneven mechanical loading.
- 4) Circuit Overloading - Consideration should be given to the connection of the equipment to the supply circuit and the effect that overloading of circuits might have on over current protection and supply wiring. Appropriate consideration of equipment nameplate ratings should be used when addressing this concern.
- 5) Reliable Earthing - Reliable earthing of rack-mounted equipment should be maintained. Particular attention should be given to supply connections other than direct connections to the branch circuit (e.g., use of power strips).

## Rack Installation

The Switch can be mounted in an EIA standard, 19-inch rack, which can be placed in a wiring closet with other equipment. To install, attach the mounting brackets on the switch's front panel (one on each side) and secure them with the screws provided.

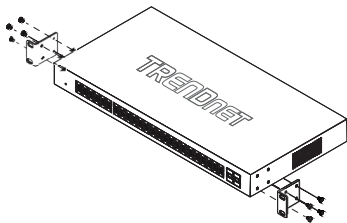

Attaching the mounting brackets to the Switch

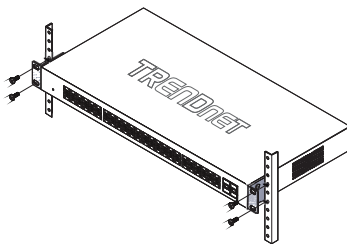

Installing the Switch in an equipment rack



# TRENDNET<sup>®</sup>

## Certifications

This device complies with Part 15 of the FCC Rules.

Operation is subject to the following two conditions:

- (1) This device may not cause harmful interference.
- (2) This device must accept any interference received.

Including interference that may cause undesired operation.



Waste electrical and electronic products must not be disposed of with household waste. Please recycle where facilities exist. Check with your Local Authority or Retailer for recycling advice.

## Fiber product warning note:

If the Optical Transceiver doesn't ship with the unit, the user manual shall have the description as below or equivalent:

"This product is intended to be used with a UL Listed Optical Transceiver product, Rated DC3.3V, Laser Class I."

## Laser warning note:

This product is intended to be used with a UL Listed Optical Transceiver product, Rated DC3.3V, Laser Class I.

## Technical Support

If you have any questions regarding the product installation, please contact our Technical Support.

Toll free US/Canada: **1-855-373-4741**

Regional phone numbers available at [www.trendnet.com/support](http://www.trendnet.com/support)

## TRENDnet

20675 Manhattan Place  
Torrance, CA 90501  
USA

Applies to PoE Products Only: This product is to be connected only to PoE networks without routing to the outside plant.

## Note

The Manufacturer is not responsible for any radio or TV interference caused by unauthorized modifications to this equipment. Such modifications could void the user's authority to operate the equipment.

## Advertencia

En todos nuestros equipos se mencionan claramente las características del adaptador de alimentación necesario para su funcionamiento. El uso de un adaptador distinto al mencionado puede producir daños físicos y/o daños al equipo conectado. El adaptador de alimentación debe operar con voltaje y frecuencia de la energía eléctrica domiciliar existente en el país o zona de instalación.

## Product Warranty Registration

Please take a moment to register your product online. Go to TRENDnet's website at: [www.trendnet.com/register](http://www.trendnet.com/register)