

## IP PoE Surface Mount Analog Clocks VIP-A12A, 12" Round VIP-A16A, 16" Round

### INTRODUCTION

The VIP-A12A 12 inch Round Analog and VIP-A16A 16 inch Round Analog Clocks enable time indication, synchronization, and correction over an IP-based LAN/WAN. This allows locating a clock display anywhere on the network. Clock synchronization can be programmed to sync with any NTP (Network Time Protocol) server. The enclosure is made of steel with a durable powder coated finish. The color of the enclosure can easily be changed to match any décor. Power is provided to the VIP-A12A and VIP-A16A via a Power over Ethernet (PoE) switch meeting the 802.3af specification.







### SPECIFICATIONS

#### Features

- RJ-45 network connection
- Low-profile/semi-flush smooth surface metal case
- Shatterproof, polycarbonate crystal
- 802.3af compatible
- High Efficiency

#### Precautionary Designations

	<b>CAUTION</b> RISK OF ELECTRIC SHOCK DO NOT OPEN	
CAUTION: To reduce the risk of electric shock, Do not remove cover. No user serviceable parts inside. Refer servicing to qualified service personnel.		
	This symbol indicates that dangerous voltage constituting a risk of electric shock is present within this unit.	
	This symbol indicates that there are important operating and maintenance instructions in the literature accompanying this unit.	

#### DIMENSIONS/WEIGHT

- VIP-A12A – 12.81" diameter x 1.20" depth  
Weight: 3.70 LBS
- VIP-A16A – 16.81" diameter x 1.60" depth  
Weight: 5.35 LBS

#### Nominal Power Requirements

4.5W via 802.3af PoE

#### Environment

Temperature: 0 to +45° C  
Humidity: 0 to 85% non-precipitating

### INSTALLATION

#### FCC Information

This equipment has been tested and found to comply with the limits for a Class A digital device, pursuant to Part 15 of the FCC Rules. These limits are designed to provide reasonable protection against harmful interference when the equipment is operated in a commercial environment. This equipment generates, uses and can radiate radio frequency energy and if not installed and used in accordance with the instruction manual, may cause harmful interference to radio communications. Operation of this equipment in a residential area may cause harmful interference in which case the user will be required to correct the interference at one's own expense.

### IMPORTANT SAFETY INFORMATION

#### CONSIGNES DE SÉCURITÉ IMPORTANTES

1. Read these instructions.  
*Lisez ces instructions.*
2. Keep these instructions.  
*Conservez ces instructions.*
3. Heed all warnings.  
*Respectez tous les avertissements.*
4. Follow all instructions.  
*Suivez toutes les instructions.*
5. Do not use this apparatus near water.  
*Ne pas utiliser cet appareil près de l'eau.*
6. Clean only with dry cloth.  
*Nettoyer avec un chiffon sec.*
7. Do not block any ventilation openings. Install in accordance with the manufacturer's instructions.  
*Ne pas bloquer les ouvertures de ventilation. Installer conformément aux instructions du fabricant.*
8. Do not install near any heat sources such as radiators, heat registers, stoves or other apparatus (including amplifiers) that produce heat.  
*Ne pas installer à proximité de sources de chaleur telles que radiateurs, registres de chaleur, poêles ou autres appareils (y compris les amplificateurs) produisant de la chaleur.*
9. Do not defeat the safety purpose of the polarized or grounding-type plug. A polarized plug has two blades with one wider than the other. A grounding type plug has two blades and a third grounding prong. The wide blade and the third prong are provided for your safety. If the provided plug does not fit into your outlet consult an electrician for replacement of the obsolete outlet.  
*Ne pas contourner le dispositif de sécurité de la fiche polarisée ou de mise à la terre. Une fiche polarisée possède deux lames dont une plus large que l'autre. Une fiche de terre a deux lames et une troisième broche de mise à la terre. La lame large et la troisième broche sont fournies pour votre sécurité. Si la fiche fournie ne rentre pas dans votre prise, veuillez consulter un électricien pour le remplacement de la prise obsolète.*
10. Protect the power cord from being walked on or pinched particularly at plugs, convenience receptacles and the point where they exit from the apparatus.
11. Only use attachments/accessories specified by the manufacturer.  
*N'utilisez que des fixations / accessoires spécifiés par le fabricant.*
12. Use only with the cart, stand, tripod, bracket or table specified by the manufacturer or sold with the apparatus. When a cart is used, use caution when moving the cart/apparatus combination to avoid injury from tip-over.  
  
*Utilisez uniquement avec le chariot, stand, trépied, support ou table spécifié par le fabricant ou vendu avec l'appareil. Quand un chariot est utilisé, Soyez prudent lorsque vous déplacez l'ensemble chariot / appareil pour éviter des blessures dues au renversement.*
13. Unplug this apparatus during lightning storms or when unused for a long period of time.  
*Débranchez cet appareil pendant les orages ou lorsqu'il n'est pas utilisé pendant une longue période de temps.*
14. Refer all servicing to qualified service personnel. Servicing is required when the apparatus has been damaged in any way. Such as when the power supply cord or plug is damaged, liquid has been spilled, objects have fallen into the apparatus or the apparatus has been exposed to rain or moisture and does not operate normally or has been dropped.  
*Confiez toute réparation à un personnel qualifié. Une réparation est nécessaire lorsque l'appareil a été endommagé de quelque façon. Par exemple lorsque le cordon d'alimentation ou la fiche est endommagé, du liquide a été renversé, si des objets sont tombés dans l'appareil ou le appareil a été exposé à la pluie ou à l'humidité et ne fonctionne pas normalement ou s'il est tombé.*

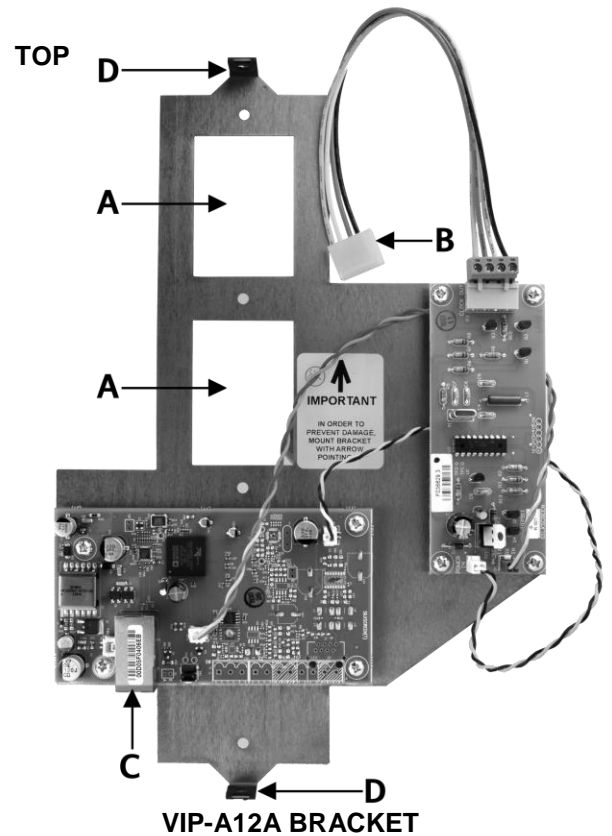

VIP-A12A BRACKET

## MOUNTING/CONNECTIONS

(A) Attach the supplied mounting bracket to a wall or a standard single-gang electrical box using appropriate hardware such as #8 pan head screws (not supplied). Mount in same orientation as shown.

(B) Attach the 5-pin female molex connector to the male molex connector on the back of the clock.

(C) Connect a standard Ethernet patch cable from an Ethernet switch into the RJ45 connector on the VIP-A12A or VIP-A16A. If PoE is not available, a PoE mid-span injector may be used to power the clocks.

(D) Place the enclosure of the clock on the outside of the upper and lower posts on the mounting bracket. Insert screws (supplied) to hold clock securely to bracket.

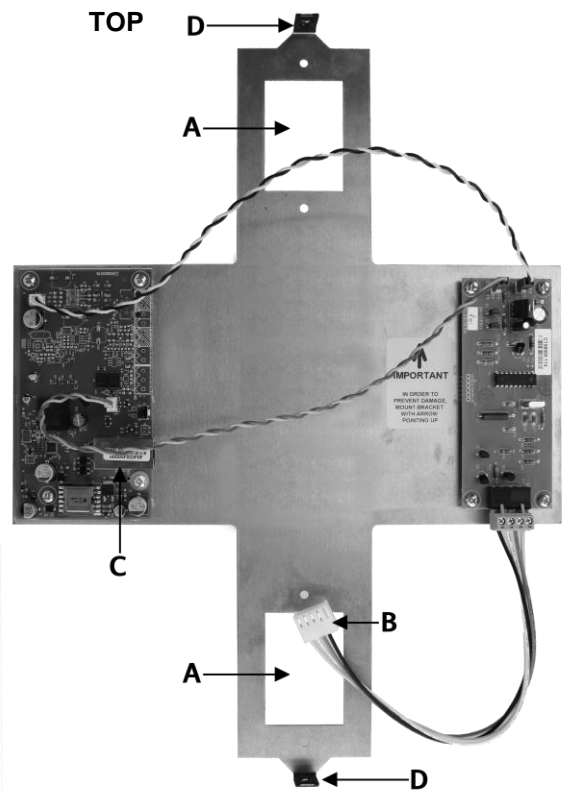

VIP-A16A BRACKET

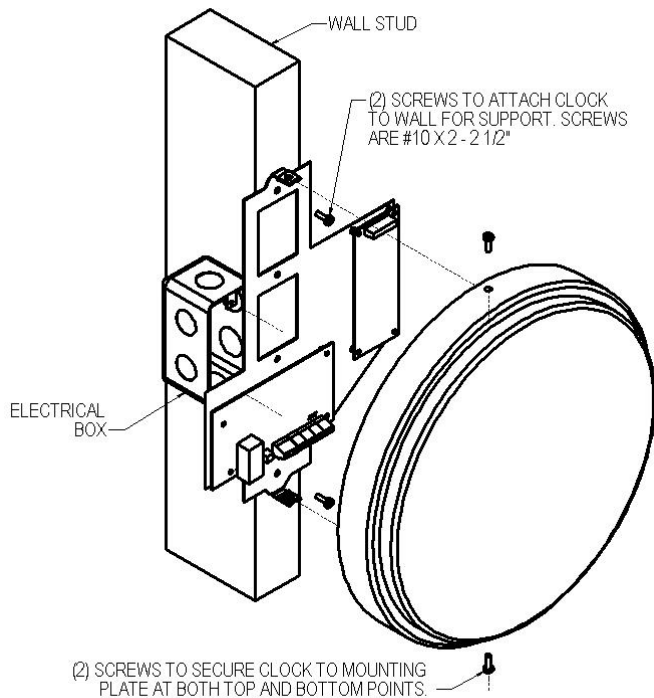

## Setup

Valcom IP Clocks (beginning with firmware version 3.17.4) are programmed at the factory to acquire an IP address using Dynamic Host Configuration Protocol (DHCP). If DHCP is not available, the clock will revert to the static IP address of 192.168.6.207 after 3 minutes.

In addition to the IP address, the clock will also try to acquire all of the information needed to synchronize time from the DHCP Scope. If the DHCP Scope Options noted below are correctly configured, the clock will be able to acquire the correct time without further programming.

- Option 42, NTP Server IP Address.
- Option 100, POSIX Time Zone, example: "EST5EDT4,M3.2.0/02:00,M11.1.0/2:00". This is the preferred option, and works for any area of the world.
- Option 101, Time Zone Name, example: "America/New\_York". This option is only supported for North America time zones.

Each of these options from the DHCP scope can be overridden by manually programming the desired value using the Valcom VIP-102B IP Solutions Setup Tool. If not using DHCP for IP address assignment, all of the Time settings will be configured using the Setup Tool. Download the latest version of the free IP Solutions Setup Tool from the Valcom web site at [www.valcom.com/vipsetuptool](http://www.valcom.com/vipsetuptool)

## TECHNICAL ASSISTANCE

When trouble is reported, verify power is being supplied to the unit and there are no broken connections. If a spare unit is available, substitute a spare unit for the suspected defective unit.

Assistance in troubleshooting is available from the factory. Call (540) 563-2000 and press 1 for Technical Support or via email at [support@valcom.com](mailto:support@valcom.com)

When requesting assistance, you should include all available information. It is strongly suggested that you go to the web site and review the documentation at: <http://www.valcom.com>

Valcom equipment is not field-repairable. Valcom, Inc. maintains service facilities in Roanoke, VA. Should repairs be necessary, attach a tag to the unit clearly stating your company name, address, phone number, contact person and the nature of the problem. Send the unit to:

**Valcom, Inc.**  
**Repair & Return Dept.**  
**5614 Hollins Road**  
**Roanoke, Va. 24019-5056**

## WARRANTY

Warranty information may be found on our website at [www.valcom.com/warranty](http://www.valcom.com/warranty).