

NEC

Desktop Monitor

MultiSync PA243W

User's Manual

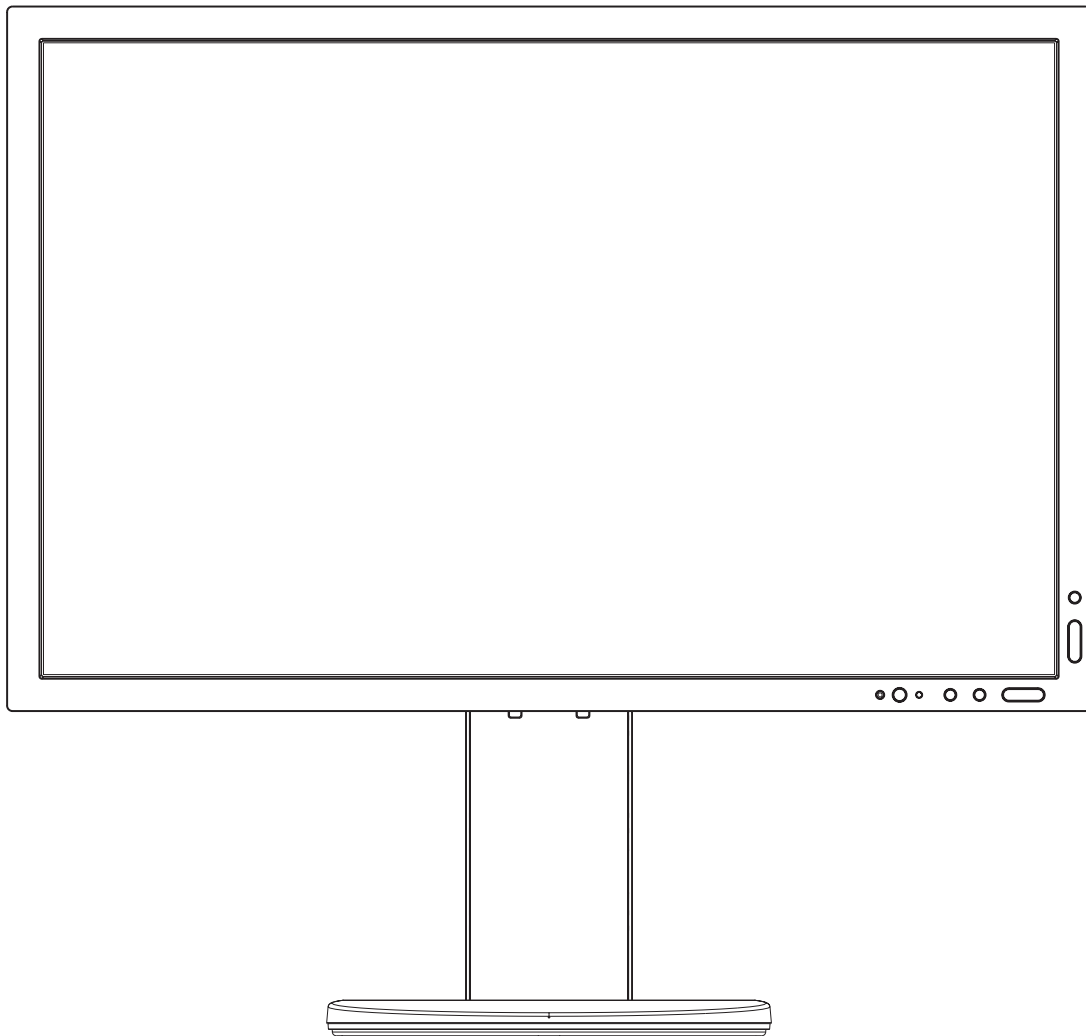

MODEL: PA243W, PA243W-BK

The regulations for this monitor applied to one of model names listed above.

Please find your model name in the label on the rear side of the monitor.

Index

WARNING	English-1
CAUTION	English-1
Registration Information	English-2
Recommended use	English-3
Safety Precautions and Maintenance	English-3
Ergonomics	English-4
Cleaning the LCD Panel.....	English-4
Cleaning the Cabinet.....	English-4
Product Features.....	English-5
Quick Start.....	English-5
Controls	English-11
Using the PICTURE MODE function	English-17
Advanced OSD.....	English-18
Specifications	English-26
Features	English-27
Troubleshooting.....	English-28
Using the Auto Brightness function	English-30
Manufacturer's Recycling and Energy Information.....	English-31

The model name is on the label.

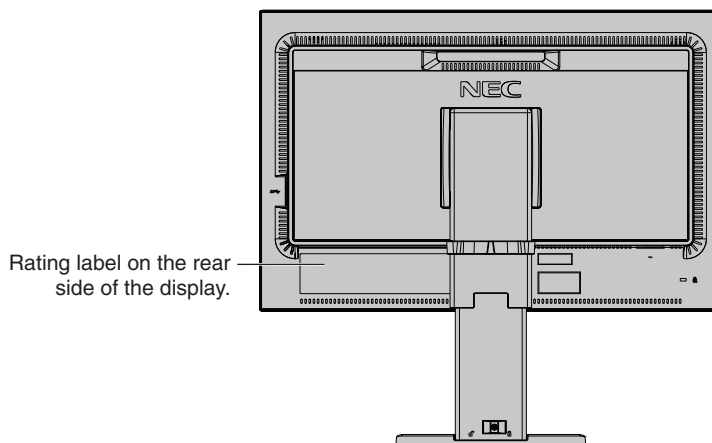

	WARNING	
<p>TO PREVENT FIRE OR SHOCK HAZARDS, DO NOT EXPOSE THIS UNIT TO RAIN OR MOISTURE. ALSO, DO NOT USE THIS UNIT'S POLARIZED PLUG WITH AN EXTENSION CORD RECEPTACLE OR OTHER OUTLETS UNLESS THE PRONGS CAN BE FULLY INSERTED.</p> <p>REFRAIN FROM OPENING THE CABINET AS THERE ARE HIGH VOLTAGE COMPONENTS INSIDE. REFER SERVICING TO QUALIFIED SERVICE PERSONNEL.</p>		

	CAUTION	
<p>TO REDUCE THE RISK OF ELECTRIC SHOCK, MAKE SURE POWER CORD IS UNPLUGGED FROM WALL SOCKET. TO FULLY DISENGAGE THE POWER TO THE UNIT, PLEASE DISCONNECT THE POWER CORD FROM THE AC OUTLET. DO NOT REMOVE COVER (OR BACK). NO USER SERVICEABLE PARTS INSIDE. REFER SERVICING TO QUALIFIED SERVICE PERSONNEL.</p>		



This symbol warns user that uninsulated voltage within the unit may have sufficient magnitude to cause electric shock. Therefore, it is dangerous to make any kind of contact with any part inside this unit.



This symbol alerts the user that important literature concerning the operation and maintenance of this unit has been included. Therefore, it should be read carefully in order to avoid any problems.

CAUTION: Please use the power cord provided with this display in accordance with the table below. If a power cord is not supplied with this equipment, please contact NEC. For all other cases, please use the power cord with the plug style that matches the power socket where the monitor is located. The compatible power cord corresponds to the AC voltage of the power outlet and has been approved by, and complies with, the safety standards in the country of purchase.

This equipment is designed to be used in the condition of the power cord connected to earth. If the power cord is not connected to the earth, it may cause electric shock. Please make sure the power cord is earthed properly.

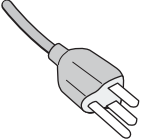
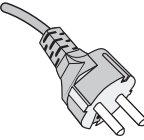
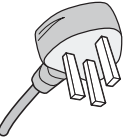
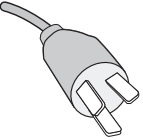
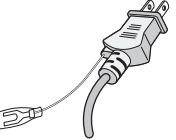
Plug Type	North America	European Continental	U.K.	Chinese	Japanese
Plug Shape					
Country	U.S.A./Canada	EU (except U.K.)	U.K.	China	Japan
Voltage	120*	230	230	220	100

*When operating the monitor with its AC 125-240V power supply, use a power supply cord that matches the power supply voltage of the AC power outlet being used.

NOTE: This product can only be serviced in the country where it was purchased.

Windows is a registered trademark of Microsoft Corporation.

NEC is a registered trademark of NEC Corporation.

ErgoDesign is a registered trademark of NEC Display Solutions, Ltd. in Austria, Benelux, Denmark, France, Germany, Italy, Norway, Spain, Sweden, U.K.

All other brands and product names are trademarks or registered trademarks of their respective owners.

DisplayPort and DisplayPort Compliance Logo are trademarks owned by Video Electronics Standards Association in the United States and other countries.



The terms HDMI and HDMI High-Definition Multimedia Interface, and the HDMI Logo are trademarks or registered trademarks of HDMI Licensing Administrator, Inc. in the United States and other countries.

- The intended primary use of this product is as an Information Technical Equipment in an office or domestic environment.
- The product is intended to be connected to a computer and is not intended for the display of television broadcast signals.



Registration Information

Cable information

- ⚠ CAUTION:** Use the attached specified cables with this monitor so as not to interfere with radio and television reception. For DVI and mini D-Sub 15-pin, please use a signal cable with ferrite core. For HDMI, DisplayPort, USB and AUDIO, please use a shielded signal cable. Use of other cables and adapters may cause interference with radio and television reception.

FCC Information

1. The power supply cord you use must have been approved by and comply with the safety standards of U.S.A., and meet the following condition.

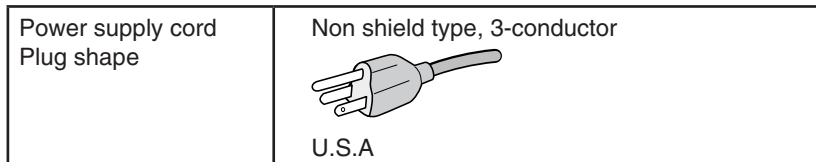

2. This equipment has been tested and found to comply with the limits for a Class B digital device, pursuant to part 15 of the FCC Rules. These limits are designed to provide reasonable protection against harmful interference in a residential installation. This equipment generates, uses, and can radiate radio frequency energy, and, if not installed and used in accordance with the instructions, may cause harmful interference to radio communications. However, there is no guarantee that interference will not occur in a particular installation. If this equipment does cause harmful interference to radio or television reception, which can be determined by turning the equipment off and on, the user is encouraged to try to correct the interference by one or more of the following measures:
- Reorient or relocate the receiving antenna.
 - Increase the separation between the equipment and receiver.
 - Connect the equipment into an outlet on a circuit different from that to which the receiver is connected.
 - Consult your dealer or an experienced radio/TV technician for help.

If necessary, the user should contact the dealer or an experienced radio/television technician for additional suggestions. The user may find the following booklet, prepared by the Federal Communications Commission, helpful: "How to Identify and Resolve Radio-TV Interference Problems." This booklet is available from the U.S. Government Printing Office, Washington, D.C., 20402, Stock No. 004-000-00345-4.

Declaration of Conformity

This device complies with Part 15 of FCC Rules. Operation is subject to the following two conditions. (1) This device may not cause harmful interference, and (2) this device must accept any interference received, including interference that may cause undesired operation.

U.S. Responsible Party:	NEC Display Solutions of America, Inc.
Address:	500 Park Boulevard, Suite 1100
	Itasca, Illinois 60143
Tel. No.:	(630) 467-3000

Type of Product: Display Monitor
Equipment Classification: Class B Peripheral
Model: MultiSync PA243W (PA243W, PA243W-BK)



We hereby declare that the equipment specified above conforms to the technical standards as specified in the FCC Rules.

To see a list of our TCO certified monitors and their TCO Certification (in English only), visit our website at https://www.nec-display.com/global/about/legal_regulation/TCO_mn/index.html

Recommended use

Safety Precautions and Maintenance



WARNING

FOR OPTIMUM PERFORMANCE, PLEASE NOTE
THE FOLLOWING WHEN SETTING UP AND
USING THE LCD COLOR MONITOR:

- **DO NOT OPEN THE MONITOR.** There are no user serviceable parts inside and opening or removing covers may expose you to dangerous shock hazards or other risks. Refer all servicing to qualified service personnel.
- Do not spill any liquids into the cabinet or use your monitor near water.
- Do not insert objects of any kind into the cabinet slots, as they may touch dangerous voltage points, which can be harmful or fatal or may cause electric shock, fire or equipment failure.
- Do not place any heavy objects on the power cord. Damage to the cord may cause shock or fire.
- Do not place this product on a sloping or unstable cart, stand or table, as the monitor may fall, causing serious damage to the monitor.
- The power supply cord you use must have been approved by and comply with the safety standards of your country. (e.g. Type H05VV-F 3G 0.75 mm² should be used in Europe).
- In UK, use a BS-approved power cord with molded plug having a black (10 A) fuse installed for use with this monitor.
- Do not place any objects onto the monitor and do not use the monitor outdoors.
- Do not bend, crimp or otherwise damage the power cord.
- Do not use the monitor in high temperature, humid, dusty, or oily areas.
- Do not cover vent on monitor.
- Vibration can damage the backlight. Do not install in areas where the monitor will be exposed to continual vibration.
- If monitor or glass is broken, do not come in contact with the liquid crystal and handle with care.
- To prevent damage to the LCD monitor caused by tipping over due to earthquakes or other shocks, make sure to install the monitor in a stable location and take measures to prevent falling.
- Immediately turn off the power, unplug your monitor from the wall outlet and move to a safe location then refer servicing to qualified service personnel under the following conditions. If the monitor is used in this condition, the monitor may cause fall, fire and electric shock:
 - If the monitor stand has been cracked or peeled.
 - If you notice any structural damage such as cracks or unnatural wobbling.
 - If the monitor has an unusual odor.
 - If the power supply cord or plug is damaged.
 - If liquid has spilled or objects have fallen into the monitor.
 - If the monitor has been exposed to rain or water.
 - If the monitor has been dropped or the cabinet has been damaged.
 - If the monitor does not operate normally by following operating instructions.



CAUTION

- Allow adequate ventilation around the monitor so that heat can properly dissipate. Do not block ventilated openings or place the monitor near a radiator or other heat sources.
- Do not put anything on top of monitor.
- The power cable connector is the primary means of detaching the system from the power supply. The monitor should be installed close to a power outlet, which is easily accessible.
- Handle with care when transporting. Save packaging for transporting.
- Handle with care during installation and adjustment to prevent personal injury and damage to the monitor.
- Do not connect headphones to the monitor while you are wearing them. Depending on the volume level, it may damage your ears and cause loss of hearing.
- Please tighten all screws. A loose screw may cause the monitor to fall off the arm or stand.
- Do not touch the LCD panel surface while transporting, mounting and setting. Applying pressure on the LCD panel can cause serious damage.

Image Persistence: Image persistence occurs when a residual or “ghost” image of a previous image remains visible on the screen. Unlike CRT monitors, LCD monitors’ image persistence is not permanent, but a still image being displayed for a long period of time should be avoided.

To alleviate image persistence, turn off the monitor for as long as the previous image was displayed. For example, if an image was on the monitor for one hour and a residual image remains, the monitor should be turned off for one hour to erase the image.

NOTE: As with all personal display devices, NEC DISPLAY SOLUTIONS recommends using a moving screen saver at regular intervals whenever the screen is idle, or turn off the monitor when not in use.

**CORRECT PLACEMENT AND ADJUSTMENT OF THE MONITOR CAN
REDUCE EYE, SHOULDER AND NECK FATIGUE. CHECK THE
FOLLOWING WHEN YOU POSITION THE MONITOR:**

Ergonomics

To realize the maximum ergonomics benefits, we recommend the following:

- For optimum performance of the monitor, allow 20 minutes for warming up. Avoid reproduction of still patterns on the monitor for long periods of time to avoid image persistence (after image effects).
- Adjust the monitor height so that the top of the screen is at or slightly below eye level. Your eyes should look slightly downward when viewing the middle of the screen.
- Position your monitor no closer than 40 cm (15.75 inches) and no further away than 70 cm (27.56 inches) from your eyes. The optimal distance is 50 cm (19.69 inches).
- Rest your eyes periodically for 5 to 10 minutes for every 1 hour by focusing on an object at least 20 feet away.
- Position the monitor at a 90° angle to windows and other light sources to minimize glare and reflections. Adjust the monitor tilt so that ceiling lights do not reflect on your screen.
- If reflected light makes it hard for you to see your screen, use an anti-glare filter.
- Adjust the monitor's brightness and contrast controls to enhance readability.
- Use a document holder placed close to the screen.
- Position whatever you are looking at most of the time (the screen or reference material) directly in front of you to minimize turning your head while you are typing.
- Blink often. Eye exercise helps to reduce eye strain. Please contact your ophthalmologist. Get regular eye checkups.
- To avoid eye fatigue, adjust the brightness to a moderate setting. Place a sheet of white paper next to the LCD screen for luminance reference.
- Do not position the Contrast control to its maximum setting.
- Use the preset Size and Position controls with standard signals.
- Use the preset Color Setting.
- Use non-interlaced signals.
- Do not use primary color blue on a dark background, as it is difficult to see and may produce eye fatigue due to insufficient contrast.
- Suitable for entertainment purposes at controlled luminous environments, to avoid disturbing reflections from the screen.

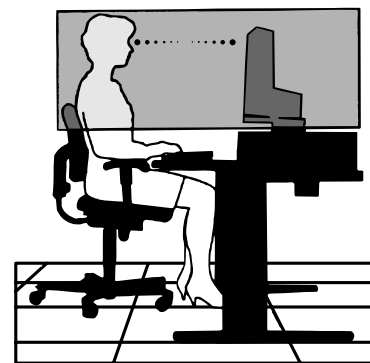

Cleaning the LCD Panel

- When the LCD is dusty, please gently wipe with a soft cloth.
- Clean the LCD monitor surface with a lint-free, non-abrasive cloth. Avoid using any cleaning solution or glass cleaner!
- Please do not rub the LCD panel with hard or coarse material.
- Please do not apply pressure to the LCD surface.
- Please do not use OA cleaner as it will cause deterioration or discoloration on the LCD panel surface.

Cleaning the Cabinet

- Unplug the power supply
- Gently wipe the cabinet with a soft cloth
- To clean the cabinet, dampen the cloth with a neutral detergent and water, wipe the cabinet and follow with a dry cloth.

NOTE: DO NOT clean with benzene thinner, alkaline detergent, alcoholic system detergent, glass cleaner, wax, polish cleaner, soap powder, or insecticide. Rubber or vinyl should not be in contact with the cabinet for an extended period of time. These types of fluids and materials can cause the paint to deteriorate, crack or peel.

For more detailed information on setting up a healthy work environment, write to the American National Standard for Human Factors Engineering of Computer Workstations - ANSI/HFES 100-2007 - The Human Factors Society, Inc. P.O. Box 1369, Santa Monica, California 90406.

Product Features

- DisplayPort and HDMI, which support 10-bit color depth.
- 5-setting, easy-to-switch picture mode (see page 13).
- Accurate color reproduction for high-end graphic design (see page 17).
- Quick warmup time.
- Picture-in-picture/picture-by-picture dual-screen mode includes real-time preview (see page 14).
- USB hub with two upstream ports (see page 14).
- MultiProfiler extends color management feature, including automatic ICC profile updates (ICC profile Emulation, Printer Emulation) (see page 17).
- Small footprint design.

Quick Start

For box contents, please refer to the printed contents sheet provided in the box.

To connect the LCD monitor to your system, follow these instructions:

NOTE: Make sure to read “Recommended Use” (page 3) before installation.

⚠ CAUTION: The accessories included depend on the location where the LCD monitor was shipped.

1. Turn off the power for your computer.
2. **For a PC or MAC with DVI digital output:** Connect the DVI signal cable to the connector of the display card in your system (**Figure A.1**). Tighten all screws.

For a PC with Analog output: Connect a 15-pin mini D-SUB to DVI-A signal cable to the connector of the display card in your system (**Figure A.2**).

For a Mac or PC with Thunderbolt or Mini DisplayPort output: Connect a Mini DisplayPort to DisplayPort cable to the video output connector on your system (**Figure A.3**).

For a PC with DisplayPort output: Connect the DisplayPort cable to the connector of the display card in your system (**Figure A.4**).

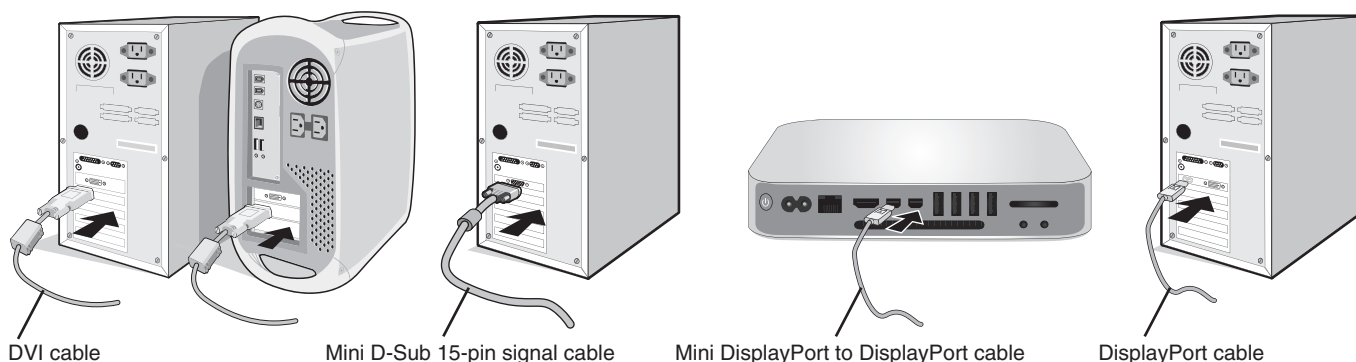

Figure A.1

Figure A.2

Figure A.3

Figure A.4

- NOTE:**
- Please use a Certified DisplayPort cable.
 - When removing the DisplayPort cable, hold down the top button to release the lock.
 - Please use a High Speed HDMI cable with the HDMI logo.

- Height adjustment is locked by a lock switch. Place a hand on top of the stand to push down the screen to the lowest position. Slide the lock switch to unlock the stand and raise the monitor screen (**Figure B.1**).

NOTE: Handle with care when unlocking the stand.

Place hands on each side of the monitor to tilt the LCD panel to a maximum tilt angle and lift up to the highest position (**Figure B.2**).

CAUTION: Cable holder cannot be removed.

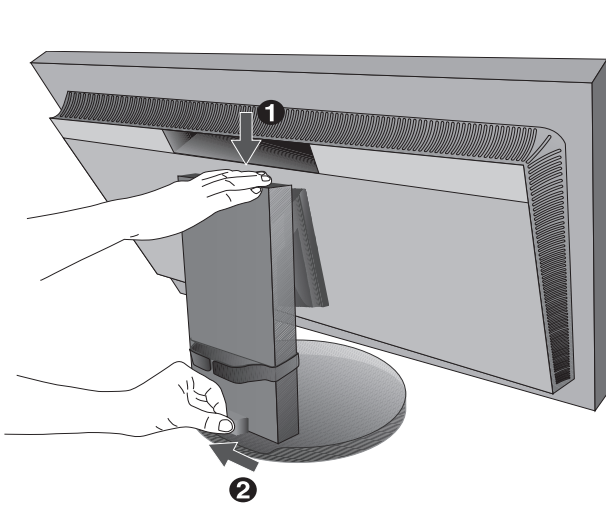

Figure B.1

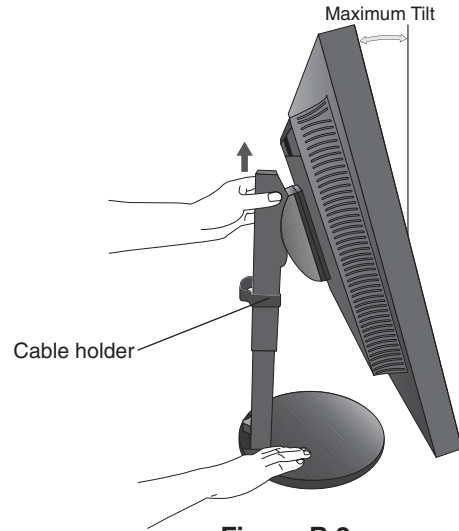

Figure B.2

- Connect all cables to the appropriate connectors (**Figure C.1**). When using a USB cable, connect the B type connector to the USB upstream port on the right rear side of the monitor and the A type connector to the downstream port on the computer (**Figure C.1a**). If using the cord from a USB device, plug into one of the downstream ports of the monitor.

CAUTION: Do not bind the USB cable. It may cause heat or fire.

NOTE: Incorrect cable connections may result in irregular operation, damage display quality/components of the LCD module and/or shorten the module's life.

NOTE: Adjustment of the volume control as well as the equalizer to other settings than the center position may increase the ear-/headphones output voltage and therefore the sound pressure level. Use an audio cable without a built-in resistor. Using an audio cable with a built-in resistor turns down the sound.

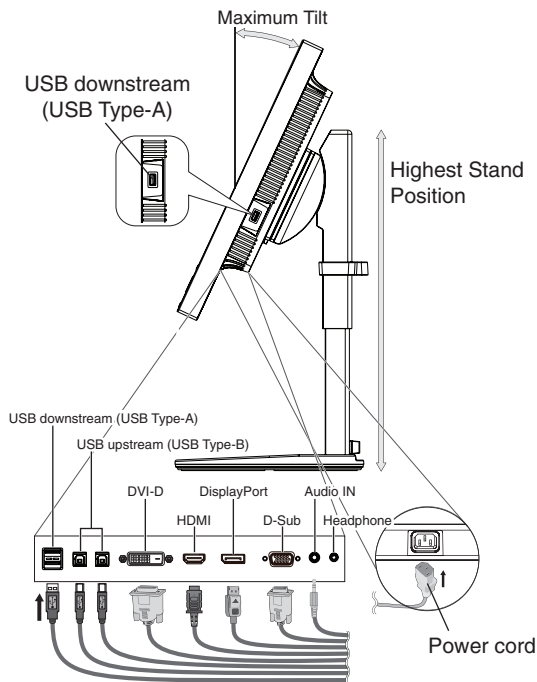

Figure C.1

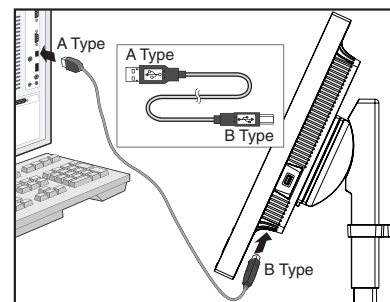

Figure C.1a

CAUTION: Do not connect headphones to the monitor while you are wearing them. Depending on the volume level, it may damage your ears and cause loss of hearing.

5. To keep the cables neatly and evenly organized, place them into the cable holder which is installed onto the stand (Figure C.2 and Figure C.3).
6. Please check that you can still rotate, raise and lower the monitor screen after you have installed the cables.

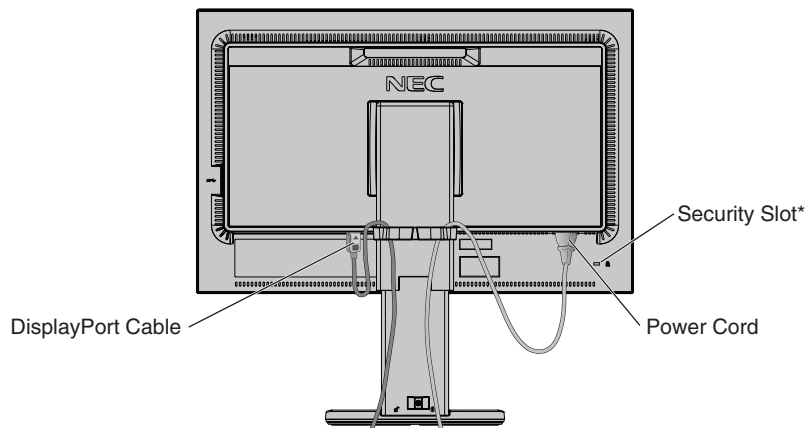

Figure C.2

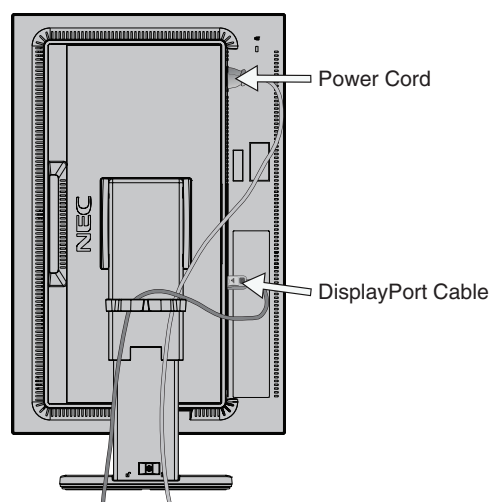

Figure C.3

7. Connect the power cord to the power outlet.

NOTE: Please refer to the **Caution** section of this manual for proper selection of the AC power cord (see page 1).

- *: Security and theft protection lock compatible with Kensington security cables/equipment.
For products, visit Kensington's website, <http://www.kensington.com/>

8. Turn on the monitor by pressing the power button and then the computer (**Figure E.1**).
9. No Touch Auto Adjust automatically adjusts the monitor to optimal settings upon initial setup. For further adjustments, use the following OSD controls:
 - AUTO CONTRAST (Analog input only)
 - AUTO ADJUST (Analog input only)

Refer to the **Controls** section of this User’s Manual for a full description of these OSD controls.

NOTE: If you have any problems please refer to the **Troubleshooting** section of this User’s Manual (see page 28).

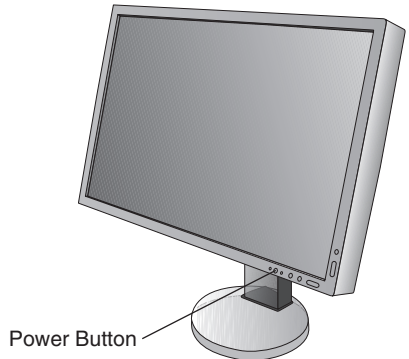

Figure E.1

Adjustable stand with pivot capability

Raise and Lower: Hold the monitor on each side and lift or lower to the desired height.

Tilt and Swivel: Hold the top and bottom sides of the monitor screen with your hands and adjust the tilt and swivel as desired.

Screen Rotation (Pivot): Hold the monitor on each side and turn it from landscape to portrait.

To rotate the OSD menu between landscape and portrait, refer to the **OSD (On-Screen-Display) Controls** section (see page 11).

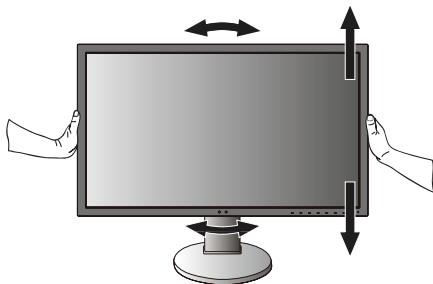

Rotation, Raise and Lower

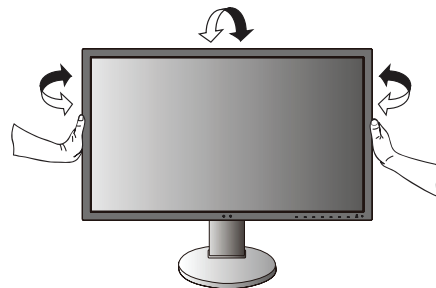

Tilt and Swivel

⚠ CAUTION: Handle with care when adjusting the monitor screen. Do not apply pressure to the LCD when adjusting the monitor screen height. Before rotating, disconnect the power cord and all cables from the display. The screen must be raised to the highest level and tilt to avoid knocking the screen on the desk or pinching your fingers.

Flexible Arm Installation

This LCD monitor is designed for use with a flexible arm. Contact NEC for more information.

To prepare the monitor for alternate mounting purposes:

- Follow the instructions provided by the manufacturer of the display mount.

⚠ CAUTION: To meet the safety requirements, the monitor must be mounted to an arm that supports the weight of the monitor. See page 26 for details. Remove the monitor stand before mounting.

1. Remove the Monitor Stand for Mounting

To prepare the monitor for alternate mounting purposes:

1. Disconnect all cables.
2. Place hands on each side of the monitor and lift up to the highest position.
3. Place the monitor face down on a non-abrasive surface (**Figure S.1**).
4. Place one hand around the base and one hand on the Quick Release Lever. Push and hold the Quick Release Lever in the direction indicated by the arrow (**Figure S.1**).
5. Lift up the stand to unhook it from the monitor (**Figure S.1**).
The monitor can now be mounted using an alternate method.
Reverse the process to reattach stand.

NOTE: Handle with care when removing the monitor stand.

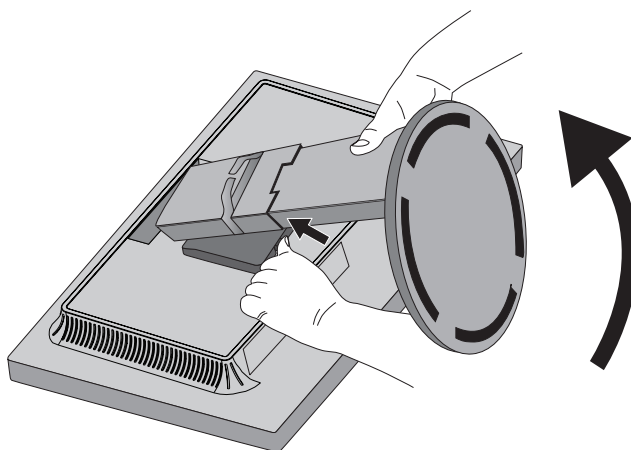

Figure S.1

2. Mount Flexible Arm

This LCD monitor is designed for use with a flexible arm.

1. Follow the instructions on how to Remove the Monitor Stand for Mounting to remove the stand.
2. Use the attached 4 screws to fasten the arm to the monitor (**Figure F.1**).



Figura F.1

- ⚠ CAUTION:**
- Only use the screws (4 pcs) that are included or M4 sized screws (Length: thickness of bracket and washer + 10-12 mm) when mounting to avoid damage to the monitor and stand.
 - To fulfil the safety requirements, the monitor must be mounted to an arm which guaranties the necessary stability under consideration for the weight of the monitor. The LCD monitor should only be used with an approved arm (e.g. TUEV GS mark).
 - Tighten all screws (recommended Fasten Force: 98 - 137N•cm).
A loose screw may cause the monitor to fall off the arm.
 - Attaching the flexible arm should be done by two or more people if the monitor cannot be placed face down on a flat surface for installation.

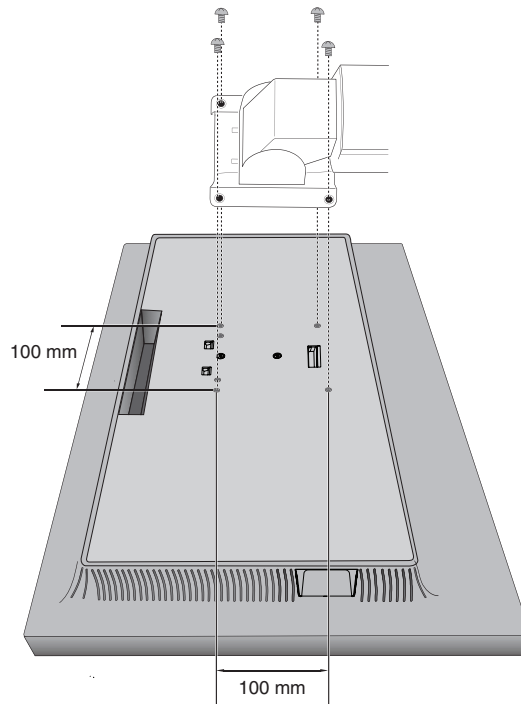
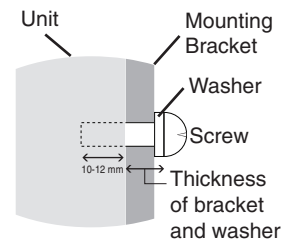

Controls

Many of the OSD controls are also available in the included MultiProfiler software, developed by NEC Display Solutions. The latest MultiProfiler software is available on the NEC Display Solutions website.

OSD (On-Screen Display) control buttons on the front of the monitor function as follows:

To access the OSD menu, press the MENU button.

To change the signal input, press the SELECT button.

NOTE: The OSD must be closed in order to change signal input.

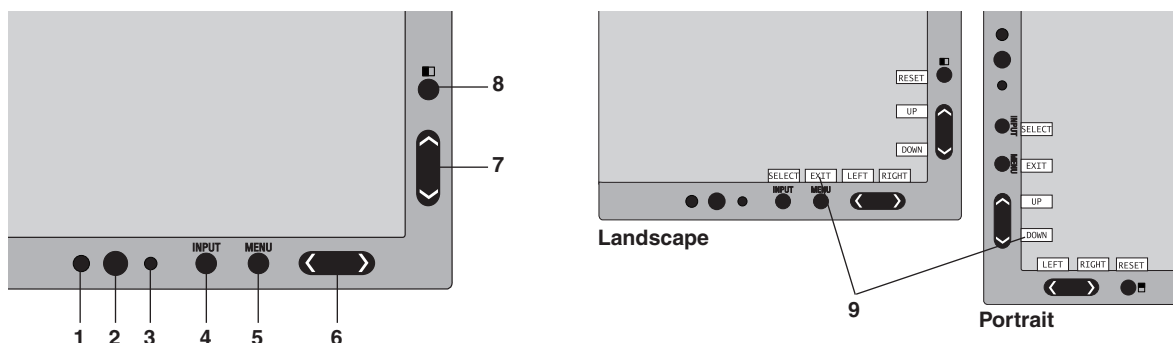

1 AMBIENT LIGHT SENSOR	Detects the level of ambient lighting allowing the monitor to make adjustments to various settings resulting in a more comfortable viewing experience. Do not cover this sensor.
2 Power	Turns the monitor on and off.
3 LED	Indicates that the power is on. Can be changed between blue and green in the Advanced OSD menu.
4 INPUT/SELECT	Enters the OSD main menu and sub menus. Changes the input source when not in the OSD menu. Hold the button to show USB selection menu when not in the OSD menu*1. NOTE: This USB selection setting back to the current setting by the OSD menu when you change input signal or turn off the monitor.
5 MENU/EXIT	Opens the OSD menu. Exits the OSD sub menus and main menu.
6 LEFT/RIGHT	Navigates through the OSD menu. When the OSD menu is not displayed on the screen, you can adjust volume directly.
7 UP/DOWN	Navigates through the OSD menu. When the OSD menu is not displayed on the screen, this button switches the PICTURE MODE status.
8 RESET/PIP	When the OSD menu is displayed on the screen, this button resets the OSD settings. PIP can be selected when the OSD is not displayed on the screen*3. Hold the button to show the ECO MODE menu while the OSD menu is off*1.
9 KEY GUIDE	The Key Guide appears on the screen when the OSD menu is accessed. The Key Guide will rotate when the OSD menu is rotated*.

* The "LEFT/RIGHT" and "UP/DOWN" buttons functionality is interchangeable depending on the orientation (Landscape/Portrait) of the OSD.

*1 When the HOTKEY function is OFF, this function is disabled.

*2 PICTURE MODE menu.

Press the UP/DOWN button to select PICTURE MODE in ACTIVE PICTURE. In PIP or PBP (Picture by Picture) mode, press LEFT/RIGHT button to change ACTIVE PICTURE. Picture mode can be selected for ACTIVE PICTURE independently.

*3 PIP MODE menu.

Press the UP/DOWN button to change MULTI PICTURE setting. Press the LEFT/RIGHT button to SWAP when you select PIP in MULTI PICTURE.

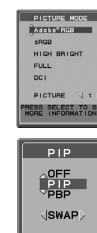

SETTING OSD LANGUAGE

- Use the control buttons (LEFT/RIGHT or UP/DOWN or MENU) to access the "LANGUAGE SELECTION" menu.
- Press the LEFT/RIGHT or UP/DOWN buttons to select the desired OSD language.
- To exit from this OSD menu, press EXIT button.

NOTE: Setting the OSD language is only necessary upon initial setup. The OSD language will stay the same until changed by the user.



Brightness/Contrast Controls

BRIGHTNESS

Adjusts the overall image and background screen brightness.

NOTE: For low brightness settings, the display will automatically compensate by adjusting the screen contrast. This will result in a reduced contrast ratio.

For high brightness settings, the display will automatically compensate by turning down uniformity compensation. This may result in decreased uniformity.

If digital compensation occurs, the brightness value on the OSD will change to magenta.

NOTE: The optimal display performance will be in the range where the OSD brightness value is black. When the display cannot achieve the desired brightness, the numerical brightness value on the OSD will blink.

NOTE: There is a brightness value limitation when you set ECO MODE or AUTO BRIGHTNESS.

ECO MODE

Decreases the amount of power consumed by reducing the brightness level.

OFF: No function.

ON: Reduces the maximum possible brightness to about 100 cd/m².

BLACK

Adjusts the black luminance.

When low settings are selected that cannot be displayed, the indicator on the OSD will turn magenta.

CONTRAST (Analog input only)

Adjusts the overall image and background screen brightness by input signal level.

NOTE: It is recommended to use BRIGHTNESS to adjust screen brightness for lower power consumption and improved image quality.

AUTO CONTRAST (Analog input only)

Adjusts the image displayed for non-standard video inputs.



Image Controls

LEFT / RIGHT

Controls Horizontal Image Position within the display area of the LCD.

DOWN / UP

Controls Vertical Image Position within the display area of the LCD.

H.SIZE (V.SIZE) (Analog input only)

Adjusts the horizontal size by increasing or decreasing this setting.

If the "AUTO ADJUST" function does not give you a satisfactory picture setting, a further tuning can be performed by using the "H.SIZE (or V.SIZE)" function (dot clock). A Moiré test pattern can be used for this. This function may alter the width of the picture. Use LEFT/RIGHT Menu to center the image on the screen. If the H.SIZE (or V.SIZE) is incorrectly calibrated, the result would look like the left drawing. The image should be homogeneous.



FINE (Analog input only)

Improve focus, clarity and image stability by increasing or decreasing this setting.

If the "AUTO ADJUST" function and the "H.SIZE" function do not give you a satisfactory picture setting, fine tuning can be performed by using the "FINE" function.

A Moiré test pattern can be used for this. If the FINE value is incorrectly calibrated, the result would look like the left drawing. The image should be homogeneous.

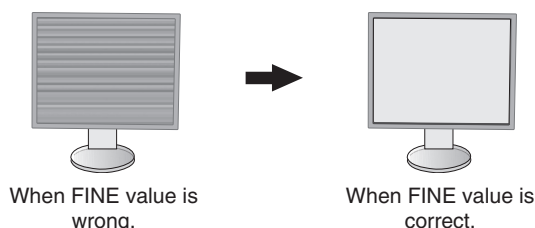

EXPANSION

Sets the zoom method.

FULL: The image is expanded to full screen, regardless of the resolution.

ASPECT: The image is expanded without changing the aspect ratio.

OFF: The image is not expanded.

NOTE: When image is rotated, depending on the signal resolution, characters and lines may be blurred.

SHARPNESS

This function is digitally capable of keeping crisp image at any time. It is continuously adjustable to get as distinct or as soft an image as you prefer and set independently by different timings.

AUTO ADJUST (Analog input only)

Automatically adjusts the Image Position, H. SIZE and FINE settings.

When using AUTO ADJUST, we recommend to display a white image to fill the screen.



Color Control Systems

PICTURE MODE

Changes the Picture mode that is most suitable for the type of content that is shown. 5 Picture modes are available to be customized. See Advanced menu Tag1 PICTURE MODE (page 18) and "Using the PICTURE MODE function" (page 17) for more information.

WHITE

Adjusts the white temperature to NATIVE or a specific color temperature using this setting. A lower color temperature will make the screen reddish and a higher color temperature will make the screen bluish. NATIVE is a default color temperature of LCD panel. 6500K is recommended for general graphic design and 5000K is recommended for print matching.

NOTE: WHITE adjustment will be up to 5000K when LOW BLUE is set.

ADJUST

HUE: Adjusts the hue of each color*1. The change in color will appear on screen and the menu color bars will show the amount of adjustment.

OFFSET: Adjusts the color brightness of each color*1. Press "RIGHT" button and the color brightness increases.

SATURATION: Adjusts the color depth of each color*1. Press the "RIGHT" button and the color vividness increases.

WHITE (White Balance): If TEMPERATURE needs further adjustment, the individual R/G/B levels of the white point can be adjusted. To adjust the R/G/B levels, CUSTOM must be showing as the TEMPERATURE selection.

*1: RED, YELLOW, GREEN, CYAN, BLUE and MAGENTA.

ADVANCED SETTING

Shows the ADVANCED MENU. See page 18 for detailed information. Set PICTURE MODE in detail in Advanced manual Tag1.



Tools

VOLUME

Controls the volume of the speakers or headphones.
To mute the sound output, press the “RESET” button.

SOUND INPUT (HDMI, DisplayPort inputs only)

Selects the sound input port, HDMI or DisplayPort.

HDMI input: HDMI or ANALOG.

DisplayPort input: DP or ANALOG.

NOTE: When you select “DVI”, the audio input sound outputs from speaker or headphone.

MULTI PICTURE AUDIO

Selects audio source.

NOTE: This function is available when the MULTI PICTURE is set to PIP (Picture in picture) or PBP (Picture by picture).

MULTI PICTURE

Selects MULTI PICTURE MODE, OFF/PIP/PBP (Picture by Picture).

ACTIVE PICTURE

Selects active picture when set to other than OFF in MULTI PICTURE. A white frame is displayed on selected picture while OSD menu is displayed.

PIP LEFT/RIGHT

Controls the horizontal position of the Picture in Picture window in PIP mode.

PIP DOWN/UP

Controls the vertical position of the Picture in Picture window in PIP mode.

PIP SIZE

Selects the size of the sub-picture used in PIP mode.

USB SELECT

Changes USB upstream input (1 or 2) associated with the current display input. When connecting a computer to each of the upstream ports, the monitor's USB downstream ports can be used by selecting this setting for the current input signal.

You can change the active display and upstream USB port combination by using the Input button (see page 11).

You can set the USB SELECT for each input signals in Advanced menu (see page 21).

When using only one upstream port, the connected upstream port is used by default.

NOTE: To avoid data loss, before changing the USB upstream ports, ensure that no USB storage devices are in use by the operating system of the computer attached to the USB upstream port.

VIDEO DETECT

Selects the method of video detection when more than one video input is connected for active picture.

FIRST: When current video input signal is not present, the monitor searches for a video signal from the other video input port(s). If the video signal is present in another port, the monitor switches the video source input port to the new found video source automatically. The monitor will not look for other video signals while the current video source is present.

LAST: When the monitor is displaying a signal from the current source and a new secondary source is supplied to the monitor, then the monitor will automatically switch to the new video source. When current video input signal is not present, then the monitor searches for a video signal from the other video input port(s). If the video signal is present in another port, then the monitor switches the video source input port to the new found video source automatically.

NONE: The Monitor will not search the other video input port unless the monitor is turned on.

OFF TIMER

The monitor will automatically power off after a period of time has passed, which you can set.

Before powering off, a message will appear on the screen asking if you want to delay the turn off time by 60 minutes.

Press any OSD button to delay the power-down time.

OFF MODE

The Intelligent Power Manager allows the monitor to enter into a power saving mode after a period of inactivity.

The OFF MODE has four settings.

OFF: Monitor does not go into power save mode when the input signal is lost.

STANDARD: Monitor enters power save mode automatically when the input signal is lost.

ADVANCED: The signal detection circuit works always. Recovery time to normal mode is faster than STANDARD. Power consumption is slightly higher than STANDARD.

NOTE: When set to STANDARD, if the image does not reappear when the signal is restarted, please change the setting to ADVANCED.

OPTION: Monitor enters power save mode automatically when the amount of surrounding light goes below the level that is determined by the user. The level can be adjusted in OFF MODE SETTING in Tag 6 of the Advanced OSD menu.

When in power save mode, the LED on the front of the monitor blinks amber. While in power save mode, push any of the front buttons, except for POWER and SELECT to return to normal.

When the amount of surrounding light returns to normal levels, the monitor will automatically return to normal mode.



MENU Tools

LANGUAGE

OSD control menus are available in nine languages.

OSD LEFT/RIGHT

You can choose the location where you would like the OSD control image to appear on your screen. Selecting OSD Location allows you to manually adjust the position of the OSD control menu left or right.

OSD DOWN/UP

You can choose the location where you would like the OSD control image to appear on your screen. Selecting OSD Location allows you to manually adjust the position of the OSD control menu Up or Down.

OSD TURN OFF

The OSD control menu will stay on as long as it is in use. You can select how long the monitor waits after the last touch of a button to shut off the OSD control menu. The preset choices are 10-120 seconds by 5-second increments.

OSD LOCK OUT

This control completely locks out access to all OSD control functions. When attempting to activate OSD controls while in the Lock Out mode, a screen will appear indicating the OSD controls are locked out.

There are three types of OSD LOCK OUT:

OSD LOCK OUT with no control: To activate the OSD Lock Out function, press SELECT, then "RIGHT" button and hold down simultaneously. To deactivate the OSD Lock Out, press SELECT, then "RIGHT" button and hold down simultaneously while in the OSD menu. No controls can be adjusted while in the lock out mode.

OSD LOCK OUT with BRIGHTNESS and VOLUME control: To activate the OSD Lock Out function, press SELECT, then "DOWN" and "LEFT" buttons and hold down simultaneously. To deactivate the OSD Lock Out, press SELECT, then "DOWN" and "LEFT" buttons and hold down simultaneously while in the OSD menu. BRIGHTNESS and VOLUME can be adjusted while in this lock out mode.

CUSTOM: Refer to the Advanced OSD Menu.

OSD TRANSPARENCY

Adjusts the transparency of the OSD Menu.

OSD COLOR

Adjusts the color of the OSD Menu. "Tag window frame color", "Item select color" and "Adjust window frame color" can be changed to Red, Green, Blue, or Gray.

RESOLUTION NOTIFIER

If ON is selected, a message will appear on the screen after 30 seconds, notifying you that the resolution is not the optimal resolution.

HOT KEY

You can adjust the VOLUME and PICTURE MODE directly. When this function is set to ON, you can adjust the VOLUME with “LEFT” or “RIGHT”, you can select the PICTURE MODE with “UP” or “DOWN”, while the OSD menu is off. The standard OSD can be accessed with the EXIT button. When this function is set to OFF, some buttons are disabled (see page 11).

FACTORY PRESET

Selecting FACTORY PRESET allows you to reset all OSD control settings (except VIDEO DETECT, LANGUAGE, OSD LOCK OUT, OSD COLOR, RESOLUTION NOTIFIER, HOT KEY) back to the factory settings. Individual settings can be reset by highlighting the control to be reset and pressing the RESET button.

NOTE: If you want to reset the Picture calibration settings and SELF COLOR CORRECTION settings, please use FACTORY PRESET in Advanced OSD menu (see page 23).



ECO Information

CARBON SAVINGS: Displays the estimated carbon savings information in kg.

CARBON USAGE: Displays the estimated carbon usage information in kg.

This is the arithmetic estimation, not actual measurement value.

This estimation is based without any options.

COST SAVINGS: Displays the electricity cost savings in balance.

CARBON CONVERT SETTING: Adjusts the carbon footprint factor in the carbon saving calculation. This initial setting is based on the OECD (2008 Edition).

CURRENCY SETTING: Displays electricity pricing in 6 currency units.

CURRENCY CONVERT SETTING: Displays electricity savings in kW/hour (US Currency is default).

NOTE: This model's initial setting is “Currency = US\$” and its Currency Convert setting = \$0.11.

This setting can be changed by using the ECO information menu.

If you want to use the French setting, please refer to steps below:

1. Press the Menu button and select the ECO information menu using the “LEFT” or “RIGHT” button.
2. Select CURRENCY SETTING item by pressing the “UP” or “DOWN” button.
3. The French currency unit is Euro (€). You can adjust currency setting to Euro icon (€) from US dollar (\$) by pressing the “LEFT” or “RIGHT” button in Current setting item.
4. Select CURRENCY CONVERT SETTING by pressing the “UP” or “DOWN” button.
This initial Euro (€) setting is based on the OECD data for Germany (2007 Edition).
Please check the receipt of electricity prices for France or OECD data for France.
The French value according to the OECD data (2007 Edition) was €0.12.
5. Adjust CURRENCY CONVERT SETTING by pressing the “LEFT” or “RIGHT” button.



Information

Provides information about the current resolution display (Main picture), current USB input setting and technical data including the preset timing being used and the horizontal and vertical frequencies. Indicates the model and serial numbers of your monitor.

OSD Warning

OSD Warning menus disappear with EXIT button.

NO SIGNAL: This function gives a warning when there is no Horizontal or Vertical Sync. After power is turned on or when there is a change of input signal, the **No Signal** window will appear. You can set below OSD menus:

- OFF MODE (see page 15): Select from OFF/STANDARD/ADVANCED/OPTION.

- DIGITAL LONG CABLE (see page 20): Select compensation level. Lower number produces less compensation.

- ANALOG DETECT (see page 24): Select from SEP/COMP or SOG.

RESOLUTION NOTIFIER: This function warns if resolution other than the optimized resolution is used. After power is turned on or when there is a change of input signal or the video signal doesn't have proper resolution, the **Resolution Notifier** window will open. This function can be disabled in the MENU Tools.

OUT OF RANGE: This function gives a recommendation of the optimized resolution and refresh rate. After the power is turned on or there is a change of input signal or if the video signal doesn't have proper timing, the **Out Of Range** menu will appear.

If you need detailed information about the controls, please use the ADVANCED OSD menu.

Using the PICTURE MODE function

Choose the Picture Mode that is most suitable for the type of content that is shown.

There are several types of mode (sRGB, Adobe®RGB, DCI, REC-Bt709, HIGH BRIGHT, LOW BLUE, FULL, DICOM, PROGRAMMABLE).

- Each PICTURE MODE includes BRIGHTNESS, AUTO BRIGHTNESS, WHITE, Color Gamut, GAMMA, BLACK, UNIFORMITY, COLOR VISION EMU, METAMERISM, RESPONSE IMPROVE, AMBIENT LIGHT COMP., 6-Axis ADJUST settings. You can change these settings in Tag1 advanced menu.

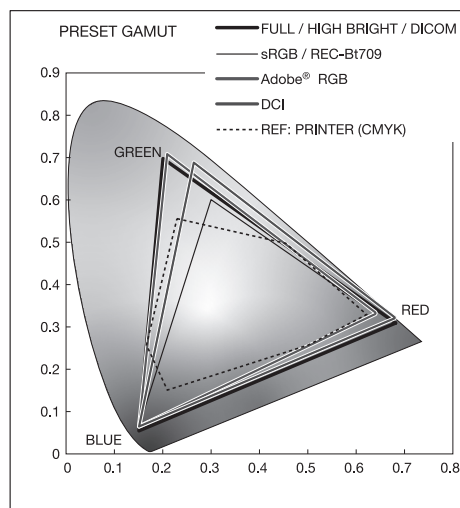
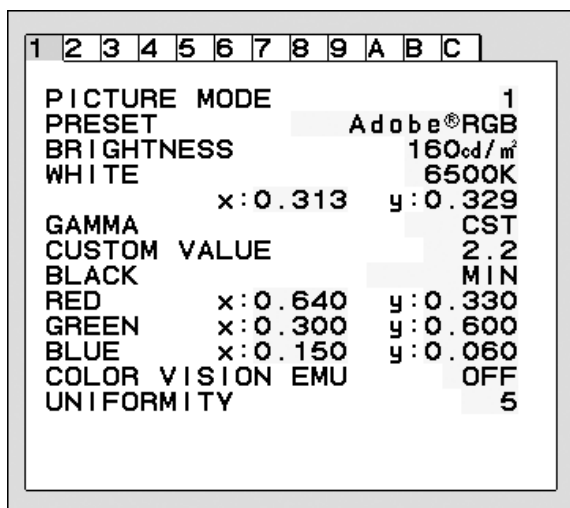

The type of PRESET for PICTURE MODE

PRESET	PURPOSE
sRGB	Standard color space used for the Internet, Windows operating systems and digital cameras. Recommended setting for general color management.
Adobe®RGB	Provides a standard color space used in high-end graphics applications such as professional digital still cameras and imaging.
eciRGB_v2	Provides a color space profile recommended by ECI (The European Color Initiative).
DCI	Color setting for digital cinema.
REC-Bt709	Color setting for High-definition television.
HIGH BRIGHT	Highest brightness setting.
LOW BLUE*	Reduces blue light emitted from the monitor.
FULL	Native display color gamut. Suitable for use with color managed applications.
DICOM	Medical settings for X-ray imaging view. Setting that conforms to the DICOM standard for the Grayscale Standard Display Function.
PROGRAMMABLE	For "MultiProfiler" software or the Hardware Calibration settings by NEC Display Solutions software (some OSD settings are disabled).

*: Low Blue Light function substantially reduces hazardous light and greatly reduces eyestrain.

- NOTE:**
- MultiProfiler software, developed by NEC Display Solutions, is highly recommended to provide extended color management features such as ICC profile Emulation and Printer Emulation. The latest MultiProfiler software is available on the NEC Display Solutions website. When the selected PICTURE MODE is different from your computer's ICC color profile, you may experience inaccurate color reproduction.
 - When PICTURE MODE is locked, "PICTURE MODE IS LOCKED" appears on screen. To unlock PICTURE MODE settings, press "SELECT" and "UP" buttons at the same time.

Advanced OSD

If you need detailed information about the controls, please use the advanced menu. There are 2 ways to access the advanced menu.

Method 1:

<To access the advanced menu>

- Press the Menu button to access OSD menu. Use the front buttons to move the cursor to the ADVANCED SETTING in Color control systems. Press INPUT button to open the advanced OSD.

<To exit the advanced menu>

- Press the EXIT button.

Method 2:

<To access the advanced menu>

- Turn off the monitor.
- Turn on the monitor by pushing the “POWER” and “INPUT/SELECT” button at the same time for at least one second simultaneously. Then press the control buttons (EXIT, LEFT, RIGHT, UP, DOWN).
- The Advanced OSD will appear. This menu is larger than the normal OSD.

<To exit the advanced menu>

- Turn off and restart the monitor.

To make an adjustment, ensure that the tag is highlighted, then press “SELECT”.

To move to another tag, press “EXIT”, then press “LEFT” or “RIGHT” to highlight another tag.

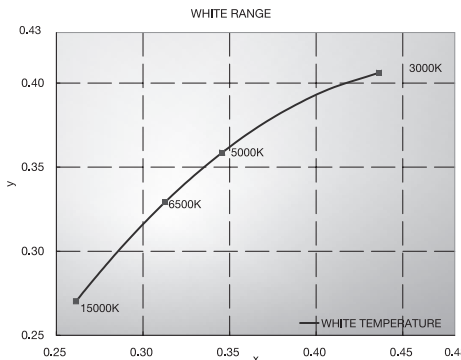
Tag1	PICTURE MODE	Selects PICTURE MODE, from 1 to 5.
	PRESET	Sets the PICTURE MODE PRESET from the type of PRESET (see page 17).
	BRIGHTNESS* ¹	Adjusts the overall image and screen background brightness. Press “LEFT” or “RIGHT” to adjust.
	WHITE	Adjusts the white color by temperature or x, y setting. A lower color temperature will make the screen reddish and a higher color temperature will make the screen bluish. A stronger x makes the screen reddish, a stronger y makes it greenish and weak x, y makes it a bluish white. 

*¹ This item does not reset by FACTORY PRESET (Tag7), when the AUTO BRIGHTNESS is set to “ON”.

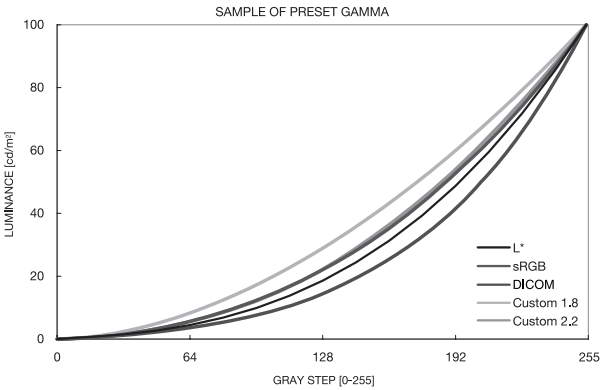
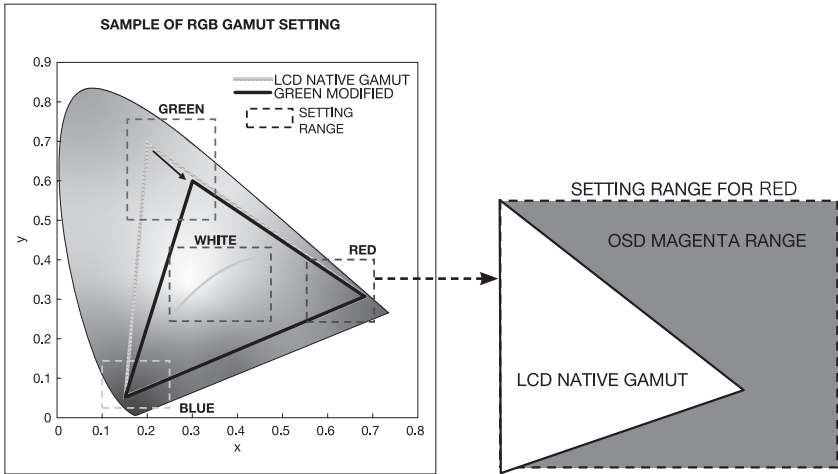
GAMMA	<p>Allows you to manually select the brightness level of grayscale. There are five selections: sRGB, L Star, DICOM, PROGRAMMABLE and CUSTOM.</p> <p>sRGB: GAMMA setting for sRGB.</p> <p>L Star: GAMMA setting for eciRGB_v2 and Lab color space.</p> <p>DICOM: DICOM GSDF (Grayscale Standard Display Function) is typically used for medical imaging.</p> <p>PROGRAMMABLE: The settings can be changed to your preference by downloading the application software. You can select this when PICTURE MODE is PROGRAMMABLE. This function cannot be select in Advanced OSD menu.</p> <p>CUSTOM: CUSTOM VALUE can be adjusted when CUSTOM is selected as the GAMMA SELECTION setting.</p> <p>CUSTOM VALUE: The gamma value is selected from a range from 0.5 to 4.0 in 0.1 steps.</p> 
BLACK	<p>Adjusts the black luminance. When the selected settings are too low to be displayed, the indicator on the OSD will turn magenta.</p>
RED GREEN BLUE	<p>Adjusts the color gamut. When the selected settings are outside of the LCD gamut, the indicator on the OSD will turn magenta.</p> 
PRINT EMU	<p>Previews printer emulation effect by “MultiProfiler”. You need to select “PROGRAMMABLE” for PICTURE MODE. PRINT MENU is shown when Advanced menu Tag7 OSD PROG. SETTING is ON.</p>
COLOR VISION EMU	<p>Previews various typical human vision deficiencies and is useful for evaluating how people who have such deficiencies will perceive colors. This preview is available in four modes: Types P (Protanopia), D (Deuteranopia) and T (Tritanopia) emulate color vision dichromacy, and Grayscale can be used for evaluating contrast legibility.</p> <p>NOTE: Depending on the vision of the user, including those with color vision deficiency, there will be a variation in how the screen's color is seen and experienced.</p> <p>A simulation is used to illustrate the view of those with a color vision deficiency. It is not their actual view. The simulation is a reproduction of those with a strong color vision mode of type P, type D or type T. People with a slight color vision deficiency will experience little to no difference compared to those with normal color vision.</p>

	UNIFORMITY	This function electronically compensates for the slight variations in the white uniformity level as well as for deviations in color that may occur throughout the display area of the screen. These variations are characteristic of LCD panel technology. This function improves the color and evens out the luminance uniformity of the display. NOTE: Using the UNIFORMITY feature does reduce the overall peak luminance of the display. If greater luminance is desired over the uniform performance of the display, then UNIFORMITY should be turned off. A higher number produces a better effect, but may also reduce CONTRAST RATIO. When BRIGHTNESS is shown in magenta, the UNIFORMITY setting is automatically reduced.
Tag2	SHARPNESS	This is a digital capability for keeping a crisp image at all signal timings. It continuously adjusts to maintain as distinct or as soft image as you prefer, and is set independently according to different timings. Press "LEFT" or "RIGHT" to adjust.
	RESPONSE IMPROVE	Turns the Response Improve function on or off. Response Improve may reduce blurring that occurs in some moving images.
	ECO MODE	Decreases the amount of power consumed by reducing the brightness level. OFF: No function. ON: Reduces the maximum possible brightness to about 100 cd/m ² .
	AUTO BRIGHTNESS	AUTO BRIGHTNESS has two settings. "OFF" is recommended for best color reproduction. OFF: No function. ON: Adjusts the brightness automatically, by detecting the brightness level of your environment and adjusting the monitor with the best BRIGHTNESS setting. Please refer to Page 30 for full "Auto Brightness" information. Note: Do not cover environmental brightness sensor (AMBIENT LIGHT SENSOR).
	METAMERISM	Improves the white point color matching when the display used side-by-side with a standard gamut display monitor. This feature compensates for the way the human eye perceives colors slightly differently compared to the scientific instrument used to adjust the display during calibration. This function should be disabled in color-critical applications.
	AMBIENT LIGHT COMP.	Luminance setting depends on ambient light compensation. This setting mostly affects black reproduction. NOTE: AMBIENT LIGHT SENSOR measures ambient brightness when power is on and affects image and color quality settings. NOTE: Do not cover environmental brightness sensor (AMBIENT LIGHT SENSOR).
	(6 - AXIS ADJUST)	HUE: Adjusts the hue of each color* ¹ . The change in color will appear on screen and the menu color bars will show the amount of adjustment. SATURATION: Adjusts the color depth of each color* ¹ . Press the "RIGHT" button and the color vividness increases. OFFSET: Adjusts the color brightness of each color* ¹ . Press "RIGHT" button and the color brightness increases. * ¹ : RED, YELLOW, GREEN, CYAN, BLUE and MAGENTA.
	SHORTCUT CUSTOM	You can select the PICTURE MODE which are displayed in PICTURE MODE shortcut menu.
Tag3	DIGITAL LONG CABLE (DVI/HDMI input only)	Compensates for image degradation caused by using a long cable. A lower number produces less compensation.
Tag4	VIDEO LEVEL (HDMI input only)	NORMAL: For computer setting. Displays all input signals of 0-255 steps. EXPAND: For audio-visual equipment setting. Expands input signals of 16-235 steps to 0-255 steps. AUTO: Auto setting depending on the input signal.
	AUTO ADJUST* ² (Analog input only)	Automatically adjusts the Image Position and H.SIZE settings and FINE settings. Press "SELECT" to activate Auto Adjustment. Please use test pattern, which is included in the enclosed CD-ROM.
	AUTO CONTRAST* ² (Analog input only)	Adjusts the image displayed for non-standard video inputs. Press "SELECT" to adjust. Any adjustment requires the image to have white portions.
	CONTRAST (Analog input only)	Adjusts the image brightness and contrast in relation to the background. Press "LEFT" or "RIGHT" to adjust.
	BLACK LEVEL (Analog input only)	Adjusts the RGB black level by input signal level.

*² This item does not reset by FACTORY PRESET (Tag7).

Tag5	H.POSITION	Controls Horizontal Image Position within the display area of the LCD. Press "LEFT" or "RIGHT" to adjust.
	V.POSITION	Controls Vertical Image Position within the display area of the LCD. Press "LEFT" or "RIGHT" to adjust.
	H.SIZE (Analog input only)	Adjusts the horizontal size of the screen. If the "AUTO ADJUST" function does not give you a satisfactory picture setting, a further tuning can be performed by using the "H.SIZE (V.SIZE)" function (dot clock). A Moiré test pattern can be used for this. This function may alter the width of the picture. Use LEFT/ RIGHT Menu to center the image on the screen. If the H.SIZE (V.SIZE) is incorrectly calibrated, vertical bands will appear. The image should be homogeneous.
	FINE (Analog input only)	Improve focus, clarity and image stability by increasing or decreasing this setting. If the "AUTO ADJUST" function and the "H.SIZE" function do not give you a satisfactory picture setting, fine tuning can be performed by using the "FINE" function. A Moiré test pattern could be used for this. If the Fine value is incorrectly calibrated, horizontal lines will appear on the display. The image should be homogeneous.
	H.RESOLUTION	Adjusts the horizontal size by increasing or decreasing the setting. Press "RIGHT" button to expand the width of the image on the screen. Press "LEFT" button to narrow the width of the image on the screen.
	V.RESOLUTION	Adjusts the vertical size by increasing or decreasing the setting. Press "RIGHT" button to expand the height of the image on the screen. Press "LEFT" button to narrow the height of the image on the screen.
	EXPANSION	Sets the zoom method. FULL: The image is expanded to full screen, regardless of the resolution. ASPECT: The image is expanded without changing the aspect ratio. OFF: The image is not expanded.
	OVER SCAN (HDMI input only)	Some video formats may require different scanning modes in order to best display the image. ON: Image size is larger than what can be displayed. The image edge will appear cropped. Approximately 95% of the image will be shown on the screen. OFF: Image size stays within the display area. The whole image is displayed on the screen. AUTO: Auto setting.
	SIDE BORDER COLOR	Adjusts the side black bars color between black and white.
Tag6	USB SELECT	USB upstream port selection for DP/HDMI/DVI-D/D-SUB. When connecting a computer to each of the upstream ports, the monitor's USB downstream ports can be used by selecting this setting for the current input signal. When using only one upstream port, the connected upstream port is active. You can change the active display and upstream USB port combination by using the Input button (see page 11). NOTE: To avoid data loss, before changing USB upstream ports, ensure that no USB storage devices are in use by the operating system of the computer attached to the USB upstream port.
	VIDEO DETECT*1	Selects the method of video detection when more than one computer is connected for active picture. Press "LEFT" or "RIGHT" to select. FIRST: When current video input signal is not present, then the monitor searches for a video signal from the other video input port(s). If the video signal is present in another port, then the monitor switches the video source input port to the new found video source automatically. The monitor will not look for other video signals while the current video source is present. LAST: When the monitor is displaying a signal from the current source and a new secondary source is supplied to the monitor, then the monitor will automatically switch to the new video source. When current video input signal is not present, then the monitor searches for a video signal from the other video input port(s). If the video signal is present in another port, then the monitor switches the video source input port to the new found video source automatically. NONE: The Monitor will not search the other video input port unless the monitor is turned on.

*1 This item does not reset by FACTORY PRESET (Tag7).

	OFF TIMER	Monitor will automatically turn off after the preset time period from power on with the ON/OFF function. When you select "ON", press "SELECT" and "LEFT" or "RIGHT" to adjust. Before powering off, a message will appear on the screen asking the user if they want to delay the turn off time by 60 minutes. Press any OSD button to delay the turn off time.
	POWER SAVE TIMER*1	ON: Monitor automatically changes to OFF mode after 2 hours of continuous no-video signal. OFF: Monitor will not automatically change to OFF mode when no video signal is connected.
	OFF MODE	The Intelligent Power Manager allows the monitor to enter into a power saving mode after a period of inactivity. The OFF MODE has four settings. OFF: Monitor does not go into power save mode when the input signal is lost. STANDARD: Monitor enters power save mode automatically when the input signal is lost. ADVANCED: The signal detection circuit works always. Recovery time to normal mode is faster than STANDARD. Power consumption is higher than STANDARD. NOTE: When set to STANDARD, if the image does not reappear when the signal is restarted, please change the setting to ADVANCED. OPTION: Monitor enters power save mode automatically when the amount of surrounding light goes below the level that is determined by the user.
	OFF MODE SETTING	Adjusts the ILLUMINANCE value for OFF MODE. Shows illuminance.
	LED BRIGHTNESS*1	Controls the brightness of the power LED on the monitor.
	LED COLOR*1	Toggles the power LED on the front between blue or green.
Tag7	LANGUAGE*1	OSD control menus are available in nine languages. Press "LEFT" or "RIGHT" to select.
	OSD H.POSITION	You can choose the location where the OSD appears on the screen. Selecting OSD Location allows you to manually adjust the position of the OSD control menu left or right.
	OSD V.POSITION	You can choose the location where the OSD appears on the screen. Selecting OSD Location allows you to manually adjust the position of the OSD control menu up or down.
	OSD TURN OFF	The OSD control menu will stay on as long as it is use. You can select how long the monitor waits after the last touch of a button to shut off the OSD control menu. The preset choices are 10-120 seconds in 5 second increments.
	OSD LOCK OUT*1	This control completely locks out access to all OSD control functions. When attempting to activate OSD controls while in the Lock Out mode, a screen will appear indicating the OSD controls are locked out. There are three types of OSD LOCK OUT: OSD LOCK OUT with no control: To activate the OSD Lock Out function, press SELECT, then "RIGHT" button and hold down simultaneously. To deactivate the OSD Lock Out, press SELECT, then "RIGHT" button and hold down simultaneously while in the OSD menu. No controls can be adjusted while in the lock out mode. OSD LOCK OUT with BRIGHTNESS and VOLUME control: To activate the OSD Lock Out function, press SELECT, then "DOWN" and "LEFT" buttons and hold down simultaneously. To deactivate the OSD Lock Out, press SELECT, then "DOWN" and "LEFT" buttons and hold down simultaneously while in the OSD menu. BRIGHTNESS and VOLUME can be adjusted while in the lock out mode. CUSTOM: Press RESET and EXIT to enter the CUSTOM Menu. Select ENABLE or DISABLE for POWER KEY, INPUT SEL, HOT KEY (PICTURE MODE & VOLUME), PICTURE MODE, WARNING (RESOLUTION NOTIFIER/OSD LOCK OUT). To deactivate the OSD Lock Out function, press RESET and EXIT to bring up the LOCK OUT warning. Press SELECT, SELECT, <, >, <, >, EXIT.
	OSD TRANSPARENCY	Adjusts the transparency of the OSD MENU.
	OSD COLOR*1	"Tag window frame color", "Item select color" & "Adjust Window frame color" can be changed.
	OSD PROG. SETTING	If ON is selected, OSD settings are shown for PROGRAMMABLE in PRESET Tag1.
	BOOT LOGO*1	The NEC logo is briefly displayed after the monitor is powered on. This feature can be turned on or off in the OSD. Note: If the "EXIT" button is kept pressed while NEC logo is displayed, the BOOT LOGO menu will appear. It is possible to change the BOOT LOGO setting to OFF.
	SIGNAL INFORMATION*1	Signal information can be displayed in the corner of the screen. Signal information is either "ON/OFF".

*1 This item does not reset by FACTORY PRESET (Tag7).

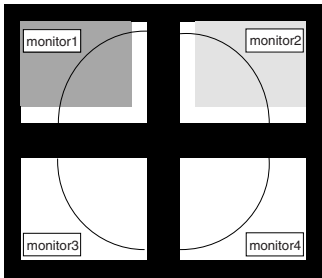
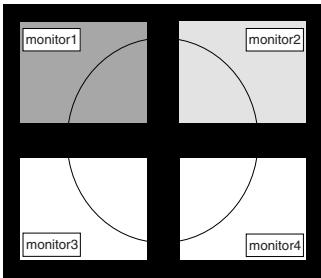
	RESOLUTION NOTIFIER*1	If ON is selected, a message will appear on the screen after 30 seconds, notifying you that the resolution is not the optimal resolution.
	HOT KEY*1	When this function is activated; the VOLUME of the monitor can be adjusted without entering the OSD menu by using the front buttons. The “LEFT” or “RIGHT” buttons adjust the VOLUME level. The “UP” or “DOWN” buttons select the PICTURE MODE. When this function is set to OFF, some buttons are disabled. See page 11.
	FACTORY PRESET	Selecting FACTORY PRESET allows you to reset all OSD control settings back to the factory settings. Highlighting the control to be reset and pressing the RESET button can reset individual settings.
Tag8	VOLUME	Controls the volume of the speakers or headphones when set to other than OFF in MULTI PICTURE. To mute the sound output, press the “RESET” button.
	SOUND INPUT	Selects the sound input port when set to other than OFF in MULTI PICTURE. A red frame is displayed on selected picture. NOTE: When DP EDID SOUND SELECT is OFF, DisplayPort signal will not emit any sound.
	MULTI PICTURE AUDIO	Selects audio source. NOTE: This function is available when the MULTI PICTURE is set to PIP (Picture in picture) or PBP (Picture by picture).
	AUDIO DELAY	For synchronizing of sounds and images, delay the audio output timing.
	DP EDID SOUND SELECT	When OFF is selected, DisplayPort signal will not emit any sound. You can select “OFF”, when DisplayPort signals do not optimize on the native resolution.
	MULTI PICTURE	Selects MULTI PICTURE MODE, OFF/PIP/PBP (Picture by Picture)
	ACTIVE PICTURE	Selects active picture when set to other than OFF in MULTI PICTURE. A white frame is displayed on selected picture.
	EXPANSION	Sets the zoom method. FULL: The image is expanded to full screen, regardless of the resolution. ASPECT: The image is expanded without changing the aspect ratio. OFF: The image is not expanded.
	PIP LEFT/RIGHT	When you select “PIP” in PIP MODE, you can control horizontal position of PIP display area.
	PIP DOWN/UP	When you select “PIP” in PIP MODE, you can control vertical position of PIP display area.
	PIP SIZE	Selects the size of the sub-picture used in PIP MODE.
Tag9	TILE MATRIX	<p>The TILE MATRIX feature allows one image to be displayed over multiple screens. This feature can be used with up to 25 monitors (5 vertical and 5 horizontal). Using TILE MATRIX requires the PC output signal be sent through a distribution amplifier to each individual monitor.</p> <p>H MONITOR: Select the number of horizontal displays. V MONITOR: Select the number of vertical displays. MONITOR No: Select a position to expand the screen. TILE COMP: Works in tandem with TILE MATRIX to compensate for the width of the tile bezels in order to accurately display the image.</p> <p>Tile Comp with 4 monitors (black area shows monitor frames):</p> <div style="display: flex; justify-content: space-around; align-items: center;"> <div style="text-align: center;">  <p>Tile Comp OFF</p> </div> <div style="text-align: center;">  <p>Tile Comp ON</p> </div> </div> <p>NOTE: TILE MATRIX works only when PIP MODE is OFF.</p>

*1 This item does not reset by FACTORY PRESET (Tag7).

TagA	ROTATION	<p>OSD: AUTO: The OSD rotates automatically when the monitor is rotated. OSD ROTATION is set to AUTO by default. LANDSCAPE: Display the OSD with landscape mode. PORTRAIT: Display the OSD with portrait mode.</p> <p>PICTURE1: AUTO: The left/up side or main window image automatically rotates according to the orientation of the display. OFF: The window image is not rotated. ON: The left/up side or main window image always rotated. NOTE: Interlace signal does not rotate. When MULTI PICTURE is set to OFF then PICTURE1 is set to ON or AUTO, the displayed image will rotate.</p> <p>PICTURE2 (MULTI PICTURE ON only): AUTO: The right/down side or sub window image automatically rotates according to the orientation of the display. OFF: The window image is not rotated. ON: The right/down side or sub window image always rotated. NOTE: Interlace signal does not rotate. When MULTI PICTURE is set to OFF, PICTURE2 is not available.</p>
	DDC/CI	DDC/CI ENABLE/DISABLE: Turns on or off the two way communication and control with connected PC by the video cable.
	SCREEN SAVER*1	<p>Use the SCREEN SAVER to reduce the risk of image persistence. NOTE: SCREEN SAVER works when MULTI PICTURE is OFF. SCREEN SAVER works when ENABLE is OFF in TILE MATRIX. MOTION (Default OFF): Screen image moves periodically in 4 directions in order to reduce the risk of image retention. Timing for MOTION can be set so the screen image moves in intervals from every 10 to 900 seconds. Timing is set in 10-second increments. OPTION (Default REDUCED): There are two optional selections. REDUCED: Screen image is reduced to 95% size and is moved periodically in 4 directions. Screen may appear slightly less sharp than normal. The full image appears on the display. NOTE: Some input signals may not be supported by REDUCED. FULL: Screen image is set to FULL and is moved periodically in 4 directions. Screen image goes outside of the display area in the direction that it shifts so that a portion of the image may appear to be cut off.</p>
	BLANK SIGNAL SKIP	Skips no signal inputs when you change input signal with INPUT button.
	INPUT SETTING*1 (Analog input only)	<p>Video Band Width: Reduces the visual “noise” level of the input signal. The higher the number, the greater the effect of reducing the noise. Press “LEFT” or “RIGHT” to select. Clamp position: Operating your monitor at a non-standard timing may cause images to appear darker than normal or have color distortion. Use of the Clamp position control will adjust images to their normal state.</p>
	ANALOG DETECT	<p>Selects a type of analog input sync signal. SEP/COMP: Please select this setting if you input horizontal and vertical sync signal separately from a video input. SOG: Please select this setting if you input an input with horizontal and vertical sync signal. NOTE: It might not be displayed properly if sync signal input and the selection you made at this setting are not matched.</p>
	TagB	CARBON SAVINGS
	CARBON USAGE	Displays the estimated carbon usages information in kg. This is the arithmetic estimation, not actual measurement value. This estimation is based without any options.
	COST SAVINGS	Displays the electricity cost savings in balance.
	CARBON CONVERT SETTING	Adjusts the carbon footprint factor in the carbon saving calculation. This initial setting is based on the OECD (2008 Edition).
	CURRENCY SETTING*1	Displays electricity pricing (available in 6 currency units).

*1 This item does not reset by FACTORY PRESET (Tag7).

	CURRENCY CONVERT SETTING	Adjusts electricity prices-electric energy equivalent in the electrical rate saving calculation.
	HOURS RUNNING* ¹	Shows total running time.
	SELF COLOR CORRECTION	Uses the internal color sensor to compensate for a natural color shift that occurs with age.
TagC	INFORMATION* ¹	Provides information about the current display resolution. Technical data, including the preset timing currently being used and the horizontal and vertical frequencies is also displayed.

*¹ This item does not reset by FACTORY PRESET (Tag7).

Specifications

Monitor Specifications		MultiSync PA243W	Notes
LCD Module	Diagonal: Viewable Image Size: Native Resolution (Pixel Count):	61.1 cm/24 inches 61.1 cm/24 inches 1920 x 1200	Active matrix; thin film transistor (TFT) liquid crystal display (LCD); 0.270 mm dot pitch; 350 cd/m ² white luminance; 1000:1 contrast ratio (typical).
Input Signal			
DisplayPort:	DisplayPort Connector:	Digital RGB	DisplayPort V1.1a (HDCP1.3)
DVI:	DVI-D 24pin:	Digital RGB	DVI (HDCP1.4)
VGA:	Mini D-Sub 15-pin:	Analog RGB Sync	0.7 Vp-p/75 ohm Separate sync.TTL level Positive/Negative Composite sync.TTL level Positive/Negative Sync on Green (Video 0.7 Vp-p and Sync Negative 0.3 Vp-p)
HDMI:	HDMI Connector:	Digital RGB	HDMI (HDCP1.4)
Display Colors		1,073,741,824 (DisplayPort/HDMI 10 bit) 16,777,216 (DVI)	Depends on display card used.
Synchronization Range	Horizontal: Vertical:	31.5 kHz to 93.8 kHz, 118.4 kHz* ² (Analog) 31.5 kHz to 91.1 kHz, 118.4 kHz* ² (Digital) 50 Hz to 85 Hz	Automatically Automatically Automatically
Viewing Angle	Left/Right: Up/Down:	±89° (CR > 10) ±89° (CR > 10)	
Response Time		8 ms (Gray to gray Typ)	
Resolutions Supported (Some systems may not support all modes listed).		640 x 480* ¹ at 60 Hz to 85 Hz 720 x 400* ¹ at 70 Hz to 85 Hz 800 x 600* ¹ at 85 Hz 832 x 624* ¹ at 75 Hz 1024 x 768* ¹ at 60 Hz to 75 Hz 1280 x 1024* ¹ at 75 Hz 1600 x 1200* ¹ at 60 Hz 1920 x 1200 at 60 Hz..... 1400 x 1050* ¹ at 60 Hz 1440 x 900* ¹ at 60 Hz 1600 x 1200* ¹ at 65 Hz to 75 Hz (Analog) 480P (720 x 480* ¹ at 60 Hz) 576P (720 x 576* ¹ at 60 Hz) 720P (1280 x 720* ¹ at 50 Hz to 60 Hz) 1080P (1920 x 1080* ¹ at 50 Hz to 60 Hz) 960 x 1200* ¹ at 60 Hz 1200 x 960* ¹ at 60 Hz 1200 x 1920 at 60 Hz	NEC DISPLAY SOLUTIONS recommended resolution for optimal display performance.
Active Display Area	Landscape: Horiz.: Vert.: Portrait: Horiz.: Vert.:	518.4 mm/20.4 inches 324.0 mm/12.8 inches 324.0 mm/12.8 inches 518.4 mm/20.4 inches	
USB Hub	I/F: Port: Load Current:	USB Specification Revision 3.1 Gen 1 Upstream 2 Downstream 3 Maximum 0.9 A per port	
AUDIO			
AUDIO Input:	STEREO Mini Jack: DisplayPort Connector: HDMI Connector:	Analog Audio Digital Audio Digital Audio	Stereo L/R 500mV rms 20 Kohm PCM 2ch 32, 44.1, 48 kHz (16/20/24bit) PCM 2ch 32, 44.1, 48 kHz (16/20/24bit)
Headphone Output:	STEREO Mini Jack:		Headphone Impedance 32 Ohm
Power Supply		AC 100-240 V ~ 50/60 Hz	
Current Rating		1.16 - 0.58 A (with option)	
Dimensions	Landscape: Portrait:	556.2 mm (W) x 379.1 - 529.1 mm (H) x 233.0 mm (D) 21.9 inches (W) x 14.9 - 20.8 inches (H) x 9.2 inches (D) 361.8 mm (W) x 573.5 - 629.8 mm (H) x 233.0 mm (D) 14.2 inches (W) x 22.6 - 24.8 inches (H) x 9.2 inches (D)	
Stand adjustable range	Height Adjustment: Tilt / Pivot / Swivel:	150 mm/5.9 inches (Landscape orientation) 56.3 mm/2.2 inches (Portrait orientation) Up 30° Down 5° / 90° / 340°	
Weight		8.0 kg (17.6 lbs)	
Environmental Considerations	Operating Temperature: Humidity: Altitude: Storage Temperature: Humidity: Altitude:	5°C to 35°C/41°F to 95°F 20% to 80% 0 to 16,404 Feet/0 to 5,000 m -20°C to 60°C/-4°F to 140°F 10% to 85% 0 to 40,000 Feet/0 to 12,192 m	

*1 Interpolated Resolutions: When resolutions are shown that are lower than the pixel count of the LCD module, text may appear different. This is normal and necessary for all current flat panel technologies when displaying non-native resolutions full screen. In flat panel technologies, each dot on the screen is actually one pixel, so to expand resolutions to full screen, an interpolation of the resolution must be done.

*2 1200 x 1920 resolution only.

NOTE: Technical specifications are subject to change without notice.

Features

SPECTRAVIEW ENGINE: This system is designed for improvement the visual quality of the monitor. Each monitor is calibrated at the factory. By making automatic adjustments during operation of the monitor hardware in real time, optimal settings are configured without any user interaction.

DisplayPort: DisplayPort is designed to be the future-ready, scalable solution for high performance digital display connectivity. It enables the highest resolutions, the fastest refresh rates and deepest color depths over standard cables.

HDMI: HDMI is designed to be the future-ready, scalable solution for high performance digital display connectivity. It enables the highest resolutions, the fastest refresh rates and deepest color depths over standard cables, especially for consumer audio/video equipment.

P&D (Plug and Display): The VESA standard for digital flat panel monitor interfaces. It is more robust than DFP since it allows for other options off a signal connector (options like USB, analog video and IEEE-1394-995). The VESA committee has recognized that DFP is a subset of P&D. As a DVI-based connector (for the digital input pins), only a simple adapter is necessary for compatibility between P&D and other DVI-based digital connector such as DVI and DFP.

Color Control Systems: Allow you to adjust the colors on your screen and customize the color accuracy of your monitor to a variety of standards.

Natural Color Matrix: Combines Six-axis color control and the sRGB standard. Six-axis color control permits color adjustments via six axes (R, G, B, C, M and Y) rather than through the three axes (R, G and B) previously available. The sRGB standard provides the monitor with a uniform color profile. This assures that the colors displayed on the monitor are exactly the same as on the color printout (with sRGB supporting operating system and sRGB printer). This allows you to adjust the colors on your screen and customise the color accuracy of your monitor to a variety of standards.

OSD (On-Screen Display) Controls: Allow you to quickly and easily adjust all elements of your screen image via simple to use on-screen menus.

ErgoDesign Features: Enhance human ergonomics to improve the working environment, protect the health of the user and save money. Examples include OSD controls for quick and easy image adjustments, tilt base for preferred angle of vision, small footprint and lower emissions.

VESA Standard Mounting Interface: Allows users to connect your MultiSync monitor to any VESA standard third party mounting arm or bracket.

Adjustable stand with pivot capability: Adds flexibility to your viewing preferences.

Quick Release stand: Allows fast removal.

Plug and Play: The Microsoft® solution with the Windows® operating system facilitates setup and installation by allowing the monitor to send its capabilities (such as screen size and resolutions supported) directly to your computer, automatically optimizing display performance.

Intelligent Power Manager System: Provides innovative power-saving methods that allow the monitor to shift to a lower power consumption level when on but not in use, saving two-thirds of your monitor energy costs, reducing emissions and lowering the air conditioning costs of the workplace.

Multiple Frequency Technology: Automatically adjusts monitor to the display card's scanning frequency, thus displaying the resolution required.

FullScan Capability: Allows you to use the entire screen area in most resolutions, significantly expanding image size.

Wide Viewing Angle Technology: Allows you to be able to see the monitor from any angle (178°) from any orientation — Portrait or Landscape. Provides full 178° viewing angles either up, down, left or right.

No Touch Auto Adjust (Analog input only): Automatically adjusts the monitor to optimal settings upon initial setup.

sRGB Color Control: A new optimized color management standard which allows for color matching on computer displays and other peripherals. The sRGB, which is based on the calibrated color space, allows for optimal color representation and backward compatibility with other common color standards.

UNIFORMITY: This feature compensates for slight variations in the white uniformity level that may occur on the screen and improves the color and evens out the luminance uniformity of the display.

Response Improve: Improves gray to gray response.

Auto dimming technology: Automatically adjusts the backlight level depending on the level of ambient light.

USB 3.1 Gen 1: USB 3.1 Gen 1 hub for faster communication with the workstation, e.g. using a USB memory stick.

Troubleshooting

No picture

- Make sure the signal cable is fully connected to both the monitor and the computer.
- Make sure the computer's display card is fully seated in its slot.
- Do not use a DisplayPort converter adapter. This device is not supported.
- Make sure both the computer and monitor power switches are in the ON position.
- Make sure that a supported mode has been selected for the display card in the system being used. (Please consult display card or system manual to change graphics mode).
- Check the monitor and your display card with respect to compatibility and recommended settings.
- Check the signal cable connector for bent or pushed-in pins.
- Make sure the connected device outputs a signal to the monitor.
- If the front LED is blinking amber, check the status of the OFF MODE mode (see page 15).
- The monitor will automatically turn off by "POWER SAVE TIMER" or "OFF TIMER" function when it is working. Please turn off "POWER SAVE TIMER" or "OFF TIMER".

Power Button does not respond

- Unplug the monitor power cable from the AC outlet to turn off and reset the monitor.

Image Persistence

- Image persistence is when a residual or "ghost" image of a previous image remains visible on the screen. Unlike CRT monitors, LCD monitors' image persistence is not permanent, but constant images being displayed for a long period of time should be avoided. To alleviate image persistence, turn off the monitor for as long as the previous image was displayed. For example, if an image was on the monitor for one hour and a residual image remains, the monitor should be turned off for one hour to erase the image.

NOTE: As with all personal display devices, NEC DISPLAY SOLUTIONS recommends using a moving screen saver at regular intervals whenever the screen is idle or turning off the monitor when not in use.

Picture is discolored

- Make sure COLOR VISION EMU is OFF.
- Make sure PICTURE MODE setting is the same as ICC profile on PC.
- Set SELF COLOR CORRECTION.
- When using an analog input, display the test pattern included in the enclosed CD-ROM and then set AUTO ADJUST.
- First, use the front POWER button to turn off the monitor. Then use the POWER button turn the monitor on while holding RESET (PIP) and SELECT (INPUT) buttons at the same time. This will reset all color parameters to the factory setting. This reset will take about 10 seconds and then the factory settings screen is displayed.

Color irregularities on screen

- Reduce BRIGHTNESS.
- Set UNIFORMITY to "5".

Moving image is not smooth

- When using a DVD player or any other type of high-definition device, consult the User's Manual included with the device for detailed information on changing the signal from interlaced to progressive.
- Set RESPONSE IMPROVE to ON.

Image is flickering

- When using an analog input, display the test pattern included in the enclosed CD-ROM and set AUTO ADJUST.

Message "OUT OF RANGE" is displayed (screen is either blank or shows rough images only)

- OSD warning "OUT OF RANGE" is displayed on a rough image (pixels are missing): Either the signal clock or resolution is too high. Change the settings to a supported mode.
- OSD warning "OUT OF RANGE" is displayed on a blank screen: The signal frequency is out of range. Change the settings to a supported mode.

Image is unstable, unfocused or swimming is apparent

- Signal cable should be completely attached to the computer.
- Use the OSD Image Adjust controls to focus and adjust display by increasing or decreasing the fine adjustment. When the display mode is changed, the OSD Image Adjust settings may need to be readjusted.
- Check the monitor and your display card with respect to compatibility and recommended signal timings.
- If your text is garbled, change the video mode to non-interlaced and use 60 Hz refresh rate.

LED on monitor is not lit (*no green, blue or amber color can be seen*)

- Power Switch should be in the ON position and power cord should be connected.
- Increase LED BRIGHTNESS adjustment.

Picture is not bright

- Make sure ECO MODE and AUTO BRIGHTNESS are turned off.
- If the brightness fluctuates make sure AUTO BRIGHTNESS is turned off.
- In PICTURE MODE, set HIGH BRIGHT. See page 17.
- LCD brightness degradation occurs due to long-term usage or extreme cold conditions.
- When the display cannot achieve the desired brightness, the numerical brightness value on the OSD will blink.
- When using an HDMI input, please change "VIDEO LEVEL".

Display image is not sized properly

- Use the OSD Image Adjust controls to increase or decrease the Coarse adjustment.
- Make sure that a supported mode has been selected for the display card in the system being used. (Please consult the display card or system manual to change graphics mode).
- When using an HDMI input, please change "OVER SCAN".
- Adjust H.RESOLUTION or V.RESOLUTION in Tag5 advanced OSD menu.

No Video

- If no video is present on the screen, turn the Power button off and on again.
- Make sure the computer is not in a power-saving mode by touching the connected keyboard or the connected mouse. If you still do not see any images, please change the "OFF MODE" setting in no signal OSD (see page 22).
- When using DisplayPort, some display cards do not output video signal under low resolution modes when the monitor is turned OFF/ON or disconnected/connected from the AC power cord.
- When using an HDMI input, please change "OVER SCAN".
- When using analog inputs, please select "ANALOG DETECT" in no signal OSD. After that, select a type of analog input sync signal.
- When using analog inputs, please select "ANALOG DETECT" in no signal OSD (see page 24). After that, select a type of analog input sync signal by an appeared window.
- When using DVI input or HDMI input, please select "DIGITAL LONG CABLE" in no signal OSD (see page 20). After that, select compensation level by an appeared window.

No Sound

- Make sure the headphones are properly connected.
- Check to see if mute is activated.
- Check the volume level in the OSD menu.
- If the input signal is DisplayPort or HDMI, make sure the SOUND INPUT in the OSD menu is set to DisplayPort or HDMI.

Brightness variations over time

- Change AUTO BRIGHTNESS to OFF and then adjust the brightness.

NOTE: When AUTO BRIGHTNESS is set to ON, the monitor automatically adjusts brightness based on the environment. When the brightness of surrounding environment changes, the monitor will also change.

Self Diagnosis

- The LCD display is equipped with the ability to self diagnose abnormalities. When the LCD detects a problem, the LED on the front flashes in a pattern of long and short blinks, depending on the type of problem detected.
- If the LED signals a problem, please refer to qualified personnel for service.

USB Hub does not operate

- Make sure the USB cord is properly connected. Refer to your USB device User's Manual.
- Make sure correct upstream is selected on USB hub setting (see page 14).
- Disconnect one upstream USB cable when using 2 upstream connections.
- Turn the Power button off and on again.

Reproduced text look blurred

- Make sure that a supported resolution has been selected on the display card or system being used. If in doubt, please refer to the user's manual of the display card or system to change the resolution.

Using the Auto Brightness function

The brightness of the LCD screen can be set to increase or decrease depending on the amount of ambient light within the room. If the room is bright, the monitor becomes correspondingly bright. If the room is dim, then the monitor will dim accordingly. The purpose of this function is to make the viewing experience more comfortable to the eye in a variety of lighting conditions.

SETUP

Use the following procedures to select the Brightness Range that the monitor will use when the Auto Brightness function is activated.

1. Set the BRIGHTNESS level. This is the brightness level that the monitor will go up to when the ambient light level is highest. Select this setting when the room is at its brightest.

Select "ON" in the AUTO BRIGHTNESS menu (**Figure 1**). Then use the front buttons to move the cursor up to the BRIGHTNESS setting. Choose the desired brightness level (**Figure 2**).

2. Set the DARK level. This is the level of brightness that the monitor will go down to when the ambient light level is low. Make sure the room is at its darkest when setting this level.

Then use the front buttons to move the cursor up to the BRIGHTNESS setting. Choose the desired brightness level (**Figure 3**).

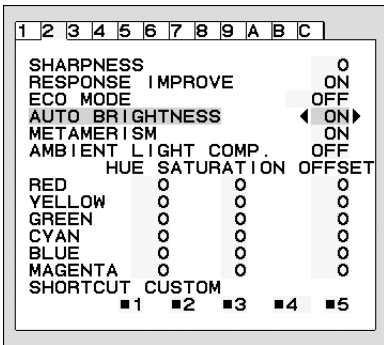

Figure 1

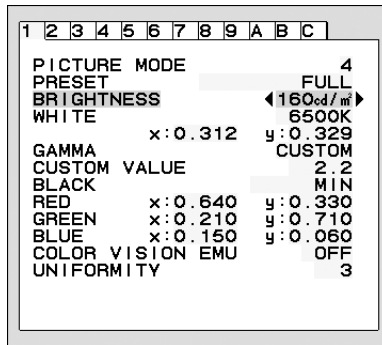

Figure 2

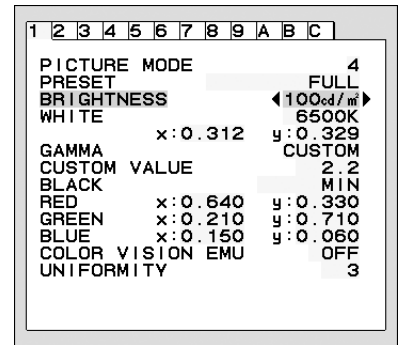

Figure 3

When the "AUTO BRIGHTNESS" function is enabled the Brightness level of the screen changes automatically according to the lighting conditions of the room (**Figure 4**).

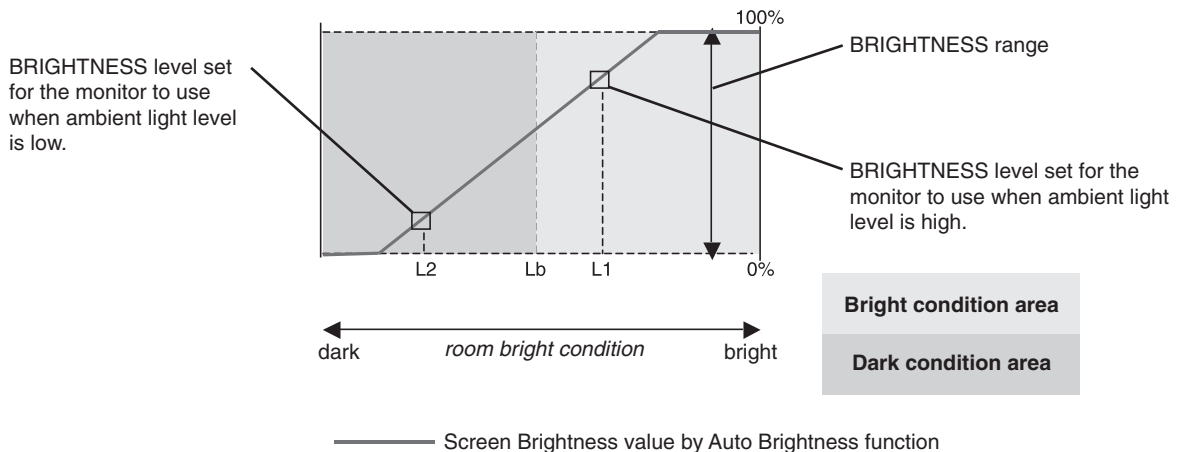

Figure 4

Lb: Border between bright and dim lighting conditions; set at factory
 L1: BRIGHTNESS level set for the monitor to use when ambient light level is high ($L1 > Lb$)
 L2: BRIGHTNESS level set for the monitor to use when ambient light level is low ($L2 < Lb$)

L1 and L2 are the brightness levels set by the user to compensate for changes in ambient light.

Manufacturer's Recycling and Energy Information

NEC DISPLAY SOLUTIONS is strongly committed to environmental protection and sees recycling as one of the company's top priorities in trying to minimize the burden placed on the environment. We are engaged in developing environmentally-friendly products, and always strive to help define and comply with the latest independent standards from agencies such as ISO (International Organisation for Standardization) and TCO (Swedish Trades Union).

Disposing of your old NEC product

The aim of recycling is to gain an environmental benefit by means of re-use, upgrading, reconditioning or reclamation of material. Dedicated recycling sites ensure that environmentally harmful components are properly handled and securely disposed. To ensure the best recycling of our products, **NEC DISPLAY SOLUTIONS offers a variety of recycling procedures** and gives advice on how to handle the product in an environmentally sensitive way, once it has reached the end of its life.

All required information concerning the disposal of the product and country-specific information on recycling facilities can be found on our following websites:

<http://www.nec-display-solutions.com/greencompany/> (in Europe),

<https://www.nec-display.com> (in Japan) or

<http://www.necdisplay.com> (in USA).

Energy Saving

This monitor features an advanced energy saving capability. When a Display Power Management signal is sent to the monitor, the Energy Saving mode is activated. The monitor enters a single Energy Saving mode.

Mode	Power consumption	LED colour
Normal Operation (Maximum Brightness)	Approx. 35 W	Green or blue
Energy Saving Mode	0.3 W	Amber
Off Mode	0.2 W	Unlit

For additional information visit:

<http://www.necdisplay.com/> (in USA)

<http://www.nec-display-solutions.com/> (in Europe)

<https://www.nec-display.com/global/index.html> (Global)

For Energy Saving information: [Default setting: OFF MODE → STANDARD]

For ErP requirement/For ErP (Network standby) requirement:

Setting: OFF MODE → STANDARD

Power consumption: 0.5 W or less.

Time for power management function: Approx. 15 min.

WEEE Mark (European Directive 2012/19/EU and amendments)



Disposing of your used product: In the European Union

EU-wide legislation as implemented in each Member State requires that used electrical and electronic products carrying the mark (left) must be disposed of separately from normal household waste. This includes monitors and electrical accessories, such as signal cables or power cords. When you dispose of such products, please follow the guidance of your local authority or ask the shop where you purchased the product, or if applicable, follow applicable legislation or agreement you may have. The mark on electrical and electronic products may only apply to the current European Union Member States.

Outside the European Union

If you wish to dispose of used electrical and electronic products outside the European Union, please contact your local authority and ask for the correct method of disposal.