

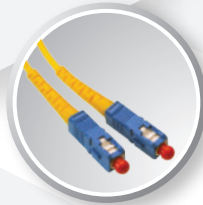

INNOVATIVE NETWORKING SOLUTIONS



Introduction

INTRODUCTION 2

About Us

ABOUT US 3

MaxiiCopper™

- COAX ETHERNET EXTENDERS 5
- COAX MIDSPANS 6
- COAX MANAGED HYBRID PoE SWITCHES 7
- UTP ETHERNET EXTENDERS 8
- UTP MIDSPANS 9
- UTP MANAGED HYBRID PoE SWITCHES 10

OmniiCopper™

- SINGLE PAIR ETHERNET & PoE EXTENDERS 11

MaxiiFiber™

- FIBER MEDIA CONVERTERS 12
- MANAGED FIBER SWITCHES 12

MaxiiNet™

- MANAGED PoE SWITCHES 13
- MANAGED INDUSTRIAL PoE SWITCHES 14
- HARDENED PoE SWITCHES 15
- DROP & INSERT 17
- ETHERNET & PoE REPEATERS 19

MaxiiPower™

- PoE MIDSPANS 20
- PoE SPLITTERS 21

ViewMate™

- IP CAMERA INSTALLATION TOOLS 22

MaxiiView™

- IP CAMERA INSTALLATION TOOLS 23

PowerMate™

- IP CAMERA INSTALLATION TOOLS 23

MaxiiPower™

- PoE ACCESSORIES 24
- POWER SUPPLIES 25

MaxiiGuard™

- IP CAMERA INSTALLATION TOOLS 23

NetObserver™

- NETWORK HEALTH MONITORING APPLICATIONS .. 28

NeTester™

- NETWORK HEALTH MONITORING APPLICATIONS .. 29

SysCap™

- SYSLOG INFORMATION CAPTURE APPLICATION ... 30

Introduction

Vigatron is leader in design and manufacturing of infrastructure transmission equipment since 1997. Our product lines have grown as the security industry has evolved to include the most complete range of networking solutions.

Vigatron is endorsed by the world's leading CCTV solution providers based on our dedication to quality, certified product performance testing, inter-operational testing with the world leading camera brands and offering the industry's longest warranty.

Performance, innovation, and reliability are the features you can rely on from the security leader in infrastructure solutions.

Symmetric Bandwidth (SBW™)

Maintains maximum bandwidth throughout specified distances for both upload and downloads.



Virtual Zero Packet Loss (VZPL™)

In network communication, information is transferred in Packets. Loss of Packets equals loss of information. Tested to RFC 2544 TCP/IP for packets sizes up to 9,000 bytes Jumbo Frames.



Pass-Through-PoE (PTP™)

Passes through the PoE power without interfering in the PSE-PD communication.



Extended Pass-Through-PoE (EPTP™)

The ability to pass 802.3af/at/bt up to 74W/90W transmitting power at extreme distances with minimal power losses.



Mega Pixel Certified (MPC™)

Testing is done to manufacturers' high-end Megapixel cameras. Vigatron products have also been tested by several IP camera manufacturers, resulting in their strong endorsements.



RFC Certified

Vigatron products are tested under RFC 2544 specifications for Packet loss, Bandwidth and Latency and the highest Jumbo frame size of 9,000 bytes, which provides the ability to transmit the largest megapixel size cameras with virtually no loss.



Hardened (HRD™)

Vigatron products are type tested for operation from -40°C to +75°C under tough NEMA-TS2 transportation testing standards.



Low Power Consumption (LPC™)

The industry's lowest power consumption, reserving needed power for PoE devices, and saving installation and operating costs.



Support Jumbo Frames (JFC™)

Jumbo Frame compatibility assures reliable full bandwidth transmission of the highest megapixel cameras with maintaining image quality at high frame rates. Vigatron products are tested up to the full jumbo frame rate of 9000 bytes.



PoE

Vigatron's PoE products provide up to 74W/90W PoE power at extended distances to cameras with PTZ, IR Illuminators, heaters and blowers, eliminating the need for any local power supplies.



Vigitron supports you in all stages of your projects

Pre-Sales: Free Infrastructure Design Services

Vigitron provides free and no obligation Infrastructure Design Services. Vigitron works closely with virtually all major IP cameras, Access Control systems, LED Lighting and Wireless Transmission manufacturers conducting intraoperative testing and uses the results in perfecting our Design Center Services in providing infrastructure designs for customer applications. Our product performance specifications are supported by extreme environmental, bandwidth and PoE certification testing.



During-Sales: Excellent Technical and Sales Support

Vigitron technical and sales teams work closely with customers to assist them to successfully implement any size infrastructure projects. We provide demo equipments to facilitate project installations and usually ship products same day that the orders are received to help expediting installations. Our extensive inter-operative testing with major IP camera brands takes the guess work out of CCTV transmission projects.



Post-Sales: Lifetime Warranty + 3 Years



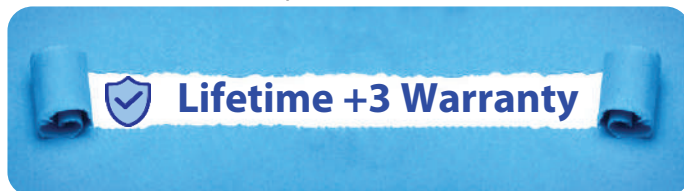



Vigitron, with over two decades of design and manufacturing experience, provides the most reliable products supported by the industry's longest warranty. Our warranty is the production lifetime plus three years to assure you of continued support, even after a product's end of life. Our lifetime warranty is free and a standard feature of our products.



Vigitron Advantages:

Feature	Vigitron
Industry's Longest Warranty	✓
Free Design Services	✓
Performance Backed by Certified Testing	✓
Highest Data Transmission	✓
Highest PoE Power Capacity	✓
Real World Product Testing	✓
IP Camera Interoperability Testing	✓

COAX ETHERNET EXTENDERS

	Model	Ports	Power Source	Function
	Vi2400A	1	12VDC or PoE	Mini Single port 10/100 Ethernet Extender w/ Pass-Through-PoE
	Vi2401A	1	12VDC or PoE	Single port 10/100 Ethernet Extender w/ Pass-Through-PoE
	Vi2400WP	1	PoE	Weatherproof (IP67) Ethernet Extender w/ Pass-Through-PoE
	Vi2404A	4	12VDC	10/100 Ethernet Extender w/ Pass-Through-PoE
	Vi2408A	8	12VDC	10/100 Ethernet Extender w/ Pass-Through-PoE
	Vi2416A	16	12VDC	10/100 Ethernet Extender w/ Pass-Through-PoE

- Extends 10BaseT up to 5,000 ft. (1,524m)
- Extends 100BaseT up to 1,800 ft. (548m)
- Provides Pass-Through-PoE up to 37W

Data & PoE Range

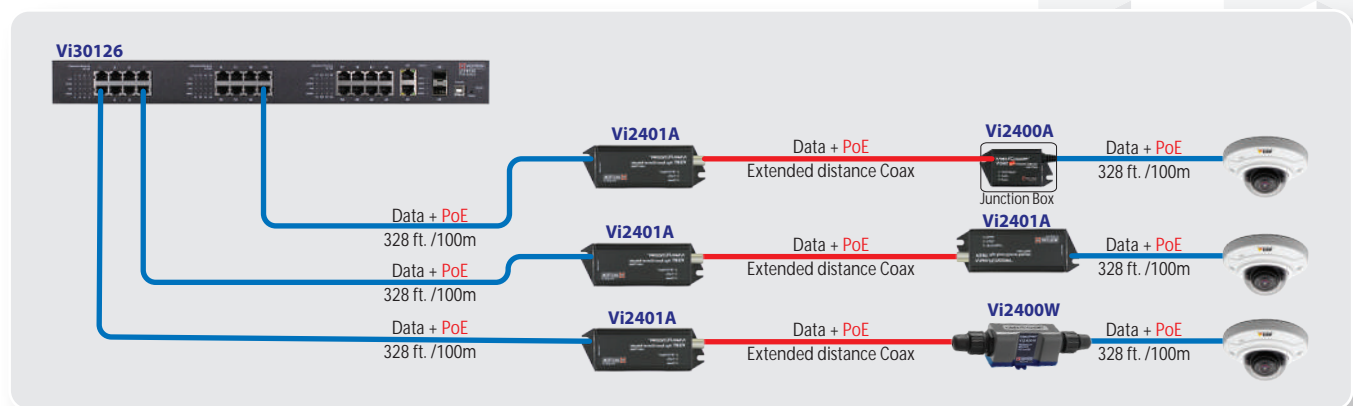
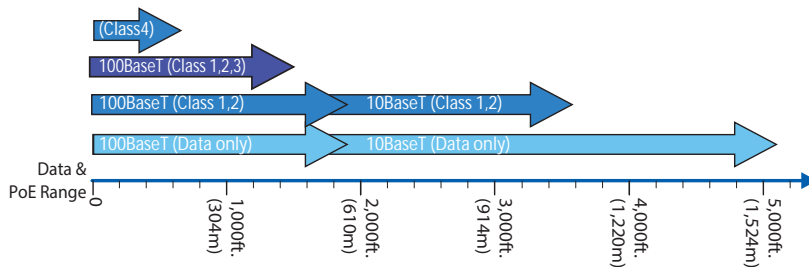





The Vi2400 series can transmit IP data with up to 37W PoE over existing coax at distances up to 1,800 feet (545m) providing a quick and cost effective method of converting analog CCTV to IP systems.

The Vi2400A Mini can fit in a common 4 inch square wiring box and J-box enclosures, making it the perfect solution for tight locations requiring security and environmental protection.

The multi-port MaxiiCopper™ Coax extenders are the ideal solution for analog systems transitioning to IP. They reduce the installation cost by using the existing coax wiring.

COAX MIDSPANS

	Model	Ports	PoE Budget	Function
	Vi2601	1	32W	Coax 10/100 Ethernet Extender w/ built-in af/at 32W PoE Midspan
	Vi3202	1	60W	Coax 10/100 Extender w/ af/at 60W PoE Midspan on UTP Port
	Vi30202U	1	60W	Coax 10/100 Extender w/ af/at/bt 60W PoE Midspan on UTP Port
	Vi2608	8	300W	Managed Coax 10/100 af/at PoE Midspan w/ 300W PoE Power Supply
	Vi2616	16	550W	Managed Coax 10/100 af/at PoE Midspan w/ 550W PoE Power Supply

- Extends 10/100 data PoE up to 3,000 ft.
- Extends 100BaseT up to 1,800 ft. (548m)
- The Vi2608/Vi2616 GUI connection are provided through USB port and Network port using Vigitron Software for maximum security protection

Data & PoE Range

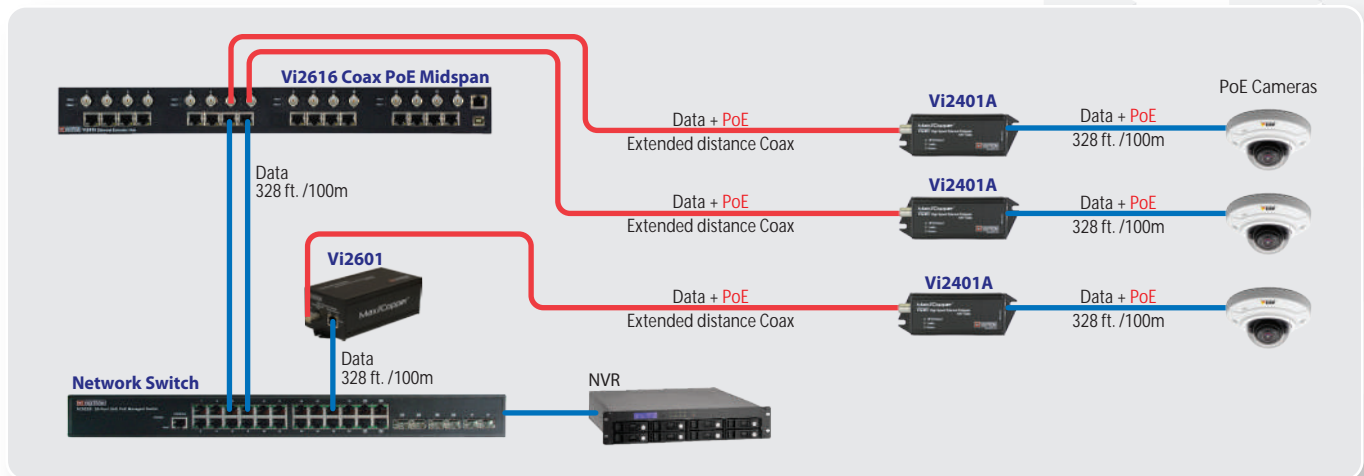
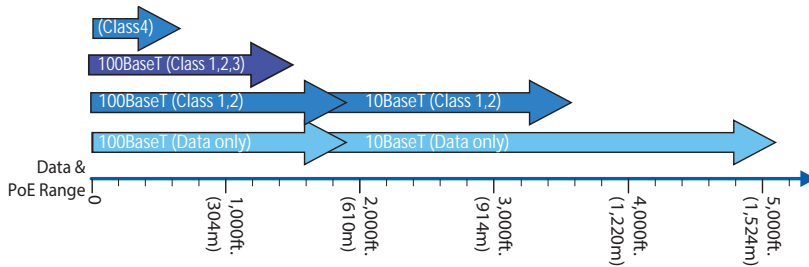

The Vi2608/Vi2616 provide PoE on up to 16 Coax ports to power Vi2401A/Vi2400As and connected PoE cameras eliminating the need for local power sources. It is a perfect solution for parking lots, loading docks and perimeter applications. The Vi2601 provides Ethernet and PoE over long distances of coax and is ideal for smaller installations.

COAX MANAGED HYBRID SWITCHES



Model	Coax Ports	UTP Ports	Function
Vi32026	8	16	L2 Managed PoE Switch, af/at 36W/72W PoE w/ 550W PoE budget
Vi32126	16	8	L2 Managed PoE Switch, af/at 36W/72W PoE w/ 550W PoE budget
Vi32226	24	N/A	L2 Managed PoE Switch, af/at 36W PoE w/ 550W PoE budget

- 24-port Layer 2, fast Ethernet + two 1G combo uplinks
- Extends 10BaseT up to 5,000 ft. (1,524m) Extends 100BaseT up to 1,800 ft. (548m).
- Provide a combination of Extended Coax ports and Standard Ethernet with PoE.
- All ports can provide up to 36W PoE and ports 17-20 can provide up to 72W PoE.*
- Reconnects automatically after data or PoE dropped connections.
- Unique SecurPort™ protects against ghosting and hacking .

* excluding Vi32226

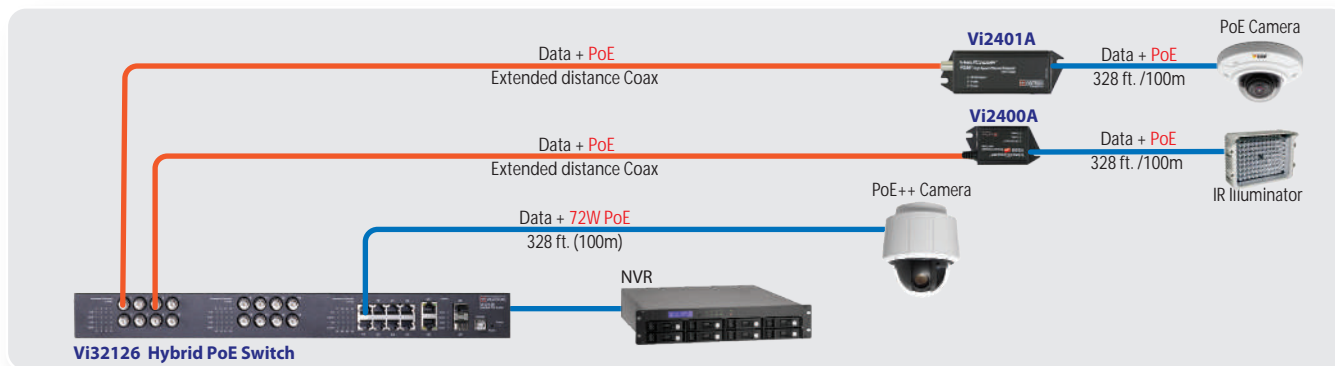



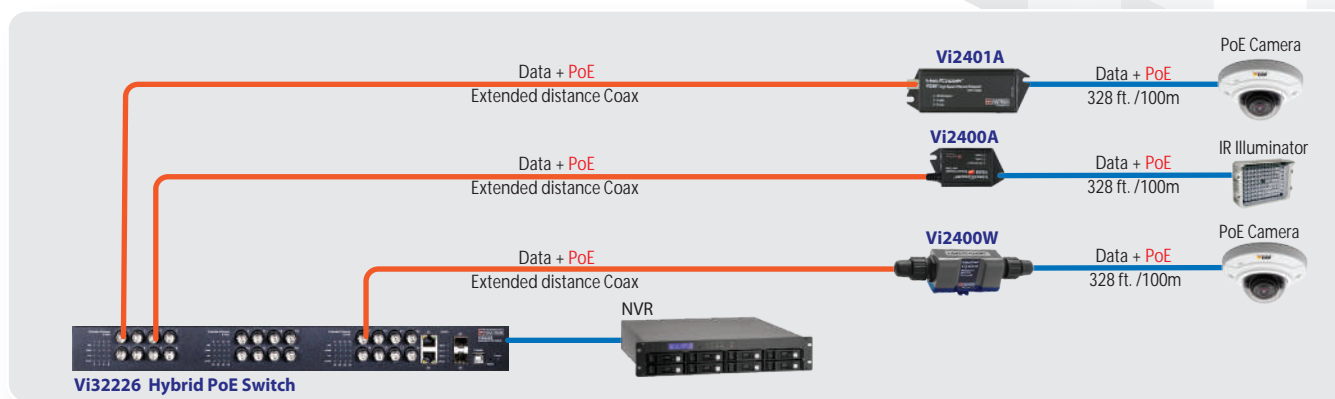



The Vi32026/Vi32126 can transmit Ethernet and PoE over Coax and UTP cables. They are cost effective and efficient in providing Ethernet and PoE for virtually any project with mixed types of cables. Ports 17-20 can provide up to 72W PoE power.



The Vi32226 is a 24-port managed PoE switch that can transmit Ethernet and PoE over Coax. They provide up to 36W PoE on each port. It is a cost effective and efficient solution for converting analog CCTV systems to IP systems.

UTP ETHERNET EXTENDERS

	Model	Ports	Power Supply	Function
	Vi2300A	1	12VDC or PoE	Mini 10/100 Ethernet Extender w/ 72W Pass-Through-PoE
	Vi2301A	1	12VDC/24VAC or PoE	10/100 Ethernet Extender w/ 72W Pass-Through-PoE
	Vi2301AU*	1	12VDC/24VAC or PoE	10/100 Ethernet Extender w/ 90W Pass-Through-PoE
	Vi2300W	1	PoE	Weatherproof (IP67) Ethernet Extender w/ 72W Pass-Through-PoE
	Vi2304A	4	12VDC	10/100 Ethernet & PoE Extender w/ 72W Pass-Through-PoE
	Vi2308A	8	12VDC	10/100 Ethernet & PoE Extender w/ 72W Pass-Through-PoE
	Vi2316A	16	12VDC	10/100 Ethernet & PoE Extender w/ 72W Pass-Through-PoE

- Extends 10BaseT up to 3,000 ft. (914m)
- Extends 100BaseT up to 2,000 ft. (609m)
- Tested and certified with major 72W/90W* PoE devices
- Plug-and-play with no set up required.

Data & PoE Range

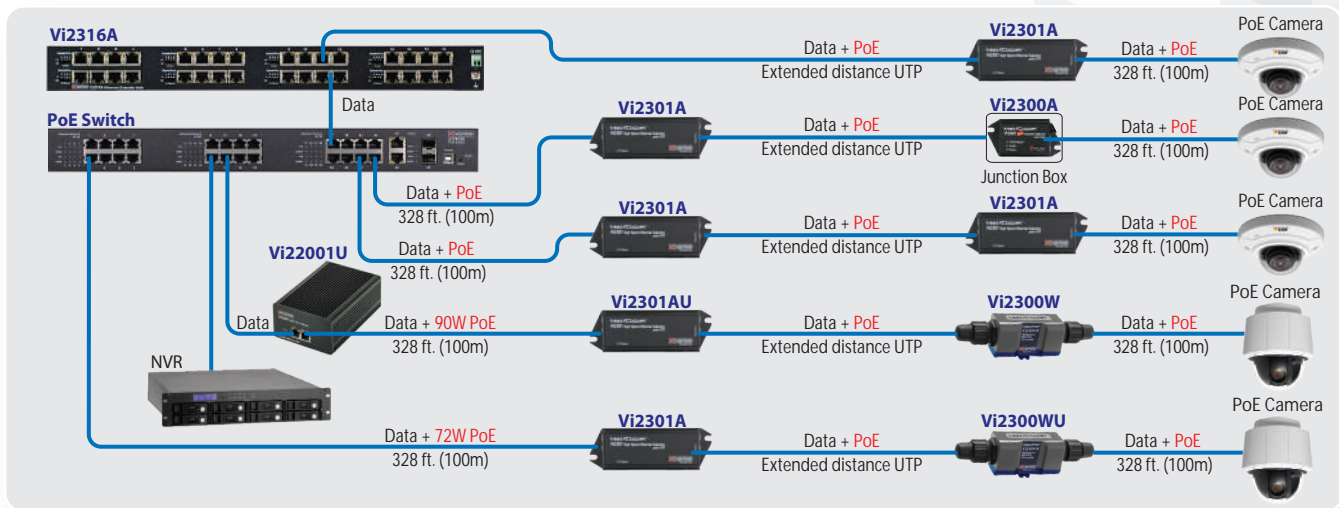
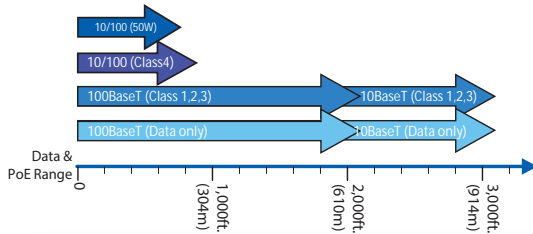





The Vi2300 series can transmit IP data and provide up to 72W PoE over extended UTP at distances up to 3,000 feet (914m) providing a cost effective method of powering, monitoring, and controlling your IP cameras

The Vi2300A Mini can fit inside a common 4 inch square wiring box and J-box enclosures, making it the perfect solution for tight locations requiring security and environmental protection.

The multi-port MaxiiCopper™ UTP extenders are ideal for larger extended distance UTP systems. The Vi230xxU models can pass through up to 90W PoE at long distances to power high power PTZ cameras.

EXTENDED UTP PoE MIDSPAN

	Model	Ports	PoE Budget	Function
	Vi2701TX	1	60W	10/100 Ethernet Extender, af/at 74W PoE (for Camera Side)
	Vi2701RX	1	60W	10/100 Ethernet Extender, af/at 74W PoE (for Control Room)
	Vi2508	8	300W	Managed 10/100 Extended UTP af/at 37/74W PoE Midspan w/ built-in 300W PoE source
	Vi2516	16	550W	Managed 10/100 Extended UTP af/at 37/74W PoE Midspan w/ built-in Power supply

- Vi25xx Provides 37W on all ports and 74W on first 4 ports
- GUI connection through USB port and Network
- Extends 10/100 data & Class-3 PoE up to 2,000 ft.

Data & PoE Range

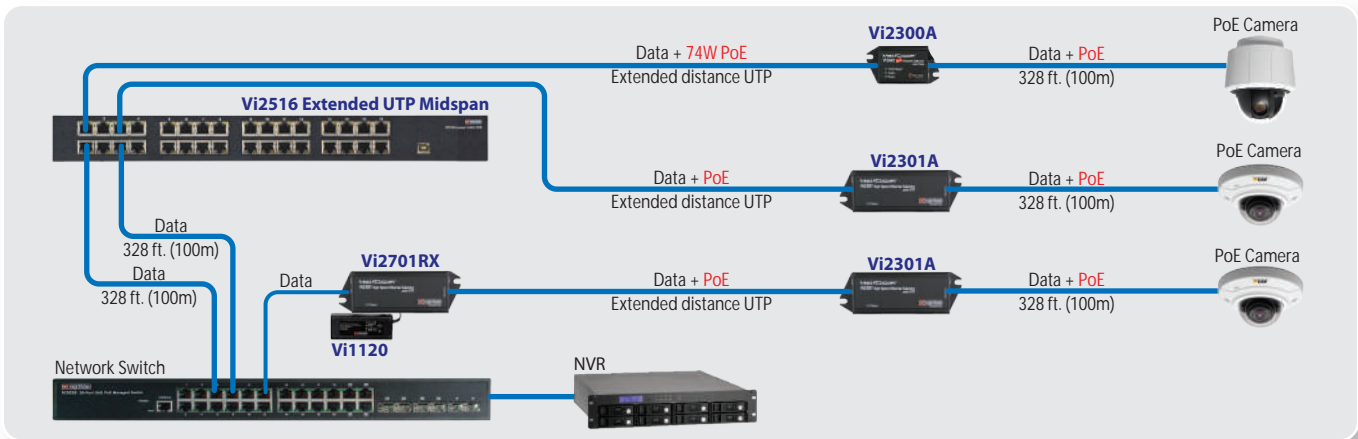
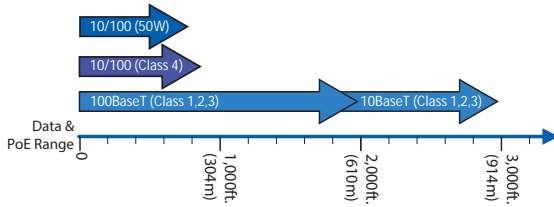

The Vi2516 provides PoE on up to 16 ports to power Vi2301A and connected PoE cameras eliminating the need for local power sources. It is an excellent solution for parking lots, loading docks and perimeter applications.

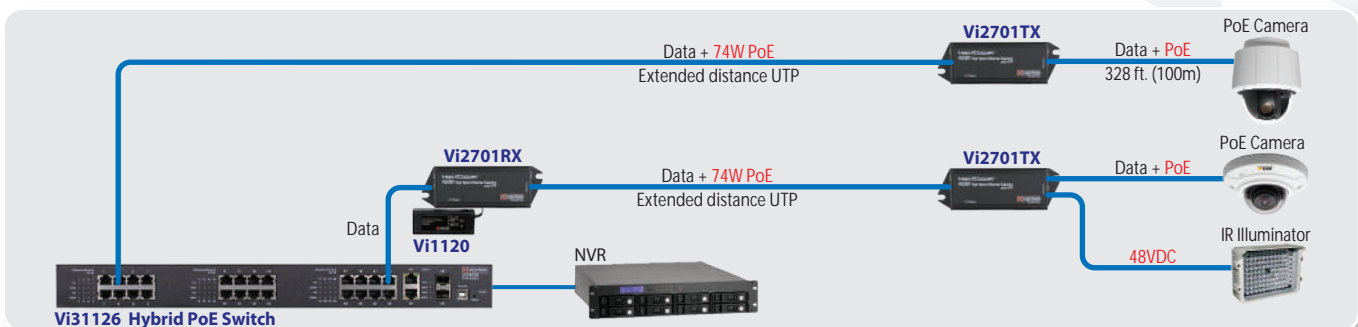

The Vi2701TX can provide IP video and PoE plus a 48VDC output to power auxiliary devices such as IR Illuminators.

EXTENDED UTP MANAGED HYBRID PoE SWITCHES



Model	Extended Ports	Standard Ports	Function
Vi31026	8	16	L2 Managed Extended and Standard UTP af/at 72W PoE Switch w/ 550W PoE budget
Vi31126	16	8	L2 Managed Extended and Standard UTP af/at 72W PoE Switch w/ 550W PoE budget

- Layer 2 High Power Managed 24-port fast Ethernet PoE Switch + two 1G combo uplinks
- Provide a combination of Extended UTP ports and Standard Ethernet with PoE
- Extends 10BaseT up to 3,000 ft. (914m) and 100BaseT up to 2,000 ft. (609m) Ethernet and PoE over long distance UTP cables
- Full PoE IEEE 802.3.af (15.4W), 802.3.at (36W) on all ports and up to 72W PoE on ports 1-4 and 17-20
- Automatically reconnects after data or PoE dropped connections
- Unique SecurPort™ protects against ghosting and hacking

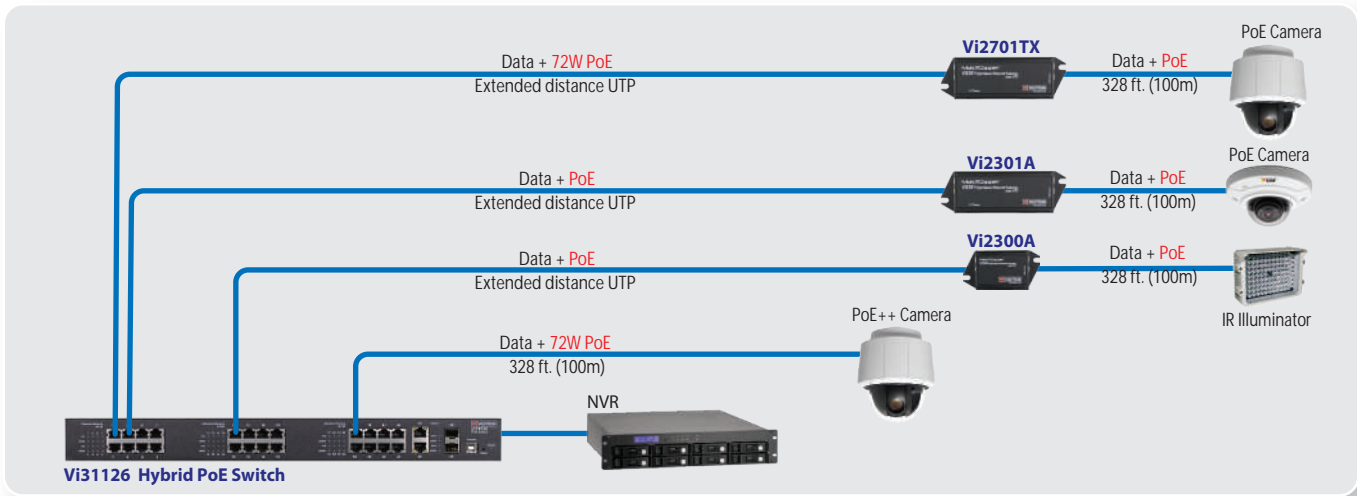

The Vi31026/Vi31126 can transmit Ethernet and PoE over standard and extended UTP cables. They are cost effective and efficient in providing Ethernet and PoE for virtually any project with new or existing extended UTP cables. Ports 1-4 and 17-20 can provide up to 72W PoE power.

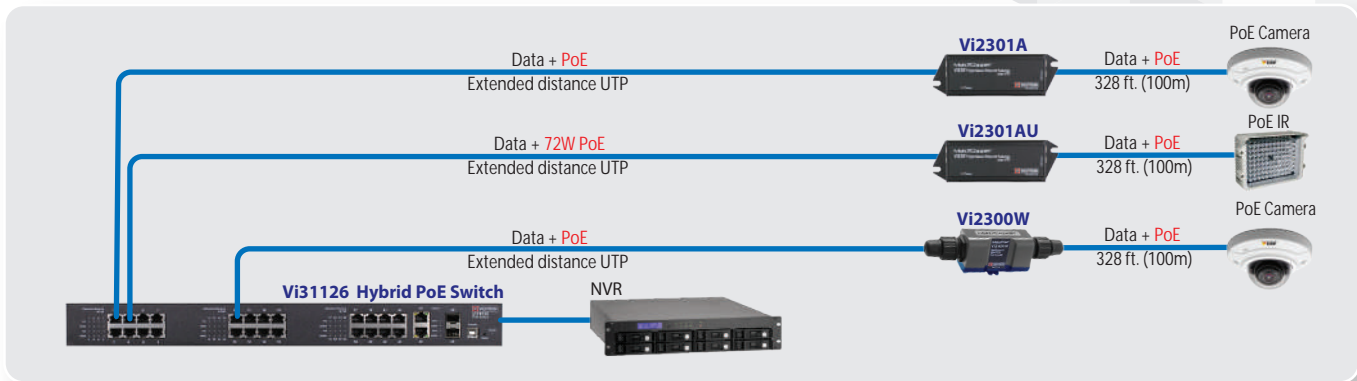

The Vi31126 is a 24-port managed Hybrid PoE switch that can transmit Ethernet and PoE over standard and extended distance UTP cables. It provides up to 36W PoE on each port and 72W PoE on ports 1-4 and 17-20. It is a cost effective and efficient solution for converting analog CCTV systems to IP or new installations.

SINGLE PAIR ETHERNET & PoE EXTENDERS



Model	Ports	Power Source	Function
Vi27000	1	48-57VDC or PoE	1-port 10/100 Ethernet & af/at 36W PoE Extender (Transmitter)
Vi27001	1	48-57VDC or PoE	1-port 10/100 Ethernet & af/at 36W PoE Extender, (Receiver)
Vi27004	4	12VDC	4-port 10/100 Ethernet & af/at 36W PoE Extender, (Receiver)

- Transmits Ethernet and PoE up to 3,000 feet (914 m) over Single-Pair Wires
- Network speeds up to 100Mbps over UTP, STP and untwisted pair wires
- Requires no switch setting or network programming
- Provides Pass-Through-PoE up to 36W
- Provides automatic Bandwidth detection

Vi27000 Series Data Rate Vs. Distance Chart

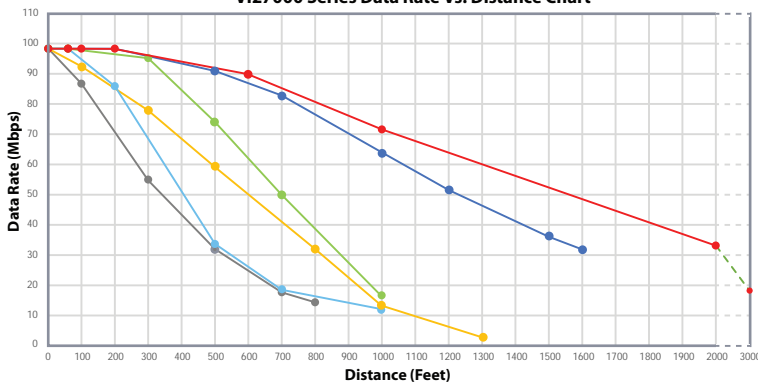

Vi27000 Series PoE Power Vs. Distance*

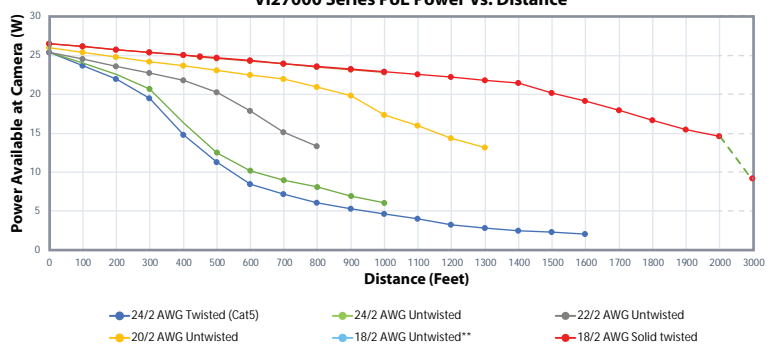

Vi30126 PoE Switch



The Vi27000 series transmitter, receiver and IP cameras can be powered by a PoE switch.

Both the Vi27001 and the Vi27000 can use local power supplies to power themselves and provide PoE to the IP cameras. Up to 4 Vi27004 Receivers can be mounted on a Vi5000R rack shelf to make a 16 port receiver.

FIBER OPTIC MANAGED SWITCHES & CONVERTERS

	Model	Function
	Vi5001	100Mbps Fiber Media convertor provides 30W PoE
	Vi5004	4-Port 100Mbps Fiber Media convertor
	Vi50004	4-Port 100/1000Mbps Fiber Media convertor
	Vi50000A	1000Mbps Fiber Media convertor provides af/at 60W PoE
	Vi50000U	1000Mbps Fiber Media convertor provides af/at/bt 60W PoE
	Vi50001	100/1000Mbps Fiber Media convertor, powered by PoE or Local power supply
	Vi00850MM-H Vi00850MMA-H Vi01310MMA-H Vi01310SM-H Vi01310SM2.5-H Vi01310G10SM-H	Multimode, 1G, 850nm SFP, up to 550m, Hardened Multimode, 1G, 850nm SFP, up to 550m, Hardened Multimode, 100M, 1310nm SFP, up to 2Km, Hardened Singlemode, 1.25G, 1310nm SFP, up to 20Km, Hardened Singlemode, 2.5G, 1310nm SFP, up to 20Km, Hardened Singlemode, 10G, 1310nm SFP, up to 20Km, Hardened
	Vi01000CH	1Gbps Copper Tranceiver SFP
	Vi35126	16-Port Fiber Optic & 8-Port L2 Managed Hybrid 100Mbps PoE Switch w/ 550W PoE
	Vi35136	36-Port L2+/L3 Lite Managed Hybrid Fiber Network Switch, 24x1G Fiber, 8x1G UTP Ports, 4x1G/2.5G/10G fiber Uplink

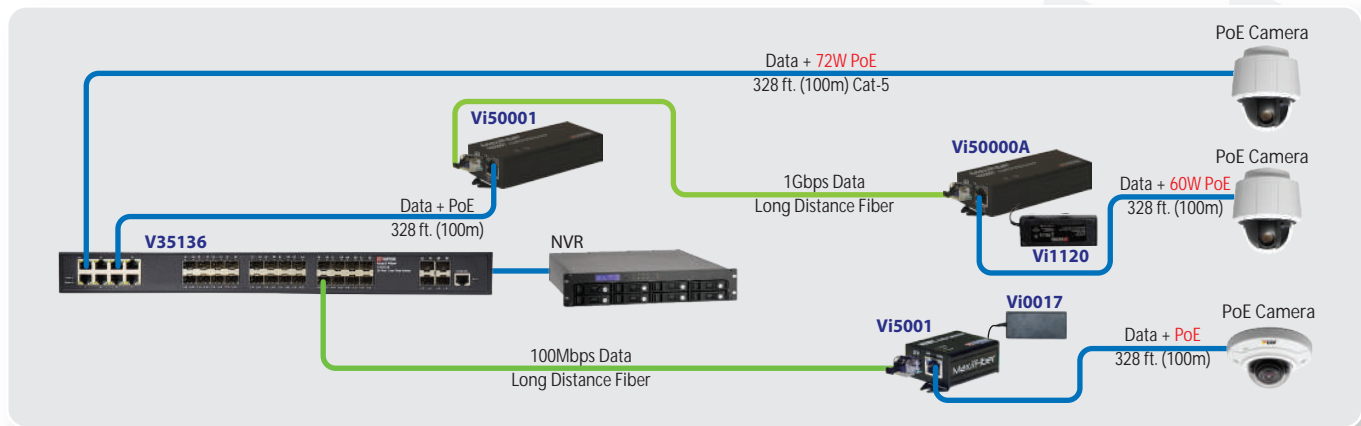



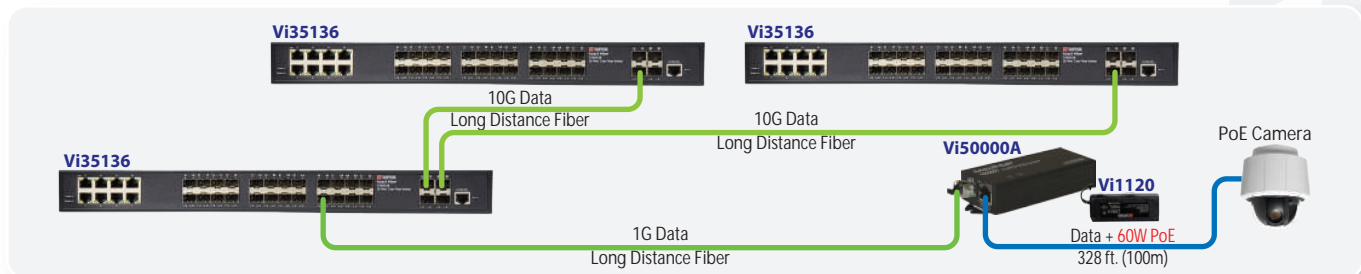

The Vi35126 Hybrid fiber switch along with Vi5001 or Vi50000A media converter transmits IP video over long distance fiber optic cables at long distances while its copper port can provide power to cameras at up to 100m.



Vi35136 can be used to combine data connections from several networks over UTP and Fiber providing 10G uplinks.

MANAGED PoE SWITCHES

	Model	Ports	PoE/ Port	Description
	Vi30110	10	36W	10/100/1G L2+/L3 Lite PoE Switch w/ 250W PoE Budget
	Vi30018	18	36W/72W	10/100 L2 Managed PoE Switch 1G Uplink, w/ 550W PoE Budget
	Vi30126	24	36W/72W	10/100 L2 Managed PoE Switch 1G Uplink, w/ 550W PoE Budget
	Vi3326	24	N/A	10/100/1G High Performance L2+ Managed Network Switch

- Layer 2+ High Power Managed PoE/Network switches
- The Vi3326/Vi30110 support Jumbo Frames up to 9600 bytes at all port speeds
- Automatically reconnects after data or PoE dropped connections
- Automatic one-step port and VLAN configuration for a wide variety of IP devices

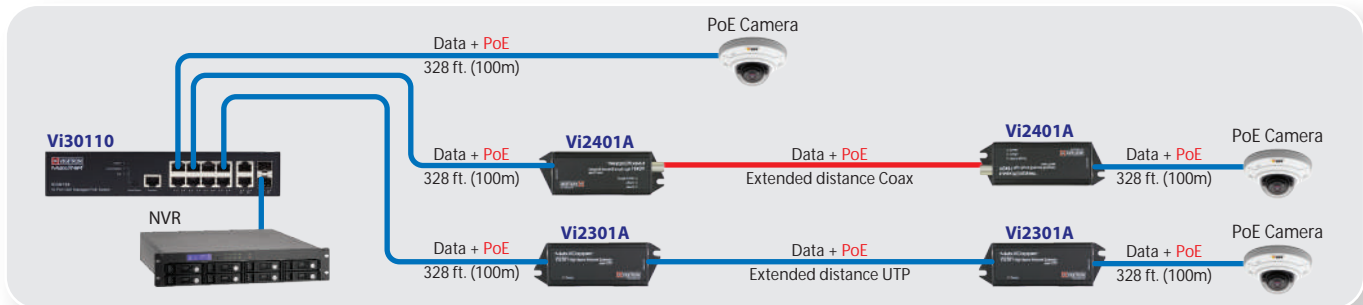

The Vi30110 is a high power PoE switch that provides eight 10/100/1G Ethernet ports plus 2x1G combo uplink ports. It is ideal for small to medium IP CCTV or IT network applications.

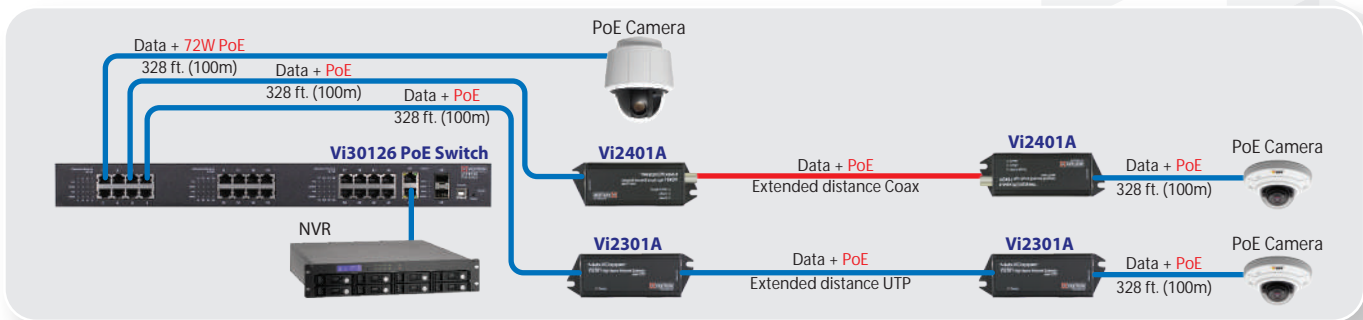

The Vi30126 Layer 2 is the ideal solution for midsize to large projects. It provides all essential and extra features needed for a reliable and successful network implementation.

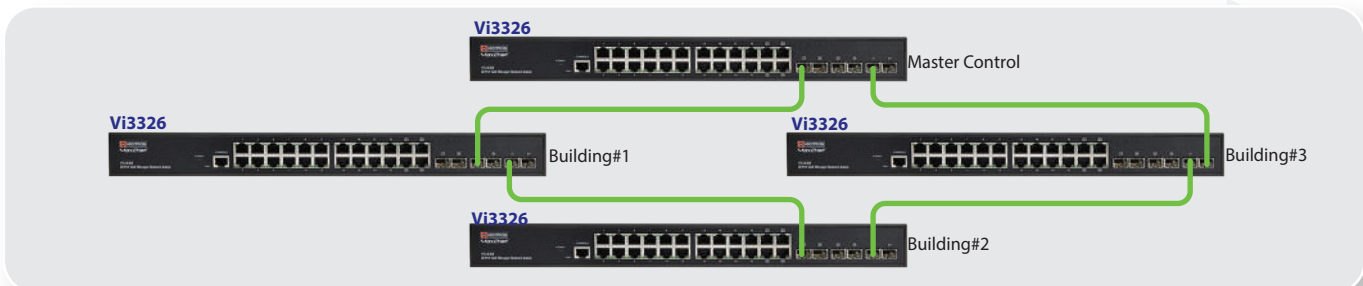

Vigtron managed switches can be connected together over long distance fiber optic cables to provide a wide area network.

MANAGED INDUSTRIAL PoE SWITCHES







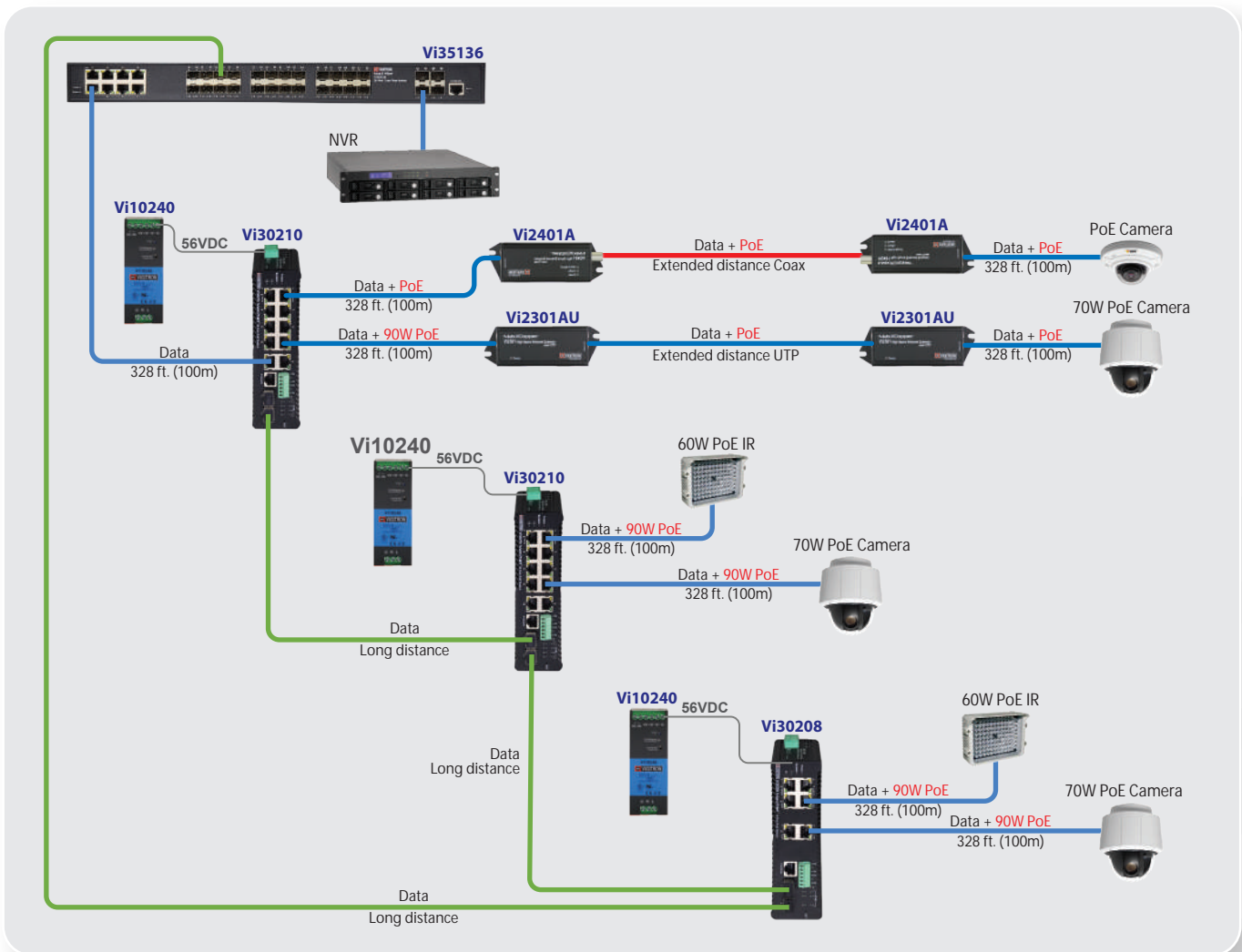

Model	Ports	PoE/ Port	Description
Vi30208	8	90W	Managed Hardened 4+2+2-Port, L2+, af/at/bt 90W PoE, 1G Industrial Ring Switch
Vi30210	12	90W	Managed Hardened 8+2-Port, L2+, af/at/bt 90W PoE, 1G Industrial Ring Switch

- Layer 2+ High Power Managed PoE Ring Network switches
- Jumbo frame programming at all bandwidth settings
- Operating temperature range -40°C to +70°C per NEMA-TS 2 standards
- G.8032 V1/V2 Rapid Ring protocol compliant
- Dual power input for back up power supply



Multiple Vi30210, Vi30208 and Vi35136 can be used in a ring network configuration to increase the reliability of the network.

HARDENED PoE SWITCHES

	Model	Ports	Uplink Ports	Function
	Vi3005	4 x UTP	1 x UTP 1 x Fiber	af/at 60W PoE Powered 10/100 PoE Switch
	Vi30005	4 x UTP	1 x UTP 1 x Fiber	af/at 60W PoE Powered 10/100/1G PoE Switch
	Vi30005W	4 x UTP	1 x UTP	af/at 60W PoE Powered 10/100/1G PoE Switch, IP67 Weatherproof
	Vi3105	4 x UTP	1 x Ext. UTP	af/at 60W PoE Powered 10/100 PoE Switch
	Vi3205	4 x UTP	1 x Coax	af/at 30W PoE Powered 10/100 PoE Switch
	Vi3305	4 x Ext. UTP	1 x UTP 1 x Fiber	af/at 36W PoE 10/100 Extended UTP PoE Switch
	Vi3405	4 x Coax	1 x UTP 1 x Fiber	af/at 36W PoE 10/100 Coax PoE Switch

- Type tested for -30°C to +75°C operating temperature range
- Automatically reconnects after data or PoE dropped connections
- Layer 2 fixed Managed PoE switches
- Each port can provide up to 36W

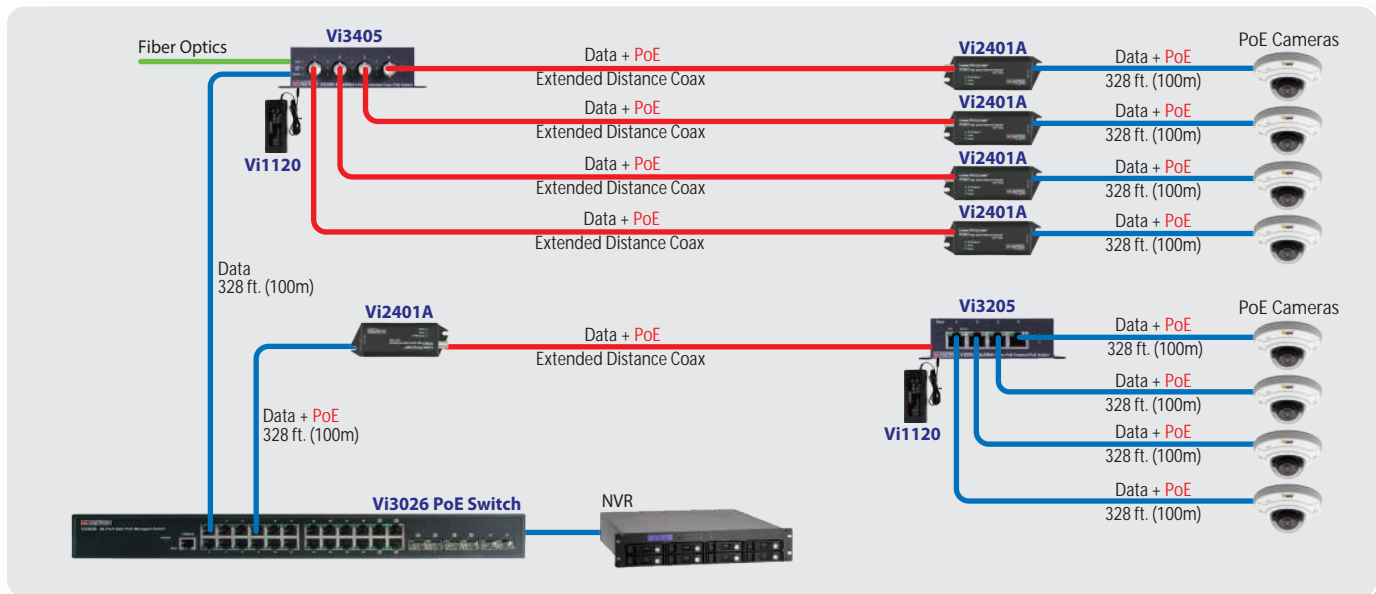

The Vigitron 5-port, layer 2, fixed management PoE switches provide flexible solutions for solving a wide variety of networking requirements.

HARDENED PoE SWITCHES

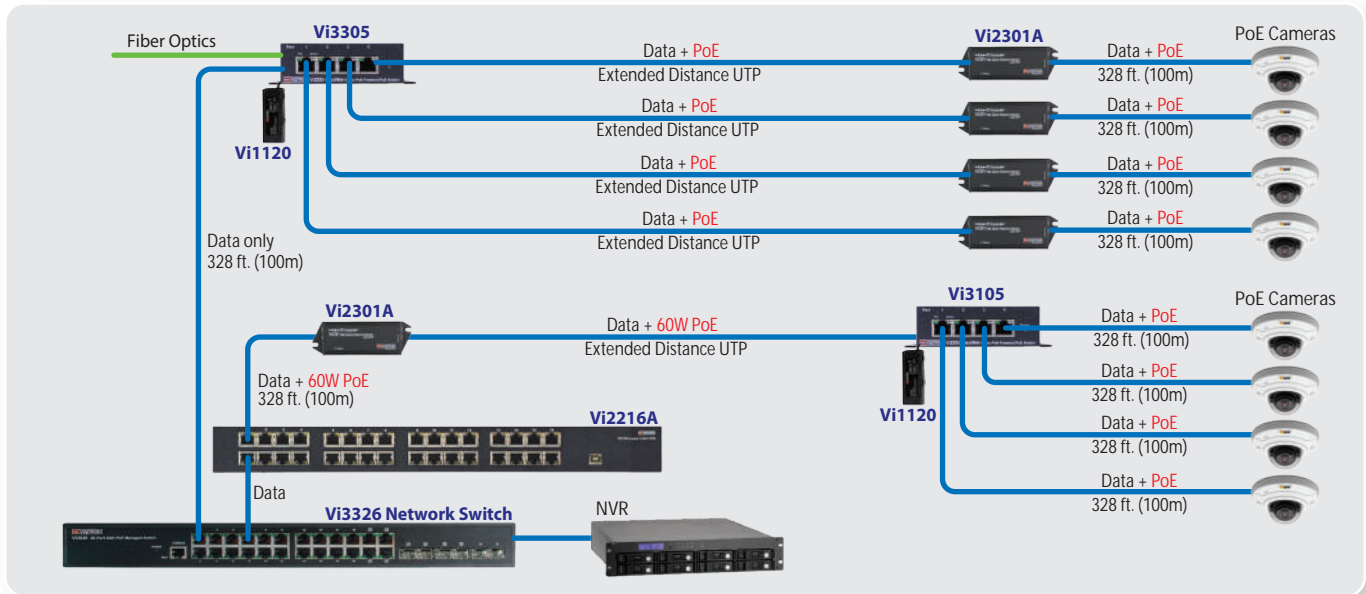

Vigitrion's Vi3305 provides 4 extended UTP ports with a combination fiber and UTP uplink. The Vi3105 provides an extended UTP uplink with the ability to power both the switch and connected devices without the need for a local power supply. Each port is capable of providing up to 37W PoE depending on the input power supply.

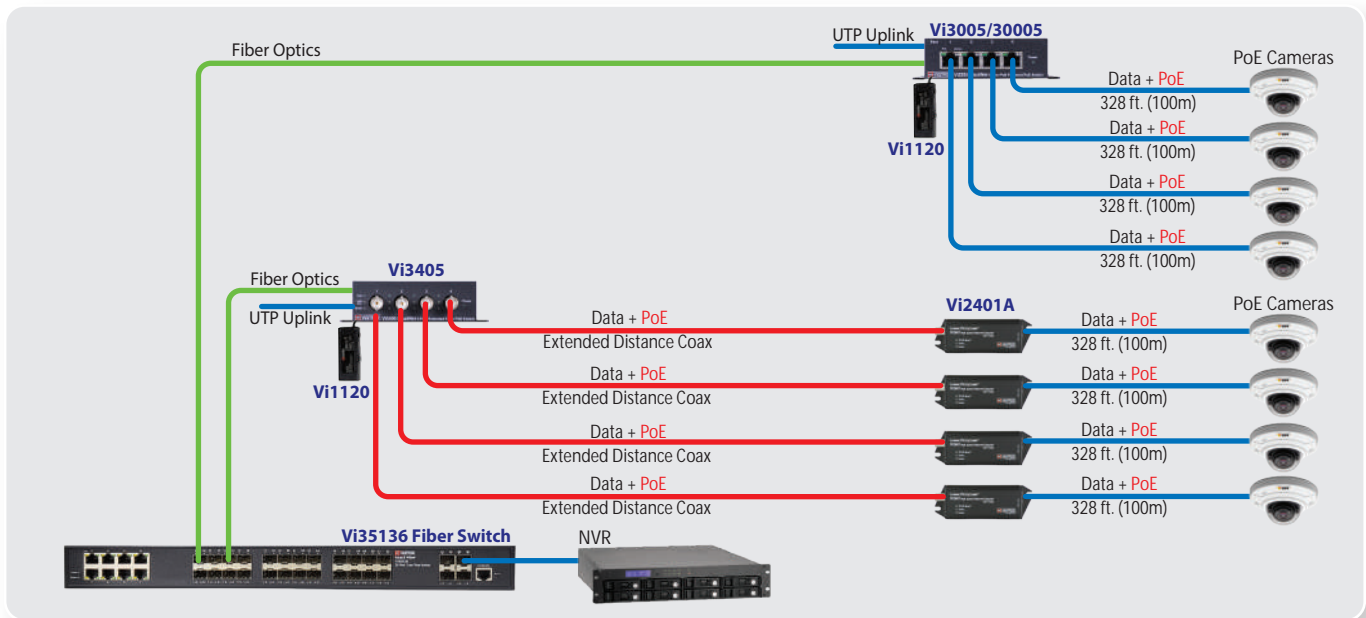







Vigitrion's Vi3005 provides 4 10/100Mbps ports with PoE to connected devices. The Vi30005 provides 1000Mbps (1G) making it the perfect solution for connecting multiple network switches to minimize headend cable runs. Both Switches can be powered locally or by PoE eliminating the need for local power supply.

The Vi3405 provides a combination fiber and UTP uplink. Using Vi1120 power supply, the Vi3405 can provide up to 36W PoE per port to the Vi2401As and cameras.

All Vigitrion hardened switches are capable of providing up to 36W PoE depending on the input power supply.

DROP & INSERT

	Model	Ports	PoE	Function
	Vi3103	3 x Copper	36W	10/100 PoE powered PoE Switch/ Drop & Insert, DC or af/at 36W PoE input
	Vi30103	3 x Copper	36W	10/100 PoE powered PoE Switch/ Drop & Insert, DC or af/at 60W PoE input
	Vi3003	3 x Copper	36W/ 60W	10/100/1G af/at 60W PoE powered PoE Switch / Drop&Insert
	Vi3003WP	3 x Copper	36W/ 60W	10/100/1G af/at 60W PoE powered PoE Switch / Drop&Insert, IP67 Weatherproof
	Vi3004	2 x Fiber 2 x Copper	30W/ 60W	10/100/1G af/at 30W/60W PoE Switch / Drop&Insert, 100/240VAC Input
	Vi3004LV	2 x Fiber 2 x Copper	60W	10/100/1G af/at 60W PoE Switch / Drop&Insert, 24VDC/24VAC Input

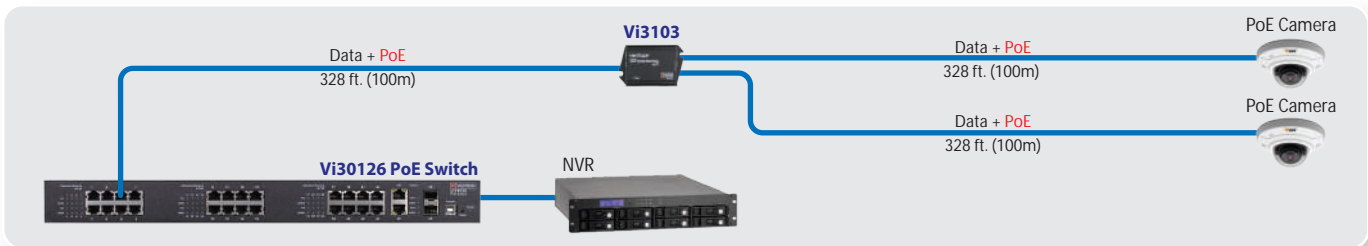

The Vi3103 is a 3-port PoE powered PoE switch that can be used to add an extra camera without new wiring or used as a drop and insert. It can be powered by PoE or a local power supply and provide up to 36W per port.



The Vi3003 enables 1G connection between network switches eliminating the need for using fiber optics.

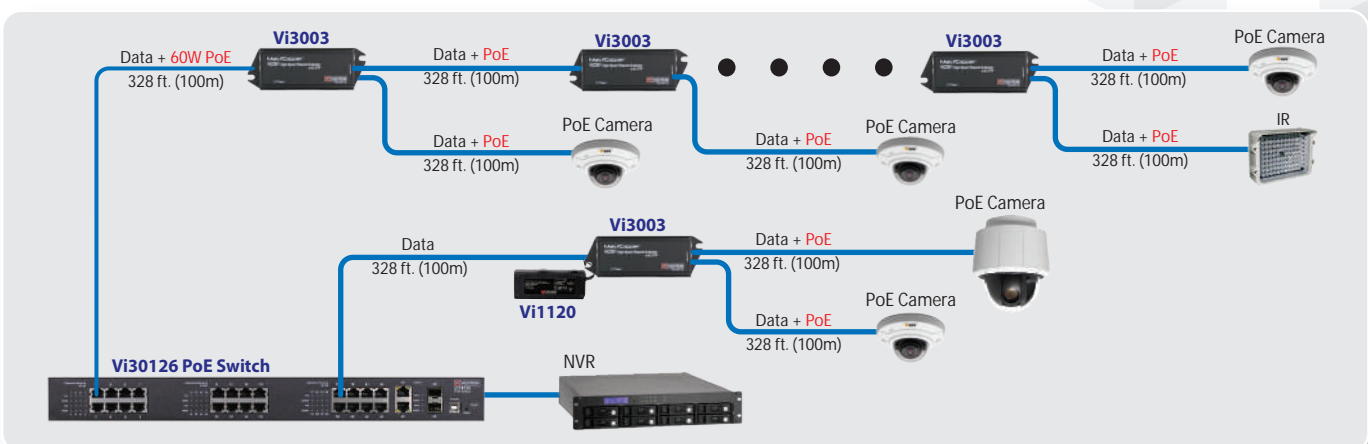

The Vi3003 is both a repeater and an L2 3-port network switch providing drop and insert capability. It can be powered by PoE or local power supply and provides up to 60W on one port and 36W on another port at 1000 Mbps. A local power supply can be used for powering 60W PTZ dome cameras.

DROP & INSERT

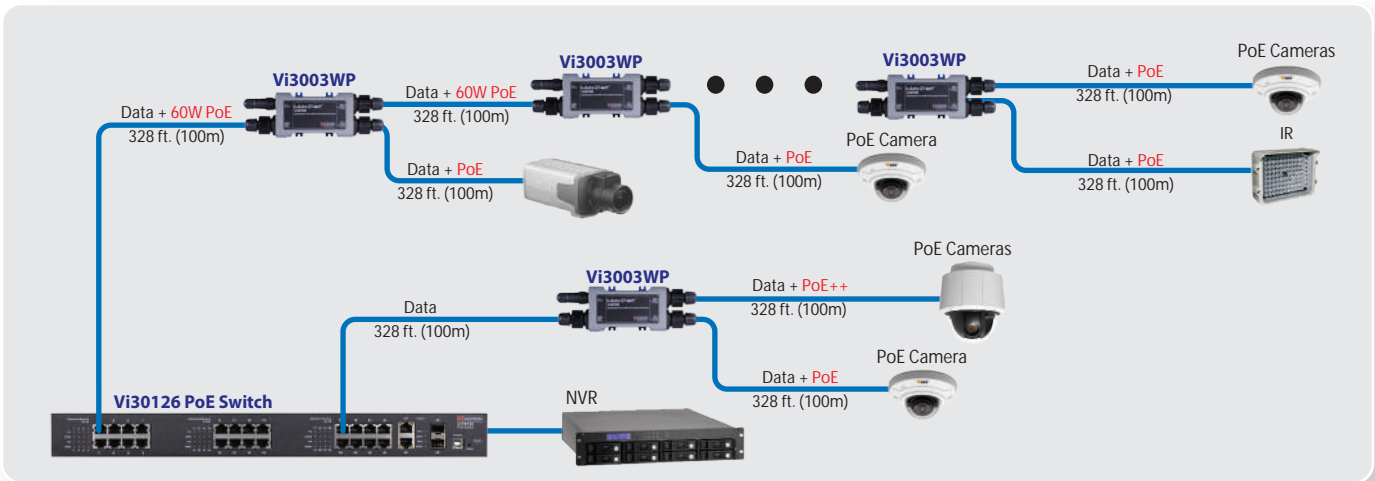

The Vi3003WP is both a repeater and L2 3-port network switch providing drop and insert capability. It can be powered locally or from a power source and provide up to 60W to one camera at network speeds of 1000 Mbps.

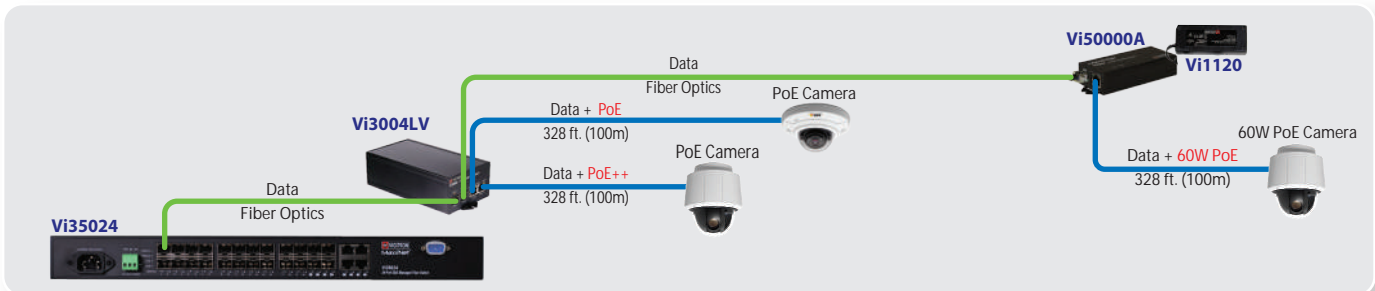

The Vi3004LV can provide up to 60W PoE to high power cameras while transmitting data at long distances over fiber optics.

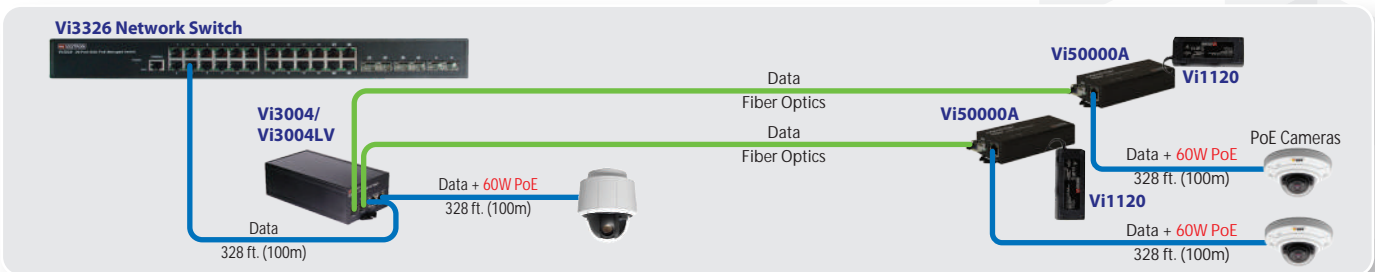



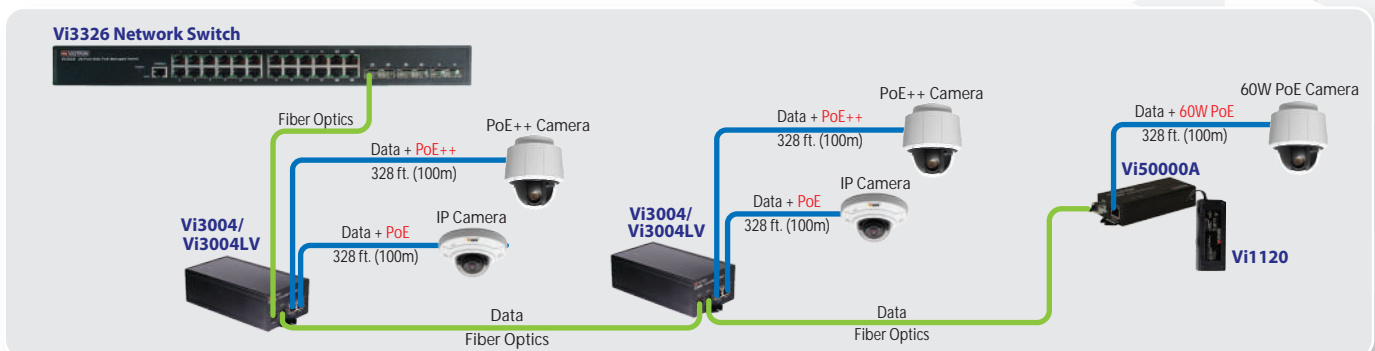

With Layer 2 network capacity, the Vi3004LV can be used to connect multiple cameras over Cat 5e/Cat 6 or fiber optics cables.



The Vi3004LV can provide up to 60W PoE on one port and 30W PoE on the second port. Their L2 network switching provide multiple drops over single cable runs and simplify installations. The Vi3004LV can use 24VDC or 24VAC power supplies.

ETHERNET & PoE REPEATERS

	Model	Ports	Data (Mbps)	Description
	Vi3602	36W	10/100/1G	Ethernet and af/at 36W PoE Repeater Powered by PoE or local Power
	Vi30602	90W	10/100/1G	Ethernet and af/at/bt 90W PoE Repeater Powered by PoE
	Vi3002	60W	10/100	Ethernet & af/at 60W PoE Repeater Powered by PoE
	Vi30002U	90W	10/100	Ethernet & af/at/bt 90W PoE Repeater Powered by PoE
	Vi3002WP	60W	10/100	Weatherproof Ethernet & af/at 60W PoE Repeater Powered by PoE



The Vi3602 can connect 2 network switches at distances up to 656 feet (200m) at 1000Mbps.

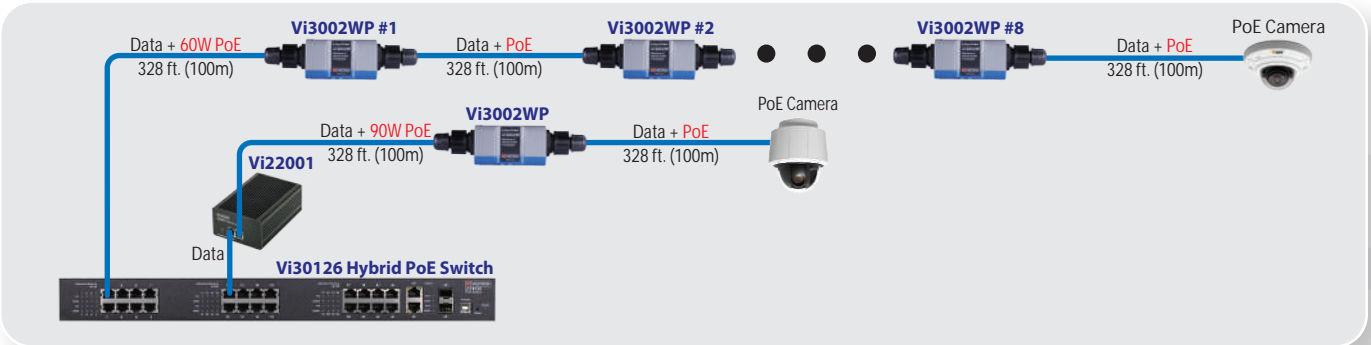



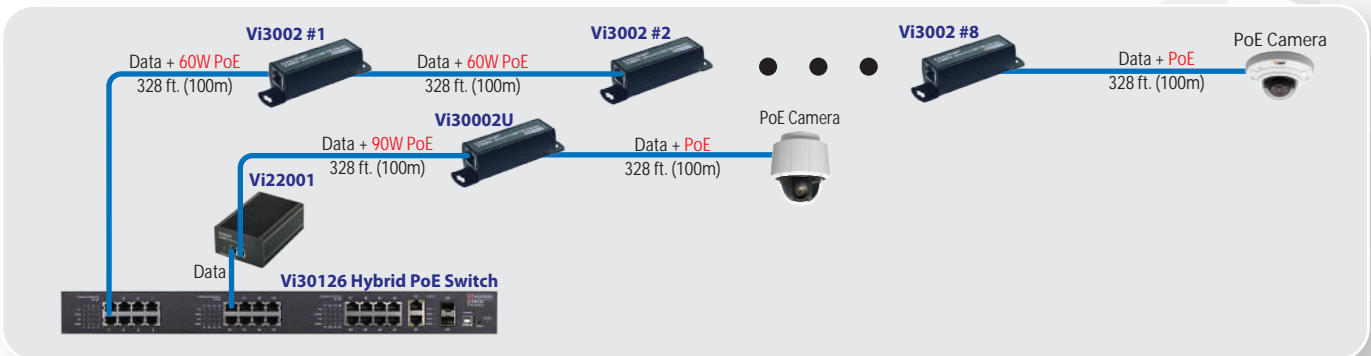



The Vi3002W/Vi30002WP complies with IP67 standards eliminating the need for an extra outdoor housing. Their unique enclosure can easily be mounted to beams, buildings, or poles. Multiple Vi3002W/Vi30002WPs, up to 8 units, can be used outdoor to extend Ethernet and PoE at desired distances.



Multiple Vi3002/Vi30002Us, up to 8 units, can be cascaded to extend Ethernet and PoE at desired distances.

MANAGED & UNMANAGED PoE MIDSPANS

	Model	Ports	PoE Budget	Description
	Vi2201	1	30W	Unmanaged af/at 30W PoE Midspan
	Vi22401 Vi22401U	1 1	60W 60W	Unmanaged af/at 60W Midspan IEEE 802.3. af/at/bt 60W Midspan
	Vi22001 Vi22001U	1 1	90W 90W	Unmanaged af/at 90W Midspan Unmanaged af/at/bt 90W Midspan
	Vi22501	1	30W <i>(w/ External PS)</i>	Unmanaged af/at 30W PoE Midspan 12-54VDC Input
	Vi22601	1	60W <i>(w/ External PS)</i>	Unmanaged af/at 60W PoE Midspan 12-54VDC Input
	Vi2208A	8	300W	Managed af/at 37/74W Midspan
	Vi2216A	16	550W	Managed af/at 37/74W Midspan

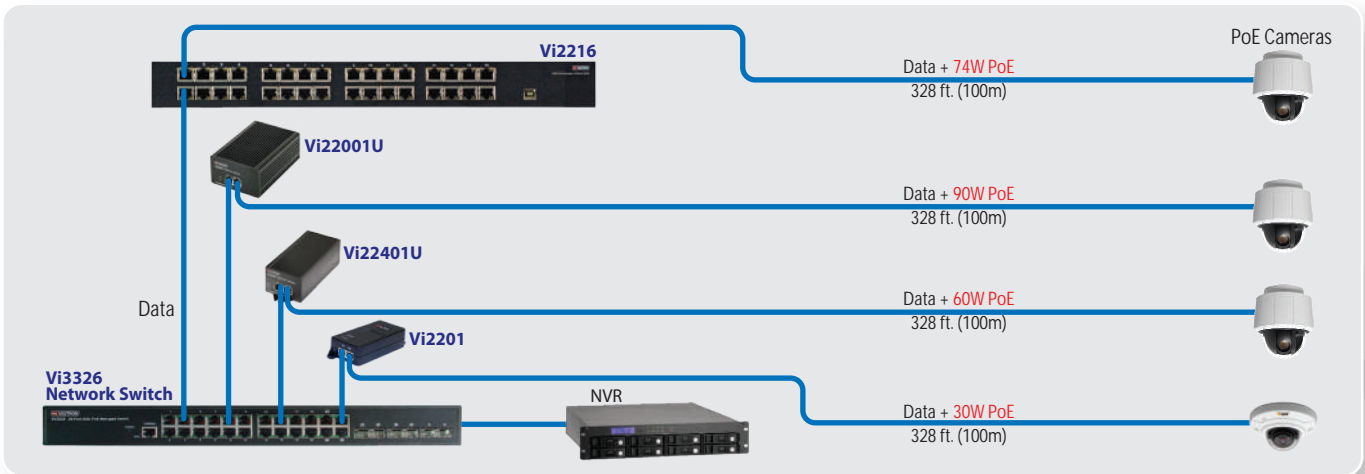

Vigtron's wide range of managed and unmanaged PoE Midspans can support virtually any size IP CCTV project requiring IEEE 802.3af to IEEE 802.3bt up to 90W PoE power.





The Vi22xx includes Vi2200 V1 management software that runs on PCs. They offer several key features including:

- Allowing the Midspans to be set up, operated and monitored remotely
- Monitor up to 400 ports from multiple Midspans
- Built in SNMP and Email notification services



The Vi22601 is a compact and high power Midspan with 12-54VDC input that can provide PoE up to 60W for a wide variety of high power applications.

PoE SPLITTERS

	Model	Output Voltage	Output Power	Function
	Vi22101	12VDC	12.95W	IEEE802.3af (12.95W) PoE Splitter with 12VDC Output
	Vi22201	12/24VDC	25W	IEEE802.3af/at (25W) PoE Splitter with 12/24VDC Output
	Vi22301	12/24VDC	60W	60W PoE Splitter with 30W 12/24VDC Output
	Vi2701TX	48VDC	60W	60W PoE and Ethernet Extender & Splitter (for Camera Side)

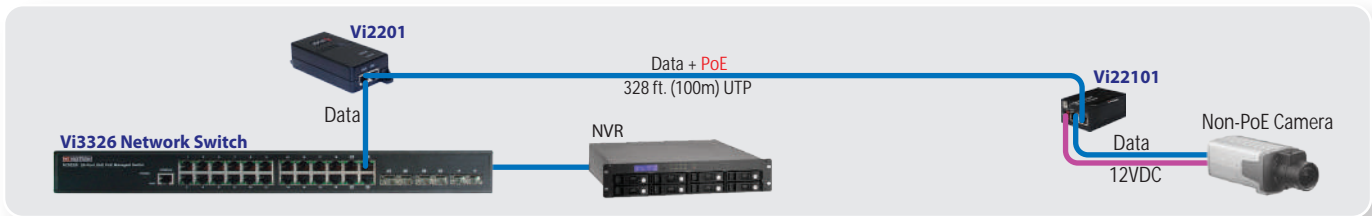

The Vi22101 is a compact and low cost PoE splitter that can provide up to 12.95W at 12VDC power to non-PoE cameras.

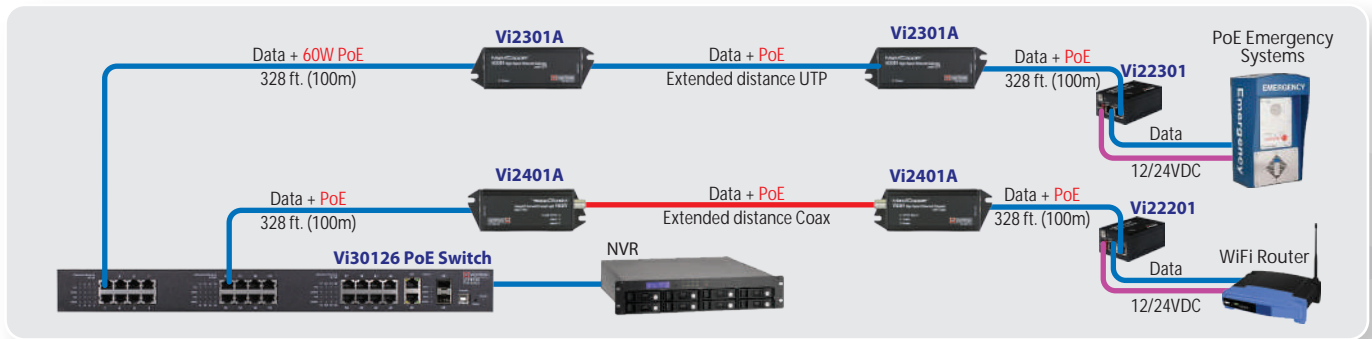



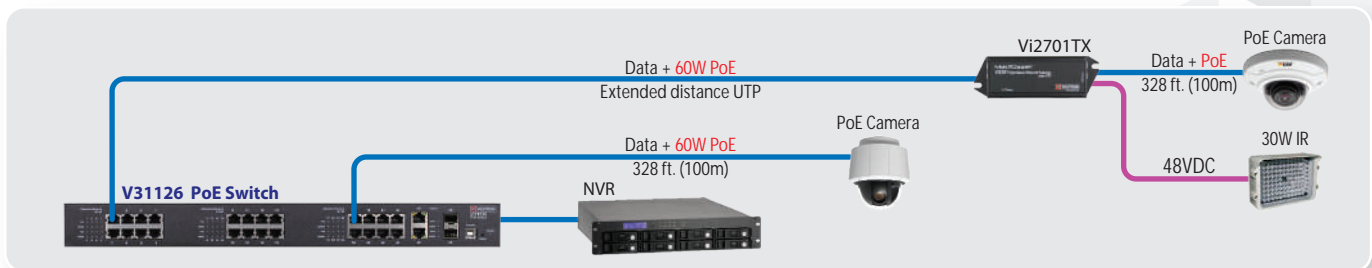

The Vi22201 and Vi22301 can be used along with Vigitrn's Vi2300 or Vi2400 extender series to provide 12VDC or 24VDC at the remote locations to power non-PoE IP cameras or other IP devices requiring DC power input.



The Vi2701TX is capable of accepting 60W PoE input at long distances and eliminate the need for local power supplies. It can provide PoE output to the cameras as well as DC voltage to accessories.

IP CAMERA INSTALLATION TOOLS

	Model	Description
	Vi0019	60W PoE Camera Setup Tool
	Vi0021	30W wired IP Camera Setup & PoE Test Tool
	Vi00021U	60W wired IP Camera Setup & PoE Test Tool
	Vi00022	30W wireless IP Camera Setup & PoE Test Tool

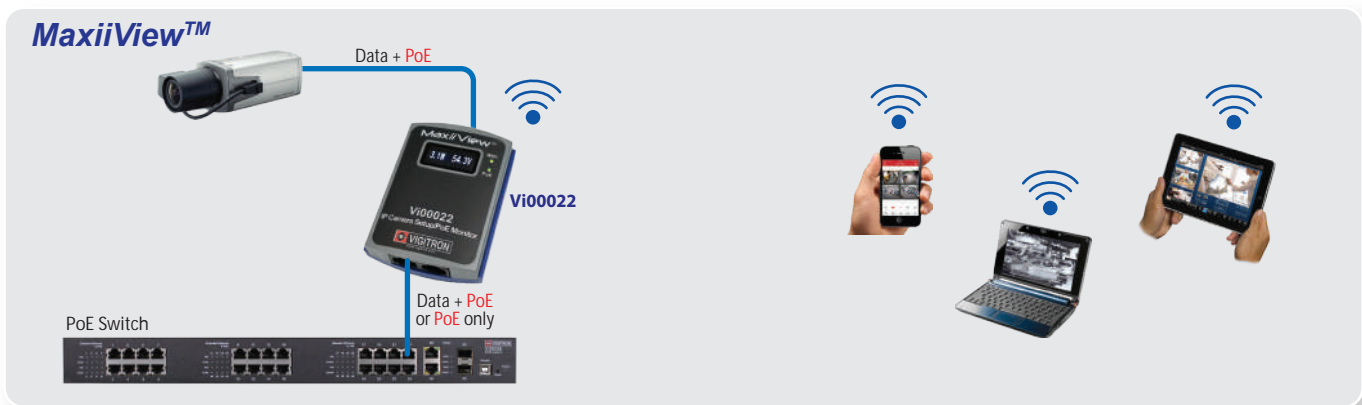

The Vi00022 is a wireless and wired PoE camera set up tool that provides PoE from a network to the camera while transmitting the video stream from the camera to WiFi devices. It enables the installer to view the camera image on a wide variety of wireless devices and set up the camera. It displays PoE voltage and power to the camera on its digital display. It can be used to troubleshoot PoE output power and cable connections and save valuable installation time by pinpointing the specific problem areas. The Vi00022 uses PoE and does not require a separate power supply.



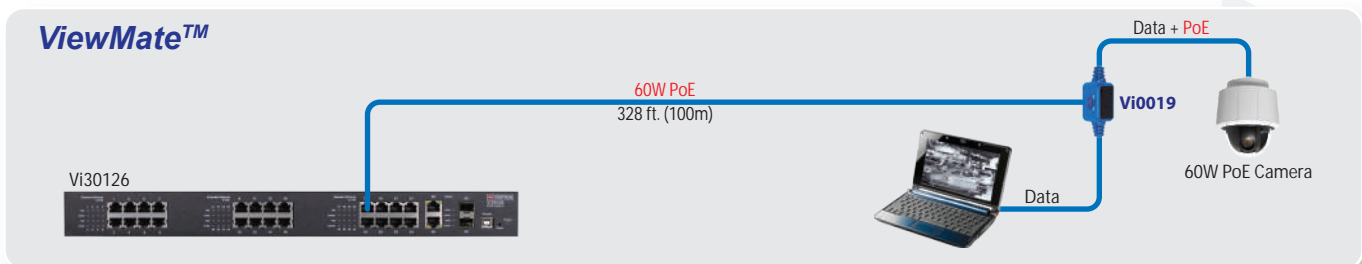

The Vi0021 is a wired PoE camera set up tool that provides PoE from a network to the camera while directing the video stream from the camera to a laptop. It enables the installer to view the image and set up the camera. It displays PoE voltage and power to the camera on its digital display. It can be used to troubleshoot PoE output power and cable connections and save valuable installation time by identifying the specific problem areas. The Vi0019, Vi0021, Vi00021U, Vi00022 uses PoE and do not require a separate power supply.



The Vi0019 is a wired PoE camera set up tool that provides PoE from a network to the camera while directing the video stream from the camera to a laptop. It enables the installer to see the image and set up the camera. It can pass through up to 60W PoE and also provides LED indicators that show the status of PoE. The Vi0019 uses PoE and does not require a separate power supply.

IP CAMERA INSTALLATION TOOLS

	Model	Description
	Vi00023	Wireless IP Camera Installation Tool w/ Removable PoE Power Bank
	Vi00023L	Wireless IP Camera Installation Tool w/ PoE Power Bank
	Vi00024	PoE Maximum Load Meter af/at/bt & UpoE Compatible w/ Voltage & Power Monitor
	Vi00027	PoE Type Test Tool

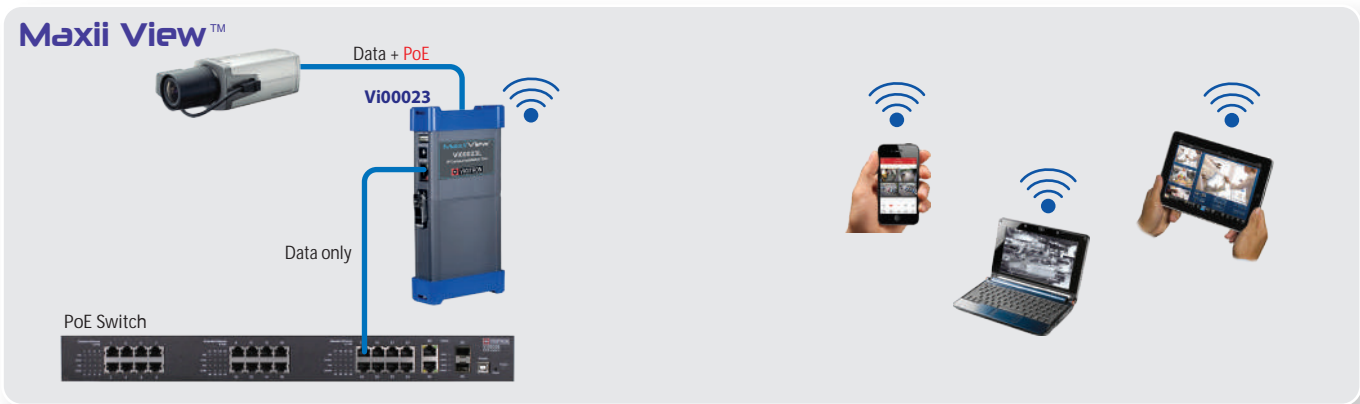

Vigtron's patent pending Vi00023/Vi00023L wireless camera installation tools offer a fast and reliable method for focusing and adjusting the view of IP cameras in the field. The connected IP camera image is transmitted through both WiFi and wired connection allowing for quick in-field view of image on cell phones, tablets or laptops. They provide PoE to connected IP cameras and display PoE voltage and power consumed by the camera. They are very compact, light and can easily fit in a pocket. The Vi00023 provides a removable power bank.





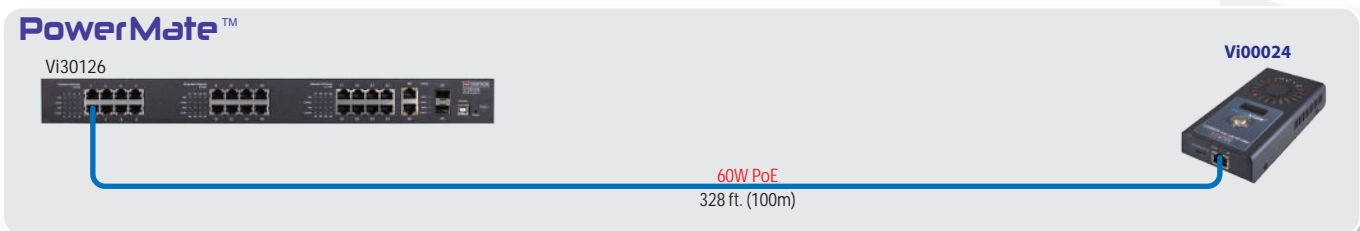

The Vi00023/Vi00023L, in addition to WiFi connection, can provide wired connection between IP cameras and laptops. They provide PoE power to the camera and transmit camera image to the laptop.

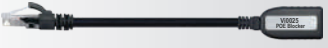

The Vi00024 simulates a PoE powered device and measures the maximum available PoE at any point of a networks before installing a camera. It is compliant with IEEE 802.3af/at/bt standard up to 74W. The Vi00024 operates in both Manual and Auto mode. In manual mode the user can manually increase the PoE consumption of the Vi00024 until it reaches the maximum available PoE. In the auto mode, the Vi00024 with the push one bottom can measure maximum available PoE in a few seconds.

PoE Accessories

	Model	Description
	Vi0024	PoE Enabler to power extenders when using with non-PoE devices
	Vi0025	Blocks PoE power to Connected IP Devices
	Vi00026	PoE Class changer
	Vi00104	PoE Booster
	Vi00103	NetMux™ Ethernet & PoE Port Multiplexer

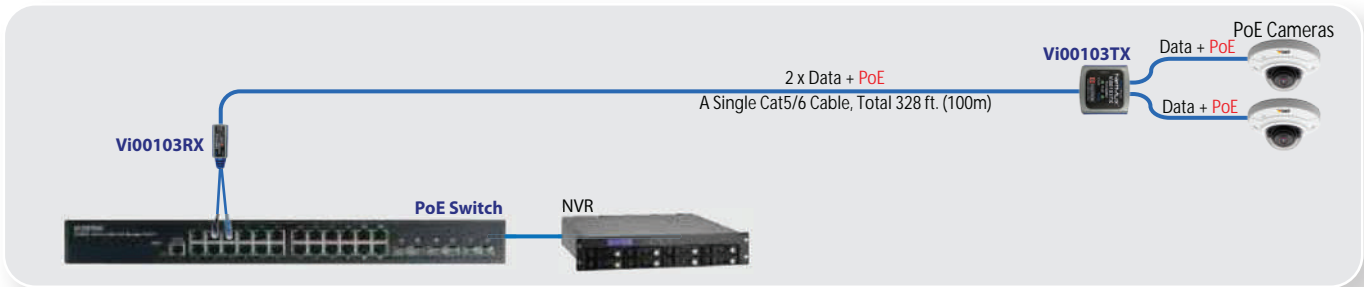

The Vi00103 can transmit 2 IP streams and PoE over a single Cat5e/6.

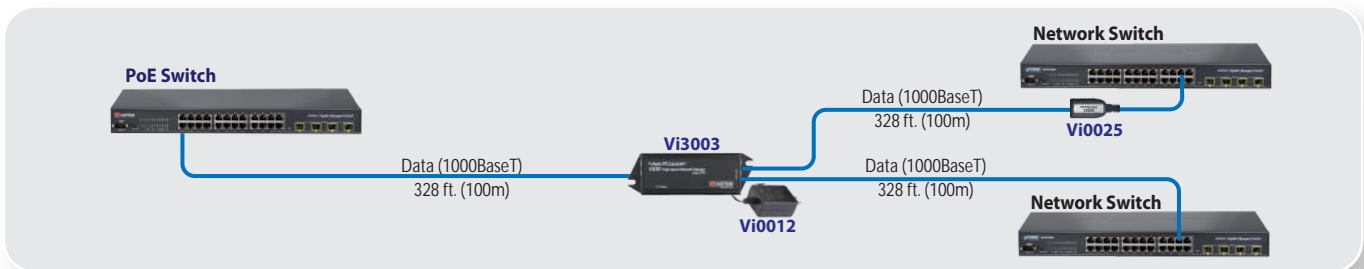

The Vi0025 blocks PoE when “Always On” PoE ports are connected to non-PoE ports.

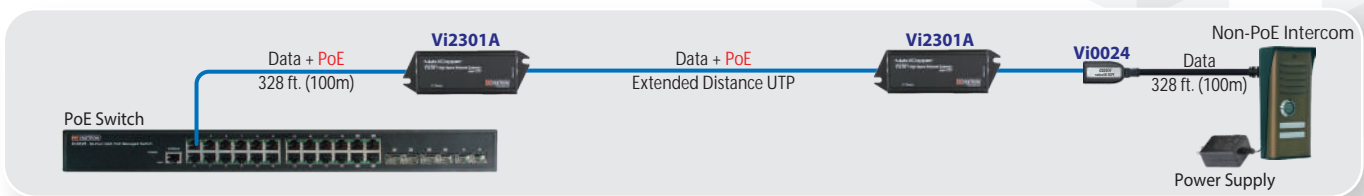

The Vi0024 enables PoE to Ethernet extenders when using with non-PoE devices.

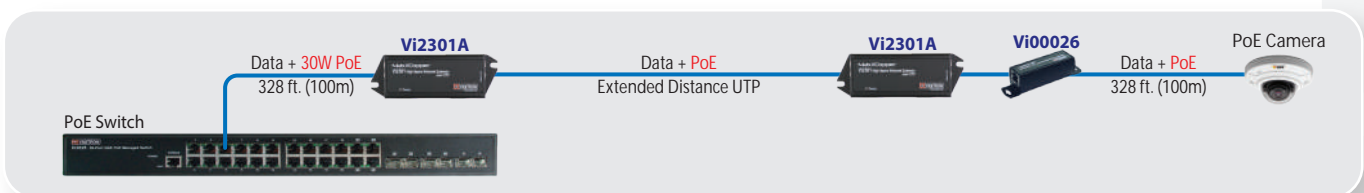

The Vi00026 requests maximum IEEE 802.3at, at 30W from the PoE source regardless of the connected PoE load power request level. It makes it possible to force the PoE source to provide extra power when the system is using extenders at long distances.

POWER SUPPLIES

	Model	Description
	Vi0012	12VDC, 12W Wall-Mount Power Supply
	Vi0014	12VDC, 36W Wall-Mount Power Supply
	Vi0017	48VDC, 40W Desktop Power Supply
	Vi1120	56VDC, 120W Desktop Power Supply
	Vi10120*	56VDC, 120W Din-Rail, Hardened Power Supply
	Vi10240*	56VDC, 240W Din-Rail, Hardened Power Supply
	Vi10480*	56VDC, 480W Din-Rail, Hardened Power Supply

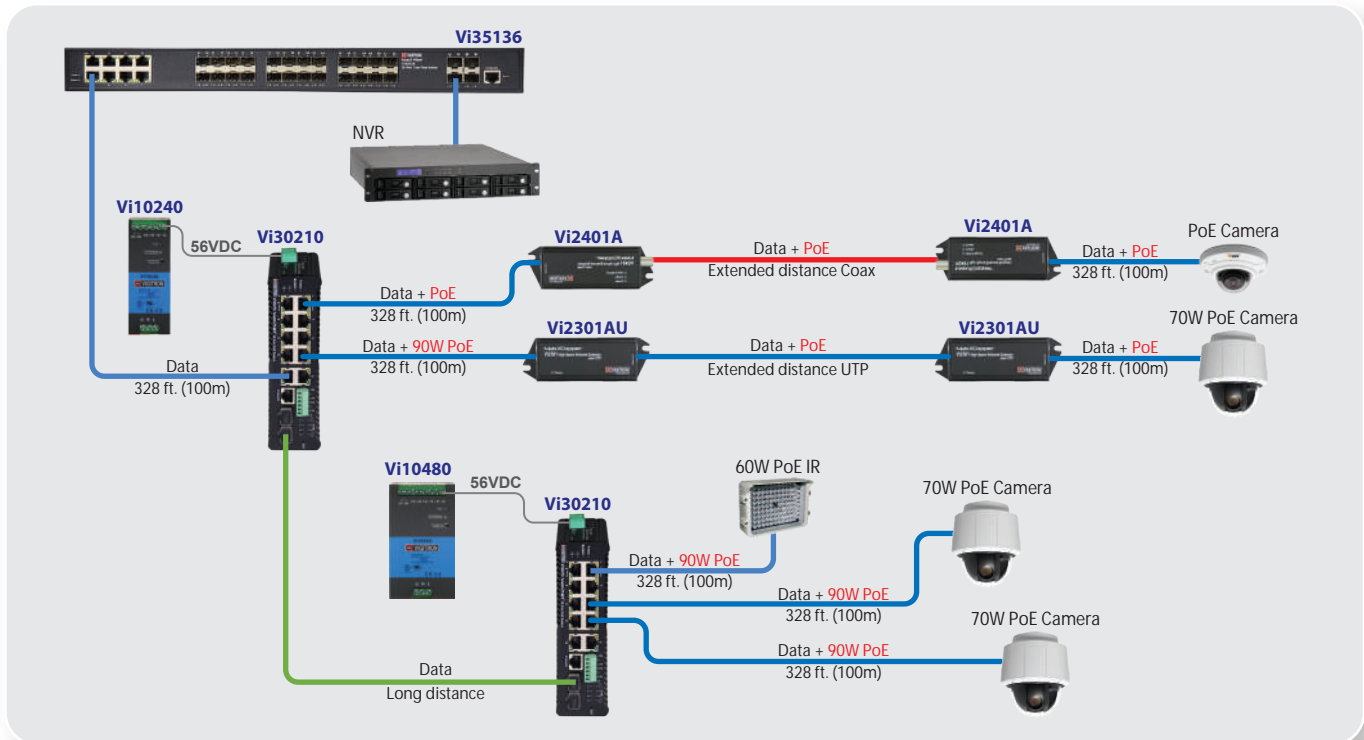

The Vi10120, Vi10240 and Vi10480 can be used to power high PoE devices.

SURGE PROTECTORS



Model	Description
Vi2001	Standard/Extended Ethernet Port Surge Protector



Network Switch



IP Camera

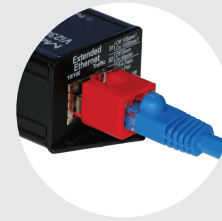

60W PoE Extender

The Vi2001 is an in-line surge protector providing up to 15KV in free space and 8KV contact to ground protection. It is compact and does not require a separate ground wire.

MOUNTING ADAPTERS



Model	Description
Vi00100	Din Rail Mount for Vi1120
Vi00101	Din Rail Mount for Vi3005, Vi3105, Vi3205 5-port Switches
Vi00102	Din Rail Mount for Vi30005, Vi3305, Vi3405 5-port Switches
Vi5000B	Fiber Media convertor blank panel
Vi5000R	Fiber Media convertor Rack Mounting Kit

The Vigitron Mounting adapters enables products be rack mounted or DIN Rail mounted.

NETWORK HEALTH MONITORING APPLICATION

NetObserver™ is a Windows™ based health monitoring database software. It receives status messages from up to 240,000 connected devices using SNMP, TCP, UDP and Syslog resulting in an almost universal interface.



NetObserver™
Vi3000 V1

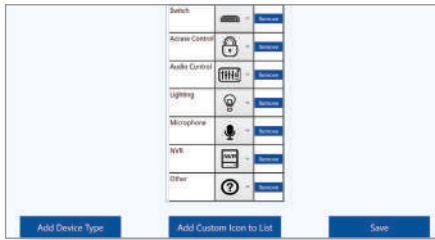

- Icons can be used to note types of devices and custom icons can be loaded. Operator can create custom names and messaging.

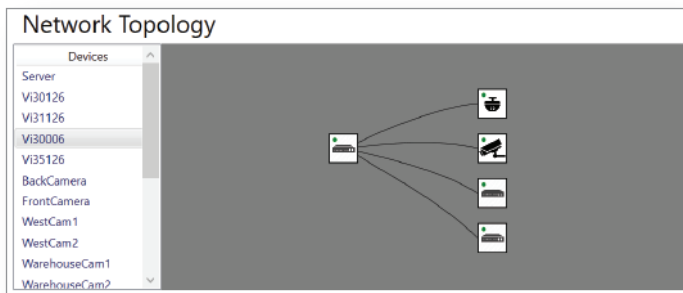

- Topographical maps can be created to show connections and status of individual devices.

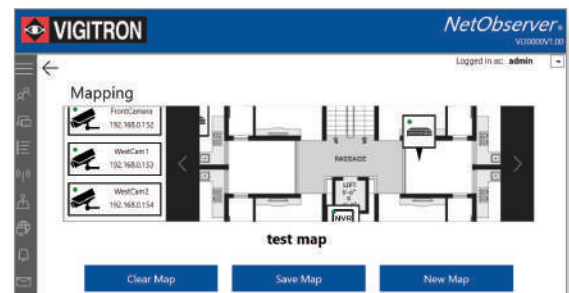

- Maps can be uploaded with devices positioned showing operating status.

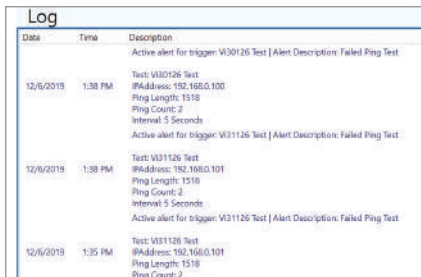

- Custom filtering creates logs which can be further filtered and downloaded as .CSV and .TXT files.

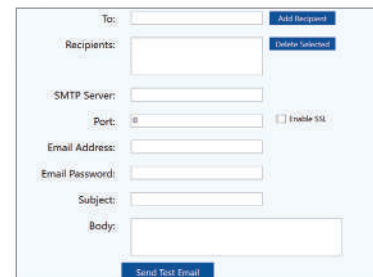

- A built in email generator sends operator customized alerts via public and private emails.

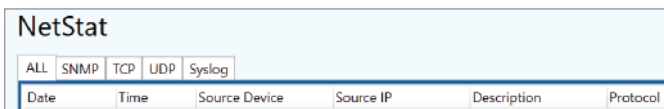

- Messaging, names can be customized to notify operators to a variety of network alerts and status helping to decrease troubleshooting time and maintaining network operations.

Please visit Vigitron's website at www.vigitron.com to see all NetObserver's features and download a Free Run version.

NETWORK HEALTH MONITORING APPLICATION

NeTester™ is a Windows™ based tool for evaluating networks prior to installation, to determine if it meets the performance requirement for its application. After installation is completed, a complete report can be provided to both dealers and customers in three different formats. In the event after installation service is required installation reports can be combined to service call status helping to easily pinpointing and solving problems.



NeTester™
Vi30001 V1

New Report

Report
Report Number: 1234 Technician Name: Sam Installation

Service Provider
Company Name: Company Name
Company Phone: 111-222-3333
Company Address: State USA
Contact Email: sam@email.com
Contact Number: 222-333-4444

Customer
Customer Name: Sam
Customer Phone: 333-444-5555
Customer Address: State USA
Contact Email: sam@email.com
Contact Number: 444-555-6666

Notes
Installed 4 Brand X Cameras all recording and viewing confirmed March 1, 2021

Create Report

New Report

Report
Report Number: 1234 Technician Name: Sam Service Call

Service Provider
Company Name: Company Name
Company Phone: 111-222-3333
Company Address: State USA
Contact Email: sam@email.com
Contact Number: 222-333-4444

Customer
Customer Name: Sam
Customer Phone: 333-444-5555
Customer Address: State USA
Contact Email: sam@email.com
Contact Number: 444-555-6666

Notes
Installation conducted on March 1, 2021 reported on Camera not working. Tested camera routed to switch all working fine. IT changed address - programmed new IP address and confirmed system operation

Create Report

Create custom reports documenting installations and service calls

Discovery

IP	Hostname
192.168.1.100	DESKTOP-PPFAEUS
192.168.1.130	Unknown

Missing Devices

IP	Hostname	Status
----	----------	--------

New Devices

IP	Hostname	Status
192.168.1.111	Robotick-6	Online

Enter Subnet Range: 192.168.1.100 - 192.168.1.140
ex 192.168.0.0 - 192.168.1.255 Total Found: 3

Scan Subnet Stop Scan
Ovif Scan UPnP Scan
Send to Library Computer Scan
Clear Scan

Discover connected network devices by scanning a range of IP address and automatically assigning them to device library for further testing.

192.168.1.101 Video Feed

HIKVISION_DS-2CDR253F-EIS

Live View Playback Log Configuration

01-01-2011 Sat 02:42:50

Camera 01

Get Unmute Get Full Take Still Use Custom Pres Open in Browser

Confirm transmission by viewing video and incorporating images into reports.

Please visit Vigitron's website at www.vigitron.com to see all NeTester's features and download a Free Run version.

SYSLOG INFORMATION CAPTURE PROGRAM

The SysCap™ is Syslog information capture program that captures information from devices with Syslog capability which is found in almost every managed network switch. Captured information is displayed in a log which can be saved to Clip Board, Excel or Word programs. The SysCap™ can run in a minimized mode to alert operations of problems when they occur.



SysCap™
Vi30012 V1

System Log Configuration

Server Mode: Enabled ▾

Server Address:

Server Port:

The SysCap™ interfaces with any managed network device capable of transmitting System Logs (Syslogs). It is easy to set up and universal in its transmission.

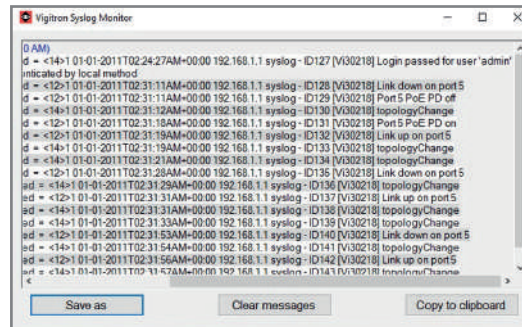
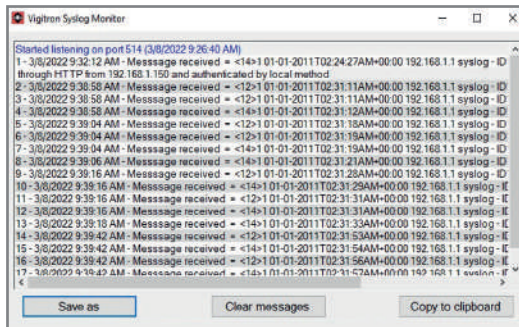

Syslog records complete log which can be saved in various format or copy to a computer clipboard

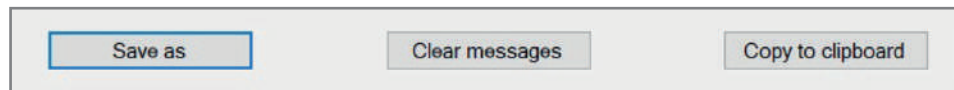

The SysCap™ can operate in the minimized background mode along with other Windows™ based.

The SysCap™ is a free utility program. Please contact support@vigotron.com or your local Vigotron representatives for more information.

Why choose Vigitron?

- Over 25 years of design and manufacturing products for security applications
- Full range of networking products for any size project
- Free and without obligation professional Design Services
- Industry's longest warranty, production life time plus 3 years
- All product specifications are supported by certified testing
- Products are designed and made with USA quality

Solutions for all your CCTV Transmission applications

MaxiiCopper™

- COAX ETHERNET EXTENDERS
- UTP ETHERNET EXTENDERS

MaxiiFiber™

- FIBER MEDIA CONVERTERS
- MANAGED FIBER SWITCHES

Maxii Power™

- POE SPLITTERS
- POE MIDSPANS

MaxiiView™ PowerMate™

- IP CAMERA INSTALLATION TOOLS

MaxiiGuard™

- SURGE PROTECTORS

● ● ● and many more ...

OmniCopper™

- SINGLE PAIR ETHERNET & PoE EXTENDERS

MaxiiNet™

- MANAGED HYBRID POE SWITCHES
- MANAGED PoE SWITCHES
- MANAGED HARDENED PoE SWITCHES
- HARDENED PoE SWITCHES
- ETHERNET & PoE REPEATERS

Net Observer™ NeTester™

- NETWORK HEALTH MONITORING APPLICATIONS

SysCap™

- SYSLOG INFORMATION CAPTURE APPLICATION



Headquarters:

Vigitron Inc.
7810 Trade Street, Suite 100
San Diego, CA 92121
888-574-8942 Toll Free (USA & Canada)
Tel: (+1) 858-484-5209
Fax: (+1) 858-484-1205
E-mail: support@vigitron.com
www.vigitron.com