



The MaxiiCopper Model Vi2300WP is a revolutionary data transmission device that extends full-duplex high-speed Ethernet over existing UTP infrastructures. It extends 10BaseT signals up to 3,000 feet (914m) and 100BaseT up to 2,100 feet (640m). It employs MaxiiCopper innovative and unique Ethernet extension technology that is designed to take full advantage of high-bandwidth networking cables and maintain a full-duplex of 10 or 100 Mb/s Ethernet connection up to the maximum range with minimum transmission error and latency.

The Vi2300WP can connect multiple remote network devices, such as Mega-pixel IP cameras or VoIP to a central LAN switching fabric with ease. Its dual-rate capability feature provides an easy way to balance the best possible network throughput and long-reach distance design. The Vi2300WP is a transceiver device that needs to be deployed on the camera side. It can be used in conjunction with a Vi230xA or Vi25xx Extended Midspans. No IP setting or configurations are required and it is completely transparent to the corporate IP network and higher layer protocols.

## Important Safety Warning

- Read these instructions.
- Keep these instructions.
- Follow all instructions.
- Heed all warnings.
- Do not use this apparatus near water.
- Clean only with a dry cloth.
- Install in accordance with the manufacturer's instructions.
- This installation should be made by a qualified service person and should conform to all local codes.
- DO NOT bundle UTP or Coax signals in the same conduit as high-voltage wiring.
- To reduce the risk of fire or electrical shock, do not expose these products to rain, moisture, dripping or splashing.
- No objects filled with liquids, such as vases, shall be placed on Vigitron equipment.
- DO NOT install the unit in a place where the operating ambient temperature exceeds 75° C.
- Make sure that the external power supply output voltage is in the recommended range.
- Do not install near any heat sources such as radiators, heat registers, stoves or other apparatus that produce heat.
- Protect the power cord from being walked on or pinched particularly at plugs, convenience receptacles, and the point where they exit from the apparatus.
- Only use attachments/accessories specified by the manufacturer.
- Unplug this apparatus during lightning storms or when unused for long periods of time.
- Refer all servicing to qualified service personnel. Servicing is required when the apparatus has been damaged in any way, such as a power supply cord or plug is damaged, liquid has been spilled, or objects have fallen into the apparatus, the apparatus has been exposed to rain or moisture, does not operate normally, or has been dropped.

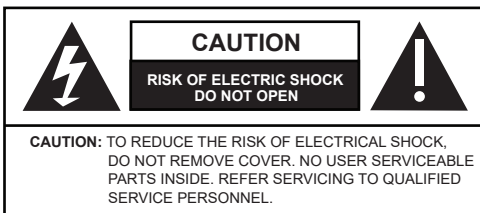

**! WARNING!** - To assure proper performance, check all gaskets to eliminate any spacing where water can penetrate.

## Application Drawing

### Using Vi2300WP with UTP Ethernet and PoE Extenders

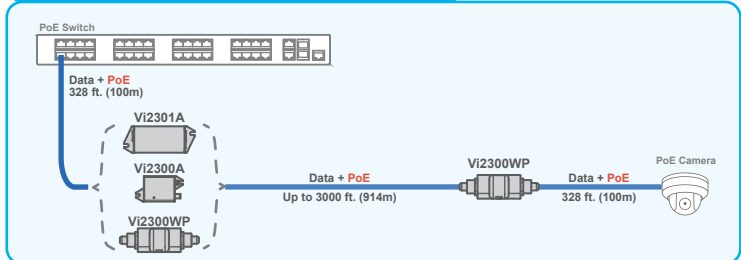

The Vi2300WP and Vigitron UTP Ethernet and PoE extenders can extend IP video and PoE at distances up to 3000ft of Coax.

## IP Camera-end Installation

- When using PoE, the camera has to be powered by PoE also.
- Connect the IP camera RJ45 connector to the "Standard Ethernet" port of Vi2300WP using a standard Cat5/6 cable of maximum 100 m in length.
- Connect one end of the long UTP cable to the "Extended Ethernet" RJ45 connector of Vi2300WP.

Unscrew the gasket and insert the UTP cable checking to confirm there is no spacing between the wire and the insertion hole.

Connect the RJ45 cable and insert it into the RJ45 female connector on the Vi2300A's body making certain the connection is tight.

Reconnect the gasket by screwing into the Vi2300WP body making certain to limit any wire slack.

## Ethernet Switch/NVR-end Installation

- When using PoE, the camera has to be powered by PoE also.
- Connect the RJ45 connector of the Ethernet switch to the "Standard Ethernet" port of Vi2301A using a standard Cat5/6 cable of maximum 328 feet (100 m) in length.
- Connect one end of the long UTP cable to the "Extended Ethernet" RJ45 connector of Vi2300WP.

Unscrew the gasket and insert the UTP cable checking to confirm there is no spacing between the wire and the insertion hole.

Connect the RJ45 cable and insert it into the RJ45 female connector on the Vi2300A's body making certain the connection is tight.

Reconnect the gasket by screwing into the Vi2300WP body making certain to limit any wire slack.

## RJ-45 Installation Instruction

Installing cable and connector is critical for maintaining the IP 67 performance of this product. Please follow instructions carefully.

1. Terminate the Cat5 cable with RJ45 plug.

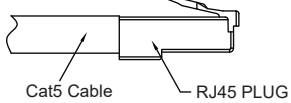

2. Insert the cable through the nut.

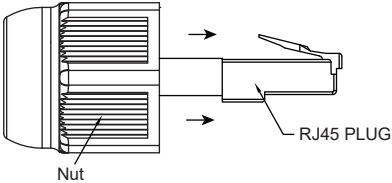

3. Split open the seal and insert the cable through the seal.

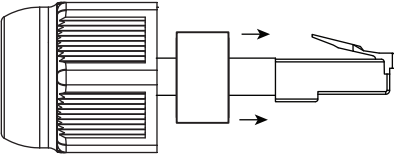

4. Insert the cable through the gasket.

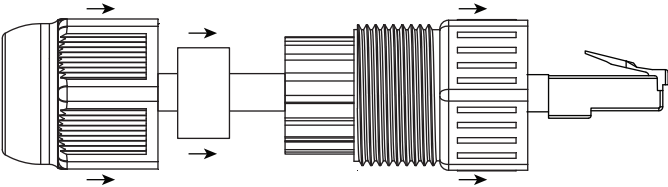

5. Tighten the nut to seal the cable.

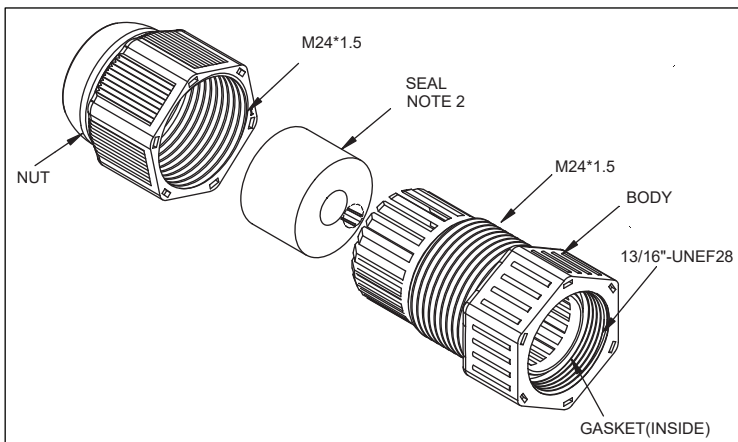
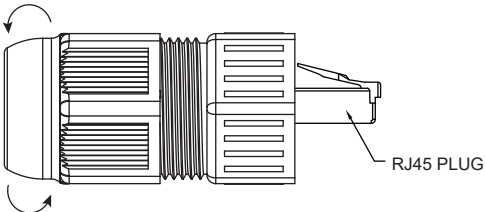

## Technical Specifications\*

### Electrical

Ethernet Interface	Standard 10/100BaseT
Ethernet Rate	Auto selectable 10/100 Mb/s
UTP**	100 Ohm, 3000 feet (914 m) at 10BaseT 2,100 feet (640 m) at 100BaseT
Connectors	Ethernet Interface RJ-45 Connector Extended Interface RJ-45 Connector

### Environmental

Humidity	0 to 95%, non-condensing
Temperature	Operating: -40°C to +75°C Storage: -40°C to +85°C
IP Rating	Conforms to IP67

### Mechanical

Dimensions	1.82 x 1.7 x 7 in (HxWxL) 46.2 x 43.2 x 177.8 mm
Weight	0.49 lbs., 220 g
Material	Plastic

\*Specifications subject to change without notice.

\*\*Distance figures are obtained using in house testing mirroring installations. Factors such as cabling, connections, use of power and environmental conditions may affect actual distances and should be taken into consideration.

## Limited Lifetime Warranty

Vigtron, Inc. warrants that all Vigtron products ("Product"), if used in accordance with these instructions, will be free of defects in material and workmanship for lifetime defined as the duration period of time until product end of life is announced. After which Vigtron will continue to provide warranty services for a period of 3 years. Period covering valid warranty will be determined by proof of purchase in the form of an invoice from an authorized Vigtron dealer.

Warranty will only be provided for as long as the original end user purchaser owns the product. Warranty is not transferrable. At Vigtron's option, defective product will be repaired, replaced or substituted with a product of equal value. This warranty does not apply if, in the judgment of Vigtron, Inc., the Product fails due to damage from shipment, handling, storage, accident, abuse or misuse, or if it has been used or maintained not conforming to Product manual instructions, has been modified, or serial number removed or defaced. Repair by anyone other than Vigtron, Inc. or an approved agent will void this warranty. Vigtron, Inc. shall not under any circumstances be liable to any person for any incidental, indirect or consequential damages, including damages resulting from use or malfunction of the product, loss of profits or revenues or costs of replacement goods. The maximum liability of Vigtron, Inc. under this warranty is limited to the original purchase price of the Product only.



TEL (+1) 858-484-5209 • FAX (+1) 858-484-1205

7810 Trade Street, Suite 100, San Diego, CA 92121, USA • support@vigtron.com • www.vigtron.com

© Copyright 2018 Vigtron, Inc.  
VI2300WP\_UM