

VON DUPRIN®

Door control
and security
hardware



Introduction

Since pioneering the first exit device in 1908, Von Duprin life safety products have provided unparalleled quality, performance and flexibility for schools, hospitals, stadiums and public buildings.

From innovative exit devices to electronic access control solutions and accessories, Von Duprin never compromises when lives are at stake.

Von Duprin exit devices meet or exceed domestic and international quality standards. All devices are UL listed for panic or fire hardware and are ANSI certified. Many models are built to resist hurricane conditions.

VON DUPRIN
Administrative Offices
2720 Tobey Dr.
Indianapolis, IN 46219

Customer Service
877-671-7011
800-999-0328 - Fax

Technical Support
877-671-7011

Table of contents

Electric strikes

4200 Series electric strikes	4-5
5100 Series electric strikes	6-7
6000 Series electric strikes	8
6100 Series electric strikes	9-11
6200 Series electric strikes	12-16
6300 Series electric strikes	17-18
Electric strike / Lock information	19
E996L Electrified Breakaway lever trim	20
Lever styles	21
EL/QEL Electric latch retraction	22
RX/LX Switches	23
SS Signal switch	24
RX330/RX350 Push pad	25
Chexit delayed exit	26-27
DE 5300	28
ALK Exit alarm kit	29
GUARD-X	30
E7500 Electric mortise lock	31
Electrical options / Power supplies	32
Electric power transfer accessories	33
Monitor strikes	34-36
Mullions	37

4200 Series electric strikes for cylindrical locks

Overview

The 4200 Series electric strikes are easy to order, configure in the field and install. This makes it a great choice for commercial applications where traffic control is the primary function.

Compatible with a wide range of cylindrical devices, the 4200 series makes electrifying an opening simple. It is designed and tested to work with all Schlage and Falcon cylindrical locks as well as those of many other manufacturers.

With a variety of field configurable options, the 4200 series is able to address a broad range of needs. The power failure mode (fail safe or fail secure) can be changed in the field without disassembling the strike. The 4200 series also features a 12/24 dual-voltage solenoid for field wiring of either input voltage.

Additional factory orderable options provide even greater flexibility. The 4200 series can be ordered with or without latchbolt monitor. Square face plate is offered standard to accommodate hollow metal frames, and rounded corner faceplates are available as an option for aluminum frames. An entry buzzer and rectifier kits are also available options.

The 4200 was developed with Von Duprin's high standards and engineering expertise. Its heavy duty stainless steel construction is designed to withstand abuse.

Features

- Field configurable 12/24 voltage utilizing dual-voltage internal solenoid
- Field configurable power failure mode (fail-safe/fail-secure)
- Non-handed, internal solenoid design
- Heavy duty stainless steel faceplate
- Latchbolt monitoring standard on 4212 only
- Optional entry buzzer and rectifier kits available for AC to DC operation
- 1 year electrical product warranty

Lockset compatibility

The 4200 series is compatible with all Schlage and Falcon cylindrical locks as well as cylindrical and deadlatch locks of many other manufacturers.

- The 4211 is compatible with locksets with $\frac{5}{8}$ " (15 mm) throw latchbolts, or up to $\frac{3}{4}$ " (19mm) throw latchbolts with a $\frac{1}{8}$ " door gap.
- The 4212 is compatible with locksets with $\frac{1}{2}$ " (12.7mm) throw latchbolts, or up to $\frac{5}{8}$ " (15 mm) throw latchbolts with a $\frac{1}{8}$ " door gap.



Technical specifications

Strike	12 VDC	12 VDC
Current (amps)	0.20 A	0.10 A
Latchbolt monitor	30 VDC	
Current (amps)	0.20 A	

The 4200 series requires a DC regulated power supply, and the Schlage PS900 series power supplies are recommended.

Model specifications

Model number	4211	4212	
Latchbolt throw	$\frac{3}{4}$ "	$\frac{5}{8}$ "	
Latchbolt monitor switch	---	•	
Face plate length	$4 \frac{7}{8}$ "	$4 \frac{7}{8}$ "	
Backbox depth	$1 \frac{3}{8}$ "	$1 \frac{3}{8}$ "	
Lockset	Cylindrical	•	•
	Deadlatch	•	•
	Mortise	---	---
	Rim exit devices	---	---
Number of doors	Single	•	•
	Pair	---	---
Door and frame type	Hollow metal	•	•
	Aluminum	•	•
	Wood	---	---
Options	EB (entry buzzer - fail-secure only)	•	•
	SO12 & SO24 rectifier kit for AC to DC operation	•	•
	Round corner faceplate	•	•

4200 Series electric strikes dimensions

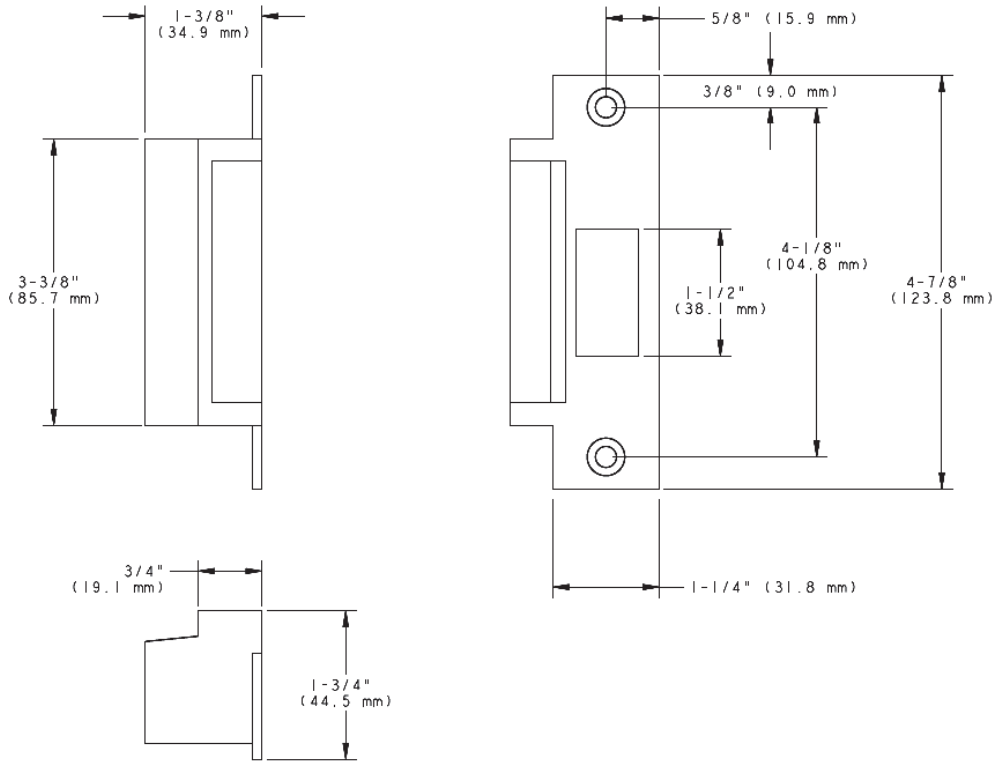

12 VDC strike wiring

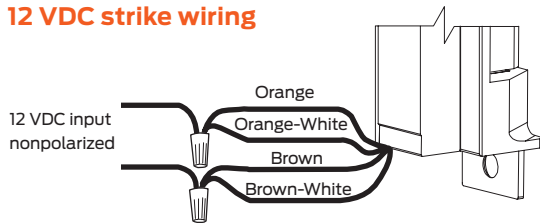

24 VDC strike wiring

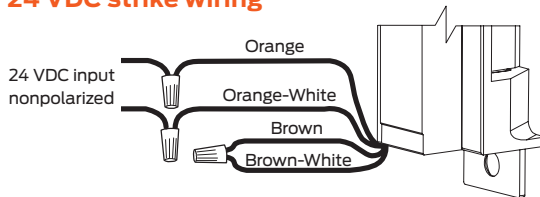

Latchbolt monitoring switch (4212 only)

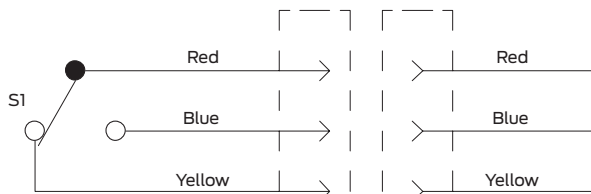

Switch shown with latch status tripper depressed

Ordering information

4200 - S024 - EB

Model	Rectifier kit*	Buzzer*
1	2	3

* Optional

Selections correspond with the numbers above

1	Model
4211	See model specification chart to make the proper selection
4212	See model specification chart to make the proper selection
2	Rectifier kit (optional)
S012	Converts 12 VAC voltage to 12 VDC to operate the solenoid
S024	Converts 24 VAC voltage to 24 VDC to operate the solenoid
3	Buzzer (optional)
EB	Entry Buzzer, with fail-secure (FSE) configured

Standard features

- Power failure mode: Field configurable fail-secure/ fail-safe
- Voltage: Field configurable 12 VDC/24 VDC dual voltage solenoid
- Finish: 630 satin stainless steel

5100 Series electric strikes for cylindrical locksets

Overview

The Von Duprin 5100 electric strike has been designed and manufactured to meet the needs of locksmiths and security professionals. This easy-to-install electric strike was created for medium-duty applications, specifically to control traffic flow through interior and exterior openings in retail and commercial environments.

The 5100 electric strike is designed for maximum flexibility. It comes standard with three faceplates for hollow metal, wood or aluminum frames in every box. The internal 12/24VDC solenoid provides additional versatility. While the adjustable keeper improves fit for applications with weather stripping or tight door preps. Furthermore, power failure mode is field selectable fail-safe/fail-secure.

With multiple faceplates and flexible options, the 5100 provides added convenience by ensuring the right parts are in the box to get the job done. This reduces labor expense and reduces return trips to the job site.

The 5100 was developed with Von Duprin's high standards and engineering expertise. Its heavy-duty construction and tamper-resistant design is able to withstand abuse. The 5100 is tested to over one million cycles and provides 1300 lbs holding strength.

Features

- Three faceplates standard in every box
- 12/24 dual-voltage
- Fail-safe/fail-secure
- Adjustable keeper
- Internal solenoid
- Non-handed
- Backbox depth of 1¹¹/₁₆"
- Keeper depth of 1/2"
- Mounting tabs
- Retrofit kit
- Illustrated installation instructions
- Tamper resistant
- One year electrical product warranty
- Continuous duty operation
- Heavy duty construction
- Meets BHMA A156.31, Grade 1 for endurance and dynamic strength, and Grade 2 for static strength
- Static strength 1300 lbs
- Dynamic strength 70 ft-lbs
- Endurance 1,000,000 cycles

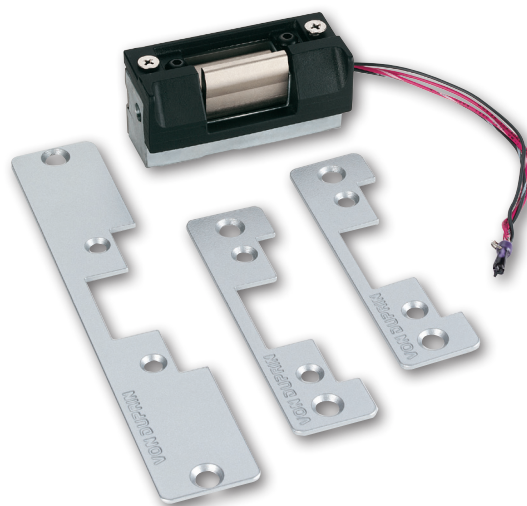

Technical specifications

Power options

DC: Regulated power supplies (recommended)	PS902 power supply	
AD/DC: Conversion	Von Duprin SO-24 kit	
	12VDC	12VDC
Resistance (ohms)	32	128
Power (watts)	4.5	4.5
Current (amps)	0.38	0.19

All specs ± 10% @ 77°F/25°C

Model specifications

Model #	5100
Latchbolt throw	1/2" to 5/8" with 1/8" door-frame gap
Face plate length	4 7/8" or 7 15/16"
Depth	1 11/16"
Lockset	Cylindrical
Door/frame type	Hollow metal, aluminum and wood
Number of doors	Single
Certifications	ANSI/BHMA 156.5 Grade 1, UL 1034 burglary listing
Application notes	Versatile electric strike for aftermarket, covering multiple applications in one SKU.

Lockset compatibility: Keeper depth of 1/2" is sufficient to accommodate all cylindrical locks up to 5/8" throw and most aluminum narrow stile deadlatches.

5100 Series electric strikes dimensions

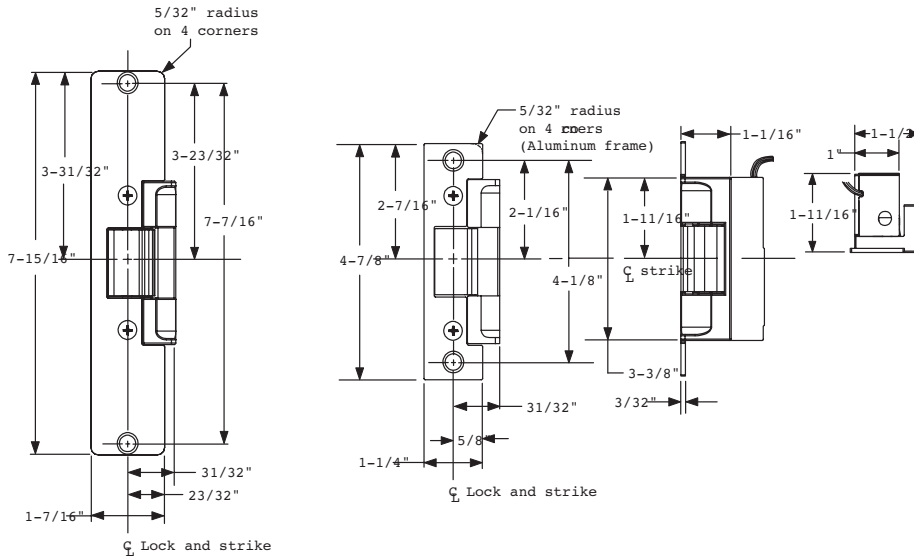

Solenoid power requirements; 12VDC, 0.38 A, 24 VDC, 0.19 A

For DC operation, Von Duprin PS902 series power supply is recommended. For AC operation, Von Duprin SO24 kit is recommended.

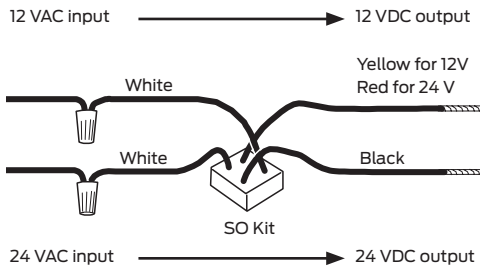

12 VDC strike wiring

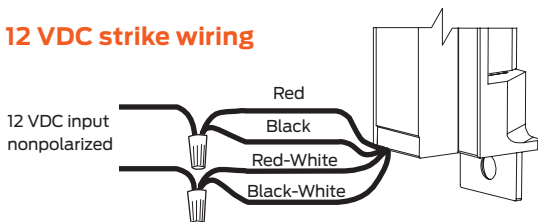

24 VDC strike wiring

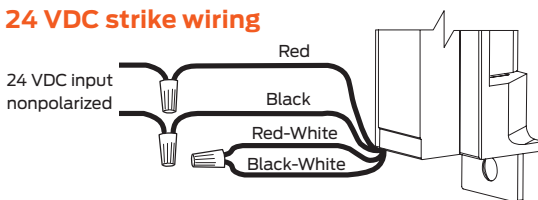

Ordering information

5100-S024

Model	Rectifier kit*
1	2

* Optional

Selections correspond with the numbers above

1	Model
5100	Electric strike for cylindrical locksets
2	Rectifier kit (optional)
S012	Converts 12 VAC voltage to 12 VDC to operate the solenoid
S024	Converts 24 VAC voltage to 24 VDC to operate the solenoid

Standard features

- 24 volts DC
- Fail-secure
- Field convertible to fail-safe

6000 Series electric strikes

Overview

Von Duprin 6000 Series electric strikes

Von Duprin is the leading manufacturer of premium, heavy-duty electric strikes known for their reliability, durability and security.

Electric Strikes provide remote release of a locked door. They allow the door to be opened without retracting the latchbolt. This occurs by the releasing of the electric strike lip (sometimes called keeper or gate). When the door closes the beveled latchbolt rides over the lip and falls into the electric strike pocket.

Von Duprin 6100 Series electric strikes

Electric strikes for use with rim exit devices

Von Duprin 6200 Series electric strikes

Electric strikes for use with mortise/cylindrical electric locks

Versatility

- Furnished 24VDC standard with 12VDC and AC operation optional. 16VDC solenoids available.
- Furnished fail secure (FSE) standard, with fail safe (FS) optional.
- Strike box is adjustable to compensate for misalignment of the door or frame.
- Two piece plug connectors are furnished for ease of installation and for removal during strike servicing.

Durability

Developed with Von Duprin's high standards and engineering expertise.

- Heavy-duty stainless steel construction. Tested to over 250,000 cycles.

Features and Benefits

- Stainless Steel Construction
- Accepts 3/4" (19mm) Throw Latchbolt
- Six Finishes
- Non-handed
- Fail Secure
- Plug Connectors

Specifications	12V	24V
Resistance in Ohms±10% @ 70°F	21	82
Watt-seated @ 70°F	7.5	8
Amps-seated @ 70°F	.6	.33
Amps-inrush @ 70°F	.6	.33

To order, specify

1. **Model number**
2. **FS** (fail safe, when required)
3. **DS** or **DS-LC** (dual switch, when required)
4. **Voltage** 12VDC or 24VDC
For 16V solenoids order separately
5. **SO12** or **SO24** (required when using AC)
6. **Finish:** US3, US4, US10, US10B, US32, US32D
7. **EB** (Entry buzzer), **FSE** only (when required)

Note: Information listed is for use on new applications. On retrofit applications, modification of the frame preparation may be required, consult factory.

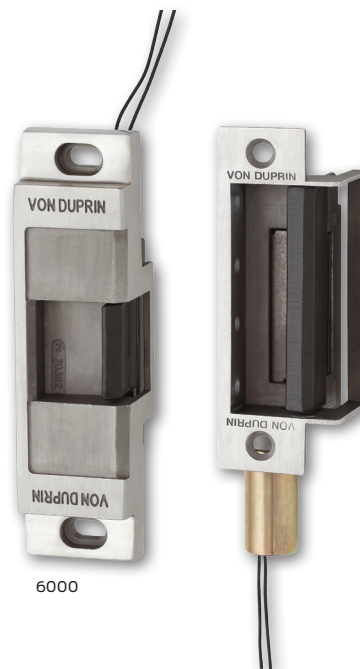

Options

AC operation

SO12 and SO24 are rectifier kits to convert AC voltage to operate the DC solenoids. These kits are field installable and plug in-line to solenoid.

DS and DS-LC — Dual switch monitoring (Factory Installed Only)

Dual switch monitoring option has two SPDT contacts, one switch monitors the tripper which is depressed when the latchbolt is inserted into the strike pocket. The second switch monitors the condition of the strike lip, open or closed and locked.

DS is standard, rated 24V, operating range from 2 ampere to 50 milliamperes.

DS-LC low current gold contact switches for use on applications associated with computer control and monitoring, rated 24V, operating range 50 milliamperes or below.

Fail secure — FSE

FSE — FAIL-SECURE electric strikes require power to be applied to unlock the strike lip. On loss of power, the strike is locked. Field convertible with parts.

Fail safe — FS

FS — FAIL-SAFE electric strikes require power to be applied to lock the strike lip. On loss of power, the strike is unlocked. Building codes prohibit the use of fail-safe strikes on labeled openings. Field convertible with parts.

Entry buzzer — EB

EB — Entry buzzer is available for use with fail-secure strikes. Installed in the frame and in parallel with the circuit, the buzzer will sound when the strike is unlocked.

UL listed

UL Listed Burglary-Resistant and Electric Strike for fire doors and frames. A label for single doors and B label for double doors. Strikes meet the requirements of ANSI 156.5, Grade 1, 1992.

+ Dual Monitor Switches (DS or DS-LC) are not available on open back strikes.

6100 Series strikes for rim exit devices

Overview

Von Duprin electric strikes are known for their reliability, durability and security. The 6100 Series is designed to withstand abuse. Its heavy-duty stainless steel construction is fully UL1034 and UL10C Listed and ANSI/BHMA Grade 1, 1500 lb hold force rated.

6100 Series electric strikes are designed for use with a variety of rim exit devices. They interface with the latch mechanism of the exit device. The movable lip (keeper) allows a door to open even when the latch bolt is extended. This feature, called remote release, provides added benefits such as increased convenience and efficiency. The 6100 Series also provides added security and traffic control.

6100 Series electric strikes can be used for retrofit applications or new construction. To assure the proper selection of an electric strike on new applications, lockset compatibility charts are shown on the next page. When using a lockset not listed or when

retrofitting a strike to an existing application, please contact Von Duprin technical support for application assistance.

The power failure mode of the 6100 can be specified at the time of order. Fail-secure is available for fire rated openings. In a fail-secure application, the door is normally locked. To unlock the

door, power must be applied. Fail-safe strikes which are commonly used for life safety applications are non-fire-rated. To unlock a fail-safe strike, power is removed. The 6100 comes standard 24 VDC; 12 VDC and AC operation are optional.

Features and benefits

- Non-handed design provides greater flexibility
- Strike box is adjustable to compensate for misalignment of the door or frame
- Two piece plug connectors are furnished for ease of installation and for removal during strike servicing
- ANSI 156.5 Grade 1, 1500 lb hold force rated
- UL1034 burglary-resistant and UL10C electric strike for fire door
- Six finishes available to suite with existing hardware
- Durable stainless steel construction
- 24 VDC standard with 12 VDC and AC operation optional
- Meets BHMA A156.31, Grade 1 for endurance and strength
- Static strength 1300 lbs
- Dynamic strength 70 ft-labs
- Endurance 1,000,000 cycles



Model specifications

Model number	6111	6112	6113	6114	6121	
Retrofits model	VD 3031	FA 310-4	VD 3011, VD 3021	FA 310-5	FA 310-4-100	
Latchbolt throw	3/4"	3/4"	3/4"	3/4"	3/4"	
Face plate length	6"	9"	6"	7"	9 1/8"	
Backbox depth	1 3/4"	1 3/4"	1 15/16"	---	N/A	
Lockset	Rim exit device	Rim exit device	Rim exit device	Rim nightlatch	Rim exit device	
Number of doors	Single	▪	▪	▪	---	
	Double door with mullion	▪	---	---	---	
	Double door without mullion	---	---	---	▪	
Door/frame type	Hollow metal	▪	▪	▪	▪	
	Aluminum	▪	▪	▪	▪	
	Wood	▪	▪	▪	---	▪
Options	Blade stop shim	Yes	No	Yes	No	No
	DS or DS-LC (dual monitor switches)	Yes	Yes	Yes	Yes	Yes
	EB (entry buzzer - fail-secure only)	Yes	Yes	Yes	Yes	Yes
Certifications	UL1034, UL10C, ANSI/BHMA 156.5 Grade 1, 1500 lb hold-force rated					
Application notes	1	2	3	4	5	

Note: 16 VDC and 28 VDC solenoid are sold as replacement parts for existing strikes. Please contact customer care for details.

Application notes:

1. For use with rim exit devices on single doors or double doors with mullion applications. 1/2" projection blade stop shim 010055-XX available for use on cased opening or blade stop frames. Specify when using 55 rim devices. May also be used with vertical rod exit devices noted on previous page x Pullman latch LBR. Non-fired-rated.
2. For use with rim exit devices on single door applications. Designed to replace Folger Adam 310-4, minor fame prep modification required.
3. 1/2" projection blade stop shim 010055-XX available for use on cased opening or blade stop frames. Non-fire rated.
4. Surface applied strike for use with rim nightlatches on single door applications. Designed to replace Folger Adam 310-5, with different mounting hole locations from Folger Adam.
5. Non-fire rated. For use with rim exit devices on double door applications without mullion. Strike mounts on inactive leaf. Replace Folger Adam 310-4-100.

Rim exit device compatibility

6111, 6112, 6113 & 6121 Strikes

Manufacturer	Device
Von Duprin	22, 33A, 35A, 55 ¹ , 88, 98, 99 8827 LBR ⁴ x Pullman latch Non-Fire rated 9827 LBR ⁴ x Pullman latch Non-Fire rated 9927 LBR ⁴ x Pullman latch Non-Fire rated
Falcon Monarch ²	XX-R, 18-R, 19-R, 24-R, 25-R
Falcon Doromatic	1790
Precision ²	2100
Sargent	2800, 6500, 6800, 8500, 8800, 9500, 9800 ³ , 9898
Yale	1500, 700

1. Strike must be factory modified, specify when using with a 55 Rim device
2. Deadlocking feature will not properly function, consult factory
3. Panic only, Not fire-rated
4. 6111 is recommended for LBR applications

Note: When using a lockset not listed or when retrofitting an existing application, please contact Von Duprin technical support for application assistance

6100 Series strikes dimensions

Wiring

AC

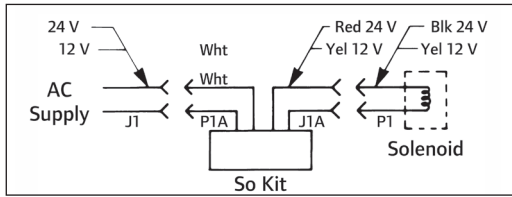

AC with buzzer

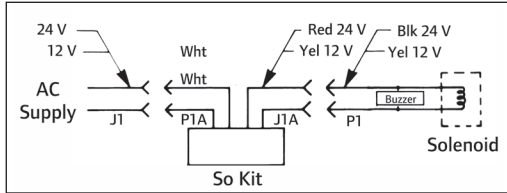

DC

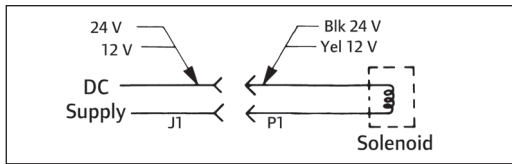

DC with buzzer

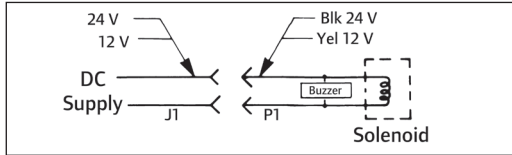

Optional DS (FSE shown)

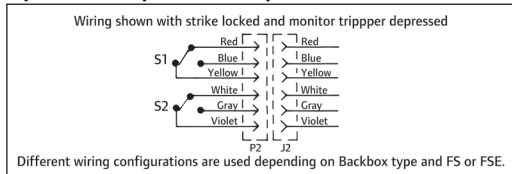

6100 Series specifications

	12V	24V
Resistance in Ohms ±10% @ 70°F	21	82
Watt-seated @ 70°F	7.5	8
Amps-seated @ 70°F	0.6	0.33
Amps-inrush @ 70°F	0.6	0.33

Dimensions

6111

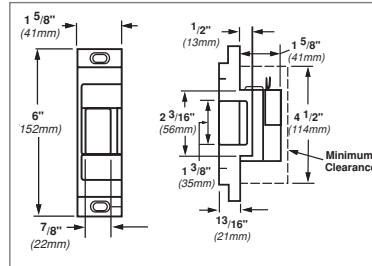

6112

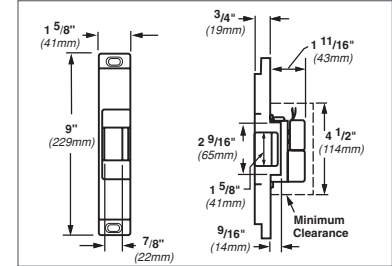

6113

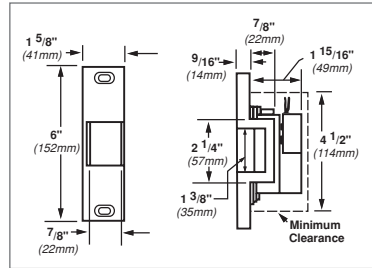

6114

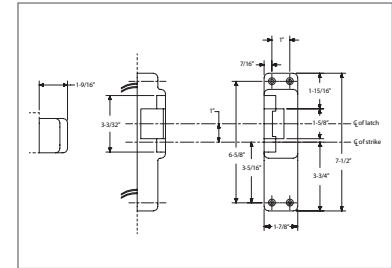

6121

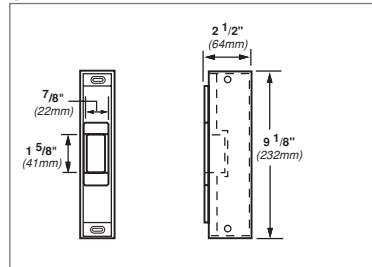

6100 Series strikes dimensions

6100 Series how to order

Ordering information

6112 - FSE - DS - 24 - S024 - US3 - EB

Model	Power failure mode	Dual switch*	Voltage	Rectifier kit*	Finish	Buzzer*
1	2	3	4	5	6	7

* Optional

Selections correspond with the numbers above

1	Model
6111	See chart on page 3 to make the proper selection
6112	See chart on page 3 to make the proper selection
6113	See chart on page 3 to make the proper selection
6114	See chart on page 3 to make the proper selection
6121	See chart on page 3 to make the proper selection
2	Power failure mode
FSE	Fail-secure. Requires power to be applied to unlock the strike lip. On loss of power, the strike lip is locked. Fire-rated.
FS	Fail-safe. Requires power to be applied to lock the strike lip. On loss of power, the strike lip is unlocked. Non-fire-rated.

3	Dual switch (optional)
DS	Monitors latch bolt and lock status. DS switches rated at 24 VDC 50 milliampere - 2 amps.
DS-LC	Optional for computer monitoring. Monitors latch bolt & lock status. DS switches rated 24 VDC 50 milliampere or less.
4	Voltage (VDC)
24	Low voltage DC power
12	Low voltage DC power
If AC power is required specify rectifier kit below.	
5	Rectifier kit (optional)
S012	Converts 12 VAC voltage to 12 VDC to operate the solenoid
S024	Converts 24 VAC voltage to 24 VDC to operate the solenoid

6	Finish
US number/Von Duprin number	
US3/85	Plated polished brass on stainless steel
US4/84	Plated dull brass on stainless steel
US10/06	Plated dull bronze on stainless steel
US10B/86	Plated dark bronze on stainless steel
US32/31	Stainless steel, polished
US32D/32	Stainless steel, satin
7	Buzzer (optional)
EB	Entry Buzzer.
Only available if Fail-Secure (FSE) is specified.	

6200 Series strikes for mortise or cylindrical devices

Overview

Von Duprin electric strikes are known for their reliability, durability and security. The 6200 Series is designed to withstand abuse. Its heavy-duty stainless steel construction is fully UL1034 and UL10C Listed and ANSI/BHMA Grade 1, 1500 lb hold force rated.

6200 Series electric strikes are designed for use with a variety of mortise or cylindrical locksets, as well as mortise exit devices. It interfaces with the latch mechanism of the exit device. The 6200 Series movable lip (keeper) allows a door to open, even when the latch bolt is extended. This feature, called remote release provides added benefits such as increased convenience and efficiency. The 6200 Series also provides added security and traffic control.

6200 Series electric strikes can be used for retrofit applications or new construction. To assure the proper selection of an electric strike on new applications, lockset compatibility charts are shown on the next page. When using a lockset not listed or when retrofitting a strike to an existing application, please contact Von Duprin Technical Support for application assistance.

The power failure mode of the 6200 Series can be specified at the time of order. Fail-secure is available for fire rated openings. In a fail-secure application, the door is normally locked. To unlock the door power must be applied. Fail-safe strikes, which are commonly used for life safety applications, are non-fire rated. To unlock a fail-safe strike, power is removed. The 6200 Series comes standard with 24 VDC; 12 VDC and AC operation are optional.

Features and benefits

- Non handed design provides greater flexibility
- Strike box is adjustable to compensate for misalignment of the door or frame
- Two piece plug connectors are furnished for ease of installation and for removal during strike servicing
- ANSI 156.5 Grade 1, 1500 lb hold-force rated
- UL1034 Burglary-Resistant and UL10C Electric Strike for Fire Door
- Six finishes available to suite with existing hardware
- Durable stainless steel construction
- 24 VDC standard with 12 VDC and AC operation optional
- Meets BHMA A156.31, Grade 1 for endurance and strength
- Static strength 1300 lbs
- Dynamic strength 70 ft-lbs
- Endurance 1,000,000 cycles

Specifications	12V	24V
Resistance in Ohms±10% @ 70°F	21	82
Watt-seated @ 70°F	7.5	8
Amps-seated @ 70°F	0.6	0.33
Amps-inrush @ 70°F	0.6	0.33



Mortise Lockset Compatibility

6211, 6211AL, 6211WF, 6212, 6213, 6214, 6215, 6221, 6222, 6223, 6224, 6224AL, 6225 & 6226 Strikes

Manufacturer	Model Number
Von Duprin	7500
Adams Rite	4510, 4710
Baldwin	6000
Best	24H, 30H
Corbin	9000
Falcon	M2300, M2500, M2600, M3300, M3500, M3600
Precision	Mortise
Russwin	Mortise
Sargent	7700, 8100, 9000
Schlage	L9000, K30, K40, K50, K60
Yale	7030, 7130, 8600, 8700

Mortise Lockset Compatibility

6210

Manufacturer	Model Number
Von Duprin	7500
Best	30H (not 45H/47H)
Corbin/Russwin	ML2200, 5000, 9000, CR2200 (not 2000)
Falcon	M100, M200, M300, M400, M500, M600
Sargent	7700, 8100 (not 7800/8200)
Schlage	L9000
Yale	8700 (not 8800)

Cylindrical Lockset Compatibility^{1,3}

6211, 6211AL, 6211WF, 6212, 6213, 6214, 6215, 6221, 6222, 6223, 6224, 6224AL, 6225 & 6226 Strikes

Manufacturer	Model Number
Baldwin	1/2" - 3/4" (13mm - 19mm)
Best	3/8" - 3/4" (10mm - 19mm)
Corbin	1/2" - 3/4" (13mm - 19mm)
Falcon	1/2" - 3/4" (13mm - 19mm)
Russwin	1/2" - 3/4" (13mm - 19mm)
Sargent	1/2" - 3/4" (13mm - 19mm)
Schlage	3/8" - 3/4" (10mm - 19mm)
Yale	1/2" - 3/4" (13mm - 19mm)

1. Von Duprin cannot guarantee compatibility as other manufacturer's designs may change without notice.
2. Signalling may not function when using 3/8" (10mm) throw bolt. Deadlocking cannot be guaranteed with all locks.
3. When using a lockset not listed or when retrofitting a strike to an existing application, please contact Von Duprin Technical Support for assistance.

6200 Series strikes for mortise or cylindrical devices

Wiring

AC

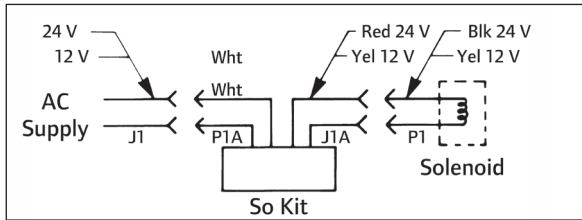

AC with buzzer

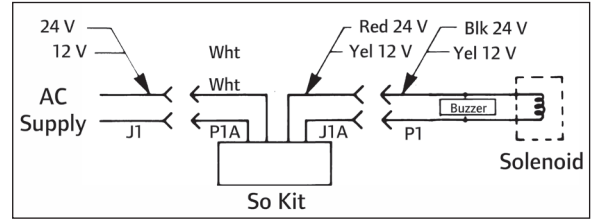

DC

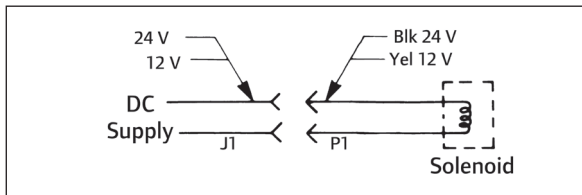



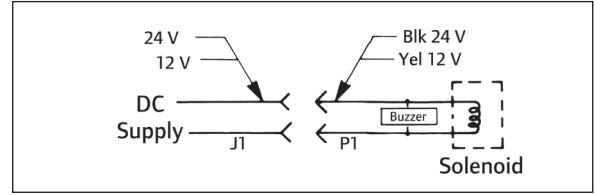

DC with buzzer

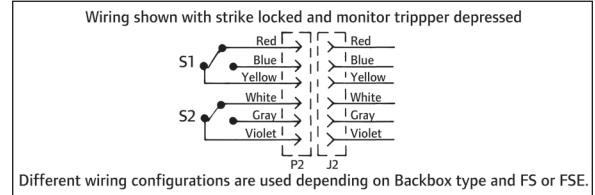

Optional DS (FSE shown)



Model Specifications







						
Model #		6210	6211	6211AL	6211WF	6212
Retrofits model		n/a	VD 3140, FA 712	FA 722	FA 732	VD 3146
Latchbolt throw		3/4"	3/4"	3/4"	3/4"	3/4"
Face plate length		4 7/8"	4 7/8"	4 7/8"	4 7/8"	6 3/8"
Backbox depth		1 21/32"	1 21/32"	1 21/32"	4 1/2"	1 21/32"
Lockset	Mortise	•	•	•	•	•
	Cylindrical	---	•	•	•	•
# Doors	Single	•	•	•	•	•
	Pair	---	---	---	---	---
Door & frame type	Hollow metal	•	•	---	---	•
	Aluminum	•	•	•	---	•
	Wood	---	---	---	•	---
Options	DS or DS-LC (dual monitor switches)	•	•	•	•	•
	EB (Entry buzzer - fail secure only)	•	•	•	•	•
	28 VDC AC rectifier kit	•	•	•	•	•
	16 VDC solenoid	•	•	•	•	•
Certifications	UL1034	•	•	•	•	•
	UL10C	•	•	•	•	•
	ANSI/BHMA 156.5 Grade 1 1500lb. Hold force rated	•	•	•	•	•
Application notes	1	2	3	4	5	







Application notes:

- For use with mortise locks without deadbolt on single door, hollow metal frame applications and using ANSI prep at standard height. Strike pocket inserts are provided to accommodate different manufacturers deadlocking trigger locations.
- For use on new installations with mortise locks without deadbolt or cylindrical locks on single door, hollow metal frame applications. Designed to replace Von Duprin 3140 or Folger Adam 712.
- For use on new installations with mortise locks without deadbolt or cylindrical locks on single door, aluminum frame applications
- For use on new installations with mortise locks without deadbolt or cylindrical locks on single door wood frame applications. Designed to replace Folger Adams 732. Wood frame horizontal solenoid location differs from Folger Adams. Requires additional frame prep when retrofitting.
- For use with mortise locks without deadbolt or cylindrical locks on single door, hollow metal or aluminum frame applications. Fits modified ANSI 115.2 cutout. Designed to replace Von Duprin 3146

6200 Series strikes for mortise or cylindrical devices

Model Specifications

							
Model #		6212WF	6213	6214	6215	6216	6221
Retrofits model		n/a	VD 3041, 3042, 3061, 3062	FA 310-2 3/4	FA 310-2	FA 310-3-1	VD 3071 & 3072
Latchbolt throw		3/4"	3/4"	3/4"	3/4"	3/4"	3/4"
Face plate length		6 3/8"	6"	9"	9"	9"	6"
Backbox depth		4 3/4"	2 1/2"	1 5/8"	1 5/8"	3 5/32"	4 3/4"
Lockset	Mortise	•	•	•	•	•	•
	Cylindrical	•	•	•	•	•	•
# Doors	Single	•	•	•	•	•	•
	Pair						•
Door & frame type	Hollow metal		•	•	•	•	•
	Aluminum		•	•	•	•	•
	Wood	•	See note 2 below			•	•
Options	DS or DS-LC (dual monitor switches)	•	•	•	•	•	•
	EB (Entry buzzer - fail secure only)	•	•	•	•	•	•
	28 VDC AC rectifier kit	•	•	•	•	•	•
	16 VDC solenoid	•	•	•	•	•	•
Certifications	UL1034	•	•	•	•	•	•
	UL10C	•	•	•	•	•	•
	ANSI/BHMA 156.5 Grade 1 1500lb. Hold force rated	•	•	•	•	•	•
Application notes		6	7	8	9	10	11

							
Model #		6222	6223	6224	6224AL	6225	6226
Retrofits model		FA 310-2 3/4 OB	VD 3091 & 3092	FA 310-2 3/4	FA 310-2RF	FA 310-2 OB	FA 310-2
Latchbolt throw		3/4"	3/4"	3/4"	3/4"	3/4"	3/4"
Face plate length		9"	6"	9"	9"	9"	9"
Backbox depth		1 5/8"	4 1/2"	1 5/8"	1 5/8"	1 5/8"	1 5/8"
Lockset	Mortise	•	•	•	•	•	•
	Cylindrical	•	•	•	•	•	•
# Doors	Single	---	---	---	---	---	---
	Pair	•	•	•	•	•	•
Door & frame type	Hollow metal	•	•	•	•	•	•
	Aluminum	•	•	•	•	•	•
	Wood	---	•	---	---	---	---
Options	DS or DS-LC (dual monitor switches)	•	•	•	•	•	•
	EB (Entry buzzer - fail secure only)	•	•	•	•	•	•
	28 VDC AC rectifier kit	•	•	•	•	•	•
	16 VDC solenoid	•	•	•	•	•	•
Certifications	UL1034	•	•	•	•	•	•
	UL10C	•	•	•	•	•	•
	ANSI/BHMA 156.5 Grade 1 1500lb. Hold force rated	•	•	•	•	•	•
Application notes		12	13	14	15	16	17

- 6 For use with mortise locks without deadbolt or cylindrical locks on single door, wood frame applications.
- 7 For use with mortise locks without deadbolt or cylindrical locks on single door hollow metal or aluminum frame applications (includes wood frame on retrofit applications). Designed to replace Von Duprin 3041, 3042, 3061 and 3062.
- 8 For use with mortise locks without deadbolt or cylindrical locks on single door hollow metal or aluminum frame applications. Designed to replace Folger Adams 310-2 3/4
- 9 For use with mortise locks without deadbolt or cylindrical locks on single door hollow metal or aluminum frame applications. Designed to replace Folger Adams 310-2.
- 10 For use with mortise locks with deadbolt 1" throw on single door hollow metal aluminum or wood frame applications. Deadbolt must be manually operated. Designed to replace Folger Adams 310-3-1.
- 11 Open back electric strike for use with mortise locks without deadbolt or cylindrical locks on 1 3/4" (44mm) thick double door applications. 4 3/4" (120 mm) minimum stile required. For a concealed vertical rod and mortise device combination, specify "A" backbox.
- 12 Open back electric strike for use with mortise locks without deadbolt or cylindrical locks on 1 3/4" (44mm) thick double door applications
- 13 Closed back electric strike for use with mortise locks without deadbolt or cylindrical locks on 1 3/4" (44mm) thick double door applications. 4 3/4" (120mm) minimum stile required. For a concealed vertical rod and mortise device combination specify "A" backbox.
- 14 Closed back electric strike for use with mortise locks without deadbolt or cylindrical locks on 1 3/4" (44mm) or 2 1/4" (57mm) thick double door applications.
- 15 Closed back electric strike for use with mortise locks without deadbolt or cylindrical locks on 1 3/4" (44mm) or 2 1/4" (57mm) thick aluminum double door applications.
- 16 Open back electric strike for use with mortise locks without deadbolt or cylindrical locks on 1 3/4" (44mm) thick double door applications.
- 17 Closed back electric strike for use with mortise locks without deadbolt or cylindrical locks on 1 3/4" (44mm) or 2 1/4" (57mm) thick double door applications.

6200 Series strikes dimensions

Dimensions

6210

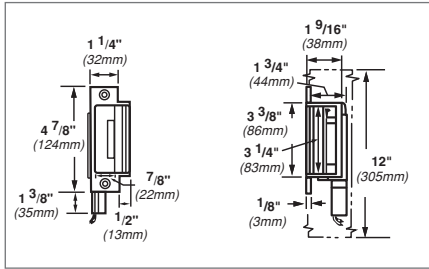

6212

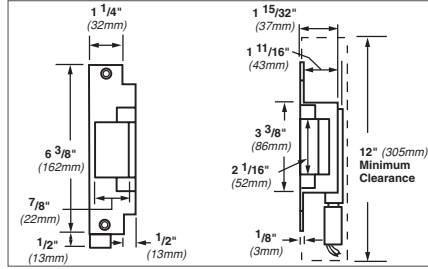

6215

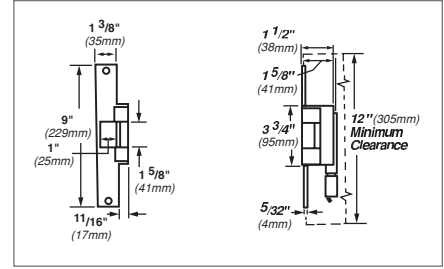

6211

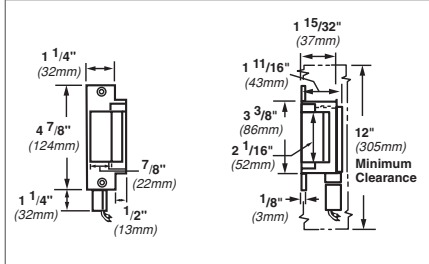

6212WF

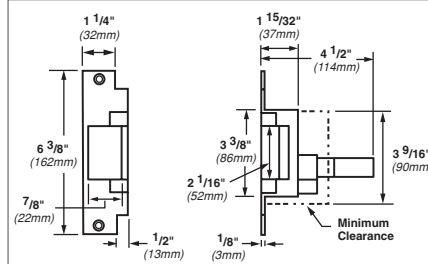

6216

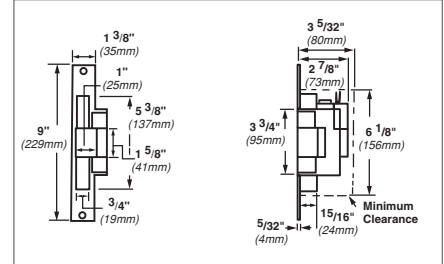

6211AL

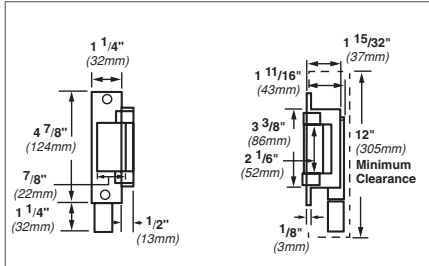

6213

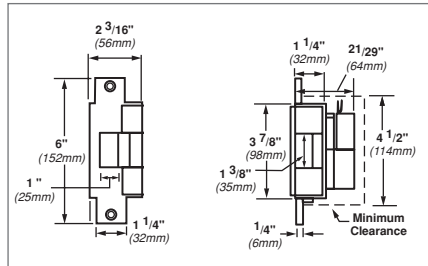

6221

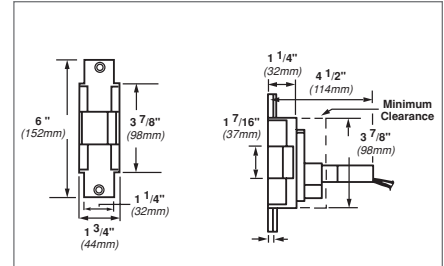

6211WF

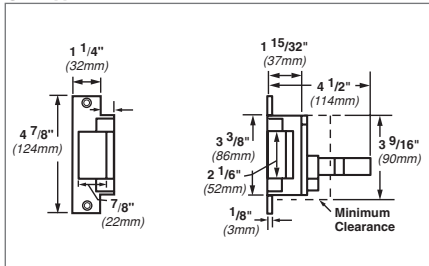

6214

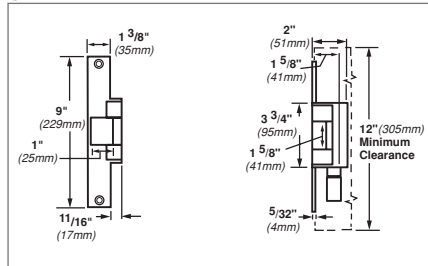

6222

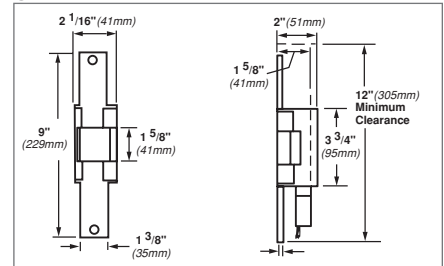

6200 Series strikes dimensions

6200 Series strikes dimensions

Dimensions

6223

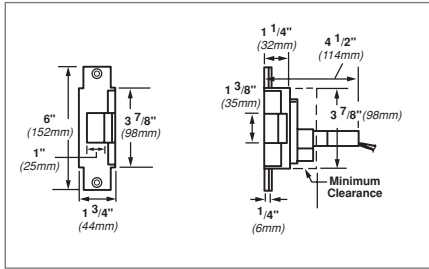

6224AL

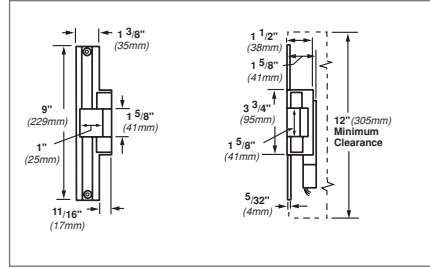

6126

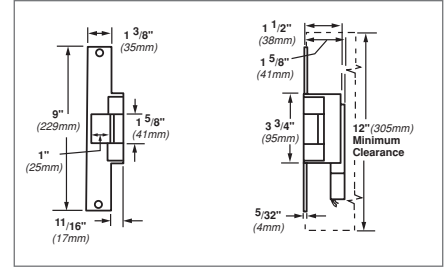

6224

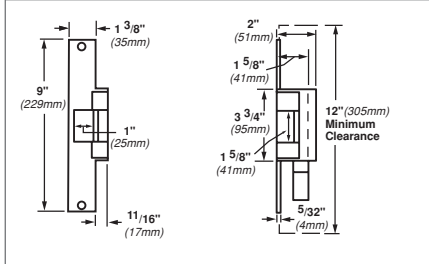

6225

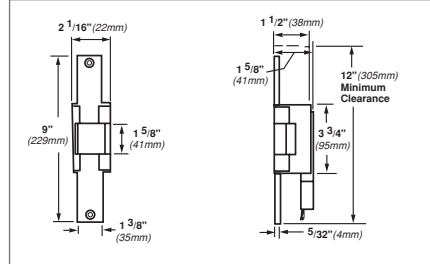

Ordering information

6210 - FSE - DS - 24 - S024 - US3 - EB

Model	Power failure mode	Dual switch*	Voltage	Rectifier kit*	Finish	Buzzer*
1	2	3	4	5	6	7

* Optional

Selections correspond with the numbers above

1	Model	2	Power failure mode	6	Finish US number/Von Duprin number
6210	See chart on page 13 to make the proper selection	FSE	Fail-secure. Requires power to be applied to unlock the strike lip. On loss of power, the strike lip is locked. Fire-rated.	US3/85	Plated polished brass on stainless steel
6211	See chart on page 13 to make the proper selection	FS	Fail-safe. Requires power to be applied to lock the strike lip. On loss of power, the strike lip is unlocked. Non-fire-rated.	US4/84	Plated dull brass on stainless steel
6211AL	See chart on page 13 to make the proper selection			US10/06	Plated dull bronze on stainless steel
6211WF	See chart on page 13 to make the proper selection			US10B/86	Plated dark bronze on stainless steel
6212	See chart on page 13 to make the proper selection	3	Dual switch (optional)	US32/31	Stainless steel, polished
6212WF	See chart on page 14 to make the proper selection	DS	Monitors latch bolt and lock status. DS switches rated at 24 VDC 50 milliamperes - 2 amps.	US32D/32	Stainless steel, satin
6213	See chart on page 14 to make the proper selection	DS-LC	Optional for computer monitoring. Monitors latch bolt & lock status. DS-LS switches rated 24 VDC 50 milliamperes or less.	7	Buzzer (optional)
6214	See chart on page 14 to make the proper selection			EB	Entry Buzzer. Only available if Fail-Secure (FSE) is specified.
6215	See chart on page 14 to make the proper selection	4	Voltage (VDC)		
6216	See chart on page 14 to make the proper selection	24	Low voltage DC power		
6221	See chart on page 14 to make the proper selection	12	Low voltage DC power		
6222	See chart on page 14 to make the proper selection		If AC power is required, specify rectifier kit below.		
6223	See chart on page 14 to make the proper selection	5	Rectifier kit (optional)		
6224	See chart on page 14 to make the proper selection	SO12	Converts 12 VAC voltage to 12 VDC to operate the solenoid		
6224AL	See chart on page 14 to make the proper selection	SO24	Converts 24 VAC voltage to 24 VDC to operate the solenoid		
6225	See chart on page 14 to make the proper selection				
6226	See chart on page 14 to make the proper selection				

6300 Series surface mounted strike for rim exit devices

Overview

Von Duprin electric strikes are known for their reliability, durability and security. The 6300 Series is designed to withstand abuse. Its heavy-duty stainless steel construction is fully UL1034 and UL10C Listed.

6300 Series electric strikes are designed for use with a variety of rim devices. It interfaces with the latch mechanism of the exit device. The movable lip (keeper) allows a door to open even when the latch bolt is extended. This feature, called remote release, provides added benefits such as increased convenience and efficiency. The 6300 Series also provides added security and traffic control.

6300 Series electric strikes are ideal for aftermarket applications. It is easy to install without modifying or altering the door frame. To assure the proper selection of an electric strike on new applications, lockset compatibility charts are shown on the next page. When using a lockset not listed or when retrofitting a strike to an existing application, please contact Von Duprin technical support for application assistance.

The 6300 is fail-secure (FSE) only to achieve compliance with UL10C for fire-rated openings. In a fail-secure application, the door is normally locked. To unlock the door, power must be applied. The 6300 strike can be used with either 12VDC or 24VDC. There are 2 connectors that ship with it and the appropriate connector for either 12VDC or 24VDC will be used, based upon the available voltage at the opening.

Features

- Non-handed design provides greater flexibility
- Requires no alteration or cutting to existing frame
- UL1034 burglary-resistant and
- UL10C electric strike for fire door
- Stainless steel (satin) finish
- Durable stainless steel construction
- Field selectable voltage 12VDC or 24VDC
- Meets BHMA A156.31, Grade 1 for endurance and strength
- Static strength 1300 lbs
- Dynamic strength 70 ft-lbs
- Endurance 1,000,000 cycles



6300 Surface mount specifications

Model	Voltage	Current	Duty	Amps	Ohms
6300	12V	DC	Continuous	0.50	22
6300	24V	DC	Continuous	0.24	89

Rim exit device compatibility 6300 strikes

Manufacturer	Model Number
Von Duprin	VD 22/22-F Rim
Von Duprin	VD 33A/35A Rim
Von Duprin	VD 55 Rim
Von Duprin	VD 88/88-F Rim device
Von Duprin	VD 98/99 and 98/99-F Rim
Falcon	Falcon 24/24-F Rim
Falcon	Falcon 25/25-F Rim
Falcon	Falcon 19/19-F Rim
Falcon Doromatic	Falcon Doromatic 1790
Falcon Doromatic	Falcon Doromatic 2090

Model specifications

Model #	6300
Retrofits model	N/A
Latchbolt throw	3/4"
Face plate length	9"
Projection	3/4"
Lockset	Rim exit device
# Doors	Single or pair with mullion
Door/frame type	Hollow metal, aluminum and wood
EB (entry buzzer)	Optional
Certifications	UL1034, UL10C
Application notes	Surface mounted electric strike ideal for aftermarket applications. Strike designed for use with Von Duprin 98/99, however it can be used with most rim exit devices.

6300 Series dimensions

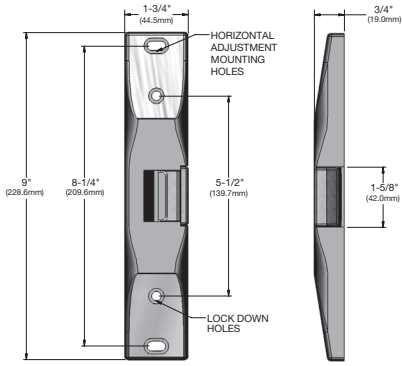

DC = Direct current

Continuous duty = Energized 1 min. or more

Note: When using device not listed or when retrofitting a strike to an existing application, please contact Von Duprin Technical Support for application assistance.

Ordering information

6300 - S024 - EB

Model	Rectifier kit*	Buzzer*
1	2	3

* Optional

1	Model
6300	Surface mounted strike for rim exit devices
2	Rectifier kit (optional)
S012	Converts 12 VAC voltage to 12 VDC to operate the solenoid
S024	Converts 24 VAC voltage to 24 VDC to operate the solenoid
3	Buzzer (optional)
EB	Entry buzzer

Standard features

- Power failure mode: Fail-Secure (FSE)
- Voltage: field selectable 24 VDC or 12 VDC
- Finish: stainless steel, satin (US32D/32)

AC

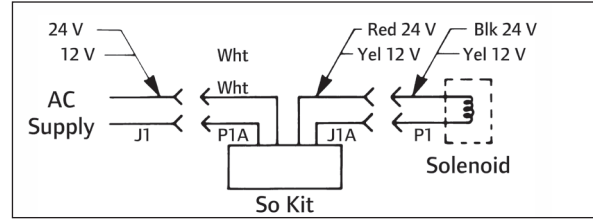

AC with buzzer

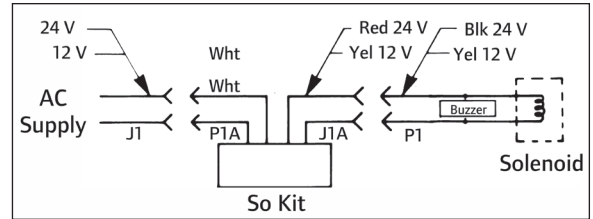

DC

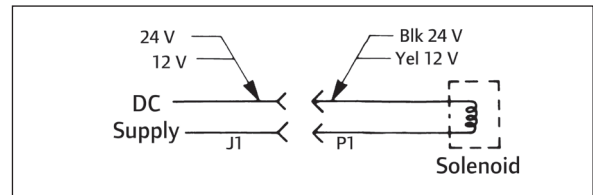

DC with buzzer

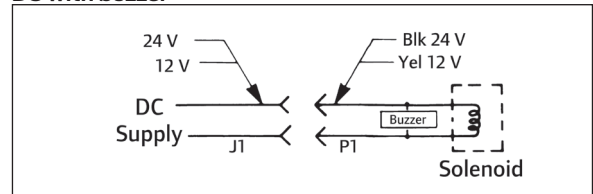

Electric Strike/Lock information

Finishes

US number	BHMA number	Description	Von Duprin number
US3	—	Plated polished brass on stainless steel	85
US4	—	Plated dull brass on stainless steel	84
US10	639	Plated dull bronze on stainless steel	06
US10B	640	Plated dark bronze on stainless steel	86
US32	629	Stainless steel, polished	31
US32D	630	Stainless steel, satin	32

Wire size selection

Current requirement at 24VDC				
Length of wire run (in feet)	0-.5 Amp	.5-1 Amp	1-2 Amp	2-3 Amp
0-100	18	18	18	18
100-200	18	18	18	16
200-300	18	18	16	14
300-450	18	16	14	12
450-600	18	16	12	NR
600-900	16	14	NR	NR
900-1200	14	12	NR	NR

NR – Not recommended

Cross reference

Name	Strike/Lock mounting	# Doors	Frame material (SGL DR) Door material (BL DR)	Faceplate length	Drop in replaces Von Duprin:	Drop in replaces Folger Adam:
6111	Rim device	Single ¹	All	6"	3031	
6112	Rim device	Single	All	9"		310-44
6113	Rim device	Single	All	6"	3011, 3021	
6114	Rim nightlatch	Single	All	7"		310-55
6121	Rim device	Double-closed back	All	9"		310-4-1005
6210	Mortise	Single	HM/Alu	4 ⁷ / ₈ "		
6211	Mortise or cylindrical	Single	HM/Alu	4 ⁷ / ₈ "	3140	712
6211AL	Mortise or cylindrical	Single	Aluminum	4 ⁷ / ₈ "		722
6211WF	Mortise or cylindrical	Single	Wood	4 ⁷ / ₈ "		7326
6212	Mortise or cylindrical	Single	HM/Alu	6 ³ / ₈ "	3146	
6212WF	Mortise or cylindrical	Single	Wood	6 ³ / ₈ "		
6213	Mortise or cylindrical	Single	All2	6"	3041, 42, 61, 62	
6214	Mortise or cylindrical	Single	All3	9"		310-2 3/4
6215	Mortise or cylindrical	Single	All3	9"		310-2
6216	Mortise and deadbolt	Single	HM/Alu	9"		310-3-1
6221	Mortise or cylindrical	Double-open back	All	6"	3071, 72	
6222	Mortise or cylindrical	Double-open back	HM/Alu	9"		310-2 3/4 OB
6223	Mortise or cylindrical	Double-closed back	All	6"	3091, 3092	
6224	Mortise or cylindrical	Double-closed back	HM/Alu	9"		310-2 3/4
6224AL	Mortise or cylindrical	Double-closed back	Aluminum	9"		310-2 RF
6225	Mortise or cylindrical	Double-open back	HM/Alu	9"		310-2 OB
6226	Mortise or cylindrical	Double-closed back	HM/Alu	9"		310-2

¹Includes double door with mullion.

²Recommended on wood frames only if drop in replacement is needed for 3041, 42, 61, 62 on wood frames. Otherwise use 6211WF.

³Recommended on wood frames only if drop in replacement is needed for 310-2 3/4, 310-2 on wood frames. Otherwise use 6211WF.

⁴Strike lip area cutout is slightly larger than Folger Adam.

⁵Surface applied strike. Mounting hole locations different from Folger Adam.

⁶Wood frame horizontal solenoid location differs from Folger Adam. May require frame prep modification when retrofitting.

E996L Electrified Breakaway™ lever trim

E996L Electrified Breakaway lever trim provides remote locking and unlocking capabilities while incorporating the patented Breakaway trim design.

The 24VDC solenoid can be energized from a distant controller, thus allowing access control of the opening. The control of stairwells in high-rise buildings is a common application for this trim.

When electrically unlocked the unit operates as a normal lever trim. When electrically locked, the lever feels locked, but when more than 35 pounds of torque pressure is applied, the Breakaway lever feature engages.

The E996L is provided standard in a fail safe (FS) condition, but can be field converted to a fail secure (FSE) where allowed. The trim can be ordered with a device, added to an existing 98/99 series device application, or a conversion kit can be added to an existing 996L Breakaway lever trim. On new construction applications, the E996L trim will require less door prep.

The E996L is available with a blank escutcheon (BE) function, or with cylinder operation for night latch (NL) function.

The E996L electrified trim replaces the current "E" electric feature on 98/99 series rim devices. Consult factory for requirements.

To order, specify:

1. Use "E" prefix, example E996L.
When ordering with device specify trim series with "E" prefix, example 9927L-BE 3' US26D E996.
2. Device type, R/V (rim/surface or concealed vertical rod) or M (mortise).
3. RHR is furnished standard if not specified. Field reversible.
4. Lever style (O6 lever is furnished standard).
5. Finish: US3, US4, US10, US10B, SP313, US26, US26D, SPBLK, US15

Specifications

Solenoid – continuous duty 24VDC

Solenoid draw – 0.22 amp



E996L Electrical wiring

- Power input for E996L is 24VDC
- Two wires on trim are non-polarized (18 AWG minimum)

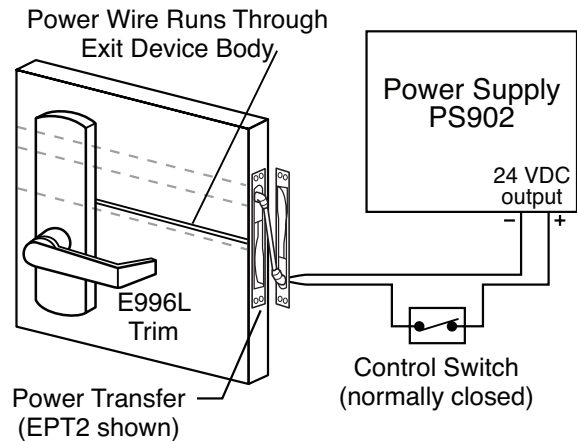

Lever styles

Decorative Levers



M51
Knurling available



M52
Knurling available



M53



M54



M55



M56



M57 **



M61
(Handed)



M62 **
(Handed)



M63
(Handed)



M81
Knurling available



M82



M83



M84



M85
(Handed)

** Available in Stainless Steel substrate ONLY.

Standard Levers



01



02
Knurling available



03*
Knurling available



05



06*
Default lever
Knurling available



07



12
(Handed)



16
(Omega)



17*
Knurling available



18



ACC
(Accent)
(Handed)



AST
(Asti)
(Handed)



MER
(Merano)
(Handed)



STA
(St. Annes)
(Handed)



LAT*
Latitude



LON*
Longitude

*Available in Stainless Steel - specify SS when ordering

EL/QEL Electric latch retraction



EL Electric latch retraction

The EL feature allows for the remote unlatching of exit devices. A control station operator can flip a switch to retract the latch bolt and immediately change an exit door to push-pull operation. A powerful, continuous duty solenoid retracts the latch bolt, either for momentary unlatching, or for extended periods of time. The EL feature is an alternative to manual dogging.

If manual hex-key dogging is required, specify HD-EL. If cylinder dogging is required, the standard cylinder dogging is not available, but special center case dogging is available, specify SD-EL. SD-EL is not available on the 9875 or 9975 devices.

EL devices are also useful with automatic door operators, and may be applied to fire-rated applications when under the control of an **automatic fire alarm system**.

UL approved for Class II circuit applications.

The EL option does not include the power transfer from door to frame, the power supply, or the control operator. Refer to EPT-2 power transfer and the PS914 power supply.

The PS914 with the 9002RS option card is the minimum option card required. Other option cards available for other functions, see PS914 power supply for additional information.

Solenoid specifications:

Continuous duty – 24 VDC
Current inrush – 16 Amps
Current holding – 0.3 Amps

Solenoid resistance:

-grn-yel 1.2 – 2.2 OHMS
-grn-org 100 – 150 OHMS

To order, specify:

Standard – use prefix **EL**, example **EL99L**.

Hex Key dogging – Use prefix **HD-EL**, example **HD-EL99L**
special center case dogging – Use prefix **SD-EL**, example **SD-EL99L**

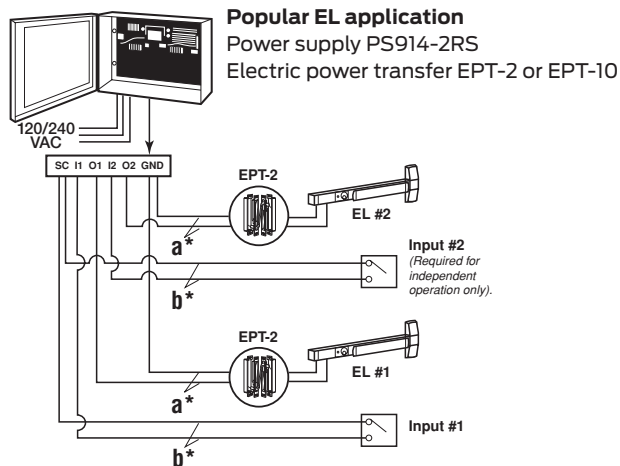

Von Duprin exit device	EL Wire length (feet) ¹	Wire gauge (AWG)
EL 98/99 Rim	0-500	12
EL 33A/35A Rim	0-300	14
	0-200	16
a* All other 98/99EL and EL33A/35A device types	0-250	12
	0-150	14
	0-100	16
b* Control Switch	0-1200	18

1. Wire lengths include an EPT, Door loop, electric hinge or pivot and are measured one way between the PS914/option board and the device.
2. Table is applicable to devices that have shipped after August 2012.

QEL Quiet electric latch retraction

The QEL feature allows for the remote unlatching of exit devices. A control station operator can flip a switch to retract the latch bolt and immediately change an exit door to push-pull operation. Different than the popular EL, the QEL quiet operation is achieved using an electric drive motor which retracts the latch bolt either momentary unlatching or for extended periods of time. This feature is an alternative to manual dogging.

If cylinder dogging is required, the standard cylinder dogging is not available, but special center case dogging is available, specify

SD-QEL. SD-QEL is not available on the 9875 or 9975 devices.

QEL devices are also useful with automatic door operators, and may be applied to fire-rated applications when under the control of an automatic fire alarm system.

UL approved for Class II circuit applications.

The QEL option does not include the power transfer from door to frame, the power supply, or the control operator. Refer to EPT-2 power transfer and the PS902 or 914 power supply.

The PS902/914 with the 2RS, 4RL or 4R board is the minimum required. Other option boards available for other functions, see PS902/914 power supply for additional information.

The QEL has a low inrush current, so it can be used with standard Schlage power supplies. Calculate the peak current draw of all devices in the system to determine the required amperage of the supply.

QEL Electrical load	
Voltage	24VDC
Current	1.0 A Inrush (0.5 sec.) / 0.14 A Holding

The 900-2RS option board designed to control two electric latch retraction devices and provide time delay between the firing of outputs is required. The power transfer is also sold separately.

Schlage PS902	Schlage PS904	Schlage PS906
up to 2 amps	up to 4 amps	up to 6 amps

To order, specify:

Standard – use prefix **QEL**, example **QEL99L**.

Special center case dogging – use prefix **SD-QEL**, example **SD-QEL99L**

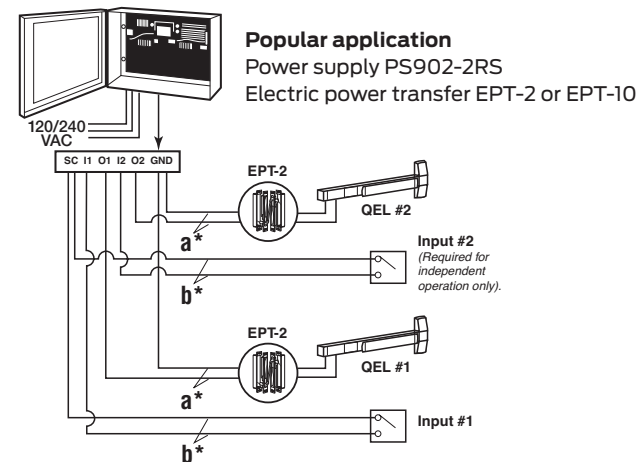

a* Distance (one-way)	Wire gauge
200´	18 AWG
320´	16 AWG
500´	14 AWG
800´	12 AWG

b* Wire selection	Switch wire size
1200 ft. Max.	18 gauge standard

RX/LX Switches

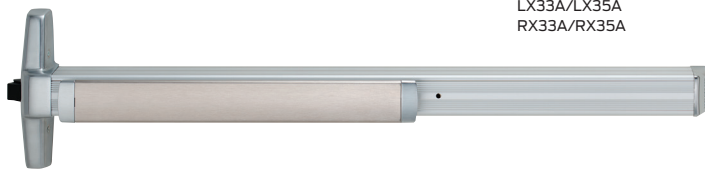

LX33A/LX35A
RX33A/RX35A

RX Request to exit

The RX (2xit) feature is used to signal the use of an opening. This device is equipped with one internal SPDT switch which monitors the pushpad.

The device can be connected to a security console, or may be used as a single door alarm when used with a horn and power supply.

The RX switch option should not be used to control a load, but as a signalling switch (0.5 amps. resistive maximum).

The RX switch is available in a low current (LC) switch. Most commonly used in computer operated monitoring systems.

To order, specify:

- Standard – Use prefix RX, example RX99EO
- Low Current – Use prefix RX-LC, example RX-LC98EO

RX2 Double request to exit

The RX2 feature uses two RX switches.

To order, specify:

- Standard – Use prefix RX2, example RX299EO

WP-RX Waterproof request to exit



LX98/LX99
RX98/RX99

Rim device shown — Refer to 33A/35A or 98/99 series catalog for complete product information, mounting styles, outside trim, finishes, etc.

LX Latchbolt monitoring



The LX feature is used to signal the use of an opening. This device is equipped with one internal SPDT switch which monitors the latch bolt.

The device can be connected to a security console, or may be used as a single door alarm when used with a horn and power supply.

The LX switch option should not be used to control a load, but as a signalling switch (0.5 amps. resistive maximum).

The LX switch is available in a low current (LC) switch. Most commonly used in computer operated monitoring systems.

To order, specify:

- Standard – Use prefix LX, example LX99EO
- Low Current – Use prefix LX-LC, example LX-LC98EO

Electrical rating for all switches:

- Standard – 2 Amp maximum @ 24VDC
- Low Current (LC) - below 50 Milliamps @ 24VDC

Note: All switches can be either factory or field installed

SS Signal switch



Monitors pushpad and latch bolt

The SS feature is used to signal the unauthorized use of an opening. This device is equipped with two internal SPDT switches. One switch monitors both the pushpad and the latch bolt assembly, making the latch bolt tamper resistant, for positive security. An additional SPDT switch is connected to the 1 1/4" (32mm) mortise cylinder with straight cam for alarm "bypass." (Schlage cam reference B502-191). The device can be connected to a security console, or may be used as a single door alarm when used with a horn and power supply.

Pushpad reads: "Emergency Exit ONLY – Push To Open And Sound Alarm." Pushpad is only available in US32D finish with red silk-screened lettering.

The SS mortise lock device is furnished with both the signal switch device and the SS7500 mortise lock. The SS7500 mortise lock has the versatility and advantages of the 7500 lock with the addition of signalling functions to monitor latch bolt operation and the trim locking function. The SS7500 mortise lock is supplied standard with the SS mortise lock device.

To order, specify:

1. Prefix SS, example SS99L.
2. Handing required, LHR or RHR.

Electrical ratings:

Up to 2.0 AMPS @ 24VDC

Popular SS Application

Unauthorized use of this opening will activate the local horn. The key switch permits inhibiting this system for authorized entry.

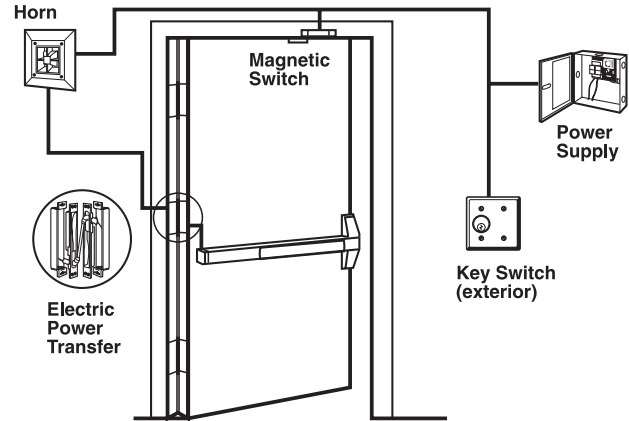

RX330/RX350 Push pad



RX330

RX330 and RX350 bar features an active push pad with monitoring switch or "request to exit" switch, used to inhibit alarms for authorized exiting. The 330 grooved outer case and the 350 smooth outer case are designed as companion units for series 33A, 35A, 98 and 99 exit devices.

The RX switch option is also available on 55DU and 88DU crossbars, and are designed as companion units for series 55 and 88 exit devices.

The internal SPDT switch should not be used to control a load, but as a signaling switch.

Minimum door openings:

- | | |
|-------------|-----------------------------|
| 3' (914mm) | 2'6" (762mm) to 3' (914mm) |
| 4' (1219mm) | 3'1" (940mm) to 4' (1219mm) |

To order, specify:

1. Prefix series 330 or 350 with "RX".
- Example, RX330
2. Size 3' or 4' (3' supplied standard if size not specified)
3. Finish: US3, US4, US10, US28, US26, US26D, 313AN, 315AN

Specifications

SPDT 0.5 ampere @ 24VDC Solenoid draw - 0.22 amp

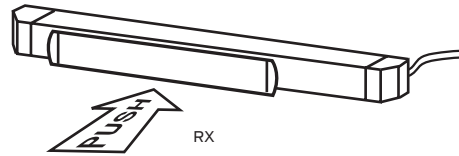
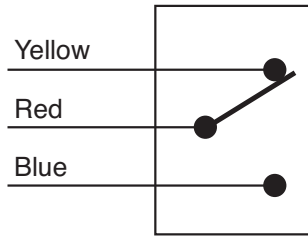

Chexit device - 33A/35A & 98/99 Series

Chexit® (with motor driven blocking actuator)*

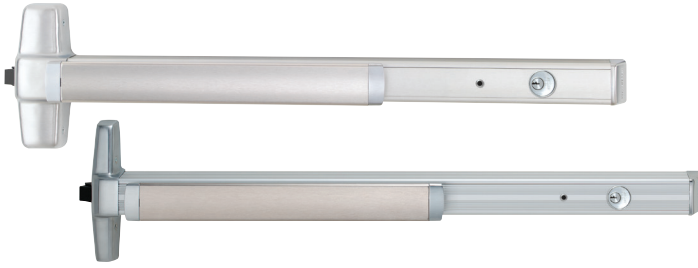

The Von Duprin Chexit device is designed for controlled egress applications. It is UL294 listed and meets 2015 International Building Code (IBC) sections 1010.1.9.7 Delayed Egress and 1010.1.9.6 Controlled Egress and National Fire Protection Associations (NFPA) sections 7.2.1.6 Special Locking Arrangements. All control inputs, auxiliary locking, local alarm and remote signaling outputs are self-contained in the Chexit assembly. Numerous configurable options allow the device to be customized for the specific code or application requirements. The standard Chexit device sounds an alarm and keeps the door secured for 15 seconds following an exit attempt with immediate release upon fire. Included with each device is a 6" x 20" decal for application on the door reading "PUSH UNTIL ALARM SOUNDS. DOOR CAN BE OPENED IN 15 SECONDS".

Minimum door opening sizes for CX devices

Consult factory for other size requirements.

Device	3' (914mm) Length	4' (1219mm) Length
CX33A/35A	2'10 3/4" (883mm)	3'4 3/4" (1035mm)
CX3327A/3327A-F/3527A/3527A-F	2'10 1/4" (870mm)	3'4 1/4" (1022mm)
CX3347A/3347A-F/3547A/3547A-F	2'10 1/4" (870mm)	3'4 1/4" (1022mm)
CX3348A/3348A-F/3548A/3548A-F	2'10 1/4" (870mm)	3'4 1/4" (1022mm)
CX3349A/3349A-F/3549A/3549A-F	2'10 1/4" (870mm)	3'4 1/4" (1022mm)
CX3350/3350WDC-F/3550/3550WDC-F	2'10 1/4" (870mm)	3'4 1/4" (1022mm)
CX98/98-F/99/99-F	2'10 3/4" (883mm)	3'4 3/4" (1035mm)
CX-XP98/XP98-F/XP99/XP99-F	2'10 3/4" (883mm)	3'4 3/4" (1035mm)
CX9827/9827-F/9927/9927-F	2'10 1/4" (870mm)	3'4 1/4" (1022mm)
CX9847/9847-F/9947/9947-F	2'10 1/4" (870mm)	3'4 1/4" (1022mm)
CX9848/9848-F/9948/9948-F	2'10 1/4" (870mm)	3'4 1/4" (1022mm)
CX9849/9849-F/9949/9949-F	2'10 1/4" (870mm)	3'4 1/4" (1022mm)
CX9850/9850WDC-F/9950/9950WDC-F	2'10 1/4" (870mm)	3'4 1/4" (1022mm)
CX9857/9857-F/9957/9957-F	2'10 1/4" (870mm)	3'4 1/4" (1022mm)
CX9875/9875-F/9975/9975-F	2'10 1/4" (870mm)	3'4 1/4" (1022mm)

Electrical specifications

Specifications / Power requirements*
Input voltage – 24VDC
Input current inrush – 1.25A
Input current holding – 390mA
Alarm relay and Secure relay contact ratings – 24VDC, 1A
Fire alarm, Inhibit and Door position switch inputs require normally closed dry contacts.

Chexit riser diagram - Single door

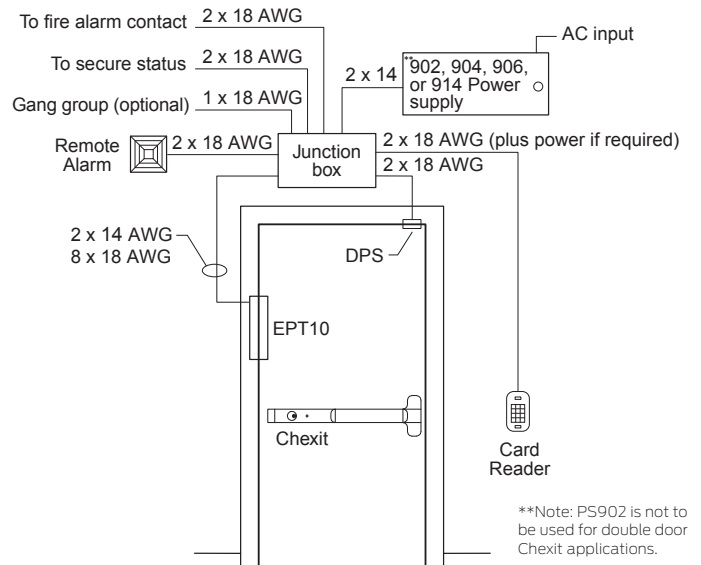

Figure 1. Riser Diagram, Single Door

Power supply information for CX devices with motor driven blocking actuator*

Power supply	Maximum number of devices*
PS902 (up to 2 amps)	1 Chexit device
PS904 (up to 4 amps)	3 Chexit devices
PS906 (up to 6 amps)	4 Chexit devices
PS914 (up to 4 amps)	4 Chexit devices

When powering multiple components, verify that the amperage requirements of all components combined does not exceed the power supply output rating. Consult Installation Instructions for proper wire gauge and wire run requirements. Exceeding the recommended devices and/or not following Installation Instructions may void your warranty. For more information call Customer Care at 877-671-7011.

How to order*

1. Prefix product description number "CX". Ex: CX99L
2. Specify option. Ex: CX-RCM or CD-CX
3. Door size other than 3' (914mm).
4. Door thickness other than 1 3/4" (45mm).
5. Finish.
6. Handing, LHR or RHR. Required with "CD" option.

*Note: The information listed in these pages reference the power supply and operating requirements for the redesigned Chexit with motor driven blocking actuator that launched August 24, 2015. For information on devices built previous to August 24, 2015, please contact Customer Care at 877-671-7011.

RCM Remote Chexit Module

RCM Remote Chexit Module — Designed to provide the concept of the Chexit delayed exit system for door sizes smaller than the standard device can accommodate. The Chexit module is installed in a control box and mounted in a remote location. Features and functions of the standard Chexit exit device are available on the RCM.



RCM Module

Minimum door opening sizes for RCM devices

Consult factory for other size requirements.

Device	3' (914mm) Length	4' (1219mm) Length
CX-RCM33A/35A	2'5" (737mm)	2'11" (889mm)
CX-RCM3327A/3327A-F /3527A/3527A-F	2'4½" (724mm)	2'10½" (876mm)
CX-RCM3347A/3347A-F /3547A/3547A-F	2'4½" (724mm)	2'10½" (876mm)
CX-RCM3348A/3348A-F /3548A/3548A-F	2'4½" (724mm)	2'10½" (876mm)
CX-RCM3349A/3349A-F /3549A/3549A-F	2'4½" (724mm)	2'10½" (876mm)
CX3350/3350WDC-F/ 3550/3550WDC-F	2'4½" (724mm)	2'10½" (876mm)
CX-RCM 98/98-F/99/99-F	2'5" (737mm)	2'11" (889mm)
CX-RCM XP98/XP98-F/XP99/XP99-F	2'5" (737mm)	2'11" (889mm)
CX-RCM 9827/9827-F/9927/9927-F	2'4½" (724mm)	2'10½" (876mm)
CX-RCM 9847/9847-F/9947/9947-F	2'4½" (724mm)	2'10½" (876mm)
CX-RCM 9848/9848-F/9948/9948-F	2'4½" (724mm)	2'10½" (876mm)
CX-RCM 9849/9849-F/9949/9949-F	2'4½" (724mm)	2'10½" (876mm)
CX-RCM 9850/9850WDC-F/ 9950/9950WDC-F	2'4½" (724mm)	2'10½" (876mm)
CX-RCM 9857/9857-F/9957/9957-F	2'4½" (724mm)	2'10½" (876mm)
CX-RCM 9875/9875-F/9975/9975-F	2'5½" (743mm)	2'11½" (902mm)

Specifications / Power requirements*

Size – 3.75" x 5.57" x 2.50"

Input voltage – 24VDC

Input current inrush – 1.25A

Input current holding – 390mA

Alarm relay and Secure relay contact ratings – 24VDC, 1A

Fire alarm, Inhibit and Door position switch inputs require normally closed dry contacts.

How to order*

See Chexit "How to order" on previous page.

*Note: The information listed in these pages reference the power supply and operating requirements for the redesigned RCM modules with motor driven blocking actuator that launched August 24, 2015. For information on devices built previous to August 24, 2015, please contact Customer Care at 877-671-7011.

DE5300 Delayed Egress System

DE5300 Delayed Egress System — Designed for controlled egress applications when used in conjunction with a magnetic lock. It meets both life safety and security needs, as well as the requirements of NFPA for "Special Locking Arrangement" and IBC "Special Egress-Control Devices". All control units, auxiliary locking, local alarm and remote signaling outputs are self-contained in the DE5300 assembly.



DE5300 Module

The DE5300 is commonly used on narrow stile doors where a standard or narrow stile Chexit is not practical. DE5300 Delayed Exit System uses a Chexit logic board and a Von Duprin RX-LC (low current request to exit) panic device to control a Schlage Electronics Direct Hold Magnetic Lock.

The Chexit module for the DE5300 is installed in a control box and mounted in the wall adjacent to the door. Features and functions of the standard Chexit exit device are available on the DE5300.

Specifications / Power supply requirements

Size – 3.75" x 5.57" x 2.50"

Input voltage – 24VDC

Input current – 1A

Alarm relay and Secure relay contact ratings – 24VDC, 1A

Fire alarm, Inhibit and Door position switch inputs require normally closed dry contacts.

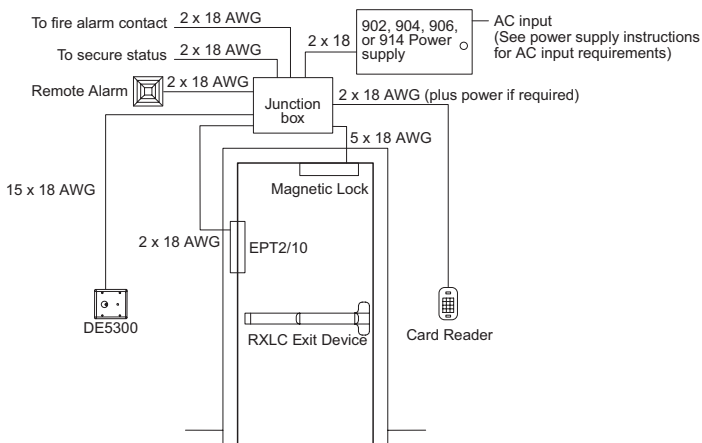

Figure 1. Riser Diagram, Single Door

How to order

1. DE5300
2. M420/P, M450/P, or M490/P magnetic lock (order direct from Schlage Electronics).
3. RX-LC 22/33A/35A/98/99 device.
4. PS900 Series
5. EPT-2/10

Chexit, RCM and DE5300 features

The Chexit, Remote Chexit Module (RCM) or DE5300 devices have several features and options available to fit your applications. See below for more information.

Inputs & Outputs

Fire Alarm Input

This input releases the door immediately upon a fire alarm allowing immediate egress. The Internal Alarm can be silenced during a fire input via an onboard switch setting.

Inhibit Input (Access Control)

This optional input is provided to allow authorized egress or entry when the device is Armed using an external card reader, Key Switch, etc. It also allows remote reset of the Chexit, RCM or DE5300 in an armed condition. The ability to reset alarms with the inhibit input can be disabled via an onboard switch setting.

Door Position Switch Input

An optional Door Position Switch (DPS) can provide door position status to Chexit, RCM or DE5300 for additional security, ensuring that the door is closed, and can cause alarm when the door is left or forced open.

Gang Bus

The Gang bus allows a Chexit, RCM or DE5300 device to signal other Chexit, RCM or DE5300 devices when it enters the Release Delay, allowing multiple doors to release at the same time in an emergency. Up to 8 devices may be connected to the Gang Bus.

Alarm Relay Contacts

The Alarm Relay contacts are provided as a means to control a Remote Alarm, such as a horn or lamp, or signal an external monitor. The contacts can be configured with a jumper as Normally Open or Normally Closed, and become active upon entering an alarmed condition.

Secure Relay Contacts

The Secure Relay contacts are provided as a means to signal an external monitor. The contacts can be configured as Normally Open or Normally Closed with a jumper, and become active when the DPS indicates the door is closed and the Push Pad is locked.

Delays

Release Delay

When the Push Pad is pushed and the Nuisance Delay expires, the Chexit, RCM or DE5300 enters the Release Delay with alarm. During the Release Delay, the Internal Alarm sounds, the Alarm Relay activates, and the Chexit/RCM keeps the Push Pad or DE5300 magnetic lock, locked for 15 seconds (less any time already elapsed during the Nuisance Delay). Once started, the Release Delay sequence will not stop and the devices will unlock.

Nuisance Delay

When a Chexit, RCM or DE5300 is located in a public area, it can be desirable to limit false releases when the Push Pad is accidentally pushed. The Nuisance Delay is the brief time a Push Pad can be accidentally pushed before the Release Delay sequence starts. If the Nuisance Time is set to 0 seconds the Chexit, RCM or DE5300 will enter Release Delay as soon as the Push Pad is pushed (when armed). Setting the Nuisance Time to 1, 2, or 3 seconds allows the Push Pad to be pressed for 1 to 3 seconds before the Chexit, RCM or DE5300 goes into Release Delay. If the Nuisance Audio and Nuisance Delay are both on, the Internal Alarm will pulse during the Nuisance Delay. The Alarm Relay does not activate during the Nuisance Delay. If the Push Pad is released before the Nuisance Delay expires, the Chexit, RCM or DE5300 will remain armed.

Rearm Delay

The Rearm Delay is the amount of time after the Key Switch or Inhibit Input is deactivated to when the device rearms. It is designed to give someone time to pass through the door before rearming occurs. The Rearm Time can be changed via the onboard switch settings from 0 and 28 seconds in 2 second increments. If the Rearm Time is set to 30 seconds and a DPS is used, if the door is opened and the Rearm Time expires, there will be no alarm. The Chexit, RCM or DE5300 will rearm after the door is closed. If the door never opens, the Chexit, RCM or DE5300 will rearm after 30 seconds. If not using a DPS, the Chexit, RCM or DE5300 will always rearm in 30 seconds.

DPS Delay

If the DPS detects that the door closed during the Rearm Delay, the Chexit, RCM or DE5300 ends the Rearm Delay and allows 2 seconds for the latch to clear the strike before rearming.

Interface

Key Switch

The Key Switch provides the means to Arm or Disarm/Reset the Chexit, RCM or DE5300. Turning the Key Switch clockwise initiates the Rearm Delay, and turning the Key Switch counter-clockwise Disarms/Resets the Chexit, RCM or DE5300. The Key Switch allows the key to be removed in either the Arm or the Disarm/Reset position.

Status Indicator

The red Status Indicator displays the status of the Chexit, RCM or DE5300. The Status Indicator flashes slow if the Chexit, RCM or DE5300 is armed, flashes fast in an alarmed mode, is off when inhibited and on solid during Rearm Delay.

Internal Alarm

The Internal Alarm sounds the status of the Chexit, RCM or DE5300. The Internal Alarm sounds continuously during and after a fire alarm or a Release Delay, pulses fast during the Nuisance Delay or a tamper and pulses slow during Disarmed Powerup mode.

Settings

Armed Powerup

When set to OFF, a power disruption and power return will put the Chexit, RCM or DE5300 in a disarmed, unlocked alarm mode.

Trim Fail Safe / Fail Secure (FS/FSE)

The trim input power can be set to FS (Fail Safe; locked when energized, unlocked when deenergized or during power failure) or FSE (Fail Secure; unlocked when energized, locked when deenergized or during power failure).

The trim must be bought or modified to physically function as FS or FSE. This on board setting only selects the trim input power.

Options

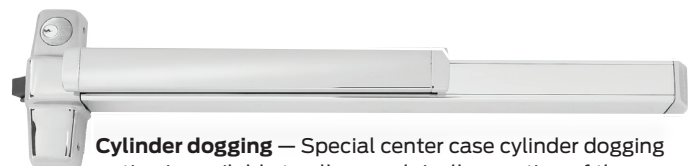

Cylinder dogging — Special center case cylinder dogging option is available to allow push/pull operation of the Chexit, when disarmed and used in a heavy traffic area. Prefix device with "CD" and specify handing.

Cylinders — Cylinders are not furnished with the Chexit, RCM or DE5300 devices and must be specified when ordering. Use 1 1/4" mortise cylinder with compression ring K510-406 with straight cam and orient cam as shown.

Schlage cylinder 20-001-114 recommended for the device and the CD cylinder dogging option. See Schlage Pricebook for additional information.

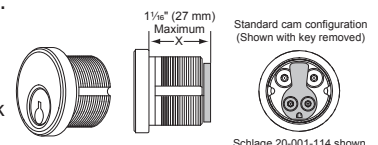

Schlage 20-001-114 shown

ALK Alarm kit



ALK Alarm kit is a simple yet effective way to deter unauthorized use of an opening. While the exit device is still a means of egress, the ALK kit contains an internal horn. When the touch bar is depressed, the horn sounds to provide an audible means of signaling that the opening has been violated. The alarm kit can be armed or disarmed by key thus allowing the exit device to be set in an armed or disarmed mode. The horn is rated at 85 decibels.

For Hardware Applications

The assembly includes both a 24VDC Input and External Inhibit standard. The External Inhibit provides remote arming and dis-arming.

The key switch uses a standard 1 1/4" (32mm) mortise cylinder with a straight cam (Schlage 20-001, B502-191 cam). The unit operates on one standard 9-volt alkaline battery. When the battery is weak, the horn will emit an intermittent low battery alert signal.

The alarm can automatically re-arm with a 1 1/2, 3 or 4 1/2 minute time delay upon request.

Alarm kits are available with a choice of two switch kits, RX or LX. RX monitors the touchpad and is furnished standard. LX optional latch bolt monitoring is recommended for use with surface vertical rod exit devices or when alarm needs to sound from both the exit device and trim side of the door. Specify ALK-LX.

Note: For latch bolt monitoring on a 98/9975 with ALK, specify a SS7500 lock. LX switch not available for 98/9975 devices.

ALK Alarm kit is a simple yet effective way to deter unauthorized use of an opening. While the exit device is still a means of egress, the ALK kit contains an internal horn. When the touch bar is depressed, the horn sounds to provide an audible means of signaling that the opening has been violated. The alarm kit can be armed or disarmed by key thus allowing the exit device to be

The ALK is available in two styles, 33A/99ALK, grooved cover and 35A/98ALK, smooth cover.

The ALK includes a 6" x 20" decal for application on door "EMERGENCY EXIT ONLY. ALARM WILL SOUND." RSS push bar trim can be used instead of the door decal, specify RSS push bar trim when ordering the device.

When the ALK is used, standard dogging is removed. If cylinder dogging is required there are two choices. Special center case dogging is available or for 3' or 4' doors. The ALK can be moved to the hinge side of the device and standard cylinder dogging can be added.

To Order, Specify:

1. Standard, 98 ALK
2. Cylinder Dogging, CD98 ALK
3. Special center case dogging, SD98 ALK (98/99 Series only)
4. If AR desired, specify AR 1.5, 3 or 4.5

Minimum door opening sizes on ALK applications

Device	3' (914mm) Length	4' (1219mm) Length
98/98-F/99/99-F	2'10" (864mm)	3'4" (1016mm)
9875/9875-F/9975/9975-F	2'10" (864mm)	3'4" (1016mm)
9827/9827-F/9927/9927-F	2'10" (864mm)	3'4" (1016mm)
9857/9857-F/9957/9957-F	2'10" (864mm)	3'4" (1016mm)
9847/9847-F/9947/9947-F	2'9" (838mm)	3'3" (991mm)
9848/9848-F/9948/9948-F	2'9" (838mm)	3'3" (991mm)

Minimum door sizes

Device	3' (914mm) Length	4' (1219mm) Length
33A/35A	2'9" (838mm)	3'3" (991mm)
3327A/3527A	2'8" (813mm)	3'2" (966mm)
3347A/3347A-F 3547A/3547A-F	2'8" (813mm)	3'2" (966mm)
3348A/3348A-F 3548A/3548A-F	2'8" (813mm)	3'2" (966mm)

GUARD-X Exit alarm lock



2670 GUARD-X provides secure, alarmed code-compliant protection for secondary emergency exits. The GUARD-X exit alarm lock readily identifies the door on which it is mounted as an emergency exit and secures the opening against unauthorized use. It is ideal for deterring theft in restaurants and retail establishments such as: discount stores, grocery stores, drug stores, clothing stores and sporting goods stores.

The GUARD-X lock provides secure protection through a large stainless steel deadbolt, which is 2" x 1/2" (51mm x 13mm) and has over 3/4" (19mm) throw. The engagement area into the strike is over 1 1/4" (32mm) square inches. The cast aluminum latch case protects the internal mechanism and resists tampering or vandalism from inside the door. This unit has been tested to withstand up to 1600 pounds of static load force against the door.

GUARD-X does not allow re-latching or resetting the alarm after an unauthorized exit, other than by an authorized person with a key. A 100-decibel alarm provides clear, attention getting warning for an unauthorized exit or attempted exit. The armed indicator light informs the owner that the alarm is armed, and an audible low-battery alert signals the owner to replace the battery when necessary.

A standard 9-volt battery powers the alarm. An exterior 9-volt power supply is available, Model PT-790, a 120VAC plug-in. When using the external power supply, the 9-volt battery functions as a battery backup during a power failure.

GUARD-X is armed and disarmed by key using a standard rim cylinder. It can be operated from the building exterior by a standard rim cylinder, so an authorized user can easily arm and disarm it to enter or exit the building when required. When using exterior operation a pull trim is recommended, use 210DT or 230DT. Rim cylinders are not furnished and must be ordered separately.

The 267 strike is furnished standard for single door applications. The optional 2609 strike is available for double door applications.

Touchbar height to finished floor	40" (1016mm) at center
Door width range	36" (914mm) to 48" (1219mm)
Touchbar projection —	
neutral	4 1/8" (103mm)
depressed	2 3/4" (70mm)
Latch case housing	7" (179mm) x 4 1/16" (103mm) x 4 1/8" (105mm)
Device length	32 1/2" (826mm)
Minimum stile requirement	Single door - 5 7/8", Double door - 6 1/4"

Note: Von Duprin trim does not thru-bolt to the Guard-X. Ives door pulls 8102-6 and 8105-6 offer dimensions that align and thru-bolt to the Guard-X Exit Lock - Order separately from Ives.

The GUARD-X non-handed design means the installer can mount it for either hand by just removing and reversing the "EMERGENCY EXIT - ALARM WILL SOUND" sign built into the device. The standard warning sign is in English with Braille; French and Spanish are available.

GUARD-X is UL/cUL listed for Panic Exit Hardware, complies with NFPA 101 Life Safety Code, meets UL305 requirements and is tested in accordance to ANSI A156.3 Grade 1 Panic Hardware. It is compliant with NFPA 101 Life Safety Code by providing a push pad that extends at least one-half the width of any door up to 48" wide. The impact-resistant end caps meet UL305 requirements by providing a design that will not catch on clothing during egress.

To order, specify:

1. Model 2670
2. Finish: US28, 313, 315.
3. Strike if other than standard 267.
4. Language if other than English.
5. Specify Rim Cylinder or Sex Bolts if required.
6. Outside trim if needed.

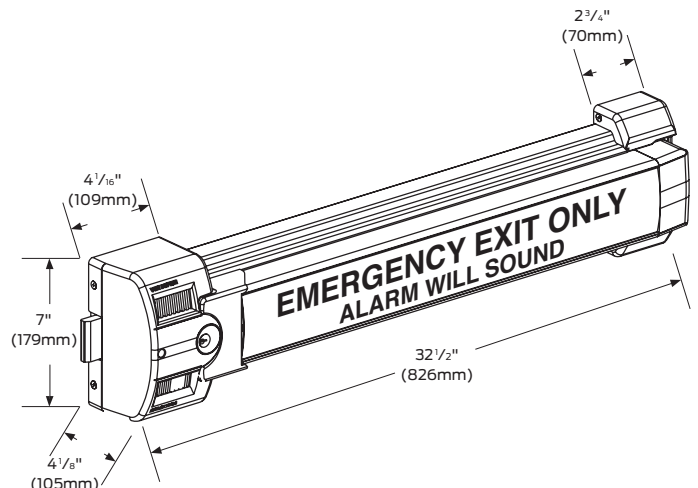

E7500 Electric mortise lock

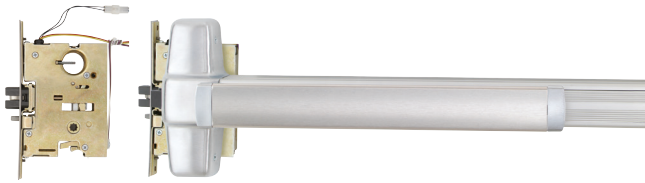

The electric mortise lock device has all the versatility and advantages of the standard mortise lock device, plus the advantage of being electrically controlled by a remote switching device, an access control system or an automatic fire alarm system. The device features the E7500 mortise lock. The E7500 controls the locking of the outside trim. When unlocked, the door remains latched, preserving the fire rating of the door and making it particularly useful where codes permit locking but require unlocking during a fire emergency. The outside trim cylinder retracts the latch bolt for mechanical override, night latch function. Only available with TP, K or L functions.

The E7500 lock contains a SPDT signal to monitor the outside trim condition (locked or unlocked) and a second SPDT signal switch to monitor the latch bolt.

Standard features:

- Field reversible handing
- 24 VDC continuous duty solenoid

Optional features:

- Fail safe (locked when energized, unlocked when de-energized or during power failure). Specify with suffix “FS.”
- Fail secure (unlocked when energized, locked when de-energized or during power failure). Specify with suffix “FSE”
- 24 VAC (with SO option)
- 12 VDC
- 12 VAC (with SO option)

Note: Some Fire codes will require “Fail Safe” (FS) operation for stairwell doors. Be sure to specify the correct operation for your application.

Electrical specifications:

- Solenoid — .60 AMPS @ 12VDC
.30 AMPS @ 24VDC
- Each switch — Up to 2.0 AMPS @ 24VDC Maximum

The E option does not include the power transfer from door to frame, the power supply or the control operator. (Refer to EPT-10 and PS902 or PS914 power supply)

To order, specify:

1. Use prefix “E,” example E9975.
2. FS or FSE
3. Voltage and current.

Electric mortise lock device

Adaptable for openings where continuous latching is required while the trim may be electrically locked or unlocked from a remote location—stairwells, exterior doors, etc.

Minimum system requirements:

- PS902
- EPT-10

Allegion Connect

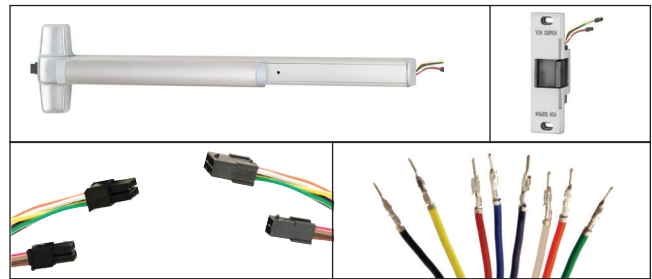

Allegion’s cross-category Connect features common interconnect components to our electrified options. Allegion Connect is a quick and easy way to connect power sources; all the way from your power supply to locking device. There is no wire cutting; reducing installation and maintenance time ultimately cutting cost. After installation, Allegion’s Connect continues to provide benefits throughout the lifetime of the opening by offering a service kit for repairs or modifications in the future.

Features and benefits

- Quick: common connections reducing installation time
- Perfect Connections: these factory installed connectors ensure the right wires match up every time
- Protective: the connectors protect the connection points throughout the installation process and lifetime of the opening
- Interchangeable: all Allegion Connect products utilize the same connectors
- Maintenance: you no longer need to cut away wire to disconnect Allegion products, also available is a service kit specifically for Connect products.

Harness length	Connectors on both ends	Connectors on one end, crimped pins on the other end
6 Inches	CON-6	CON-6P
12 Inches	CON-12	CON-12P
26 Inches	CON-26	CON-26P
32 Inches	CON-32	CON-32P
38 Inches	CON-38	CON-38P
44 Inches	CON-44	CON-44P
50 Inches	CON-50	CON-50P
192 Inches	CON-192	CON-192P

Power Supply Wire Harness = Connectors on one end, stripped leads on the other end, offering a direct connection to the power supply

6 Inches	CON-6W - wire extension to power supply
----------	---

Consult door manufacturer for harness length requirements.

Note: You will need to purchase a separate wiring harness to go from exit device to hinge/EPT and an additional harness to go from hinge/EPT to power supply or access control system. Harness part numbers with ordering information can be located in the Schlage, Von Duprin and Falcon pricebooks. A service kit is available for order in the Schlage, Von Duprin and Falcon pricebooks. Included in this kit are male end plugs, female end plugs and pins to customize harnesses to your application.

Note: Must be ordered with exit devices and locks

How to order

1. Specify CON for Connect electronic options
Example: EL-99-EO-CON (99 Series Electrified Latching exit only with Connect connectors)
2. Specify harness length; Consult door manufacturer for harness length
3. Specify Von Duprin EPT10-CON or Ives 7200 power transfer hinge

Wire run options

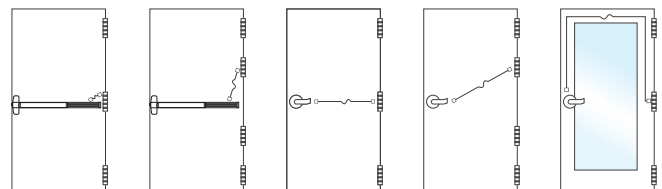

Electrical options

Power Supplies

Series PS902/914



Overview:

The PS900 Series is a consolidated line of power supplies and accessories that offer enhanced flexibility and functionality specific to the changing needs of the access control market. The PS900 Series can be used in a variety of applications to convert high voltage AC power into the low voltage DC outputs required by most access control devices. The PS900 Series protects devices downstream by providing Class 2*, filtered and regulated power. The full line is UL294 certified.

Note: PS906 can provide Class 2 rated outputs when used with 900-8P distribution board.

Features:

- Constant output rating at both 12 VDC and 24 VDC provides superior performance ; includes field selectable jumper
- Polarized connectors for option boards eliminate need for racks and side connectors
- Flat mounting of option boards provides easier access to terminal blocks for connection of electrified devices
- High voltage protective cover
- Battery back-up board auto-selects voltage
- Fire alarm relay can be configured to provide either switched or un-switched outputs from a power supply
- PS914 designed with high in rush current for powering electrified panic devices
- Universal 120-240 VAC input
- Low voltage DC, regulated and filtered
- Electronic power limiting foldback circuit for AC current overload protection
- Fused primary input
- AC status monitor- isolated SPDT contacts
- AC input and DC output LED status indicators
- Cover mounted AC input indication
- Hinged cover with lock down screws

Certifications:

- UL 294 certified—the standard for access control
- Class 2 rated*

* Except PS906, output rating exceeds Class 2 power limits

Once power is converted to low voltage DC, the PS900 Series offers a variety of distribution options, including basic fuse protection, simple relay, and advanced logic providing complex sequencing and timing functions.

* PS906 can provide Class 2 rated outputs when used with 900-8P distribution board.

	PS902	PS904	PS906	PS914
Number of connectors on power supply for the following:	2 amps	4 amps	6 amps	4 amps
Distribution boards	1	2	3	2
Battery back-up board	1	1	1	1

Note: One fire alarm board can be connected directly to the PS902. If a fire alarm board is desired for the PS904, PS906 or PS914 it can be connected to a distribution board.

Applications:

The PS900 Series of power supplies works with many electrified devices including Schlage electromagnetic locks, Schlage AD-Series hardwired locks, Schlage electrified mechanical locks, Von Duprin electrified strikes , Von Duprin exit devices, and many other brands.

Accessories:

The Schlage PS900 Series features seven option boards for use in a variety of applications. All Schlage PS900 Series power supplies option boards are UL 294 certified.

Option boards:

900-4R: 4 relay controlled output board to power multiple devices

900-4RL: 4 relay distribution board with logic is field configurable for time delay function, auto operator, security interlock

900-8F: Provides 8 individually fuse-protected outputs, giving the flexibility to power multiple devices and provide another layer of protection

900-FA: Emergency interface relay integrates with fire alarm and is used to cut power in case of emergency

900-BB: Battery backup

900-2RS: 2 relay EL panic device control board (PS914 only)

900-BBK: Battery backup kit includes two 7A/hr batteries and provides up to four hours of backup power when cycled every 5 minutes at full load

Electric power transfer accessories

EPT Electrical power transfer

PNT Pneumatic transfer

Electric Power Transfer provides a means of transferring electrical power from a door frame to the edge of a swinging door. The units are completely concealed when the door is in the closed position, and are ideal for installations involving abuse or heavy traffic.

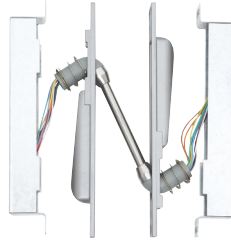

Two models are available; EPT-2, two 18 gauge wires and EPT-10, ten 24 gauge wires. The EPT-2 and EPT-10 are U/L listed as "miscellaneous door accessory".

UL Listed for use on fire doors

Door applications:

up to 5" butt hinges – 180° swing,

5 1/2" butt hinges – 130° swing,

6" butt hinges – 110° swing,

3/4" butt offset pivots 180° swing.

Not for use with swing clear hinges or center-hung pivots.

Finishes

SP28 (sprayed aluminum)

SP313 (sprayed duranodic).

Dimensions

Housing	9" x 1 1/4" x 1 5/8" (229mm x 32mm x 38mm)
EPT-2	Two 18 gauge wires, Up to 2 AMPS @ 24VDC, with a 16 AMPS Maximum Surge
EPT-10	Ten 24 gauge wires, Up to 1 AMPS @ 24VDC, with a 16 AMPS Maximum Surge
PNT-1	5/32" Tubing

To order, specify:

1. EPT-2, EPT-10 or PNT-1.

2. Finish, SP28 or SP313.

Electromagnetic locks

Schlage has a rich heritage in electronic security. For years we have led the industry by providing a broad portfolio of solutions to meet the diverse needs of the market. Today, our electromagnetic locking portfolio continues to evolve to meet your changing needs.

Schlage electromagnetic locks are used to secure the door in conjunction with push bars, request to- exit devices, or credential readers for fail-safe applications when code compliance permits. You can use them on a single standalone door or as part of an access control system. Electromagnetic locks do not contain moving parts, making them extremely durable and preferred for high security applications.

Electromagnetic locks consist of an armature and a coil assembly, which become magnetized when an electric current passes through them. This magnetic field secures the door. Electromagnetic locks are fail-safe by design. To unlock the door simply remove power.

M400 Series electromagnetic locks

The M400 Series is a robust line of electromagnetic locks with unique new design elements that make them easy to install and secure.

Features:

- Auto voltage selection is standard
- Plus Package (P) adds magnetic bond sensor, relocking time delay, door status monitor
- Optional mounting kits available including: Top Jamb Mount, Double and Glass Door

Certifications:

- UL 1034
- UL 10C 3 hour fire rating
- BHMA Grade 1
 - M420 – 500 lb. hold force for traffic control
 - M450 – 1000 lb. hold force for high security
 - M490 – 1500 lb. hold force for max security

Electromagnetic specialty locks

Schlage's electromagnetic specialty locks provide flexibility for a variety of applications. They offer a depth of features and a proven record of performance.

Features and certifications:

M490DE: Delays egress with 15 second timer: includes integrated alarm

- Designed to meet NFPA 101 & BOCA, UL 10C 3 hr fire rating, UL 294, and BHMA 1500 lb. hold force

M490G: Gate lock is weather resistant for exterior swinging and sliding gates

- BHMA 1500 lb. hold force rated GF3000: Concealed locking mechanism enhances security and appearance
- UL 10C 3 hr fire rating, BHMA 1500 lb. hold force 320M: MiniLine is mortise designed for interior sliding doors
- UL 10C 3 hr fire rating, UL 1034 listed

40/70 Series Electromagnetic Locks

Ease of installation makes the 40/70 Series a perfect choice for retrofit applications. It is also easy to select and stock.

Features and Certifications:

- Magnetic bond sensor and door status monitor standard
- UL 10C 1 hour fire rating and BHMA Grade 1:
 - 40 Series – 500 lb. hold force
 - 70 Series – 1000 lb. hold force

Monitor strikes

Monitor strikes are designed to offer remote door monitoring through the use of a signal switch mounted in the strike to monitor the latch bolt. This series of monitor strikes is designed for use with Von Duprin and most other manufacturers' rim, mortise, surface and concealed vertical rod exit devices and cylindrical, mortise and unit type locks.

The monitor strike replaces the standard door strike. The tripper in the monitor strike is depressed when the latch bolt is fully inserted in the strike. The stainless steel tripper activates an electric switch.

Features and benefits

UL listed as "miscellaneous door accessory"

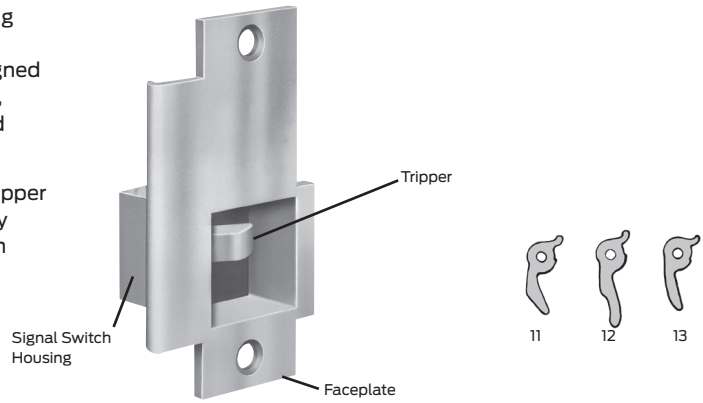

Monitor strike electrical rating

SPDT Switch (single pole double throw): 24VDC @ 2 Amps (resistive)

Note: Tripper selection is based on the throw and shape of the latch bolt.

Series 4263, 4268-T1, 4582



Model specifications			
Model #	4263	4268-T1	4582
Lockset	Rim or surface vertical rod exit devices	Rim fire exit devices	Mortise or cylindrical locks
# Doors	Single or pair	Single or pair	Single or pair
Compatibility (with tripper type)	Von Duprin 22, T3 2227, T1 33A/35A, T3 3327A/3527A, T3 44, T1 55, T1 88, T1 8827, T1 98/99, T3 9827/9927, T1 Monarch Rim, T3 (3/49" [19mm] throw) Yale® 1500, T1 (5/89" [16mm] throw)	Von Duprin 22/22-F 33A/35A 88/88-F 98/99 98-F/99-F	Schlage 3/4" (19mm) Cyl., T2 L90, T2 Falcon 5/8" (16mm) ML (LR), T2 Arrow™ 5/8" (16mm) ML (LR), T1 Corbin Ruswin® 5/8" (16mm) ML (LR) 5999 ML (LR), T2 Yale® 5/8" (16mm) ML (LR), T2
Certifications		UL list (GXHX R4504) fire exit hardware	UL List (GXHX R4504) fire exit hardware
Application notes	1	2	3

Application notes:

The 4263 is non-handed and features horizontal adjustment to compensate for misalignment of door and frame. 4263 may be used with a mullion. Tripper selection (-T1 or -T3) is based upon the lock to be used with.

The 4268 features horizontal adjustment to compensate for misalignment of door and frame. 4268-T1 is not for use with mullions.

For use on single or pair of doors with ANSI 115.3 frame cutout (frame modification required.) Tripper selection (-T1 or -T2) is based upon the lock to be used.

Monitor strikes

Basic monitor strike circuit

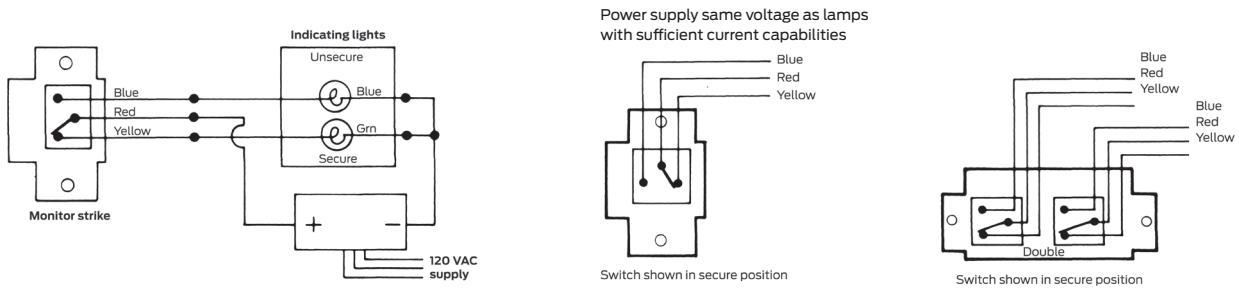

Series 4570T1, 4670-T1, 4690-T2, 4690-1-T2



Model specifications					
Model #	4570-T1		4670-T1	4690-T2	4690-1-T2
Lockset	Cylindrical locks		Cylindrical locks	Concealed vertical rod exit devices	Concealed vertical rod exit devices
# Doors	Single or pair		Single or pair	Wide stile pair of doors	Narrow stile pair of doors
Compatibility (with tripper type)	Schlage	1/29" (13mm) Cyl. 5/89" (14mm) Cyl.	Schlage	1/29" (13mm) Cyl. 5/89" (14mm) Cyl.	Von Duprin 3347A-F 3347A 9947 9947F
	Falcon	1/29" (13mm) Cyl. 9/169" (14mm) Cyl.	Falcon	1/29" (13mm) Cyl. 9/169" (14mm) Cyl.	
	Adams Rite®	4510 8400	Adams Rite®	4510 8400	
	Arrow™	1/29" (13mm) Cyl.	Arrow™	1/29" (13mm) Cyl.	
	Best®	9/169" (14mm) Cyl.	Best®	9/169" (14mm) Cyl.	
	Corbin Russwin®	5/89" (16mm) Cyl.	Corbin Russwin®	5/89" (16mm) Cyl.	
	Dexter®	7/169" (11mm) Cyl.	Dexter®	7/169" (11mm) Cyl.	
	Kwikset®	1/29" (13mm) Cyl.	Kwikset®	1/29" (13mm) Cyl.	
	Precision™	1040 Automatic Flush Bolt¹	Precision™	1040 Automatic Flush Bolt¹	
	Sargent®	1/29" (13mm) Cyl.	Sargent®	1/29" (13mm) Cyl.	
	Yale®	1/29" (13mm) Cyl.	Yale®	1/29" (13mm) Cyl.	
Certifications				UL list (GXHX R4504) fire exit hardware	
Application notes	1		2	3	4

¹Special template required

Application notes:

For use on single or pair of doors with ANSI 115.2 frame cutout (frame modification required.) 4570-T1 is only used with T1.

For use on single or double doors with ANSI 115.3 frame cutout (frame modification required.) 4670-T1 is only used with T1.

For use with pair of doors where one leaf has concealed vertical rods. 4690-T2 is only used with T2.

For use with pair of doors where both leaves have concealed vertical rods. 4690-1-T2 is only used with T2.

Monitor strikes dimensions

4263

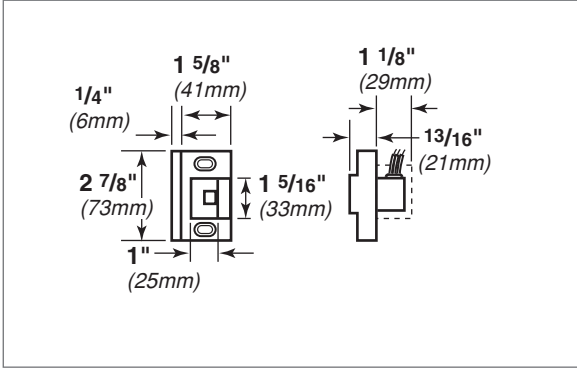

4670-T1

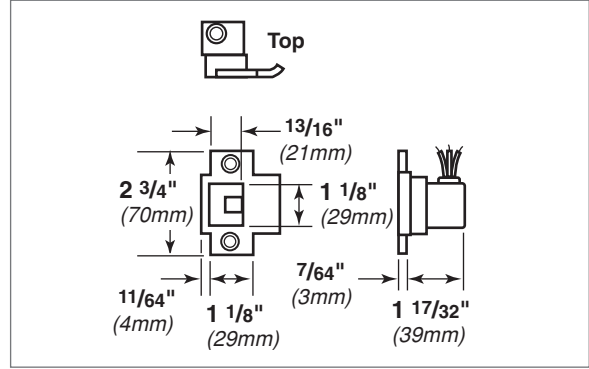

4268-T1

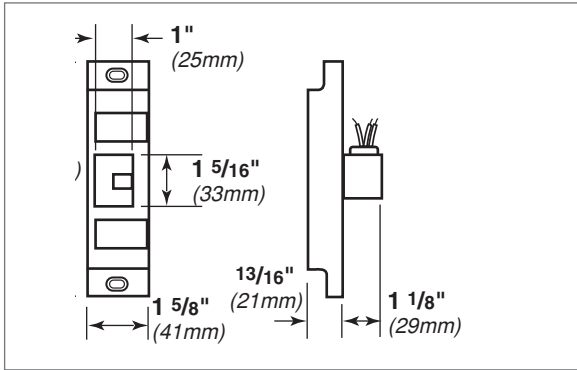

4690-T2

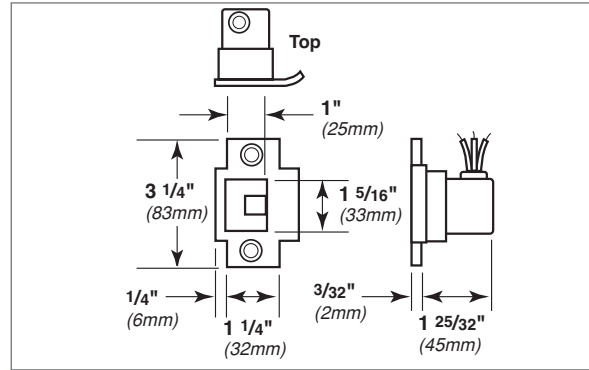

4570-T1

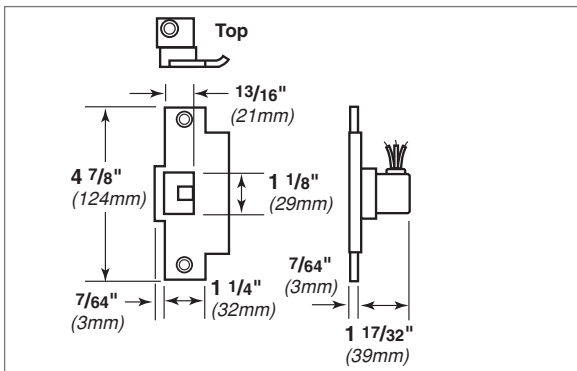

4690-1-T2

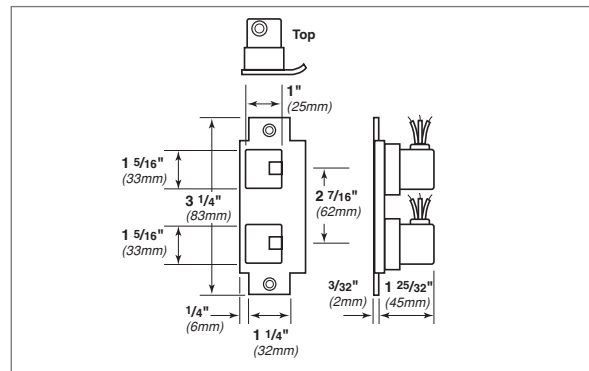

4582

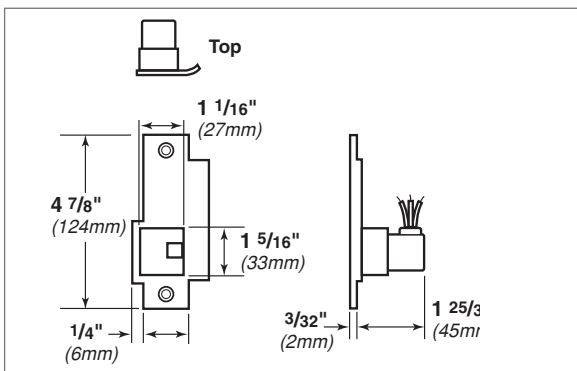

To order, specify

1. Model
2. Tripper T1, T2 or T3
3. Handing required on model 4582
4. Specify LHR or RHR
5. Finish: US3, US4, US10, US10B, US26, US26D

Allegion, the Allegion logo, Von Duprin and the Von Duprin logo are trademarks of Allegion plc, its subsidiaries and/or affiliates in the United States and other countries. All other trademarks are the property of their respective owners.

Mullions

Electrified removable mullions are used with pairs of doors equipped with rim mounted exit devices.

Each includes an electric cable with five conductors wired to a twist-apart plug. The soffit fitting is supplied with a pre-wired mating socket.

4754 — Prepared for two 4263 monitor strikes. Use with all Von Duprin rim panic devices.

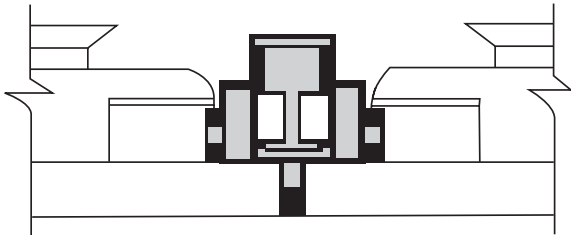

4854 — Prepared for one 6111 electric strike and one 299 strike. Indicate handing for electric strike.

9854 — Prepared for one 6111 electric strike and one 268 or 499F strike. Indicate handing for electric strike. UL Fire labeled for up to 3 hours on up to 8' x 8' (2438mm x 2438mm) openings using Von Duprin fire exit rim devices.

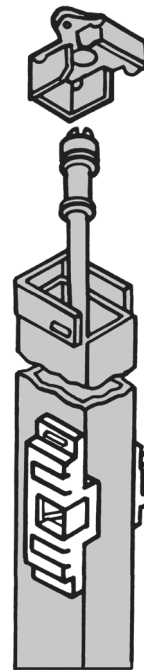

Steel mullion dimensions

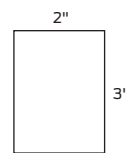

Wall Thickness 1/8" (3mm)

Sizes for mullions

4754, 4854, 9854

7' 2" (2184mm)

*8' 2" (2489mm)

*10' 2" (3099mm)

KR4754, KR4854

7' 6" (2286mm)

8' 6" (2591mm)

10' 6" (3200mm)

KR9854**

7' 5" (2261mm)

*8' 5" (2565mm)

*10' 5" (3175mm)

* Only qualifying applications will be provided with UL Label.
** Fire rated same as 9854

4854/9854 — Using one electric strike

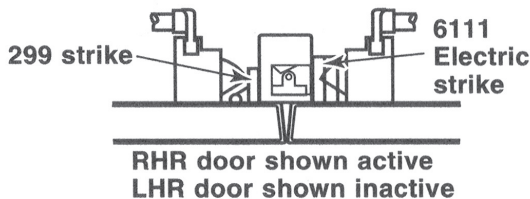

KR - Keyed removable option available on electrified removable mullion. Makes removal faster and easier by a single operation of the mortise cylinder. Once mullion is removed, large equipment or furniture can freely pass through the opening. The unit will self lock when re-installed, without use of the cylinder key. Uses 1 1/4" mortise cylinder with a straight cam (Schlage cam reference B502-191). Cylinders are sold separately. Prefix mullion model with "KR".

To order, specify

1. Model number.
2. Height of opening
3. Finish: SP28, SP313, SPBLK.
4. Handing if required.
5. Centerline deviation (refer to device template for standard centerline).
6. Strikes, when required, should be ordered with device.
7. For keyed removable option prefix model number with "KR", example KR9854.

Quick disconnect

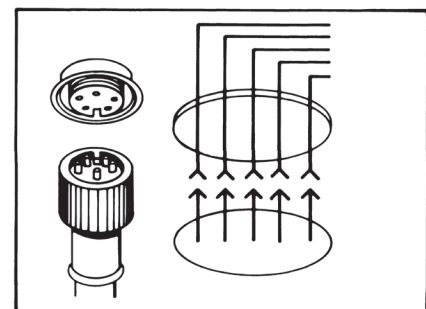

Soffit details

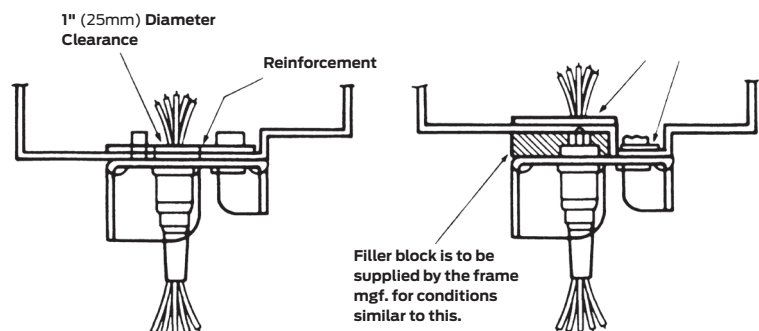

Filler block is to be supplied by the frame mgf. for conditions similar to this.

Notes

Notes

About Allegion

Allegion (NYSE: ALLE) creates peace of mind by pioneering safety and security. As a \$2 billion provider of security solutions for homes and businesses, Allegion employs more than 8,000 people and sells products in more than 120 countries across the world. Allegion comprises more than 25 global brands, including strategic brands CISA®, Interflex®, LCN®, Schlage® and Von Duprin®.

For more, visit www.allegion.com

aptiQ ■ LCN ■ **SCHLAGE** ■ STEELCRAFT ■ VON DUPRIN