



Access & Power Integration

# Trove1HW1R

- Trove rack enclosure with  
Altronix/Honeywell backplane (THW1R)

## Installation Guide

All registered trademarks are property of their respective owners.



Rev. THWR031119



**More than just power.™**

Installing Company: \_\_\_\_\_ Service Rep. Name: \_\_\_\_\_

Address: \_\_\_\_\_ Phone #: \_\_\_\_\_

## Overview:

Altronix Trove1HW1R rack mount access & power integration solution accommodates various combinations of Honeywell boards with or without Altronix power supplies and accessories for access systems.

## Specifications:

### Agency Listings:

- CE European Conformity.

### Trove1HW1R

#### Trove1R rack mount enclosure with THW1R Altronix/Honeywell backplane.

- 16 Gauge black enclosure with ample knockouts for convenient access.
- Modular 2U standard EIA 19" drawer with extendable slides up to 48".
- Dimensions (H x W x D): 3.375" x 19.0" x 26.5" (85.8mm x 482.6mm x 673.1mm).
- Includes tamper switch (Altronix Model TS112 or equivalent) and cam lock.

### THW1R

#### Altronix/Honeywell backplane.

- 16 Gauge backplane.
- Dimensions (H x W x D): 18.5" x 15.25" x 0.3125" (469.9mm x 387.4mm x 7.9mm).

### Optional Accessories:

- RE2: Rack Mount Battery Enclosure accommodates up to four (4) 12VDC/7AH batteries
- WM5, WM25, WM100: Magnetic Cable Tie Mounts (5, 25, 100 counts).
- LC3: 6 ft. three-wire line cord.

## Backplane Accommodates a Combination of the Following:

### Altronix:

- One (1) eFlow4NB, eFlow6NB, eFlow102NB, eFlow104NB, ACMS8(CB) or ACM8(CB).
- Up to two (2) ACM4(CB), MOM5, PD4UL(CB), PD8UL(CB), PDS8(CB), or VR6.

### Honeywell:

- Up to four (4) PR032E1PS, PR032IC, PR032R2, PR032IN, PR032OUT, PW6K2E2PS, PW6K1IC, PW6K1IN, PW6K1OUT, PW6K1R2.
- One (1) PR032E1PS or PW6K2E2PS.

## Hardware and Accessories:



## Installing Trove1R into Rack Tower:

Wiring methods shall be in accordance with the National Electrical Code/NFPA 70/ANSI, and with all local codes and authorities having jurisdiction. These products are for indoor use only and must be installed within the protected premises.

**Note:** First assemble and Install Z Bracket Wire Management Accessory (refer to Z Bracket Installation pg. 4)

1. Remove backplane from enclosure prior to installing into rack cabinet (do not discard hardware).
2. In order to mount included UL Listed tamper switch (Altronix Model TS112 or equivalent) turn the enclosure upside down. Punch out the knockout in designated location, on the back of the unit, from outside of the drawer (Fig. 1, pg. 3). Insert the tamper switch into the knockout from outside of the drawer with the button facing outwards and spaded connectors inside the drawer. Connect tamper switch wiring to the Access Control Panel input or the appropriate UL Listed reporting device.  
To activate alarm signal open the rack drawer.
3. Slide the rack enclosure into an open 2U location in the four post rack cabinet.
4. Utilizing proper fasteners attach front ears to the rack rails.
5. Attach the rear of the adjustable slides to the rear rails of the rack cabinet with the proper fasteners.
6. Secure the rack cover (Fig. 2a, pg. 3) and rack drawer to earth ground (Fig. 2b, pg. 3).

Fig. 1  
Back of the drawer,  
viewed from outside.

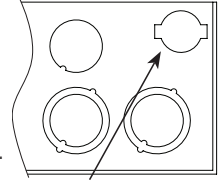

Tamper Switch  
mounting location

Fig. 2

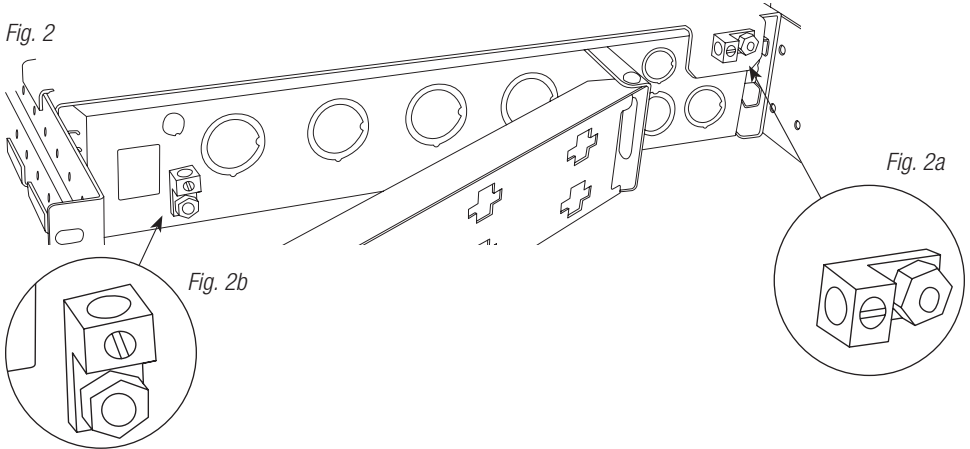

7. Make sure that all internal configurations (wiring, voltage selection, switch settings, etc.) are complete before mounting backplane back into enclosure.
8. After all components are mounted on the backplane, attach it to the enclosure using included hardware.

## Assembling and Attaching

### Z Bracket Wire Management Accessory (included):

Altronix Trove Rack enclosures include Z Bracket, a convenient and reliable wire management accessory.

#### Hardware (included):

 Ten (10) bolts and  eight (8) lock nuts.

1. Carefully unpack Z Bracket. Do not discard hardware (included) (Fig. 3, pg. 4).
2. Attach arms to each other using bolts and lock nuts (Fig. 3a, pg. 4).
3. Attach the hinge brackets to the ends of arms using bolts and nuts positioning them as shown on (Fig. 3b, pg. 4).
4. Make sure that all nuts are tightened.

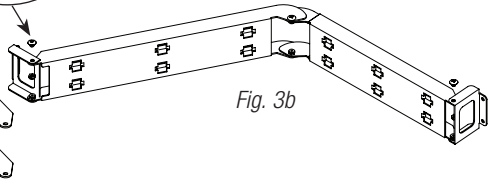
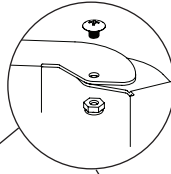
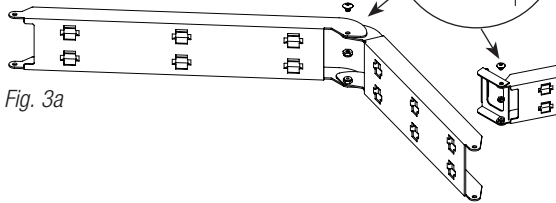
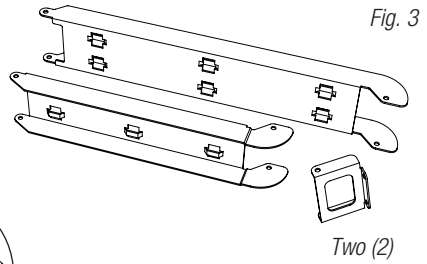

5. Attach the hinge bracket on the longer side of Z Bracket to the adjustable slide using bolts and lock nuts (included) (Fig. 4, 4a, pg. 4).
6. Attach the hinge bracket on the shorter side of Z Bracket to the rear of the rack enclosure using bolts (included).

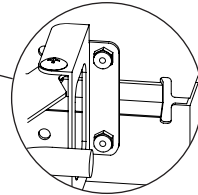
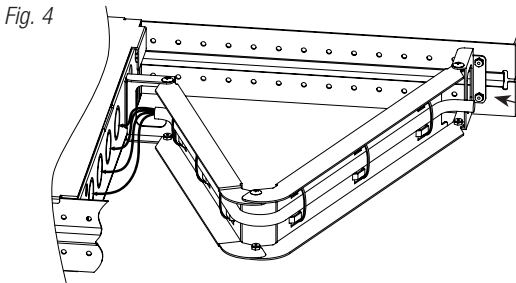

Fig. 4a

# THW1R:

## Configuration of Altronix Power Supply and/or Sub-Assembly Boards

1. Fasten spacers onto metal pems configuration (A) or (B) of backplane depending on the board (Fig. 5, pg. 5).
2. Position access controller module over corresponding spacers and fasten screws into spacers (Fig. 5a, pg. 5).
3. Mount backplane to enclosure with hardware.

### Position Chart for the Following Models:

Altronix Power Supply/Charger or Sub-Assembly	Pem Mounting
eFlow4NB, eFlow6NB, eFlow102NB, eFlow104NB, or ACM8(CB), ACMS8(CB)	(A)
ACM4(CB), MOM5, PD4UL(CB), PD8UL(CB), PDS8(CB), PD16W(CB) or VR6	(B)

Fig. 5

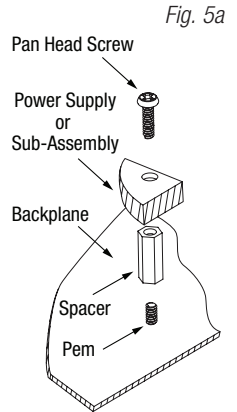
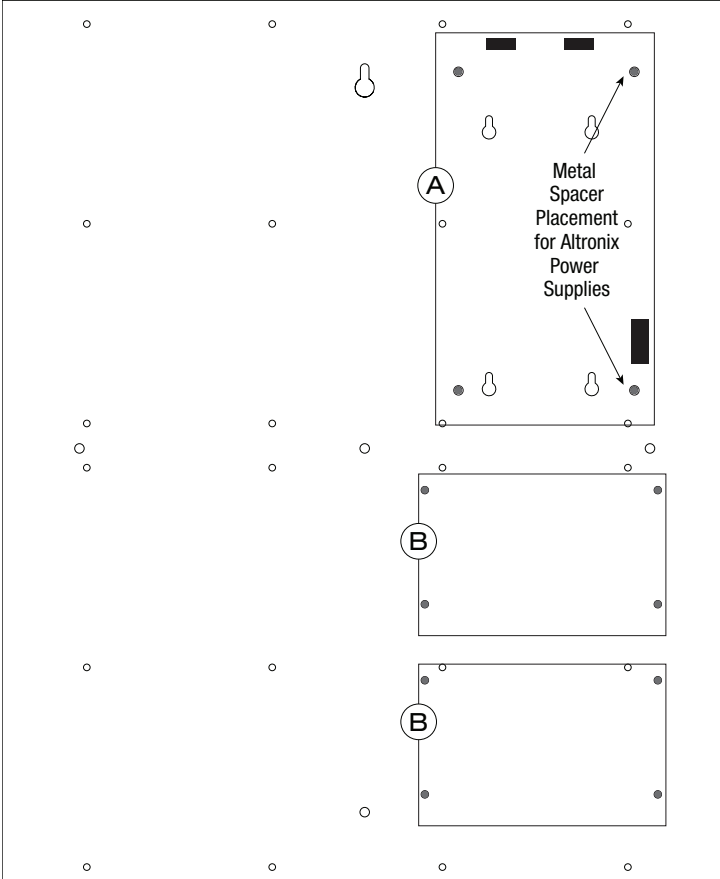

## Installation Instructions for Honeywell PRO32E1PS or PW6K2E2PS to THW1R:

1. Install four (4) mounting screws approximately halfway into mounting holes in the power supply's frame.
2. Position the power supply over four (4) keyholes (B) on THW1R.
3. Slide the power supply forward until secure. Tighten the mounting screws.

## Installation Instructions for Honeywell Access Controllers to THW1R:

1. Fasten spacers (provided) into pem configuration (A) of backplane (Fig. 6, pg. 6).
2. Mount boards to spacers utilizing 5/16" pan head screws (provided) (Fig. 6a, pg. 6).
3. Mount backplane to enclosure with hardware.

## Honeywell ProWatch/WinPak Power Supply or Access Controller Position Chart for the Following Models:

Honeywell Board	Pem Mounting
3200 Series or WIN-PAK Series	(A)
PRO32E1PS or PW6K2E2PS	(B)

Fig. 6

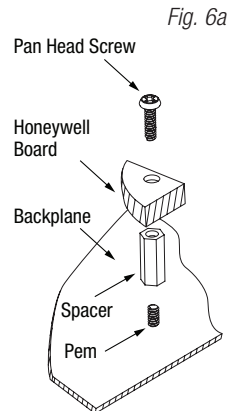
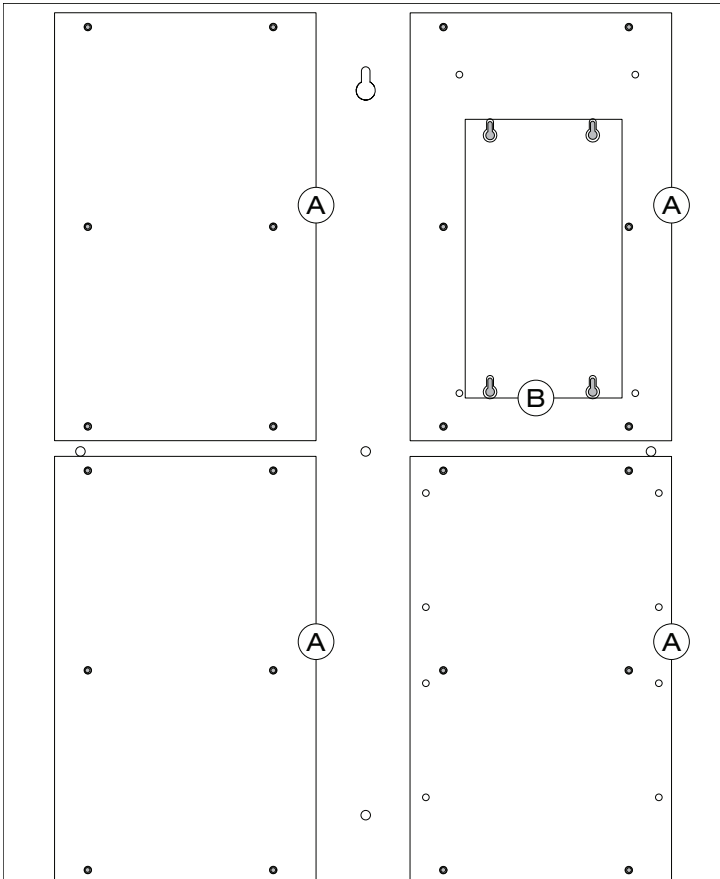

# THW1R Backplane Dimensions (H x W x D):

18.5" x 15.25" x 0.3125" (469.9mm x 387.4mm x 7.9mm)

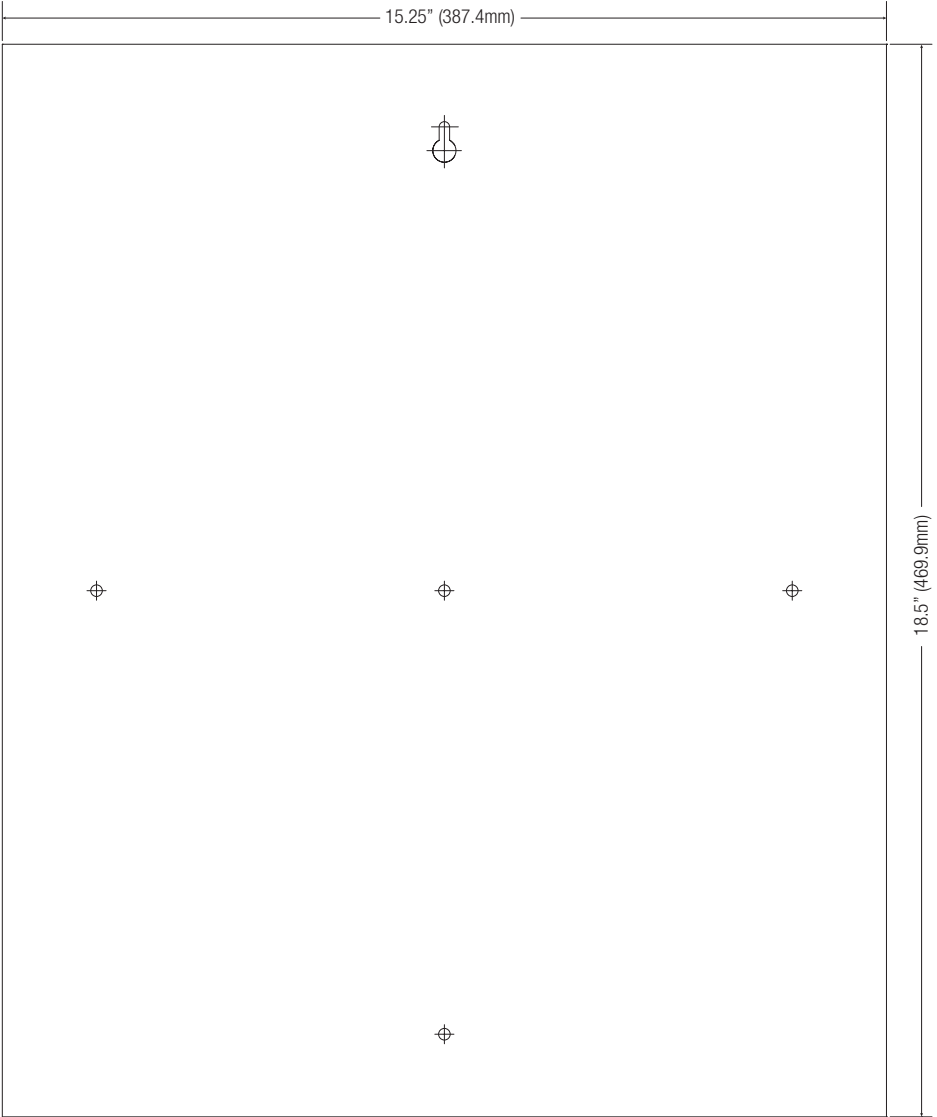

# Trove1R Enclosure Dimensions:

3.375" x 19.0" x 26.5" (85.8mm x 482.6mm x 673.1mm). Shown with Z Bracket attached.

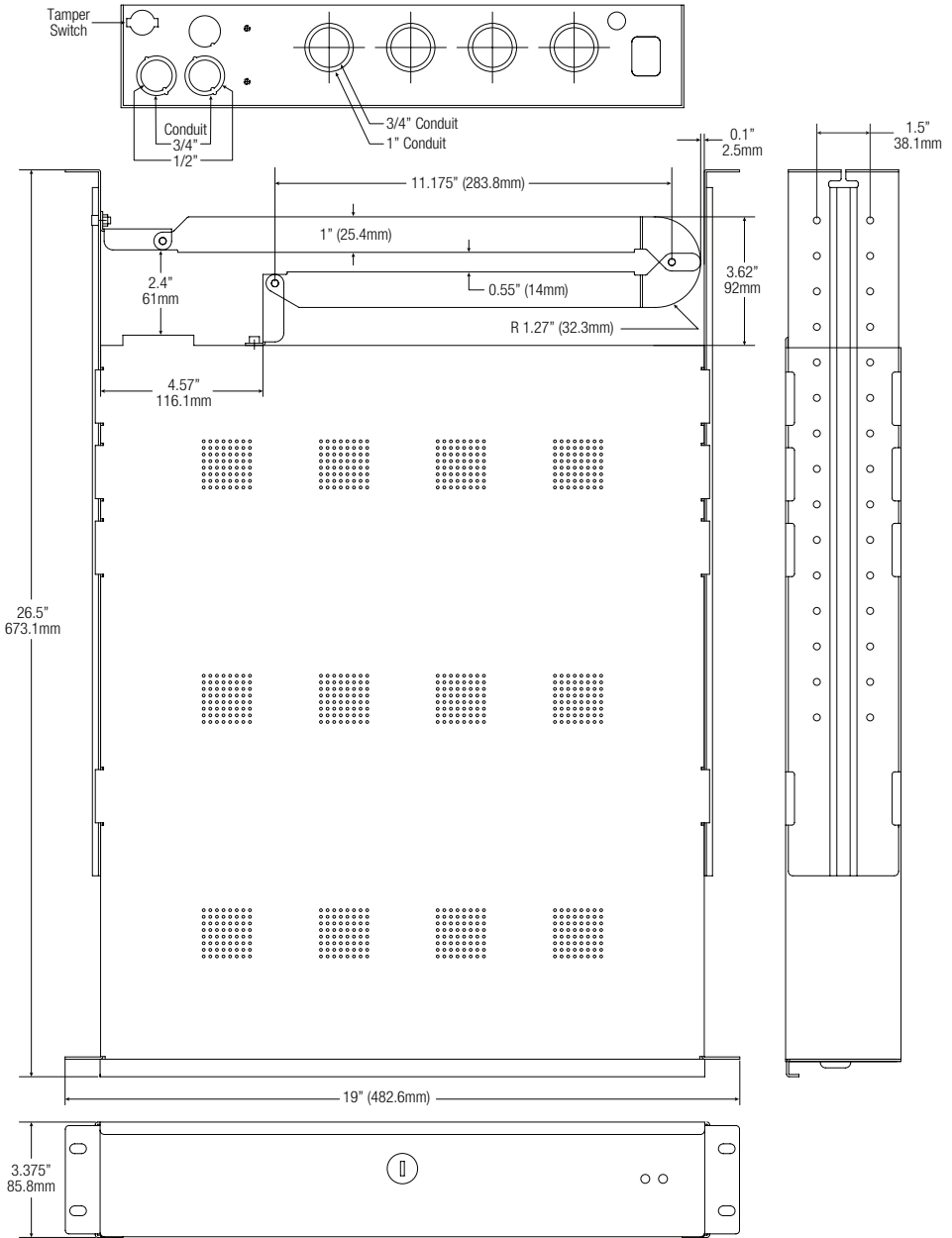

Altronix is not responsible for any typographical errors.

140 58th Street, Brooklyn, New York 11220 USA | phone: 718-567-8181 | fax: 718-567-9056  
 website: [www.altronix.com](http://www.altronix.com) | e-mail: [info@altronix.com](mailto:info@altronix.com) | Lifetime Warranty  
 ITrove1HW1R D09V

