

PLATINUM TOOLS®

We Make Connections EZ!



Security
Residential
Industrial
Electrical
Datacom
Telecom





Cutters ————— 2-7



Strippers ————— 8-13



Crimpers ————— 14-25



Punchdown ————— 26-29



Specialty Tools — 30-37



Connectors ————— 38-47



Structured Wiring — 48-55



Cable Management - 56-61

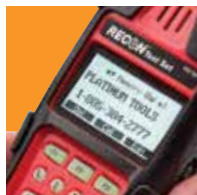

Testers ————— 62-71



Kits ————— 72-83

Index & Reference 84-92

Cutters



Made in the USA

Part #	Description
10525C	Professional Electrician's Scissors

Professional Electrician's Scissors. Designed for use in electrical, telephone and datacom service applications. Ergonomically designed large ring provides more power, reduces fatigue and wrist strain. Fits comfortably in the power portion of the palm producing a cleaner, quicker cut with less effort. Bottom blade has serrated teeth the full length of the cutting edge to grip the cable/wire. Through hardened (RC59).

Technical / Features

- Cuts stranded wire to 12 AWG
- Cuts solid wire to 16 AWG
- Trims Kevlar® in fiber optic cable
- Strips 19 to 23 AWG wire
- Serrated edges on back of blades for cleaning wire and binding posts



Made in the USA

Part #	Description
10517C	Scissor-Run Electrician's Scissors - 5"

5" Scissor-Run Electrician's Scissors. Our Scissor-Run Scissors are an original favorite. This smooth cutting action, scissor-run design is excellent for cutting Kevlar®, foil and wire. Cuts wire up to 16 AWG solid, 12 AWG stranded, and will strip 19 AWG and 23 AWG.

Technical / Features

- Full serrated bottom blade for non-slip cutting
- Through hardened, high carbon steel for edge retention
- Double plated chrome over nickel
- Easily re-sharpens & holds cutting edge
- Scraper & file on backside of blades



Made in the USA

10522C

10526C

Leather Pouch, Knife & Scissors Kits. These kits provide essential solutions for the professional installer. Includes a 6" nickel plated cable splicer's knife with a comfortable, non-slip grip weighted handle and your choice of scissors in a durable leather belt pouch.

Part #	Description
10522C	Scissor-Run Electrician's Scissors Kit
10526C	Professional Electrician's Scissors Kit

10520C



10519C	Leather Pouch and Cable Splicer's Knife
10520C	Cable Splicer's Knife
10521C	Leather Pouch



Ceramic Kevlar® Scissors. The Ceramic Kevlar® Scissors provide superior performance when trimming the Kevlar strength member in fiber optic cables; also works well with Kevlar cloth. The secret is the Zirconia ceramic blades that will not dull or lose their edge like stainless steel blade scissors. Large finger loops are comfortable and easy to manipulate.

Technical / Features

- Cuts fiberglass aramid fibers
- Never needs sharpening
- Zirconia ceramic blades
- Large finger loops for ease of use

Part #	Description
10530C	Ceramic Kevlar® Scissors



Pull For Performance. EZ-RJ45® Connectors.

Tips & Tricks

The closer the twists are to the contacts, the point of termination, the better the performance. So don't just push your twists, BUT push & pull your twists. Take advantage of those extended conductors and watch your performance go up! Caution: Allow a wee bit of slack, especially when working with stranded.

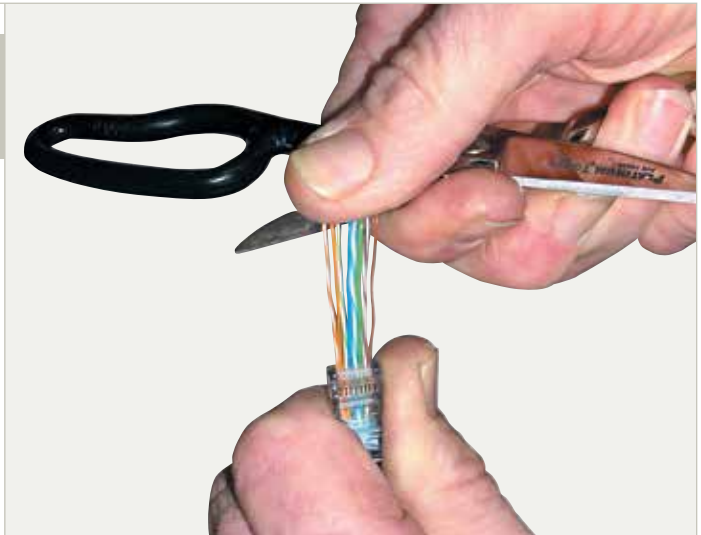

Cut-N-Strip. The dual function Cut-N-Strip tool's small size and ease of use delivers superior performance and utility of function. The cutting jaws provide a low profile full-flush cut and are manufactured from induction hardened stainless steel for long life. The patented stripper in the handle self-adjusts to wire sizes of 26 AWG to 14 AWG. Catch, hold and strip wire in one quick motion.

Technical / Features

- Strips 26 AWG to 14 AWG
- Full-flush cutting jaws
- Self-adjusting stripping jaws, no stripping holes to locate
- For use on copper wire only

Part #	Description
10503	Cut-N-Strip





5" Side Cutting Pliers. The 5" Side Cutting Pliers are perfectly suited for field or production line work. Cut copper wire or trim leads with the full flush cutting blades. Manufactured from high carbon tool steel, precision ground and hardened for long life. Molded comfort grip handle. Rust resistant black oxide finish.

Technical / Features

- Cuts copper wire and soft metals up to 16 AWG (.05" dia.)
- 21° full flush cut
- Spring action
- Comfort grip vinyl handle

Part #	Description
10531C	5" Side Cutting Pliers



Coax & Round Wire Cable Cutter. This durable, economically priced cutter is designed to cut solid and stranded wire to 8 AWG, multi-conductor and coaxial cable to 1/2" diameter. Features a curved, precision-ground blade that will not deform the conductors or dielectric. Stamped from high carbon tool steel and heat treated for long life.

Technical / Features

- Cuts solid and stranded wire to 8 AWG
- Cuts multi-conductor cable to 1/2" diameter
- Cuts coaxial cables without deforming the dielectric
- Spring loaded with locking latch

Part #	Description
10500C	Coax & Round Wire Cable Cutter



BTP-6 Coax & Data Cable Cutter. The rugged drop forged construction provides exceptional durability and professional results. Dual elliptical cutting blades are precision ground to provide low effort cutting of coaxial cables without deforming the dielectric. Cuts twisted pair cables, both UTP/STP, and a wide range of coax. Non-slip cushioned handles fit the hand and the tool pouch.

Technical / Features

- Cuts solid, stranded and multi-conductor cables to 6 AWG
- Cuts coaxial cables without deforming the dielectric
- Dual elliptical cutting blades

Part #	Description
10510C	BTP-6 Coax & Data Cable Cutter

CCS-6 Cable Cutter. Finally, a compact cable cutter designed to cut coax cable with steel center conductor, including RG11. Also easily cuts through copper and aluminum cable including Cat5e UTP/STP and many more.

Technical / Features

- Cuts RG11/7, RG59, RG6, RG6Q with steel center conductor
- Compact and lightweight
- Fully tested to 10,000 cuts on RG6 CCS (copper clad steel center conductor), with no degradation to the cutting blades
- Heat-treated, precision ground blades

Part #	Description
10514C	CCS-6 Cable Cutter

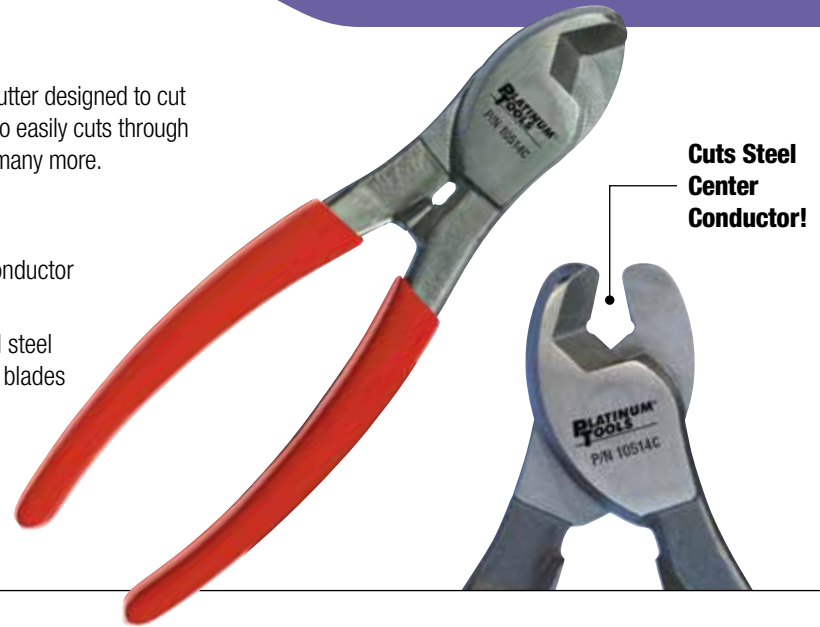

Steel Wire Cutter. Heavy duty, high leverage design provides single-handed cutting action on a wide variety of hard to cut materials. Blade is designed to ensure a clean cut without pinching or crushing. Maintains concentricity to allow fittings and terminals to go on easily.

Technical / Features

- Forged from chrome molybdenum and hardened to 58-60 HRC
- Rust resistant electrophoretic deposition finish
- Smooth spring action for easy, repetitive cutting
- Handles contoured for comfortable hand grip

Part #	Description
10512C	Steel Wire Cutter



BTC-20 Cable Cutter. Heavy duty, high leverage design provides greater cutting capacity with no cable distortion. Made from chrome vanadium steel.

Technical / Features

- Cuts up to 2/0 AWG (70mm²) soft copper
- Cuts up to 4/0 AWG (95mm²) aluminum
- 100-pair 24 AWG telephone cable
- Through hardened and vacuum heat treated for longer-lasting cut

Part #	Description
10540C	BTC-20 Cable Cutter





100 Pair Cable Cutter. This cable and wire cutter is a must for any tool belt when cutting larger diameter cables. Built to last – manufactured from precision ground, heat treated tool steel with rust resistant black oxide finish. Has built-in return spring and locking latch for easy storage. Plastic molded ergonomic handles.

Technical / Features

- Cuts to 100 pair group telephone cable
- Cuts solid or stranded cable to 2 AWG
- Cuts large diameter coaxial cable such as RG9U

Part #	Description
10550C	100 Pair Cable Cutter



500 MCM Cable Cutter. This compact ratcheted cutter is designed for simple one hand operation. Works well in tight spaces. Cuts stranded, flexible copper and aluminum cable up to 500 MCM (240mm²). Both fixed and moving cutting blades are precision ground. Cutting blades are manufactured from high carbon tool steel and heat treated for long life. Rust resistant black oxide finish.

Technical / Features

- Cuts up to 500 MCM copper and aluminum cables
- Non-slip two-tone comfort grip handles
- Locking latch for easy storage
- Ergonomic handles
- Quick blade release system
- Designed for easy one handed operation

Part #	Description
10569C	500 MCM Cable Cutter
6055	Replacement Blade for PN 10569C



Give It The Boot

Cutting large diameter cables like 750 MCM can be a bear on your hand! Use the cutting boot (P/N 1081) to provide a stable platform for the cutter. Now you can put your weight behind the moving blade to improve your leverage... and save your hand!

Tips & Tricks



Ratcheted Telecom Cutter. This versatile cutter has a specially designed moving blade to handle larger diameter telephone cables. Cuts up to 2,700 pair telephone cable and up to 750 MCM (380mm²) soft drawn copper and aluminum cables. Cutting blades are manufactured from hardened tool steel for long life. The optional fixed handle cutting boot provides stability and increased leverage. Ratchet lock holds handles in closed position for storage. Rust resistant black oxide finish.

Technical / Features

- Cuts up to 2,700 pair telephone cable
- Cuts up to 750 MCM copper and aluminum cables
- Quick blade release mechanism for safety and fast backout
- Locking latch for easy storage

Part #	Description
10560	Ratcheted Telecom Cutter - 2,700 Pair
6051	Replacement Blade for PN 10560
1081	Fixed Handle Cutting Boot



Ratcheted Utility Cutter. This compact ratcheted cutter is designed for simple one hand operation. Cuts stranded, flexible copper and aluminum cable up to 750 MCM (380mm²). The compact design works well in tight workspaces. Both fixed and moving cutting blades are precision ground. The optional fixed handle cutting boot provides stability and increased leverage. Cutting blades are manufactured from high carbon tool steel and heat treated for long life. Rust resistant black oxide finish.

Technical / Features

- Cuts up to 750 MCM copper and aluminum cables
- Quick blade release mechanism
- Locking latch for easy storage

Part #	Description
10565	Ratcheted Utility Cutter - 750 MCM
6050	Replacement Blade for PN 10565
1081	Fixed Handle Cutting Boot



Strippers



15316

15310C



Laminated Blades



Wire Cutter



Adjustable Wire Stop

Part #	Description
15316	Maxim® 16 Self-Adjusting Wire Stripper 10-5 AWG
15310C	Maxim® 6 Self-Adjusting Wire Stripper 24-10 AWG
15313	Replacement Blade Cassette for 15310C
15317	Replacement Blade Cassette for 15316



Replacement Blade Cassette P/N 15313

Maxim® 6 and 16 Self-Adjusting Wire Strippers.

Heavy duty, self-adjusting wire stripping and cutting tool. Ergonomic handle is designed for comfort and reduces fatigue. The auto form laminated stripping jaws form around the radius of the cable to ensure no damage to the inner conductor. Set adjustable wire stop for precise strip lengths. High leverage built-in cutter with safety guard. Made from high grade polymers and carbon steels to ensure long life and reliable performance.

Technical / Features

- For use with round, oval and flat wire cable
- Maxim® 6:
 - 24-10 AWG stripping range
 - 30-10 AWG cutting range
- Maxim® 16:
 - 10-5 AWG stripping range
 - 10-5 AWG cutting range



15305C

Minim® 2.5 Self-Adjusting Wire Stripper.

High quality, self-adjusting wire stripping and cutting tool with a range of 30-13 AWG. Compact pistol grip design gives increased control and greater precision, vital for stripping smaller cables. The auto form laminated stripping jaws form around the radius of the cable to ensure no damage to the inner conductor. Adjustable wire stop for precise strip lengths. Made from high grade polymers and carbon steels to ensure long life and reliable performance.

Technical / Features

- 30-13 AWG stripping range
- 30-13 AWG cutting range
- For use with round, oval and flat wire cable

Part #	Description
15305C	Minim® 2.5 Self Adjusting Wire Stripper
15308	Replacement Blade Cassette for PN 15305C

ProStrip Wire Strippers.

Designed to meet the demanding expectations of professionals. These wire strippers deliver performance, comfort and consistent, reliable results. The tools can be used left or right handed – wire sizes are marked on both sides.

Ergonomically designed handles require less hand force.

The curved cutting blades ensure cleaner, precise cuts. Color-coded for quick identification.

Technical / Features

- Precision-ground strip nest
- Cut and chase threads on 16/32 & 8/32 bolts
- Serrated plier nose for gripping, pulling and twisting
- Holes in jaw for looping wire
- Hardened to HRC45
- Rust resistant black oxide finish

Part #	Description
15003C	ProStrip 10/20 Wire Stripper, 10-20 AWG solid / 12-22 AWG stranded
15005C	ProStrip 16/30 Wire Stripper, 16-30 AWG solid / 18-32 AWG stranded



Cable Jacket Slitter & Stripping Tools. Use the Cable Jacket Slitter for quick and precise removal of insulation from round cables without nicking conductors. Unique lever and blade design allows ringing, longitudinal and spiral slitting of cable jackets. Cable holding bracket has integrated sharpened edge for removing insulation. Adjustable blade cutting depth; includes spare blade in the handle.

Technical / Features

- Strips to a maximum OD of:
 - .18"-1.0" (4.5mm to 25mm) OD – **10005C**
 - 1.0"-1.4" (25mm to 35.5mm) OD – **10007C**
- Blade adjusts for jacket thickness to 0.125" (4.5mm)
- Use with stranded, solid and multi conductor cable

Part #	Description
10005C	Cable Jacket Slitter .18 - 1.0"
10007C	Cable Jacket Slitter 1.0 - 1.4"
10006C	Replacement Blade (2 blades) for PN 10005C and PN 10007C



Applications

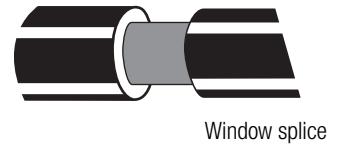
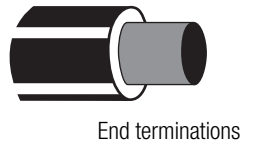
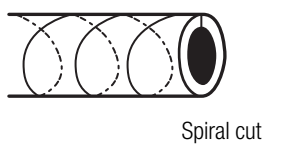
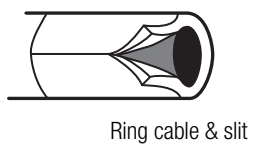



V-Notch Wire Stripper. Designed with a precision ground V-notch blade for superior stripping results on various types of 24-10 AWG jacket insulations. Precision ground from high carbon steel, the stripping blades adjust to proper wire gauge with rotating cam wheel.

Technical / Features

- Strip & cuts 24-10 AWG, solid or stranded wire
- Spring loaded with locking latch
- Looping holes for solid wire
- Vinyl dipped cushioned handles
- Hardened to HRC45
- Rust resistant black oxide coating

Part #	Description
15001C	V-Notch Wire Stripper

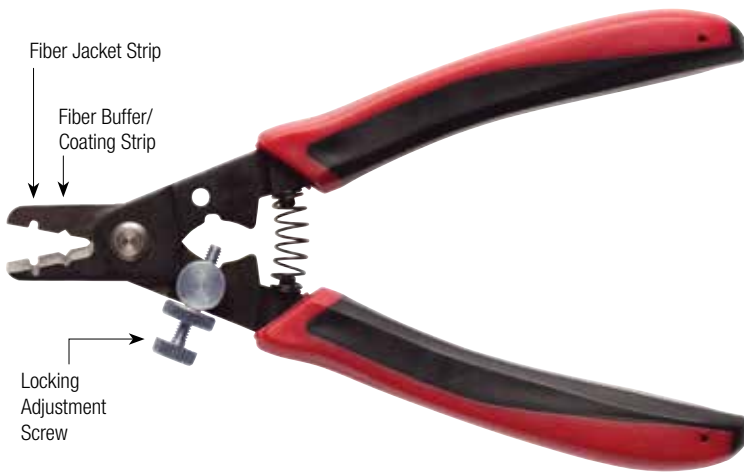

Adjustable Fiber Optic Stripper. The Adjustable Fiber Optic Stripper is designed to be versatile and economical without compromising the needs of the professional installer. All stripping surfaces are precision ground and hardened for durability and long life. The circular notch strips a full range of outer fiber cable jacket insulations. The V-notch will strip/remove a full range of fiber buffer and coating materials. The adjustment screw allows for precise adjustments and locks into place once set.

Technical / Features (See diagram)

- Use V-notch for stripping 250μ to 500μ fiber coatings (A)
- Use V-notch for stripping 500μ to 900μ tight buffer. (Loose Tube to 1500μ) (B)
- Use round notch for stripping outer cable jacket insulations to 3.0mm diameter (C)
- Cushioned grip handles provide positive, non-slip, comfortable operation

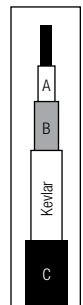

Part #	Description
15060C	Adjustable Fiber Optic Stripper



Tips & Tricks

Measure Twice, Cut Once. Terminating SealSmart™ BNC Connectors.

Having trouble properly seating your SealSmart™ BNC connectors? Use the connector as a measuring stick. Place your prepped cable next to your connector with the dielectric beneath the base of the BNC head. If the conductor goes past the upper end of the knurled band (A), then it is too long. Trim if necessary.

Use a pen to mark the cable (B) so you will know how far down the connector needs to go.

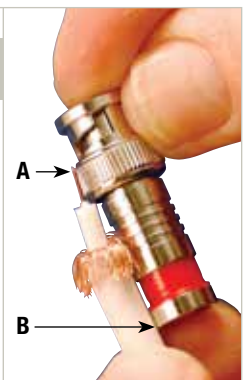

Cat5e/6 Cable Jacket Stripper. This economical tool strips the cable jacket from Cat5e/6 twisted pair cables with professional results. Features a long life blade specifically designed to self-adjust to prevent nicks to the inner conductors. Durable, high impact plastic housing is molded in yellow to make it easy to locate.

Technical / Features

- Removes the cable jacket on Cat5e/6 cables
- Accepts cable diameters from 0.18" to 0.25" (4.5mm - 6.3mm)
- No adjustments required; easily switch from one cable type or insulation to another
- Does not nick inner conductors
- Recommended for PVC cable jackets



Part #	Description
15015C	Cat5e/6 Cable Jacket Stripper

Cyclops® 2 Cable Jacket Stripper. The Cyclops® 2 takes the guesswork out of removing the jacket from many cable types including, twisted pair, multicore and fiber optic cables. The tool self-adjusts to automatically score PVC, plenum and other insulation types without damaging the braids, foils or conductors. One piece design, ready to use right out of the package. Typical applications are in data, voice, video, audio, security and others.

Technical / Features

- Removes cable jackets from:
 - Twisted pair (shielded & unshielded) cables
 - Single and multi-core cables (shielded & unshielded)
 - Fiber optic cable
- Self-adjusting
- Accepts cable diameters from 0.10" to 0.43" (2.5mm - 11mm)

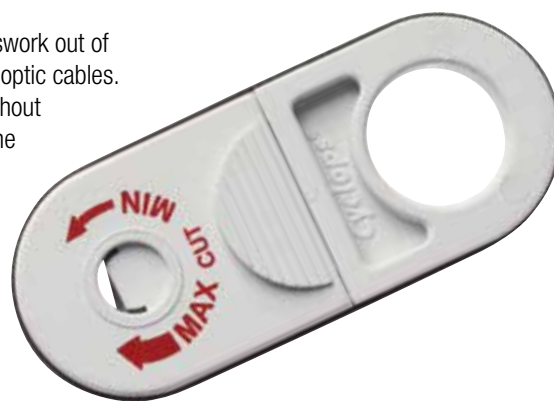

Part #	Description
15010C	Cyclops® 2 Cable Jacket Stripper

BR1 Multi-Stripper. Easy to use, "Big Red" cuts and strips most cable types/sizes making it the pro's choice in the voice, data and video-networking world.

Technical / Features

- Works with most cable types/sizes including:
 - **Coax (Video):** RG59 CCTV; RG6 and RG6 Quad; RG7/11
Includes braid comb for folding braid back over the cable jacket
 - **Twisted Pair (Data) PVC & Plenum:** Cat3/4; Cat5e shielded; Cat6; Cat6 shielded; Cat6A shielded
 - **Telephone & Audio (Voice):** Round cable
- Coax blades are preset; replacement cassettes available
- Adjustable cable jacket stripper for voice/data
- Built-in cable cutter; not for steel



↑ Strips all these



Part #	Description
15041C	BR1 Multi-Stripper
15042C	Replacement Blade Cassette
15041BLC	Replacement Blade Set (2)

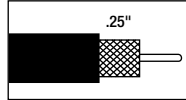

Part #	Description
15020C	Double-Ended Coax Stripper

Double-Ended Coax Stripper.

Quickly and easily strips a broad range of coax cables in a single step without any adjustments. The blades are designed to produce the standard 1/4" braid, 2-level strip for compression connectors.

Technical / Features

- Works with RG7/11/213/8 and RG59/6/6Q cables
- Quickly removes cable jacket and dielectric
- Preset, requires no adjustments
- Compact, lightweight and simple operation



Part #	Description	Tool & Connector Color
15021C	SealSmart™ Coax Stripper for RG6 Quad	(Blue) ●
15022C	SealSmart™ Coax Stripper for RG6	(Black) ●
15023C	SealSmart™ Coax Stripper for RG59	(Red) ●

SealSmart™ Coax Cable Strippers.

SealSmart™ Coax Strippers are factory preset for specific cable sizes. Delivers fast, accurate results right out of the box. Color-coded by cable type to coordinate with the SealSmart™ Compression Connectors.

Technical / Features

- Preset, requires no adjustments
- 1/4" braid, 2 level strip
- Meets industry standard for all compression connectors

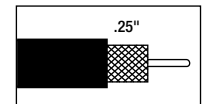

Part #	Description	Connector Color
15024C	SealSmart™ Coax Stripper for Mini RG59 (Navy Blue)	●

SealSmart™ Mini RG59 Stripper.

This SealSmart™ Coax Cable Stripper is factory preset for Mini RG59 cable. It works on 23 AWG solid center conductor cable.

Technical / Features

- 1/4" braid, 2 level strip
- Preset, no adjustment required
- Prep coax for SealSmart™ 23 AWG center conductor F, RCA & BNC compression connectors with the navy blue color code

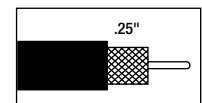

ProStrip 25R Coax Stripper. Designed for the professional contractor. Factory preset for industry standard 1/4" cable preparation, eliminating the need for time consuming blade depth adjustments. Stainless steel rollers provide smoother, concentric, non-binding rotation on a wide range of cables for fast professional results. No adjustments required!

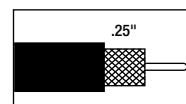

Technical / Features

- Includes 2 stripping ports for a broader range of cables:
 - RG6 and RG59
 - RGB/Mini 59 for 23, 24 & 25 AWG
- Industry standard 1/4" strip length
- Preset, quick-change blade cartridges
- Rugged, high impact plastic housing
- Long life stainless steel blades

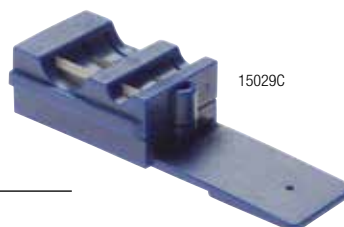

Part #	Description
15028C	ProStrip 25R Coax Stripper
15029C	Replacement Blade Cartridge for PN 15028C

E Series Coax Cable Strippers. The E Series Coax Cable Strippers are simple to operate and ensure a professional, repeatable strip every time. All strippers include a hex wrench for adjustable blade depth. Stripping lengths are also adjustable.

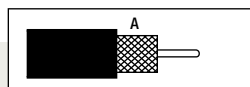

2-Level Stripping

- Factory presetting: Shield Dimension (A) 6mm (.236")
- Adjustable to additional settings: 4, 8 & 12mm (.157/.315/.472")

Part #	Description
15030C	Coax Cable Stripper, 2-Level RG58/59/62/6/6Q
15031C	Coax Cable Stripper, 2-Level RG58/59/62
15032C	Coax Cable Stripper, 2-Level RG59/62/6
15038C	Replacement Blades (2 sets), for 2-Level Strippers

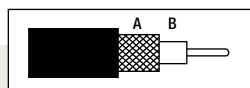

3-Level Stripping

- Factory presetting: Shield Dimension (A) 8mm (.315"); Dielectric (B) 4mm (.157")

Part #	Description
15033C	Coax Cable Stripper, 3-Level RG58/59/62
15034C	Coax Cable Stripper, 3-Level RG59/62/6/6Q
15035C	Coax Cable Stripper, 3-Level RG7/8/11/213/214
15039C	Replacement Blades (2 sets), for 3-Level Strippers

Technical / Features

- Works with RG58/59/62/6/6 Quad coax cables
- Adjustable stripping depth for various insulation types and thicknesses
- Preset for 6mm (referred to as the 1/4" strip) but adjusts to additional dimensions
- Uses drop-in replacement blades, no cassettes required
- Hex wrench snaps into housing for convenient storage
- Molded from high impact plastic for long life

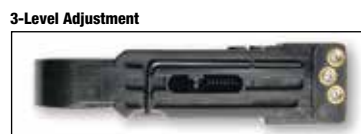

Crimp Tools & Die Sets



Terminating Connectors is as EZ as **1-2-3!**

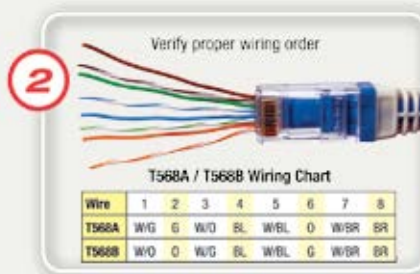
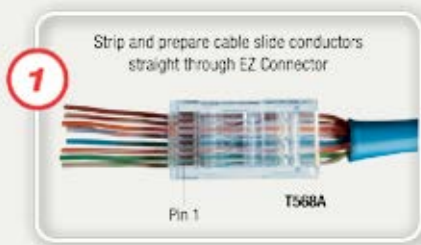



EZ-RJ45® & EZ-RJ12/11™
Connectors: pages 42-43

EZ-RJPRO™ HD Crimp Tool.

The EZ revolution continues – the EZ-RJPRO™ HD Crimp Tool is designed for the professional installer demanding consistent, reliable and repeatable terminations, every time. This heavy duty tool is the perfect solution when working with high performance, larger OD cables that are tougher to terminate due to larger wire gauges, thicker, harder insulation and pair separating splines. Overcome these connectivity obstacles and be assured that every termination will meet FCC specifications.

Technical / Features

- Compatible with all EZ-RJ45® and EZ-RJ12/11™ Connectors as well as all standard modular plugs, except AMP
- Ratcheted, high leverage and stable platform for consistent, repeatable terminations
- Patented “crimp and trim system” delivers a clean, flush trim on the extended conductors for all EZ Connectors
- Zero flex frame prevents torque loss
- Tool steel die head assembly provides 360 degrees of connector support
- Full surface to surface contact delivers uniform crimp force
- Built-in cutter for flat and round cable
- Built-in stripper for round and flat cable
- Laser marked with wiring guide for proper wire sequence

Part #	Description
100054C	EZ-RJPRO™ HD Crimp Tool
100054BL	Replacement Blade Set for PN 100054C
100054SBL-10C	Replacement RJ45 Blade, Pack of 10

EZ-RJ45® Crimp Tool. This high quality crimp tool is designed to quickly crimp and cut the wires of the EZ-RJ45® Connector in one easy simple operation! The ratcheted straight action crimping motion ensures a uniform crimp every cycle. Features precision cast crimping dies for superior accuracy. Built-in wire cutter and stripper for silver satin. All steel frame with rust resistant black oxide finish.



EZ-RJ45® & EZ-RJ12/11™
Connectors: pages 42-43

Technical / Features

- For use with EZ-RJ45® Cat5/5e & Cat6 Connectors
- Crimps and trims extended wire in EZ-RJ45® Connectors in a single cycle
- Features precision cast crimping dies for superior accuracy
- Built-in wire cutter and stripper for silver satin
- Laser marked with wiring guide for proper wire sequence
- Also compatible with all standard modular plugs (except AMP)

Part #	Description
100004C	EZ-RJ45® Crimp Tool
100004BL	Replacement Blade (2 blades) for PN 100004C

EZ-Viking™ Crimp Tool. The patented EZ-Viking™ Crimp Tool was developed to meet the most demanding network performance. This single function professional crimp tool, is precision manufactured to the highest international standards and delivers the highest quality, consistent modular plug terminations available. Applications include high-end data centers, aerospace and broadcast.

Technical / Features

- Optimizes termination of EZ-RJ45® Cat5e/6 regular/shielded & external/internal ground connectors
- Parallel action for precision crimping
- Ergonomic, pistol grip ratchet action for full crimp cycle
- Highest quality and durability – minimum of 50,000 cycles
- Zero flex frame prevents torque loss during the crimping cycle
- Tool steel die provides 360 degree connector support during crimp for tighter tolerances
- Flush trim on the EZ-RJ45® extended conductors
- Factory set with precise eccentric cam adjustment
- Safety release
- Made in Sweden



- * PN 100543K1**
- Blade Spacer
 - Blade
 - Blade Return Springs
 - 6" Safety Wire (0.02" dia)
 - Blade Retention Nuts
 - Blade Retention Springs

Part #	Description
100544	EZ-Viking™ Crimp Tool
100543BL	Replacement Blade for PN 100543
100543	EZ-RJ45® Crimp Die Set for PN 100544
100543K1	EZ-Viking™ Field Service Kit *



Tele-TitanXg™ Modular Plug Crimp Tool. This professional crimp tool fits comfortably in your hand or your pocket. The straight action termination delivers even pressure on each of the modular plug's pins ensuring precise termination. Its superior fit and function consistently meet your performance requirements.

Technical / Features

- Specifically designed for RJ45 Cat6A/10-Gig shielded connectors (*Not for standard RJ45 modular plugs*)
- Minimal hand force
- Straight action crimp
- Compact & rugged
- Terminates to industry specified crimp heights
- Stays securely closed with gun-style lock
- Built-in cable stripper for round wire and flat satin
- Easily control the blade depth when stripping
- Built-in cable cutter

Part #	Description
12515C	Tele-TitanXg™ Modular Plug Crimp Tool
12507BL	Replacement Blade Set for PN's 12515C and 12507C



10Gig Termination Kit™

Kit includes the Tele-TitanXg™ and 10-Gig shielded connectors. The pairing that assures you will achieve 10-Gig performance every time.

PN 90170, see Kits page 72.

Tele-TitanXg 2.0™ Modular Plug Crimp Tool. The next generation in our 10Gig Termination System combines two crimpers into a single tool, making 2-step crimping simple. First, insert the connector into the front end to terminate the contacts and switch to the back end to crimp the external ground. Like the original, the new Tele-TitanXg 2.0, along with our 10-Gig Shielded Connectors, are engineered specifically for Cat6A cables to provide true 10-Gig performance each and every time.

Technical / Features

- One tool does the job of two tools
- Improve efficiencies by not having to change out tools in the middle of your termination
- Straight action crimp achieved with minimal hand force
- Compact and rugged design
- Terminates to industry specified crimp heights
- Gun-style lock for secure closure
- Non-slip handle and finger grooves for comfortable grip and control
- *Not to be used on standard RJ45 modular plugs*

Application

- RJ45 Cat6A/10-Gig Shielded RJ45 Connectors
- Cat6E, Cat6A, Cat7 & over-sized Cat5e/6 Industrial Ethernet Cables
- RJ12/11 connectors

Part #	Description
12516C	Tele-TitanXg 2.0™ Crimp Tool
12517C	Tele-Titan Xg 2.0™ Combo 10-Pack

Tele-Titan™ Xg 2.0

The Cat6A/10-Gig Termination Solution!

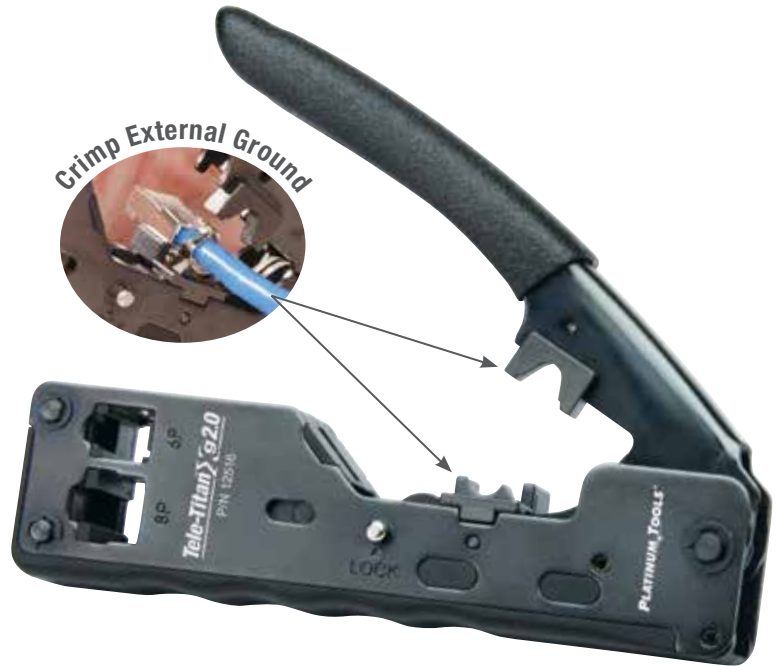

CT-360 External Ground Crimp Tool. Crimps 360° on the external ground tab of shielded RJ45 connectors. Tool design allows the installer to perform a concentric termination with full control, preventing over/under crimping.

Technical / Features

- Non-ratcheted design
- Dual cavity covers wide range of cable ODs
- Spring loaded
- Simple design, easy to use
- Works on most external ground tabs
- All steel frame
- Black oxide finish

Part #	Description
12360C	CT-360 External Ground Crimp Tool





**Compact
& Rugged**

Tele-Titan™

Tele-Titan™ Modular Plug Crimp Tool. This professional crimp tool fits comfortably in your hand or pocket. The straight action termination delivers even pressure on each of the modular plug's pins ensuring precise termination. Its superior fit and function consistently meet your performance requirements.

Technical / Features

- Rugged – for professional use and reliability
- Crimps with minimal hand force
- Lightweight and half the size of a standard crimp tool
- Stays securely closed for storage with “gun safety lock-style” design
- Embedded cable strippers for round & flat cables; built-in cable cutter

Connectors: pages 46-47

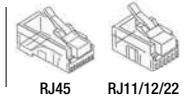

Part #	Description
12507C	Tele-Titan™ Modular Plug Crimp Tool
12507BLC	Replacement Blade Set for PN's 12507C and 12515C
12508C	Tele-Titan™ Combo Pack

12508C Combo contents:

- Tele-Titan™ Modular Plug Crimp Tool, PN 12507C
- 10 – RJ45 Cat5e connectors
- 10 – RJ11 connectors



All-In-One Modular Plug Crimp Tool. Combines a rugged design with multi-purpose functions for all telecom and network installers working with RJ45, RJ12, RJ11 & RJ22 (handset) modular plugs. Manufactured to provide reliable terminations every time.

Technical / Features

- Works with RJ45/12/11/22 modular plugs with Cat5, Cat5e and Cat6 cables
- Three separate crimp cavities for 4, 6 & 8 position modular plugs
- Ratchet mechanism with quick release assures optimum termination
- Built-in round and flat (silver satin) cable strippers and cable cutter
- All steel frame with rust resistant black oxide finish; rugged PVC handles

Connectors: pages 46-47

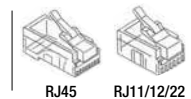

Part #	Description
12503C	All-In-One Modular Plug Crimp Tool
12503BLC	Replacement Blade Set for PN 12503C

PROAMP™ Crimp Tool. The PROAMP™ Crimp Tool is designed for installing AMP style modular plugs. The platform provides reliable, repeatable terminations every time. This heavy duty tool is the perfect solution when working with high performance, bigger OD cables that are tougher to terminate due to larger wire gauges, thicker, harder insulation and pair separating splines. Overcome these connectivity obstacles and be assured that every termination will meet FCC specifications.

Technical / Features

- Crimps AMP style RJ45, RJ12 and RJ11 modular plugs; solid, stranded, unshielded (UTP) and shielded (STP)
- Die head assembly manufactured from tool steel
- Provides 360° of connector support during crimp cycle – expanded surface area on contact drivers delivers full, uniform crimp force
- Built-in cutter and cable jacket strippers (for round and flat cables)

Part #	Description
100055C	PROAMP™ Crimp Tool
100055BL	Replacement Blade Set for PN 100055C

SealSmart™ Compression Crimp Tool.

The original SealSmart™ provides simple, fast and reliable terminations for F, RCA & BNC compression style connectors. It's the perfect solution for CATV, DSS, security and residential structured wiring installations. Connector adapters mount in handle for easy storage. Straight action mechanism provides uniform compression.



Technical / Features

- Crimps F, RCA and BNC and Right angle compression style connectors – simply insert proper adapter
- Use on RG59, RG6 and RG6Q shielded cables
- Adjustable crimp stroke enables tool to work with SealSmart™ and other manufacturers' compression connectors
- F, RCA and BNC connector crimping adapters included (spare adapters available)

Part #	Description
16201C	SealSmart™ Compression Crimp Tool
16202C	BNC Adapter & Nut
16203C	F Adapter & Nut
16204C	RCA Adapter & Nut

SealSmart™ II Compression Crimp Tool.

Easily terminate F, RCA and BNC compression style connectors without changing adapters. The universal head easily adjusts to the proper crimp stroke, making it compatible with most standard compression connectors.

Technical / Features

- Crimps all standard F, RCA, BNC and right-angle compression style connectors
- Works with RG59, RG6, RG6Q and mini RGB coax cables
- Lock washer holds head in place once adjusted to proper crimp stroke

Part #	Description
16220C	SealSmart™ II Compression Crimp Tool



F Connector Compression Crimp Tool. This professional quality tool will withstand the rigors of continuous field use. Manufactured from tool steel and chrome plated with non-slip vinyl grip. At only 5 ½" long, its small compact design fits and feels right in the hand. Works great when terminating F connectors inside a panel box.

Technical / Features

- Crimps compression F connectors onto RG6Q/RG6/RG59 coax
- Small compact design, 5 ½" long
- Great for working in tight spaces
- Tool locks in the closed position when not in use

Part #	Description
16207C	F Compression Crimp Tool



SealSmart™ PROCON Compression Crimp Tool.

The newest addition to the SealSmart™ product line is designed for professional contractors installing CATV & CCTV networks who need quick, reliable results every time. Engineered for long life, this rugged tool features a patented rotating connector positioner-head and multi-head adapter.

Technical / Features

- Head rotates from RG6Q/6/59 to RG11/7
- Connector positioner accepts F, BNC or RCA
- Adjustable crimp stroke accommodates standard compression F, BNC, RCA & right angle connectors
- High carbon tool steel frame
- Comfortable, molded handle

Part # Description

16213C	SealSmart™ PROCON Compression Crimp Tool
16215C	Replacement Multi-Head Adapter for PN 16213C

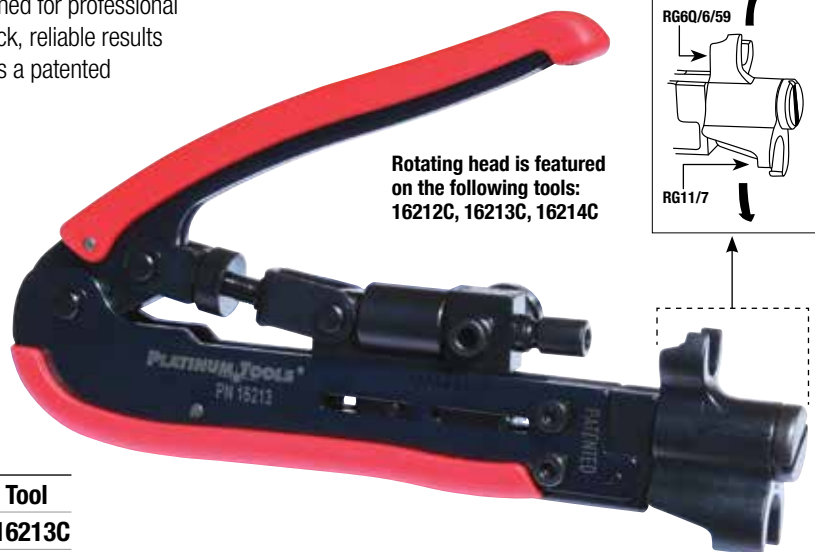

SealSmart™ RH360L F Compression Tool – Long Stroke.

This rugged tool is designed for the CATV installation contractor. Patented rotating head allows for quick change between RG11/7 and RG59/6/6Q with no adjustments required. Crimp height is fixed for most other brands of connectors with similar compression length meeting the industry standard when fully compressed.

Technical / Features

- Crimps SealSmart™ F connectors on RG59/6/6Q and RG11/7 coax cables
- Works with most other brands of compression F connectors with similar length on RG59/6/6Q and RG11/7 coax cables
- Molded cushioned handle for comfort
- High carbon tool steel frame with black oxide rust resistant finish



Part #	Description
16212C	SealSmart™ RH360L F Compression Tool - Long Stroke

SealSmart™ RH360S F Compression Tool – Short Stroke.

This rugged tool is designed for the CATV installation contractor using short type EX compression F fittings. Patented rotating head allows for quick change between RG11/7 and RG59/6/6Q without adjusting tool. Crimp height is fixed for PPC Aquatight® connector 'EX or short version' compression fittings and others with similar compression length.

Technical / Features

- For crimping short type EX compression F connector fittings on RG59/6/6Q, RG/11/7 and QR320 coax
- Comfortable, molded cushioned handle
- High carbon tool steel frame with black oxide rust resistant finish



Part #	Description
16214C	SealSmart™ RH360S F Compression Tool - Short Stroke

Open Barrel Contact Crimp Tool. Simultaneously performs electrical & strain relief crimps of 24-18 AWG open barrel contact pins. Crimping cavities are precision ground and heat treated for long life.

Technical / Features

- 24-22 AWG & 20-18 AWG wire ranges
- Spring loaded for ease of use and locking latch for storage
- Soft, comfortable molded handles
- Built-in wire cutter

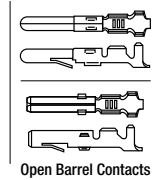

Part #	Description
16801C	Open Barrel Contact Crimp Tool



4-Way, 8 & 12 Point Indent Crimp Tools. An economical alternative to MIL-SPEC® (MS22520) approved crimping tools. Providing a higher level of reliability and greater pull strength, the dies are precision machined from tool steel and heat treated for long life. The tools feature a full cycle ratchet mechanism and include a built-in contact locator.

Technical / Features

- 4-Way, 8 point or 12 point indent crimping styles
- Wire range: 26 - 20 AWG
- For use on solid barrel type contacts used in RS-232 style connectors
- For use on BNC/TNC solid barrel center contacts

Part #	Description
13010C	4-Way, 8 Point Indent Crimp Tool
13015C	4-Way, 12 Point Indent Crimp Tool

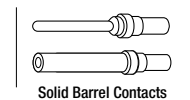

9" Ergo Crimp Tool. Here's the next generation of crimp tool technology designed around the user. Crimping is even easier and more comfortable. The "straight plate" lower jaw assembly eliminates critical structural stress points, common in most competitive tools - it will not break under heavy stress and will last for years to come. Higher performance, reliability and comfort, it's all here.

Technical / Features











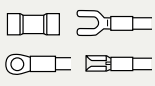



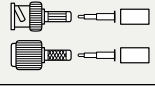

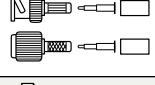



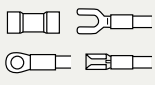

- Crimps insulated terminals to 10 AWG and non-insulated terminals to 8 AWG
- Variety of crimp dies available for CATV F, BNC, TNC, SMB, SMA and N series coaxial connectors
- Accepts crimp die sets from most other popular tools. Your old crimping dies will work!
- Reduced handle grip distance makes it ideal for all hand sizes and allows for prolonged, comfortable use
- Smooth ratcheted crimp cycle with a safety release and no break over hand force
- Adjustable cam for precision ratchet adjustment, allowing for a perfect crimp, no matter the die set or application

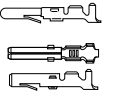

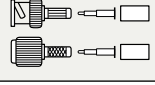
Part #	Description
16500C	9" Ergo Crimp Tool, Frame Only
17099C	Quick Change Die Screws - Set of 2

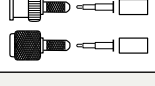

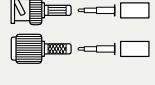
9" Ergo Crimp Tool Dies and Applications

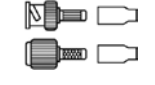
Die	Crimp	Part # Tool & Die / Die Only	Cable Types	Crimp Type/Sizes	Connector Types
		16501C / 17051C	22-10 AWG Solid or Stranded	3 Cavity 22-18 AWG (.34-.75 mm ²) 16-14 AWG (1.5-2.5 mm ²) 12-10 AWG (4-6 mm ²)	Heavy Duty Insulated Terminals and Lugs
		16502C / 17052C	22-8 AWG Solid or Stranded	4 Cavity 22-18 AWG (.34-.75 mm ²) 16-14 AWG (1.5-2.5 mm ²) 12-10 AWG (4-6 mm ²) 8 AWG (10 mm ²)	Non-Insulated Terminals
		16503C / 17053C	RG59/6 Belden 8281/1694A	Hex .042 / .068 / .255 / .324	BNC, TNC, HDTV
		16504C / 17054C	RG58, RG59, RG62	Hex .068 / .213 / .255	BNC, TNC 3 Piece
		16505C / 17055C	RG59, RG6	Hex .256 / .315 / .346	F Type, 1 & 2 Piece CATV
		16506C / 17056C	RG6, RG6Q, 8281 1694A, 1695, 1505, 9259, 9231	Hex .360 / .324 / .068	BNC, TNC, F Type
		16507C / 17057C	22-10 AWG Solid or Stranded	3 Cavity 22-18 AWG (.34-.75 mm ²) 16-14 AWG (2.5-1.5 mm ²) 12-10 AWG (4-6 mm ²)	Standard Duty Commercial Insulated Terminals & Lugs
		16508C / 17058C	22-10 AWG Stranded	3 Cavity 22-18 AWG (.34-.75 mm ²) 16-14 AWG (2.5-1.5 mm ²) 12-10 AWG (4-6 mm ²)	Commercial Pin & Socket Type Contacts, Open Barrel Contacts, Box Contacts
		16509C / 17059C	RG174, 187, 188, 316 Mini Coaxial	Hex .178 / .128 / .068	SMA, SMB, Mini 59, BNC, TNC, Mini UHF
		16510C / 17060C	RG8, RG11, RG213, RG214, LMR400	Hex .429 / .100 / .080	N Type Plugs
		16511C / 17061C	RG59/62, 734, 735, RG6	Hex .311 / .256 / .200 / .068 / .039	HDTV, True 75 Ohm BNC, TNC
		16512C / 17062C	RG6/6TFE/59/59TFE/58 RG59/59TFE RG58	Hex .320 / .264 / .250 / .212	Universal 2-Piece BNC, TNC with 2-Step Ferrule & Captive Contact

Contact us about custom dies.



8" Crimp Tool. Features comfortable, ergonomically designed handle grips with a smaller handle spread. The tool's light weight and compact design is very popular in the higher production environments. Perfectly suited for hard to handle open barrel contacts and fiber optic connectors. Crimp release lever improves throughput by eliminating rejected terminations resulting from improper connector positioning. Accepts crimp die sets from a wide variety of manufacturers and are easily interchangeable.

Technical / Features

- Full cycle ratchet mechanism
- Quick release lever
- Smaller handle spread
- Accepts die sets from a variety of manufacturers

Part #	Description
16000C	8" Crimp Tool, Frame Only

8" Crimp Tool Dies and Applications

Die	Crimp	Part # <small>Tool & Die / Die Only</small>	Cable Types	Crimp Type/Sizes	Connector Types
		16001C / 16051C	Fiber Optic	Hex .151 / .178 / .213	Fiber Optic SMA, ST, SC, FC
		16003C / 16053C	Fiber Optic	Hex .128 / .151 / .178	Fiber Optic SMA, ST, SC
		16004C / 16054C	24-12 AWG Stranded	2 Cavity 24-20, 18-14 AWG	Open Barrel Contacts
		16005C / 16055C	30-18 AWG Stranded	2 Cavity 30-24, 22-18 AWG	Open Barrel D-Sub, RS232 Pin & Socket Contacts
		16006C / 16056C	16 AWG Stranded	2 Cavity Male / Female Contact	Open Barrel Pin & Socket Contacts w/ Waterproof Gasket
		16007C / 16057C	22-10 AWG Solid or Stranded	5 Cavity 22-10 AWG	DIN & US Type Wire Ferrules (Cord End Terminals)



Tips & Tricks

Color Coded Strain Reliefs: What is the max cable OD?

The answer is 0.235 inches! These will only work with the EZ-RJ45® Cat6 (page 42) and all Standard Modular RJ45 Plugs (page 46). **See page 44 for Strain Reliefs.**
NOTE: Not compatible with the EZ-RJ45® Cat5e connectors.



Punchdown Tools

PRO-Strike™



13150C

PRO-Strike™ Punchdown Tool. Combines rugged design, an ergonomic comfort grip handle and enhanced functions. The primary tool for all telecom and datacom installers working with 110, 66, Krone and BIX™ style cross connects. This professional tool will provide precise, repeatable and reliable terminations that helps ensure installations pass certification and your peace-of-mind.

Technical / Features

- Terminate and cut Cat3/5/5e/6 cables
- Spring loaded for fast, low effort wire seating and termination
- Bayonet style (twist & lock) blade retention socket is compatible with industry standard tools and blades
- New built-in hook – feeds or removes wire
- New multi-use spudger – for screwdriver, IDC insert tool or to clean debris
- 110, 66, 630, Krone and BIX™ style interchangeable blades
- Color coded yellow on the cut side of the tool per industry standard
- Adjustable low and high force impact settings are precisely controlled to meet the industry standard 8762D Spec
- Will not damage sensitive circuitry
- Spare blade storage compartment in the handle

Part #	Description
13150C	PRO-Strike™ Punchdown Tool, Blades Not Included
13155C	PRO-Strike™ Punchdown Tool, w/66 Blade
13156C	PRO-Strike™ Punchdown Tool, w/110 Blade
13157C	PRO-Strike™ Punchdown Tool, w/66 & 110 Blades
13159C	PRO-Strike™ Punchdown Tool, w/66/110 Combo Blade

We Make Connections EZ

Punchdown Blades

Technical / Features

- Bayonet style (twist & lock) blades are compatible with all industry standard punchdown tools
- Manufactured from high carbon tool steel
- Heat treated for durability

Part #	Description
13001C	Punchdown Blade, 66 Style
13002C	Punchdown Blade, 110 Style
13003C	Punchdown Blade, 630 Style
13004C	110 EZ-Data Cut Blade®, w/2 Spare Knives
13004BLC	Replacement Knives (Pkg 3) for PN 13004C
13021C	Combo 66/110 Blade
13022C	Punchdown Extension Tool
13023C	Punchdown Blade, BIX™ Style
13024C	Punchdown Blade, Krone Style

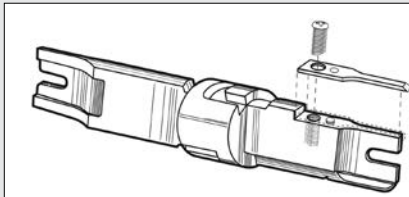

Cutting knife is easily replaced for sharp, reliable performance

110 EZ-Data Cut Blade®

- Replaceable cutting knives, precision ground from medical grade stainless steel
- Lower cost, replace just the cutting knives, not the complete blade
- Beveled cutting edge
- Faster, cleaner termination
- Less stress on sensitive circuitry





13105C

PRO Punchdown Tool. Combines a rugged design with ergonomic function. Provides precise, repeatable and reliable terminations every time. Precision controlled impact force settings for optimum termination of sensitive circuitry found in Cat5e and Cat6 cross connects.

Technical / Features

- Terminate and trim wires in 66, 110, Krone and BIX™ style cross connect blocks and in 110 and 630 wall jack modules
- Bayonet style (twist & lock) blade retention socket is compatible with industry standard tools and blades
- Spring-loaded for fast, low effort wire seating and termination
- Adjustable HI/LO impact settings are precisely controlled to meet industry standard 8762D specification
- Will not damage sensitive circuitry
- Embedded rubber finger grip
- Spare blade storage compartment in tool handle

Part #	Description
13100C	PRO Punchdown Tool, Blades Not Included
13105C	PRO Punchdown Tool w/66 Blade
13106C	PRO Punchdown Tool w/110 Blade
13107C	PRO Punchdown Tool w/66 &110 Blades
13108C	PRO Punchdown Tool w/110 EZ-Data Cut Blade®
13109C	PRO Punchdown Tool w/Combo 66/110 Blade

Punchdown Impact Tool. The basic tool for all telecom and data communications installers. Seats and trims wire in 110 and 66 style cross connects along with 110 and 630 style wall jacks. Spring loaded for fast, low effort wire seating and termination. Color coded yellow on the cut side of the tool conforms to the industry standard.

Technical / Features

- Bayonet style blade retention mechanism is compatible with industry standard tools and blades
- Adjustable low and high impact force settings
- Spare blade storage compartment in the handle

Part #	Description
13000C	Punchdown Impact Tool, Blades Not Included
13005C	Punchdown Impact Tool w/66 Blade
13006C	Punchdown Impact Tool w/110 Blade
13007C	Punchdown Impact Tool w/66 & 110 Blades
13008B	Punchdown Impact Tool w/110 EZ-Data Cut Blade®



13005C

JackAX™ 110 Termination Tool. The patented JackAX™ terminates keystone jacks and seats the wire every time for ultimate performance and certification! The innovative design ensures 110 jacks are properly terminated eliminating common NEXT and FEXT failures.

Technical / Features

- Terminates all standard brands of 90° and 180° jacks
- Uses standard 110 blades—no expensive die set heads to purchase
- More comfortable to use than the traditional punchdown tool and puck
- Zero impact termination prevents block damage or stress
- Increases performance, accuracy and productivity on the job site
- Engineered for ease of use— including applications inside walls and junction boxes
- Quickly adjusts for 90° and 180° terminations, including single row pairing jacks
- Blade securely held in place with simple screw
- Rubber-molded handles for sure grip

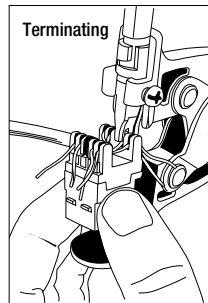
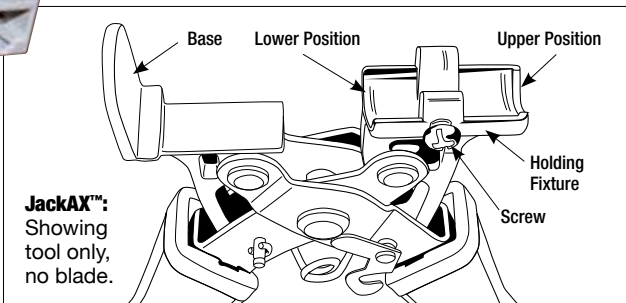
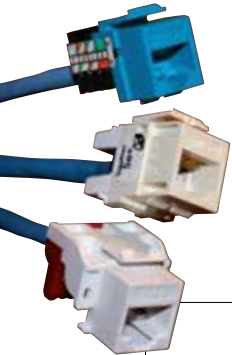

Part #	Description
13212C	JackAX™ 110 Termination Tool with 110 Standard Blade
13211C	JackAX™ 110 Termination Tool with 110 EZ-Data Cut Blade®
13210	JackAX™ 110 Termination Tool (frame only), Blades Not Included

Non-Impact Tool with 110 EZ-Data Cut Blade®.

This economical non-impact tool includes the patented 110 EZ-Data Cut Blade® for a new level of performance. It features a precision ground, replaceable cutting knife with a beveled cutting edge for faster, cleaner terminations.

Technical / Features

- Terminates 110-style keystone blocks and jacks
- Lower cost, replace just the cutting knife
- Faster, cleaner terminations



Part #	Description
100111C	Non-Impact Tool with 110 EZ-Data Cut Blade®
13004BLC	Replacement Knives (Pkg 3)

PRO Punchdown Kit.

Keeps your tools readily accessible and organized so you're always ready to perform those datacom jobs. This belt pouch kit will quickly become part of your daily gear. Kit includes Black, Fine Tip Sharpie® Pen and product instructions.

90152C – PRO Punchdown Tool Kit

Kit Contains:

Part #	Description
10525C	Professional Electrician's Scissors
13100C	PRO Punchdown Tool
13002C	110 Punchdown Blade
4015C	Punchdown Tool Pouch



Specialty Tools

Terminal Crimp Tool. Designed and manufactured to provide superior performance, durability and value. It features dual crimping cavities for insulated and non-insulated terminals and splices. The thin tapered nose assists when working in confined areas.

Technical / Features

- Crimp non-insulated terminals and splices from 10-22 AWG
- Crimp insulated terminals and splices from 10-22 AWG
- Precision ground and hardened cutting blade
- Drop forged from chrome vanadium steel alloy to prevent rust
- Comfort grip dipped handles
- Cuts copper and aluminum wire up to 10 AWG
(not suitable for cutting steel)

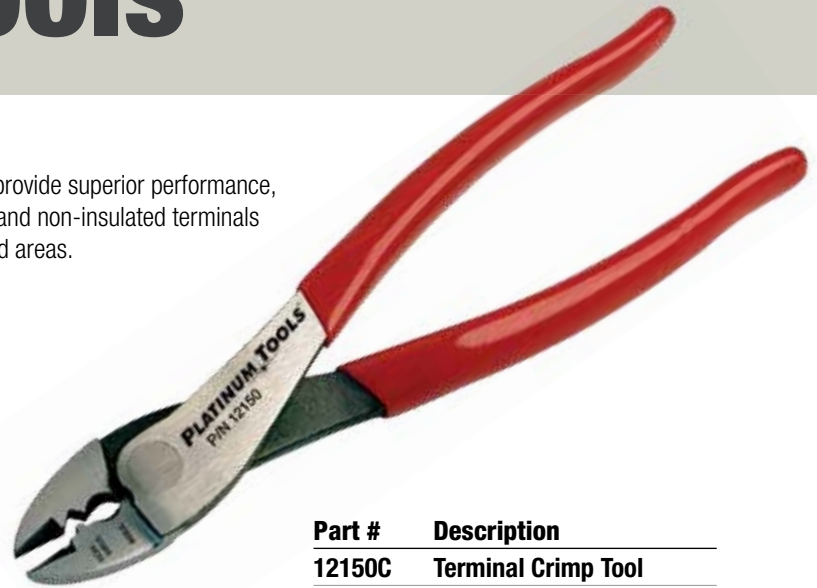

Part #	Description
12150C	Terminal Crimp Tool

8.5" and 6" Lineman's Pliers. A fresh take on a classic design for gripping, twisting, bending and cutting wire and cable. The two-tone (TPR) molded comfort grip handle helps make any job a breeze. Features a 6140CrV drop forged body with a hardness level of 45+/-3 and a blade hardness of 58-61 to ensure a clean cut for years to come. The 6" Lineman's Pliers smaller design allows for it to fit in places other Lineman's pliers cannot.

Technical / Features

- Body material: 6140CrV
- Body hardness: 45 +/- 3
- Blade hardness: 58 - 61
- Handle material: Black & Red TPR

Part #	Description
12201C	8.5" Lineman's Pliers
12206C	6" Lineman's Pliers



Connector Pressing Telecom Pliers.

Designed to crimp telecom-style splice connectors including UG, UR, UB and UY style made by 3M and other manufacturers. Manufactured in accordance with Bell Specifications, these pliers feature a built-in side cutter, coil spring and a built-in stop to prevent damage to connectors.

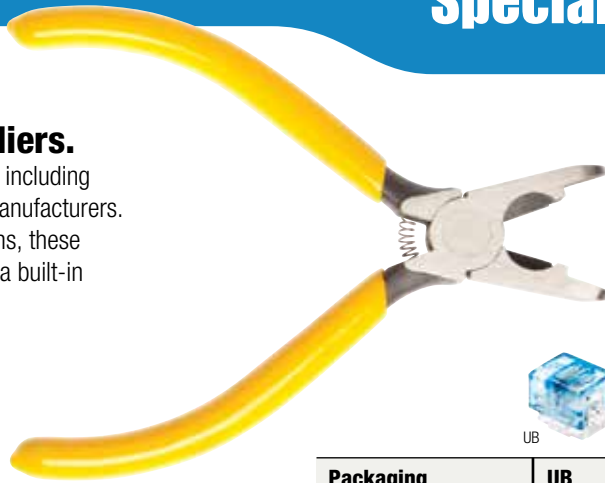

Technical / Features

- Use for pressing/crimping UR, UY, UG and UB style connectors
- Also compatible with other telecom-style splice connectors
- Built-in side cutter and stop
- Coil spring
- Vinyl handles

Packaging Description	UB 22-26 AWG	UR 19-26 AWG	UY 22-26 AWG
Clamshell – 25 Pieces	18131	18111	18121
Clamshell – 50 Pieces	18112C		
Clamshell – 100 Pieces	18132C		18122C
Box – 100 Pieces*	18130	18110	18120
Jar – 200 Pieces	28110J		

Part #	Description
12100C	Connector Pressing Telcom Pliers

* Bulk quantities available. Contact us for pricing & delivery.

Can Wrench. For telephone craftwork to connect wires to fuses, tighten nuts on binding post terminals and insert fuses in cable terminals. Double ended 3/8" and 7/16" hex sockets are color coded for quick identification of socket sizes. Design allows use of a wrench for additional torque. Sockets designed with thin walls for access into tight spaces.

Technical / Features

- 3/8" & 7/16" hex nuts
- Access telephone boxes and pedestals
- Tighten nuts on binding post terminals
- Rugged high impact extruded plastic handle
- Manufactured from high carbon tool steel and heat treated for strength and durability



Part #	Description
19059C	Can Wrench

Heavy Duty Cable Tie Gun.

The professional's choice with its robust all steel construction, adjustable tension wheel and automatic cut-off. Trims cable ties flush, eliminating dangerous sharp edges on cable ties. Use with standard and heavy duty cable ties.

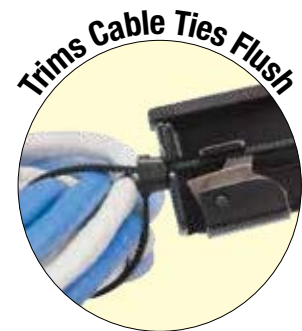

Technical / Features

- Maximum capacity of 0.250" width
- Tension adjustment wheel in handle
- Automatic flush cut-off eliminates sharp edges on ties

Part #	Description
10200C	Heavy Duty Cable Tie Gun

PRO Drywall Saw. Designed for the demands of professional installers who expect efficiency, ease of use and accuracy. The teeth are precision ground for fast and effortless cutting in both directions – push and pull. The extra thick blade (1.8mm) prevents bending and breaking during use whether cutting, punching or scoring.

Technical / Features

- Heavy duty handle designed with a non-slip grip for comfort and safety
- Hardened blade tip designed to score or punch with ease
- One piece handle and blade design
- Ideal for cutting various surfaces, including:
 - Drywall
 - Plywood
 - Plaster board
 - Wallboard
 - Plastic paneling
 - Ceiling tile
- Blade material: High carbon steel SK5
- Rust resistant electrophoretic deposition finish on the blade
- Dimensions: Blade 6 1/4" (160mm)
Handle 5 1/2" (140mm)

Part #	Description
10711C	PRO Drywall Saw w/Sheath



1.0/2.3 Connector Removal Tool. Designed to un-mate the push on style 1.0/2.3 Din 75 ohm connector. In high density applications on panels or racks, this tool is a must have for the tool box.

Made in the USA

Technical / Features

- Precision machined and formed
- Nickel plated
- Extruded and polished resin handle
- Overall length 12"

Part #	Description
11050	1.0/2.3 Connector Removal Tool

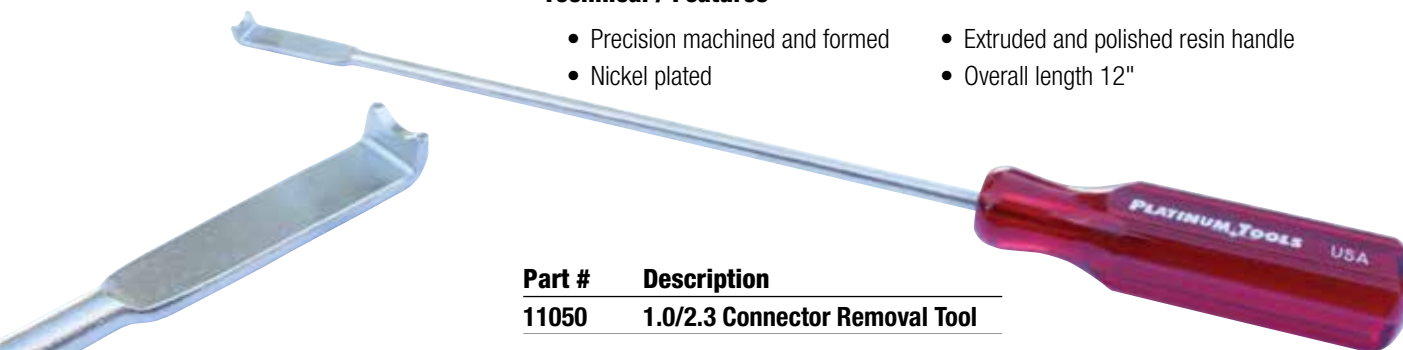

BNC Removal Tools. Designed and manufactured for the true broadcast and telecom installation professional. Outperforms all other BNC removal tools in the market today. The barrel is precision machined from high strength tool steel and heat treated for long life. It will not stretch!

Technical / Features

- Use to insert and remove BNC connectors in digital video patch bays and in high-density DSX cross connect systems
- Wider barrel slot fits over Canare L-7CFB and Belden 9292 cables
- Extruded and polished resin handle

Made in the USA

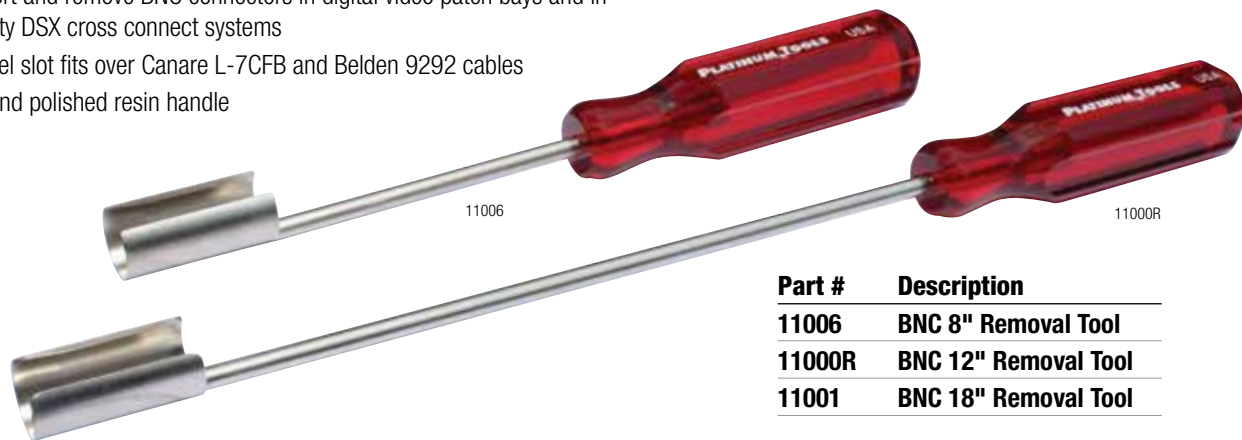

Part #	Description
11006	BNC 8" Removal Tool
11000R	BNC 12" Removal Tool
11001	BNC 18" Removal Tool

BNC Economy Removal Tools. Manufactured for the professional installer on a budget. Whether working on security, audio or video installations, the Economy Series BNC Removal Tools will perform beyond your expectations without compromise.

Technical / Features

- Use to insert and remove BNC connectors in digital video patch bays and in high-density DSX cross connect systems
- Machined from tool steel and heat treated
- Durable handle made from resin

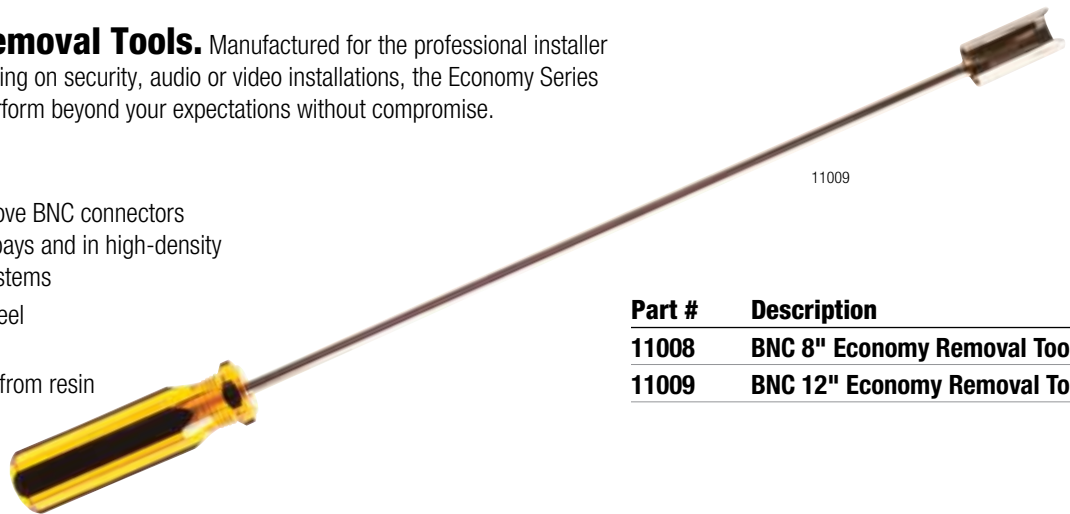

Part #	Description
11008	BNC 8" Economy Removal Tool
11009	BNC 12" Economy Removal Tool

F Connector Assembly & Removal Tools. These dual function tools feature a 7/16 inch hex socket at one end and 3/8-32 thread at the other end. The hex socket slides over the cable and rear of the connector for easy mating and un-mating of hard to grasp F connectors. The threaded end provides a stable surface for cable insertion when prepping connectors for termination and can also be used as a thread chaser.

Technical / Features

- 7/16 inch hex socket for mating and un-mating
- 3/8-32 threaded end for connector assembly
- Rugged extruded plastic handle
- Long life chrome finish

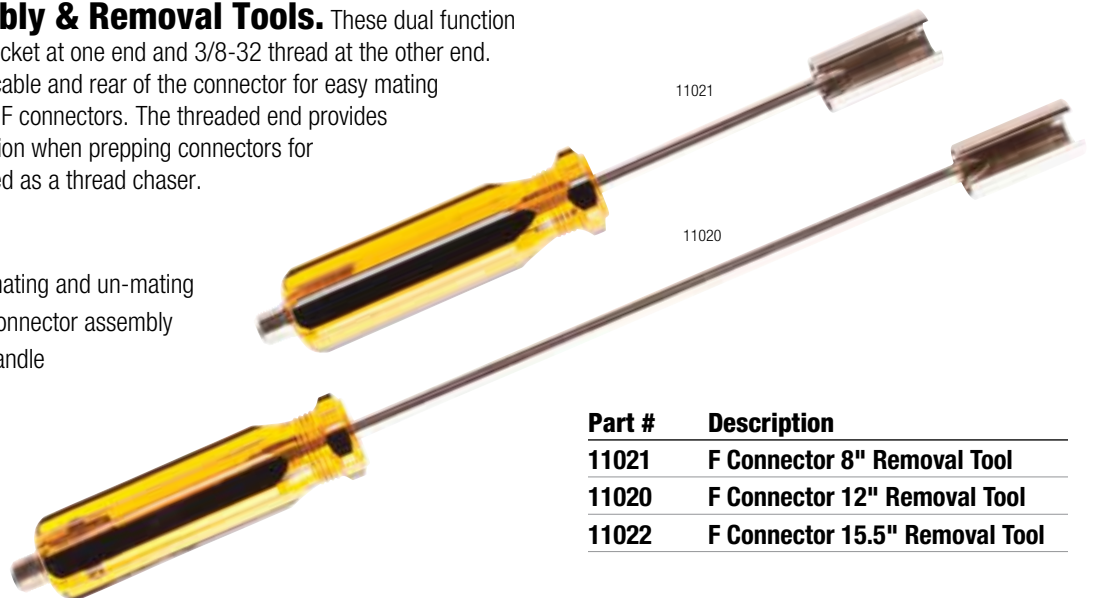

Part #	Description
11021	F Connector 8" Removal Tool
11020	F Connector 12" Removal Tool
11022	F Connector 15.5" Removal Tool

EZ-Grip Puck®. Manufactured from a rubberized material for flexibility and durability, this simple tool saves time and energy when working with wire and cable. Fit the puck in the palm of your hand to dramatically improve your grip when pulling or pushing cable. Also, use the puck as a stable base for keystone punching.

Technical / Features

- Improves grip when pulling fish tape through conduit
- Provides a stable base for terminating wire in a keystone jack
- Improves grip when pushing cable into F connectors



Part #	Description
100333	EZ-Grip Puck®

PRO 6-in-1 Standard and Security Screwdriver.

These ergonomically designed screwdrivers have a high impact plastic core covered in a comfortable cushion grip handle. This feature allows the screwdriver to be used for extended periods of time without hand fatigue or stress. Multiple bit loads included for various applications.

19002C Bit Load

- **Phillips:** #1 & #2
- **Slotted:** #5 & #7
- **Nut Drivers:** 1/4" & 5/16"

Bits Included



19003C Bit Load

- **Security Torx®:** T15, T20, T25, T30
- **Nut Drivers:** 1/4" & 5/16"

Bits Included



Part #	Description
19002C	PRO 6-in-1 Screwdriver
19003C	PRO 6-in-1 Security Screwdriver

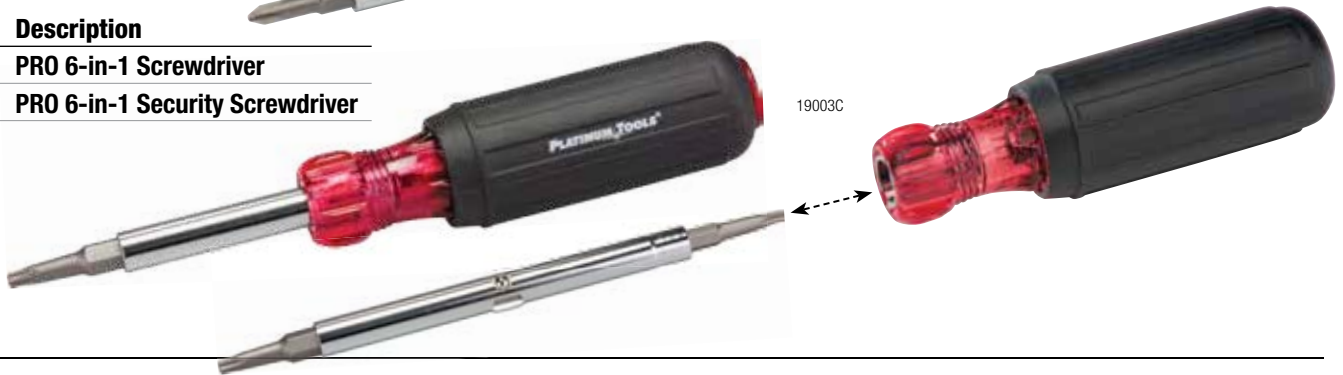
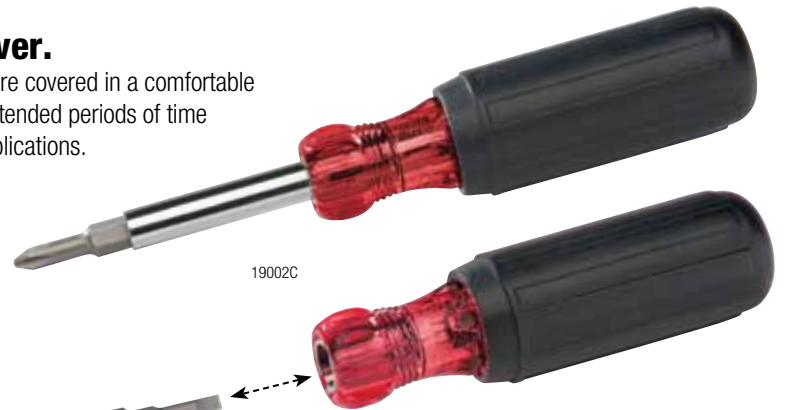

6-in-1 Screwdriver. This versatile tool is a must have for any tool belt. Double-ended reversible bits with ball detent retention. S2 alloy steel bits for long life. Molded, ergonomic high impact plastic handle.

19001C Bit Load

- **Phillips:** #1 & #2
- **Slotted:** #5 & #7
- **Nut Drivers:** 1/4" & 5/16"

Bits Included



Part #	Description
19001C	6-in-1 Screwdriver



Tips & Tricks

Measuring Twisted Pair Cable Length

The max length per run is 100 meters or 328 feet, and when pulling 'near max' runs, a tape measure is NOT a good tool to use! Remember you need to measure what is inside the cable, and a tester is the most precise means of measurement. Our TSS200, T129, TCB300 and the TCB700 testers (pages 65, 67, 70 & 71) will all provide you that critical information and help get the job done right the first time.



22-in-1 Security Screwdriver Kit. The perfect set for security installers - reach into those deep crevices with ease and never be without the right screwdriver. It features a non-slip, comfort grip handle with a high impact plastic core and 11 double sided security shaft style bits. The shaft style enables access into recessed screws up to 5 inches deep. The bit load includes multiple sizes of Security Torx®, Hex and Robertson along with Spanners and Tri-Wings so the list of applications is endless. This kit can be used on standard hex and torx screws and includes a slotted and Phillips head bit for traditional screwdriver applications.

19105 Bit Load

- **Security Torx®:** T8, T10, T15, T20
- **Security Hex:** 1/8", 9/64", 5/32", 3/16"
2.5mm, 3mm, 4mm, 5.5mm
- **Security Robertson:** 1, 2
- **Spanner:** 4, 6, 8, 10
- **Tri-Wings:** 2, 3
- **Slotted:** 7/32"
- **Phillips:** #2

Part #	Description
19105	22-in-1 Security Screwdriver Kit



8-in-1 Ratcheted Stubby Screwdriver. It is the perfect tool for those cramped spaces. Features a six-position bit retention holster in the cap conveniently built directly into the handle. Simply unscrew the top cap and swap bits out as needed... which means no more lost bits! Also features a high force, precision ratcheting mechanism and a non-slip, TPR rubberized grip for quick tightening and loosening of screws with minimal effort.

Technical / Features

- High force precision ratcheting mechanism
- Forward, reverse and fixed ratchet
- Hardened chromium-vanadium steel bits & shafts
- 7 bits plus a 1/4" hex nut driver

19120C Bit Load

- **Phillips:** #1, 2, 3
- **Slotted:** 3/16", 1/4"
- **Torx®:** T15, T20
- **Nut Driver:** 1/4"

Part #	Description
19120C	8-in-1 Ratcheted Stubby Screwdriver



Precision Screwdriver 33 Piece Set. Includes tips for slotted, Phillips, Pozi drive and Torx® screwdrivers along with hex sockets. The tips are manufactured from high quality, hardened chrome vanadium for long life. The screwdriver handle is molded from TPR for a comfortable, non-slip grip and adjusts from 5" to 9.5" making it perfect for those hard to reach places. Features a smooth action rotating cap and high impact plastic case for convenient storage.

Technical / Features

- Sockets & Shaft: M5 Socket, M6 Socket, M4 Shaft

19101 Bit Load

- **Pozi Drive:** PZ1 & PZ0
- **Slotted:** 1.0, 1.5, 2.0, 2.5, 3.0, 3.5, 4.0
- **Phillips:** 000, 00, 0, 1
- **Torx®:** 4, 5, 6, 7, 8, 9, 10, 15, 20
- **Hex:** 0.7, 0.9, 1.3, 1.5, 2.0, 2.5, 3.0, 4.0

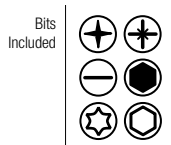

Part #	Description
19101	Precision Screwdriver 33 Piece Set



Tips & Tricks

Reshaping the BIG Stuff

Having trouble inserting cable into your connector?

Use the grip cavity of your pliers and lightly compress the concentricity of your cable, re-shaping it into an oval/rectangular shape. This will make it much easier to insert the cable into the back end of the connector and push it to the correct location as required by termination specs.

Remember, the distance from the point of termination to the twists are:

- Cat5e = less than 1/2 inch
- Cat6 = less than 3/16 inch

NOTE: This deformation will not interfere with passing certification.

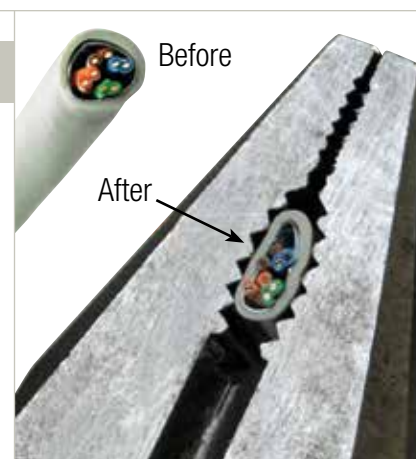

Micro Mini II 13 Piece Screwdriver Set. Features a combination of the smallest popular bits used in today's electronics. The soft grip TPR handle has a non-mag, 4mm bit holder that adjusts from 5" to 8".

Technical / Features

- Hardened (RC55) CrV 8660 Bits
- Smooth action rotating cap
- High impact plastic case

19103 Bit Load

- **Slotted:** 2.0, 1.5, 1.2, 1.0
- **Phillips:** #0000, 000, 00, 0
- **Torx®:** 3, 4, 5, 6



Part #	Description
19103	Micro Mini II 13 Piece Screwdriver Set



1 KV Insulated Precision, 6 Piece Screwdriver Set.

Convenient set of insulated, precision slotted and Phillips screwdrivers in plastic storage/carrying case. The screwdrivers provide shock protection to 1000 VAC and complies with VDE safety standard VDE-400009250.

Technical / Features

- Black oxide tip
- Dual-compound handle

19110 Bit Load

- Includes the following sizes:
 - **Slotted:** 0.23x1.5x65 / 0.4x2.0x65 / 0.4x2.5x65
 - **Phillips:** PH00x65 / PH0x65 / PH1X65



Part #	Description
19110	1 KV Insulated Precision, 6 Piece Screwdriver Set



Connectors

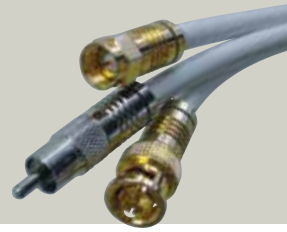

SealSmart™ Coax Compression “F” Connectors

Cable/Connector Color Code	
Red	● RG59
Black	● RG6
Blue	● RG6Q
Navy	● Mini

RG6Q



Packaging Description	Gold Plated	Nickel Plated	Right Angle Nickel Plated
Bag – 100 Pieces	18004	18001	
Bag – 25 Pieces			18001RA
Jar – 75 Pieces		28001J	
Clamshell – 10 Pieces	18005	18002	
Clamshell – 3 Pieces			18003

RG6



Packaging Description	Gold Plated	Nickel Plated	Right Angle Nickel Plated
Bag – 100 Pieces	18009	18006	
Bag – 25 Pieces			18006RA
Jar – 75 Pieces		28006J	
Clamshell – 10 Pieces	18010	18007	
Clamshell – 3 Pieces			18008

RG59



Packaging Description	Gold Plated	Nickel Plated	Right Angle Nickel Plated
Bag – 100 Pieces	18015	18011	
Bag – 25 Pieces			18011RA
Jar – 75 Pieces		28011J	
Clamshell – 10 Pieces	18016	18012	
Clamshell – 3 Pieces			18013

RGB 25 AWG



Packaging Description	Gold Plated	Nickel Plated
Bag – 25 Pieces	18225	18220

RGB 24 AWG



Packaging Description	Gold Plated	Nickel Plated
Bag – 25 Pieces	18205	18200

RGB 23 AWG



Packaging Description	Gold Plated	Nickel Plated
Bag – 25 Pieces	18215	18210

RG11



Packaging Description	Nickel Plated
Bag – 25 Pieces	18311
Clamshell – 4 Pieces	18312



SealSmart™ II Compression Crimp Tool

Easily terminate F, RCA and BNC compression style connectors without changing adapters.



See pages 19 & 20 for additional compression crimp tools

SealSmart™ Coax Compression “BNC” Connectors

RG6Q



Packaging Description	Gold Plated	Nickel Plated	Right Angle Nickel Plated
Bag – 25 Pieces	18020	18035	18035RA
Clamshell – 6 Pieces	18021	18036	
Clamshell – 3 Pieces			18037



Cable/Connector Color Code	
Red	● RG59
Black	● RG6
Blue	● RG6Q
Navy	● Mini

RG6



Packaging Description	Gold Plated	Nickel Plated	Right Angle Nickel Plated
Bag – 25 Pieces	18025	18038	18038RA
Jar – 40 Pieces		28038J	
Clamshell – 6 Pieces	18026	18039	
Clamshell – 3 Pieces			18040

RG59



Packaging Description	Gold Plated	Nickel Plated	Right Angle Nickel Plated
Bag – 25 Pieces	18030	18041	18041RA
Jar – 40 Pieces		28041J	
Clamshell – 6 Pieces	18031	18042	
Clamshell – 3 Pieces			18043

RGB 25 AWG



Packaging Description	Gold Plated	Nickel Plated
Bag – 25 Pieces	18255	18250

RGB 24 AWG



Packaging Description	Gold Plated	Nickel Plated
Bag – 25 Pieces	18235	18230

RGB 23 AWG



Packaging Description	Gold Plated	Nickel Plated
Bag – 25 Pieces	18245	18240

Tips & Tricks



Combing Your Braid

Tired of pulling the braid back over your coax cable jacket and getting little pieces of braid in your fingers?



Do it the EZ way!

Cut a small piece of Velcro, the ‘prickly’ side, and stick it on the side of your coax stripper. You now have a comb to brush back the braid over the jacket. You will be happy with how nice and even the braid looks and your fingers will be happy too!

SealSmart™ Coax Compression “RCA” Connectors

RG6Q



Packaging Description	Gold Plated	Nickel Plated	Right Angle Nickel Plated
Bag – 25 Pieces	18057	18065	18065RA
Clamshell – 6 Pieces	18058	18066	
Clamshell – 3 Pieces			18067



Cable/Connector Color Code	
Red	● RG59
Black	● RG6
Blue	● RG6Q
Navy	● Mini

RG6



Packaging Description	Gold Plated	Nickel Plated	Right Angle Nickel Plated
Bag – 25 Pieces	18052	18051	18051RA
Jar – 50 Pieces		28051J	
Clamshell – 6 Pieces	18053	18051C	
Clamshell – 3 Pieces			18054

Tips & Tricks



Listen To Your Stripper

When stripping coax, do not turn your tool around as though it were a propeller.

RG59



Packaging Description	Gold Plated	Nickel Plated	Right Angle Nickel Plated
Bag – 25 Pieces	18055	18060	18060RA
Jar – 50 Pieces		28060J	
Clamshell – 6 Pieces	18056	18061	
Clamshell – 3 Pieces			18062



15020C
Pg 12

RGB 25 AWG



Packaging Description	Gold Plated	Nickel Plated
Bag – 25 Pieces	18285	18280

RGB 24 AWG



Packaging Description	Gold Plated	Nickel Plated
Bag – 25 Pieces	18265	18260

RGB 23 AWG



Packaging Description	Gold Plated	Nickel Plated
Bag – 25 Pieces	18275	18270

As you rotate your tool, listen to the cutting of the braid and when it stops talking to you, turn another 1/8 to a 1/4 turn, open tool and remove the stripper. When rotating, be sure the hand that is holding the cable is supporting the cable immediately next to the tool. Allow no cable play!

Coax Adapters

F Connector Coupler, High Performance F81 Clamshell – 2 pieces Bag – 25 pieces TAD001		BNC Inline Splice Female-to-Female Clamshell – 2 pieces Bag – 25 pieces 18308C 18308	
F Female-to-Female Coupler Clamshell – 2 pieces Bag – 25 pieces 18301C 18301		F Male Terminator 75 ohm Clamshell – 2 pieces Clamshell – 10 pieces Bag – 25 pieces 18306C 18309C 18309	
BNC Female-to-F Female Clamshell – 2 pieces Bag – 25 pieces 18303C 18303		BNC Male-to-F Female Clamshell – 2 pieces Bag – 25 pieces 18310C 18310	
BNC Female-to-F Male Clamshell – 2 pieces Bag – 25 pieces 18305C 18305		RCA Male-to-BNC Female Clamshell – 2 pieces Bag – 25 pieces 18314C 18314	
F Male-to-F Male Splice Clamshell – 2 pieces Bag – 25 pieces 18307C 18307			

Telecom Splicing Connectors. Utilize an insulation displacement contact (IDC) design for fast, simple, reliable terminations. No wire stripping is required and connectors will accept wire of different gauges. All connectors are gel filled to provide moisture resistance and inhibit corrosion. For use with solid copper conductors only. Typical uses include butt splicing 2 or 3 wires of the same or different gauges. Perfect for pigtail and load coil splice applications.

Technical / Features

Telecom Splicing Connectors UB-Gel Filled

- 26-22 AWG, in-line tap
- Tap directly on to existing wire without interrupting service
- Max insulation OD, .050" (1.27mm)

Telecom Splicing Connectors UR-Gel Filled

- 26-19 AWG, 2 or 3 wire splice
- Use for butt splicing 2 or 3 wires
- Wires can be of different wire gauges
- Max. insulation OD, .066" (1.67mm)

Telecom Splicing Connectors UY-Gel Filled

- 26-22 AWG, 2 wire splice
- Wires can be of different wire gauges
- Max. insulation OD, .060" (1.52mm)



Packaging Description	UB 26-22 AWG	UR 26-19 AWG	UY 26-22 AWG
Clamshell – 25 Pieces	18131	18111	18121
Clamshell – 50 Pieces		18112C	
Clamshell – 100 Pieces	18132C		18122C
Box – 100 Pieces*	18130	18110	18120
Jar – 200 Pieces		28110J	

* Bulk quantities available.
Contact us for pricing & delivery.

EZ Connectors... "The World's Easiest Twisted Pair Termination System"

The revolutionary design of the EZ Connectors transformed the way modular plugs are prepped and crimped. By allowing each individual conductor to completely pass through the connector and out of the front greatly simplifies terminations. Installers can easily see & verify the proper wiring order before crimping. The unique design also optimizes electrical performance by reducing the distance between the wire twists and contacts.

Whether terminating data or voice connections, the job is EZ using the EZ-RJ45® crimp tools – crimp and trim the wires in one easy cycle.

Technical / Features

- Through holes allow pairs to pass through the front of the connector for faster terminations
- EZ to verify wiring sequence
- More reliable and higher performance
- Works with solid or stranded wire – separate connectors are not required reducing inventory and preventing confusion
- Reduces scrap by eliminating wasted crimps
- Simple one-piece design – bars or liners are not required
- Use in Category 3, 5, 5e or 6 compliant voice and data networks
- FCC and RoHS compliant
- UL rated
- Manufactured in the USA
- Patented design

Terminating Connectors is as EZ as 1-2-3!

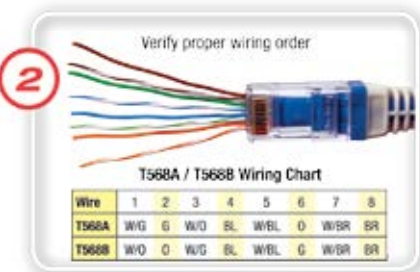
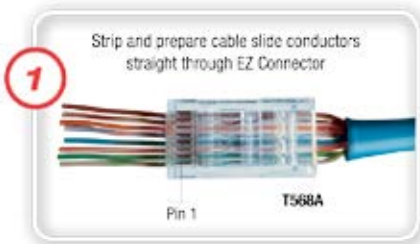

Made in the USA



Front end of EZ Connector

Through holes allow wire pairs to be inserted through front of connector for faster terminations.



EZ-RJ12/11™ Connectors

EZ-RJ12/11™ Standard Tab



Packaging Description

Clamshell – 50 Pieces	100026C
Box – 100 Pieces	100026B
Jar – 100 Pieces	202026J
Bag – 500 Pieces	105005

EZ-RJ12/11™ Long Tab



Packaging Description

Clamshell – 50 Pieces	100026LTC
Box – 100 Pieces	100026LTB
Bag – 500 Pieces	105005LT

EZ-RJ45® Connectors

EZ-RJ45® Cat5e



Packaging Description

Clamshell – 15 Pieces	100015
Clamshell – 50 Pieces	100003C
Box – 100 Pieces	100003B
Jar – 100 Pieces	202003J
Bag – 500 Pieces	105003

EZ-RJ45® Cat6



Packaging Description

Clamshell – 10 Pieces	100009C
Clamshell – 50 Pieces	100010C
Box – 100 Pieces	100010B
Jar – 100 Pieces	202010J
Bag – 500 Pieces	105004

EZ-RJ45® Shielded Cat5e/6 Connector with Internal or External Ground

Combines the performance advantage exclusive to the EZ-RJ45® design with the performance advantage inherent to shielded products to provide an unparalleled solution for the market. In applications where NEXT, FEXT and AXT are an issue, using shielded products can be the solution. This connector is designed to work on both Cat5e and Cat6 cables, solid or stranded.

Made in the USA

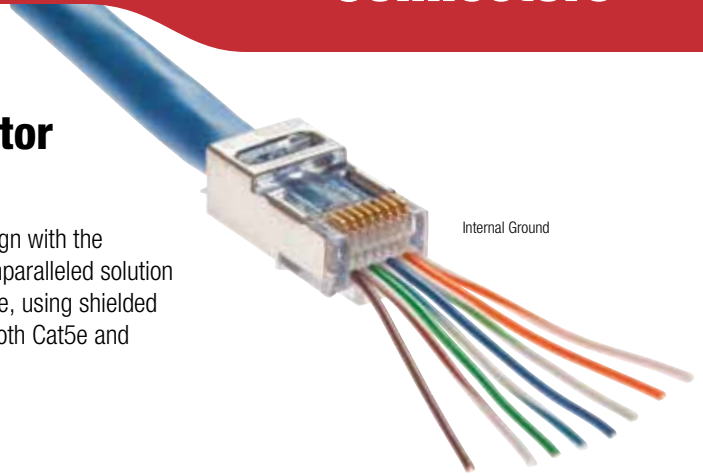

Internal Ground

Packaging Description	
Clamshell – 10 Pieces	100021C
Clamshell – 50 Pieces	100020C
Bag – 50 Pieces	100020
Jar – 50 Pieces	202020J
Bag – 100 Pieces	105020

Max cable OD: 0.260"
Max conductor OD: 0.041"

External Ground

Packaging Description	
Clamshell – 10 Pieces	100023C
Clamshell – 50 Pieces	100022C
Bag – 50 Pieces	100022
Jar – 50 Pieces	202022J
Bag – 100 Pieces	105022

Max cable OD: 0.280+"
Max conductor OD: 0.041"

Technical / Features

- FCC compliant
- UL & RoHS compliant
- 50 micro inch gold plate
- Patented



50/50 Combo Jars

100 Piece Jar of 50 EZ-RJ45® Connectors & 50 EZ Strain Reliefs



Made in the USA

Packaging Description	
Jar – EZ-RJ45® Cat5e 50/50 Combo	202015J
Jar – EZ-RJ45® Cat6 50/50 Combo	202016J



30/30 Cat6 Combo Pack

60 Piece Clamshell of 30 Cat6 EZ-RJ45® Connectors & 30 Color Coded Strain Reliefs

Packaging Description

Clamshell – EZ-RJ45® Cat6 30/30 Combo (10 each Red/Blue/Grey Strain Reliefs)	100011C
------------------------------------------------------------------------------	----------------

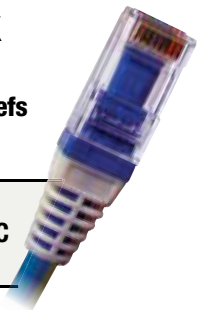

Snag Proof EZ Strain Reliefs. Designed specifically for crimping with the EZ-RJ45® Connectors, the primary strain relief of the plug, locks the snag proof strain relief in place, creating an integrated assembly; it will not pull off. Achieve the look of a commercially molded patch cord with a field termination and most importantly eliminate snags or hang ups. Patents pending.

Technical / Features

- Prolong patch cord life
- Maintain bend radiuses required for standards compliance
- Optimizes electrical performance
- No more snags or hang ups, causing tangled messes
- Easier to unlock the connector when unplugging from jack/port
- UL and RoHS compliant

Made in the USA

Clear



Packaging Description	Cat5e	Cat6
Jar – 100 Pieces	202035J	202036J
Clamshell – 50 Pieces	100035C	100036C
Bag – 50 Pieces	100035	100036
Bag – 500 Pieces	105015	105016

RJ45 Boots

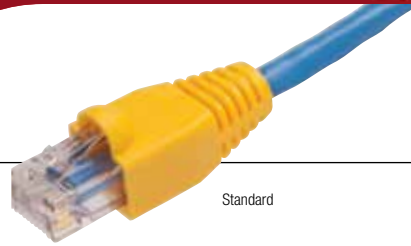

Standard

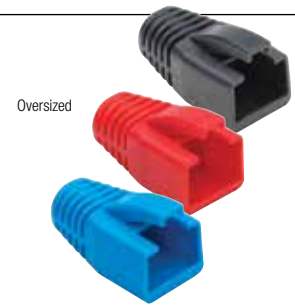

Oversized

Organize your cables and protect RJ45 plugs with snagless Cat5e and Cat6 boots.

Technical / Features

- Protect the connector
- Prevent tangled messes
- Eliminate broken release/locking tabs
- Relieve stress on cable
- Help maintain radius bend
- Color code designated
- Cover the external ground on shielded connectors
- Manufactured from ABS material

Color	Quantity	Standard Cable OD Ranges			
		5.5mm OD (0.217")	6mm OD (0.236")	6.5mm OD (0.260")	7mm OD (0.275")
Red	100/bag	105060	105071	105081	105091
	25/bag	100031R-BG	100032R-BG	100033R-BG	100034R-BG
Blue	100/bag	105061	105072	105082	105092
	25/bag	100031B-BG	100032B-BG	100033B-BG	100034B-BG
Black	100/bag	105062	105073	105083	105093
	25/bag	100031BK-BG	100032BK-BG	100033BK-BG	100034BK-BG
Grey	100/bag	105063	105074	105084	105094
	25/bag	100031GY-BG	100032GY-BG	100033GY-BG	100034GY-BG
Green	100/bag	105064	105075	105085	105095
	25/bag	100031GR-BG	100032GR-BG	100033GR-BG	100034GR-BG
Yellow	100/bag	105065	105076	105086	105096
	25/bag	100031Y-BG	100032Y-BG	100033Y-BG	100034Y-BG
White	100/bag	105066	105077	105087	105097
	25/bag	100031W-BG	100032W-BG	100033W-BG	100034W-BG
Purple	100/bag	105067	105078	105088	105098
	25/bag	100031P-BG	100032P-BG	100033P-BG	100034P-BG
Orange	100/bag	105068	105079	105089	105099
	25/bag	100031O-BG	100032O-BG	100033O-BG	100034O-BG

Oversized Cable OD Ranges		
7.5mm OD (0.295")	8mm OD (0.315")	8.5mm OD (0.344")
105102	105105	105108
100037R-BG	100038R-BG	100039R-BG
105100	105103	105106
100037B-BG	100038B-BG	100039B-BG
105101	105104	105107
100037BK-BG	100038BK-BG	100039BK-BG

Color Coded Strain Reliefs



Packaging Description	Red	Blue	Grey	Green	Yellow	Black
Clamshell – 50 Pieces	100030R-C	100030B-C	100030GY-C	100030GR-C	100030Y-C	100030BK-C
Bag – 500 Pieces	105006	105007	105008	105009	105010	105011

Compatible with all Standard Modular RJ45 Plugs (page 46) and EZ-RJ45® Cat6 Connectors (page 42).

NOTE: Not compatible with the EZ-RJ45® Cat5e Connectors.

EZ-DataLock™

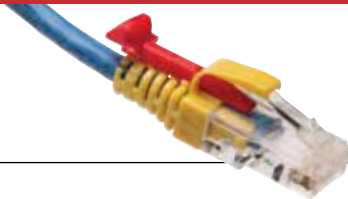

Protect and secure your data network 24/7. To be used as a locking strain relief for cables that are NOT to be disconnected! When locked, it will remain so until the 'Key-Holder' unlocks it. Also doubles as a snag-proof strain relief.

Technical / Features

- Patented 'OD-Flex' technology allows for a wide range of cable OD sizes:
 - Maximum cable OD: 6.8mm/0.268"
 - Minimum cable OD: 5.0mm/0.197"
- Materials: Polycarbonate
- UL, RoHS, CSA & CE compliant



NOTE: EZ-DataLock Strain Reliefs will work with standard shielded RJ45's or EZ-RJ45 Shielded Connectors with an internal ground. They are not compatible with shielded connectors that have an external ground tab.



EZ-DataLock Strain Relief Locking Sets – for EZ-RJ45 Cat5e Connectors ONLY:

Locking Set includes: 20 Strain Reliefs, 20 Locking Pins and 2 Keys

Part #	Description & Usage	Color
100041CL-C	EZ-DataLock Locking Set – 20/Clamshell	Clear
100041BK-C	EZ-DataLock Locking Set – 20/Clamshell	Black
100041R-C	EZ-DataLock Locking Set – 20/Clamshell	Red
100041Y-C	EZ-DataLock Locking Set – 20/Clamshell	Yellow
100041GR-C	EZ-DataLock Locking Set – 20/Clamshell	Green
100041B-C	EZ-DataLock Locking Set – 20/Clamshell	Blue
100041GY-C	EZ-DataLock Locking Set – 20/Clamshell	Grey
100041W-C	EZ-DataLock Locking Set – 20/Clamshell	White

EZ-DataLock Strain Relief – for EZ-RJ45 Cat5e Connectors ONLY:

Bulk/100 piece bags – **NOTE:** Locking Pins and Keys must be purchased separately. See below.

Part #	Description & Usage	Color
105030	EZ-DataLock Strain Relief – Bulk 100/Bag	Clear
105031	EZ-DataLock Strain Relief – Bulk 100/Bag	Black
105032	EZ-DataLock Strain Relief – Bulk 100/Bag	Red
105033	EZ-DataLock Strain Relief – Bulk 100/Bag	Yellow
105034	EZ-DataLock Strain Relief – Bulk 100/Bag	Green
105035	EZ-DataLock Strain Relief – Bulk 100/Bag	Blue
105036	EZ-DataLock Strain Relief – Bulk 100/Bag	Grey
105037	EZ-DataLock Strain Relief – Bulk 100/Bag	White

EZ-DataLock Strain Relief Locking Sets – for ALL Standard RJ45 Cat5e/6 and EZ-RJ45 Cat6 Connectors:

Locking Set includes: 20 Strain Reliefs, 20 Locking Pins and 2 Keys.

Part #	Description & Usage	Color
100042CL-C	EZ-DataLock Locking Set – 20/Clamshell	Clear
100042BK-C	EZ-DataLock Locking Set – 20/Clamshell	Black
100042R-C	EZ-DataLock Locking Set – 20/Clamshell	Red
100042Y-C	EZ-DataLock Locking Set – 20/Clamshell	Yellow
100042GR-C	EZ-DataLock Locking Set – 20/Clamshell	Green
100042B-C	EZ-DataLock Locking Set – 20/Clamshell	Blue
100042GY-C	EZ-DataLock Locking Set – 20/Clamshell	Grey
100042W-C	EZ-DataLock Locking Set – 20/Clamshell	White

EZ-DataLock Strain Relief – for ALL Standard RJ45 Cat5e/6 and EZ-RJ45 Cat6 Connectors:

Bulk/100 piece bags – **NOTE:** Locking Pins and Keys must be purchased separately. See below.

Part #	Description & Usage	Color
105041	EZ-DataLock Strain Relief – Bulk 100/Bag	Clear
105042	EZ-DataLock Strain Relief – Bulk 100/Bag	Black
105043	EZ-DataLock Strain Relief – Bulk 100/Bag	Red
105044	EZ-DataLock Strain Relief – Bulk 100/Bag	Yellow
105045	EZ-DataLock Strain Relief – Bulk 100/Bag	Green
105046	EZ-DataLock Strain Relief – Bulk 100/Bag	Blue
105047	EZ-DataLock Strain Relief – Bulk 100/Bag	Grey
105048	EZ-DataLock Strain Relief – Bulk 100/Bag	White

EZ-DataLock Locking Pins and Key:

Part #	Description & Usage
100043C	EZ-DataLock Locking Pins – 50/Clamshell
100045C	EZ-DataLock Key – 5/Clamshell
105049	EZ-DataLock Locking Pins – 50/Bag
105050	EZ-DataLock Key – 50/Bag

Locking Pin



Key

Standard Modular Plugs

Standard Modular Plugs.

Traditional crimp WE/SS-style modular plugs for use in terminating cables in both telephone and data applications.

Technical / Features

- Multiple position & contact configuration styles available
- Round & flat cable versions
- 2 prong stranded conductor contact
- 3 prong solid conductor contact
- Gold plated contacts provide reliable performance and long life
- Complies with FCC 68 guideline
- UL listed
- Flammability Rating: UL94V-2
- Materials: Polycarbonate
- Contact material: Phosphor bronze
- Plating: 50µ & 15µ gold



RJ11

RJ12

RJ45 - Standard

RJ11/12 – Round, Stranded



Packaging Description	RJ11 (6P4C)	RJ12 (6P6C)
Clamshell – 25 Piece	106117C	106132C
Jar – 100 Pieces	106118J	106133J
Bag – 500 Pieces	106115	106130

RJ11/12 – Round, Solid



Packaging Description	RJ11 (6P4C)	RJ12 (6P6C)
Clamshell – 25 Pieces	106122C	106137C
Jar – 100 Pieces	106123J	106138J
Bag – 500 Pieces	106120	106135

RJ22/11/12 – Flat, Stranded



Packaging Description	RJ22 (4P4C)	RJ11 (6P4C)	RJ12 (6P6C)
Clamshell – 25 Pieces	106102C	106112C	106127C
Jar – 100 Pieces	106103J	106113J	106128J
Bag – 500 Pieces	106100	106110	106125

Cat5e RJ45 – 8P8C



Packaging Description	Flat, Stranded 2 prong conductor contact	Round, Stranded 2 prong conductor contact	Round, Solid 3 prong conductor contact
Clamshell – 25 Pieces	106142C	106147C	106152C
Jar – 100 Pieces	106143J	106148J	106153J
Bag – 500 Pieces	106140	106145	106150

Cat5e RJ45 – 8P8C

Hi-Lo Stagger One Piece Design: 50µ



Packaging Description	Round, Stranded 2 prong conductor contact	Round, Solid 3 prong conductor contact	Round, Solid, Shielded 3 prong conductor contact
Clamshell – 25 Pieces	106162C	106167C	Bag – 100 106180
Jar – 100 Pieces	106163J	106168J	Clamshell – 50 106182C
Bag – 500 Pieces	106160	106165	Clamshell – 10 106183C

Standard Modular Plugs

Cat6 RJ45 – 8P8C

Non-Shielded

Two Piece Design: 50µ



Round, Solid, Non-Shielded

3 prong conductor contact, w/Liner

Round, Solid, Shielded

3 prong conductor contact, w/Liner

Shielded

RJ45 - High Performance

Packaging Description

Clamshell – 25 Pieces	106187C
Jar – 100 Pieces	106188J
Bag – 500 Pieces	106185

Clamshell – 10 Pieces	106208C
Clamshell – 50 Pieces	106207C
Jar – 100 Pieces	106206J
Tray – 100 Pieces	106205

Max cable OD: 0.285" or 7.24mm | Max conductor OD: 0.044" or 1.12mm | 23-24 AWG

Cat6 RJ45 – 8P8C

Three Piece Design: 50µ



Round, Stranded

2 prong conductor contact

Round, Solid

3 prong conductor contact

Packaging Description

Clamshell – 25 Pieces	106172C	106177C
Jar – 100 Pieces	106173J	106178J
Bag – 500 Pieces	106170	106175

Max cable OD: 0.270" or 6.85mm | Max conductor OD: 0.040" or 1.01mm | 24 AWG

RJ45 Cat6A 10-Gig Shielded Connectors with Liners

Platinum's 10-Gig System was developed to support today's 10-Gig infrastructure. In environments where speed transmission, uptime and response are critical, companies are using 10-Gig. It delivers the necessary bandwidth and also builds for future emerging technologies. Our system addresses the challenges of working with larger cables like Cat6E, Cat6A and Cat7. Our connectors deliver the performance needed to stream large data, audio and video files. Coupled with the Tele-TitanXg™ or the Tele-TitanXg™ 2.0, you can rest assured your installation exceeds industry standard performance.

Technical / Features

- Exceeds 10-Gig performance standard
- UL and RoHS compliant
- Max cable OD: 0.335"/8.5mm
- Max conductor OD: 0.053"/1.35mm

RJ45 Cat6A 10-Gig Connectors

Packaging Description

Clamshell – 10 Pieces	106193C
Clamshell – 50 Pieces	106192C
Bag – 25 Pieces	106191
Bag – 50 Pieces	106192
Bag – 100 Pieces	106190

Spare Liners

Bag – 50 Pieces	106194
-----------------	---------------

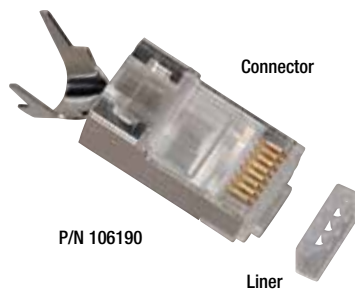

See pages 72-73 for 10Gig Termination Kit

Structured Wiring

Keystone Jacks and Couplers. Platinum Tools is known as a leader in providing products and solutions for the structured wiring networking world of data, voice and video. Keystone Jacks, Wall Plates and EZ-SnapJacks are the latest additions to our growing line of solutions.

Technical / Features

- Color coded to make EIA/TIA 568A/B wiring easy
- Contacts 50 micron gold
- Meets/Exceeds EIA/TIA Category Standards
- Compatible with industry standard wall plates
- RoHS Compliant and UL Listed

Cat3, Cat5e, Cat6
and Cat6A



726LA-50



726WH-50

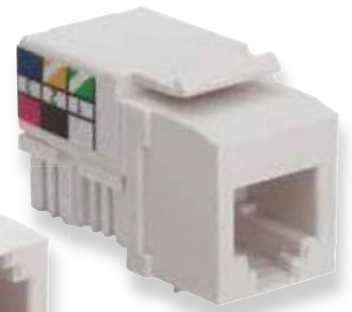

723WH-50

Keystone Jacks – Installer Packs of 50

Part #	Description
723LA-50	Keystone Cat3, 6 Pin, 110 Jack, Light Almond
723WH-50	Keystone Cat3, 6 Pin, 110 Jack, White
725BL-50	Keystone Cat5e, 110 Jack, Blue
725LA-50	Keystone Cat5e, 110 Jack, Light Almond
725WH-50	Keystone Cat5e, 110 Jack, White
726BL-50	Keystone Cat6, 110 Jack, Blue
726LA-50	Keystone Cat6, 110 Jack, Light Almond
726WH-50	Keystone Cat6, 110 Jack, White
780LA-50	Keystone F - 3GHz, Light Almond
780WH-50	Keystone F - 3GHz, White



725BL-50

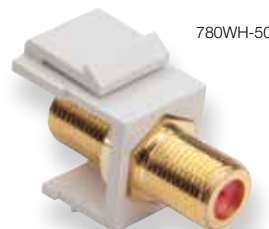

780WH-50

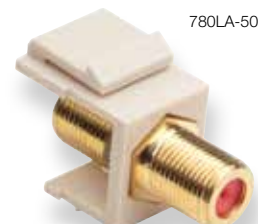

780LA-50

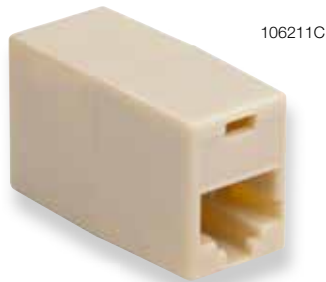

Keystone Coupler – Installer Bags (10 Pcs./Bag)

Part #	Description
765WH-10	Keystone Cat5e Data Coupler, White

In-Line Coupler – 2 Per Clamshell

Part #	Description
106211C	RJ45 In-Line Coupler, Light Almond

Keystone Blank Inserts – Installer Bags (10 Pcs./Bag)

Part #	Description
790LA-10	Keystone Blank Insert, Light Almond
790WH-10	Keystone Blank Insert, White

10 Gig Keystone Jacks – Shielded 1 Per Clamshell

Part #	Description
750-1C	Keystone Cat6A Tool-less, Shielded

Keystone HDMI – 1 Per Clamshell

Part #	Description
775WH-1C	HDMI to HDMI Pigtail, White



Wall Plates. A simple solution for connecting and managing your data, audio, video and telephone connectivity and networks. Compatible with most industry standard keystone jacks like Leviton, ICC and others.

Technical / Features

- Compatible with most industry standard keystone jacks and EZ-SnapJacks™
- Engineered to prevent possible fracturing from over tighten screws
- Drillable material
- UL & RoHS compliant
- One-piece, single-gang, 4 ½" X 2 ¾"
- Includes color matching mounting screws
- Designed to fit standard single-gang outlet boxes

Wall Plates – Installer Packs of 25

Part #	Description
600WH-25	Standard 1 Gang Blank, White
601LA-25	Standard 1 Port, Light Almond
601WH-25	Standard 1 Port, White
602LA-25	Standard 2 Port, Light Almond
602WH-25	Standard 2 Port, White
604LA-25	Standard 4 Port, Light Almond
604WH-25	Standard 4 Port, White



600WH-25



601WH-25



601LA-25



604WH-25



602WH-25



604LA-25

EZ-SnapJack™. You may never need a punchdown tool – at least for your wall jacks – again. The patented EZ-SnapJack™ is self-terminating and quickly installs for professional results in a snap. Available for both Cat5e and Cat6 cable types.

Technical / Features

- FCC, UL, ULC & RoHS compliant
- 50 micro-inch selective gold plating
- Molded from UL94-V0 material
- Meets/exceeds TIA/EIA-568B.2-1
- Save time – no need for eight punchdowns
- Repair damaged jacks on the spot
- Wire guide ensures pairs stay in proper order for fast, easy termination
- Designed to fit industry standard wallplates in seven colors
- Optimal for new or retrofits in commercial and home automation installations
- EZ-SnapJacks™ are re-useable
- Reduced tool cost, no PDT required

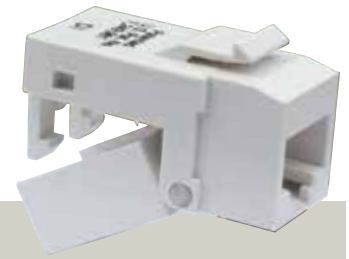

Prep cable

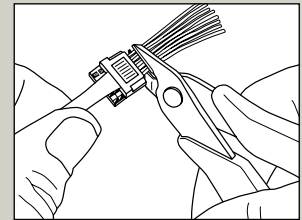
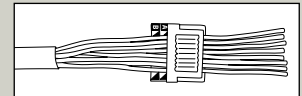

Insert wire guide

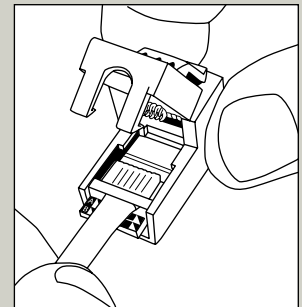

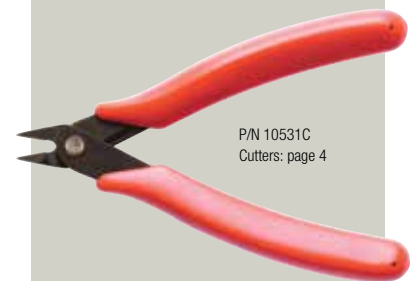
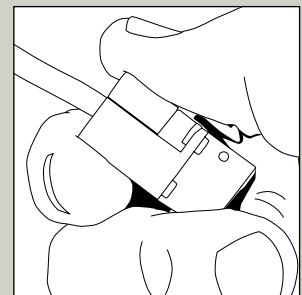

Snap together



P/N 10531C
Cutters: page 4

EZ-SnapJack™ – Cat5e

Color	Clamshell 4 Pcs	Bulk Bag 1 Pc./Bag	Installer Pack 40 Pieces	Jar 20 Pcs
White 	705WH-4C	705WH-1	705WH-40	705WH-20J
Light Almond 	705LA-4C	705LA-1	705LA-40	
Blue 	705BL-4C	705BL-1	705BL-40	705BL-20J
Ivory 	705IV-4C	705IV-1	705IV-40	
Black 	705BK-4C	705BK-1	705BK-40	
Yellow 	705YL-4C	705YL-1	705YL-40	
Orange 	705OR-4C	705OR-1	705OR-40	

EZ-SnapJack™ – Cat6

Clamshell 4 Pcs	Bulk Bag 1 Pc./Bag	Installer Pack 40 Pieces
706WH-4C	706WH-1	706WH-40
706LA-4C	706LA-1	706LA-40
706BL-4C	706BL-1	706BL-40
706IV-4C	706IV-1	706IV-40
706BK-4C	706BK-1	706BK-40
706YL-4C	706YL-1	706YL-40
706OR-4C	706OR-1	706OR-40

Patch Panels. An efficient and convenient solution to terminating all the cable runs coming in from various rooms to one main location commonly referred to as the server room or wiring closet.

Cat5e, Cat6 and Cat6A

Patch Panels – Cat5e, Cat6 and Cat6A

Part #	Description
650-12C5	12 Port Cat5e Non-Shielded
660-12C6	12 Port Cat6 Non-Shielded
667-12C6S	12 Port Cat6 Shielded
651-24C5	24 Port Cat5e Non-Shielded
661-24C6	24 Port Cat6 Non-Shielded
668-24C6S	24 Port Cat6 Shielded
675-24C6AS	24 Port Cat6A Shielded

Patch Panels are key to connecting and routing circuits in your network and beneficial to:

- Keeping your cables tidy
- Making it easier to identify your cables
- Keep your cables secure
- Easier to re-configure and troubleshoot your network

12 Port Cat6 Shielded Patch Panel

Wall Mount
P/N 667-12C6S

Technical / Features

- High strength frame for rigidity and durability. Eliminates flexing and warping
- Cable management bracket, helps support/eliminate cable disconnects (integrated)
- Removable shielded dust cover
- Locking screw terminals for cable support and security, eliminates disconnects
- Wall Mount
- Meets ANSI/EIA/TIA 568C.2 Standard
- Color coded label for easy wiring T568A & B
- 110/Krone punchdown compatible
- Solid or stranded 22 thru 26 AWG wire
- Ideal for voice, data, video and audio applications
- Gold plated RJ45 port contacts



See page 44 for RJ45 Boots



12 Port Cat5e Non-Shielded Patch Panel

Wall Mount, Vertical Design
P/N 650-12C5



12 Port Cat6 Non-Shielded Patch Panel

Wall Mount, Vertical Design
P/N 660-12C6



Technical / Features

12 Port Cat5e and Cat6 Non-Shielded

- Wall Mount / Vertical Design
- 110/Krone punchdown compatible
- Meets ANSI/EIA/TIA 568C.2 Standard
- Color coded label for easy wiring T568A & B
- Solid or stranded 22 thru 26 AWG wire
- ABS Plastic Housing
- Gold plated RJ45 port contacts
- Ideal for voice, data, video and audio applications

24 Port Cat5e Non-Shielded Patch Panel

1U Spacing
P/N 651-24C5



Front



Back

24 Port Cat6 Non-Shielded Patch Panel

1U Spacing
P/N 661-24C6



Front



Back

Technical / Features

24 Port Cat5e and Cat6 Non-Shielded Patch Panels

- 1U Spacing, traditional 19-inch rack design
- Cable management bracket, helps support/eliminate cable disconnects (removable)
- High strength frame for rigidity and durability. Eliminates flexing and warping
- Color coded label for easy wiring T568A & B
- Meets ANSI/EIA/TIA 568C.2 Standard
- 110/Krone punchdown compatible
- Solid or stranded 22 thru 26 AWG wire
- Ideal for voice, data, video and audio applications
- Gold plated RJ45 port contacts

24 Port Cat6 Shielded Patch Panel

1U Spacing
P/N 668-24C6S

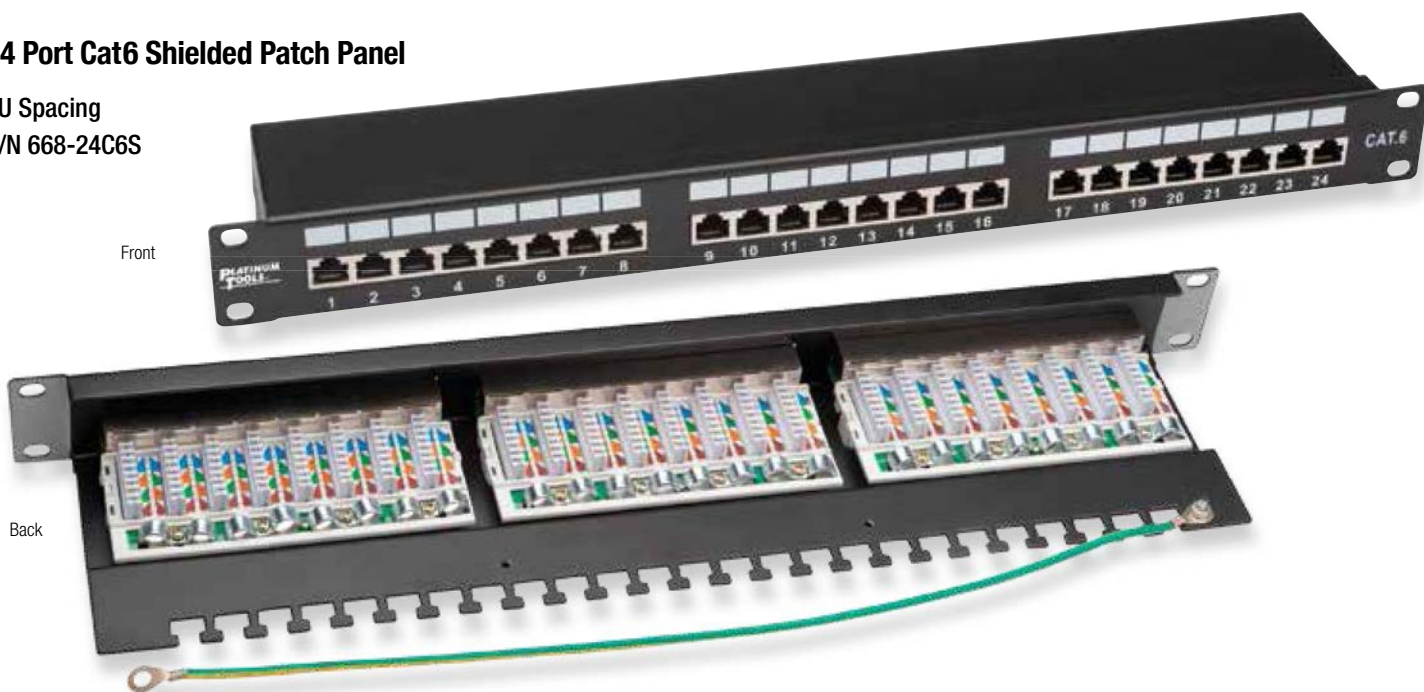

24 Port Cat6A Shielded Patch Panel

1U Spacing
P/N 675-24C6AS

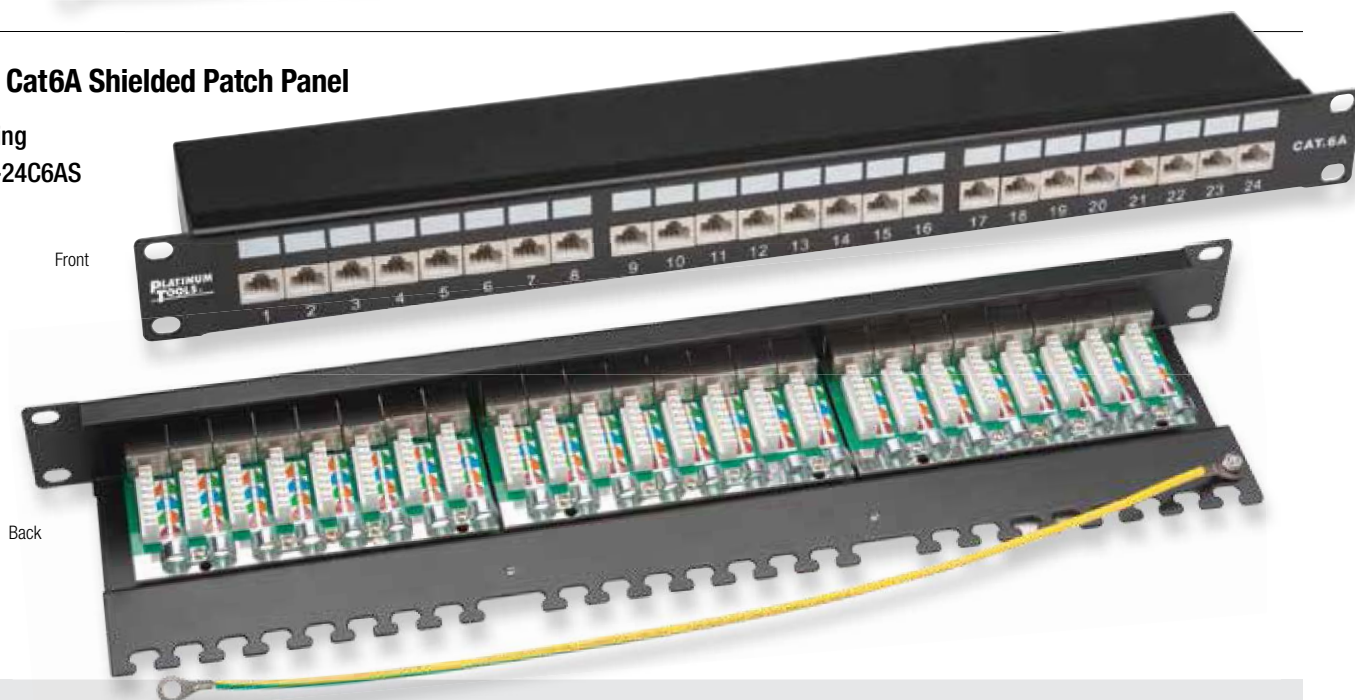

Technical / Features

24 Port Cat6 and Cat6A Shielded Patch Panels

- 1U Spacing, traditional 19-inch rack design
- High strength frame for rigidity and durability. Eliminates flexing and warping
- Cable management bracket, helps support/eliminate cable disconnects (integrated)
- Removable shielded dust cover
- Locking screw terminals for cable support and security, eliminates disconnects
- Meets ANSI/EIA/TIA 568C.2 Standard
- Color coded label for easy wiring T568A & B
- 110/Krone punchdown compatible
- Solid or stranded 22 thru 26 AWG wire
- Ideal for voice, data, video and audio applications
- Gold plated RJ45 port contacts

Cable Management

CCP - Cable Cage Polypropylene J-Hooks



	Cable Capacity		Standard CCP	90° CCP	Batwing CCP
	Cat5e	Cat6			
1" Size 16	30	15	CCP16-100 100 / Box	CCP16AC-100 100 / Box	CCP16W-100 100 / Box
2" Size 32	80	50	CCP32-100 100 / Box	CCP32AC-100 100 / Box	CCP32W-100 100 / Box
3" Size 48	160	100	CCP48-25 25 / Box	CCP48AC-25 25 / Box	CCP48W-25 25 / Box

CCP - Cable Cage Polypropylene J-Hooks

Technical / Features

- Steel J-Hooks over-molded with polypropylene for ultra smooth cable glide and locking cable cage
- Molded in hook for fast lock & latch
- EZ open & close
- Super smooth edges eliminate cable snags
- Use for Telecom, Data, Broadband, Satellite, CCTV and Fiber installations
- Perfect for flexible conduit in residential and commercial applications
- Material: Galvanized Steel
- Finish: Yellow Zinc Chromate
- Patent pending

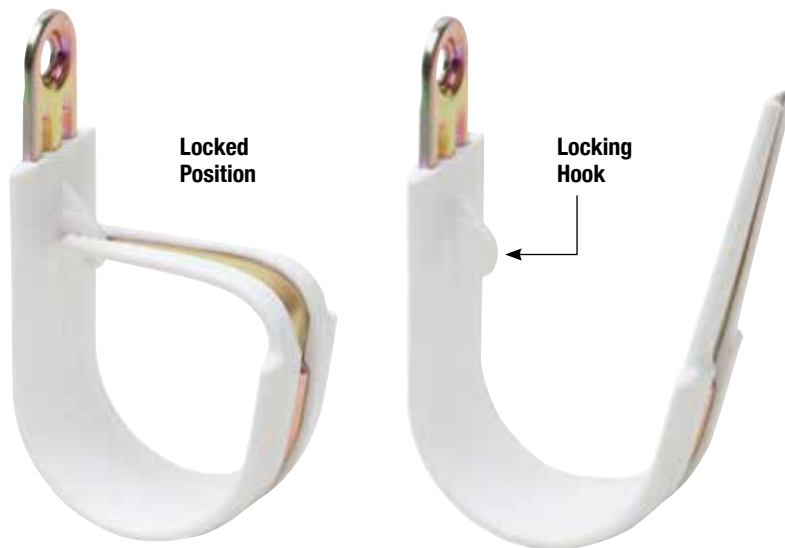

CCP16 J-Hook
with JH932-100
Angle Clip 90°
Hardware Accessory.

J-Hook Load Capacity

Size	Load (lbs.)	Size	Load (lbs.)
12 (3/4")	12	32 (2")	17
16 (1")	14	48 (3")	30
21 (1 5/16")	17	64 (4")	50

See Pages 58-59
for J-Hook Hardware Accessories.

Standard Multi-Purpose J-Hooks



	Cable Capacity		Standard	90° Standard	Batwing Standard
	Cat5e	Cat6			
3/4" Size 12	16	10	JH12-25 25/ Box	JH12AC-25 25/ Box	JH12W-25 25/ Box
3/4" Size 12	16	10	JH12-100 100 / Box	JH12AC-100 100 / Box	JH12W-100 100 / Box
1 5/16" Size 21	50	32	JH21-25 25/ Box	JH21AC-25 25/ Box	JH21W-25 25/ Box
1 5/16" Size 21	50	32	JH21-100 100 / Box	JH21AC-100 100 / Box	JH21W-100 100 / Box
2" Size 32	80	50	JH32-25 25/ Box	JH32AC-25 25/ Box	JH32W-25 25/ Box
2" Size 32	80	50	JH32-100 100 / Box	JH32AC-100 100 / Box	JH32W-100 100 / Box
4" Size 64	300	185	JH64-25 25 / Box	JH64AC-25 25 / Box	JH64W-25 25 / Box

Standard Multi-Purpose J-Hooks

Technical / Features

- Traditional style, construction grade
- Stress free cable support to organize and build a distribution pathway for various types of cables
- The perfect solution for heavy duty hanging applications
- Use above suspended ceilings, or below raised floors. Perfect for the garage and shop too
- Pre-assembled with rivet
- All steel construction
- UL and CUL listed
- Material: Galvanized Steel
- Finish: Yellow Zinc Chromate



	Cable Capacity		End Hook	Hammer-On	Beam Clamp
	Cat5e	Cat6			
3/4" Size 12	80	50			JH12BC-100 100 / Box, 3/4"
1 5/16" Size 12	80	50			JH21BC-100 100 / Box, 1 5/16"
2" Size 32	80	50	JH32EH-100 100 / Box, 1/4" x 20 Threads	JH32HOK24-100 100 / Box, for flanges 1/8" x 1/4"	JH32BC-100 100 / Box, 2"
2" Size 32	80	50		JH32HOK58-100 100 / Box, for flanges 5/16" x 1/2"	
4" Size 64	300	185		JH64HOK58-25 25 / Box, for flanges 5/16" x 1/2"	

J-Hook Hardware Accessories



A



B



C



D



E

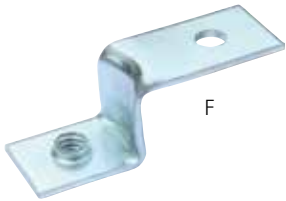

F



G



H

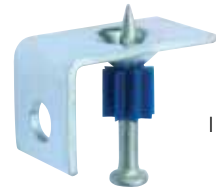

I



J



K



L



M



N



O



P



Q



R



S

	Part No.	Description	Qty
A	JH901-100	Vertical Overhang 180° with 1/4" Hole (C Purlin Applications)	100
B	JH902-100	Angled Overhang 45° with 1/4" Hole (Z Purlin Applications)	100
C	JH910-100	Hammer-On Beam Clamp 1/8 Thru 1/4" with 1/4" Hole	100
D	JH911-100	Hammer-On Beam Clamp 5/16 Thru 1/2" with 1/4" Hole	100
E	JH920-100	Angle Clip 90° - End Hook with 1/4-20 Thread & 1/4" Hole	100
F	JH921-100	Angle Clip Z - 1/4-20 Threaded Hole & 1/4" Hole	100
G	JH930-100	Angle Clip 90° - End Hook with 1/4-20 Thread & Powder Actuated Nail	100
H	JH931-50	Angle Clip Z - with Powder Actuated Nail and 1/4-20 Threaded Hole	50
I	JH932-100	Angle Clip 90° - Powder Actuated Nail with 1/4" Hole	100
J	JH940-100	Eye Lag Screw - 3" Overall Length, 3/16" Hole & 1 1/2" Thread Length (Wood Applications)	100
K	JH941-100	Eye Lag Screw - 2" Overall Length I-LAG™ Brand Eye Lag Screw, 3/16" Hole & 3/4" Thread Length (16-22 Gauge, Sheet Metal Applications) ICC ESR-3135	100
L	JH952-100	Threaded Rod, 3/8-16 Male Coupler with 2" Long Sharp Point Screw (Wood Applications)	100
M	JH953-100	Threaded Rod, 3/8-16 Male Coupler with 3/4" Long Self Drill Screw (16-22 Gauge, Sheet Metal Applications)	100
N	JH960-100	Multi-Function Clip - Batwing with 1/4-20 and 10-24 Impressions	100
O	JH965-50	Pressed Beam Clamp up to 1/2" Flanges, 1/4-20 Threaded Rod	50
P	JH966-100	Beam Clamp for 1/8" Thru 1/2" Flanges with 1/4-20 & 10-24 Impressions	100
Q	JH967-100	All Purpose Clip, Hammer-On 1/8" Thru 1/2" Flanges with 1/4-20 & 10-24 Impressions & accommodates Drive Rings	100
R	JH975	Installation Tool - Vertical (JH901-100) and Angled Overhang (JH902-100)	1
S	JH980	Installation Tool - Eye Lag Driver – Fits Into Any Drill, Hex 1/4" Hex	1

Bridle Rings

Support and secure your communication and other low voltage cables with these various sized Bridle Rings. Simple and effective. Constructed of solid low carbon steel. The perfect choice for cable management made easy!

Part #	Qty.	Description
JH802-100	100/box	10 x 24 - 3/4" ID
JH804-100	100/box	10 x 24 - 2" ID
JH807-100	100/box	1/4" x 20 - 1 1/4" ID
JH808-100	100/box	1/4" x 20 - 2" ID
JH809-50	50/box	1/4" x 20 - 4" ID

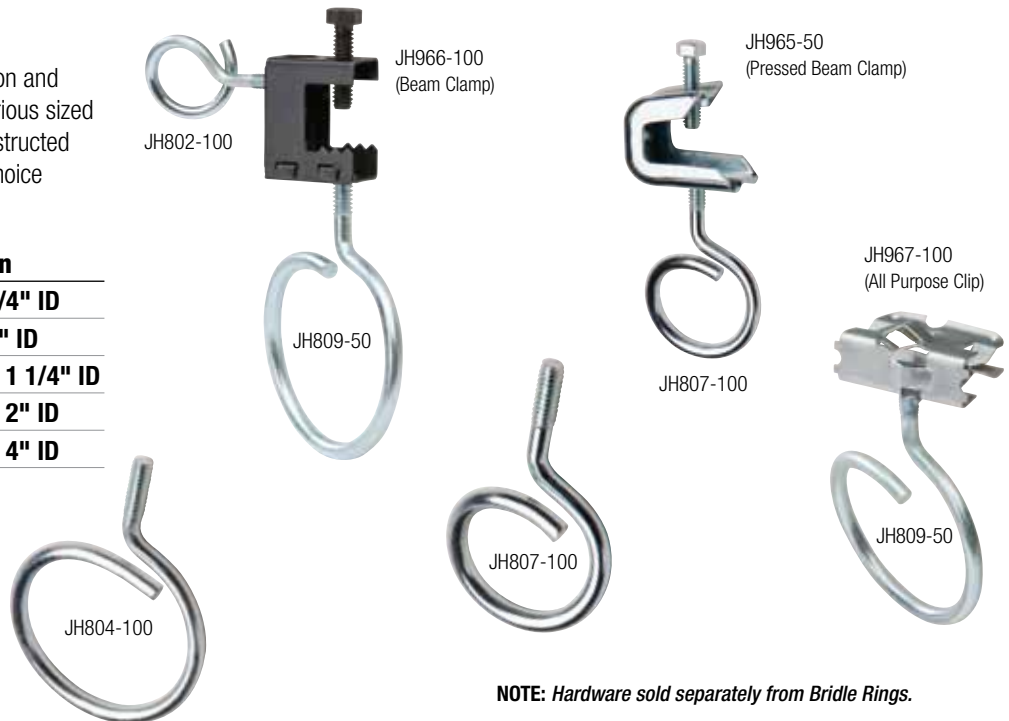

NOTE: Hardware sold separately from Bridle Rings.

Xtender Pole™ – Speeds installation. Improves safety. Saves money.

The professional cable installer's tool for easier overhead installations. A safer way to reach areas that previously were dangerous or inaccessible to ladders, scaffolding, and scissor lifts. Including vaulted ceilings, over stairwells, and through ceiling grid... **all from the work floor.**

Technical / Features

- Install hanging hardware from work floor, improves safety and efficiency
- Patented All-In-One Adapter System for threaded rod, eye lag screws, wire & jack chain
- Install multiple fastener types to a variety of ceiling structures — Elco®, Hanger Mate®, Buildex® Sammy Super Screws®, Powers Vertigo®
- Powered with any 3/8" or 1/2" drill
- Includes female hex adapter for 1/4" male driver and 5/8" hex adapter
- Video instructions for applications (Platinum Tools website)
- Tips & Instruction Booklet
- Xtender Pole™ -12 (three 4' sections, ceilings up to 18')
- Xtender Pole™ -18 (three 6' sections ceilings up to 24')

Part #	Description
JH712	Xtender Pole™ -12
JH718	Xtender Pole™ -18
JH701	Female Hex Adapter - 1/4" Male Driver
JH702	Hex Adapter, Open End 3/8"
JH703	Female Open End 5/8" Hex Adapter
JH705	1/2" NPT Adapter
JH707	Drill Driver Adapter
JH975	Installation Tool - Vertical & Angled Overhang

Xtender Pole Applications

Hang wire and chain.

Install as many as 100 ceiling wires per hour.

Drive screws.

The 1/4" hex adapter transforms the Xtender Pole™ into a very long screwdriver.

Hang threaded rod.

The socket adapters work with 3/8" or 1/4" threaded rod up to 10 feet long.

Assembled
in the USA
with Globally
Sourced
Components

1/2" Hex Adapter is built into the Xtender Pole Adapter Head to be used with Elco® HangerMate® screws to install threaded rod.

Xtender Pole™ – Accessories



Adapters included:

- A) Female Open End 5/8" Hex Adapter - JH703**
For installing ITW Buildex® Sammy Super Screws® and will work with Powers Vertigo®. For use with 1/4-20 and 3/8-16 threaded rod installation.
- B) Drill Driver Adapter - JH707**
- C) Female Hex Adapter - JH701**
Use with any 1/4" hex bit

Adapters & Accessories available:

- D) 1/2" NPT Adapter - JH705**
Use with Installation Tool, PN JH975 or any other tool requiring 1/2" NPT (National Pipe Thread).
- E) Installation Tool - JH975**
Use for vertical & angled overhang.
- F) Hex Adapter, Open End 3/8" - JH702**
Use to install threaded rod



BongoTies®

Handy ties for cables and other unruly items, BongoTies® have unlimited uses. Simple, durable and made of high-quality, heavy gauge natural rubber and bamboo. The patented design allows for quick, secure, button-type fastening. Wrap a BongoTie® around twice for small jobs or attach several ties together to secure large bundles.

Applications

- Cords and Cables
- Electronics and IT
- Hardware & Housewares
- Office & Industrial
- Outdoor Sports
- Travel

Part #	Description
19501	BongoTies® Bag – 10 pieces

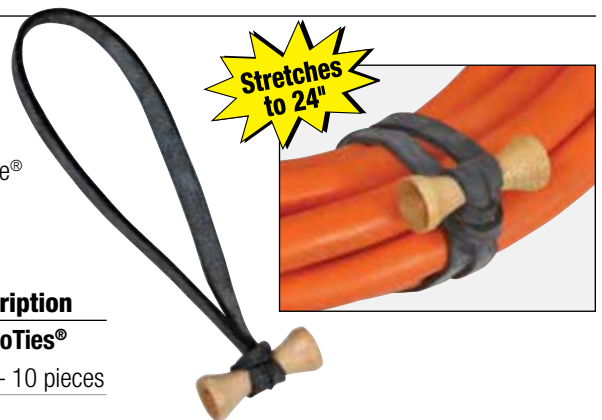

Testers

We're making testing **EZ!**

4MAPPER™ Tester. The fast and easy solution to troubleshoot and identify multiple coax cables. Also quickly identify and track up to 4 connections at a time from the main cable box. Easy to use, simply place colored remotes at the wall plate end and work the 4MAPPER at the cable box end.

Features

- EZ 1-button design
- Displays Pass, Open or Short
- Integrated tone generator
- Automatic power off
- Line voltage warning LED
- Flashing low battery LED
- Ultra bright, high intensity LED's,
- Includes 4 color coded, push-on design F Remotes
- When wire mapping, tester indicates what color remote is at the other end of the cable
- Small and compact, fits in the palm of the hand
- Long battery life
- Cable length for testing: 0 to 3,000 ft.

Assembled
in the USA
with Globally
Sourced
Components



T104C

Part #	Description
T104C	4MAPPER™ Tester w/4 custom F Remotes w/holster & 1 F (F to F) Adapter

4Mapper Accessories

T101C	F Remote Kit – Includes 4 custom F Remotes w/holster and 1 F (F to F) Adapter
T103C	BNC Adapter Kit – Includes 4 BNC (F) to F (F) Adapters w/holster and 1 BNC (F) to F (M) Adapter



T101C

**Tone it!
Track it!
Test it!**

CATV
Satellite
Security
AV Installations

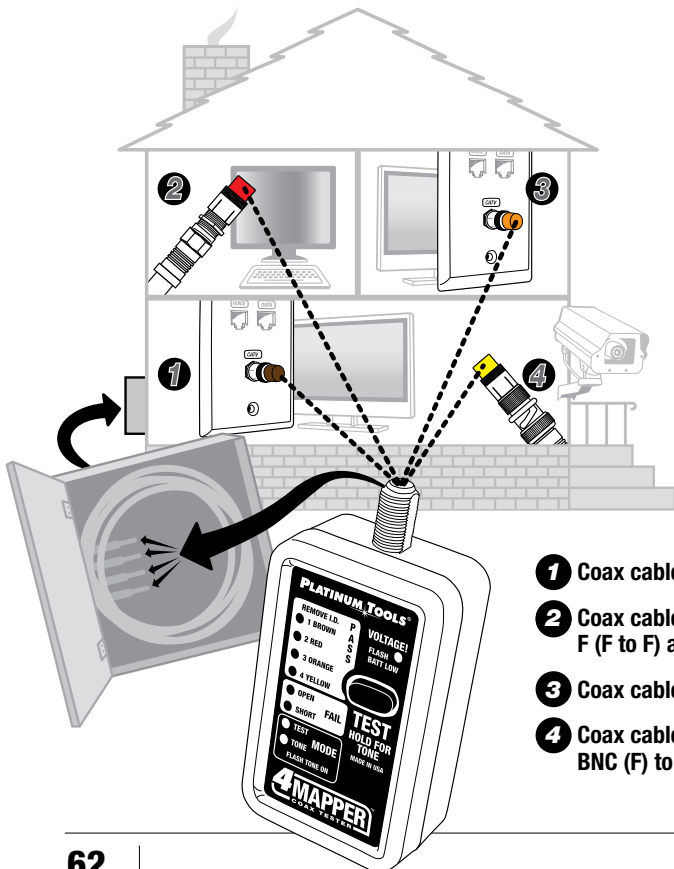

- 1 Coax cable to wall plate
- 2 Coax cable with F (F to F) adapter
- 3 Coax cable to wall plate
- 4 Coax cable with BNC & BNC (F) to F (F) adapter

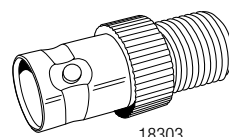

18303

BNC (F) to F (F) Adapter

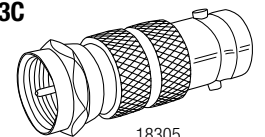

18305

BNC (F) to F (M) Adapter

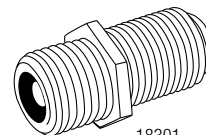

18301

F (F to F) Adapter

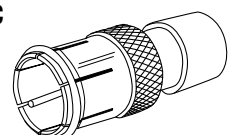

F Remote Push-On

Tone and Probe Set. With its steady tone, push-to-scan button and a clear loudspeaker, quickly trace and identify cable locations on jacks or through walls. Wire bundles are easily penetrated with the tapered probe tip and the probe volume is controlled with a thumbwheel. With common send and receive frequencies, the TP150 is versatile enough to be used with other tone generators or probes.



Scan for more information

Probe Features

- Recessed push-button activates tone scanning when needed
- Tapered tip allows easy penetration of cable bundles
- Side thumb wheel adjusts volume and turns off power to reserve battery power
- Probe Sensitivity: 100Hz~300KHz

Tone Generator Features

- Slide switch to select TONE/OFF/CONT
- Continuity mode to verify if a wire is broken
- Alligator clips to test pairs and an RJ11 connector for phone lines
- Tone Generator Output: 1.5KHz square waveform

Part #	Description
TP150	Tone and Probe Set – Includes Carrying Case, 9V Batteries & User Instructions



Designed specifically for easy cable tracing and identification.

Alligator clips to test pairs

VDV MapMaster™ Tester. Combines continuity testing, mapping and tone generator functions into a single unit. Capable of identifying and mapping 19 voice, data and video locations at one time. Whether your jobs are commercial or residential, the versatility of the VDV MapMaster™ makes it an installer's best friend!

Features

- Tests Voice (6 wires), Data (8 wires) and Video (coax) including:
 - Cat6, Cat5e, Cat5, Cat4, Cat3 and Coax Cables
 - Tests shielded and unshielded cables
- Tone generator features selectable tone cadence and selectable pins carrying tone
- Tests and indicates pins with shorts, opens, reversals, miswires and split pairs
- Easy to read, extra-large 7-segment LCD screen with large icons
- Cable test results displayed in wire map format with connector pin numbers
- Display reads "Pass" for correctly wired T568A/B 8 & 6 pin and crossover/uplink
- LOOP ON function sets up a continuous test mode, useful for trouble shooting intermittent problems
- RJ (Voice & Data) Master Remote stores in bottom of case
- Mapping - video and data cables can be connected to their respective remotes at the same time to improve testing efficiency of 'tech' cable (both data & coax cables in one jacket)
- Mapping - optional data and video, custom ID Remote Sets (#1 thru #19) for locating cable runs to wall outlets are available (see accessories, Pg. 66)
- Patch Cables may be tested without removing the Master Remote from storage
- Low power consumption for long battery life
- Auto Power-Off
- Voltage detection warning icon
- Low battery indicator

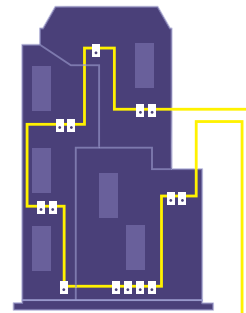

MAP networks the EZ way!



VDV MapMaster™
Voice, Data and Video Tester

Technical

- RJ Cable Length: 1000'
- Minimum cable length for split pairs detection: 1.5 feet
- Maximum coax cable length: Cable resistance varies
- Size: 6.4 x 2.8 x 1.4 inches
- Weight: 9.0 oz. (Including battery and remote)
- Operating Temperature: 32° to 122° F
- Storage Temperature: -4° to 140° F
- Humidity: 10% to 90% non-condensing
- Battery Life Active: 425 hours (9V alkaline)

See page 66 for the VDV MapMaster Accessories

Part #	Description
T119C	VDV MapMaster™ Tester

- Includes:**
- RJ45 #1 Remote**
- Coax F #1 Remote**
- F (F-to-F) Adapter**
- 9V Battery**
- Instruction Sheet**

MapMaster™ Ports



Assembled in the USA with Globally Sourced Components

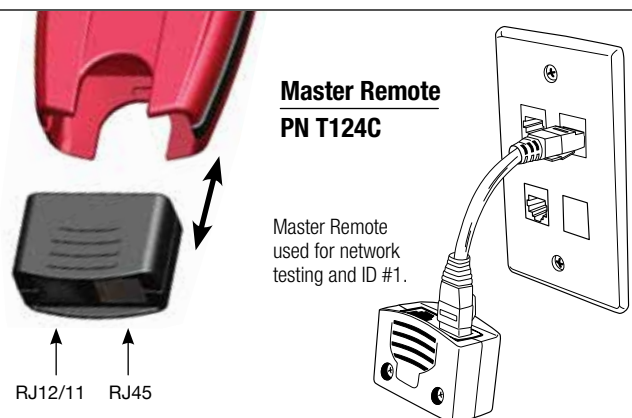

Master Remote PN T124C

Master Remote used for network testing and ID #1.

VDV MapMaster™ 2.0 Tester. Combines continuity testing, mapping, tone generator and length measurement functions in a single tester. Capable of identifying and mapping 19 locations at one time. Whether your jobs are commercial or residential, the versatility & added features of the VDV MapMaster™ 2.0 makes it an installer's best friend!



- Test ✓
- Map ✓
- Measure ✓
- Tone ✓



Features

- Measures length of entire cable and individual wire pairs
- Measures distance to an open
- Tests and indicates pins with shorts, opens, reversals, miswires and split pairs
- Tests Voice (6 wire), Data (8 wire) and Video (coax)
- Easy to read, extra large 7-segment LCD screen with large icons
- Displays 'Pass' icon for correctly wired T568A/B and crossover/uplink
- Tone generator with selectable tone cadence and selectable pins carrying tone
- Displays 'Pass' icon for correctly wired 6-pin telephone plus 'Rev' for reverse-pinned
- Map 19 locations at one time
- RJ (Voice & Data) Master Remote stores in bottom of case
- Low power consumption for long battery life
- Auto Power-off

Assembled in the USA with Globally Sourced Components

Technical

- RJ Cable Length: 1000'
- Minimum cable length for split pairs detection: 1.5 feet
- Maximum coax cable length: Cable resistance varies
- Size: 6.4 x 2.8 x 1.4 inches
- Weight: 9.0 oz. (Including battery and remote)
- Operating Temperature: 32° to 122° F
- Storage Temperature: -4° to 140° F
- Humidity: 10% to 90% non-condensing
- Battery Life Active: 425 hours (9V alkaline)

Part #	Description
T129	VDV MapMaster™ 2.0 Tester

Includes:

RJ45 #1 ID/Map Remote
Coax F #1 Remote
RJ45 to Alligator 12" Cable
F Female to Female Adapter
9V Battery
Instruction Sheet

See page 66 for the VDV MapMaster 2.0 Accessories.

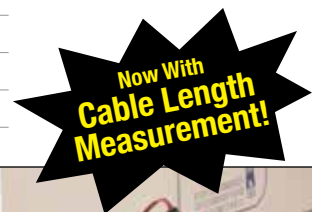

Cable Length Measurement:

Length Mode (LM) is used to measure the length of entire cables and its pin pairs. LM also allows you to view and adjust the length constant value for video, data, and voice cables.



See the Kit section, page 81 for additional information on the VDV MapMaster™ 2.0 Test Kit, PN T129K1

Tester Accessories:



T120C

Coax Remote Set, Push-On F Type, 19 pc T120C - Test and ID/MAP 19 video (coax) cables at one time. Numbered custom F remotes #1 thru #19 for easy identification.



T127C

Coax Remote Set, Push-On F Type, 8 pc T127C - Test and ID/MAP 8 video (coax) cables at once. Numbered custom F remotes #1 thru #8 for easy identification.



T121C

Data Remote Set, RJ45, 19 pc T121C - ID/MAP 19 data (twisted pair) cables or data ports/jacks at one time. Numbered custom RJ45 remotes #1 thru #19 for easy identification. For mapping only!



T128C

Data Remote Set, RJ45, 12 pc T128C - ID/MAP 12 data (twisted pair) cables or data ports/jacks at once. Numbered custom RJ45 remotes 1 thru 12 for easy identification. For mapping only!



Master Remote T124C
Replacement Master Remote for VDV MapMaster, PN T119C, and VDV MapMaster 2.0, PN T129.



RJ45 to Alligator 12" Cable T125C
Use when shooting tone via the data port. Cable conductors are terminated on contact #1 and #2, so program your VDV MapMaster to shoot tone on pair 1 and 2.



No-Fault Cable T126C
7.5" Special RJ12 to RJ12 The No-Fault Cable uses no-fault RJ12 connectors on both ends to assure no damage to the RJ45 jacks. It is the ideal patch cable to use when mapping or shooting tone.



RJ45 Port Saver 21025C
Extend the life of your tester by using the RJ45 Port Saver as your sacrificial cable. This eliminates the wear and tear from constantly plugging in and out of the tester port.



Hanging Pouch 4007
Durable pouch for safe storage & transport of your tester.



12" Screw-On F Jack-to-Push-On Plug Cable Assembly TCA004



Micro USB Cable TCA007
Connects Coax Clarifier to computers to export test results.

Smart Remote Kit. Maximize efficiency and save time, by eliminating the need to walk back & forth to test sites. Combine this kit with your VDV MapMaster 2.0 (PN T129), Cable Prowler (PN TCB300) or Net Prowler (PN TNP700) to both 'Test' & 'Map/ID' up to eight drops/locations simultaneously. Smart Remotes are a 'smarter' way to go!

Features

- Test & Map/ID voice/data simultaneously
- Cat6, Cat5e, Cat5, Cat4 and Cat3 cables
- Shielded and unshielded cables
- Remotes #2-8 work on UTP/STP cables
- Snap-lock clear case protects and alerts you if a remote is missing

Part #	Description
T139	Smart Remote Kit

Combine the Smart Remote Kit with these testers
 See Page 65 for VDV MapMaster 2.0, PN T129
 See Page 67 for Cable Prowler, PN TCB300
 See Page 71 for Net Prowler, PN TNP700



NOTE: Smart Remotes do not work with the T119C VDV MapMaster. Patch cables not included.

Cable Prowler™ Tester. Provides full color cable testing and report management for Cat3, 5e, 6 & 6A, coax and telephone cable types. The Cable Prowler™ combines the functions of a high-end cable tester and length measurement tester, the capability to identify link status, link capability and PoE detection. All of this functionality is combined with internal memory to save, download and output results in full color.

Technical

- Displays length measurement for each pair in feet or meters using TDR technology
- Detects presence of PoE and class of PoE per IEEE 802.3af/at with load test for voltage drop
- Detects and reports current link speed and link capabilities for active Ethernet drops up to 1 Gbps
- Tests Ethernet cable configuration and verifies connectivity while conducting tests for opens, shorts, miswires, split pairs, and reverses
- Supports up to 8 Testing & ID Remotes for network & telephone cables
- Supports up to 20 network & coax ID/MAP – remotes
- View saved cable tests
- Full color graphical wire-mapping
- Ability to define cable name, save cable tests and print ALL results (cable testing & network testing)
- Multilingual (English, French, Spanish)

Applications

- Measure cable length and length to faults using TDR technology
- Network testing of link capability, link status, and link light
- Test PoE to ensure adequate power for powered devices such as VoIP phones
- Conduct single ended and remote cable tests with display of PASS, wire map, ID, and faults for network & coax cables
- Tone and trace cables
- Locate unlabeled network & coax cables with up to 20 remote identifiers
- Test multiple (up to 8) network & telephone drops with testing & identifier remotes
- Define a cable name for your cable test, save every cable test, export to your computer for record keeping and printing



See page 80 for information on the Cable Prowler PRO Test Kit.

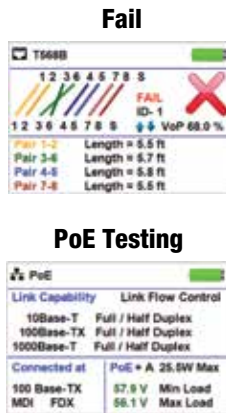

Assembled in the USA with Globally Sourced Components



See Page 41 for Coax Adapters

Part #	Description
TCB300	Cable Prowler™ Tester

Includes:

- Net Prowler™ Main Unit
- #1-5 Coax ID and Test Remote Set
- #1-5 Data ID-only Remote Set
- F Female to F Female Adapter F81
- Network/Tel Test and ID Smart Remote #1
- No-Fault Cables – Qty 2
- Micro USB Cable
- Hanging Pouch
- Quick Start Guide
- Alkaline AA Batteries

Coax Clarifier™ Tester.

Discern the layout of a dark coax network, locate faults on individual cable runs, identify remotes through splitters and determine cable run lengths. Separate wiremapping sets allows mapping the entire coax system and measure the quality and network characterization for carrying high grade video, surveillance data and HD programming.

Features

- Identifies cable faults
- Displays cable run quality
- Detects Coax RF Remotes through splitters
- Locates splitters in the system
- Tests and grades splitter performance
- Measures cable length up to 1,500 feet
- Wiremaps up to 12 coax locations



Assembled in the USA with Globally Sourced Components



TCC220 includes 4 remotes.
TCC200 includes 2 remotes.

Part #	Description
TCC200	Coax Clarifier™ with 2 Coax RF Remotes, TRK104, TCA004, 18303, 18304(3), 18301(3), 18309(4) and 4007
TCC220	Coax Clarifier™ with 4 Coax RF Remotes, TRK112, TCA004, 18303, 18304(5), 18301(3), 18309(4) and 4007

Coax Run Mapping

Maps runs through splitters to show an accurate picture of the coax system layout using up to 4 Coax RF Remotes. Up to 12 ID Only Coax Remotes are also available for wiremapping on home runs.

Cable Length

Determines cable run length and reports the location of an open or unterminated cable.

Quality of Network

Measures overall network quality and clearly depicts network reading as both a bar graph and a digital return loss number, measured in dB.

Tone Tracing

Traces coax runs with four unique tones to quickly distinguish between respective outlets.

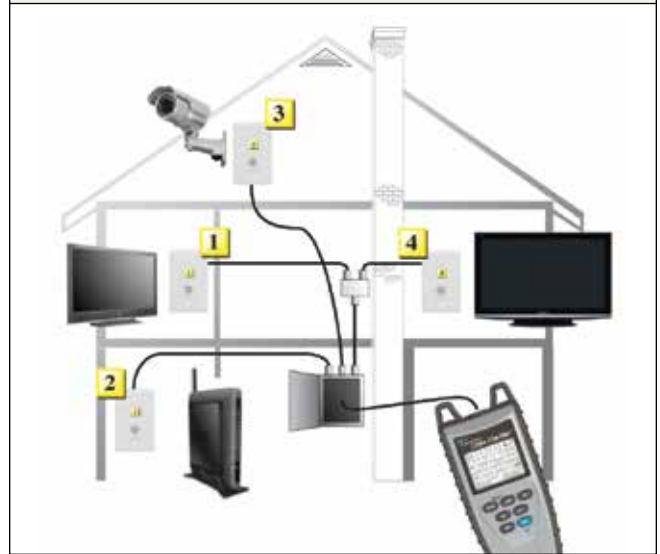

Accessories:

Part #	Description
TCA004	Cable Assembly, Screw-On F Jack to Push-On F Plug Cable - 12"
TCR001	Coax RF Remote # 1
TCR002	Coax RF Remote # 2
TCR003	Coax RF Remote # 3
TCR004	Coax RF Remote # 4
TRK104	# 1-4 ID Only Coax Remote Set in Foam Holder
TRK112	# 1-12 ID Only Coax Remote Set in Foam Holder
4007	Hanging Pouch
18303	Adapter, BNC Female to Female
18304	Adapter, F Jack to Push-On Plug
18301	F-Connector Coupler, F81
18309	F Male Terminator 75 ohm
	User Manual

RECON™ Test Set.

The RECON™ is the first true 21st century telecommunication line analyzer. It is a field instrument that delivers more information of online conditions & status than any other test set on the market.

- Advanced data detection & identification
- Large backlit display for low light environments
- Glow-in-the-dark keypad
- 100% Data Safe
- Rugged weatherproof case, IP54 Standard
- Drop-proof (drop tested at 20ft)

Part #	Description
T62	RECON™ Test Set
4007	Hanging Pouch
6070K1	Replacement Cord Set Kit

Features

- Multilingual (English, French, Spanish)
- Speaker with fine volume adjustment
- Adjustable earpiece volume, hearing aid compatible
- Noise cancelling microphone
- Microphone mute with toggle On/Off locking feature
- Soft key menu system
- Cushion boot for extra protection
- Backlight 0 to 100% adjustable with On/Off option
- Meets IP54 Water Resistance Standard

Functions

- Off-hook current and polarity
- On-hook voltage and polarity
- Ring amplitude and frequency
- On-hook and call waiting Caller ID info
- Amplified Line Monitor for volume levels comparable to “off-hook” operation
- 8 number stored memory with Alpha/Numeric Tags
- Fuel gauge battery condition
- Continuous polarity indication
- Caller ID/Call Waiting and Caller ID Error Detection
- Tone and Pulse dialing
- Configurable Auto Off in all modes
- Detects and identifies DSL and T1 lines
- Last number dialed, redialed or received

RECON™ Test Set

The 21st Century Butt Set

Includes:
Angled Bed-Of-Nails,
Piercing Clip,
No-Fault RJ12 Cord
Set with dust-cap
and User Manual



Largest Backlit LCD Display On The Market!

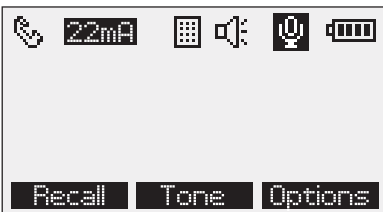

Actual Display Size



Digital Protection Features

- Data Defender™ Data line-in-use capability (Data Defender is a trademark of Independent Technologies®)
- High line voltage detection with next step options
- Data measurement options
- Active monitor circuitry minimizes load on subscriber line
- DTMF digit detection and display in monitor mode
- Detects DSL and T1 lines
- DigitView™, DTMF decode sees defects on customer equipment while dialing out
- PwrSave™ circuitry for extra long battery life

Snap Shot™ Tester.

Accurately finds cable length, impediments in the cable and conditions at the end of every wire in your data, power or communications/video system up to 3,000 ft. Advanced Spread Spectrum TDR technology (SSTDR) works in all wire environments and is immune to voltage, current, or data stream disruptions.

Features

- Works on energized cables
- Finds cable length or distance to fault from one end
- Measures cable distance on spool
- Accuracy of 1% or better
- Calibrates NVP values
- Internal memory for storing up to two of your most used cable NVP values
- Large backlit LCD display
- Built-in tone generator for cable tracing & identification
- Loop test for continuous testing
- Displays length reading in feet or meters
- Auto-off to preserve battery life



TCA001 Cable Assembly, Insulated Push-On F to RJ45 Plug



TCA003 Cable Assembly, Insulated Push-On F to Alligator Clips



TCA002 Cable Assembly, Insulated BNC to Alligator Clips

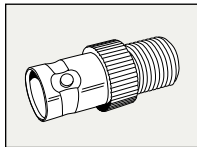

18303 BNC Female to F Female

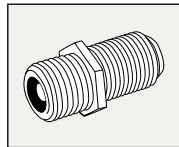

TAD001 F Connector Coupler, High Performance F81

Part #	Description
TSS200	Snap Shot™ Main Unit with TCA001, TCA002 TCA003, TAD001 and 18303

Includes:

Part #	Description
TCA001	Cable Assembly, Insulated Push-On F to RJ45 Plug
TCA002	Cable Assembly, Insulated BNC to Alligator Clips
TCA003	Cable Assembly, Insulated Push-On F to Alligator Clips
TAD001	F Connector Coupler, High Performance F81
18303	Adapter, F BNC Female to F Female
4007	Hanging Pouch
	User Manual

Memory

Holds up to two different NVP values for multiple cable tests.

Calibration

Ability to calibrate NVP for any cable.

Tests

Tests length, opens or shorts present on the cable, up to 3,000 ft.

Tone Generation

Produces four different tones for locating cables.

Fault Finding/Cable Length Measurement



Assembled in the USA with Globally Sourced Components

Net Prowler™ Tester. Combines network testing (physical layer and link), cable verification & troubleshooting and PoE voltage testing in a handheld tester with a full-color display; all with the capability of saving and printing tests results from a personal computer.

Technical

Network Testing

- Ping both IPV4 and IPV6 Addresses
- Test TCP/UDP Throughput
- Detects and reports advertised link speed and link duplex capability
- Tests the presence of VLANs
- CDP/LLDP/NDP and VLAN identification provides network configuration information
- Ping specific URL to verify WAN connectivity
- Blinks link light to identify location on a hub/switch/router port
- Displays network devices & associated IP Addresses

Cable Verification & Troubleshooting

The Net Prowler™ provides full cable testing on any category network, coax, or telephone cable. It will display wire map, numbered ID remotes, and any faults, including shorts, opens, miswires, split pairs, and reverses. The full-featured Net Prowler™ measures cable length (using TDR technology) and generates tone levels for signal tracing and cable identification on all pairs, a selected pair or a selected pin.

PoE Voltage Testing

Net Prowler™ tests the presence of PoE on the network drop and what class of PoE per IEEE 802.3 af/at with load test for voltage drop. These network tests can also be saved for record keeping and printing.

Identify, Monitor & Test LAN Issues

Assembled in the USA with Globally Sourced Components

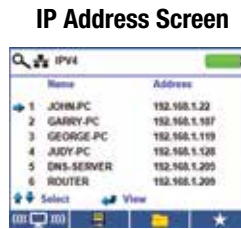

Net Prowler™ Tester comes with a handy hanging pouch for easy portability and organization. Included are the following accessories to help you get started:

Includes:

- Net Prowler™ Main Unit
- #1-5 Coax ID and Test Remote Set
- #1-5 Data ID only Remote Set
- F Female to F Female Adapter F81
- Network/Tel Test and ID Smart Remote #1
- No-Fault Cables – Qty 2
- Micro USB Cable
- Hanging Pouch
- Quick Start Guide
- Alkaline AA Batteries

See Pages 82-83 for the Net Prowler™ PRO Test Kit



Part #	Description
TNP700	Net Prowler™ Tester

Kits

10Gig Termination Kit. Streaming media demands robust, dependable networks, including 10-Gig Cat6A shielded cable, to provide the necessary expanded bandwidth. However, these larger, shielded cables require special connectors and tools.

Our 10-Gig shielded connector and Tele-TitanXg™ crimp tool are specifically designed to terminate Cat6A cables. A pairing that assures you will achieve 10-Gig performance... a true 10Gig Termination System.

90170 – 10Gig Termination Kit

Kit Contains:

Part #	Description
12515C	Tele-TitanXg™ Crimp Tool
15010C	Cyclops 2 Cable Jacket Stripper
12360C	CT-360 External Ground Crimp Tool
106190	RJ45 Cat6A/10-Gig Shielded Connector w/Liners (100 Pieces)
	User Manual

Application:

- Cat6E
- 10-Gig Cat6A
- Cat7
- Over-sized Cat5e/6 Industrial Ethernet Cables



Tele-TitanXg Crimp Tool

- Specifically made for terminating Platinum's RJ45 Cat6A 10-Gig Shielded Connectors (Not for standard RJ45 modular plugs)
- Straight action vertical crimp force
- Minimum hand force for a perfect crimp



Tele-TitanXg™



106190 (terminated)

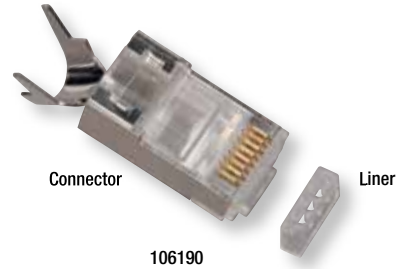
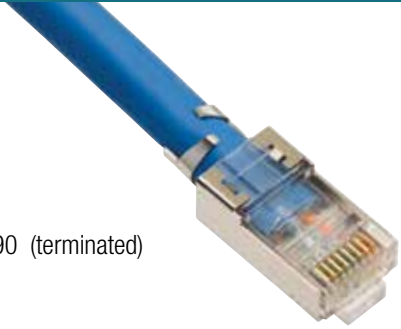

Connector

Liner

106190

RJ45 Cat6A 10-Gig Shielded Connector:

- Max cable OD: 8.5mm/0.335"
- Max conductor OD: 1.35mm/0.053"
- Meets 10-Gig performance standard
- UL and RoHS compliant



Cyclops® 2 Cable Jacket Stripper

- Self-adjusts to automatically score PVC and Plenum
- Ready-to-use out of the kit
- Works with shielded/unshielded twisted pair and fiber optic cables
- Accepts cable ODs 0.10" to 0.43" (2.5mm - 11mm)

CT-360 External Ground Crimp Tool

- 360° crimp on the external ground tab of shielded RJ45 connectors
- Perform concentric termination with full control to prevent over or under crimping
- Dual cavity covers wide range of cable ODs ranging from 0.245" to 0.335" (6.2mm - 8.5mm)
- Spring-loaded, non-ratcheted design
- Steel frame, black oxide finish, molded handles

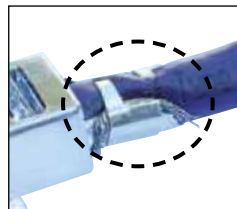

Crimped External Ground



15010C

90203 – Premier Data Connectivity Kit

Kit Contains:

Part #	Description
10500C	Coax & Round Wire Cable Cutter
15015C	Cat5e/6 Cable Jacket Stripper
12503C	All-In-One Modular Plug Crimp Tool (Ratcheted)
19001C	6-in-1 Screwdriver
106150	RJ45 (8P8C) Cat5e Modular Plug, 3-Prong, Solid Wire (25 Pieces)
4001NPT	Nylon Zippered Case
	Product Instructions



Premier Data Connectivity Kit. Platinum Tools' Premier Series Kits deliver a practical solution and offer the right mix of products that will withstand even the toughest jobs. The Premier Data Connectivity Kit provides the essential tools and connectors required for data network installations.



Twisted Pair Termination Kit. Featuring the patented EZ-RJ45® system, this kit includes all the tools required for data communications and telephone installations using twisted pair cable.



90122 – Twisted Pair Termination Kit

Kit Contains:

Part #	Description
10510C	BTP-6 Coax & Data Cable Cutter
15015C	Cat5e/6 Cable Jacket Stripper
100004C	EZ-RJ45® Crimp Tool
13100C	PRO Punchdown Tool
13002C	110 Punchdown Blade
105003	EZ-RJ45® Cat5e Connector (10 Pieces)
4001NPT	Nylon Zippered Case
	Product Instructions

EZ-RJ45® Convenience Packs. Assembled for the installer who needs the complete EZ-RJ45® system to add to his existing tool bag; packaged to fit your budget with your choice of the original EZ-RJ45® or the EZ-RJPRO™ HD Crimp Tool and EZ-RJ45® Cat5e Connectors. All kits include detailed instructions.



EZ-RJPRO™ HD Crimp Tool
100054C



EZ-RJ45® Crimp Tool
100004C



EZ-RJ45® Cat5e Connector
105003

Part #	Description	EZ-RJPRO™ HD Crimp Tool 100054C	EZ-RJ45® Crimp Tool 100004C	EZ-RJ45® Cat5e Connector 105003
100007	EZ-RJPRO™ HD Convenience Pack	■		50
100002	EZ-RJ45® Convenience Pack - 200		■	200
100005	EZ-RJ45® Convenience Pack - 50		■	50
100008*	EZ-RJ45® Combo - 24		■	24

* Packaged in clamshell.

EZ-RJPRO™ Termination Pod. Twisted pair made EZ. Professional, modular plug cable prep & termination kit for Category 3, 5, 5e or 6 compliant data networks.

90173 – EZ-RJPRO Termination Pod

Kit Contains:

Part #	Description
100054C	EZ-RJPRO™ HD Crimp Tool
15015C	Cat5e/6 Cable Jacket Stripper
10517C	Electrician's Scissors, 5"
105003	EZ-RJ45® Cat5e Connector (100 Pieces)
105004	EZ-RJ45® Cat6 Connector (100 Pieces)
105005	EZ-RJ12/11™ Connector (50 Pieces)
	Product Instructions

For Additional Information:

- **EZ-RJPRO™ HD Crimp Tool –**
Crimper section, page 14-15
- **Cat5e/6 Cable Jacket Stripper –**
Stripper section, page 11
- **Electrician's Scissors –**
Cutter section, page 2
- **EZ-Connectors –**
Connector section, pages 42-43



EZ-RJ45® Basic Installation Kit Bundles.

In addition to the EZ-RJ45® or EZ-RJPRO™ HD Crimp Tool and connectors, the Kit Bundles also include other cable preparation tools you will need to complete your job. All kits include detailed instructions.



100012 – EZ-RJ45® Basic Installation Kit Bundle





Kit Bundle Contains:

Part #	Description
10500C	Coax & Round Wire Cable Cutter
15015C	Cat5e/6 Cable Jacket Stripper
100004C	EZ-RJ45® Crimp Tool
105003	EZ-RJ45® Cat5e Connector (50 Pieces)

100016 – EZ-RJPRO® HD Basic Installation Kit Bundle

Kit Bundle Contains:

Part #	Description
10500C	Coax & Round Wire Cable Cutter
15015C	Cat5e/6 Cable Jacket Stripper
100054C	EZ-RJPRO™ HD Crimp Tool
105003	EZ-RJ45® Cat5e Connector (50 Pieces)

		
Cat5e/6 Cable Jacket Stripper 15015C Pg. 11	EZ-RJ45® Cat5e Connectors Pgs. 42-43	
		
EZ-RJPRO™ HD Crimp Tool 100054C - Pg. 14-15	EZ-RJ45® Crimp Tool 100004C - Pg. 15	Coax & Round Wire Cable Cutter 10500C - Pg. 4

EZ-RJ45® Termination Kit. This termination kit features the patented EZ-RJ45® Crimp Tool and Connectors coupled with snips and a nick-free UTP/STP stripper, for the simplest, fastest and highest performing installation of Cat5/5e/6 data networks.

90136 – EZ-RJ45® Termination Kit

Kit Contains:

Part #	Description
10525C	Professional Electrician's Scissors
15015C	Cat5e/6 Cable Jacket Stripper
100004C	EZ-RJ45® Crimp Tool
105003	EZ-RJ45® Cat5e Connector (10 Pieces)
4001NPT	Nylon Zippered Case
	Product Instructions



EZ-RJPRO™ HD Termination Kit. Designed for installers working with high-performance, larger OD cables. Includes the patented EZ-RJPRO™ HD Crimp Tool, EZ Connectors, and required tools to tackle those harder to terminate cables.



90151 – EZ-RJPRO® HD Termination Kit

Kit Contains:

Part #	Description
10525C	Professional Electrician's Scissors
15015C	Cat5e/6 Cable Jacket Stripper
100054C	EZ-RJPRO™ HD Crimp Tool
105003	EZ-RJ45® Cat5e Connector (10 Pieces)
4002PT	Nylon Zippered Case, w/Handles
	Product Instructions

PRO Punchdown Kit. Keeps your tools readily accessible and organized so you're always ready to perform those datacom jobs. This belt pouch kit will quickly become part of your daily gear.



90152C – PRO Punchdown Kit

Kit Contains:

Part #	Description
10525C	Professional Electrician's Scissors
13100C	PRO Punchdown Tool
13002C	110 Punchdown Blade
4015C	Punchdown Tool Pouch
	Black Fine Tip Sharpie® Pen
	Product Instructions

Basic Twisted Pair and Coax Kit. Featuring the patented EZ-RJ45® Crimp Tool and Connectors for simple, high performance Cat5/5e data networks. This kit provides the basic tools required for data, telephone and CATV structured wire installations.



90121 – Basic Twisted Pair and Coax Kit

Kit Contains:

Part #	Description
10500C	Coax & Round Wire Cable Cutter
15030C	Coax Cable Stripper, 2-Level RG58/59/62/6/6Q
15015C	Cat5e/6 Cable Jacket Stripper
100004C	EZ-RJ45® Crimp Tool
13100C	PRO Punchdown Tool
13002C	110 Punchdown Blade
11021	F Connector 8" Assembly/Removal Tool
105003	EZ-RJ45® Cat5e Connector (10 Pieces)
4001NPT	Nylon Zippered Case
	Product Instructions

PRO Twisted Pair and Coax Termination Kit.

Terminate RJ45 or RJ12/11 and F, BNC or RCA connectors with ease. This kit features the patented EZ-RJ45® Crimp Tool and SealSmart™ Compression Tool along with the other necessary tools to cut, strip and terminate twisted pair and coaxial cables.



90124 – PRO Twisted Pair and Coax Termination Kit

Kit Contains:

Part #	Description
10500C	Coax & Round Wire Cable Cutter
15030C	Coax Cable Stripper, 2-Level RG58/59/62/6/6Q
15015C	Cat5e/6 Cable Jacket Stripper
16201C	SealSmart™ Compression Crimp Tool
100004C	EZ-RJ45® Crimp Tool
13100C	PRO Punchdown Tool
13002C	110 Punchdown Blade
11021	F Connector 8" Assembly/Removal Tool
4001NPT	Nylon Zippered Case
	Product Instructions

Basic HD Twisted Pair and Coax Kit. Provides the basic tools required for data, telephone and coax structured wiring installations. Features the patented EZ-RJPRO™ HD Crimp Tool.



90150 – Basic HD Twisted Pair & Coax Kit

Kit Contains:

Part #	Description
10500C	Coax & Round Wire Cable Cutter
15030C	Coax Cable Stripper, 2-Level RG58/59/62/6/6Q
15015C	Cat5e/6 Cable Jacket Stripper
100054C	EZ-RJPRO™ HD Crimp Tool
13100C	PRO Punchdown Tool
13002C	110 Punchdown Blade
19001C	6-in-1 Screwdriver
105003	EZ-RJ45® Cat5e Connector (10 Pieces)
4002PT	Nylon Zippered Case, w/Handles
	Product Instructions

PRO HD Twisted Pair and Coaxial Kit.

Includes our most versatile and rugged wire and cable preparation tools so you can quickly and effortlessly tackle your data, voice and video projects on-time, and on budget.



90153 – PRO HD Twisted Pair and Coaxial Kit

Kit Contains:

Part #	Description
10500C	Coax & Round Wire Cable Cutter
15028C	ProStrip 25R Coax Stripper
15015C	Cat5e/6 Cable Jacket Stripper
16201C	SealSmart™ Compression Crimp Tool
100054C	EZ-RJPRO™ HD Crimp Tool
13100C	PRO Punchdown Tool
13002C	110 Punchdown Blade
11021	F Connector 8" Assembly/Removal Tool
4002PT	Nylon Zippered Case, w/Handles
	Product Instructions

90201 – Premier CATV Connectivity Kit

Kit Contains:

Part #	Description
10500C	Coax & Round Wire Cable Cutter
15020C	Double-Ended Coax Stripper – RG7/11/213 & RG59/6/6Q
16220C	SealSmart™ II Compression Crimp Tool
11021	F Connector 8" Assembly/Removal Tool
18006	SealSmart™ F Connectors for RG 6 Cable (10 Pieces)
4001NPT	Nylon Zippered Case
	Product Instructions

Premier CATV Connectivity Kit.

Platinum Tools' Premier Series Kits deliver a practical solution and offer the right mix of products that will withstand even the toughest jobs. The Premier CATV Connectivity Kit provides the essential tools and connectors required for CATV F cable runs.



Premier CCTV Connectivity Kit.

Platinum Tools' Premier Series Kits deliver a practical solution and offer the right mix of products that will withstand even the toughest jobs. The Premier CCTV Connectivity Kit includes rugged and easy to use tools carefully selected to make you more productive and ensure that terminations are done right, the first time.

90202 – Premier CCTV Connectivity Kit

Kit Contains:

Part #	Description
10500C	Coax & Round Wire Cable Cutter
15020C	Double-Ended Coax Stripper – RG7/11/213 & RG59/6/6Q
16220C	SealSmart™ II Compression Crimp Tool
19001C	6-in-1 Screwdriver
18041	SealSmart™ BNC Connectors for RG59 Cable (8 Pieces)
4001NPT	Nylon Zippered Case
	Product Instructions



SealSmart™ Field Installation Kits. If your job requires you to use compression F, RCA and BNC connectors in assorted cables sizes and you have been trying to figure out how to keep it all organized, the SealSmart™ Field Installation Kits provide the ultimate solution. Store your tools and connectors in a rugged, high impact plastic case with compartments to assist in identifying, sorting and re-stocking all components quickly and easily. Available with nickel or gold plated connectors.

90126 – SealSmart™ Field Installation Kit, Gold

Kit Contains:

Part #	Description	Qty
15030C	Coax Cable Stripper, 2-Level RG58/59/62/6/6Q	1
16201C	SealSmart™ Compression Crimp Tool	1
18004	SealSmart™ F Connectors for RG6 Quad Cable	20
18009	SealSmart™ F Connectors for RG6 Cable	20
18015	SealSmart™ F Connectors for RG59 Cable	20
18020	SealSmart™ BNC Connectors for RG6 Quad Cable	10
18025	SealSmart™ BNC Connectors for RG6 Cable	10
18030	SealSmart™ BNC Connectors for RG59 Cable	10
18057	SealSmart™ RCA Connectors for RG6 Quad Cable	10
18052	SealSmart™ RCA Connectors for RG6 Cable	10
18055	SealSmart™ RCA Connectors for RG59 Cable	10
4050	SealSmart™ Compartmented Plastic Case	1
	Laminated Instruction Sheet	1

90125 – SealSmart™ Field Installation Kit, Nickel

Kit Contains:

Part #	Description	Qty
15030C	Coax Cable Stripper, 2-Level RG58/59/62/6/6Q	1
16201C	SealSmart™ Compression Crimp Tool	1
18001	SealSmart™ F Connectors for RG6 Quad Cable	20
18006	SealSmart™ F Connectors for RG6 Cable	20
18011	SealSmart™ F Connectors for RG59 Cable	20
18035	SealSmart™ BNC Connectors for RG6 Quad Cable	10
18038	SealSmart™ BNC Connectors for RG6 Cable	10
18041	SealSmart™ BNC Connectors for RG59 Cable	10
18065	SealSmart™ RCA Connectors for RG6 Quad Cable	10
18051	SealSmart™ RCA Connectors for RG6 Cable	10
18060	SealSmart™ RCA Connectors for RG59 Cable	10
4050	SealSmart™ Compartmented Plastic Case	1
	Laminated Instruction Sheet	1



22-in-1 Security Screwdriver Kit.

The perfect set for security installers - reach into those deep crevices with ease and never be without the right screwdriver. It features a non-slip, comfort grip handle with a high impact plastic core and 11 double sided security shaft style bits. The shaft style bits enable access into recessed screws up to 5 inches deep. The bit load includes multiple sizes of Security Torx®, Hex and Robertson along with Spanners and Tri-Wings so the list of applications are endless. In addition to the security applications, this kit can be used on standard hex and torx screws and includes a slotted and Phillips head bit for traditional screwdriver applications.

19105 Bit Load:

- **Security Torx®:** T8, T10, T15, T20
- **Security Hex:** 1/8", 9/64", 5/32", 3/16"
2.5mm, 3mm, 4mm, 5.5mm
- **Spanner:** 4, 6, 8, 10
- **Security Robertson:** 1, 2
- **Tri-Wings:** 2, 3
- **Slotted:** 7/32" **Phillips:** #2

Part #	Description
19105	22-in-1 Security Screwdriver Kit



Cable Prowler™ PRO Test Kit. Provides full color cable testing and report management for Cat3/5e/6/6A, coax, and telephone cable types. The Cable Prowler™ combines the functions of a high-end cable tester and length measurement tester, the capability to identify link status, link capability, and PoE detection. All of this functionality is combined with internal memory to save, download and output results in full color.

Technical

- Displays length measurement for each pair in feet or meters using TDR technology
- Detects presence of PoE and class of PoE per IEEE 802.3af/at with load test for voltage drop
- Detects and reports current link speed and link capabilities for active Ethernet drops up to 1 Gbps
- Tests Ethernet cable configuration and verifies connectivity while conducting tests for opens, shorts, miswires, split pairs, and reverses
- Supports up to 8 Testing & ID Remotes for network & telephone cables
- Supports up to 20 network & coax ID/MAP remotes
- View saved cable tests
- Full color graphical wire-mapping
- Ability to define cable name, save cable tests and print ALL results (cable testing & network testing)
- Multilingual (English, French, Spanish)

Kit Includes:

- Cable Prowler™ Main Unit
- #1-8 Network/Tel Test and ID Remotes
- #1-8 ID and Test Push-On Coax Remote Set
- #1-12 UID/MAP only Data Remote Set
- Micro USB Cable
- No-Fault Cable - (Qty 2)
- RJ45 Port Saver
- RJ45 to Alligator 12" Cable
- F Female to F Female Adapters, (Qty 2)
- BNC Female to F Female Adapter
- BNC Female to F Male Adapter
- Durable Plastic Case
- Quick Start Guide
- Warranty Activation Card

Part #	Description
TCB360K1	Cable Prowler™ PRO Test Kit



Assembled in the USA with Globally Sourced Components

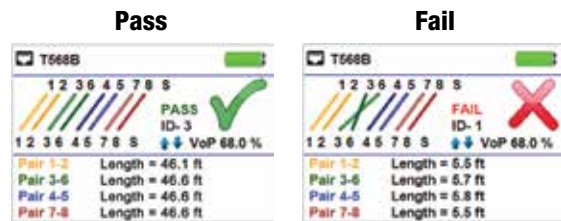

PoE Testing

PoE	
Link Capability	Link Flow Control
10Base-T	Full / Half Duplex
100Base-TX	Full / Half Duplex
1000Base-T	Full / Half Duplex
Connected at	PoE + A 25.6W Max
100 Base-TX	57.9 V Min Load
MDI FDX	56.1 V Max Load



VDV MapMaster™ 2.0 Test Kit.

The VDV MapMaster 2.0 combines continuity testing, mapping, tone generation and length measurement functions in a single tester. This kit includes the tester and all the accessories required for voice, data and video testing & mapping in the field. It's packaged in a rugged double-walled, blow-molded case with custom cut out, high density EVA foam to help protect your equipment for years to come.

Kit Includes:

- VDV MapMaster™ 2.0 Tester
- Durable Plastic Case
- #1-8 ID and Test Push-On Coax Remote Set
- #1-12 UID/MAP only Data Remote Set
- RJ45 Port Saver
- RJ45 to Alligator 12" Cable
- No-Fault Cable
- F Female to F Female Adapters, (Qty 3)
- BNC Female to F Female Adapter
- BNC Female to F Male Adapter
- 9V Battery
- Instruction Manual

Assembled in the USA with Globally Sourced Components



Part #	Description
T129K1	VDV MapMaster™ 2.0 Test Kit

See the Tester section, page 65 for additional information on the VDV MapMaster™ 2.0

Smart Remote Kit. Maximize efficiency and save time, by eliminating the need to walk back & forth to test sites. Combine this kit with your T129 VDV MapMaster 2.0 (PN T129), Cable Prowler (PN TCB300) or Net Prowler (PN TNP700) to both 'Test' & 'Map/ID' up to eight drops/locations simultaneously. Smart Remotes are a 'smarter' way to go!

Features

- Test & Map/ID voice/data simultaneously
- Cat6, Cat5e, Cat5, Cat4 and Cat3 cables
- Shielded and unshielded cables
- Remotes #2-8 works on UTP/STP cables
- Snap-lock clear case protects and alerts you if a remote is missing

Part #	Description
T139	Smart Remote Kit

Test Up To 8 Locations Simultaneously!



Combine the Smart Remote Kit with these testers
 See Page 65 for VDV MapMaster 2.0, PN T129
 See Page 67 for Cable Prowler, PN TCB300
 See Page 71 for Net Prowler, PN TNP700

NOTE: Smart Remotes do not work with the T119 VDV MapMaster. Patch Cables not included.

Net Prowler™ PRO Test Kit. Combines network testing (physical layer and link), cable verification & troubleshooting and PoE voltage testing in a handheld tester with a full-color display; all with the capability of saving and printing tests results from a personal computer.

Technical

Network Testing

- Ping both IPV4 and IPV6 Addresses
- Test TCP/UDP Throughput
- Detects and reports advertised link speed and link duplex capability
- Tests the presence of VLANs
- CDP/LLDP/NDP and VLAN identification provides network configuration information
- Ping specific URL to verify WAN connectivity
- Blinks link light to identify location on a hub/switch/router port
- Displays network devices & associated IP Addresses

Cable Verification & Troubleshooting

The Net Prowler™ provides full cable testing on any network, coax or telephone cable. It will display wire map, numbered ID remotes and any faults, including shorts, opens, miswires, split pairs and reverses. The full-featured Net Prowler™ measures cable length (using TDR technology) and generates tone levels for signal tracing and cable identification on all pairs, a selected pair or a selected pin.

PoE Voltage Testing

Net Prowler™ tests the presence of PoE on the network drop and what class of PoE per IEEE 802.3af/at with load test for voltage drop. These network tests can also be saved for record keeping and printing.

Kit Includes:

- Net Prowler™ Main Unit
- #1-8 Network/Tel Test and ID Smart Remotes
- #1-8 ID and Test Push-On Coax Remote Set
- #1-12 UID/MAP only Data Remote Set
- Micro USB Cable
- No-Fault Cable – (Qty 2)
- RJ45 Port Saver
- RJ45 to Alligator 12 Inch Cable
- F Female to F Female Adapter F81 – (Qty 2)
- BNC Female to F Female Adapter
- BNC Female to F Male Adapter
- Durable Plastic Case
- Quick Start Guide
- Warranty Activation Card

Identify, Monitor & Test LAN Issues



Assembled in the USA with Globally Sourced Components

Part #	Description
TNP850K1	Net Prowler™ PRO Test Kit



TCP/UDP Throughput Testing Screen



IP Address Screen



Ping Screen



Cable Verification Screen

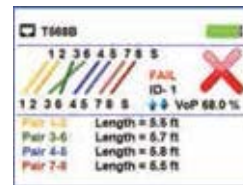

Link Settings & PoE Voltage Detection Screen



Part #	Description	Page
600WH-25	Standard 1 Gang Blank, White	50
601LA-25	Standard Wall Plate 1 Port, Light Almond (25)	50
601WH-25	Standard Wall Plate 1 Port, White (25)	50
602LA-25	Standard Wall Plate 2 Port, Light Almond (25)	50
602WH-25	Standard Wall Plate 2 Port, White (25)	50
604LA-25	Standard Wall Plate 4 Port, Light Almond (25)	50
604WH-25	Standard Wall Plate 4 Port, White (25)	50
650-12C5	12 Port Cat5e Non-Shielded Patch Panel	53
651-24C5	24 Port Cat5e Non-Shielded Patch Panel	54
660-12C6	12 Port Cat6 Non-Shielded Patch Panel	53
661-24C6	24 Port Cat6 Non-Shielded Patch Panel	54
667-12C6S	12 Port Cat6 Shielded Patch Panel	52
668-24C6S	24 Port Cat6 Shielded Patch Panel	55
675-24C6AS	24 Port Cat6A Shielded Patch Panel	55
705BK-1	EZ-SnapJack, Cat 5e, Black (Bulk)	51
705BK-40	EZ-SnapJack, Cat 5e, Black (40)	51
705BK-4C	EZ-SnapJack, Cat 5e, Black (4)	51
705BL-1	EZ-SnapJack, Cat 5e, Blue (Bulk)	51
705BL-20J	EZ-SnapJack, Cat 5e, Blue (20)	51
705BL-40	EZ-SnapJack, Cat 5e, Blue (40)	51
705BL-4C	EZ-SnapJack, Cat 5e, Blue (4)	51
705IV-1	EZ-SnapJack, Cat 5e, Ivory (Bulk)	51
705IV-40	EZ-SnapJack, Cat 5e, Ivory (40)	51
705IV-4C	EZ-SnapJack, Cat 5e, Ivory (4)	51
705LA-1	EZ-SnapJack, Cat 5e, Light Almond (Bulk)	51
705LA-40	EZ-SnapJack, Cat 5e, Light Almond (40)	51
705LA-4C	EZ-SnapJack, Cat 5e, Light Almond (4)	51
705OR-1	EZ-SnapJack, Cat 5e, Orange (Bulk)	51
705OR-40	EZ-SnapJack, Cat 5e, Orange (40)	51
705OR-4C	EZ-SnapJack, Cat 5e, Orange (4)	51
705WH-1	EZ-SnapJack, Cat 5e, White (Bulk)	51
705WH-20J	EZ-SnapJack, Cat 5e, White (20)	51
705WH-40	EZ-SnapJack, Cat 5e, White (40)	51
705WH-4C	EZ-SnapJack, Cat 5e, White (4)	51
705YL-1	EZ-SnapJack, Cat 5e, Yellow (Bulk)	51
705YL-40	EZ-SnapJack, Cat 5e, Yellow (40)	51
705YL-4C	EZ-SnapJack, Cat 5e, Yellow (4)	51
706BK-1	EZ-SnapJack, Cat 6, Black (Bulk)	51
706BK-40	EZ-SnapJack, Cat 6, Black (40)	51
706BK-4C	EZ-SnapJack, Cat 6, Black (4)	51
706BL-1	EZ-SnapJack, Cat 6, Blue (Bulk)	51
706BL-40	EZ-SnapJack, Cat 6, Blue (40)	51
706BL-4C	EZ-SnapJack, Cat 6, Blue (4)	51
706IV-1	EZ-SnapJack, Cat 6, Ivory (Bulk)	51
706IV-40	EZ-SnapJack, Cat 6, Ivory (40)	51
706IV-4C	EZ-SnapJack, Cat 6, Ivory (4)	51
706LA-1	EZ-SnapJack, Cat 6, Light Almond (Bulk)	51
706LA-40	EZ-SnapJack, Cat 6, Light Almond (40)	51
706LA-4C	EZ-SnapJack, Cat 6, Light Almond (4)	51
706OR-1	EZ-SnapJack, Cat 6, Orange (Bulk)	51
706OR-40	EZ-SnapJack, Cat 6, Orange (40)	51
706OR-4C	EZ-SnapJack, Cat 6, Orange (4)	51
706WH-1	EZ-SnapJack, Cat 6, White (Bulk)	51
706WH-40	EZ-SnapJack, Cat 6, White (40)	51
706WH-4C	EZ-SnapJack, Cat 6, White (4)	51
706YL-1	EZ-SnapJack, Cat 6, Yellow (Bulk)	51
706YL-40	EZ-SnapJack, Cat 6, Yellow (40)	51
706YL-4C	EZ-SnapJack, Cat 6, Yellow (4)	51
723LA-50	Keystone Cat3, 6 Pin, 110 Jack, Light Almond (50)	48
723WH-50	Keystone Cat3, 6 Pin, 110 Jack, White (50)	48
725BL-50	Keystone Cat5e, 110 Jack, Blue (50)	48
725LA-50	Keystone Cat5e, 110 Jack, Light Almond (50)	48
725WH-50	Keystone Cat5e, 110 Jack, White (50)	48
726BL-50	Keystone Cat6, 110 Jack, Blue (50)	48
726LA-50	Keystone Cat6, 110 Jack, Light Almond (50)	48
726WH-50	Keystone Cat6, 110 Jack, White (50)	48
750-1C	Keystone Cat6A Tool-less, Shielded Jack (1)	49
765WH-10	Keystone Cat5e Data Coupler, White (10)	49
775WH-1C	HDMI-to-HDMI Pigtail, White	49
780LA-50	Keystone F - 36GHz, Light Almond	48
780WH-50	Keystone F - 36GHz, White	48
790LA-10	Keystone Blank Insert, Light Almond (10)	49
790WH-10	Keystone Blank Insert, White (10)	49
1081	Fixed Handle Cutting Boot	7
4001NPT	Nylon Zip Case	74, 76, 77, 78
4002PT	Nylon Zip Case, W/Handles	76, 77, 78
4007	Hanging Pouch	66, 67, 68, 69, 70, 71
4015C	Punchdown Tool Pouch	29, 76
4050	SealSmart Installation Case	79
6050	Replacement Blade for PN 10565	7
6051	Replacement Blade for PN 10560	7
6055	Replacement Blade for PN 10569C	6
6070K1	Replacement Cord Set Kit	69
10005C	Cable Jacket Slitter (.18-1.0")	9
10006C	Replacement Blade for Slitters	9
10007C	Cable Jacket Slitter (1-1.4")	9
10200C	Heavy Duty Cable Tie Gun	31
10500C	Coax & Round Wire Cable Cutter	4
10503	Cut-N-Strip	3
10510C	BTP-6 Coax & Data Cable Cutter	4
10512C	Steel Wire Cutter	5
10514C	CCS-6 Cable Cutter	5
10517C	Scissor-Run Electrician's Scissors	2
10519C	Leather Pouch & Cable Splicer's Knife	2
10520C	Cable Splicer's Knife	2
10521C	Leather Pouch	2
10522C	Scissor-Run Electrician's Scissors Kit	2
10525C	Professional Electrician's Scissors	2, 29, 76
10526C	Professional Electrician's Scissors Kit	29, 76
10530C	Ceramic Kevlar Scissors	3
10531C	5" Side Cutting Pliers	4
10540C	BTC-20 Cable Cutter	5
10550C	100 Pair (2/0) Cable Cutter	6
10560	Ratcheted Telcom Cutter - 2,700 Pair	7
10565	Ratcheted Utility Cutter - 750 MCM	7
10569C	500 MCM Cable Cutter	6
10711C	PRO Drywall Saw	32
11000R	BNC 12" Removal Tool	32
11001	BNC 18" Removal Tool	32
11006	BNC 8" Removal Tool	32
11008	BNC 8" Economy Removal Tool	33
11009	BNC 12" Economy Removal Tool	33
11020	F Connector 12" Removal Tool	33

11021	F Connector 8" Removal Tool	33
11022	F Connector 15.5" Removal Tool	33
11050	1.0/2.3 Connector Removal Tool	32
12100C	Connector Pressing Telecom Pliers	31
12150C	Terminal Crimp Tool	30
12201C	8.5" Lineman's Pliers	30
12206C	6" Lineman's Pliers	30
12360C	External Ground Crimp Tool	17
12503BLC	Replacement Blade Set	18
12503C	All-in-One Modular Plug Crimp Tool	18
12507BLC	Replacement Blade Set	16, 18
12507C	Tele-Titan Modular Plug Crimp Tool	18
12508C	TeleTitan Combo Pack	18
12515C	Tele-TitanXg Crimp Tool	16
12516C	Tele-TitanXg 2.0 Crimp Tool	17
12517C	Tele-TitanXg 2.0 Combo 10-Pack	17
13000C	Punchdown Impact Tool	28
13001C	Punchdown Blade, 66	27
13002C	Punchdown Blade, 110	27, 29
13003C	Punchdown Blade, 630	27
13004BLC	Replacement Knives for PN 13004C	27, 29
13004C	110 EZ-Data Cut Blade	27
13005C	Punchdown Impact Tool w/66 Blade	28
13006C	Punchdown Impact Tool w/110 Blade	28
13007C	Punchdown Impact Tool w/66 & 110 Blades	28
13008B	Punchdown Impact Tool w/110 EZ-Data Cut Blade	28
13010C	4-Way, 8 Point Indent Crimp Tool	21
13015C	4-Way, 12 Point Indent Crimp Tool	21
13021C	Combo 66/110 Blade	27
13022C	Punchdown Extension Tool	27
13023C	Punchdown Blade, BIX	27
13024C	Punchdown Blade, Krone	27
13100C	PRO Punchdown Tool	28, 29
13105C	PRO Punchdown Tool w/66 Blade	28
13106C	PRO Punchdown Tool w/110 Blade	28
13107C	PRO Punchdown Tool w/66 & 110 Blades	28
13108C	PRO Punchdown Tool w/110 EZ-Data Cut Blade	28
13109C	PRO Punchdown Tool w/Combo 66/110 Blade	28
13150C	PRO-Strike Punchdown Tool, Only	26
13155C	PRO-Strike Punchdown Tool, w/66 Blade	26
13156C	PRO-Strike Punchdown Tool, w/110 Blade	26
13157C	PRO-Strike Punchdown Tool, w/66 & 110 Blade	26
13159C	PRO-Strike Punchdown Tool, w/66/110 Combo Blade	26
13210	JackAX 110 Termination Tool	29
13211C	JackAX 110 w/EZ-Data Cut Blade	29
13212C	JackAX 110 w/Standard Blade	29
15001C	V-Notch Adjustable Wire Stripper	10
15003C	ProStrip 10/20 Wire Stripper	9
15005C	ProStrip 16/30 Wire Stripper	9
15010C	Cyclops 2 Cable Jacket Stripper	11
15015C	Cat 5e/6 Cable Jacket Stripper	11
15020C	Double Ended Coax Stripper	12
15021C	SealSmart Coax Stripper - RG6 Quad	12
15022C	SealSmart Coax Stripper - RG6	12
15023C	SealSmart Coax Stripper - RG59	12
15024C	SealSmart Coax Stripper - Mini RG59	12
15028C	ProStrip 25R Coax Stripper	13

15029C	Replacement Blade Cartridge	13
15030C	Coax Stripper - 2 Level, RG58/59/62/6/6Q	13
15031C	Coax Stripper - 2 Level, RG58/59/62	13
15032C	Coax Stripper - 2 Level, RG59/62/6	13
15033C	Coax Stripper - 3 Level, RG58/59/62	13
15034C	Coax Stripper - 3 Level, RG59/62/6/6Q	13
15035C	Coax Stripper - 3 Level, RG7/8/11/213/214	13
15038C	Replacement Blade for 2 Level Strippers	13
15039C	Replacement Blade for 3 Level Strippers	13
15041C	BR1 Multi-Stripper "Big Red"	11
15041BLC	BR1 Blade Set	11
15042C	Replacement Blade Cassette for BR1	11
15060C	Adjustable Fiber Optic Stripper	10
15305C	Minim 2.5 Wire Stripper	8
15308C	Replacement Blade Cassette for Minim	8
15310C	Maxim 6 Wire Stripper	8
15313C	Replacement Blade Cassette for Maxim 6	8
15316	Maxim 16 Wire Stripper	8
15317C	Replacement Blade Cassette for Maxim 16	8
16000C	8" Crimp Tool Only	24
16001C	8" Crimp Tool w/Die Set PN 16051C	24
16003C	8" Crimp Tool w/Die Set PN 16053C	24
16004C	8" Crimp Tool w/Die Set PN 16054C	24
16005C	8" Crimp Tool w/Die Set PN 16055C	24
16006C	8" Crimp Tool w/Die Set PN 16056C	24
16007C	8" Crimp Tool w/Die Set PN 16057C	24
16051C	Die Set - Fiber Optics SMA, ST, SC, FC	24
16053C	Die Set - Fiber Optics SMA, ST, SC	24
16054C	Die Set - Open Barrel Contacts	24
16055C	Die Set - Open Barrel D-Sub & RS232	24
16056C	Die Set - Open Barrel Pin & Socket	24
16057C	Die Set - DIN & US Wire Ferrules	24
16201C	SealSmart Compression Crimp Tool	19
16202C	SealSmart BNC Adapter & Nut	19
16203C	SealSmart F Adapter & Nut	19
16204C	SealSmart RCA Adapter & Nut	19
16207C	F Compression Crimp Tool	19
16212C	RH360L F Compression Tool-Long Stroke	20
16213C	PROCON Crimp Tool	20
16214C	RH360S F Compression Tool -Short Stroke	20
16215C	Replacement Multi-Head Adapter	20
16220C	SealSmart II Compression Crimp Tool	19
16500C	9" Ergo Crimp Tool	22
16501C	9" Ergo Crimp Tool w/Die Set PN 17051C	23
16502C	9" Ergo Crimp Tool w/Die Set PN 17052C	23
16503C	9" Ergo Crimp Tool w/Die Set PN 17053C	23
16504C	9" Ergo Crimp Tool w/Die Set PN 17054C	23
16505C	9" Ergo Crimp Tool w/Die Set PN 17055C	23
16506C	9" Ergo Crimp Tool w/Die Set PN 17056C	23
16507C	9" Ergo Crimp Tool w/Die Set PN 17057C	23
16508C	9" Ergo Crimp Tool w/Die Set PN 17058C	23
16509C	9" Ergo Crimp Tool w/Die Set PN 17059C	23
16510C	9" Ergo Crimp Tool w/Die Set PN 17060C	23
16511C	9" Ergo Crimp Tool w/Die Set PN 17061C	23
16512C	9" Ergo Crimp Tool w/Die Set PN 17062C	23
16801C	Open Barrel Crimp Tool	21
17051C	Die Set - Heavy Duty Insulated Terminals	23

17052C	Die Set - Non-Insulated Terminals	23	18058	SealSmart RCA Conns, RG6Q, Gold Plate (6)	40
17053C	Die Set - Coax BNC/TNC/HDTV	23	18060	SealSmart RCA Conns, RG59, Ni Plate (25)	40
17054C	Die Set - Coax BNC/TNC 3 Piece	23	18060RA	SealSmart RCA RA Conns, RG59, Ni Plate (25)	40
17055C	Die Set - CATV F Type Connectors	23	18061	SealSmart RCA Conns, RG59, Ni Plate (6)	40
17056C	Die Set - Coax BNC/TNC F Type Connectors	23	18062	SealSmart RCA RA Conns, RG59, Ni Plate (3)	40
17057C	Die Set - Commercial Insulated Terminals	23	18065	SealSmart RCA Conns, RG6Q, Ni Plate (25)	40
17058C	Die Set - Commercial Open Barrel	23	18065RA	SealSmart RCA RA Conns, RG6Q, Ni Plate (25)	40
17059C	Die Set - SMA/SMB/Mini Coax, BNC/TNC	23	18066	SealSmart RCA Conns, RG6Q, Ni Plate (6)	40
17060C	Die Set - N Type Plugs	23	18067	SealSmart RCA RA Conns, RG6Q, Ni Plate (3)	34
17061C	Die Set - HDTV/True 75 Ohm/BNC/TNC	23	18110	UR Telecom Splice (100)	31, 41
17062C	Die Set - Coax BNC/TNC 2-Piece	23	18112C	UR Telecom Splice (50)	31, 41
17099C	Quick Change Die Screws	22	18111	UR Telecom Splice (25)	31, 41
18001	SealSmart F Conns, RG6Q, Ni Plate (100)	38	18120	UY Telecom Splice (100)	31, 41
18001RA	SealSmart F RA Conns, RG6Q, Ni Plate (25)	38	18121	UY Telecom Splice (25)	31, 41
18002	SealSmart F Conns, RG6Q, Ni Plate (10)	38	18122C	UY Telecom Splice (100)	31, 41
18003	SealSmart F RA Conns, RG6Q, Ni Plate (3)	38	18130	UB Telecom Splice (100)	31, 41
18004	SealSmart F Conns, RG6Q Gold Plate (100)	38	18131	UB Telecom Splice (25)	31, 41
18005	SealSmart F Conns, RG6Q, Gold Plate (10)	38	18132	UB Telecom Splice (100)	31, 41
18006	SealSmart F Conns, RG6, Ni Plate (100)	38	18200	SealSmart F Conns, RGB 24 AWG, Ni Plate (25)	38
18006RA	SealSmart F RA Conns, RG6, Ni Plate (25)	38	18205	SealSmart F Conns, RGB 24 AWG, Gold Plate (25)	38
18007	SealSmart F Conns, RG6, Ni Plate (10)	38	18210	SealSmart F Conns, RGB 23 AWG, Ni Plate (25)	38
18008	SealSmart F RA Conns, RG6, Ni Plate (3)	38	18215	SealSmart F Conns, RGB 23 AWG, Gold Plate (25)	38
18009	SealSmart F Conns, RG6, Gold Plate (100)	38	18220	SealSmart F Conns, RGB 25 AWG, Ni Plate (25)	38
18010	SealSmart F Conns, RG6, Gold Plate (10)	38	18225	SealSmart F Conns, RGB 25 AWG, Gold Plate (25)	38
18011	SealSmart F Conns, RG59, Ni Plate (100)	38	18230	SealSmart BNC Conns, RGB 24 AWG, Ni Plate (25)	39
18011RA	SealSmart F RA Conns, RG59, Ni Plate (25)	38	18235	SealSmart BNC Conns, RGB 24 AWG, Gold Plate (25)	39
18012	SealSmart F Conns, RG59, Ni Plate (10)	38	18240	SealSmart BNC Conns, RGB 23 AWG, Ni Plate (25)	39
18013	SealSmart F RA Conns, RG59, Ni Plate (3)	38	18245	SealSmart BNC Conns, RGB 23 AWG, Gold Plate (25)	39
18015	SealSmart F Conns, RG59, Gold Plate (100)	38	18250	SealSmart BNC Conns, RGB 25 AWG, Ni Plate (25)	39
18016	SealSmart F Conns, RG59, Gold Plate (10)	38	18255	SealSmart BNC Conns, RGB 25 AWG, Gold Plate (25)	39
18020	SealSmart BNC Conns, RG6Q, Gold Plate (25)	39	18260	SealSmart RCA Conns, RGB 24 AWG, Ni Plate (25)	40
18021	SealSmart BNC Conns, RG6Q, Gold Plate (6)	39	18265	SealSmart RCA Conns, RGB 24 AWG, Gold Plate (25)	40
18025	SealSmart BNC Conns, RG6, Gold Plate (25)	39	18270	SealSmart RCA Conns, RGB 23 AWG, Ni Plate (25)	40
18026	SealSmart BNC Conns, RG6, Gold Plate (6)	39	18275	SealSmart RCA Conns, RGB 23 AWG, Gold Plate (25)	40
18030	SealSmart BNC Conns, RG59, Gold Plate (25)	39	18280	SealSmart RCA Conns, RGB 25 AWG, Ni Plate (25)	40
18031	SealSmart BNC Conns, RG59, Gold Plate (6)	39	18285	SealSmart RCA Conns, RGB 25 AWG, Gold Plate (25)	40
18035	SealSmart BNC Conns, RG6Q, Ni Plate (25)	39	18301	F Female-to-Female Coupler (25)	41, 68
18035RA	SealSmart BNC RA Conns, RG6Q, Ni Plate (25)	39	18301C	F Female-to-Female Coupler (2)	41
18036	SealSmart BNC Conns, RG6Q, Ni Plate (6)	39	18303	BNC Female-to-F Female Adapter (25)	41
18037	SealSmart BNC RA Conns, RG6Q, Ni Plate (3)	39	18303C	BNC Female-to-F Female Adapter (2)	41, 68, 70
18038	SealSmart BNC Conns, RG6, Ni Plate (25)	39	18304	Adapter, F Jack to Push-On Plug	68
18038RA	SealSmart BNC RA Conns, RG6, Ni Plate (25)	39	18305	BNC Female-to-F Male Adapter (25)	41
18039	SealSmart BNC Conns, RG6, Ni Plate (6)	39	18305C	BNC Female-to-F Male Adapter (2)	41
18040	SealSmart BNC RA Conns, RG6, Ni Plate (3)	39	18306C	F Male 75 Ohm Terminator (2)	41
18041	SealSmart BNC Conns, RG59, Ni Plate (25)	39	18307	F Male-to-F Male Splice (25)	41
18041RA	SealSmart BNC RA Conns, RG59, Ni Plate (40)	39	18307C	F Male-to-F Male Splice (2)	41
18042	SealSmart BNC Conns, RG59, Ni Plate (6)	39	18308	BNC Inline Splice Female-to-Female (25)	41
18043	SealSmart BNC RA Conns, RG59, Ni Plate (3)	39	18308C	BNC Inline Splice Female-to-Female (2)	41
18051	SealSmart RCA Conns, RG6, Ni Plate (25)	40	18309	F Male 75 Ohm Terminator (25)	41, 68
18051C	SealSmart RCA Conns, RG6, Ni Plate (6)	40	18309C	F Male 75 Ohm Terminator (10)	41, 68
18051RA	SealSmart RCA RA Conns, RG6, Ni Plate (25)	40	18310	BNC Male-to-F Female (25)	41
18052	SealSmart RCA Conns, RG6, Gold Plate (25)	40	18310C	BNC Male-to-F Female (2)	41
18053	SealSmart RCA Conns, RG6, Gold Plate (6)	40	18311	SealSmart F Conns, RG11, Ni Plate (25)	38
18054	SealSmart RCA RA Conns, RG6, Ni Plate (3)	40	18312	SealSmart F Conns, RG11, Ni Plate (4)	38
18055	SealSmart RCA Conns, RG59, Gold Plate (25)	40	18314	RCA Male-to-BNC Female (25)	41
18056	SealSmart RCA Conns, RG59, Gold Plate (6)	40	18314C	RCA Male-to-BNC Female (2)	41
18057	SealSmart RCA Conns, RG6Q, Gold Plate (25)	40	19001C	6-in-1 Screwdriver	34

19002C	PRO 6-in-1 Screwdriver	34	100026LTC	EZ-RJ12/11 Long Tab (50)	42
19003C	PRO 6-in-1 Security Screwdriver	34	100030B-C	Strain Relief, Cat 6, Blue (50)	44
19059C	Can Wrench	31	100030BK-C	Strain Relief, Cat 6, Black(50)	44
19101	Precision Screwdriver Set	36	100030GR-C	Strain Relief, Cat 6, Green (50)	44
19103	Micro Mini II Screwdriver Set	37	100030GY-C	Strain Relief, Cat 6, Grey (50)	44
19105	22-in-1 Security Screwdriver Kit	35, 79	100030R-C	Strain Relief, Cat 6, Red (50)	44
19110	1 KV Insulated Precision Screwdriver Set	37	100030Y-C	Strain Relief, Cat 6, Yellow (50)	44
19120C	8-in-1 Ratcheted Stubby Screwdriver	35	100031B-BG	RJ45 Boots, 5.5 mm OD, Blue (25)	44
19501	BongoTies	61	100031BK-BG	RJ45 Boots, 5.5 mm OD, Black (25)	44
21025C	RJ45 Port Saver	66	100031GR-BG	RJ45 Boots, 5.5 mm OD, Green (25)	44
28001J	SealSmart F Conns, RG6Q, Ni Plate (75)	38	100031GY-BG	RJ45 Boots, 5.5 mm OD, Grey (25)	44
28006J	SealSmart F Conns, RG6, Ni Plate (75)	38	100031O-BG	RJ45 Boots, 5.5 mm OD, Orange (25)	44
28011J	SealSmart F Conns, RG59, Ni Plate (75)	38	100031P-BG	RJ45 Boots, 5.5 mm OD, Purple (25)	44
28038J	SealSmart BNC Conns, RG6, Ni Plate (40)	39	100031R-BG	RJ45 Boots, 5.5 mm OD, Red (25)	44
28041J	SealSmart BNC Conns, RG59, Ni Plate (40)	39	100031W-BG	RJ45 Boots, 5.5 mm OD, White (25)	44
28051J	SealSmart RCA Conns, RG6, Ni Plate (50)	40	100031Y-BG	RJ45 Boots, 5.5 mm OD, Yellow (25)	44
28060J	SealSmart RCA Conns, RG59, Ni Plate (50)	40	100032B-BG	RJ45 Boots, 6 mm OD, Blue (25)	44
28110J	UR Telecom Splice (200)	31, 41	100032BK-BG	RJ45 Boots, 6 mm OD, Black (25)	44
90121	Basic Twisted Pair & Coax Kit	77	100032GR-BG	RJ45 Boots, 6 mm OD, Green (25)	44
90122	Twisted Pair Termination Kit	74	100032GY-BG	RJ45 Boots, 6 mm OD, Grey (25)	44
90124	PRO Twisted Pair & Coax Termination Kit	77	100032O-BG	RJ45 Boots, 6 mm OD, Orange (25)	44
90125	SealSmart Field Install Kit, Ni	79	100032P-BG	RJ45 Boots, 6 mm OD, Purple (25)	44
90126	SealSmart Field Install Kit, Gold	79	100032R-BG	RJ45 Boots, 6 mm OD, Red (25)	44
90136	EZ-RJ45 Termination Kit	76	100032W-BG	RJ45 Boots, 6 mm OD, White (25)	44
90150	Basic HD Twisted Pair & Coax Kit	77	100032Y-BG	RJ45 Boots, 6 mm OD, Yellow (25)	44
90151	EZ-RJPRO HD Termination Kit	76	100033B-BG	RJ45 Boots, 6.5 mm OD, Blue (25)	44
90152C	PRO Punchdown Tool Kit	29, 76	100033BK-BG	RJ45 Boots, 6.5 mm OD, Black (25)	44
90153	PRO HD Twisted Pair & Coaxial Kit	78	100033GR-BG	RJ45 Boots, 6.5 mm OD, Green (25)	44
90170	10Gig Termination Kit	72, 73	100033GY-BG	RJ45 Boots, 6.5 mm OD, Grey (25)	44
90173	EZ-RJPRO Termination Pod	75	100033O-BG	RJ45 Boots, 6.5 mm OD, Orange (25)	44
90201	Premier CATV Connectivity Kit	78	100033P-BG	RJ45 Boots, 6.5 mm OD, Purple (25)	44
90202	Premier CCTV Connectivity Kit	78	100033R-BG	RJ45 Boots, 6.5 mm OD, Red (25)	44
90203	Premier Data Connectivity Kit	74	100033W-BG	RJ45 Boots, 6.5 mm OD, White (25)	44
100002	EZ-RJ45 Convenience Pack - 200	74	100033Y-BG	RJ45 Boots, 6.5 mm OD, Yellow (25)	44
100003B	EZ-RJ45 Cat5e (100 Box)	42	100034B-BG	RJ45 Boots, 7 mm OD, Blue (25)	44
100003C	EZ-RJ45 Cat5e (50)	42	100034BK-BG	RJ45 Boots, 7 mm OD, Black (25)	44
100004BL	EZ-RJ45 Replacement Blade Set (2 per)	15	100034GR-BG	RJ45 Boots, 7 mm OD, Green (25)	44
100004C	EZ-RJ45 Crimp Tool	15	100034GY-BG	RJ45 Boots, 7 mm OD, Grey (25)	44
100005	EZ-RJ45 Convenience Pack - 50	74	100034O-BG	RJ45 Boots, 7 mm OD, Orange (25)	44
100007	EZ-RJPRO HD Convenience Pack	74	100034P-BG	RJ45 Boots, 7 mm OD, Purple (25)	44
100008	EZ-RJ45 Combo - 24	74	100034R-BG	RJ45 Boots, 7 mm OD, Red (25)	44
100009C	EZ-RJ45 Cat 6 (10)	42	100034W-BG	RJ45 Boots, 7 mm OD, White (25)	44
100010B	EZ-RJ45 Cat 6 (100 Box)	42	100034Y-BG	RJ45 Boots, 7 mm OD, Yellow (25)	44
100010C	EZ-RJ45 Cat 6 (50)	42	100037R-BG	RJ45 Boots, 7.5 mm OD, Red (25)	44
100011C	EZ-RJ45 Cat 6 Combo Pack - 30	43	100037B-BG	RJ45 Boots, 7.5 mm OD, Blue (25)	44
100012	EZ-RJ45 Basic Installation Kit Bundle	75	100037BK-BG	RJ45 Boots, 7.5 mm OD, Black (25)	44
100015	EZ-RJ45 Cat5e (15)	42	100038R-BG	RJ45 Boots, 8 mm OD, Red (25)	44
100016	EZ-RJPRO HD Basic Installation Kit Bundle	75	100038B-BG	RJ45 Boots, 8 mm OD, Blue (25)	44
100020	EZ-RJ45 Shielded Cat 5e/6 (Internal Ground) (50)	43	100038BK-BG	RJ45 Boots, 8 mm OD, Black (25)	44
100020C	EZ-RJ45 Shielded Cat 5e/6 (Internal Ground) (50)	42	100039R-BG	RJ45 Boots, 8.5 mm OD, Red (25)	44
100021C	EZ-RJ45 Shielded Cat 5e/6 (Internal Ground) (10)	43	100039B-BG	RJ45 Boots, 8.5 mm OD, Blue (25)	44
100022	EZ-RJ45 Shielded Cat 5e/6 (External Ground) (50)	43	100039BK-BG	RJ45 Boots, 8.5 mm OD, Black (25)	44
100022C	EZ-RJ45 Shielded Cat 5e/6 (External Ground) (50)	43	100035	EZ-RJ45 Strain Relief, Cat 5e, Clear (50)	43
100023C	EZ-RJ45 Shielded Cat 5e/6 (External Ground) (10)	43	100035C	EZ-RJ45 Strain Relief, Cat 5e, Clear (50)	43
100026B	EZ-RJ12/11 Std. Tab (100)	42	100036	EZ-RJ45 Strain Relief, Cat 6, Clear (50)	43
100026C	EZ-RJ12/11 Std. Tab (50)	42	100036C	EZ-RJ45 Strain Relief, Cat 6, Clear (50)	43
100026LTB	EZ-RJ12/11 Long Tab (100)	42	100041B-C	EZ-DataLock Locking Set for EZ-RJ45, Blue (20)	45

100041CL-C	EZ-DataLock Locking Set for EZ-RJ45, Clear (20)	45	105048	EZ-DataLock Strain Relief, White (100)	45
100041BK-C	EZ-DataLock Locking Set for EZ-RJ45, Black (20)	45	105049	EZ-DataLock Locking Pins (50)	45
100041GR-C	EZ-DataLock Locking Set for EZ-RJ45, Green (20)	45	105050	EZ-DataLock Key (50)	45
100041GY-C	EZ-DataLock Locking Set for EZ-RJ45, Grey (20)	45	105060	RJ45 Boots, 5.5 mm OD, Red (100)	44
100041R-C	EZ-DataLock Locking Set for EZ-RJ45, Red (20)	45	105061	RJ45 Boots, 5.5 mm OD, Blue (100)	44
100041Y-C	EZ-DataLock Locking Set for EZ-RJ45, Yellow (20)	45	105062	RJ45 Boots, 5.5 mm OD, Black (100)	44
100041W-C	EZ-DataLock Locking Set for EZ-RJ45, White (20)	45	105063	RJ45 Boots, 5.5 mm OD, Grey (100)	44
100042B-C	EZ-DataLock Locking Set for EZ-RJ45, Blue (20)	45	105064	RJ45 Boots, 5.5 mm OD, Green (100)	44
100042CL-C	EZ-DataLock Locking Set for EZ-RJ45, Clear (20)	45	105065	RJ45 Boots, 5.5 mm OD, Yellow (100)	44
100042BK-C	EZ-DataLock Locking Set for EZ-RJ45, Black (20)	45	105066	RJ45 Boots, 5.5 mm OD, White (100)	44
100042GR-C	EZ-DataLock Locking Set for EZ-RJ45, Green (20)	45	105067	RJ45 Boots, 5.5 mm OD, Purple (100)	44
100042GY-C	EZ-DataLock Locking Set for EZ-RJ45, Grey (20)	45	105068	RJ45 Boots, 5.5 mm OD, Orange (100)	44
100042R-C	EZ-DataLock Locking Set for EZ-RJ45, Red (20)	45	105071	RJ45 Boots, 6 mm OD, Red (100)	44
100042Y-C	EZ-DataLock Locking Set for EZ-RJ45, Yellow (20)	45	105072	RJ45 Boots, 6 mm OD, Blue (100)	44
100042W-C	EZ-DataLock Locking Set for EZ-RJ45, White (20)	45	105073	RJ45 Boots, 6 mm OD, Black (100)	44
100043C	EZ-DataLock Locking Pins (50)	45	105074	RJ45 Boots, 6 mm OD, Grey (100)	44
100045C	EZ-DataLock Key (5)	45	105075	RJ45 Boots, 6 mm OD, Green (100)	44
100054BL	Replacement Blade Set	15	105076	RJ45 Boots, 6 mm OD, Yellow (100)	44
100054C	EZ-RJPRO HD Crimp Tool	15	105077	RJ45 Boots, 6 mm OD, White (100)	44
100054SBL-10C	Replacement RJ45 Blades (10)	15	105078	RJ45 Boots, 6 mm OD, Purple (100)	44
100055BL	Replacement Blade Set	18	105079	RJ45 Boots, 6 mm OD, Orange (100)	44
100055C	PROAMP Crimp Tool	18	105081	RJ45 Boots, 6.5 mm OD, Red (100)	44
100111C	Non-Impact PDT with EZ-Data Cut Blade	29	105082	RJ45 Boots, 6.5 mm OD, Blue (100)	44
100333	EZ-Grip Puck	33	105083	RJ45 Boots, 6.5 mm OD, Black (100)	44
100543	EZ-RJ45 Die for 100544	16	105084	RJ45 Boots, 6.5 mm OD, Grey (100)	44
100543BL	Replacement Blade for 100543	16	105085	RJ45 Boots, 6.5 mm OD, Green (100)	44
100543K1	EZ-Viking Field Service Kit	16	105086	RJ45 Boots, 6.5 mm OD, Yellow (100)	44
100544	EZ-Viking Crimp Tool	16	105087	RJ45 Boots, 6.5 mm OD, White (100)	44
105003	EZ-RJ45 Cat 5e (Bulk)	42	105088	RJ45 Boots, 6.5 mm OD, Purple (100)	44
105004	EZ-RJ45 Cat 6 (Bulk)	42	105089	RJ45 Boots, 6.5 mm OD, Orange (100)	44
105005	EZ-RJ12/11 Std. Tab (Bulk)	42	105091	RJ45 Boots, 7 mm OD, Red (100)	44
105005LT	EZ-RJ12/11 Long Tab (Bulk)	42	105092	RJ45 Boots, 7 mm OD, Blue (100)	44
105006	Strain Relief, Cat 6, Red (500)	44	105093	RJ45 Boots, 7 mm OD, Black (100)	44
105007	Strain Relief, Cat 6, Blue (500)	44	105094	RJ45 Boots, 7 mm OD, Grey (100)	44
105008	Strain Relief, Cat 6, Grey (500)	44	105095	RJ45 Boots, 7 mm OD, Green (100)	44
105009	Strain Relief, Cat 6, Green (500)	44	105096	RJ45 Boots, 7 mm OD, Yellow (100)	44
105010	Strain Relief, Cat 6, Yellow (500)	44	105097	RJ45 Boots, 7 mm OD, White (100)	44
105011	Strain Relief, Cat 6, Black (500)	44	105098	RJ45 Boots, 7 mm OD, Purple (100)	44
105015	EZ-RJ45 Strain Relief, Cat 5e, Clear (500)	43	105099	RJ45 Boots, 7 mm OD, Orange (100)	44
105016	EZ-RJ45 Strain Relief, Cat 6, Clear (500)	43	105100	RJ45 Boots, 7.5 mm OD, Blue (100)	44
105020	EZ-RJ45 Shielded Cat 5e/6 (Internal Ground) (100)	43	105101	RJ45 Boots, 7.5 mm OD, Black (100)	44
105022	EZ-RJ45 Shielded Cat 5e/6 (External Ground) (100)	43	105102	RJ45 Boots, 7.5 mm OD, Red (100)	44
105030	EZ-DataLock Strain Relief for EZ-RJ45, Clear (100)	45	105103	RJ45 Boots, 8 mm OD, Blue (100)	44
105031	EZ-DataLock Strain Relief for EZ-RJ45, Black (100)	45	105104	RJ45 Boots, 8 mm OD, Black (100)	44
105032	EZ-DataLock Strain Relief for EZ-RJ45, Red (100)	45	105105	RJ45 Boots, 8 mm OD, Red (100)	44
105033	EZ-DataLock Strain Relief for EZ-RJ45, Yellow (100)	45	105106	RJ45 Boots, 8.5 mm OD, Blue (100)	44
105034	EZ-DataLock Strain Relief for EZ-RJ45, Green (100)	45	105107	RJ45 Boots, 8.5 mm OD, Black (100)	44
105035	EZ-DataLock Strain Relief for EZ-RJ45, Blue (100)	45	105108	RJ45 Boots, 8.5 mm OD, Red (100)	44
105036	EZ-DataLock Strain Relief for EZ-RJ45, Grey (100)	45	106100	RJ22, Flat/Stranded (500)	46
105037	EZ-DataLock Strain Relief for EZ-RJ45, White (100)	45	106102C	RJ22, Flat/Stranded (25)	46
105041	EZ-DataLock Strain Relief, Clear (100)	45	106103J	RJ22, Flat/Stranded (100)	46
105042	EZ-DataLock Strain Relief, Black (100)	45	106110	RJ11, Flat/Stranded (500)	46
105043	EZ-DataLock Strain Relief, Red (100)	45	106112C	RJ11, Flat/Stranded (25)	46
105044	EZ-DataLock Strain Relief, Yellow (100)	45	106113J	RJ11, Flat/Stranded (100)	46
105045	EZ-DataLock Strain Relief, Green (100)	45	106115	RJ11, Round/Stranded (500)	46
105046	EZ-DataLock Strain Relief, Blue (100)	45	106117C	RJ11, Round/Stranded (25)	46
105047	EZ-DataLock Strain Relief, Grey (100)	45	106118J	RJ11, Round/Stranded (100)	46

106120	RJ11, Round/Solid (500)	46
106122C	RJ11, Round/Solid (25)	46
106123J	RJ11, Round/Solid (100)	46
106125	RJ12, Flat/Stranded (500)	46
106127C	RJ12, Flat/Stranded (25)	46
106128J	RJ12, Flat/Stranded (100)	46
106130	RJ12, Round/Stranded (500)	46
106132C	RJ12, Round/Stranded (25)	46
106133J	RJ12, Round/Stranded (100)	46
106135	RJ12, Round/Solid (500)	46
106137C	RJ12, Round/Solid (25)	46
106138J	RJ12, Round/Solid (100)	46
106140	RJ45 Cat 5e, Flat/Stranded (500)	46
106142C	RJ45 Cat 5e, Flat/Stranded (25)	46
106143J	RJ45 Cat 5e, Flat/Stranded (100)	46
106145	RJ45 Cat 5e, Round/Stranded (500)	46
106147C	RJ45 Cat 5e, Round/Stranded (25)	46
106148J	RJ45 Cat 5e, Round/Stranded (100)	46
106150	RJ45 Cat 5e, Round/Solid (500)	46
106152C	RJ45 Cat 5e, Round/Solid (25)	46
106153J	RJ45 Cat 5e, Round/Solid (100)	46
106160	RJ45 Cat 5e, Round/Stranded (500)	46
106162C	RJ45 Cat 5e, Round/Stranded (25)	46
106163J	RJ45 Cat 5e, Round/Stranded (100)	46
106165	RJ45 Cat 5e, Round/Solid (500)	46
106167C	RJ45 Cat 5e, Round/Solid (25)	46
106168J	RJ45 Cat 5e, Round/Solid (100)	46
106170	RJ45 Cat 6, Round/Stranded (500)	47
106172C	RJ45 Cat 6, Round/Stranded (25)	47
106173J	RJ45 Cat 6, Round/Stranded (100)	47
106175	RJ45 Cat 6, Round/Solid (500)	47
106177C	RJ45 Cat 6, Round/Solid (25)	47
106178J	RJ45 Cat 6, Round/Solid (100)	47
106180C	RJ45 Cat 5e, Round/Stranded (100)	46
106182C	RJ45 Cat 5e, Round/Stranded (50)	46
106183C	RJ45 Cat 5e, Round/Stranded (10)	46
106185	RJ45 Cat6, Round/Solid, High-Performance (500)	47
106187C	RJ45 Cat6, Round/Solid, High-Performance (25)	47
106188J	RJ45 Cat6, Round/Solid, High-Performance (100)	47
106190	RJ45 Cat6A, 10-Gig (100)	47
106191	RJ45 Cat6A, 10-Gig (25)	47
106192	RJ45 Cat6A, 10-Gig (50)	47
106192C	RJ45 Cat6A, 10-Gig (50)	47
106193C	RJ45 Cat6A, 10-Gig (10)	47
106194	RJ45 Cat6A, 10-Gig Liners (50)	47
106205	RJ45 Cat6, Round/Solid, Shielded High-Performance (100)	47
106206J	RJ45 Cat6, Round/Solid, Shielded High-Performance (100)	47
106207C	RJ45 Cat6, Round/Solid, Shielded High-Performance (50)	47
106208C	RJ45 Cat6, Round/Solid, Shielded High-Performance (10)	47
106211C	In-Line Coupler, Light Almond (2)	49
202003J	EZ-RJ45 Cat5e (100)	42
202010J	EZ-RJ45 Cat 6 (100)	42
202015J	EZ-RJ45 Cat 5e 50/50 Combo (50 Each)	43
202016J	EZ-RJ45 Cat 6 50/50 Combo (50 Each)	43
202020J	EZ-RJ45 Shielded Cat 5e/6 (Internal Ground) (50)	43
202022J	EZ-RJ45 Shielded Cat 5e/6 (External Ground) (50)	43
202026J	EZ-RJ11/12 Std. Tab (100)	42

202035J	EZ-RJ45 Strain Relief, Cat 5e, Clear (100)	43
202036J	EZ-RJ45 Strain Relief, Cat 6, Clear (100)	43
CCP16-100	J-Hook, Std CCP, 1" Size 16 (100)	56
CCP16AC-100	J-Hook, 90° CCP, 1" Size 16 (100)	56
CCP16W-100	J-Hook, Batwing CCP, 1" Size 16 (100)	56
CCP32-100	J-Hook, Std CCP, 2" Size 32 (100)	56
CCP32AC-100	J-Hook, 90° CCP, 2" Size 32 (100)	56
CCP32W-100	J-Hook, Batwing CCP, 2" Size 32 (100)	56
CCP48-25	J-Hook, Std CCP, 3" Size 48 (25)	56
CCP48AC-25	J-Hook, 90° CCP, 3" Size 48 (25)	56
CCP48W-25	J-Hook, Batwing CCP, 3" Size 48 (25)	56
JH12-25	J-Hook, Standard, 3/4" Size 12 (25)	57
JH12-100	J-Hook, Standard, 3/4" Size 12 (100)	57
JH12AC-25	J-Hook, 90° Standard, 3/4" Size 12 (25)	57
JH12AC-100	J-Hook, 90° Standard, 3/4" Size 12 (100)	57
JH12BC-100	J-Hook, Beam Clamp, 3/4" Size 12 (100)	57
JH12W-25	J-Hook, Batwing Standard, 3/4" Size 12 (25)	57
JH12W-100	J-Hook, Batwing Standard, 3/4" Size 12 (100)	57
JH21-25	J-Hook, Standard, 1 5/16" Size 21 (25)	57
JH21-100	J-Hook, Standard, 1 5/16" Size 21 (100)	57
JH21AC-25	J-Hook, 90° Standard, 1 5/16" Size 21 (25)	57
JH21AC-100	J-Hook, 90° Standard, 1 5/16" Size 21 (100)	57
JH21BC-100	J-Hook, Beam Clamp, 1 5/16" Size 12 (100)	57
JH21W-25	J-Hook, Batwing Standard, 1 5/16" Size 21 (25)	57
JH21W-100	J-Hook, Batwing Standard, 1 5/16" Size 21 (100)	57
JH32-25	J-Hook, Standard, 2" Size 32 (25)	57
JH32-100	J-Hook, Standard, 2" Size 32 (100)	57
JH32AC-25	J-Hook, 90° Standard, 2" Size 32 (25)	57
JH32AC-100	J-Hook, 90° Standard, 2" Size 32 (100)	57
JH32BC-100	J-Hook, Beam Clamp, 2" Size 32 (100)	57
JH32EH-100	End Hook, 2" Size 32 (100)	57
JH32HOK24-100	Hammer-On, 2" Size 32 (100)	57
JH32HOK58-100	Hammer-On, 2" Size 32 (100)	57
JH32W-25	J-Hook, Batwing Standard, 2" Size 32 (25)	57
JH32W-100	J-Hook, Batwing Standard, 2" Size 32 (100)	57
JH64-25	J-Hook, Standard, 4" Size 64 (25)	57
JH64AC-25	J-Hook, 90° Standard, 4" Size 64 (25)	57
JH64HOK58-25	Hammer-On, 4" Size 64 (25)	57
JH64W-25	J-Hook, Batwing Standard, 4" Size 64 (25)	57
JH701	Female Hex Adapter for 1/4" Male Driver	60, 61
JH702	Hex Adapter, Open End 3/8"	60, 61
JH703	Female Open End 5/8" Hex Adapter	60, 61
JH705	1/2" NPT Adapter	60, 61
JH707	Drill Driver Adapter	60, 61
JH712	Xtender Pole - 12	60
JH718	Xtender Pole - 18	60
JH802-100	Bridle Rings, 10x24 - 3/4" ID	59
JH804-100	Bridle Rings, 10x24 - 2" ID	59
JH807-100	Bridle Rings, .25x20 - 1.1/4" ID	59
JH808-100	Bridle Rings, .25x20 - 2" ID	59
JH809-50	Bridle Rings, .25x20 - 4" ID	59
JH901-100	Vertical Overhang (C Purlin) (100)	59
JH902-100	Angled Overhang (Z Purlin) (100)	59
JH910-100	Hammer-On Beam Clamp, 1/8-1/4" (100)	59
JH911-100	Hammer-On Beam Clamp, 5/16-1/2" (100)	59
JH920-100	Angle Clip 90° 1/4-20 (100)	59
JH921-100	Z Angle Clip 1/4-20 (100)	59

JH930-100	Angle Clip 90 - End Hook, Powder Actuated Nail (100)	59
JH931-50	Angle Clip Z - Powder Actuated Nail (50)	59
JH932-100	Angle Clip 90 - Powder Actuated Nail (100)	59
JH940-100	1/4" Eye Lag Screw (100)	59
JH941-100	2" Overall Self Drill Eye Lag Screw (100)	59
JH952-100	3/8-16 Male Coupler for Wood (100)	59
JH953-100	3/8-16 Male Coupler for Sheet Metal (100)	59
JH960-100	Multi-Function Clip, Batwing (100)	59
JH965-50	Pressed Beam Clamp for 1/2" Flanges (50)	59
JH966-100	Beam Clamp for 1/8"-1/2" Flange (100)	59
JH967-100	Beam Clamp for 1/8"-1/2" Flange (100)	59
JH975	Installation Tool - Vertical & Angled Overhang (1)	59, 60
JH980	Eye Lag Driver (1)	59
T62	RECON Test Set	69
T101C	F Remote Kit	62
T103C	BNC Adapter Kit	62
T104C	4MAPPER Tester	62
T119C	VDV MapMaster Tester	64
T120C	Coax Remote Set, 1-19	66
T121C	Data Remote Set, 1-19	66
T124C	Master Remote	66
T125C	RJ45 to Alligator 12" Cable	66
T126C	No-Fault Cable	66
T127C	Coax Remote Set, 1-8	66
T128C	Data Remote Set, 1-12	66
T129	VDV MapMaster 2.0 Tester	65
T129K1	VDV MapMaster 2.0 Test Kit	81
T139	Smart Remote Kit	66, 81
TAD001	F Connector Coupler	41, 70
TCA001	Cable Assembly, Insulated Push-On F to RJ45 Plug	70
TCA002	Cable Assembly, Insulated BNC to Alligator Clips	70
TCA003	Cable Assembly, Insulated Push-On F to Alligator Clips	70
TCA004	Cable Assembly, Screw-On F Jack to Push-On F Plug, 12"	48, 68
TCA007	Micro USB Cable	66
TCB300	Cable Prowler Tester	67
TCB360K1	Cable Prowler PRO Test Kit	80
TCC200	Coax Clarifier with 2 Coax RF Remotes	68
TCC220	Coax Clarifier with 4 Coax RF Remotes	68
TCR001	No. 1 Coax RF Remote	68
TCR002	No. 2 Coax RF Remote	68
TCR003	No. 3 Coax RF Remote	68
TCR004	No. 4 Coax RF Remote	68
TNP700	Net Prowler Tester	71
TNP850K1	Net Prowler PRO Test Kit	82
TP150	Tone and Probe Set	63
TRK104	Nos. 1-4 ID Only Coax Remote Set	68
TRK112	Nos. 1-12 ID Only Coax Remote Set	68
TSS200	Snap Shot Tester	70

Alpha Index

10Gig Termination Kit	72
110 EZ-Data Cut Blade	27
4MAPPER Tester	62
Big Red Stripper	11
Bongo Ties	61
BR1 Multi-Stripper	11
Bridle Rings	59

Cable Jacket Slitters	9
Cable Prowler Tester	67
Cable Prowler PRO Test Kit	80
Cable Tie Gun	31
Can Wrench	31
Coax Clarifier Tester	68
Coax Adapters	41
Compression Connectors	38-40
Connector Removal Tools	28-29
Cyclops Stripper	11
E Series Coax Strippers	13
EZ-DataLock Strain Relief	45
EZ-Grip Puck	33
EZ-RJ12/11 Connectors	42
EZ-RJ45 Connectors	42-43
EZ-RJ45 Crimp Tools	15
EZ-SnapJacks	51
EZ-Viking Crimp Tool	16
JackAx 110 Termination Tool	29
J Hooks and J Hook Hardware	56-59
Keystone Blank Inserts	49
Keystone Coupler	49
Keystone Jacks	48-49
Maxim Strippers	8
Minim Strippers	8
Patch Panels	52-55
PRO Punchdown Tool	28
PROAMP Crimp Tool	18
PRO Drywall Saw	32
PRO-Strike Punchdown Tools	26
ProStrip 25R Coax Stripper	13
ProStrip Wire Strippers	9
Punchdown Blades	27
RECON Test Set	69
RJ11/12 Connectors	46
RJ22 Connectors	46
RJ45 Boots	44
RJ45 Cat6A 10-Gig Connectors	47
RJ45 Connectors	46-47
Screwdriver Sets	34-37
SealSmart Compression Connectors	38-40
SealSmart Crimp Tools	19-20
SealSmart Coax Strippers	12
Smart Remote Kit	66
SnapShot Tester	70
Strain Reliefs, Color Coded	44
Strain Reliefs, EZ Snag Proof	43
Telecom Splicing Connectors	31, 41
Telecom Pliers	31
Tele-Titan Crimp Tool	18
Tele-TitanXG 2.0 Crimp Tool	17
Tester Accessories	66
Tone and Probe Set	63
VDV MapMaster	64
VDV MapMaster 2.0	65, 80
Wall Plates	50
XTender Pole & Accessories	60-61

EZ-RJ45® Termination

Wire	1	2	3	4	5	6	7	8
T568A	White/Green	Green	White/Orange	Blue	White/Blue	Orange	White/Brown	Brown
T568B	White/Orange	Orange	White/Green	Blue	White/Blue	Green	White/Brown	Brown

1) Remove 1 1/2" to 2" of your cable jacket from your cable using the Cat5e/6 Cable Jacket Stripper, P/N 15015. Rotate stripper 1 to 2 turns, enough to score the jacket without cutting through it, to prevent nicking the conductors.

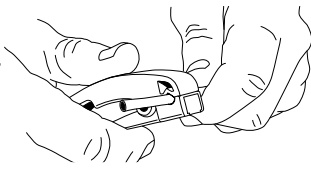

2) Bend the cable where it is scored and the cable jacket will 'pop' and break away. Remove it but do NOT throw it away. This is your FREE pair separator!

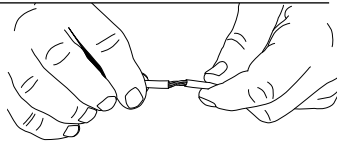

3) Separate pair ends at tip. Place your free pair separator over one of the conductor ends of each pair and push/rotate in opposite direction of the twist, separating each pair.

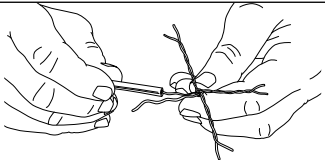

4) Straighten each pair, removing all the bends/kinks.

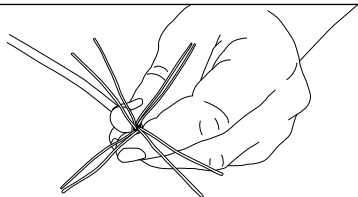

5) Determine whether you will be using the T568A or T568B configuration (above) and organize wires accordingly. Line up your wires and make a clean cut across all 8 conductors with P/N 10517 leaving approximately 1.5" of wire protruding from the jacket.

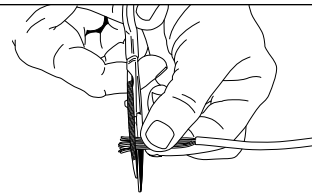

6) Slide the connector onto the wires snugging it up to the jacket. **Cat5e:** Be sure to insert cable jacket beyond the primary strain latch to assure twists are less than 1/2" from the point of termination. **Cat6:** Be sure to insert cable jacket all the way up and behind the contacts to assure twists are less than 3/16" from the point of termination.

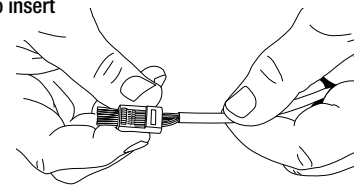

7) Crimp & trim the connector in one EZ process with P/N 100054.

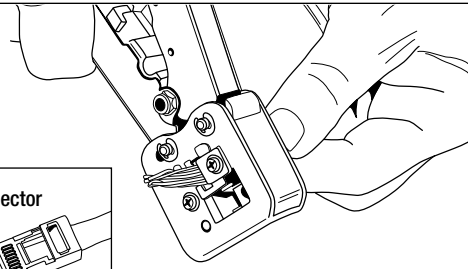

7) Crimp & trim the connector in one EZ process with P/N 100054.

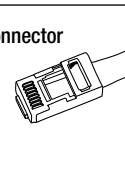

87654321

Contact Identification
Front end of EZ Connector



Terminating Connectors is as EZ as 1-2-3!

1 Strip and prepare cable slide conductors straight through EZ Connector.

Pin 1 T568A

2 Verify proper wiring order

T568A / T568B Wiring Chart

Wire	1	2	3	4	5	6	7	8
T568A	W/G	G	W/O	BL	W/BL	O	W/BR	BR
T568B	W/O	O	W/G	BL	W/BL	G	W/BR	BR

3 Crimp connector and trim excess wire in one step with the EZ-RJ45® Crimp Tool!

US/Metric Conversions

Wire Gauge Equivalents

AWG	=	mm ²
32	=	0.03
30	=	0.05
28	=	0.08
26	=	0.10
24	=	0.20
22	=	0.34
20	=	0.50
18	=	0.75
None	=	1.00
16	=	1.50
14	=	2.50
12	=	4.00
10	=	6.00
8	=	10
6	=	16
4	=	25
2	=	35
1/0	=	50
2/0	=	70
3/0	=	80
4/0	=	96-116
250 MCM	=	127
300 MCM	=	152
350 MCM	=	177
400 MCM	=	203
500 MCM	=	240
600 MCM	=	300
750 MCM	=	400
1500 MCM	=	800
2000 MCM	=	1000

Conversions

1 Inch	=	25.4 mm
1 Inch	=	2.54 cm
0.0394 Inch	=	1 mm
0.394	=	1 cm
1 Ounce	=	28.5 Grams
Degrees C	=	(Degrees F – 32) x 5/9
Degrees F	=	(Degrees C x 9/5) + 32
1 Newton (force)	=	4.448 lbs. (force)
1 lb. (force)	=	0.2248 Newtons (force)

Tips & Tricks

How to use your tools is just as important as what tool you choose for a specific application. Look for this icon throughout our catalog for field-proven ways to work smarter, faster and safer.

Have a "Tip & Trick" of your own? Want to share your idea? E-mail us at info@platinumtools.com.

Tip & Trick	Pg.
Give It The Boot	6
Measure Twice, Cut Once	10
Color Coded Strain Reliefs: What is the max cable OD?	24
Measuring Twisted Pair Cable Length	34
Reshaping The BIG Stuff	36
Combing Your Braid	39
Listen To Your Stripper	40
T568A / T568B Wiring Chart	14, 42
Pull For Performance	3



Tip & Ring Chart

Going to wire your phone system with either Cat5e or Cat6 cable but not sure what the correct color code is? This Tip & Ring Chart will help give you the right answers!

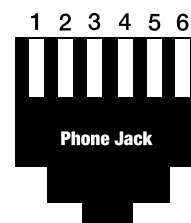

Contact Position	RJ12 (RJ25) 6P6C	RJ11 (RJ14) 6P6C	RJ11 6P2C	Pair	Tip (T) & Ring (R)	Pos (+) & Neg (-)	Cat5e & Cat6	New Color Code	Old Color Code
1	1			3	T	+	W/GR	W/GR	White
2	2	1		2	T	+	W/OR	W/OR	Black
3	3	2	1	1	R	-	BL	BL/W	Red
4	4	3	2	1	T	+	W/BL	W/BL	Green
5	5	4		2	R	-	OR	OR/W	Yellow
6	6			3	R	-	GR	GR/W	Blue

©2016 Platinum Tools, Inc. All rights reserved.

The following marks are trademarks of Platinum Tools, Inc.; 'We Make Connections EZ', SealSmart, Tele-Titan, Tele-TitanXg, EZ-Viking, PROAMP, PRO-Strike, Xtender Pole, VDV MapMaster, 4MAPPER and RECON.

The following marks are referenced: EZ-RJ45, 110 EZ-Data Cut Blade, EZ-RJPRO HD and JackAX are trademarks of SullStar Technologies, Inc.; Net Prowler, Cable Prowler, Coax Clarifier and Snap Shot are trademarks of T3 Innovation; AMP is a trademark of TE Connectivity, Ltd. Company; Kevlar is a trademark of DuPont; BIX is a trademark of Nortel; Krone is a trademark of Krone, Inc.; Maxim, Minim and Cyclops are trademarks of Tavismanor, Ltd.; BongoTies is a trademark of Gyroscope Interactive; Torx is a trademark of Camcar Corp.; Elco is a trademark of Merloni Brands KFT; HangerMate is a trademark of Acument Intellectual Propertiers, Llc.; Sammy Super Screws is a trademark of ITW Buildex & Illinois Tool Works, Inc.; Powers Vertigo is a trademark of Powers Fasteners, Inc.; SC is a trademark of NTT Advanced Technology; ST is a trademark of American Telephone & Telegraph Company; Velcro is a trademark of Velcro Industries B.V. Other products, logos and company names mentioned herein may be trademarks of their respective owners.

Reference dimensions in this catalog shown in inches, millimeters or both, are for reference purposes only. For precise and specific dimensional requirements, contact the factory.

Products in this catalog have been manufactured and engineered primarily with the US market in mind. The largest percentage of these products will be saleable in the European market but we make no claims that they meet all European requirements. If compliance is questioned per a regulation or standard on any particular product, contact your authorized Platinum Tools Distributor or your local Representative for Platinum Tools or email your Platinum Tools Team: info@platinumtools.com.

We believe the information in this catalog at the time of printing was accurate and reliable to the best of our expertise and knowledge. Its intention is to act as a guide with product(s) selection. It is not a technical reference manual or is it intended to be used as one. We do not assume any liability for any occurrence due to said use. This catalog supersedes and voids all previous catalogs.

We warranty our products to be free from defects of material and workmanship, under normal service and use, for a minimum of one year or as otherwise stated in either catalog or packaging. Platinum Tools will not be liable for any misuse or modification of its product(s) by the purchaser or purchaser's agent. Said misuse or modification will void warranty.

Platinum Tools, Inc.
2450 Turquoise Circle
Newbury Park, CA 91320
USA

Phone: **800.749.5783**

Fax: **800.749.5784**

www.platinumtools.com
info@platinumtools.com

2450 Turquoise Circle
Newbury Park, CA 91320
USA



Phone: **800.749.5783**

Fax: **800.749.5784**

www.platinumtools.com

info@platinumtools.com



P/N 15SD09 9/15 Printed in USA \$3.95