

DIP SWITCH CONFIGURATION

The Model 8083 Flush Mount Module has 4 dip switches that must be configured. The thermostat should be powered down for 90 seconds for the dip switch settings to take effect.

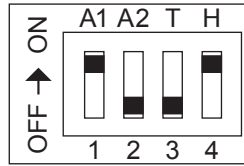

Address Selection – Dip Switch A1 and A2

Each Flush Mount Module and/or Support Module must have its own unique address. The address for the Flush Mount Module is set as shown on the diagram to the right.



Temperature and Humidity Sensor Mode – Dip Switch T and H

The T dip switch setting determines if the temperature sensor is a controlling (on) or monitoring (off) value. The H dip switch setting determines if the humidity sensor is a controlling (on) or monitoring (off) value.

If the dip switch is set to off, the thermostat will use the sensor value as a monitoring value which can be displayed on the thermostat and read over the thermostat's communication interface.

If the switch is set to on, the thermostat will consider this sensor to be a controlling value. If multiple temperature or humidity sensors are set to controlling the thermostat will average the values for control. The averaged value will also be displayed as the controlling temperature or humidity value on the thermostat.

SPECIFICATIONS

Temperature	-40 to 130°F (-40 to 55°C)
Temperature Accuracy	+/-1°F 60 to 80°F (Comfort Range) +/-2°F 40 to 100°F (Control Range)
Humidity	0% to 99% R.H. (non-condensing)
Humidity Accuracy	+/-5% R.H. 20% to 80% R.H.
Electrical	Operating Voltage 24VAC (18 to 30VAC)

AprilairePartners.com

P.O. Box 1467
Madison, WI 53701-1467
800.334.6011 F: 608.257.4357

Printed in China

©2017 Aprilaire – Division of Research Products Corporation
610001351 B2207049B 8.17

8083 Flush Mount Temperature and Humidity Module

Installation Instructions

READ AND SAVE THESE INSTRUCTIONS

FEATURES

The 8083 Flush Mount Temperature and Humidity Module can be used to remotely sense temperature and humidity in a space. When wired to any Aprilaire thermostat that features Support Module capabilities, a combination of up to four total Model 8083 Flush Mount Modules and Model 8081 TT or Model 8082 TrH Support Modules can be used to remotely monitor the temperature and humidity in various rooms or throughout a larger space. The temperature and humidity readings can also be averaged to create controlling values for the thermostat.

INSTALLATION INSTRUCTIONS

1. Select a location for mounting the module.

Locate the module as you would locate a thermostat.

- Mount on an interior wall, in a frequently occupied space.
- Keep the module 18" away from an outside wall.
- DO NOT mount the module:
 - Behind doors, in corners or other dead air spaces.
 - In direct sunlight or near lamps, appliances, dimmer switches or other sources of heat.
 - On an outside wall or wall exposed to an unconditioned space (i.e. garage).
 - In the flow path of a supply register, in stairways or near outside doors.
 - On a wall where a concealed pipe or ductwork could influence the module.
 - Near sources of electrical interference such as light switches.

Maximum wire length from the module to the thermostat is 1000 feet.

2. Remove the metal disk from the front of the module.

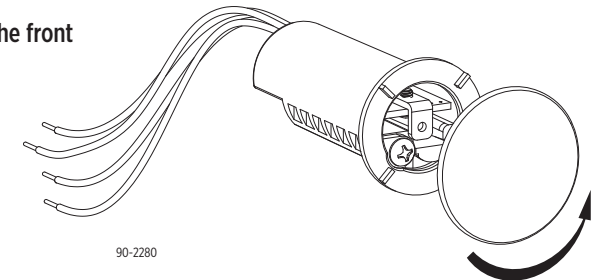

90-2280

3. Set dip switches.

First rotate the latch counter-clockwise, then slide the access door open as shown below. See **Dip Switch Configuration** for more details about the settings.

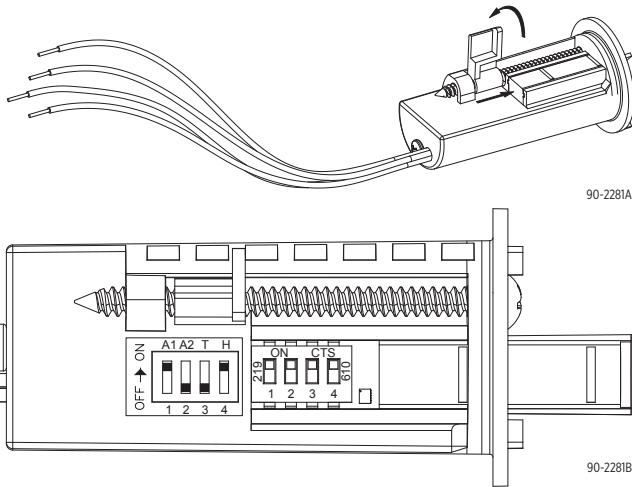

4. Drill mounting hole.

Use a 1" paddle bit to drill a 1" diameter hole in the drywall/sheetrock. Keep the drill steady and horizontal to ensure a clean finished hole.

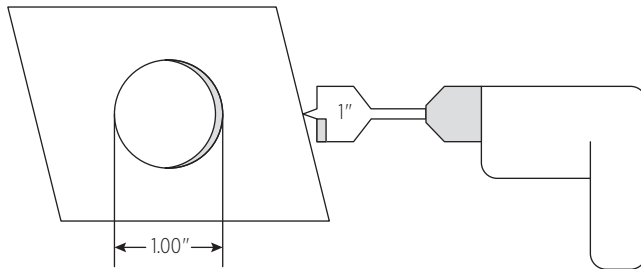

5. Wire the module to the thermostat.

Ensure power at the HVAC equipment is off. Route wire from the Model 8083 Flush Mount Module to the thermostat using Cat-5 wire. Use the supplied wire nuts to connect the wires from the thermostat to the wires on the Model 8083 Flush Mount Module.

MODEL 8083 FLUSH MOUNT MODULE TO THERMOSTAT WIRING		
8083 Module	8800 & 8820 Thermostat	8830 & 8840 Thermostat
Red	RC	1
Black	C	2
Yellow	RSA	A
Green	RSB	B

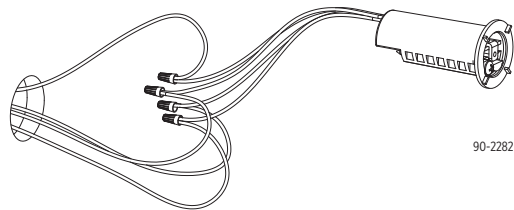

Note: For the Model 8830 and 8840 two piece thermostats, run the wire the from the Model 8083 Flush Mount Module to the thermostat, not the equipment control module.

⚠ CAUTION

Damage to components can occur if power is not disconnected.

Note:

- Do not route the wires along sources of electrical noise such as 120VAC.
- If multiple Model 8083 Flush Mount Modules and/or Support Modules are used, daisy chain the wiring. The maximum cumulative distance is 1000 feet.
- Use 1 twisted pair for RSA and RSB and another twisted pair for RC and C.

6. Insert the module into the wall.

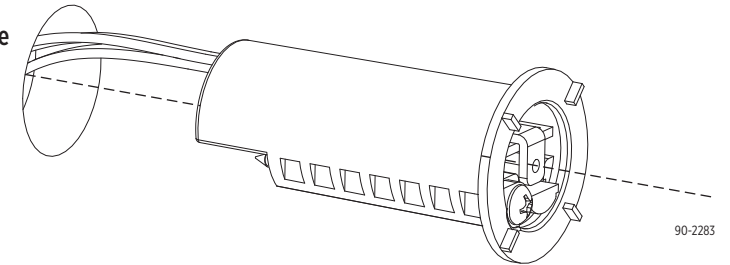

7. Tighten the screw as shown below to secure the Model 8083 Flush Mount Module in place.

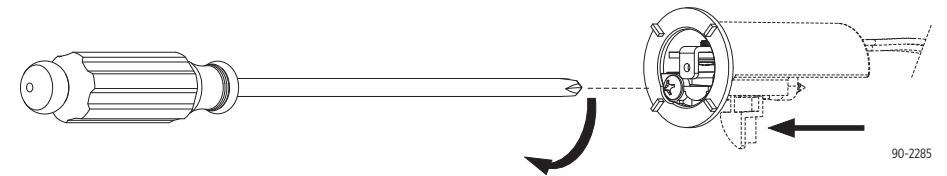

8. Reinstall the metal disk on the module. Do not overtighten!

Note: Paint or apply wallpaper to the disc prior to installing the module in the wall.

