

# MAGNASPHERE MSS-300S SERIES INSTALLATION INSTRUCTIONS: All Models of MSS300S-Series

## Required Tools and Components

### Provided by Manufacturer (per module set)

- 1 MSS-3XXS switch module
- 1 MSS-3XXS magnet module

### Provided by Installer

- Power drill
- #36 Drill Bit or 7/64
- 4 #8 (x7/8" MIN) Flat Head Screws

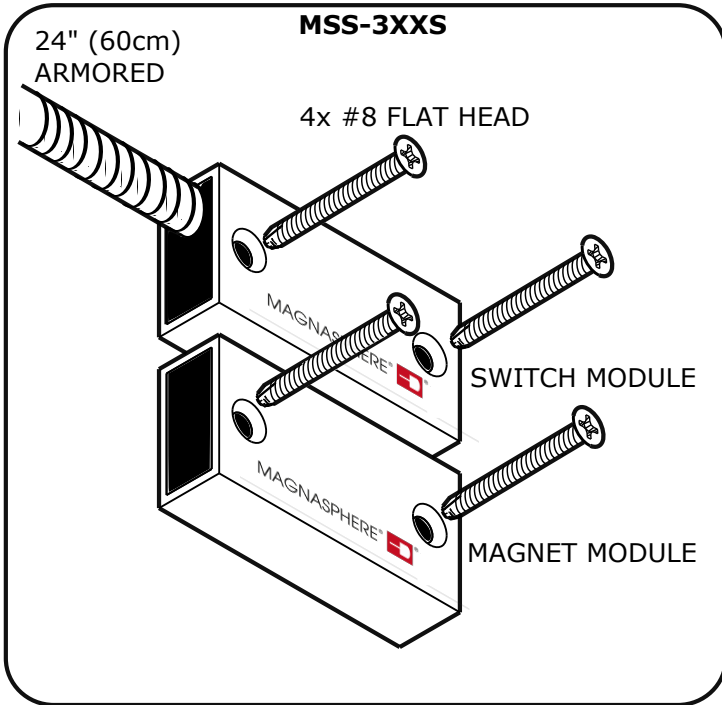

### Specifications

**Max Current:** 0.25 A Resistive  
**Max Voltage:** 30 VDC  
**Max Power:** .25 W Resistive  
 Suitable for **Indoor and Outdoor** use, for U.S. and Canadian applications. The Magnasphere MSS-3XXS series is intended to be connected to a UL Listed compatible control panel for US applications and a ULC Listed compatible control panel for Canadian applications.

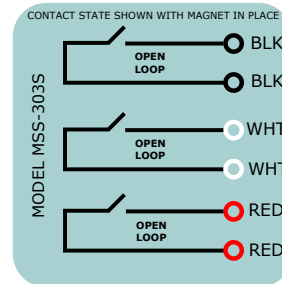
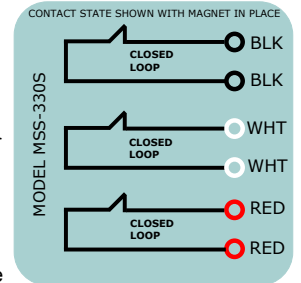

### NOMENCLATURE

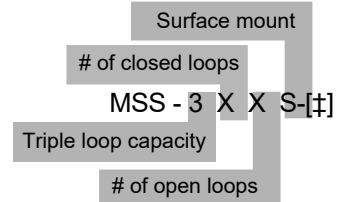

‡ See p.2 for optional embedded resistor schemes

### Installation Plan & Switch Orientation

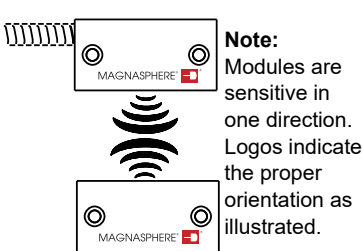

**Note:** Modules are sensitive in one direction. Logos indicate the proper orientation as illustrated.

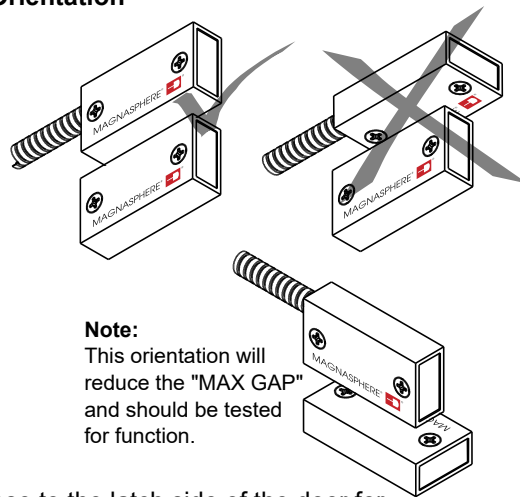

**Note:** This orientation will reduce the "MAX GAP" and should be tested for function.

### Installation:

The 3xxS should be mounted close to the latch side of the door for optimal performance. In order to meet UL 681 requirements, contact shall be installed so door cannot be opened more than 2 inches without causing an alarm. Intended for operating gaps of up to 5/16" (8mm). Ensure that the modules are well aligned. When synchronous switching of the contacts is important, position modules to operate as depicted. Hold the switch module in position and drill one pilot hole; drive the #8 screw in until the module is seated. Repeat for the second hole. Repeat these steps for the magnet module to insure accurate positioning. Wire the switch according to the schematic. Check the operation of the installed switch.

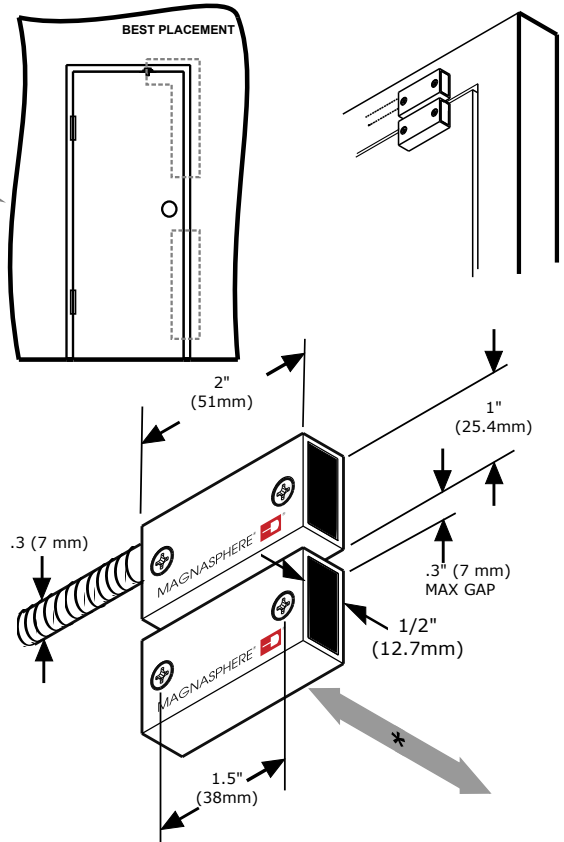

Patents #5977873, #RE39731, #6506987, #6303845, #6603378 & Other Patents Pending

05-2018 MSS-300S-INST REV. C

MAGNASPHERE®

MAGNASPHERE N22 W22931 Nancys Ct. Ste 3, Waukesha, WI 53186 tel 262.347.0711 fax 262.347.0710 www.magnasphere.com

# MAGNASPHERE MSS-300S SERIES INSTALLATION INSTRUCTIONS: Base Models and Resistor-Embedded Models of MSS-300S-Series

## Schematics: All Base Model Infixes

## End-Of-Line Resistor Standard Models ( ### suffix)

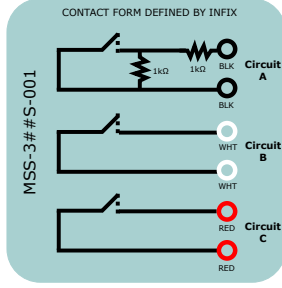
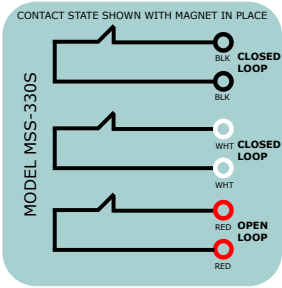
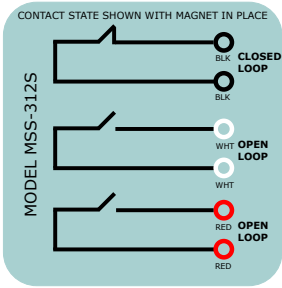
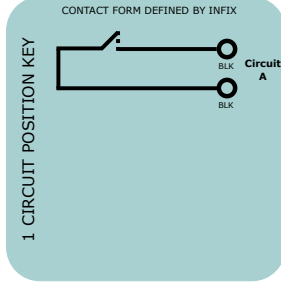
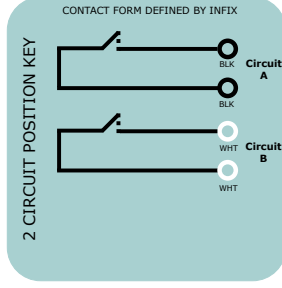
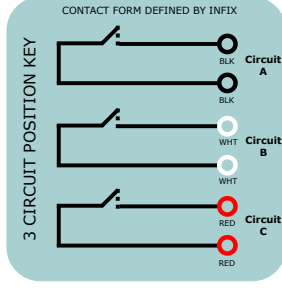
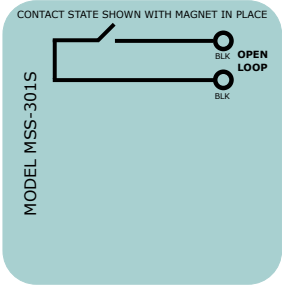
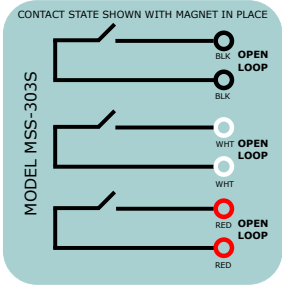

**MSS-3###S-001:**  
Series & Parallel 1k resistors on circuit A. One instance shown at right:

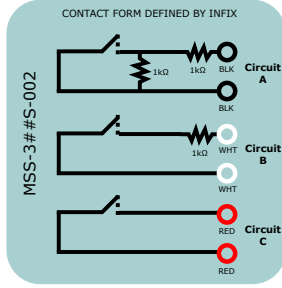
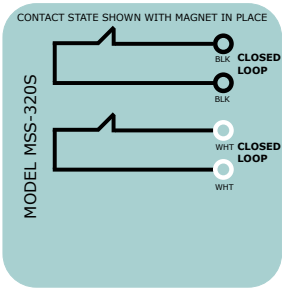
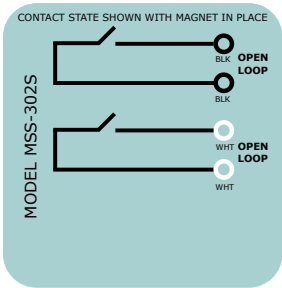
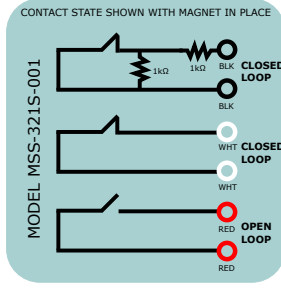

**MSS-3###S-002:**  
Series & Parallel 1k resistors on circuit A, Series 1k resistor on Circuit B. One instance shown at right:

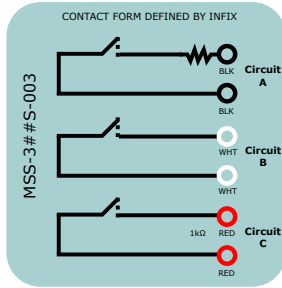
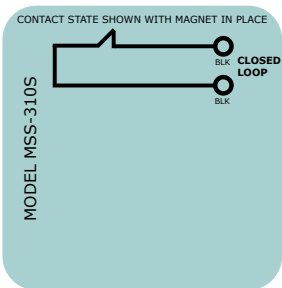
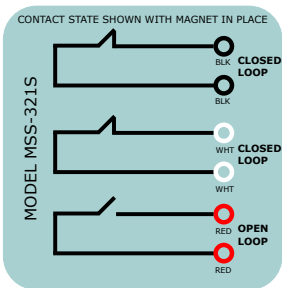
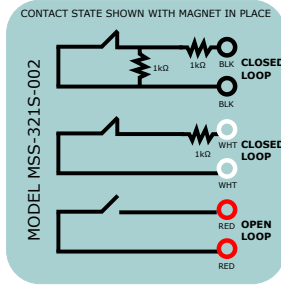

**MSS-3###S-003:**  
Series 1k resistor on Circuit A. One instance shown at right:

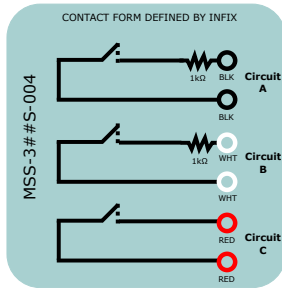
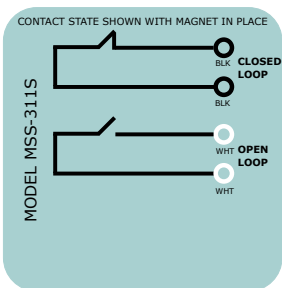
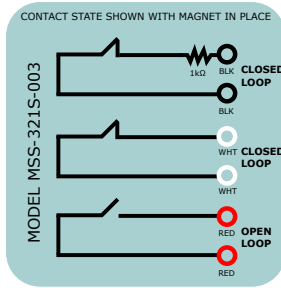

**MSS-3###S-004:**  
Series 1k resistor on Circuit A and on Circuit B. One instance shown at right:

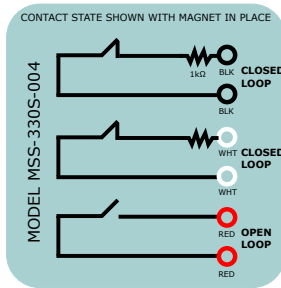

## End-Of-Line Resistor Custom Models ( -i-###-### suffix)

### i-###-### Scheme:

"i" precedes custom resistor (kΩ) values separated by hyphens. The sequence of entries correlates to the positions depicted in the key. "N" is used as a null place-holder (No resistor for this position). Contact Magnasphere for nomenclature guidance and for resistor value availability.

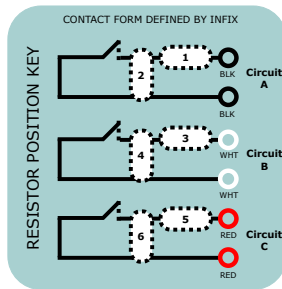

### Examples:

**MSS-321S**  
-i.18-.3-1-N-N-1  
At right.  
**MSS-330S**  
-i1-N-1-N-N-N  
as an alternate ID to MSS-330S-004, last to the right.

