

MAGNASPHERE HIGH SECURITY L1.5 INSTALLATION INSTRUCTIONS

HSL1.5-###-FIRE MODEL SERIES

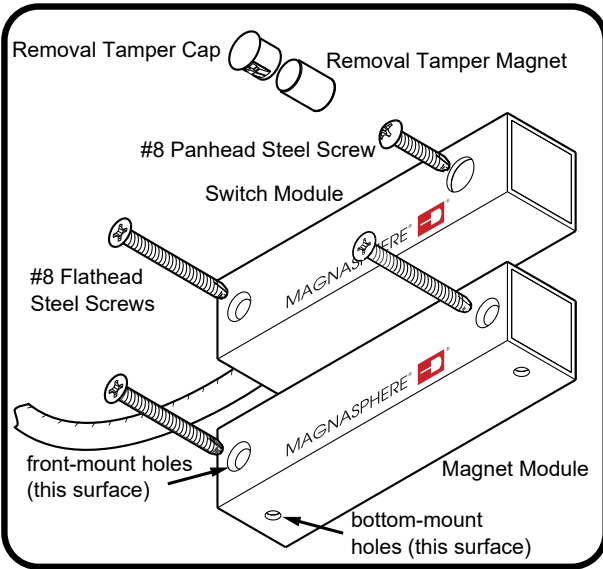

Installation:

The High Security L1.5 should be mounted close to the latch side of the door: Up to 15" (38cm) from the doorknob/door-latch edge is recommended. Intended for operating gaps of up to 1/4" (6mm).

Alignment and orientation of the switch & magnet modules is critical for proper operation. Center-to-center alignment of the modules must be within 1/8" (3mm). The labeled faces of the modules must always have the same orientation.

For UL-qualified installations, only the following depicted configurations satisfy the requirements of UL634 High Security Level 1. Note the orientation of the labeled faces and the door-swing direction.

Patents: #6506987, #6803845, #8314698, #6603378, #8228191, #8648720, #9704680, #9934921 & Other Patents Pending HSL1_5-###-FIRE INST MAY2019

Required Tools and Components

Provided by Manufacturer:
 1 High Security L1.5 Switch Module
 1 High Security L1.5 Magnet Module
 1 Removal Tamper Magnet
 2 Removal Tamper Caps
 2 Spacers, 1/16"

Provided by Installer:
 Power Drill
 9/64" (3.5mm) Dia Drill Bit
 3 x #8 x1.5" (40mm) Flathead Screws, Self-Tapping recommended
 1 x #8 x.5" (12mm) Panhead Screw, Self-Tapping recommended

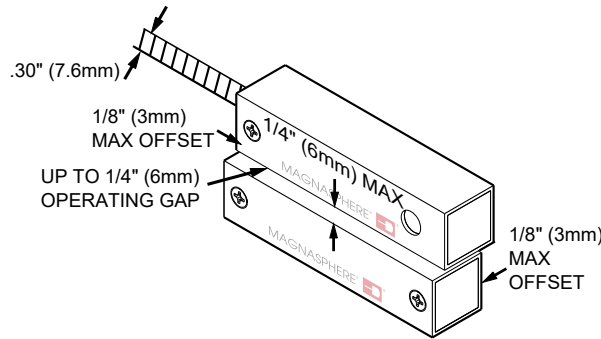

SPECIFICATIONS PER CIRCUIT:

MAXIMUM RATINGS:
 250 mA
 30 VDC RESISTIVE
 0.25 W

Suitable for Outdoor or Indoor Use
 UL Classified
 Miscellaneous Fire
 Door Accessory:
 ANSI/UL 10C Listed,
 3/4 hour rated

INSWINGING DOOR INSTALLATION

(Switch affixed to door frame. Magnet mounted to door by front-mounting holes. Labels facing horizontally outward.)

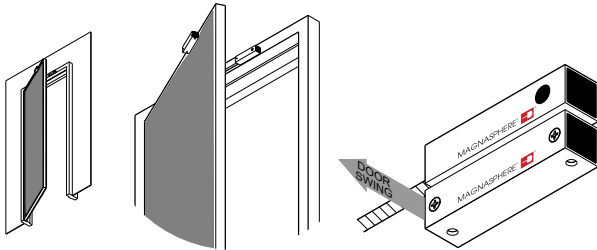

OUTSWINGING DOOR INSTALLATION

(Switch affixed to door stop. Magnet mounted to door using bottom-mount holes. Labels facing downward.)

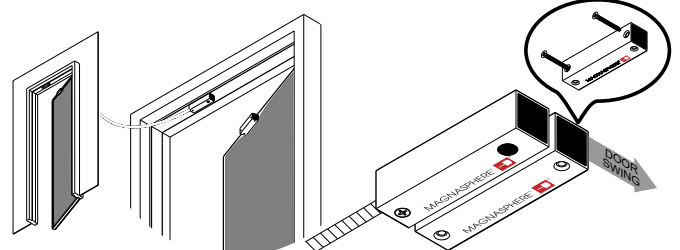

Installation: Flat-head screws are meant for all holes except for the large removal tamper in the switch module. Hold the switch module in position and drill one pilot hole; drive the #8 screw in until the module is seated. Repeat for the second hole. Maintain orientation and alignment of the modules as shown. Repeat these steps to secure the magnet module.

Wire the switch according to the schematic. Check the operation of the installed switch. The Removal Tamper circuit can be tested by withdrawing the Removal Tamper Magnet; use a magnet or piece of steel to withdraw the Removal Tamper Magnet. Insert a Removal Tamper Cap to plug the switch's large hole. The 2nd removal cap is a spare.

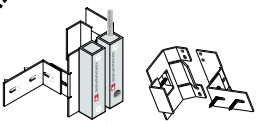

P/N: 1271
 KIT: Overhead Door Rail
 Mount Bracket for HS-L1.5

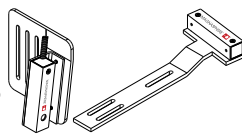

P/N: HS1452-L1.5-111 & -121
 (w/ Modules Premounted)
 KIT: Roll Up Door Bracket w/ HSL1.5-Right Side*
 P/N: HS1453-L1.5-111 & -121
 (w/ Modules Premounted)
 KIT: Roll Up Door Bracket w/ HSL1.5-Left Side*

Secure door-stop extension available for unusually narrow door-stops. (P/N 1524)

See catalog for L-Bracket (1618), Z-Bracket (1612), 1-Inch Spacer Block (1615) and other installation accessories.

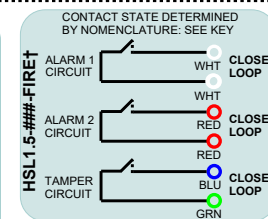
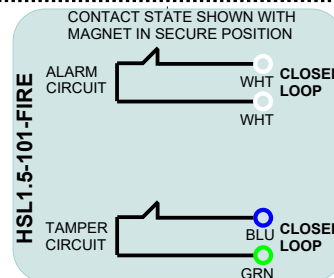
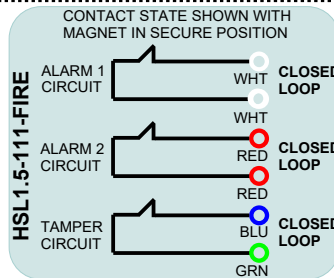
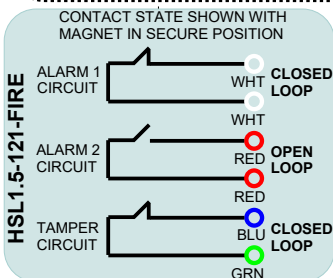

MODEL HSL1.5-###-FIRE†
 VARIANTS:

ALARM CIRCUIT 1
 ALARM CIRCUIT 2
 TAMPER CIRCUIT
 HSL1.5-# # #
 † KEY:
 "1" is Closed-Loop
 "2" is Open Loop
 "0" is Not-Equipped

