



**SILENT
KNIGHT**

by Honeywell

INTELLIKNIGHT 5820XL 5820XL-EVS

**Addressable Fire System
Emergency Voice System**

**Installation and
Operations Manual**

Document: LS10061-001SK-E

Rev: **H**

LS10061-001SK-E:H ECN: 17-0298

Fire Alarm & Emergency Communication System Limitations

While a life safety system may lower insurance rates, it is not a substitute for life and property insurance!

An automatic fire alarm system—typically made up of smoke detectors, heat detectors, manual pull stations, audible warning devices, and a fire alarm control panel (FACP) with remote notification capability—can provide early warning of a developing fire. Such a system, however, does not assure protection against property damage or loss of life resulting from a fire.

An emergency communication system—typically made up of an automatic fire alarm system (as described above) and a life safety communication system that may include an autonomous control unit (ACU), local operating console (LOC), voice communication, and other various inter-operable communication methods—can broadcast a mass notification message. Such a system, however, does not assure protection against property damage or loss of life resulting from a fire or life safety event.

The Manufacturer recommends that smoke and/or heat detectors be located throughout a protected premises following the recommendations of the current edition of the National Fire Protection Association Standard 72 (NFPA 72), manufacturer's recommendations, State and local codes, and the recommendations contained in the Guide for Proper Use of System Smoke Detectors, which is made available at no charge to all installing dealers. This document can be found at <http://www.systemsensor.com/appguides/>. A study by the Federal Emergency Management Agency (an agency of the United States government) indicated that smoke detectors may not go off in as many as 35% of all fires. While fire alarm systems are designed to provide early warning against fire, they do not guarantee warning or protection against fire. A fire alarm system may not provide timely or adequate warning, or simply may not function, for a variety of reasons:

Smoke detectors may not sense fire where smoke cannot reach the detectors such as in chimneys, in or behind walls, on roofs, or on the other side of closed doors. Smoke detectors also may not sense a fire on another level or floor of a building. A second-floor detector, for example, may not sense a first-floor or basement fire.

Particles of combustion or "smoke" from a developing fire may not reach the sensing chambers of smoke detectors because:

- Barriers such as closed or partially closed doors, walls, chimneys, even wet or humid areas may inhibit particle or smoke flow.
- Smoke particles may become "cold," stratify, and not reach the ceiling or upper walls where detectors are located.
- Smoke particles may be blown away from detectors by air outlets, such as air conditioning vents.
- Smoke particles may be drawn into air returns before reaching the detector.

The amount of "smoke" present may be insufficient to alarm smoke detectors. Smoke detectors are designed to alarm at various levels of smoke density. If such density levels are not created by a developing fire at the location of detectors, the detectors will not go into alarm.

Smoke detectors, even when working properly, have sensing limitations. Detectors that have photoelectronic sensing chambers tend to detect smoldering fires better than flaming fires, which have little visible smoke. Detectors that have ionizing-type sensing chambers tend to detect fast-flaming fires better than smoldering fires. Because fires develop in different ways and are often unpredictable in their growth, neither type of detector is necessarily best and a given type of detector may not provide adequate warning of a fire.

Smoke detectors cannot be expected to provide adequate warning of fires caused by arson, children playing with matches (especially in bedrooms), smoking in bed, and violent explosions (caused by escaping gas, improper storage of flammable materials, etc.).

Heat detectors do not sense particles of combustion and alarm only when heat on their sensors increases at a predetermined rate or reaches a predetermined level. Rate-of-rise heat detectors may be subject to reduced sensitivity over time. For this reason, the rate-of-rise feature of each detector should be tested at least once per year by a qualified fire protection specialist. Heat detectors are designed to protect property, not life.

IMPORTANT! Smoke detectors must be installed in the same room as the control panel and in rooms used by the system for the connection of alarm transmission wiring, communications, signaling, and/or power. If detectors are not so located, a developing fire may damage the alarm system, compromising its ability to report a fire.

Audible warning devices such as bells, horns, strobes, speakers and displays may not alert people if these devices are located on the other side of closed or partly open doors or are located on another floor of a building. Any warning device may fail to alert people with a disability or those who have recently consumed drugs, alcohol, or medication. Please note that:

- An emergency communication system may take priority over a fire alarm system in the event of a life safety emergency.
- Voice messaging systems must be designed to meet intelligibility requirements as defined by NFPA, local codes, and Authorities Having Jurisdiction (AHJ).
- Language and instructional requirements must be clearly disseminated on any local displays.
- Strobes can, under certain circumstances, cause seizures in people with conditions such as epilepsy.
- Studies have shown that certain people, even when they hear a fire alarm signal, do not respond to or comprehend the meaning of the signal. Audible devices, such as horns and bells, can have different tonal patterns and frequencies. It is the property owner's responsibility to conduct fire drills and other training exercises to make people aware of fire alarm signals and instruct them on the proper reaction to alarm signals.
- In rare instances, the sounding of a warning device can cause temporary or permanent hearing loss.

A life safety system will not operate without any electrical power. If AC power fails, the system will operate from standby batteries only for a specified time and only if the batteries have been properly maintained and replaced regularly.

Equipment used in the system may not be technically compatible with the control panel. It is essential to use only equipment listed for service with your control panel.

Telephone lines needed to transmit alarm signals from a premises to a central monitoring station may be out of service or temporarily disabled. For added protection against telephone line failure, backup radio transmission systems are recommended.

The most common cause of life safety system malfunction is inadequate maintenance. To keep the entire life safety system in excellent working order, ongoing maintenance is required per the manufacturer's recommendations, and UL and NFPA standards. At a minimum, the requirements of NFPA 72 shall be followed. Environments with large amounts of dust, dirt, or high air velocity require more frequent maintenance. A maintenance agreement should be arranged through the local manufacturer's representative. Maintenance should be scheduled monthly or as required by National and/or local fire codes and should be performed by authorized professional life safety system installers only. Adequate written records of all inspections should be kept.

Limit-D-1-2013

Installation Precautions

Adherence to the following will aid in problem-free installation with long-term reliability:

WARNING - Several different sources of power can be connected to the fire alarm control panel. Disconnect all sources of power before servicing. Control unit and associated equipment may be damaged by removing and/or inserting cards, modules, or interconnecting cables while the unit is energized. Do not attempt to install, service, or operate this unit until manuals are read and understood.

CAUTION - System Re-acceptance Test after Software Changes: To ensure proper system operation, this product must be tested in accordance with NFPA 72 after any programming operation or change in site-specific software. Re-acceptance testing is required after any change, addition or deletion of system components, or after any modification, repair or adjustment to system hardware or wiring. All components, circuits, system operations, or software functions known to be affected by a change must be 100% tested. In addition, to ensure that other operations are not inadvertently affected, at least 10% of initiating devices that are not directly affected by the change, up to a maximum of 50 devices, must also be tested and proper system operation verified.

This system meets NFPA requirements for operation at 0-49° C/32-120° F and at a relative humidity . However, the useful life of the system's standby batteries and the electronic components may be adversely affected by extreme temperature ranges and humidity. Therefore, it is recommended that this system and its peripherals be installed in an environment with a normal room temperature of 15-27° C/60-80° F.

Verify that wire sizes are adequate for all initiating and indicating device loops. Most devices cannot tolerate more than a 10% I.R. drop from the specified device voltage.

Like all solid state electronic devices, this system may operate erratically or can be damaged when subjected to lightning induced transients. Although no system is completely immune from lightning transients and interference, proper grounding will reduce susceptibility. Overhead or outside aerial wiring is not recommended, due to an increased susceptibility to nearby lightning strikes. Consult with the Technical Services Department if any problems are anticipated or encountered.

Disconnect AC power and batteries prior to removing or inserting circuit boards. Failure to do so can damage circuits.

Remove all electronic assemblies prior to any drilling, filing, reaming, or punching of the enclosure. When possible, make all cable entries from the sides or rear. Before making modifications, verify that they will not interfere with battery, transformer, or printed circuit board location.

Do not tighten screw terminals more than 9 in-lbs. Overtightening may damage threads, resulting in reduced terminal contact pressure and difficulty with screw terminal removal.

This system contains static-sensitive components. Always ground yourself with a proper wrist strap before handling any circuits so that static charges are removed from the body. Use static suppressive packaging to protect electronic assemblies removed from the unit.

Follow the instructions in the installation, operating, and programming manuals. These instructions must be followed to avoid damage to the control panel and associated equipment. FACP operation and reliability depend upon proper installation.

Precau-D1-9-2005

Documentation Feedback

Your feedback helps us keep our documentation up-to-date and accurate. If you have a question or encounter a problem not covered in this manual, contact Silent Knight Technical Support at 800-446-6444.

Please give the following information:

- Product name and version number (if applicable)
- Printed manual
- Topic Title
- Page number (for printed manual)
- Brief description of content you think should be improved or corrected
- Your suggestion for how to correct/improve documentation

To order parts, contact Silent Knight Sales at 800-328-0103.

Contents

Section 1

Introduction 1

- 1.1 Overview of Basic System 1
 - 1.1.1 Addressable Fire Alarm Control/Communicator Hardware Features 1
 - 1.1.2 5820XL-EVS Emergency Voice Hardware Features 1
 - 1.1.3 Software Features 2
- 1.2 About this Manual 2
 - 1.2.1 Terms Used in this Manual 2
- 1.3 Compatible Products 3
- 1.4 How to Contact Silent Knight 4

Section 2

Agency Listings, Approvals, and Requirements 1

- 2.1 Federal Communications Commission (FCC) 1
- 2.2 Underwriters Laboratories (UL) 2
 - 2.2.1 Requirements for All Installations 2
 - 2.2.2 Requirements for Central Station Fire Alarm Systems 2
 - 2.2.3 Requirements for Local Protected Fire Alarm Systems 3
 - 2.2.4 Requirements for Remote Station Protected Fire Alarm Systems 3

Section 3

Before You Begin Installation 1

- 3.1 What's in the Box? 1
- 3.2 Environmental Specifications 1
- 3.3 Electrical Specifications 2
- 3.4 Wiring Specifications 3
- 3.5 Board Assembly Diagram 5
- 3.6 Calculating Current Draw and Standby Battery 6
 - 3.6.1 Current Draw Worksheet Requirements 6
 - 3.6.2 Current Draw Worksheet for SK SLC Devices 6
 - 3.6.3 Current Draw Worksheet for SD SLC Devices 10
 - 3.6.4 Maximum Battery Standby Load 12
- 3.7 Installation Tasks Overview 12

Section 4

Control Panel Installation 1

- 4.1 Mounting the Control Panel Cabinet 1
 - 4.1.1 Preventing Water Damage 1
 - 4.1.2 Removing the 5820XL / 5820XL-EVS Assembly from the Housing 1
- 4.2 AC Connection 2

4.3	Battery Connection	2
4.3.1	RBB Accessory Cabinet	3
4.3.1.1	Installing the RBB Accessory Cabinet and Batteries	3
4.4	SBUS Wiring	4
4.4.1	Calculating Wiring Distance for SBUS Modules	5
4.4.2	Wiring Configurations	7
4.5	5860 Remote Annunciator Installation	8
4.5.1	Mounting the 5860	9
4.5.1.1	Flush Mounting	10
4.5.1.2	Surface Mounting	12
4.5.2	Model 5860 Connection to the Panel	12
4.6	5815XL Installation	12
4.6.1	5815XL Connection to the Panel	13
4.7	5824 Serial/Parallel Interface Module Installation	14
4.7.1	Selecting 5824 Options	15
4.8	5880 LED I/O Module	16
4.8.1	5880 Board Layout	16
4.8.2	5880 Connection to Panel	16
4.8.3	LED Wiring	18
4.8.4	Dry Contact Wiring	18
4.9	5865-3 / 5865-4 LED Annunciator Installation	20
4.9.1	5865 Connection to Panel	20
4.9.2	5865 Mounting	21
4.10	Configuring Modules	22
4.10.1	Assigning SBUS Module IDs	22
4.11	Telephone Connection	23
4.12	Flexputs™ I/O Circuits	23
4.12.1	Conventional Notification Appliance	23
4.12.1.1	Class B Notification Wiring	24
4.12.1.2	Class A Notification Wiring	24
4.12.2	Conventional Input Switch Circuits	25
4.12.2.1	Class B Inputs	26
4.12.2.2	Class A Inputs	26
4.12.3	Installing 2-Wire Smoke Detectors	27
4.12.3.1	Installing 2-Wire Class B Smoke Detectors	27
4.12.3.2	Installing 2-Wire Class A Smoke Detectors	28
4.12.4	Installing 4-Wire Smoke Detectors	28
4.12.4.1	Installing 4-Wire Class B Smoke Detectors	28
4.12.4.2	Installing 4-Wire Class A Smoke Detectors	29
4.12.5	Auxiliary Power Installation	30
4.12.5.1	Door Holder Power	30
4.12.5.2	Constant Power	30
4.12.5.3	Resettable Power	30
4.12.5.4	Sounder Sync Power	31
4.13	On-Board Relays (Conventional)	31
4.13.1	Trouble Relay	31
4.13.2	Programmable Relays	31
4.14	Remote Station Applications	31
4.14.1	Keltron Model 3158 Installation	31
4.14.2	City Box Connection Using the 5220 Module	32
4.14.3	NFPA 72 Polarity Reversal	33
4.14.3.1	Using the 5220 Module	33
4.14.3.2	Using the 7644-L8* Module	34
4.14.4	Using the SD500-ARM Addressable Relay Module	35

4.14.5 Using a MR-201/T Control Relay From Air Products	35
4.14.6 Transmitter Activated by Dry Contacts	37

Section 5

SK SLC Device Installation 1

5.1 List of SK SLC Devices	1
5.2 List of SD SLC Devices	2
5.3 Maximum Number of Devices	3
5.4 Wiring Requirements for SLC Devices	3
5.4.1 Wiring 5815XL in Style 4 (Class B) Configuration	3
5.4.2 Wiring 5815XL in Style 6 & 7 (Class A) Configuration	5
5.5 Wiring SK SLC Detectors	5
5.6 Addressing SK SLC Devices	6
5.7 Wiring SD SLC Detectors	7
5.8 Addressing SD Devices	8
5.8.1 SD505-PHOTO or SD505-HEAT	8
5.8.2 SLC Devices with DIP Switches	9

Section 6

Programming Overview 1

6.1 Security and Data Protection	1
6.2 JumpStart Autoprogramming	1
6.2.1 Input Points	2
6.2.2 Output Points	2
6.2.3 Running JumpStart AutoProgramming	2
6.3 Mapping Overview	4
6.3.1 Input Point Mapping	5
6.3.2 Output Circuit Mapping	6
6.3.3 Zone Event Mapping	7
6.3.4 Mapping LED Points	9
6.4 Programming Using the 5660 Silent Knight Software Suite	9
6.5 Programming Using an Annunciator	10
6.5.1 Entering / Exiting the Program Menu	10
6.5.1.1 Moving through the Menus	11
6.5.1.2 Selecting Options and Entering Data	11
6.5.1.3 Editing Keys	12
6.6 Programming Menu Quick Reference	13

Section 7

Programming 1

7.1 UL 864 / UL 2572 Programming Requirements	1
7.2 Modules	1
7.2.1 Edit Modules	2
7.2.1.1 Naming Modules	2
7.2.1.2 Editing Module Features	2
7.2.2 Adding a Module	2
7.2.3 Deleting a Module	3

7.2.4	View Module List	3
7.3	Zone	3
7.3.1	Edit Zone	3
7.3.1.1	Edit Zone Name	4
7.3.1.2	Edit Zone Properties	4
7.3.1.3	Zone Outputs	5
7.3.1.4	Cadence Patterns	7
7.3.1.5	Zone Accessory Options	8
7.3.2	Add Zone	9
7.3.3	Delete Zone	9
7.3.4	View Zone Points	9
7.4	Group	10
7.4.1	Edit Group	10
7.4.1.1	Edit Group Name	10
7.4.1.2	Edit Group Properties	11
7.4.2	Add Group	12
7.4.3	Delete Group	12
7.4.4	View Group Points	13
7.4.5	Edit Output Group Templates	13
7.5	Point	14
7.5.1	Point Programming For 5815XL Module	14
7.5.2	Point Programming For Internal or External Power Module	18
7.5.3	Point Programming For 5880, 5865, EVS-50W, EVS-INT50W, EVS-100W, EVS-125W and EVS-CE4 Modules	20
7.5.4	Point Programming For EVS-VCM and EVS-RVM Modules	20
7.5.5	Assigning a Name to Points	21
7.6	System Options	22
7.6.1	Reporting Account	22
7.6.1.1	Edit Accounts	22
7.6.1.2	Auto Test Time	24
7.6.2	Phone Lines	24
7.6.2.1	Dialing Prefix	25
7.6.2.2	Number of Answer Rings	25
7.6.2.3	Dial Option (TouchTone or Pulse)	25
7.6.2.4	Rotary Format	26
7.6.2.5	Line Monitor	26
7.6.2.6	Answering Machine Bypass	26
7.6.3	System Event Outputs	26
7.6.3.1	Trouble Events	27
7.6.3.2	System Alarm Cadence	27
7.6.4	Time Options	28
7.6.4.1	Water Flow Delay	28
7.6.4.2	Alarm Verification Time	28
7.6.4.3	Low AC Report Delay	29
7.6.4.4	Clock Display Format (AM/PM or Military)	29
7.6.4.5	Change AC Line Frequency	29
7.6.5	Miscellaneous Options	29
7.6.5.1	Synchronize Strobes Active During Silence	29
7.6.5.2	Auto Display Oldest Event	30
7.6.5.3	Report by Zone or by Point	30
7.6.5.4	Plex Door Option	30
7.6.5.5	Single Key Acknowledge	30
7.6.6	Daylight Savings	30
7.6.6.1	Automatic Daylight Savings Adjustment	30

7.6.6.2	Daylight Saving Time Start and End	30
7.6.7	Edit Banner	31
7.6.8	SLC Family	32
7.7	JumpStart Autoprogramming	32
7.8	Computer Account	33
7.9	Access Codes	33
7.9.1	Profile Edit Menu	35
7.9.1.1	Edit Name	35
7.9.1.2	Edit Access Code	35
7.9.1.3	Panel Functions	35
7.10	Voice Options	35
7.10.1	EVS-VCM Maintenance	35
7.10.1.1	PC Connection	35
7.10.1.2	Local Recording	35
7.10.2	Edit Voice Commands	35
7.10.3	EVS System Options	36
7.10.3.1	Enable EVS System	36
7.10.3.2	Edit Command Priority	37
7.10.3.3	Edit Command Mapping	37
7.10.3.4	Edit Timers	37
7.10.3.5	Edit Event Names	38

Section 8

System Operation

8.1	User and Installer Default Codes	1
8.2	Annunciator Description	1
8.2.1	LCD Display	1
8.2.2	Banner	1
8.3	Key Operation	2
8.4	Menu System	2
8.4.1	Main Menu Overview	3
8.4.2	Using the Menus	3
8.5	Basic Operation	3
8.5.1	Setting Time and Date	3
8.5.2	Disable / Enable a Point	3
8.5.2.1	Disable / Enable NACs by Template	4
8.5.3	Disable / Enable NACs by Group	4
8.5.3.1	Disable / Enable Zone Points	4
8.5.4	View Event History	4
8.5.5	To clear the event history	4
8.5.6	Conduct a Fire Drill	4
8.5.7	Conduct an Indicator Test	4
8.5.8	Conduct a Walk Test	5
8.5.9	Conduct a Dialer Test	5
8.5.10	Silence alarms or troubles	5
8.5.11	Reset alarms	5
8.5.12	Check Detector Sensitivity Through Point Status	6
8.5.13	View Status of a Point	7
8.5.14	View Alarms, Supervisories or Troubles	7
8.5.15	View System Information	7
8.5.16	Reset Items	7

8.5.16.1	Reset Dialer	7
8.5.16.2	Reset DSP USB	7
8.5.17	Communicating with a Remote Computer	7
8.5.18	Working with a Printer	9
8.6	Operation Mode Behavior	10
8.7	Releasing Operations	15
8.7.1	Single Interlock Zone Releasing	16
8.7.2	Double Interlock Zone Releasing	17
8.8	Smoke Alarm Verification	18

Section 9

Emergency Voice System Operation 1

9.1	Overview	1
9.2	LOC Functionality	1
9.2.1	Keys and LEDs	1
9.2.1.1	EVS Control Key	1
9.2.1.2	EVS Control LED	2
9.2.1.3	ALL CALL Key	2
9.2.1.4	NON-ACTIVE CALL Key	2
9.2.1.5	EVS Message Keys	2
9.2.1.6	EVS Message LEDs	2
9.2.1.7	Select Keys	2
9.2.1.8	Select Key LEDs	2
9.2.2	Gaining EVS Control	3
9.2.2.1	LOC Priority	3
9.2.2.2	LOC Lockout	3
9.2.2.3	User Profile Access Control	4
9.2.3	Manual EVS	4
9.2.3.1	Switching between Microphone Mode and Message Mode	4
9.2.3.2	Activating/Deactivating Output Groups Dynamically	4
9.2.4	Microphone Mode	4
9.2.5	Message Mode	5
9.2.6	Custom EVS Event	5
9.2.7	Passing EVS Control	5
9.2.8	Exit EVS Control Menu	5
9.2.9	Relinquish EVS Control	5
9.2.10	EVS Reset	6
9.2.11	Access Control	6
9.3	EVS Super User	6
9.4	EVS Point Functionality	6
9.4.1	EVS Point Activations	6
9.4.2	EVS-VCM Points	7
9.5	EVS 5880	7
9.5.1	EVS (1-8) 5880 Module	7
9.5.2	Enable 5880 EVS	7
9.6	EVS LOC Programming	7
9.6.1	Adding an LOC	7
9.6.2	Editing an LOC	8
9.6.2.1	LOC Priority	8
9.6.2.2	LOC Association	8
9.7	Amplifier Programming	9

9.7.1	Adding an Amplifier	9
9.7.2	Editing an Amplifier	9
9.8	Event Priority	10
9.8.1	System Control	10
9.8.2	System Override	10
9.8.3	EVS Event Priority	10
9.8.4	View Active Alarms, Troubles and Supervisory Signals	11
9.9	Using the Microphone	11
9.9.1	Microphone Functionality	11
9.9.2	Custom EVS Event	11
9.9.3	Fire Page	12
9.9.4	Emergency Page	12
9.9.5	Paging	12
9.10	Recording Custom Messages	13
9.10.1	Recording Messages 1-15 Using Aux Audio Input	14
9.10.2	Recording Messages 1-15 Using the Microphone	16
9.10.3	Erasing User Message	17
9.10.4	Using EVS Message Manager Software	18
9.11	EVS Priority	19
9.11.1	Priority Rules	19
9.12	Defining Output Group Type	20
9.13	Voice Command Mapping	21
9.13.1	Voice System Mapping	21
9.13.2	EVS Voice Aux Inputs (Dynamic with VCM/RVM in the system)	21
9.13.3	Edit Command Mapping	23
9.13.3.1	Mapping for Voice Commands	23
9.14	EVS Timer Options	24
9.14.0.2	Timers include	24
9.14.0.3	EVS Timer Menu	24

Section 10

Reporting 1

10.1	Receivers Compatible with the Control Panel	1
10.2	Reporting Formats Table	1

Section 11

Testing and Troubleshooting 1

11.1	Troubleshooting	1
11.2	Common Problems	1
11.3	Periodic Testing and Maintenance	3
11.4	Event History	3
11.5	Built-in Troubleshooting and Testing Tools	3
11.5.1	SLC Device Locator	3
11.5.2	SLC Multiple Locator	4
11.5.3	I/O Point Control	5
11.5.4	Earth Fault Resistance	6

Section 12

Installation Records1

- 12.1 Detector and Module Point Record 1
- 12.2 Conventional Output Point Record 6

Appendix A

Compatible Device1

Appendix B

Special Characters Lists1

Silent Knight Fire Product Warranty and Return Policy

Manufacturer Warranties and Limitation of Liability

IntelliKnight 5820XL Basic Operating Instructions

5820XL-EVS Basic Operating Instructions

Section 1

Introduction

The IntelliKnight 5820XL Fire Alarm Control/Communicator is an addressable fire control system that meets the requirements of UL 864.

The 5820XL/EVS integrates an Emergency Voice System that meets the requirements of UL 864 and UL 2572.

1.1 Overview of Basic System

The IntelliKnight 5820XL and 5820XL-EVS base system is packaged as an assembled stack of 3 circuit boards mounted to an aluminum housing.

1.1.1 Addressable Fire Alarm Control/Communicator Hardware Features

- The IntelliKnight 5820XL and 5820XL-EVS panel has one signaling line circuit (SLC). Up to three additional SLC loops can be added using the 5815XL SLC expander. The SLC(s) supports SK addressable detectors and modules or SD protocol detectors and modules.
- Each SLC supports 99 SK detectors and 99 SK modules for a total of 396 SK detectors and 396 SK modules per 5820XL/EVS or 127 SD devices for a total of 508 SD devices per 5820XL/EVS.
- 6.0A of output power is available through 6 sets of terminals for notification and auxiliary applications. Each circuit is power limited per UL 864 and can source up to 3.0A (total output power must not exceed 6.0A).
- Built-in dual phone line, digital alarm communicator/transmitter (DACT).
- Reports events to central station by point or by zone.
- UL Listed for pre-action and deluge releasing systems.
- Dedicated Form C trouble relay and two general purpose Form C programmable relays.
- Basic system operation can be performed using a key or a user code.
- Can be used with up to twelve Model 5860s Remote Annunciators (sold separately).
- Supports the 5865-3, 5865-4, and 5880 in any combination for a total of eight devices on one control panel.
- Printing of detector status, event history, and real time event log available through the Model 5824 Serial/Parallel Printer Interface Module (sold separately).
- Supports conventional 2-wire & 4-wire detectors using the 6 Flexput™ circuits.
- Add six Flexput™ circuits with each 5895XL Intelligent Power Module (up to eight 5895XLs per system). See note below.
- Add four notification/auxiliary power circuits with each 5496 Intelligent Power Module. See note below.

Note: The system can support a maximum of eight Intelligent Power modules, either the 5895XL or 5496, in any combination.

1.1.2 5820XL-EVS Emergency Voice Hardware Features

- The EVS-VCM has a built-in Digital Message Repeater.
- 15 EVS messages.
- Single enclosure for system control components.
- SBUS addressable amplifier. The system can support a combination of up to four EVS-50W, EVS-125W, EVS-INT50W or EVS-100W amplifiers for a maximum of 500 watts per system.
- On-board supervised microphone.
- 5820XL/EVS can support up to four EVS-RCU's (Remote Command Units).

- Up to 32 mappable speaker circuits using a combination of EVS-50W, EVS-100W, EVS-125W, EVS-INT50W and EVS-CE4's.
- Supports 25 Vrms or 70.7 Vrms speaker circuits using EVS-50W or EVS-100W.
- Supports 25 Vrms speaker circuits using EVS-125W.

1.1.3 Software Features

- Advanced smoke detector features:
 - Automatic drift compensation
 - Maintenance alert region
 - Point status meets calibrated smoke test requirements for NFPA 72
- “JumpStart” feature for easy programming.
- 125 software zones, 250 output groups.
- Non-volatile event history stores 1000 events.
- A choice of output patterns available for notification outputs, including ANSI 3.41 temporal signal.
- Built-in synchronization appliance support for AMSECO, Faraday, Gentex[®], System Sensor[®], and Wheelock[®].

1.2 About this Manual

This manual is intended to be a complete reference for all installation and operation tasks for the 5820XL* and 5820XL/EVS**. Please let us know if the manual does not meet your needs in any way. We value your feedback!

* All references to 5820XL within this manual are applicable to the 5820XL-EVS.

** Further installation instructions for the 5820XL-EVS and accessories can be found in the EVS Series installation manual P/N LS10062-001-SK-E.

1.2.1 Terms Used in this Manual

The following terminology is used with the above mentioned control panels:

Term	Description
SLC	Signaling line circuit
Module	The term module is used for all hardware devices except for SLC addressable devices and notification appliances. This includes the 5820XL/EVS panel itself and the built-in 5897 power supply. It also refers to any (optional) 5815XL SLC expansion modules.
Input Point	An addressable sensing device, such as a smoke or heat detector or a contact monitor device.
Input Zone	A protected area made up of input points.
Output Point (or “Output Circuit”)	A notification point or circuit for notification appliances. Relay circuits and auxiliary power circuits are also considered output points.
Output Group (OPG)	A group of output points. Operating characteristics are common to all output points in the group.
Output (or “Cadence”) Pattern	The pattern that the output will use, for example, Constant, March Code, ANSI 3.41. Applies to zones and special system events. See Section 7.6.3.2 for additional information.
Mapping	Mapping is the process of specifying which outputs are activated when certain events occur in the system. Section 6.3 explains mapping in detail.
EVS	Emergency Voice System.

1.3 Compatible Products

Table 1-1 lists the products available from Silent Knight for use with the 5820XL and 5820XL-EVS.

Table 1-1: 5820XL/EVS Compatible Products

Type of Device	Model	Description	
SK Addressable SLC Devices	See Section 5.1 for a list of compatible devices.		
SD Addressable SLC Devices	See Section 5.2 for a list of compatible devices.		
Other Modules	5815XL SLC Expander	Allows an additional 127 SD devices or 99 SK detectors and 99 SK modules to be added to the system. Up to three 5815XLs per system.	
	5824 Serial/Parallel Printer Interface Module	Allows a printer to be attached for the system for on-site event logging, detector status and event history reports. Two maximum per system.	
	5895XL Intelligent Power Module	Provides additional power, six Flexput™ circuits, and two Form C relays. Max. 8 per system see <i>Model 5895XL Installation Instructions P/N 151142</i> .	5895XLs and 5496s can be used in any combination, up to a total of twelve devices on one system.
	5496 Intelligent Power Module	Provides 4 additional Notification Appliance Circuits/Auxiliary power. (Up to 8 per system).	
	5860 and 5860R Remote Fire Alarm Annunciator	Same operation, similar appearance as on-board annunciator. Up to 12 5860s per system. 5860 is gray; 5860R is red.	up to a total of 12 5860s on one system.
	5860TG and 5860TR Trim Ring Kit	Trim ring kits for surface mounting the 5860 annunciator. 5860TG is gray; 5860TR is red.	
	5865-3 and 5865-4 LED Annunciator	LED annunciator can display up to 30 LEDs (15 red and 15 yellow). 5865-4 has key switches for silence and reset, and a system trouble LED.	5865-3, 5865-4, and 5880 can be used in any combination, up to a total of eight devices on one panel.
	5880 LED I/O Module	Driver for up to 40 LEDs. Interfaces with customized annunciator boards. In addition, the 5880 has eight generic switch input points.	
	5883 General Purpose Relay Module	Provides 10 Form C relays. Designed to be driven by the 5880. Up to four, 5883s can be used with each 5880 module.	
	EVS-VCM	Voice Control Module used with the 5820XL-EVS.	For use with 5820XL-EVS only. Refer to the <i>EVS-Series Installation Manual P/N LS10062-001SK-E</i> for more information on these accessories.
	EVS-SW24	24 switch expander used with the 5820XL-EVS.	
	EVS-50W	50 watt audio amplifier.	
	EVS-125W	125 watt audio amplifier.	
	EVS-100W	50/100 watt Intelligent amplifier	
	EVS-50WBU	External backup amplifier	
	EVS-CE4	Provides 4 additional audio circuits for the EVS-50W or EVS-125W.	
	EVS-INT50W	50 watt Internal amplifier	
EVS-RVM	Remote Voice Microphone used with the 5820XL-EVS.		
Misc.	7860 Telephone Cord	RJ31X cord for connecting phone line to the 5820XL/EVS.	
	5660 Silent Knight Software Suite (SKSS)	"For communication and panel programming with a Windows-based computer. Remote access requires a modem." (not sold by Silent Knight, see Table 1-2 for compatible modems). Enables remote viewing of detector status and event history.	
	5670 Silent Knight Software Suite (SKSS)	Facility management software. For remote viewing of detector status and event history. Remote access requires a modem (not sold by Silent Knight).	
	RBB	Remote Battery Box for mounting backup batteries that are too large to fit into the main FACP cabinet. Dim.: 16" W x 10" H x 6" D (40.64 cm W x 25.4 cm H x 15.24 cm D)	

The following modems have been tested by Silent Knight for compatibility with the IntelliKnight 5820XL and 5820XL-EVS and the Silent Knight Software Suite software packages:

Table 1-2: Compatible Modems

Manufacturer	Model
US Robotics	28.8
Motorola	LifeStyle
	28.8, 3400 series
	Premier 33.6
MultiTech	MT19321ZDX

Section 2

Agency Listings, Approvals, and Requirements

2.1 Federal Communications Commission (FCC)

- The following information must be provided to the telephone company before the 5820XL or 5820XL-EVS can be connected to the phone lines:

A	Manufacturer:	Silent Knight by Honeywell
B	Model Number:	IntelliKnight 5820XL and 5820XL-EVS
C	FCC registration number:	AC6USA-23901-AL-E
	Ringer equivalence:	0.8B
D	Type of jack:	RJ31X
E	Facility Interface Codes:	Loop Start: 02LS2
F	Service Order Code:	9.0F

This equipment complies with Part 68 of the FCC rules and the requirements adopted by ACTA. On the inside cover of this equipment is a label that contains, among other information, a product identifier. If requested, this information must be provided to the telephone company.

A plug and jack used to connect this equipment to the premises wiring and telephone network must comply with the applicable FCC Part 68 rules and requirements adopted by the ACTA. A compliant telephone cord (not provided) and modular jack must be utilized with this product. It is designed to be used with a modular jack that is also compliant.

The REN (ringer equivalence number) provided on this installation sheet is used to determine the number of devices that may be connected to the public switched telephone network. This number must not exceed 5.0. Since this product has an REN of .8, the number of devices is limited. The REN number is embedded in the FCC registration number as 10B.

If the 5820XL or 5820XL-EVS causes harm to the telephone network, the telephone company will notify you in advance that the temporarily discontinuance of service may be required. But if advance notice is not practical, the telephone company will notify the customer as soon as possible. Also, you will be advised of your right to file a complaint with the FCC if you believe it is necessary.

The telephone company may make changes in its facilities, equipment, operations or procedures that could affect the operation of the equipment. If this happens the telephone company will provide advance notice in order for you to make necessary modifications to maintain uninterrupted service.

If trouble is experienced with the 5820XL or 5820XL-EVS, for repair or warranty information, please contact Silent Knight at 1-800-328-0103 or www.silentknight.com. If the equipment is causing harm to the telephone network, the telephone company may request that you disconnect the 5820XL or 5820XL-EVS until the problem has been resolved.

This product cannot be adjusted or repaired in the field. It must be returned to the factory for service.

This equipment is not designed for use with party line service. Connection to party line service is subject to state tariffs. You may contact the state public utility commission, public service commission or corporation commission for information.

Since the 5820XL/5820XL-EVS is a commercial fire alarm panel, it must be connected upstream of all other equipment utilizing the phone lines. If you have questions about the installation, contact your telephone company

or a qualified installer.

Warning

This device has been verified to comply with FCC Rules Part 15. Operation is subject to the following conditions: (1) This device may not cause radio interference, and (2) This device must accept any interference received, including interference that may cause undesired operation.

2.2 Underwriters Laboratories (UL)

2.2.1 Requirements for All Installations

General requirements are described in this section. When installing an individual device, refer to the specific section of the manual for additional requirements. The following subsections list specific requirements for each type of installation (for example, Central Station Fire Alarm systems, Local Protected Fire Alarm systems, and so on). See Section 8.7 for information on releasing operation.

1. All field wiring must be installed in accordance with NFPA 70 National Electric Code.
2. Use the addressable smoke detectors specified in Section 5.2 (SD devices) or Section 5.1 (SK devices) of this manual and/or conventional detectors listed in the compatibility chart. (See Appendix A).
3. Use UL listed notification appliances compatible with the 5820XL/EVS from those specified in *Appendix A* of this manual.
4. A full system checkout must be performed any time the panel is programmed.

Restricted Options:

- The loss of AC signal is defaulted to 3 hours, however the system allows settings from 0 - 30 hours. For UL certified installations this number must be set from 1 to 3 hours.
- The system allows the use of non-latching spot type smoke detectors. This feature may not be used in commercial applications whereby a general alarm is sounded. It is intended for elevator recall, door holding applications, and hotel/motel room applications.
- The system allows the Alarm Verification time to be set from 1 to 255 seconds. For UL certified installations the setting must be a minimum of 60 seconds.
- Call forwarding shall not be used.
- When two count is used: detector spacing shall be cut in half, you shall not use the alarm verification feature, and no delay shall be used.
- P.A.S. (positive alarm sequence) feature shall be used only with automatic detectors.

2.2.2 Requirements for Central Station Fire Alarm Systems

1. Use both phone lines. Enable phone line monitors for both lines.
2. You must program a phone number and a test time so that the 5820XL/5820XL-EVS sends an automatic daily test to the central station.
3. The AC Loss Hours option must be set from 1-3 hours.
4. The Attempts to Report option must be set for 5.

2.2.3 Requirements for Local Protected Fire Alarm Systems

At least one UL listed supervised notification appliance must be used.

2.2.4 Requirements for Remote Station Protected Fire Alarm Systems

1. Do not exceed the current draw load restrictions shown in Section 3.6.
2. The AC Loss Hours option must be set from 15-30 hours.

Section 3

Before You Begin Installation

This section of the manual is intended to help you plan your tasks to facilitate a smooth installation. Please read this section thoroughly, especially if you are installing a 5820XL/EVS panel for the first time.

3.1 What's in the Box?

The IntelliKnight 5820XL ships with the following hardware:

- A cabinet with all hardware assembled
- Two keys for the front door
- Two keys for user operation of the on-board annunciator (installer operations require the Installer's Code)
- Ten 4.7K ohm end-of-line resistors
- A battery cable for batteries wired in series

The IntelliKnight 5820XL-EVS ships with the following hardware:

- A cabinet with all hardware assembled
- Two keys for the front door
- Two keys for user operation of the on-board annunciator (installer operations require the Installer's Code)
- Ten 4.7K ohm end-of-line resistors
- A battery cable for batteries wired in series
- Ten 15K ohm end-of-line resistors
- EVS-VCM Voice Control Module
- Supervised microphone

3.2 Environmental Specifications

It is important to protect the IntelliKnight 5820XL/5820XL-EVS control panel from water. To prevent water damage, the following precautions should be FOLLOWED when installing the units:

- Intended for indoor use in dry locations only
- Do not mount directly on exterior walls, especially masonry walls (condensation)
- Do not mount directly on exterior walls below grade (condensation)
- Protect from plumbing leaks
- Protect from splash caused by sprinkler system inspection ports
- Do not mount in areas with humidity-generating equipment (such as dryers, production machinery)

When selecting a location to mount the IntelliKnight 5820XL/ 5820XL-EVS control panel, the unit should be mounted where it will NOT be exposed to: temperatures outside the range of 0°C-49°C (32°F-120°F) or humidity exceeding 93% noncondensing.

3.3 Electrical Specifications

Table 3-1: Terminal Descriptions and Electrical Specification

Terminal # and Label		Description	Rating		Earth Ground Faults	
			Voltage	Current		
1	L	AC input (hot)	120 VAC, 60 Hz	2.7 A	N/A	
2		Earth ground	N/A	N/A	N/A	
3	N	AC input (neutral)	120 VAC, 60 Hz	2.7 A	N/A	
4	X	*I/O 6	Flexput™ Circuits	24 VDC	3.0A notification and auxiliary power circuits 100 mA for initiation circuits	0Ω
5	O					
6	X	*I/O 5	Flexput™ Circuits	24 VDC	3.0A notification and auxiliary power circuits 100 mA for initiation circuits	0Ω
7	O					
8	X	*I/O 4	Flexput™ Circuits	24 VDC	3.0A notification and auxiliary power circuits 100 mA for initiation circuits	0Ω
9	O					
10	X	*I/O 3	Flexput™ Circuits	24 VDC	3.0A notification and auxiliary power circuits 100 mA for initiation circuits	0Ω
11	O					
12	X	*I/O 2	Flexput™ Circuits	24 VDC	3.0A notification and auxiliary power circuits 100 mA for initiation circuits	0Ω
13	O					
14	X	*I/O 1	Flexput™ Circuits	24 VDC	3.0A notification and auxiliary power circuits 100 mA for initiation circuits	0Ω
15	O					
16	B	SBUS OUT	SBUS communication	5 VDC	100 mA	0Ω
17	A					
18	+		SBUS power	24 VDC	1.0 A	
19	-					
20	B	SBUS IN	Used for Class A installations			0Ω
21	A					
22	+					
23	-					
24	N.C.	RELAY 1	General Purpose Relay 1	24 VDC	2.5 A, resistive	N/A
25	C					
26	N.O.					
27	N.C.	RELAY 2	General Purpose Relay 2	24 VDC	2.5 A, resistive	N/A
28	C					
29	N.O.					
30	N.C.	TROUBLE	Trouble Relay	24 VDC	2.5 A, resistive	N/A
31	C					
32	N.O.					
33	SC-	L1 SLC OUT	SLC terminals	32 VDC	150 mA	0Ω
34	SC+					

* Regulated for NAC circuits, special applications when used for releasing or auxiliary power circuits

Table 3-1: Terminal Descriptions and Electrical Specification

Terminal # and Label			Description	Rating		Earth Ground Faults
				Voltage	Current	
35	SC-	L2 SLC IN	Used for Class A installations			0Ω
36	SC+					
37	Ring	Phone Line 1 Telco Ring	N/A		0Ω	
38	Tip	Phone Line 1 Telco Tip				
39	Ring	Phone Line 1 Premises Ring				
40	Tip	Phone Line 1 Premises Tip				
41	Ring	Phone Line 2 Telco Ring	N/A		0Ω	
42	Tip	Phone Line 2 Telco Tip				
43	Ring	Phone Line 2 Premises Ring				
44	Tip	Phone Line 2 Premises Tip				
45	SC-	SLC Programming Terminal (-)	32 VDC	150 mA	0Ω	
46	SC+	SLC Programming Terminal (+)	32 VDC	150 mA		

3.4 Wiring Specifications

Induced noise (transfer of electrical energy from one wire to another) can interfere with telephone communication or cause false alarms. To avoid induced noise, follow these guidelines:

- Isolate input wiring from high current output and power wiring. Do not pull one multi-conductor cable for the entire panel. Instead, separate the wiring as follows:

High voltage	AC power, Terminals 1-3
SLC loops	Terminals 33-36
Audio input/output	Phone line circuits, Terminals 37-44
Notification circuits	Terminals 4-15
SBUS	Terminals 16-23
Relay circuits	Terminals 24-32

- Do not pull wires from different groups through the same conduit. If you must run them together, do so for as short a distance as possible or use shielded cable. Connect the shield to earth ground at the panel. You must route high and low voltages separately.
- Route the wiring around the inside perimeter of the cabinet. It should not cross the circuit board where it could induce noise into the sensitive microelectronics or pick up unwanted RF noise from the high speed circuits. See Figure 3-1 for an example.
- High frequency noise, such as that produced by the inductive reactance of a speaker or bell, can also be reduced by running the wire through ferrite shield beads or by wrapping it around a ferrite toroid.

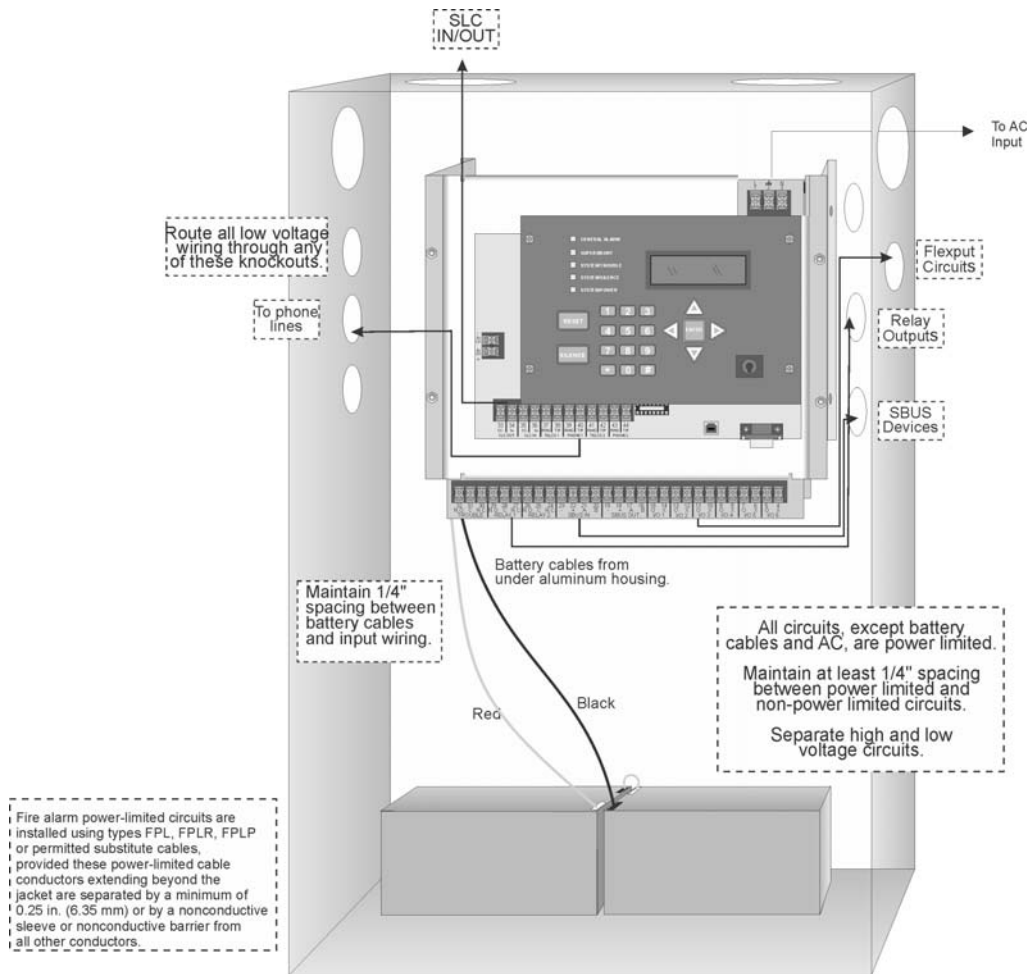

Figure 3-1 Wire Routing Example

3.5 Board Assembly Diagram

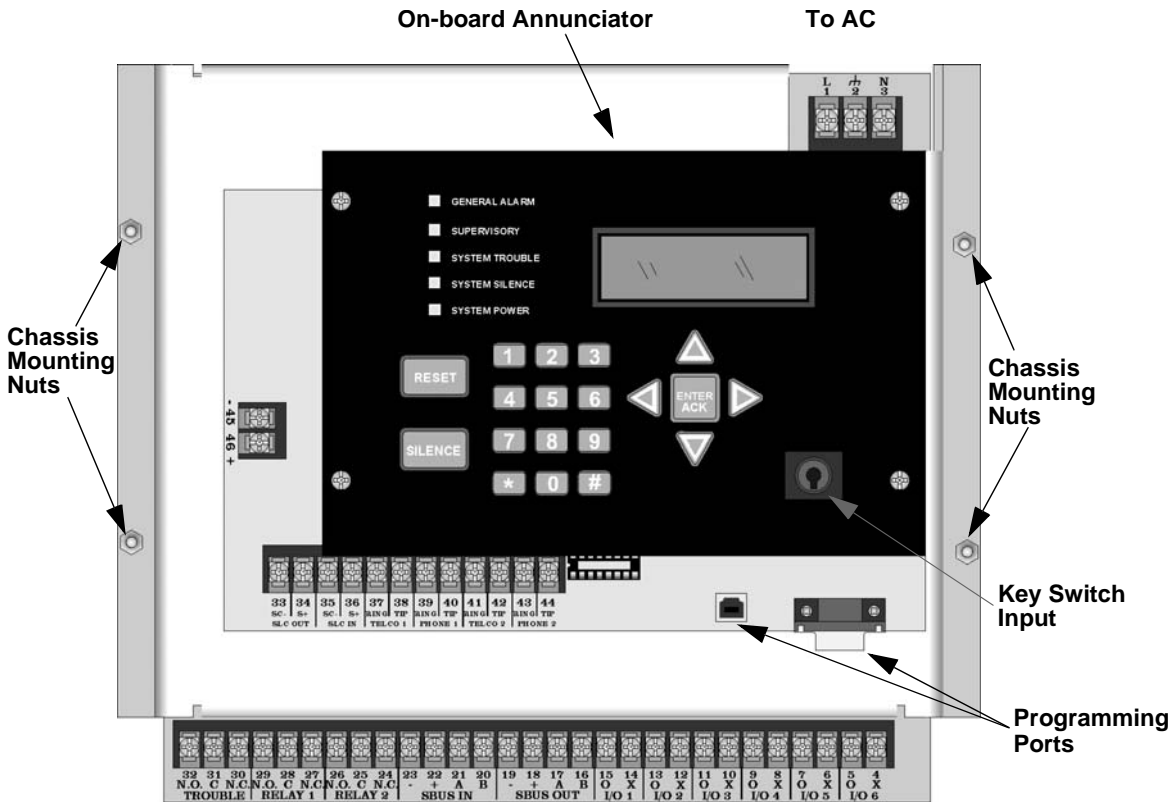

Figure 3-2 Model 5820XL / 5820XL-EVS Assembly

Figure 3-2 shows the circuit boards, metal housing and annunciator that attach the 5820XL / 5820XL-EVS assembly to the cabinet. If you should need to remove the board assembly for repair, remove the four mounting nuts which hold the assembly in the cabinet. Then lift the entire assembly out of the cabinet. Do not attempt to remove the circuit boards from the metal bracket.

3.6 Calculating Current Draw and Standby Battery

This section is for helping you determine the current draw and standby battery needs if you are using SK addressable devices (Table 3-2) or SD addressable devices (Table 3-3).

3.6.1 Current Draw Worksheet Requirements

The following steps must be taken when determining 5820XL/5820XL-EVS current draw and standby battery requirements.

1. You will use the Current Draw Worksheet to determine current draw and standby battery requirements. Use Table 3-2 if installing SK SLC Devices and Table 3-3 if installing SD SLC Devices. For the 5820XL / 5820XL-EVS, the worst case current draw is listed for the panel, addressable devices, and all SBUS expanders. Fill in the number of addressable devices and expanders that will be used in the system and compute the current draw requirements for alarm and standby. Record this information in the Current Draw Worksheet on Line A.
2. Add up the current draw for all auxiliary devices and record in the table on Line B.
3. Add up the current draw for all notification appliances and record in the table on Line C.
4. For notification appliances and auxiliary devices not mentioned in the manual, refer to the device manual for the current ratings.
5. Make sure that the total alarm current you calculated, including current for the panel itself, does not exceed 6.0 A. This is the maximum alarm current for the 5820XL / 5820XL-EVS control panel.

If the current is above 6.0 A you will need to use a notification power expander(s) such as the Silent Knight 5495 or the 5895XL intelligent power expander, to distribute the power loads so that the 5820XL / 5820XL-EVS or the power expanders do not exceed their power ratings. Refer to the current draw worksheets provided with the 5495 or the 5895XL manuals so you do not exceed their power ratings.

6. Complete the remaining instructions in the appropriate Current Draw Worksheet for determining battery size requirements.

3.6.2 Current Draw Worksheet for SK SLC Devices

Use to determine current requirements during alarm/battery standby operation SK SLC devices are installed. when SD SLC devices are installed. You can install up 99 SK detectors SD per loop (396 points max per panel) and 99 SK modules per loop (396 points max per panel). Copy this section if additional space is required.

Table 3-2 Current Draw Worksheet for SK SLC Devices

Device	# of Devices	Current per Device	Standby Current	Alarm Current
For each device use this formula: This column X This column = Current per number of devices.				
Fire Panel (battery current draw)	1	Standby:	275 mA	275 mA
		Alarm:	440 mA	440 mA

Table 3-2 Current Draw Worksheet for SK SLC Devices

Device	# of Devices	Current per Device	Standby Current	Alarm Current	
Addressable SLC Detectors					
SK-PHOTO	(99 max/loop & 396 max/ panel) ¹	Standby/Alarm: .30 mA ⁶	mA	mA	
SK-PHOTO-T			mA	mA	
SK-HEAT			mA	mA	
SK-HEAT-HT			mA	mA	
SK-ACCLIMATE			mA	mA	
SK-HEAT-ROR			mA	mA	
SK-DUCT ⁵ (includes PhotoR)			mA	mA	
SK-BEAM (without integral test)		SLC	Standby/Alarm: 2 mA		
		Aux. Pwr	Standby: 2 mA	mA	
SK-BEAM-T ⁴ (with integral test)			Alarm: 8.5 mA		mA
		SLC	Standby/Alarm: 2 mA		
SK-FIRE-CO		Aux. Pwr	Standby: 2 mA	mA	
			Alarm: 8.5 mA		mA
SK-FIRE-CO	SLC	Standby: .30mA	mA		
		Alarm: 7.2mA		mA	
Addressable SLC Module					
SK-MONITOR	(99 max/loop & 396 max/ panel) ¹	Standby/Alarm: .375 mA	mA	mA	
SK-MINIMON			mA	mA	
SK-PULL-SA			mA	mA	
SK-PULL-DA			mA	mA	
SK-MONITOR-2		Standby/Alarm: .75 mA	mA	mA	
SK-MON-10		Standby/Alarm: 3.5 mA	mA	mA	
SK-CONTROL		SLC	Standby: 2.25 mA	mA	
			Alarm: 2.25 mA		mA
		Aux Pwr	Standby: 1.7 mA	mA	
			Alarm: 7 mA		mA
SK-CONTROL-6		SLC	Standby: 2.25 mA	mA	
			Alarm: 2.25 mA		
		Aux Pwr	Standby: 8 mA	mA	
		Alarm: 20 mA		mA	
SK-RELAY	Standby/Alarm: .255 mA	mA	mA		
SK-RELAY-6	Standby/Alarm: 1.45 mA	mA	mA		
SK-RELAYMON-2	Standby: 1.3 mA	mA			
	Alarm: 24 mA		mA		
SK-ZONE	Aux Pwr	Standby 12 mA	mA		
		Alarm 90 mA		mA	
SK-ZONE-6	SLC	Standby/Alarm .27 mA	mA	mA	
	Aux Pwr	Standby 50 mA	mA		
		Alarm 270 mA		mA	
	SLC	Standby/Alarm 2 mA	mA	mA	

Table 3-2 Current Draw Worksheet for SK SLC Devices

Device	# of Devices	Current per Device		Standby Current	Alarm Current	
SLC Modules						
B200SR Sounder Base	(99 max/loop & 396 max/panel)	Aux Pwr	Standby:	.50 mA	mA	
			Alarm:	35 mA		mA
B200S Sounder Base		SLC	Standby	.30 mA	mA	
			Aux	Standby	.50 mA	mA
B200SR-LF Low Frequency Sounder Base		SLC	Alarm (high vol)	35 mA		mA
			Aux Pwr	Standby:	1 mA	mA
B200S-LF Low Frequency Sounder Base		SLC	Alarm:	125 mA		mA
			Aux	Standby	.55 mA	mA
B224RB Relay Base		SLC	Alarm (high vol)	140 mA		mA
			Standby	.30 mA	mA	
RTS151/151 KEY		Standby/Alarm:	0.5 mA	mA	mA	
RA100Z		Alarm:	7.5 mA		mA	
		Alarm:	10 mA		mA	
SLC Isolator Devices						
SK-ISO (Isolator Module)	(100 max/loop & max/panel)	Standby/Alarm:	.45 mA	mA	mA	
ISO-6 (6 Fault Isolator Module)		Standby: (per circuit)	.45 mA	mA		
		Alarm: (per circuit)	17 mA		mA	
B224BI Isolator Base		Standby/Alarm:	.5 mA	mA	mA	
Accessories Modules						
5815XL SLC Expander	(3 max.)	Standby/Alarm:	55 mA	mA	mA	
5860 Remote Fire Alarm Annunciator * EVS-RCU contains one 5860 and must be added to the calculation here.	(12 max.)	Standby:	20 mA	mA		
		Alarm:	25 mA		mA	
5824 Serial/Parallel Printer Interface Module	(2 max.)	Standby/Alarm:	45 mA	mA	mA	
5496 Intelligent Power Module	(8 max.)	Standby/Alarm:	10 mA	mA	mA	
5895XL IntelliKnight Power Module		Standby/Alarm:	10 mA	mA	mA	
5865-4 LED Annunciator (with reset and silence switches)	(8 max.)	Standby:	35 mA	mA		
		Alarm:	145 mA		mA	
5865-3 LED Annunciator		Standby:	35 mA	mA		
		Alarm:	145 mA		mA	
5880 I/O Module		Standby:	35 mA	mA		
		Alarm:	200 mA		mA	
5883 Relay Interface	(32 max.)	Standby:	0 mA	mA		
		Alarm:	220 mA (22 mA per relay)		mA	
EVS-VCM Voice Control Module	(1 max.)	Standby:	70 mA	mA		
		Alarm:	100 mA		mA	
EVS-SW24 Switch Expander	(5 max.)	Standby:	10 mA	mA		
		Alarm:	25 mA		mA	
EVS-50W or EVS-125W Audio Amplifier with/without EVS-CE4	(4 max.)	Standby:	10 mA	mA		
		Alarm:	10 mA		mA	

Table 3-2 Current Draw Worksheet for SK SLC Devices

Device	# of Devices	Current per Device	Standby Current	Alarm Current
EVS-INT50W Internal Amplifier	(4 max.)	Standby: 52 mA	mA	
		Alarm @ 25V: 275 mA		mA
		Alarm @ 70V: 310 mA		mA
Notification Devices	Refer to devices manual for number of devices and current rating.			
EVS-RVM Remote Voice Module * The EVS-RCU contains one EVS-RVM and must be added to the calculation here	(4 max.)	Standby: 70 mA	mA	
		Alarm: 100 mA		mA
EVS-100W 100W amplifier	(4 max.)	Standby/Alarm: 10 mA	mA	mA
EVS-100WBU backup daughter card	(4 max.)	Standby/Alarm: 10 mA	mA	mA
Total System Current				
Auxiliary Devices ²	Refer to devices manual for current rating.			
IPDACT-2 IP Communicator		Alarm: 136 mA		mA
		Standby: 93 mA	mA	
IPDACT-2UD IP Communicator		Alarm: 155 mA		mA
		Standby: 98 mA	mA	
		Alarm/Standby: mA	mA	mA
		Alarm/Standby: mA	mA	mA
		Alarm/Standby: mA	mA	mA
		Alarm/Standby: mA	mA	mA
Auxiliary Devices Current				
Notification Appliance Circuits	Refer to device manual for current rating.			
5495/5499 Power Supply	24 VDC	One input circuit: 15 mA		mA
		Both input circuits: 30 mA		mA
		Alarm: mA		mA
		Alarm: mA		mA
		Alarm: mA		mA
		Alarm: mA		mA
Notification Appliances Current				mA
Total current ratings of all devices in system (line A + line B + C)			mA	mA
Total current ratings converted to amperes (line D x .001):			A	A
Number of standby hours:			H	
Multiply lines E and F. Total standby AH			AH	
Alarm sounding period in hours. (For example, 5 minutes = .0833 hours)				H
Multiply lines E and H. Total alarm AH				AH
Add lines G and I. ³ Total ampere hours required			AH	

1. Total does not include isolator devices or accessory bases.
2. If using door holders, you do not need to consider door holder current for alarm/battery standby, because power is removed during that time. However, during normal operation, door holders draw current and must be included in the 6.0A total current that can be drawn from the panel.
3. Use next size battery with capacity greater than required.
4. SK-BEAM-T draws a maximum of 500mA from Auxiliary power only when the test feature is used. this should be considered when determining auxiliary power capacity but not calculated into current requirements for day to day operation.

5. The SK-DUCT housing contains a vacant mount for a SK-RELAY (sold separately). Current draw for the SK-RELAY is calculated by increasing the SK-RELAY row of the calculation sheet by one for each SK-RELAY used with a SK-DUCT.
6. The FACP can only support 5 devices w/LED's on. This current draw has been added to the panels alarm current.

3.6.3 Current Draw Worksheet for SD SLC Devices

Use to determine current requirements during alarm/battery standby operation when SD SLC devices are installed. You can install up SD devices per loop (Max per panel). Copy this section if additional space is required.

Table 3-3: Current Draw Worksheet for SD SLC Devices

Device	# of Devices	Current per Device		Standby Current	Alarm Current
For each device use this formula: This column X This column = Current per number of devices.					
IntelliKnight 5820XL Fire Panel (Current draw from battery)	1	Standby:	275 mA	275 mA	
		Alarm:	440 mA		440 mA
Addressable SLC Devices					
SD500-AIM	(508 max.) ¹	Standby/Alarm: .55 mA ⁵		mA	mA
SD500-MIM				mA	mA
SD500-PS				mA	mA
SD500-ARM				mA	mA
SD505-AHS (obsolete. See SD505-HEAT)				mA	mA
SD505-HEAT				mA	mA
SD505-APS (obsolete, see SD505-PHOTO)				mA	mA
SD505-PHOTO				mA	mA
SD500-ANM	(508 max.) ¹	Aux. Pwr	Standby: 8 mA	mA	
			Alarm: 60 mA		mA
		SLC	Standby/Alarm: .55 mA	mA	mA
SD500-SDM	(508 max.) ¹	SLC	Standby/Alarm: .55 mA		mA
		Aux. Pwr	Standby: 20 mA	mA	
			Alarm: 106 mA		mA
SLC Accessory Bases					
SD505-6RB	(508 max.)	Standby/Alarm: .082 mA		mA	mA
SD505-6SB	(508 max.)	Aux. Pwr	Standby: 1 mA	mA	
			Alarm: 32 mA		mA
		SLC	Standby/Alarm: .082 mA	mA	mA
SD505-DUCTR	(508 max.)	Aux. Pwr	Standby: 20 mA ²	mA	
			Alarm: 62 mA ²		mA
		SLC	Standby/Alarm: .5 mA	mA	mA
SD505-DTS-K	(508 max.)	None, included with SD505-DUCTR worst case.			
SD505-DUCT	(508 max.)	None, included with detector current.			
SLC Isolator Devices					
SD500-LIM	(1024 max.)	Standby/Alarm		.092 mA	mA
SD505-6IB	(508 max.)				
Accessories Modules					
5815XL SLC Expander	(3 max.)	Standby/Alarm: 55 mA		mA	mA
5860 Remote Fire Alarm Annunciator.	(12 max.)	Standby: 20 mA		mA	
EVS-RCU contains one 5860 and must be added to the calculation here..		Alarm: 25 mA			mA
5824 Serial/Parallel Printer Interface	(2 max.)	Standby/Alarm: 45 mA		mA	mA
5895XL IntelliKnight Power Expander	(8 max.)	Standby/Alarm: 10 mA		mA	mA
5496 Intelligent Power Module		Standby/Alarm: 10 mA		mA	mA

Table 3-3: Current Draw Worksheet for SD SLC Devices

Device	# of Devices	Current per Device	Standby Current	Alarm Current
5865-4 LED Annunciator (with reset and silence switches)	(8 max.)	Standby: 35 mA	mA	
		Alarm: 145 mA		mA
5865-3 LED Annunciator		Standby: 35 mA	mA	
		Alarm: 145 mA		mA
5880 LED I/O Module	(32 max.)	Standby: 35 mA	mA	
		Alarm: 200 mA		mA
5883 Relay Interface	(32 max.)	Standby: 0 mA	mA	
		Alarm: 220 mA (22 mA per relay)		mA
EVS-VCM Voice Control Module	(1 max.)	Standby: 70 mA	mA	
		Alarm: 100 mA		mA
EVS-SW24 Switch Expander	(5 max.)	Standby: 10 mA	mA	
		Alarm: 25 mA		mA
EVS-50W or EVS-125W Audio Amplifier with/without EVS-CE4	(4 max.)	Standby: 10 mA	mA	
		Alarm: 10 mA		mA
EVS-INT50W Internal Amplifier	(4 max.)	Standby: 52 mA	mA	
		Alarm @ 25V: 275 mA		mA
		Alarm @ 70V: 310 mA		mA
Notification Devices	Refer to devices manual for number of devices and current rating.			
EVS-RVM Remote Voice Module * The EVS-RCU contains one EVS-RVM and must be added to the calculation here	(4 max.)	Standby: 70 mA	mA	
		Alarm: 100 mA		mA
EVS-100W 100W Amplifier	(4 max.)	Standby/Alarm: 10 mA	mA	mA
EVS-100WBU backup daughter card	(4 max.)	Standby/Alarm: 10 mA	mA	mA
Total System Current				
Auxiliary Devices ³	Refer to devices manual for current rating.			
IPDACT-2 IP Communicator		Alarm: 136 mA		mA
		Standby: 93 mA	mA	
IPDACT-2UD IP Communicator		Alarm: 155 mA		mA
		Standby: 98 mA	mA	
		Alarm/Standby: mA	mA	mA
		Alarm/Standby: mA	mA	mA
		Alarm/Standby: mA	mA	mA
		Alarm/Standby: mA	mA	mA
B Auxiliary Devices Current				
Notification Appliance Circuits	Refer to devices manual for current rating.			
5495/5499 Power Supply		24 VDC	One input circuit: 15 mA	mA
			Both input circuits: 30 mA	mA
		Alarm: mA		mA
		Alarm: mA		mA
		Alarm: mA		mA
		Alarm: mA		mA
Notification Appliances Current				mA
D Total current ratings of all devices in system (line A + line B + C)			mA	mA
E Total current ratings converted to amperes (line D x .001):			A	A
F Number of standby hours:			H	
G Multiply lines E and F.	Total standby AH		AH	
H Alarm sounding period in hours. (For example, 5 minutes = .0833 hours)				H
I Multiply lines E and H.	Total alarm AH			AH
J Add lines G and I. ⁴	Total ampere hours required		AH	

1. Total does not include isolator devices or accessory bases.
2. If using 24 VDC aux power only. No standby or alarm current for battery calculation if using 24 VAC, 120 VAC or 240 VAC.

3. If using door holders, you do not need to consider door holder current for alarm/battery standby, because power is removed during that time. However, during normal operation, door holders draw current and must be included in the 6.0A total current that can be drawn from the panel.
4. Use next size battery with capacity greater than required.
5. The FACP can only support 2 devices w/LED's on. This current draw has been added to the panels alarm current.

3.6.4 Maximum Battery Standby Load

Table 3-4 shows the maximum battery standby load for the 5820XL/5820XL-EVS based on 24 and 60 hours of standby. The standby load calculations of line D in the Current Draw Calculation Worksheet (Table 3-2 for SK devices and Table 3-3 SD devices), must be less than the number shown in Table 3-4 for the battery size used and standby hours required.

Table 3-4: Maximum Battery Standby Load

Rechargeable Battery Size	Max. Load for 24 hrs. Standby, 5 mins. Alarm	*Max. Load for 60 hrs. Standby, 5 mins. Alarm
7 AH	270 mA	105 mA
12 AH	475 mA	190 mA
18 AH	685 mA	270 mA
35 AH	1.3 A	540 mA

- * Required for NFPA 72 Auxiliary Protected Fire Alarm systems for Fire Alarm Service (City Box) and Remote Station Protected Fire Alarm systems (Polarity Reversal) and Digital Alarm Communicator/Transmitter (DACT)
- * 33AH max battery size for FM (factory mutual) installations.

Warning!

Silent Knight does not support the use of batteries smaller than those listed in Table 3-4. If you use a battery too small for the installation, the system could overload the battery resulting in the installation having less than the required 24 hours standby power. Use Table 3-4 to calculate the correct battery amperes/hour rating needed for your installation.

3.7 Installation Tasks Overview

This section provides a chart listing tasks that need to be performed when installing the 5820XL/5820XL-EVS system. The chart is intended to be a handy way for you to make sure you have completed all necessary tasks. Unless noted, these tasks do not have to be performed in the order they are listed here.

Important: Connect and address SLC devices before running JumpStart AutoProgramming.

Task	See Sec. (for more info.)
Main Panel Hardware Installation	
Mount the control panel cabinet.	4.1
Connect AC.	4.2
Install 5815XL SLC expander modules. Required if more than 127 SLC devices are used.	4.6
Install 5860 Remote Fire Alarm Annunciator modules.	4.5
Install 5865 or LED Annunciator modules.	4.9
Install 5880 LED I/O modules.	4.8
Install notification appliances.	4.12

Task	See Sec. (for more info.)
Install auxiliary power devices.	4.12.5
Install the 5824 Serial/Parallel Printer Interface modules.	4.7
Connect batteries (typically last step).	4.3
SLC Device Hardware Installation Perform these steps before running JumpStart.	
Connect device bases to the loop.	SK 5.5 SD 5.7
Set device addresses.	SK 5.6 SD 5.8
Physically connect detectors to their bases. Connect relay and contact monitor modules.	5.4 & see device install instructions
JumpStart AutoProgramming	
JumpStart is for initial system programming. JumpStart automatically selects some options for SLC devices. See "Input Point (SLC Device) Configuration" section of this chart for other options. JumpStart makes selections for the following options. You can customize options, if necessary.	6.2 & 7.7
Device type (detector or switch) configured by JumpStart.	To change, see 7.7
Program type of detector (heat, photoelectric, or ionization) selected by JumpStart.	To change, see 7.7
System Software Configuration	
Select low AC hours report time (3 hours by default).	7.6.4.2
Select Auto Test Time (2:00 AM by default).	7.6.2
Enable/disable automatic DST adjustment feature (enabled by default).	7.6.6.1
Change clock display format (12-hour with AM/PM by default).	7.6.4.4
Set up reporting accounts.	7.6.1
Select options for phone lines.	7.6.2
Select system-wide response to trouble conditions, if desired.	7.6.3
Select system-wide cadence patterns for special conditions (fire drill, Aux1 and Aux2 alarms) if desired.	7.6.3.2
Customize banner message (message that displays on LCD in normal mode) if desired.	7.6.7
Input Point (SLC Device) Configuration	
JumpStart automatically selects some options for SLC devices (see "JumpStart" section of this chart). You can change options selected by JumpStart, if necessary and further customize input point options.	
Select device family (SK or SD). Only one device family can be used per control panel.	7.6.8
Program type of switch (manual pull, fire drill, and so on), if necessary. (JumpStart assigns all switches as Manual Pull type.)	7.5
If the installation includes duct detectors, program detector type. (JumpStart does not distinguish duct detectors from ordinary smoke detectors.)	7.5
Assign a name (or description) to the point.	7.5.5
Assign input points to zones, if necessary. (JumpStart assigns all input points to Zone 1.)	7.5
Zone Configuration	
Add the zone to the system if it does not already exist. (Zone 1 created by JumpStart.)	7.3.2
Program a name (or description) for the zone.	7.3.1.1
Select alarm delay options (detection characteristics) for zone.	7.3.1.2

Task	See Sec. (for more info.)
Select heat detector trip temperature and/or smoke sensitivity level for photoelectric smoke detectors. (JumpStart selects 150°F for heat detectors and Low sensitivity for smoke detectors.)	7.3.1.2
Output Point Configuration	
Conventional notification circuits (circuits 1-6):	
Enable circuits used for notification appliances through programming (if necessary). (JumpStart enables circuits 1-6 as Notification.)	7.5
Conventional relay circuits (circuits 7-8):	
Select options for relay circuits, if desired. Note: Relay circuits will always output continuously (constant pattern), even if assigned to an Output Group that uses a different output pattern.	7.5
Auxiliary power circuits (circuits 1-6):	
Enable any circuit used for auxiliary power devices through programming.	7.5
Select type of power (door holder, constant, or resettable)	7.5
Addressable relay modules	
Assign addressable relay modules to output groups through programming. (JumpStart assigns all relay modules to Group 1.)	7.5
LED output points (from the 5880 LED I/O module or 5865/66 LED Annunciator)	
Assign LED modules to output groups through programming.	7.5.3
All output circuits (1-8):	
Disable (set to UNUSED) any unused circuits. If you do not disable unused output circuits, they will cause a trouble condition (unless an EOL resistor is used).	7.5
Select a name for the point.	7.5.5
Output Group Configuration	
Add a group to the system if it does not already exist.	7.4.2
Assign output points to a group.	7.5
Assign a name (or description) for the group.	7.4.1.1
Select "group properties" (see below).	
Latching / non-latching	7.4.1
Silencing option	7.4.1
Select options for activation with system switches.	7.4.1
Map zones to output groups that will activate when zone goes into alarm.	7.3.1.3
Select a cadence pattern for outputs in the zone.	7.3.1.3
Emergency Voice System	
EVS Super User	9.3
EVS Priority Table & Rules	9.8
EVS Device Priority	9.6
Voice Command Mapping	9.13
EVS System Options	7.10.3
EVS-VCM Maintenance	7.10.1

Section 4

Control Panel Installation

Caution!

To avoid the risk of electrical shock and damage to the unit, power should be OFF at the control panel while installing or servicing.

4.1 Mounting the Control Panel Cabinet

Read the environmental specifications in Section 3.2 before mounting the control panel cabinet. This will ensure that you select a suitable location.

The panel should be accessible to main drop wiring runs. It should be mounted as close to the center of the building as possible and located within a secured area, but should be accessible for testing and service.

Mount the control panel cabinet so it is firmly secured to the wall surface. When mounting on concrete, especially when moisture is expected, attach a piece of 3/4-inch plywood to the concrete surface and then attach the cabinet to the plywood. Also mount any other modules to the plywood.

The 5820XL cabinet can be surface- or flush-mounted. Cabinet dimensions are 16.2" W x 26.4" H x 4.2" D. There should be 1.5" to 1.75" of cabinet extruding from the wall, this should be measured from either the top edge or bottom edge to the exterior side of the sheet rock. Do NOT flush mount in a wall designated as a fire break.

The 5820XL-EVS cabinet can be surface or flush mounted. Cabinet dimensions are 20" W x 26.5" H x 4.6" D. There should be 1.5" to 1.75" of cabinet extruding from the wall, this should be measured from either the top edge or bottom edge to the exterior side of the sheet rock. Do NOT flush mount in a wall designated as a fire break.

4.1.1 Preventing Water Damage

Water damage to the fire system can be caused by moisture entering the cabinet through the conduits. Conduits that are installed to enter the top of the cabinet are most likely to cause water problems. Installers should take reasonable precautions to prevent water from entering the cabinet. Water damage is not covered under warranty.

4.1.2 Removing the 5820XL / 5820XL-EVS Assembly from the Housing

If it should ever be necessary to remove the control panel assembly from the cabinet for repair, do so by unscrewing the nuts that connect the control panel assembly to the cabinet. Do not attempt to disassemble the circuit boards. See Section 3.5 for location of the nuts.

4.2 AC Connection

At installation, connect the AC terminals to the power source as shown in Figure 4-1. It may be necessary for a professional electrician to make this connection.

Warning
To reduce the risk of electric shock, this product is provided with a grounding type power supply cord. Connect product to a grounded receptacle.

The AC terminals are rated at 120 VAC, 60 Hz, 2.7A.

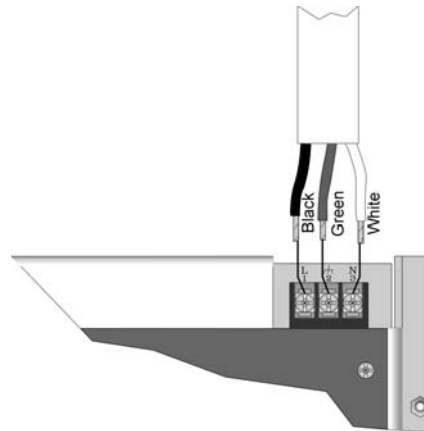
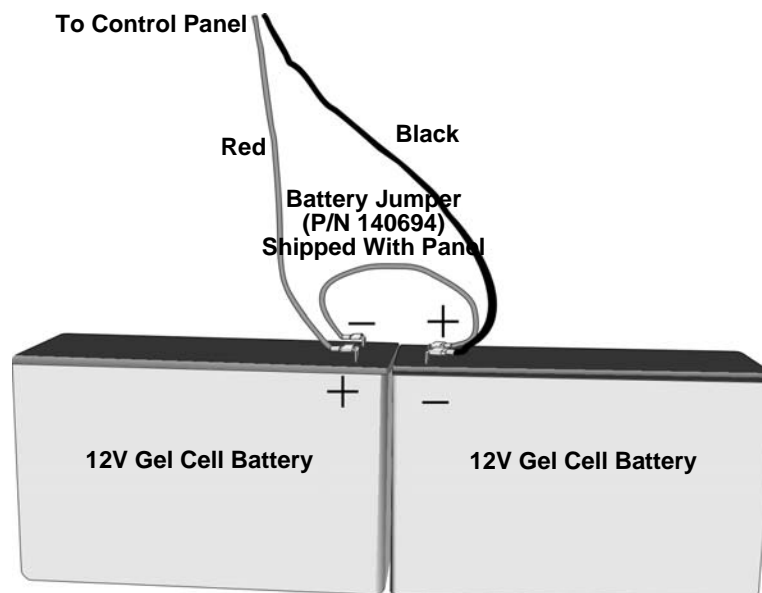

Figure 4-1 120 VAC Power Connection for the 5820XL/EVS

4.3 Battery Connection

The control panel battery charge capacity is 7.0 to 35 AH. Use 12V batteries of the same AH rating. Determine the correct AH rating as per your current load calculation (see Section 3.6).

Wire batteries in series to produce a 24-volt equivalent. Do not parallel batteries to increase the AH rating.



* It is recommended that you replace batteries every five years.

Figure 4-2 Battery Connection

4.3.1 RBB Accessory Cabinet

The Model RBB Accessory cabinet can be used when your backup batteries requirements use backup batteries that are too large to fit into the main control panel cabinet. The RBB cabinet holds batteries up to the 35 AH size. The RBB dimensions are 16" W x 10" H x 6" D (40.64 cm W x 25.4 cm H x 15.24 cm D).

4.3.1.1 Installing the RBB Accessory Cabinet and Batteries

To properly install the accessory cabinet and backup batteries, follow these steps:

1. Mount the accessory cabinet. See Figure 4-3 for the four cabinet mounting holes.
 - If mounting onto drywall the accessory cabinet must be mounted onto 3/4-inch plywood. This is necessary because the weight of the batteries inside the accessory cabinet could cause the cabinet to pull away from the drywall.
 - When mounting on concrete, especially when moisture is expected, attach a piece of 3/4" plywood to the concrete surface and then attach the RBB cabinet to the plywood.
 - If using the battery cable extenders provided (P/N 140643), mount the RBB cabinet no more than 18" away from the main control panel cabinet. This will ensure that the battery cables reach the battery terminals.

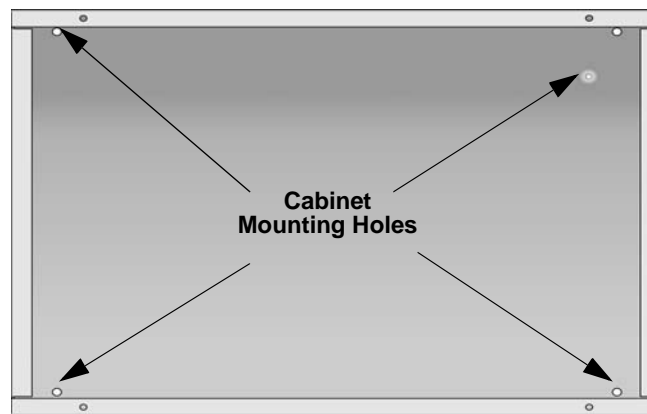

Figure 4-3 RBB Cabinet Mounting Holes

2. Connect the main control panel battery cables to the battery cable extenders as shown in Figure 4-4.

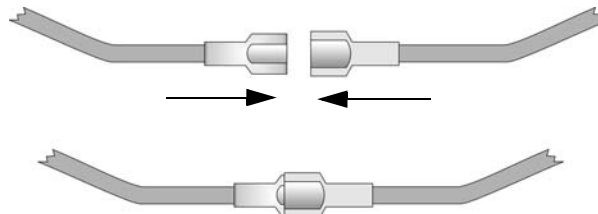

Figure 4-4 Splicing Control panel Battery Cable to RBB Battery Cable Extenders

- Run extended battery cable from control panel cabinet through conduit to RBB cabinet. See Figure 4-5.

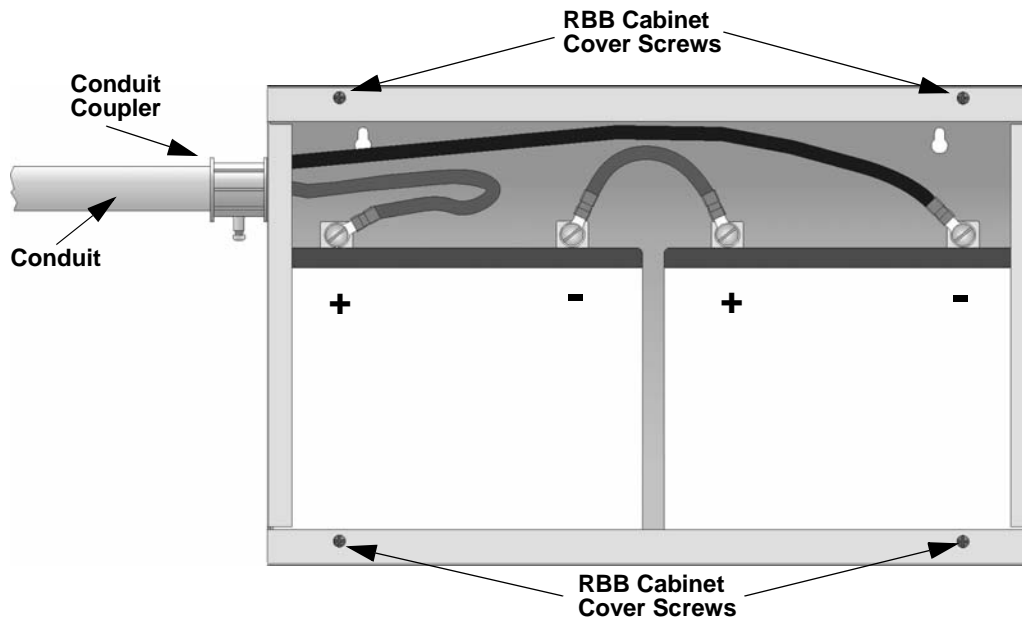

Figure 4-5 Battery Connections in the RBB Cabinet

Note: Figure 4-5 is an example of how the wire connections can be routed. However, any other cabinet knock-outs (on either the main control panel or the RBB cabinet), that are not previously being used may be utilized to connect conduit between the two cabinets.

- Connect battery leads to the backup battery terminals. See Figure 4-5.
Observe the proper polarity to prevent damage to the batteries or the control panel.
- Insert the RBB cover screws into the cover mounting holes. See Figure 4-5.
Screw the cover screw $\frac{3}{4}$ of the way into the cover mounting hole.
- Align the cover plate mounting keyhole over the cover mounting screws. See Figure 4-6.

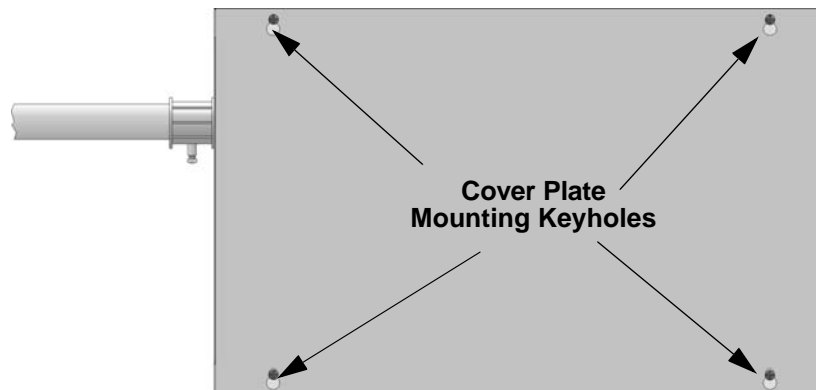

Figure 4-6 Cover Plate Mounting Keyholes and Cover Mounting Screws Alignment

- Slide the cover into place and tighten the cover mounting screws. See Figure 4-6.

4.4 SBUS Wiring

This section contains information on calculating SBUS wire distances and the types of wiring configurations (Class A and B).

4.4.1 Calculating Wiring Distance for SBUS Modules

The following instructions will guide you in determining the type of wire and the maximum wiring distance that can be used with control panel SBUS accessory modules.

To calculate the wire gauge that must be used to connect SBUS modules to the control panel, it is necessary to calculate the total worst case current draw for all modules on a single 4-conductor bus. The total worst case current draw is calculated by adding the individual worst case currents for each module. The individual worst case values are shown in the table below.

Note: Total worst case current draw on a single SBUS cannot exceed 1 amp. If a large number of accessory modules are required, and the worst case current draw will exceed the 1 amp limit, then the current draw must be distributed using 5895XL Power Expanders. Each 5895XL Power Expander provides an additional SBUS, with an additional 1 amp of SBUS current. Wiring distance calculations are done separately for each 5895XL, and separately for the control panel itself.

Model Number	Worst Case Current Draw
5860 Fire Annunciator	.100 amps
5824 Serial/Parallel Printer Interface Module	.040 amps
5880 LED I/O Module	.250 amps
5865 LED Annunciator	.200 amps
5895XL Intelligent Power Supply	.010 amps
5496 Intelligent Power Supply	.010 amps
EVS-50W	.010 amps
EVS-125W	.010 amps
EVS-100W	.010 amps
EVS-100W with EVS-100WBU	.010 amps
EVS-VCM / EVS-VCM with EVS-SW24* **	.080 amps / .105 amps
EVS-RCU / EVS-RCU with EVS-SW24* **	.080 amps / .105 amps

Note: Refer to if using SD SLC devices and Table 3-2 if using SK SLC devices for maximum number of each type of device that can be used per system

* All devices must use the same SBUS and VBUS.

** When doing wire calculations, use .080 amps per device with .105 amps for the last device.

After calculating the total worst case current draw, Table 4-1 specifies the maximum distance the modules can be located from the panel on a single wire run. The table ensures 6.0 volts of line drop maximum. In general, the wire length is limited by resistance, but for heavier wire gauges, capacitance is the limiting factor.

These cases are marked in the chart with an asterisk (*). Maximum length can never be more than 6,000 feet, regardless of gauge used. The formula used to generate this chart is shown in the note below.

Table 4-1: Wire Distances Per Wire Gauge Using Copper Wire

Wiring Distance: SBUS Modules to Panel				
Total Worst Case Current Draw (amps)	22 Gauge	18 Gauge	16 Gauge	14 Gauge
0.100	1852 ft.	4688 ft.	* 6000 ft.	* 6000 ft.
0.200	926 ft.	2344 ft.	3731 ft.	5906 ft.
0.300	617 ft.	1563 ft.	2488 ft.	3937 ft.
0.400	463 ft.	1172 ft.	1866 ft.	2953 ft.
0.500	370 ft.	938 ft.	1493 ft.	2362 ft.
0.600	309 ft.	781 ft.	1244 ft.	1969 ft.
0.700	265 ft.	670 ft.	1066 ft.	1687 ft.
0.800	231 ft.	586 ft.	933 ft.	1476 ft.
0.900	206 ft.	521 ft.	829 ft.	1312 ft.
1.000 (Max)	185 ft.	469 ft.	746 ft.	1181 ft.

Note: The following formulas were used to generate the wire distance chart:

$$\text{Maximum Resistance (Ohms)} = \frac{6.0 \text{ Volts}}{\text{Total Worst Case Current Draw (amps)}}$$

$$\text{Maximum Wire Length (Feet)} = \frac{\text{Maximum Resistance (Ohms)}}{\text{Rpu}} * 500$$

(6000 feet maximum)

where: Rpu = Ohms per 1000 feet for various wire gauges (see table below)

Table 4-2: Typical Wire Resistance Per 1000 ft. Using Copper Wire

Wire Gauge	Ohms per 1000 feet (Rpu)
22	16.2
18	6.4
16	4.02
14	2.54

Wiring Distance calculation example:

Suppose a system is configured with the following SBUS modules:

- 2 - Module 5860 Fire Annunciator
- 1 - 5895XL Intelligent Power Expander
- 1 - 5865 LED Annunciator
- 1 - 5824 Serial/Parallel Interface Module

The total worst case current is calculated as follows:

5860 Current Draw	= 2 x .100 amps	= .200 amps
5895XL Current Draw	= 1 x .010 amps	= .010 amps
5865 Current Draw	= 1 x .200 amps	= .200 amps
5824 Current Draw	= 1 x .040 amps	= .040 amps
Total Worst Case Current Draw		= .450 amps

Using this value, and referring to the Wiring Distance table, it can be found that the available options are:

370 feet maximum using 22 Gauge wire

938 feet maximum using 18 Gauge wire

1493 feet maximum using 16 Gauge wire

2362 feet maximum using 14 Gauge wire

4.4.2 Wiring Configurations

Figure 4-7 illustrates Class A wiring configuration and Figure 4-8 illustrates Class B configuration.

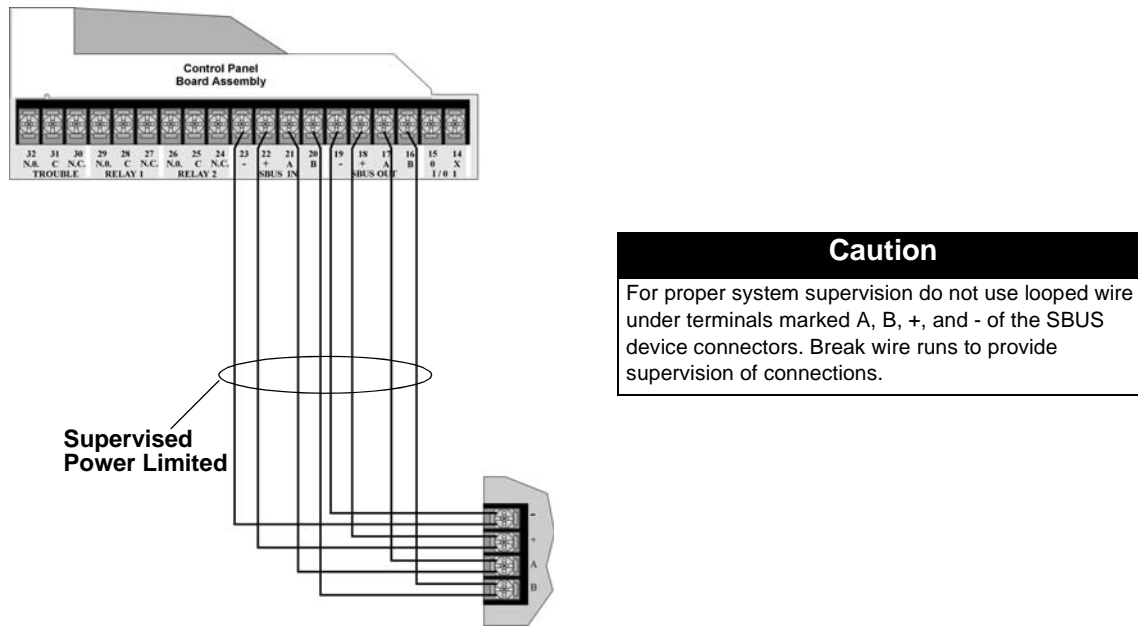

Figure 4-7 SBUS Class A Wiring

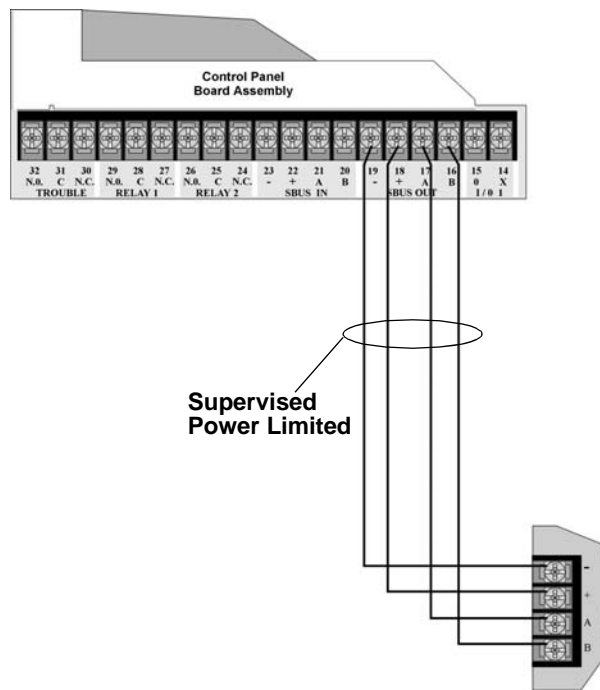

Figure 4-8 SBUS Class B Wiring

4.5 5860 Remote Annunciator Installation

The optional Model 5860 Remote Annunciator, shown in Figure 4-9, performs the same functions as the on-board annunciator. It can initiate and end fire drills with a single key press and view event history by alarms, supervisories, or troubles. Up to 12 annunciators can be added to the IntelliKnight 5820XL / 5820XL-EVS system.

Note: The EVS-RCU contains a 5860 and counts toward one of the eight annunciators.

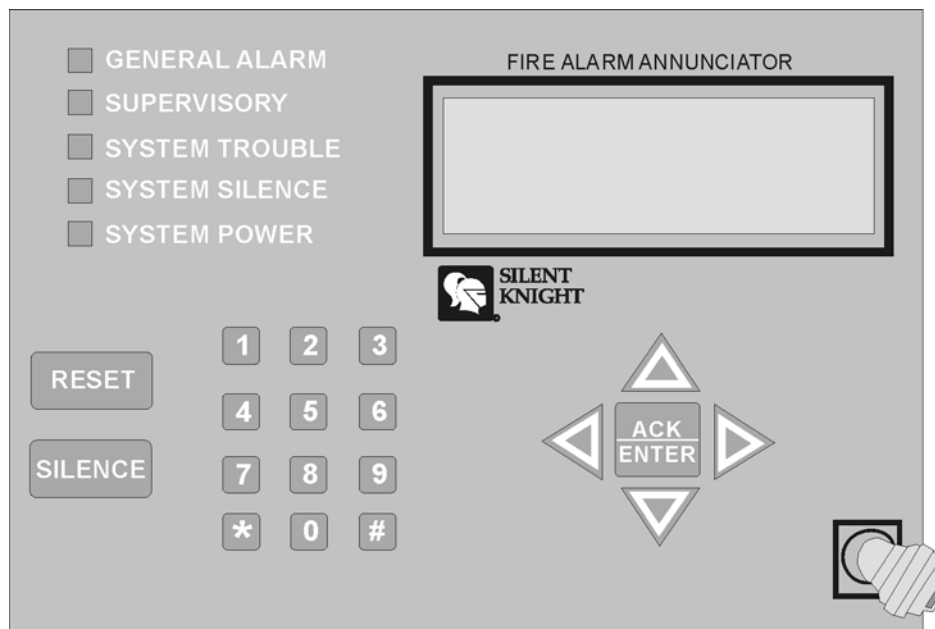

Figure 4-9 Model 5860 Remote Annunciator, Front View

5860 installation involves the following steps:

1. Make sure power is off at the panel.
2. Mount the 5860 in the desired location (see Section 4.5.1).
3. Connect the 5860 to the panel (see Section 4.5.2).
4. Use the DIP switches on the back of the 5860 to assign an ID# to the 5860 (see Section 4.10.1).
5. The new 5860 module must be added to the system through programming. JumpStart will add the module automatically (see Section 6.2). You can also add it manually (see Section 7.2.2). Select a name, if desired (see Section 7.2.1.1).

4.5.1 Mounting the 5860

This section of the manual describes mounting the remote annunciator. The annunciator can be flush- or surface-mounted. Figure 4-10 shows the parts of the annunciator. Instructions for disassembling and mounting appear on the following pages.

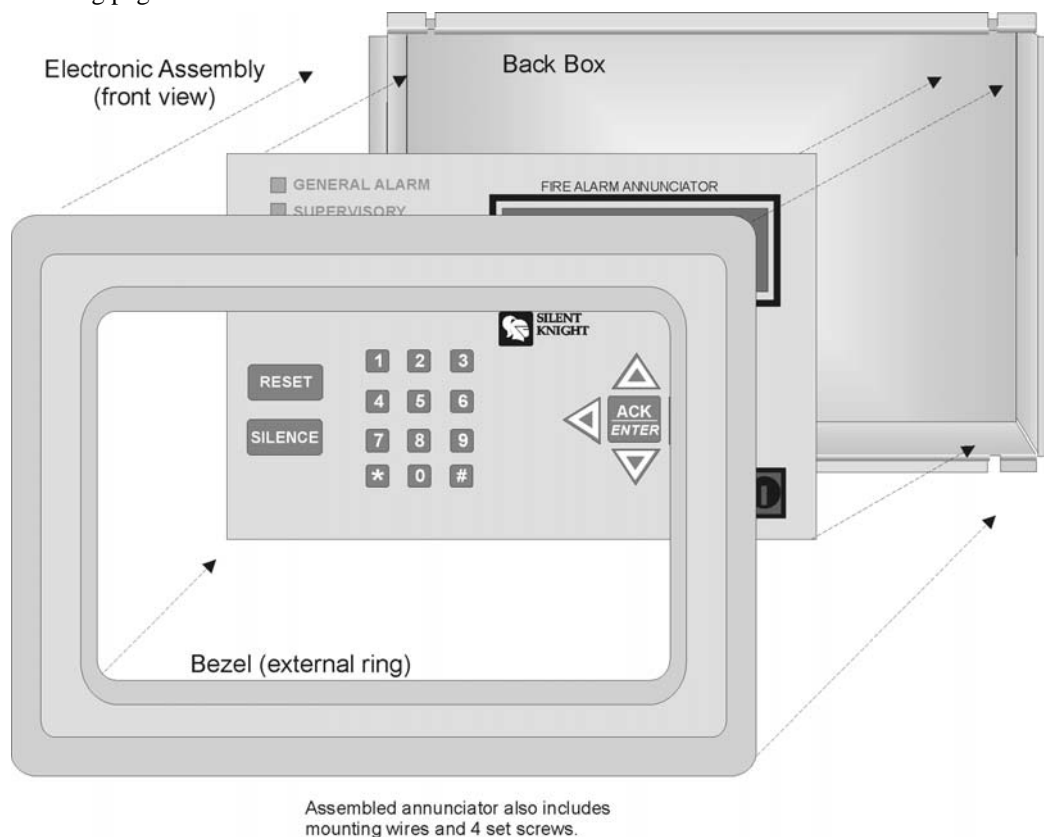

Figure 4-10 Annunciator Parts

The 5860 comes from the factory fully assembled. You must disassemble it for mounting. To disassemble the annunciator, use a 5/64 hex wrench to remove the set screws, located on the bottom of the annunciator bezel. (See Figure 4-11 for location of the set screws).

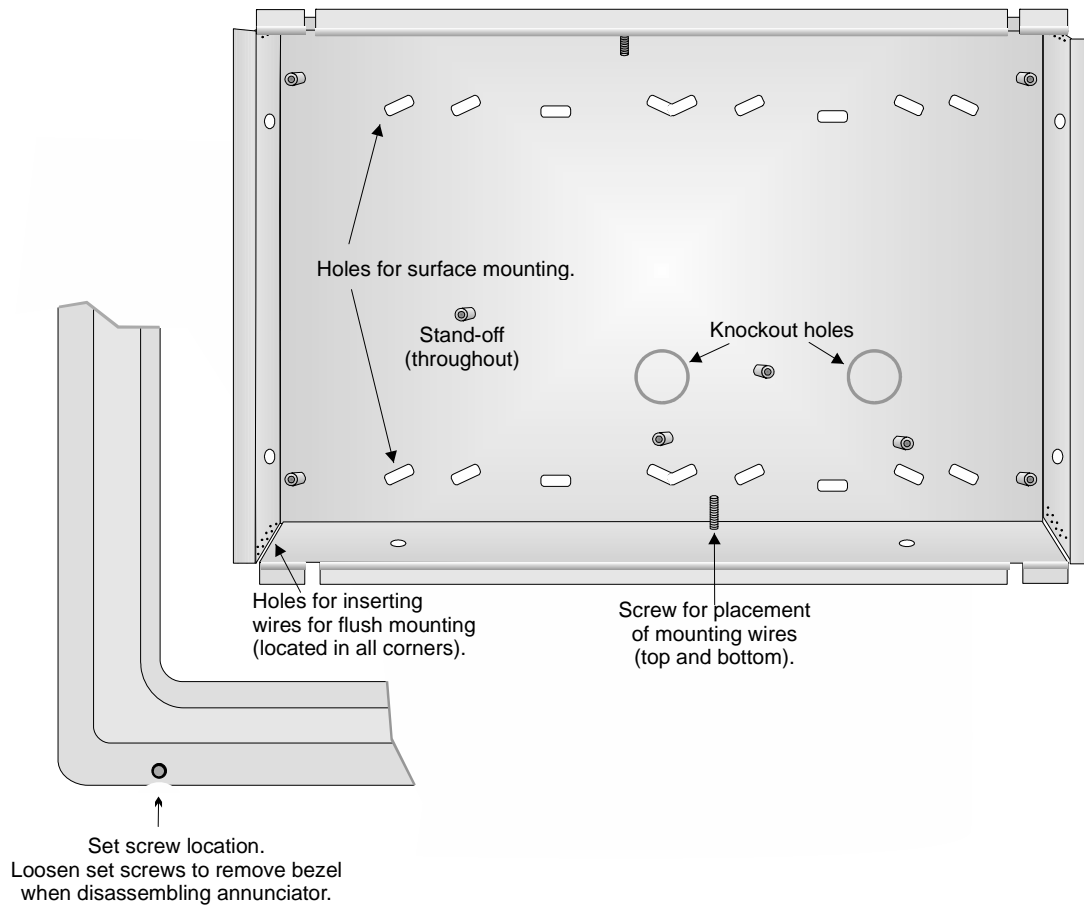

Figure 4-11 Annunciator Back Box and Bezel Details

4.5.1.1 Flush Mounting

This section of the manual describes flush mounting. You can flush-mount with or without an electrical box.

Flush Mounting with an Electrical Box

The 5860 annunciator can be used with the following types of electrical boxes: 4S, single-gang, and double-gang.

If an electrical box is used, the box must be 1-3/8" back from the face of the wall to accommodate the

annunciator. Studs used with an electrical box must be two by fours (or larger).

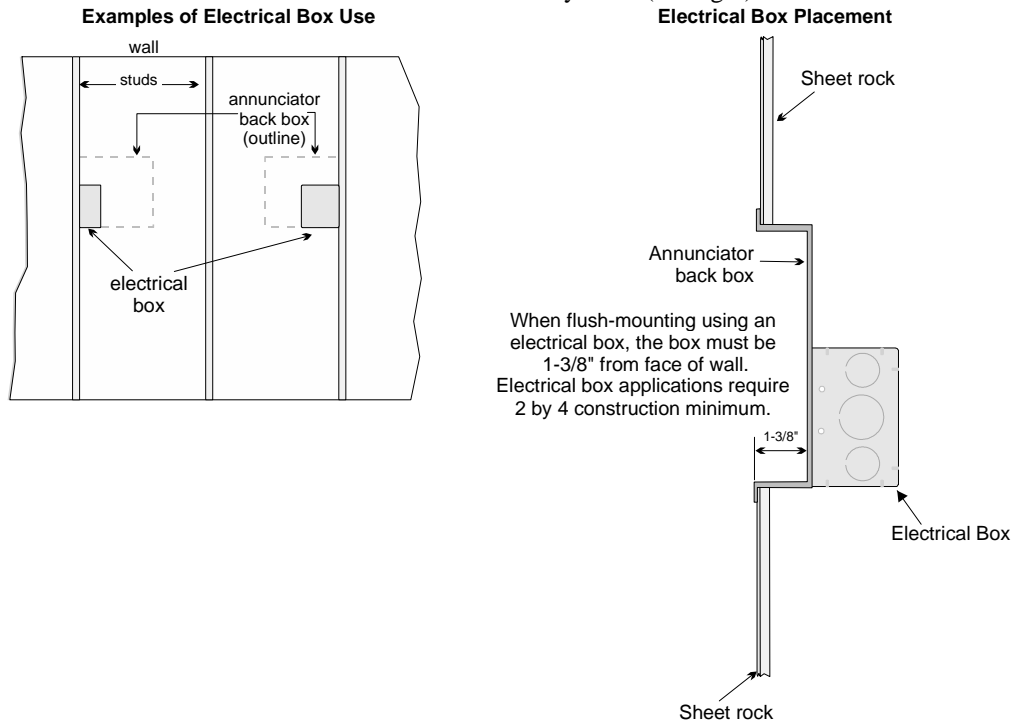

Figure 4-12 Placement of Electrical Box for Flush Mounting

Flush Mounting Steps

1. Cut a hole in the sheet rock to the following dimensions: 8-1/4" W x 6-5/8" H. If an electrical box is used, the box must be 1-3/8" back from face of wall to accommodate the annunciator (see Figure 4-12).
2. Remove knockout holes as needed for wires.
3. Fit the annunciator back box into the hole and stabilize with mounting wires. Angle the mounting wires into the first hole past the sheet rock. Secure the wires behind the screws as shown in Figure 4-13. When all four wires are in place, the back box should fit snugly into the hole in the sheet rock.
4. After the annunciator wiring to the panel has been completed (described in Section 4.5.2), replace the electronic assembly in the back box. Place the bezel over the back box and tighten the set screws on the bezel.

Attach second set of wires to top of back box.

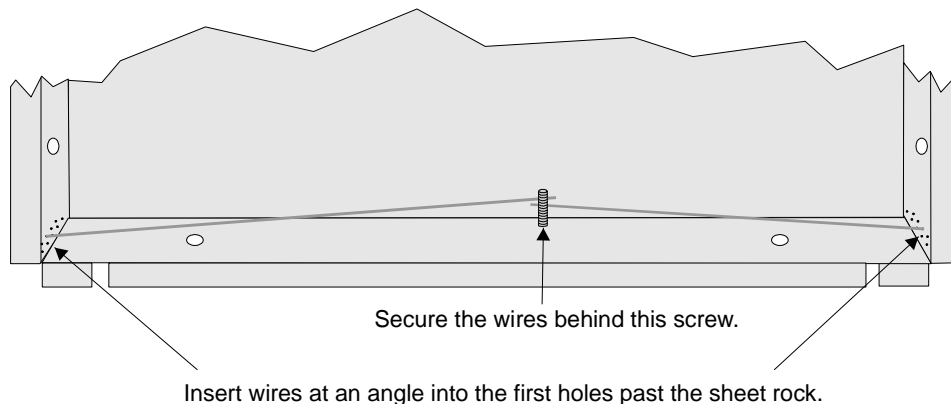

Figure 4-13 Flush Mounting the Back Box

4.5.1.2 Surface Mounting

The 5860 can be mounted directly to a surface or can be attached to a single, double, or four-square electrical box. The Model 5860TG/TR trim ring kit is available for use when surface mounting.

1. Drill holes in the surface to match the screw holes on the back box.
2. Fit the trim ring over the back box.
3. Attach the back box to the surface using screws provided.
4. After the annunciator wiring to the panel has been completed (described in Section 4.5.2), replace the electronic assembly in the back box. Place the bezel over the back box and tighten the set screws on the bezel.

4.5.2 Model 5860 Connection to the Panel

Connect the 5860 to the panel as shown in Figure 4-14.

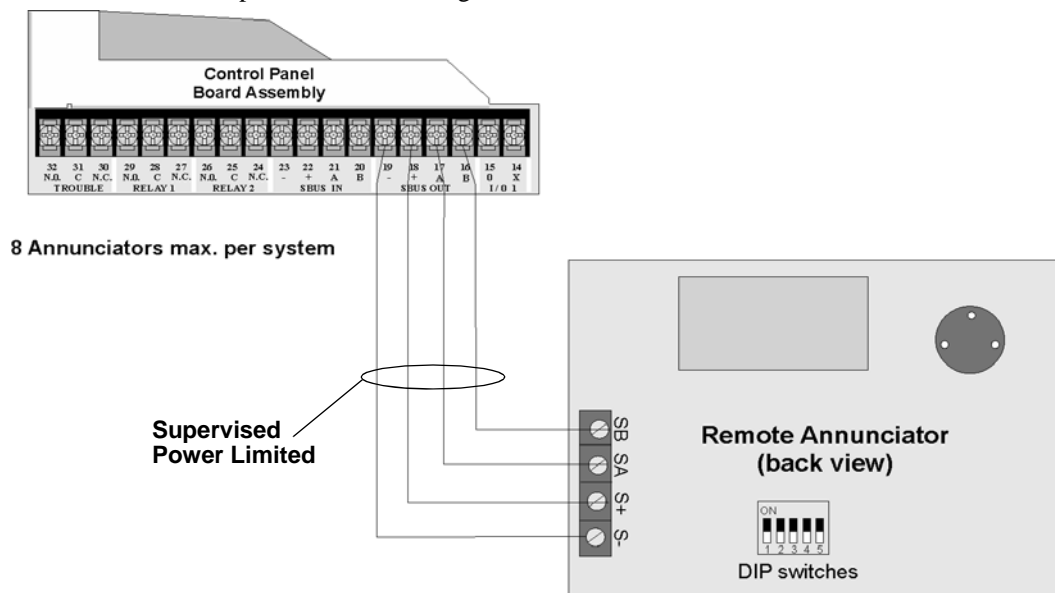

Figure 4-14 Model 5860 Connection to the Panel

4.6 5815XL Installation

The 5815XL SLC expander lets you add 127 SD addressable devices or 99 SK detectors and 99 SK modules. Add up to three 5815XLs to a system to achieve the maximum number of devices on the system.

To install the 5815XL:

1. Make sure power is off at the panel.
2. Mount the 5815XL in the 5820XL cabinet, the 5895XL cabinet, or the 5815RMK remote mounting kit. Use the standoffs located under the control panel board assembly and secure with screws provided with the 5815XL. For additional information, also see *Model 5895XL Installation Instructions* (P/N 151142) or *5815RMK Remote Mounting Kit Installation Instructions* (P/N 151391).
3. Connect the 5815XL to the control panel. (See Section 4.6.1.)
4. Use on-board DIP switches to select an SBUS ID#. (See Section 4.10.1).
5. The new 5815XL module must be added to the system through programming. JumpStart will add the module automatically (see Section 6.2). You can also add it manually (see Section 7.2.2). Select a name, if desired (see Section 7.3.1.1).
6. You are now ready to connect SLC devices to the 5815XL (see Section 5.4.2).

Figure 4-15 is a drawing of the 5815XL board, showing the location of terminals and DIP switches.

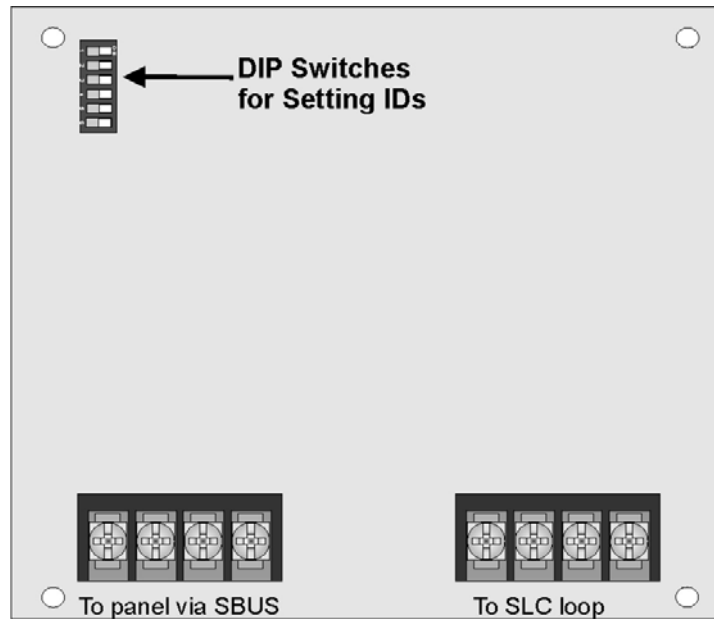

Figure 4-15 5820XL Board

4.6.1 5815XL Connection to the Panel

Connect the 5815XL to the control panel as shown in Figure 4-16. After the 5815XL is connected to the panel, it must be added to the system. This programming step is described in Section 4.10.

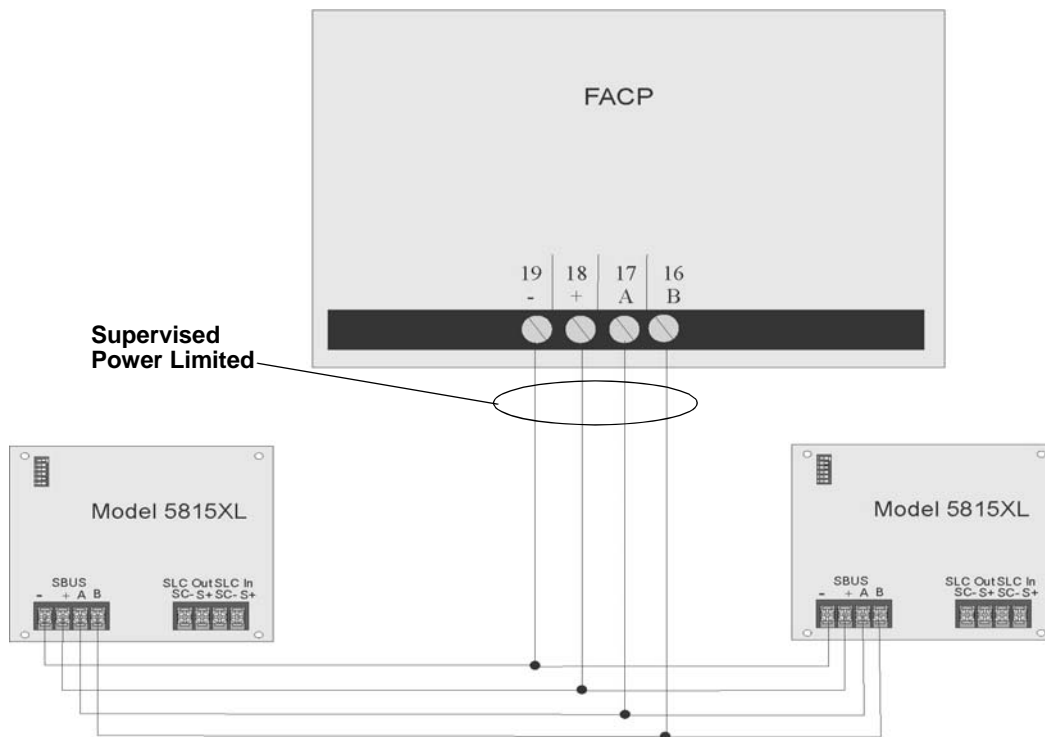

Figure 4-16 5815XL Connection to Main Panel Assembly

4.7 5824 Serial/Parallel Interface Module Installation

The 5824 serial/parallel interface module allows you to connect a printer to the panel, so you can print a real-time log of system events, a report of detector status, and event history. Instructions for installing the 5824 appear below.

The 5824 and the printer connected to the 5824 Parallel port is ancillary, the serial port can be used for primary fire signaling. The printer must be a UL 864 listed printer.

5824 installation involves the following steps:

1. Make sure power is off at the panel.
2. Connect the 5824 to the panel as shown in Figure 4-17.

Note: Two 5824s per panel maximum.

3. Use the DIP switches on the back of the 5824 board to assign an ID# to the 5824 (see Section 4.10.1).
4. Configure the 5824 device through programming. See Section 4.7.1.
5. Connect a printer to the 5824 as shown in Figure 4-18.

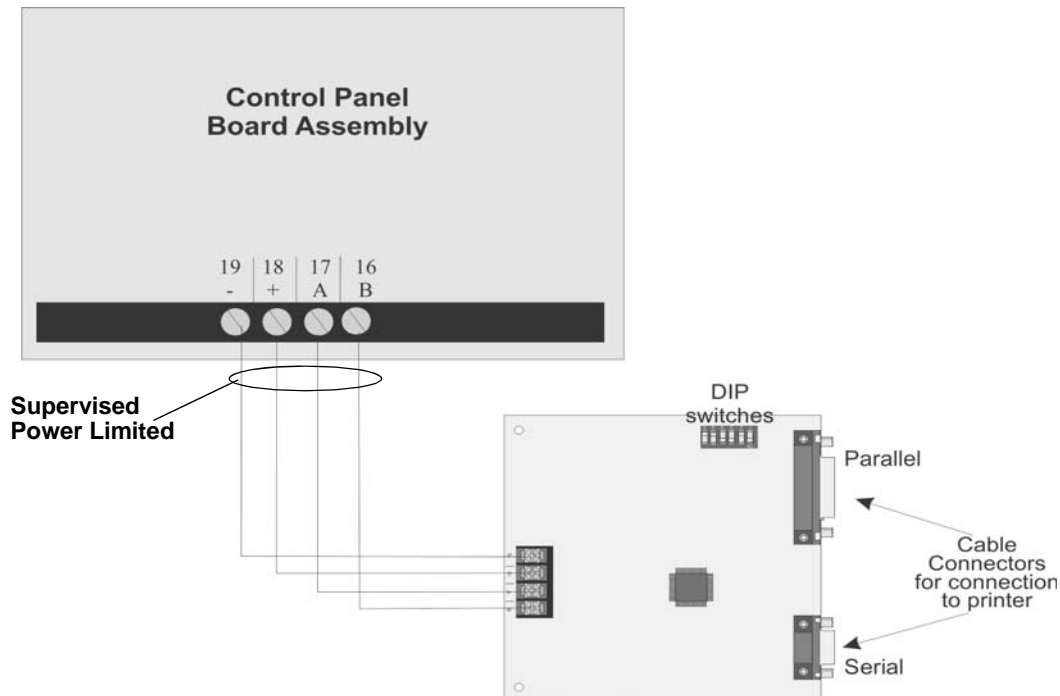

Figure 4-17 5824 Connection to the Panel

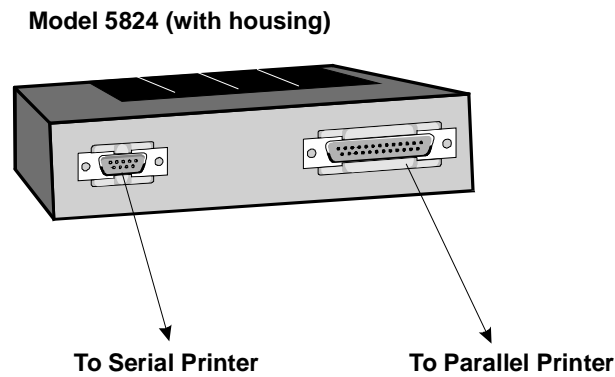

Figure 4-18 Printer Connection

4.7.1 Selecting 5824 Options

Configuring the 5824 includes the following steps:

- Add the module to the system. JumpStart will add the module automatically (see Section 6.2). You can also add it manually (see Section 7.2.2).
- Select a name, if desired (see Section 7.2.1.1).
- Select options for the printer and the output port. See below.

Printer and Output Port Options

1. From the Installer Main Menu, select 7 for Program Menu.
2. Select 1 for Module.
3. Select 1 for Edit Module.
4. From the list that displays, select the 5824 module you want to configure.
5. The right arrow must be pressed twice to skip over the Enter Module ID and Enter Module name options. A screen similar to the one shown in Figure 4-19 will display.

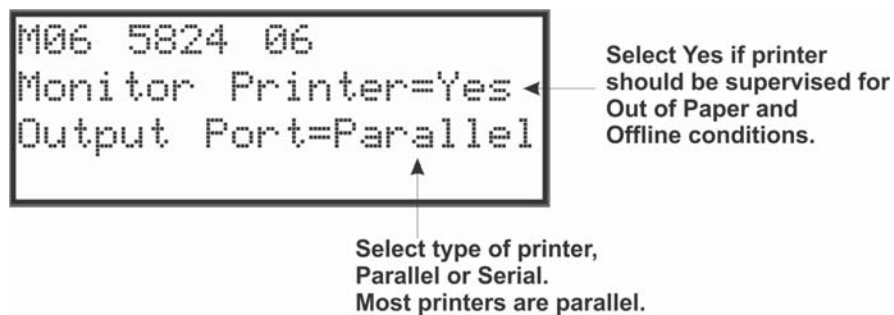

Figure 4-19 Selecting Printer and Output Port Options

6. Select options for the printer as needed for your installation. Most printers are parallel.

- If you are using a serial printer, use the next screen to select serial port options as required for your printer. Refer to your printer manual if you need more information.

Option	Choices
Baud Rate:	75 - 19200
Data Bits:	5 - 8
Stop Bits:	.5, 1, 2
Parity:	None, Even, Odd

4.8 5880 LED I/O Module

The 5880 is an LED driver board that can be used in a wide variety of applications, including as an interface with most customized floor plan annunciator boards. The 5880 can drive up to 40 LEDs and has one PZT controller. The 5880 also has eight inputs for monitoring dry contacts. When used with the 5820XL-EVS the 5880 inputs can be programmed to replicate the eight EVS buttons located on the front of the voice control module. (See section 9.5 for programming options). The following sub-sections describe hardware installation. Refer to Section 7 for programming information.

4.8.1 5880 Board Layout

Figure 4-20 shows the locations of screw terminals for connection to the panel and contact monitor wiring; pin connectors for connecting LEDs; and the DIP switch for selecting an SBUS ID number for the 5880.

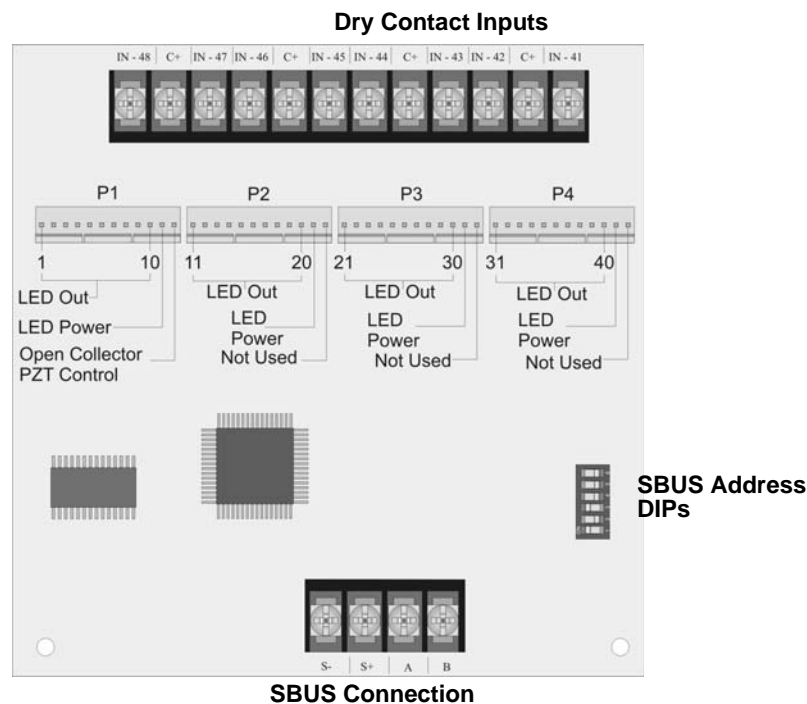

Figure 4-20 5880 Board Layout

4.8.2 5880 Connection to Panel

The 5880 connects to the panel via the SBUS. Make connections as shown in Figure 4-21. After the 5880 is

connected to the panel, it must be added to the system. This programming step is described in Section 4.10.

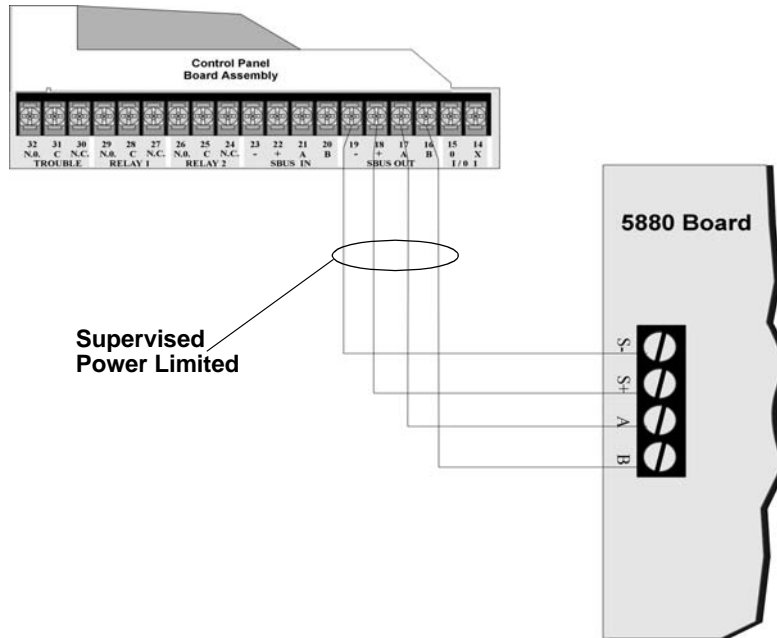

Figure 4-21 5880 Connection to Main Control Panel Assembly

4.8.3 LED Wiring

There are four 12-pin connectors on the 5880 board for connecting LEDs. Each LED gets its power from Pin 11. Internal resistors are sized so that there is approximately 10 mA of current for each LED, no series resistors are required. LED outputs can be mapped to output circuits. See Section 6 for programming details.

Wire the LEDs as shown in Figure 4-22.

On connector P1, Pin 12 is an open collector output for controlling a PZT. If used, the 5880 PZT will match the PZT pattern of the on-board (or 5860) annunciator.

Note: The circuit connected to "Open Collector Output" (last pin on P1) must be current limited so that no more than 100 mA of current is allowed to flow into the open collector transistor.

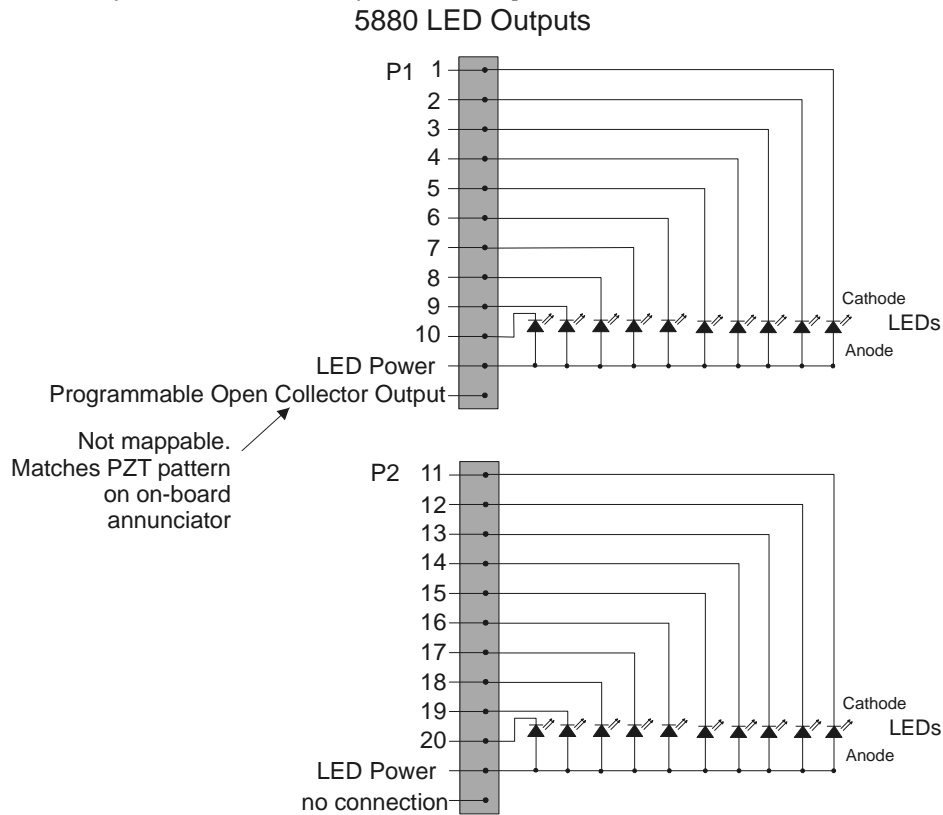

Connectors P3 and P4 wired same as P2.

Figure 4-22 5880 Board Layout

4.8.4 Dry Contact Wiring

The 8 input circuits on the 5880 board are for monitoring switch inputs-any type of switch supported by the control panel can be used with the 5880. For example, you can use a 5880 to monitor pull stations, water flow, tamper, reset, or silence switches.

Wire dry contacts as shown in Figure 4-23. Notice grouping of terminals; power terminals are shared by two

inputs.

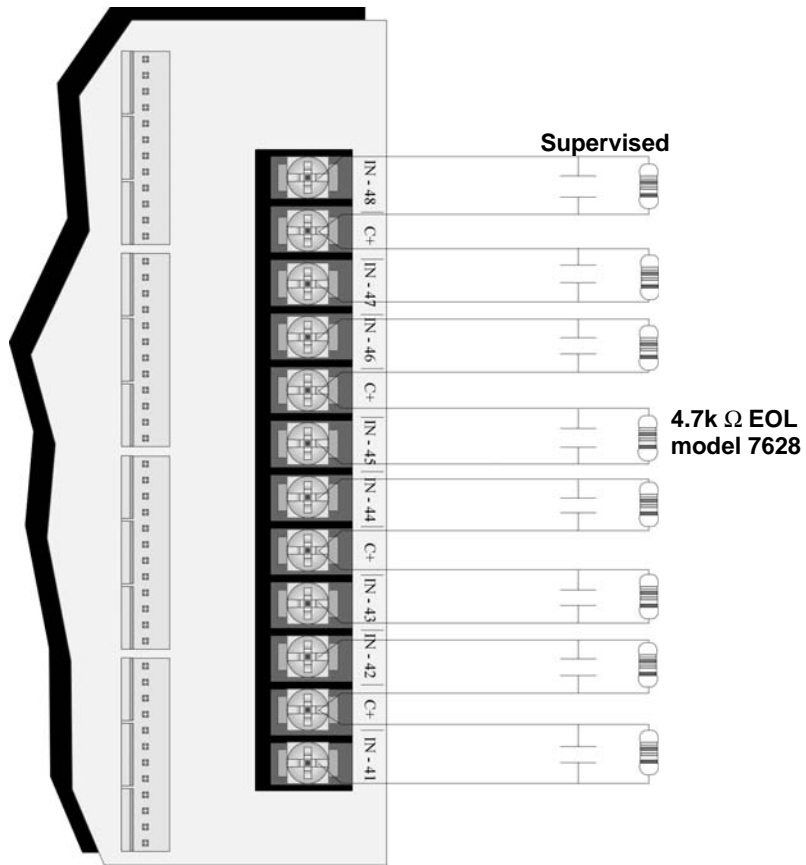

Figure 4-23 Dry Contact Wiring

4.9 5865-3 / 5865-4 LED Annunciator Installation

The 5865-3 and 5865-4 are LED annunciators. The 5865-4 has 30 mappable LEDs, remote silence and reset key switches, and a general system trouble LED. The 5865-3 has 30 mappable LEDs only. These are arranged as 15 pairs of red (typically used for alarm) and yellow (typically used for trouble) LEDs.

Installation of the 5865-5 and 5865-4 is identical. The key switches and the trouble LED follow the behavior of other system annunciators and do not require any installation steps. The following sub-sections describe how to install the 5865-3 and 5865-4 hardware. Refer to Section 6 for programming information.

Note: This manual uses “5865” when referring to aspects of the 5865-3 and 5865-4 that are common to both models.

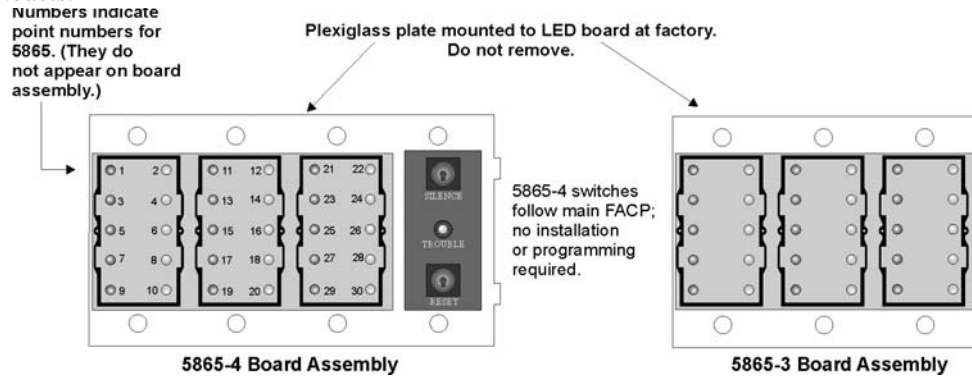

Figure 4-24 5865-3 and 5865-4 Assembly (front view)

4.9.1 5865 Connection to Panel

The 5865 connects to the panel via the SBUS. Make connections as shown in Figure 4-25. After the 5865 is connected to the panel, it must be added to the system. This programming step is described in Section 4.10.

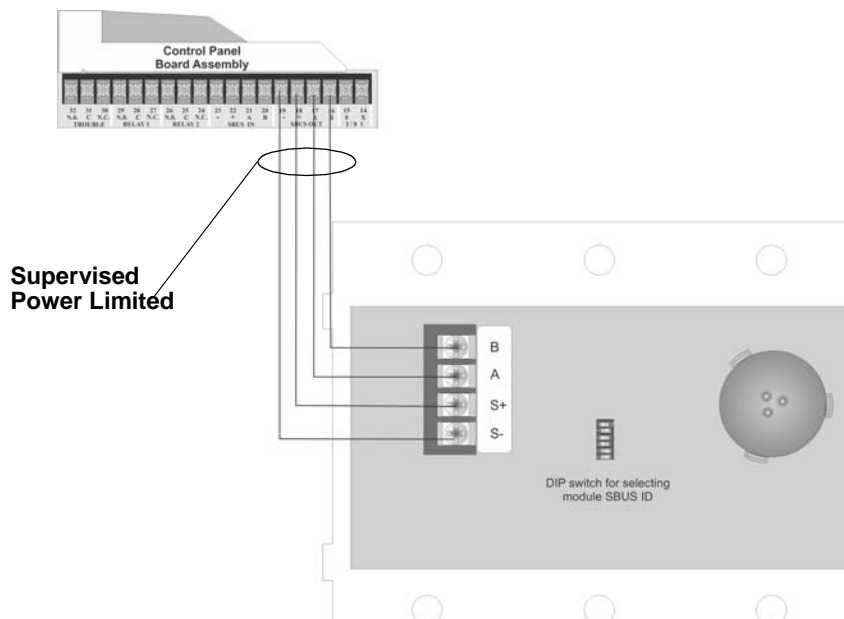

Figure 4-25 5865 Connection to the FACP

4.9.2 5865 Mounting

Mount the 5865-4 to a standard 4-gang electrical box. Mount the 5865-3 to a standard 3-gang electrical box. In Figure 4-26, the 5865-4 attached to a 4-gang box is used as an example.

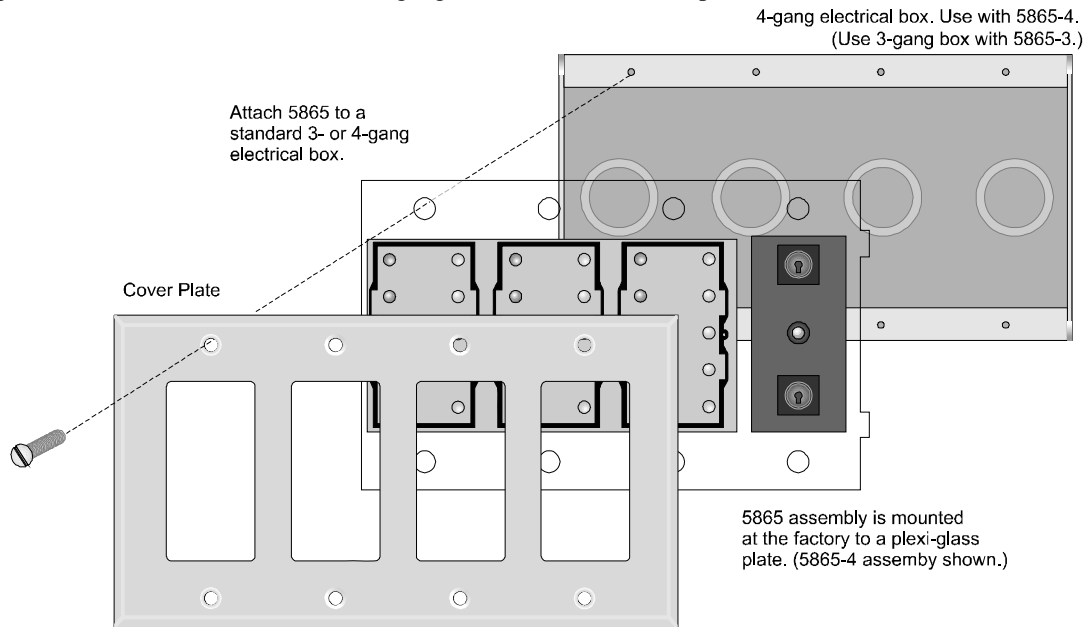

Figure 4-26 5865 Mounting Example

The 5865 ships with a set of zone description labels that can be inserted into the 5865 board assembly. These labels can be used in a typewriter or can be written on by hand. Slide the labels under the plexiglass as shown in Figure 4-27. The LEDs will show through the label when illuminated.

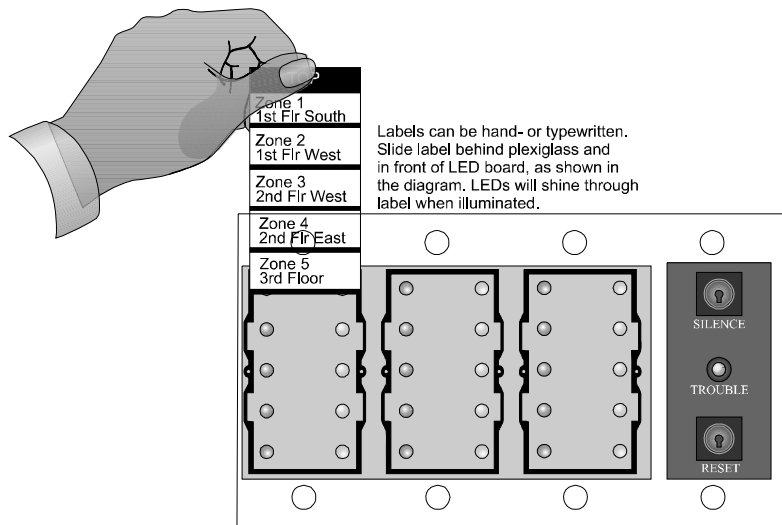

Figure 4-27 Inserting Zone Description Labels

4.10 Configuring Modules

This section describes how to configure any system hardware modules that have been added to the system.

4.10.1 Assigning SBUS Module IDs

When installing a hardware module (such as, 5815XL, 5824, 5860, 5496, 5895XL, 5865-3, 5865-4, EVS-50W, EVS-125W, EVS-100W, EVS-RVM, or EVS-VCM), you must use the DIP switches on the module to assign an ID# to the module.

Figure 4-28 shows all possible DIP switch positions and their correlation to a numerical ID. For example, to select ID 2, place DIP switch 2 in the up position.

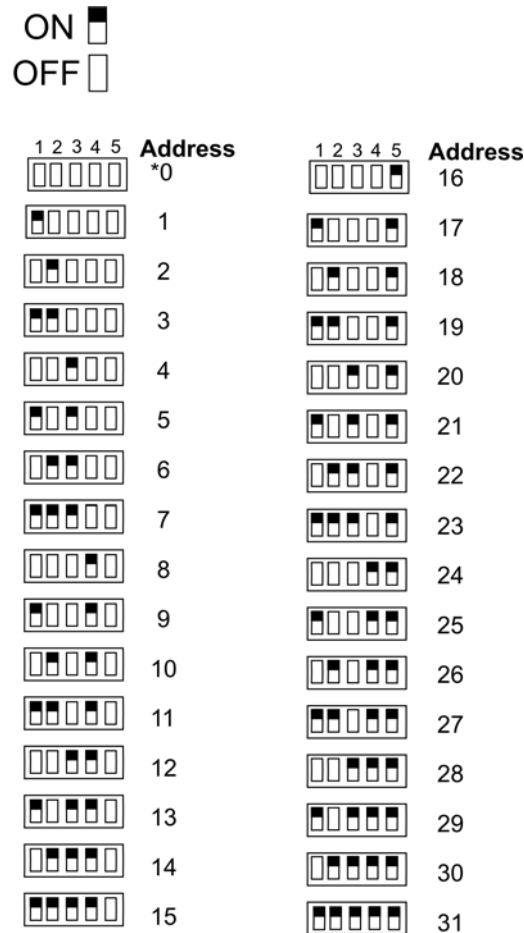

*Note: Address 0 cannot be used.

Figure 4-28 Possible module addresses

Refer to Section 7.2 to edit, add, delete, and view module list.

4.11 Telephone Connection

Connect the telephone lines as shown in Figure 4-29. The Model 7860 phone cord is available from Silent Knight for this purpose.

A number of programmable options are available for customizing telephone lines. These options are described in Section 7.6.

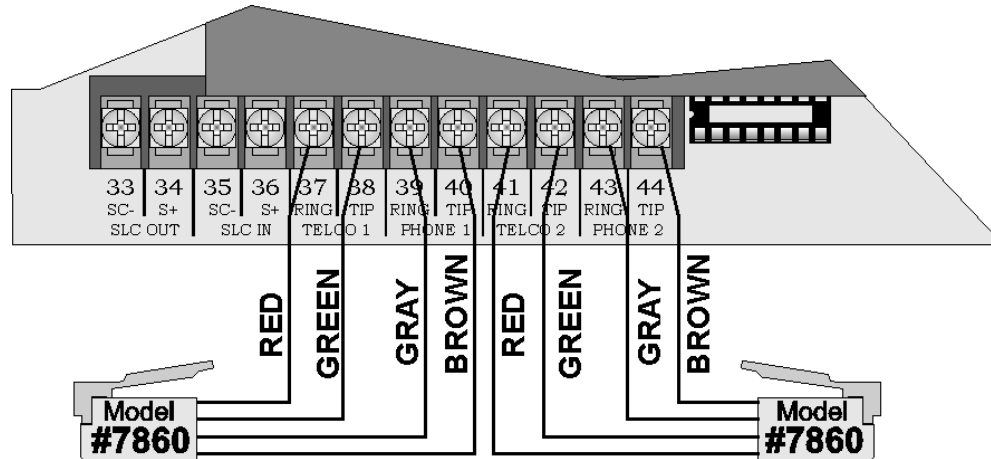

Figure 4-29 Connection of Telephone Lines

4.12 Flexputs™ I/O Circuits

The six Flexput™ circuits are an innovative and versatile feature of the control panel. They can be used as: Class A or B notification circuits, Class A or B initiation circuits (either 2 or 4 wire detectors), or as auxiliary power (resettable, continuous, door holder, or sounder sync).

The polarity of the Flexput terminals differs depending on whether the circuit is programmed as an input or an output circuit. If the circuit is programmed as an input circuit (for a detector or normally open contact) the X terminal is negative and O terminal is positive. If the circuit is programmed as an output circuit (Aux power or NAC) then the X terminal is positive and the O terminal is negative.

This section of the manual explains how to install conventional notification appliances and initiating devices to be used with the system.

4.12.1 Conventional Notification Appliance

This sub-section of the manual explains how to install conventional notification appliances for Class A (Style Z) and Class B (Style Y) configurations.

4.12.1.1 Class B Notification Wiring

You must use an appliance from the list of compatible appliances in the Appendix A at the back of this manual.

To install a circuit:

1. Wire Class B Notification appliances as shown in Figure 4-30.
2. Configure the circuit through programming (see Section 7.5).

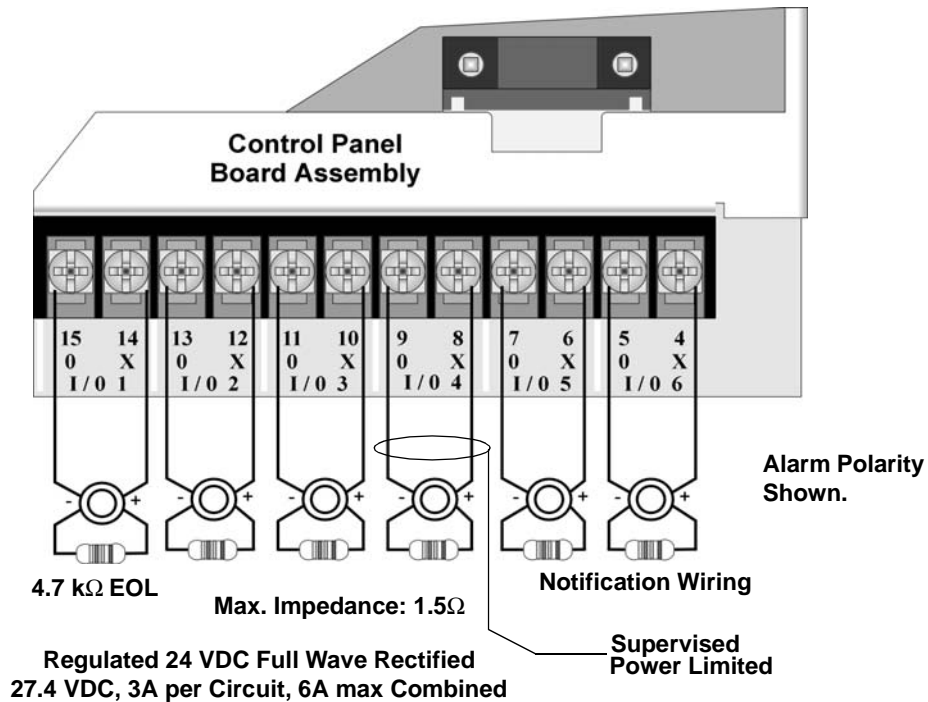

Figure 4-30 Class B Notification Appliance Circuit Wiring

4.12.1.2 Class A Notification Wiring

You must use an appliance from the list of compatible appliances in the Appendix at the back of this manual.

To install a Class A notification appliance circuit:

1. Wire the Class A notification appliances as shown in Figure 4-31.

Caution

For proper system supervision do not use looped wire under terminals marked O and X of the Flexput connectors. Break wire runs to provide supervision of connections.

2. Configure the circuit for Class A in programming (see Section 7.5).

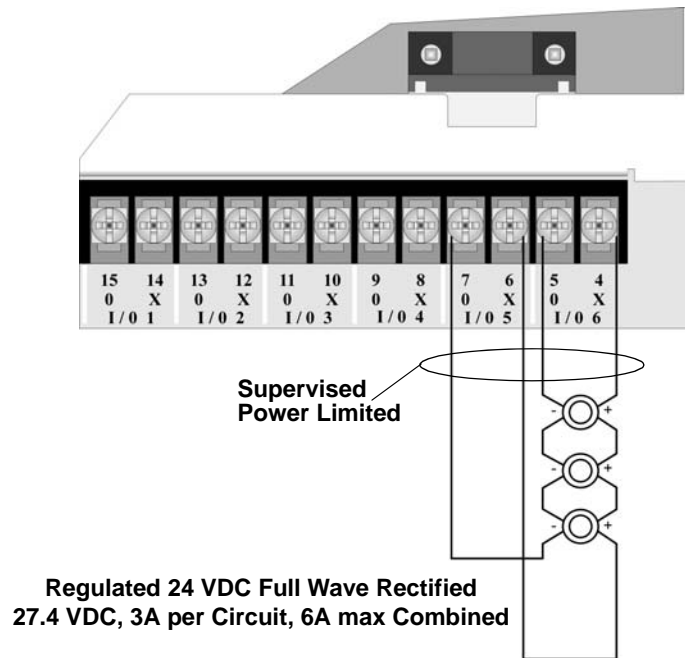

Figure 4-31 Class A Notification Appliance Circuit Configuration

Note: In programming any point that uses multiple Flexput circuits, the lowest Flexput circuit number is used to refer to the circuit pair. For example, Figure 4-31 uses both Flexput circuit 5 and 6, so in programming it would be referred to as point 5.

4.12.2 Conventional Input Switch Circuits

This section of the manual explains how to install conventional initiating devices for Class A (Style D) or Class B (Style B) configurations.

4.12.2.1 Class B Inputs

You can connect conventional Class B switches, such as waterflow switches and pull stations, directly to the Flexput circuits of the control panel.

To install a Class B switch:

1. Wire the Class B switch as shown in Figure 4-32.
2. Configure the circuit through programming (see Section 7.5).

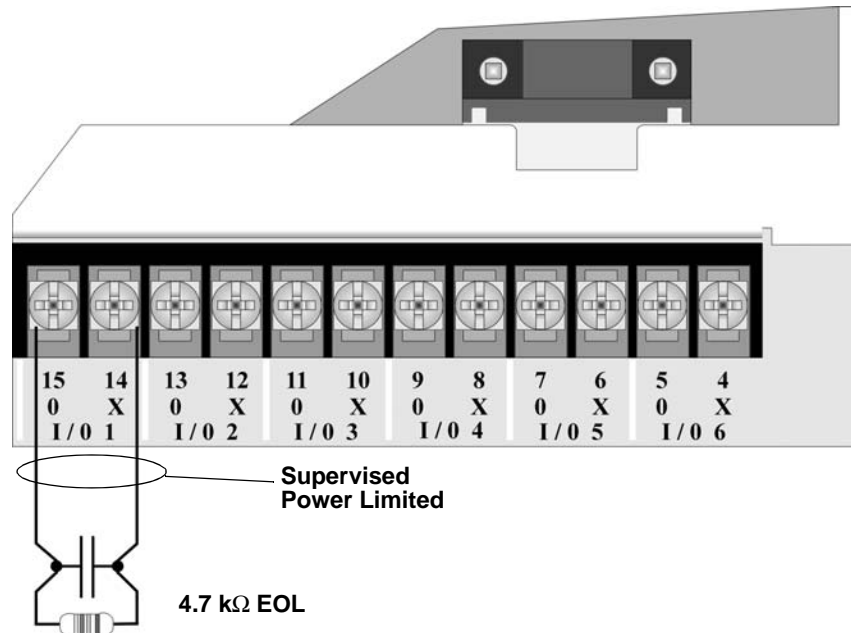

Figure 4-32 Class B Input Switches

4.12.2.2 Class A Inputs

You can connect conventional Class A switches, such as waterflow switches and pull stations, directly to the Flexput circuits of the control panel.

To install a Class A switch:

1. Wire the Class A switch as shown in Figure 4-33.

Caution

For proper system supervision do not use looped wire under terminals marked + and – of the Flexput connectors. Break wire runs to provide supervision of connections.

- Configure the circuit through programming (see Section 7.5).

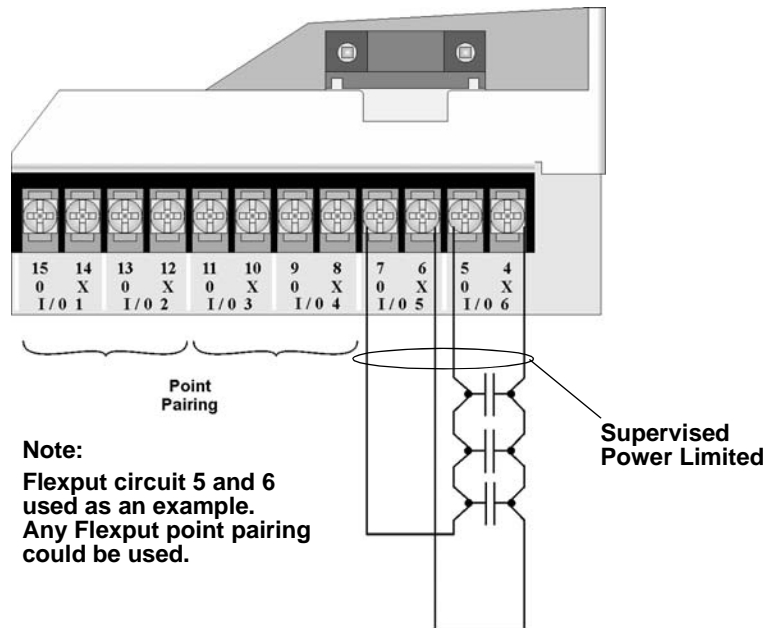

Figure 4-33 Class A initiating Switches

Note: In programming any point that uses multiple Flexput circuits, the lowest Flexput circuit number is used to refer to the circuit pair. For example, Figure 4-33 uses both Flexput circuit 5 and 6, so in programming it would be referred to as point 5.

4.12.3 Installing 2-Wire Smoke Detectors

Any compatible UL listed two-wire smoke detector can be used with the control panel (see Appendix A for list of compatible smoke detectors). Figure 4-34 and Figure 4-35 illustrate how to connect a UL listed 2-wire detector to the control panel.

4.12.3.1 Installing 2-Wire Class B Smoke Detectors

To install a Class B two-wire smoke detector, wire as shown in Figure 4-34.

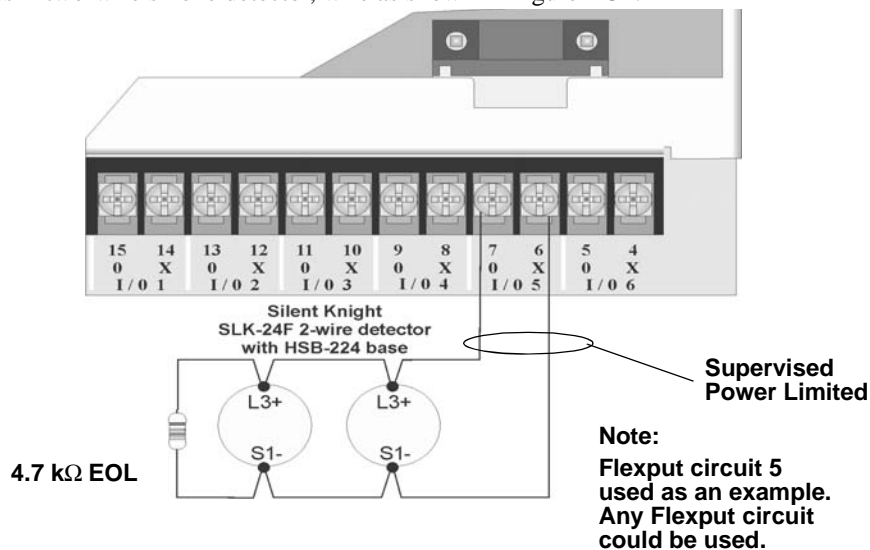

Figure 4-34 Two-Wire Class B Smoke Detector

4.12.3.2 Installing 2-Wire Class A Smoke Detectors

To install a Class A two-wire smoke detector, wire as shown in Figure 4-35.

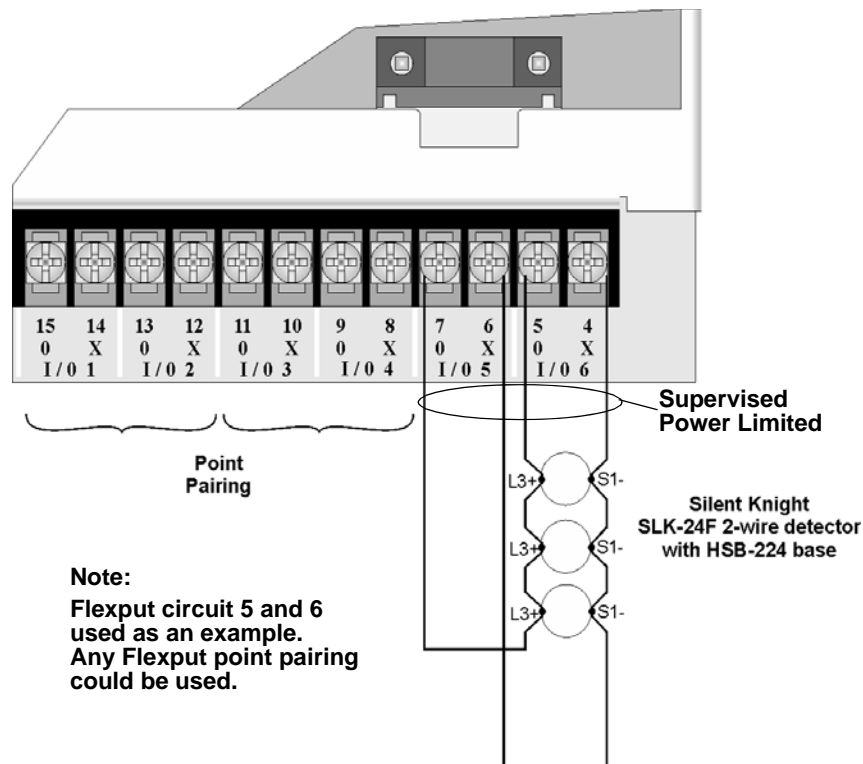

Figure 4-35 Two-Wire Class A Smoke Detector Connections

Note: In programming any point that uses multiple Flexput circuits, the lowest Flexput circuit number is used to refer to the circuit pair. For example, Figure 4-35 uses both Flexput circuit 5 and 6, so in programming it would be referred to as point 5.

4.12.4 Installing 4-Wire Smoke Detectors

Any compatible UL listed four-wire smoke detector can be used with the control panel (see Appendix A for list of compatible smoke detectors). Figure 4-34 and Figure 4-35 illustrate how to connect a UL listed four-wire detector to the control panel.

4.12.4.1 Installing 4-Wire Class B Smoke Detectors

Figure 4-36 illustrates how to install a 4-wire Class B smoke detector.

Conventions used for wiring 4-wire Class B loops:

1. Up to three Class B 4-wire smoke detector loops can be connected to the control panel at once.
2. Each Class B loop input is paired with a unique power source as shown in Figure 4-36.

- Each loop gets smoke power from the even numbered Flexput circuit and the contact input is connected to the odd numbered Flexput circuit.

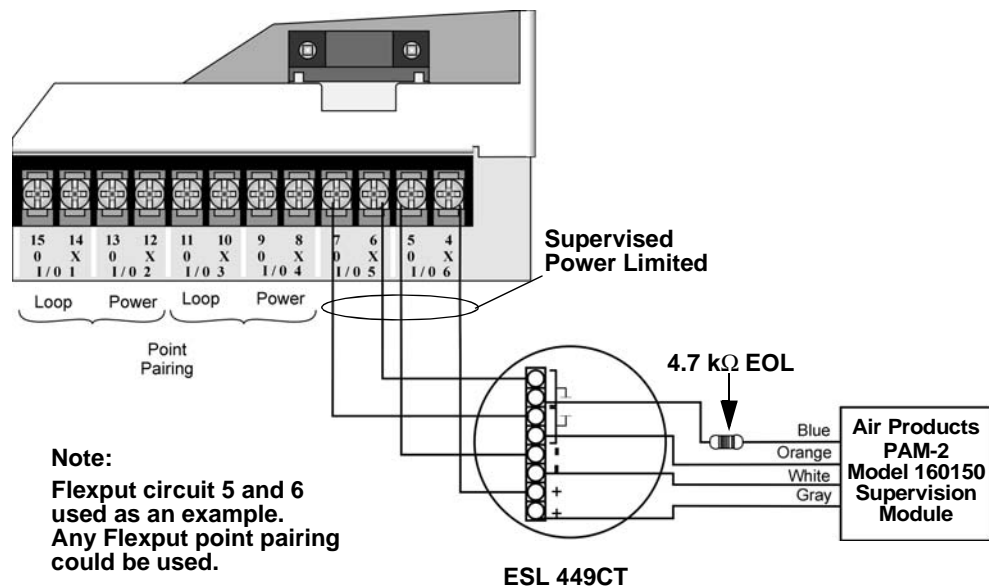

Figure 4-36 Class B 4-Wire Smoke Detector Connections

Note: In programming any point that uses multiple Flexput circuits, the lowest Flexput circuit number is used to refer to the circuit pair. For example, Figure 4-36 uses both Flexput circuit 5 and 6, so in programming it would be referred to as point 5.

4.12.4.2 Installing 4-Wire Class A Smoke Detectors

Figure 4-37 illustrates how to install a 4-wire Class A detectors.

Conventions used for wiring 4-wire Class A loops:

- Up to two Class A 4-wire loops can be connected to the control panel at once.
- Smoke power is supplied to each Class A loop as shown in Figure 4-37.

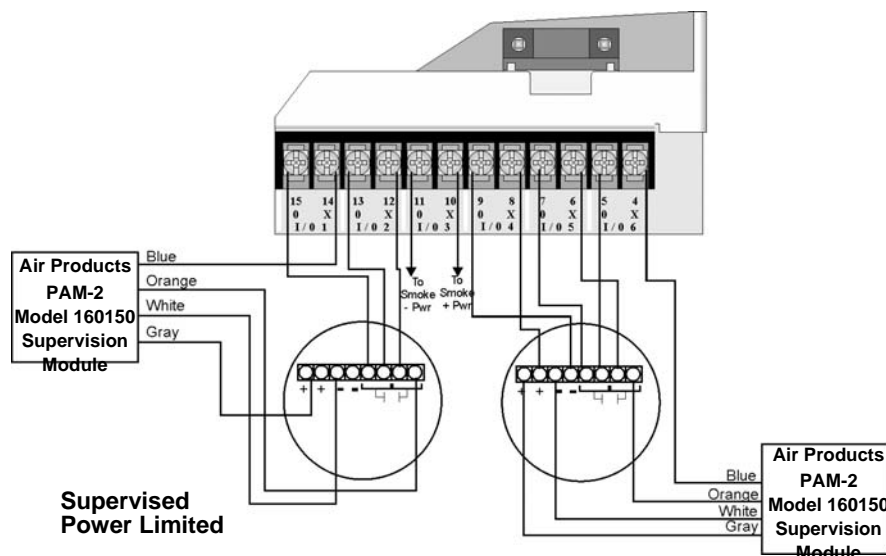

Figure 4-37 Class A 4-Wire Smoke Detector Connections

Note: In programming any point that uses multiple Flexput circuits are always referred to as the lowest Flexput circuit number used. For example, Figure 4-37 uses Flexput circuits 1, 2, 3 together and 4, 5, 6 together. In programming (1, 2, 3) would be referred to as point 1, and (4, 5, 6) would be referred to as point 4.

4.12.5 Auxiliary Power Installation

Flexput Circuits 1-6 on the control panel can be used as auxiliary power circuits. The four types of auxiliary power available are:

- Door Holder Power (see Section 4.12.5.1)
- Constant Power (see Section 4.12.5.2)
- Resettable Power (see Section 4.12.5.3)
- Sounder Sync Power (see Section 4.12.5.4)

Auxiliary power circuits are power limited. Each circuit can source up to 3A (total current for all Flexput circuits must not exceed 6.0 A).

To install an auxiliary power circuit:

1. Wire the Flexput circuit(s) that will be used for auxiliary power. See Figure 4-38 for location of Flexput circuits.
2. Configure the auxiliary power output through programming (see Section 7.5).

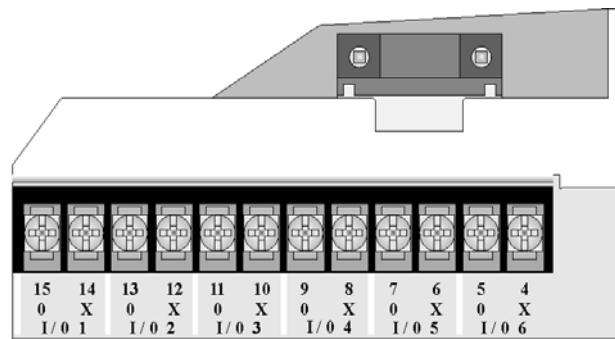

When used as auxiliary power, terminals labeled "O" are negative, terminals labeled "X" are positive.

Figure 4-38 Flexput Circuit Location

4.12.5.1 Door Holder Power

Door holder power is intended for fire door applications. When there are no alarms in the system and the panel has AC power, door holder circuits have 24-volt power present at their terminals. Any alarm will cause power to disconnect. Power will be re-applied when the system is reset. If AC power is off for more than 15 seconds, the auxiliary door holder power will be disconnected to conserve the battery backup. When AC power is restored, power is immediately restored to the door holder circuits.

Use a UL listed door holder ESL DHX-1224, for this application.

4.12.5.2 Constant Power

Use constant power for applications that require a constant auxiliary power source. Power is always present at Constant circuits.

4.12.5.3 Resettable Power

Resettable power is typically used to power beam detectors, flame detectors and conventional 4-wire smoke detectors. For circuits selected as Resettable, 24-volt power is always present at the terminals unless a system reset occurs. If a system reset occurs, power is disconnected from the terminals for 30 seconds, then re-applied.

4.12.5.4 Sounder Sync Power

Sounder Sync Power continuously outputs the System Sensor synchronization pattern and is intended for use with B200S sounder bases.

4.13 On-Board Relays (Conventional)

The control panel has two built-in programmable relays and a built-in trouble relay. All relays are Form C rated at 2.5 A @ 24 VDC.

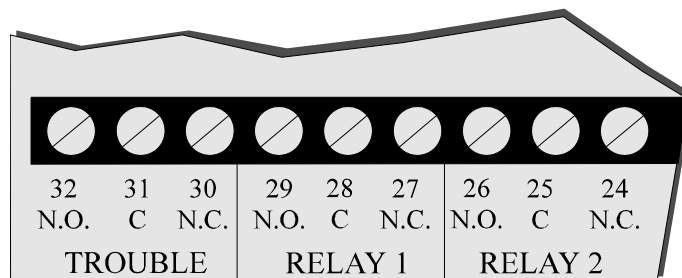

Figure 4-39 Location of Conventional Relay Circuits

4.13.1 Trouble Relay

The control panel has a dedicated Form C trouble relay built into terminals 30-32. The relay provides a normally open and a normally closed contact. The trouble relay will deactivate under any trouble condition.

Note: The N.C. contact is the relay contact that is closed when the panel has power and there are no trouble conditions.

4.13.2 Programmable Relays

The control panel has two Form C programmable relays built into terminals 24-29. Each relay provides a normally open and a normally closed contact.

To install one or two programmable relays, follow these steps.

1. Wire Relay 1 and/or Relay 2 as needed for your application. See Figure 4-39 for the location of the relay terminals.
2. Configure the relay through programming (see Section 7.5).

4.14 Remote Station Applications

4.14.1 Keltron Model 3158 Installation

The control panel is compatible with Keltron Model 3158, used for direct connection to a Keltron receiver. The 3158 reports alarms, supervisories, and troubles.

The steps for connecting the 3158 to the control panel. Refer to the 3158 installation instructions for complete information.

1. Wire the 3158 to the control panel as shown in the connection list and Figure 4-40.
2. Wire the 3158 within 20 feet of the control panel. Wiring must be enclosed in conduit.
3. Program control panel Relay 1 for alarm.
4. Program Flexput circuit 5 for alarm.

- Program Flexput circuit 6 for supervisory non latching.

Table 4-3: Keltron 3158 to Control Panel Connections

Terminal #	Connects To
3158 Term. 1	To Keltron receiving equipment
3158 Term. 2	To Keltron receiving equipment
3158 Term. 3	Earth ground
3158 Term. 4	Not used; no connection.
3158 Term. 5	Control panel Term. 18
3158 Term. 6	Control panel Term. 19
3158 Term. 7	Control panel Term. 7

Terminal #	Connects To
3158 Term. 8	Control panel Term. 28
3158 Term. 9	Control panel Term. 5
3158 Term. 10	Control panel Term. 4
Control panel Term. 6	Control panel Term. 29
Control panel Term. 28	Control panel Term. 31
Control panel Term. 29	Control panel Term. 30

Not suitable for remote station protected premise service where separate transmission circuits are required for fire supervisory (if applicable), and trouble signals.

Intended for connection to a polarity reversal circuit of a remote station receiving unit having compatible ratings.

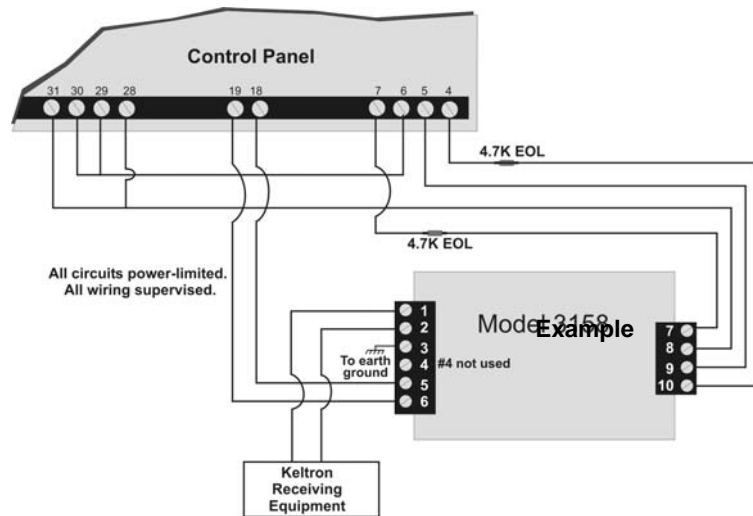

Figure 4-40 Keltron 3158 Connection to Control Panel

4.14.2 City Box Connection Using the 5220 Module

This section describes how to connect the control panel to a local energy municipal fire alarm box or “city box” as required by NFPA 72 Auxiliary Protected Fire Alarm systems for fire alarm service. The city (master) box is an enclosure that contains a manually operated transmitter used to send an alarm to the municipal communication center which houses the central operating part of the fire alarm system.

City Box Standby Current: 0 (Notification supervision current accounted for in control panel draw).

Alarm Current: 1 Amp for 1 second 27.2 VDC max

The maximum coil and wire resistance (combined) must not exceed 30 ohms.

To install the 5220 for city box connection:

- Use one of the knockouts on the right side of the control panel to connect the 5220 using a short piece of conduit (must not exceed 20 feet in length).
- Wire the 5220 to the control panel as shown in Figure 4-41. This drawing also shows how to connect the city box coil to terminals 3 and 4 on the 5220. Do not install an EOL resistor in the terminals of the Flexput circuit used for this application.
- Connect earth ground wire to the 5220 chassis with mounting screw.

4. Program the Flexput circuit used as a notification circuit, continuous and non-silencing. Refer to Section 7.5 for point programming, Section 7.5 for group settings, and Section 7.3 for zone settings and mapping.

It is not possible to reset the remote indication until you clear the condition and reset the control panel.

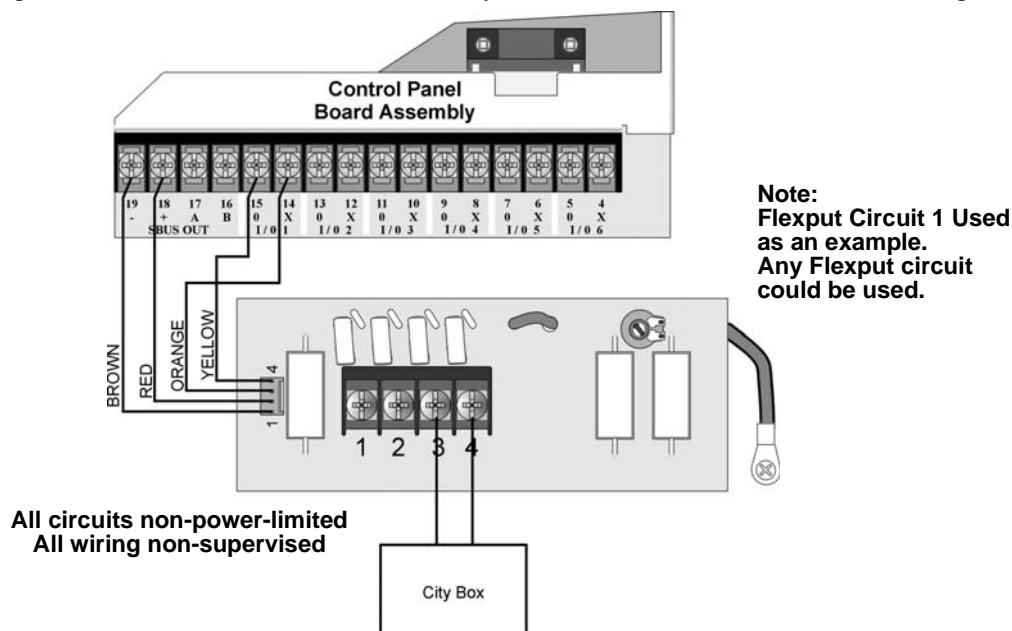

Figure 4-41 City Box Connection

4.14.3 NFPA 72 Polarity Reversal

Note: Intended for connection to a polarity reversal circuit of a control unit at the protected premises having compatible rating.

4.14.3.1 Using the 5220 Module

When the 5220 is wired and programmed for polarity reversal, it reports alarm and trouble events to a remote site. Alarms will override trouble conditions and it will not be possible to reset the remote indicator until the condition is cleared and the control panel is reset.

If an alarm condition occurs, the alarm relay will close, overriding the trouble condition.

Standby Current: 100 mA, 24 VDC
 Alarm: 100 mA, 24 VDC

To install the 5220 for polarity reversal, follow the steps below:

1. Locate the knockout on the right side of the control panel cabinet to connect the 5220 using a short piece of conduit (must not exceed 20 feet in length).
2. Wire the 5220 to the control panel using the four-wire pigtail provided as shown in Figure 4-42. This diagram also shows how to connect the 5220 to the remote indicator. Do not install an EOL resistor in the terminals of the Flexput circuit used for this application.
3. Connect earth ground wire to the 5220 chassis with mounting screw.
4. Program the Flexput circuit used as a notification circuit, continuous and non-silencing. Refer to Section 7.5 for point programming, Section 7.4 for group settings, and Section 7.3 for zone settings and mapping.

- If necessary, adjust loop current using the potentiometer (R10) on the 5220 board. Normal loop current is 2-to-8 mA with a 1k ohm remote station receiving unit. Maximum loop resistance is 3k ohm.

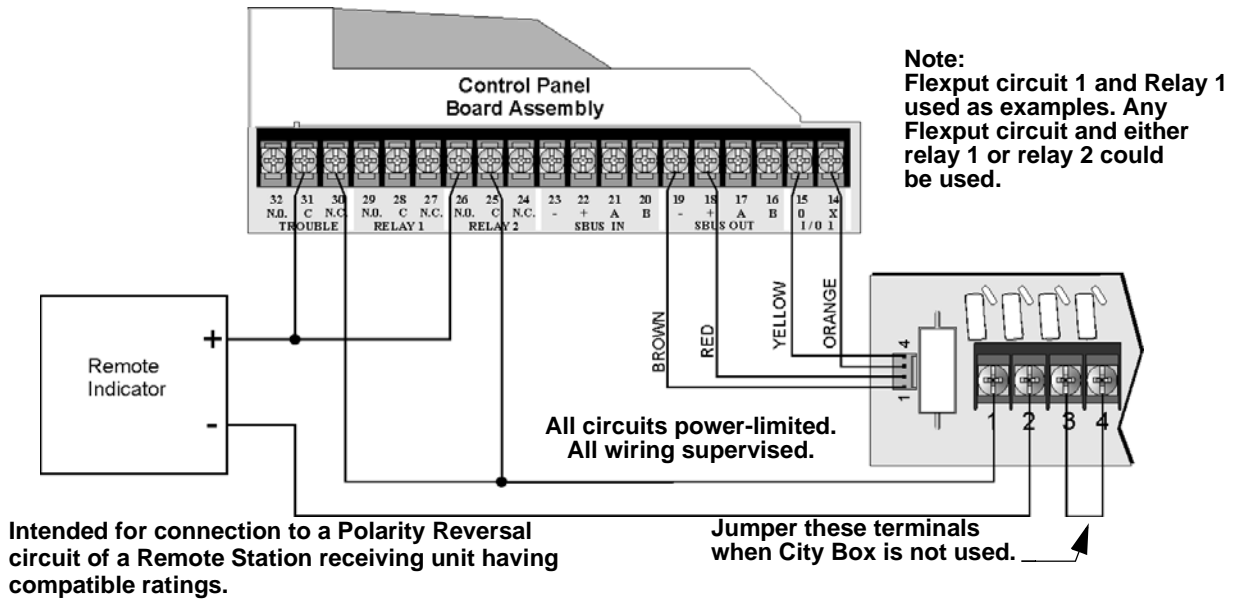

Figure 4-42 Polarity Reversal Connection Using the 5220 Module

4.14.3.2 Using the 7644-L8* Module

When the 7644 is used for polarity reversal, it allows alarm and trouble events to be reported to a remote site. Alarms will override trouble conditions and it will not be possible to reset the remote indicator until the condition is cleared and the control panel is reset.

To install the 7644-L8 for polarity reversal:

- Wiring the 7644-L8 to the control panel as shown in Figure 4-43. Do not install an EOL resistor on the terminals of the Flexput circuit used.

Note: Use only Flexput circuits on the control panel for reverse polarity.

- Program the Flexput circuit as a notification circuit. See Section 7.5.2.
- Map the group to activate constant on from the zone event. See Section 7.3.1.3.
- Program the output group characteristics as non-silenceable and reverse polarity. See Section 7.4.1.2.

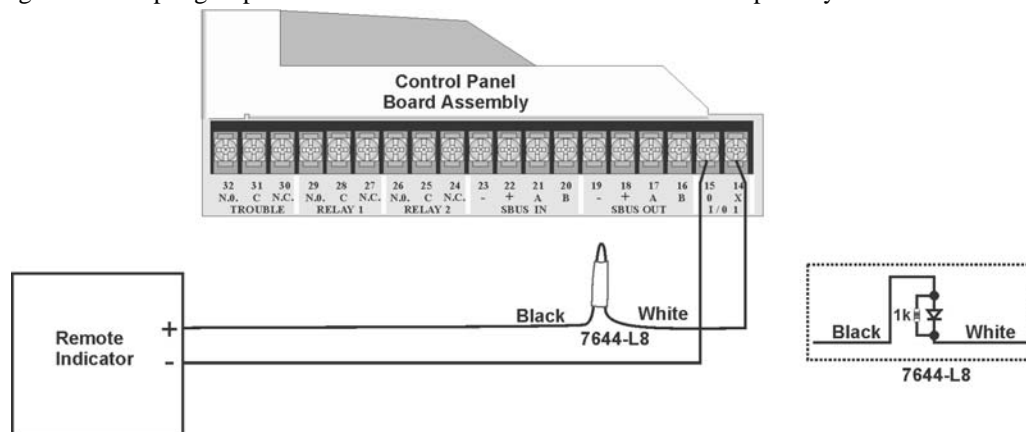

Figure 4-43 Polarity Reversal Connection Using the 7644-L8

*Note: *When ordering, request as P/N 7644-L8*

4.14.4 Using the SD500-ARM Addressable Relay Module

When the SD500-ARM is wired for polarity reversal, it reports alarm and trouble events to a remote site. Alarms will override trouble conditions and it will not be possible to reset the remote indicator until the condition is cleared and the control panel is reset.

Wire the SD500-ARM as shown in Figure 4-44.

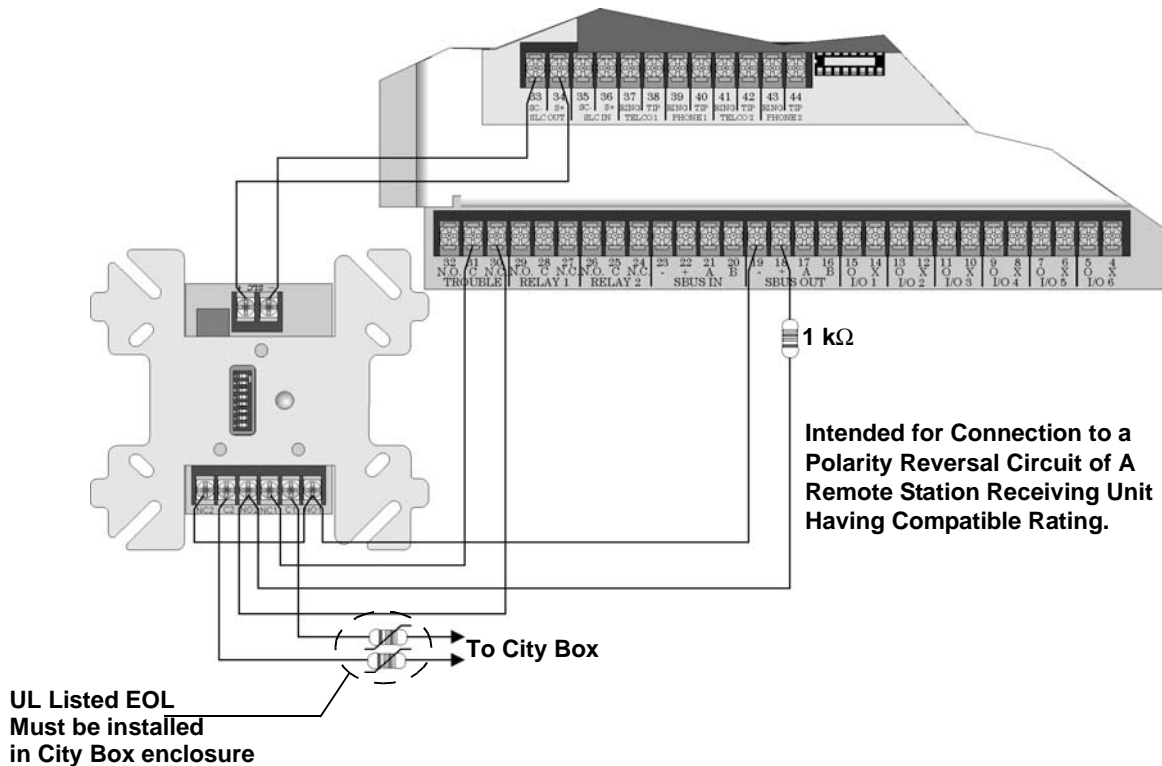

Figure 4-44 Polarity Reversal Connection Using the SD500-ARM Module

4.14.5 Using a MR-201/T Control Relay From Air Products

When the MR-201/T control relay is wired for polarity reversal, it reports alarm and trouble events to a remote site. Alarms will override trouble conditions and it will not be possible to reset the remote indicator until the condition is cleared and the control panel is reset.

If an alarm condition occurs, the alarm relay will close, overriding the trouble condition.

- Current: 15 mA max.
- Operating Voltage: 24 VDC nominal
- Resistance: 4 KΩ

To install the MR-201/T for polarity reversal, follow the steps below:

1. Wire the MR-201/T as shown in Figure 4-45.

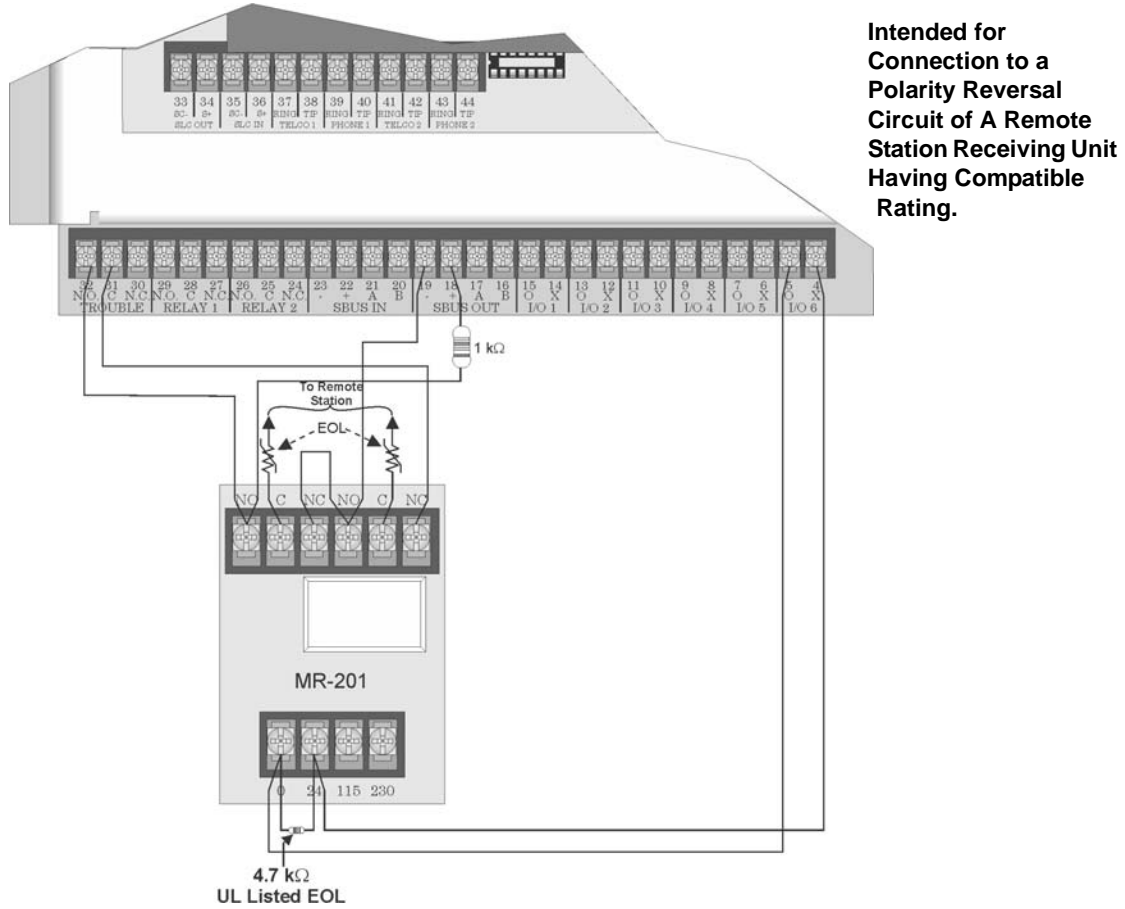
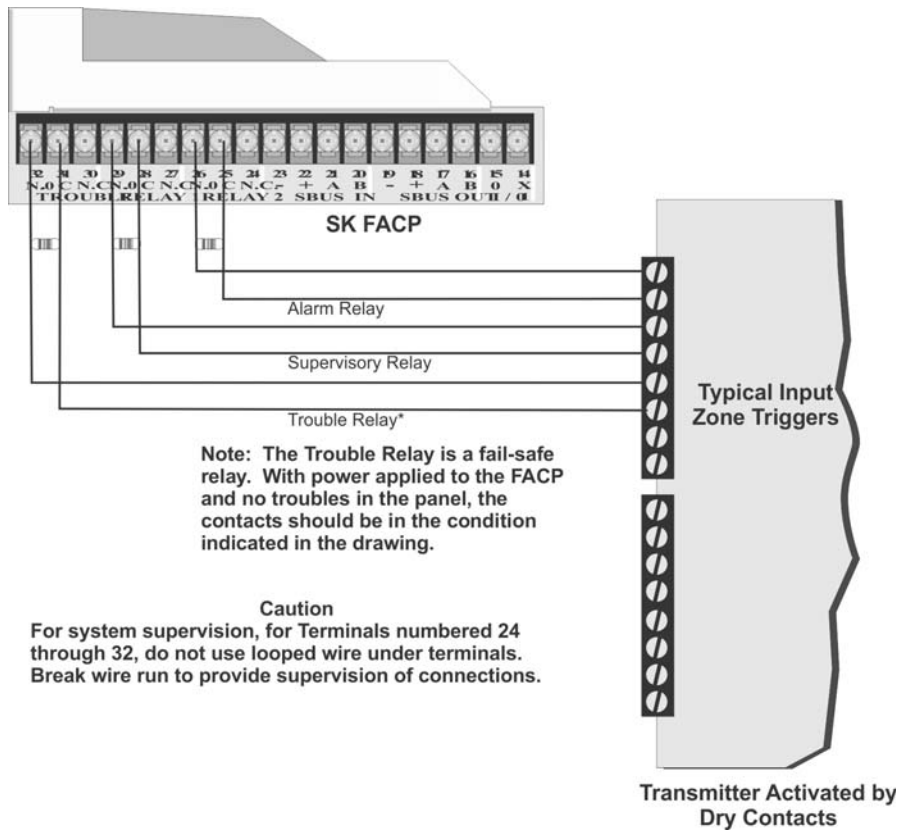

Figure 4-45 Wiring the MR-201/T

2. Program the Flexput circuit for non silence NAC circuit (see Section 7.5).

4.14.6 Transmitter Activated by Dry Contacts

This section describes the connection of a UL 864 listed remote station transmitter to the 5820XL / 5820XL-EVS FACP dry contacts. The FACP contacts must be supervised by the remote station transmitter module using end-of-line resistors (ELRs) with a value determined by the transmitter manufacturer. Power is also provided by the remote station transmitter manufacturer. Refer to the remote station transmitter manufacturer’s manual for details.



Section 5

SK SLC Device Installation

Caution!

To avoid the risk of electrical shock and damage to the unit, power should be OFF at the control panel while installing or servicing.

5.1 List of SK SLC Devices

The following SK SLC devices can be used with the control panel. SK detectors include a 6" base. See the appropriate section number in this manual or the device installation instructions (packaged with the device) for more information.

Note: The control panel supports the use of either SK SLC devices or SD SLC devices. You cannot install both SLC device types on the control panel.

SK Part Number	Model Name/Description	Installation Instruction PN
SK-Photo	Photoelectric smoke detector	156-3426-001
SK-Photo-T	Photoelectric smoke detector with thermal (135°F)	
SK-PhotoR	Photoelectric detector with remote test capability	
SK-Acclimate	Multicriteria photoelectric smoke detector with thermal (135°F)	
SK-Beam	Reflected beam smoke detector without test feature	156-3433-001
SK-Beam-T	Reflected beam smoke detector with test feature	
SK-Ion (obsolete)	Ionization smoke detector	156-3428-001
SK-Duct	Photoelectric duct smoke detector with extended air speed range	156-3432-000
SK-Heat	Fixed temperature thermal detector (135°F)	156-3429-000
SK-Heat-ROR	Rate-of-rise thermal detector with 135° fixed temperature	
SK-Heat-HT	Fixed high temperature thermal detector (190°F)	
SK-Pull-SA	Addressable single action pull station	156-3446-000
SK-Pull-DA	Addressable dual action pull station	156-3447-000
SK-Iso	Fault isolator module	156-3445-000
ISO-6	Six fault isolator module	156-4096-000
SK-Monitor	Monitor module	156-3442-000
SK-Minimon	Mini monitor module	156-3444-000
SK-Monitor-2	Dual input monitor module	156-3435-000
SK-Mon-10	10 input monitor module	156-3443-000
SK-Relay	Addressable relay module	156-3438-000
SK-Relay-6	Six relay control module	156-3439-000
SK-Relaymon-2	Dual relay/monitor module	156-3735-000
SK-Zone	Addressable zone interface module	156-3440-000
SK-Zone-6	Six zone interface module	156-3441-000
SK-Control	Supervised control module	156-3436-000
SK-Control-6	Six circuit supervised control module	156-3437-000
SK-Fire-CO	CO Smoke Detector	156-3945-000

SK Part Number	Model Name/Description	Installation Instruction PN
B200S	Sounder Base	I56-3387-00
B201LP	6" mounting base	I56-0595-00
B224BI	6" isolator base	I56-0725-00
B224RB	6" relay base	I56-3737-00
B200SR	Sounder base	I56-3392-00
B501	4" mounting base	I56-0357-00
B200SR-LF	Low Frequency Sounder Base	I56-4152-00
B200S-LF	Low Frequency Sounder Base	I56-4151-00

5.2 List of SD SLC Devices

The following SD SLC devices can be used with the control panel. SD detector bases are sold separately. See the appropriate section number in this manual or the device installation instructions (packaged with the device) for more information.

Note: The control panel supports the use of either SD SLC devices or SK SLC devices. You cannot install both SLC device types on this control panel.

SD Model Number	Model Name/Description	Installation Instruction PN
SD505-PHOTO	Photoelectric smoke detector	150955
SD505-AIS	Ionization smoke detector	
SD505-HEAT	Absolute temperature heat detector. Trip point range from 135°F–150°F (0°C–37°C)	
SD505-6AB	6" base for use with the SD505-HEAT and SD505-PHOTO	150955
SD505-6IB	6" short circuit isolator base for use with the SD505-HEAT and SD505-PHOTO	151175
SD505-6RB	6" relay base for use with the SD505-HEAT and SD505-PHOTO	151192
SD505-6SB	6" sounder base for use with the SD505-HEAT and SD505-PHOTO SLC devices	151191
SD505-DUCT	Duct Housing including the SD505-PHOTO Analog Photoelectric Smoke Sensor. Intake tubing for duct available in three lengths: SD505-T2 (2.5 foot); SD505-T5 (5 foot); SD505-T10 (10 foot)	1700-09882
SD505-DUCTR	Duct Housing with relay including the SD505-PHOTO Analog Photoelectric Smoke Sensor.	
SD500-PS/-PSDA	Single or dual action addressable pull station	151177
SD500-AIM	Addressable input module (switch input), standard size, DIP switch configurable	151071
SD500-MIM	Mini input monitor module (switch input), small size, DIP switch configurable. Fits in single-gang box with manual pull station switch	151071
SD500-ANM	Addressable notification module	151109
SD500ARM	Addressable relay module DIP switch configurable	151091
SD500-SDM	Addressable smoke detector module. Use to assign an address to a loop of conventional devices	151193
SD500-LIM	Line isolator module. Fits in a double gang box	151125
SD505-DTS-K	Remote test switch & LED indicator for the SD505-DUCTR	1700-09882

5.3 Maximum Number of Devices

The 5820XL/5820XL-EVS supports SK or SD devices on one system. The maximum number of devices per system varies depending on device protocol and the number of 5815XL signaling circuit loop (SLC) expanders added to the system. Device support is as follows:

- **SK Devices**—A system can support a total of 396 SK detectors *and* 396 SK modules. 99 devices can be added to 5820XL/5820XL-EVS control panel. Each optional 5815XL adds another 99 detectors and 99 modules. Add up to three 5815XLs to 5820XL/5820XL-EVS system to achieve the maximum number of devices on the system.

OR

- **SD Devices**—5820XL/5820XL-EVS system can support a total of 508 SD SLC detectors and modules, in any combination. 127 devices can be attached to 5820XL/5820XL-EVS control panel. Each optional 5815XL adds another 127 devices. Add up to three 5815XLs to 5820XL/5820XL-EVS system to achieve the 508 point capacity.

5.4 Wiring Requirements for SLC Devices

The following information applies to all SLC devices. Refer to the section that describes the type of device you are installing for details.

5.4.1 Wiring 5815XL in Style 4 (Class B) Configuration

No special wire is required for addressable loops. The wire can be untwisted, unshielded, solid or stranded as long as it meets the National Electric Code 760-51 requirements for power limited fire protective signaling cables. Wire distances are computed using copper wire.

Maximum wiring resistance is 40 ohms for SK device and 50 ohms for SD devices.

Maximum loop length depends on the wire gauge. See Table Table 5-1 and Table 5-2.

Table 5-1 Maximum Distance for SK Devices

Wire Gauge	Max. Distance for SK Modules
22 AWG	1200 feet
18 AWG	3100 feet
16 AWG	4900 feet
14 AWG	7900 feet
12 AWG	10,000 feet

Table 5-2 Maximum wiring distance for SD Devices

Wire Gauge	Max. Distance for SD Modules
22 AWG	1500 feet
18 AWG	3900 feet
16 AWG	6200 feet
14 AWG	10,000 feet

Figure 5-1 and Figure 5-2 show how wire length is determined for out & back tap and T-Tap style wiring.

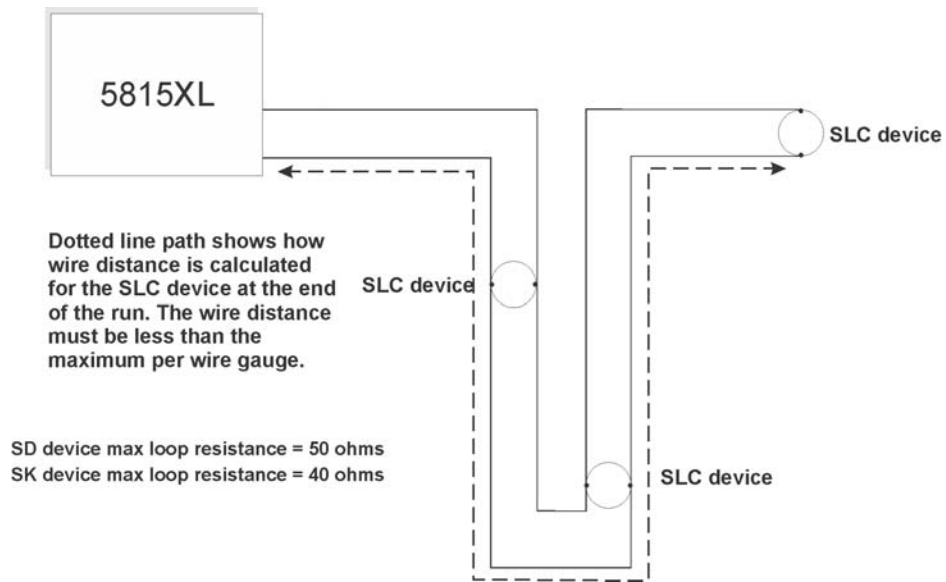

Figure 5-1 Calculating wire run length for a simple out and back

When using T-taps, the total length of all taps and the main bus must not exceed 40,000 feet. This requirement must be met in addition to the maximum distance requirements for the various wire gauges.

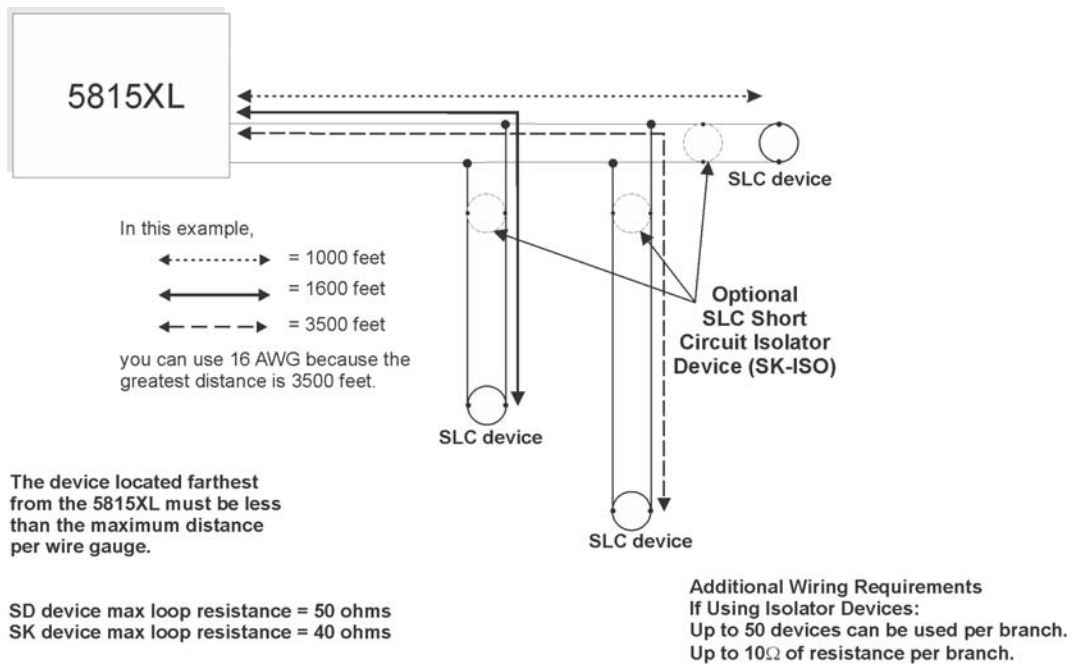

Figure 5-2 Calculating Wire Run Length for a T-tap

5.4.2 Wiring 5815XL in Style 6 & 7 (Class A) Configuration

The following figure illustrates how to wire the SLC loop for Style 6 or Style 7 Class A installations.

Note: Style 6 does not use short circuit isolator devices.

Note: Style 7 wiring requires an isolator module as the first device on the in and the out loops.

Note: No t-taps allowed on class A SLC loops.

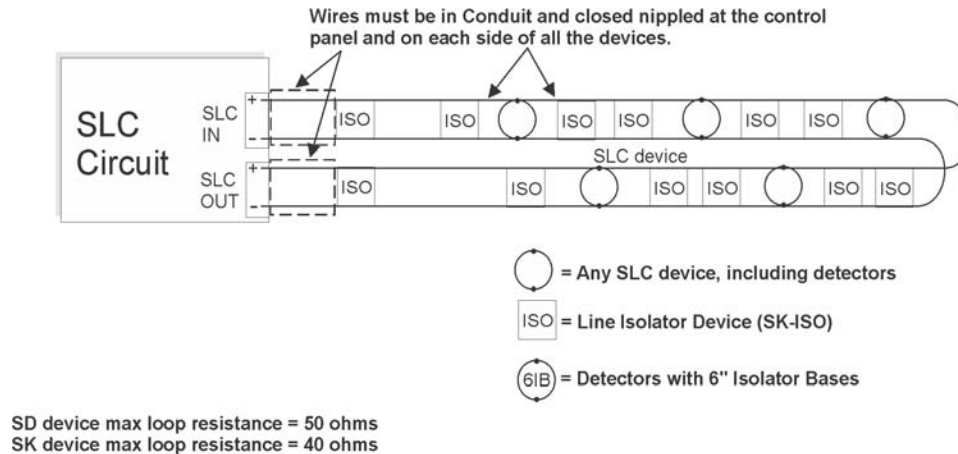

Figure 5-3 Class A SLC Configuration

Caution

For proper system supervision do not use looped wire under terminals marked SLC + and – of the SLC device connectors. Break wire runs to provide supervision of connections.

5.5 Wiring SK SLC Detectors

This section describes how to install SK heat and smoke detectors. All detectors ship with installation instructions. Refer to the detectors’ installation instructions for more detailed information.

This information applies to the following SK models:

- SK-Photo Photoelectric Smoke Detector
- SK-Photo-T Photoelectric Smoke Detector with Thermal
- SK-Acclimate Photoelectric Smoke Detector with Thermal
- SK-Heat Fixed Temperature Detector
- SK-Heat-T High Temperature Thermal Detector
- SK-Heat-ROR Rate-of-Rise Thermal Detector
- SK-Ion Ionization Smoke Detector
- SK-Fire-CO CO Detector

To wire SK detectors:

1. Wire device bases as shown in Figure 5-4.
2. Set the address for each device as described in Section 5.6.

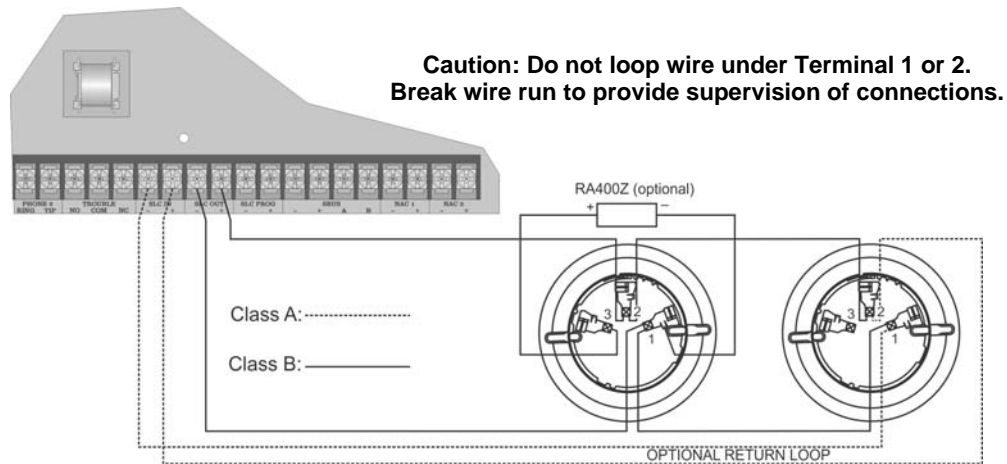

Figure 5-4 Heat and Smoke Detector Connection to the Panel.

5.6 Addressing SK SLC Devices

All SK devices are addressed using the two rotary dials that appear on the device board. Use the *ONES* rotary dial to set the ones place in a one or two digit number, and use the *TENS* rotary dial to set the tens place in a two digit number.

SK device addresses are handled differently than SD device addresses. The control panel recognizes when an SK detector or SK module is installed. For this reason, SK detectors can be assigned any unique address from 1 to 99, and SK modules can be assigned any unique address from 1 to 99. Unlike SD detectors and modules which share addresses 1 through 99, there can be an SK detector using address 1 and an SK module using address 1. 0 is an invalid address.

Example 1: To select device address 1, turn the *ONES* rotary dial to **1** and the *TENS* rotary dial to **0** as shown in Figure 5-5.

Example 2: To select device address 42, turn the *ONES* rotary dial to **2** and the *TENS* rotary dial to **4** as show in Figure 5-5.

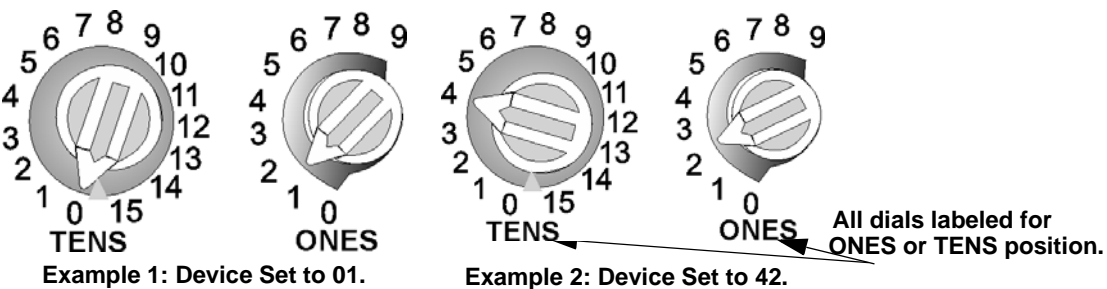

Figure 5-5 SK SLC Device Addressing Using Rotary Dials

5.7 Wiring SD SLC Detectors

This section describes how to install SD heat and smoke detectors. All detectors ship with installation instructions. Refer to each detectors' installation instructions for more detailed information.

This information applies to the following SD models:

- SD505-HEAT Heat Detector
- SD505-PHOTO Photoelectric Smoke Detector

To wire SD505-PHOTO or SD505-HEAT detectors:

1. Wire device bases as shown in Figure 5-6.
2. Set the address for each device as described in Section 5.8.

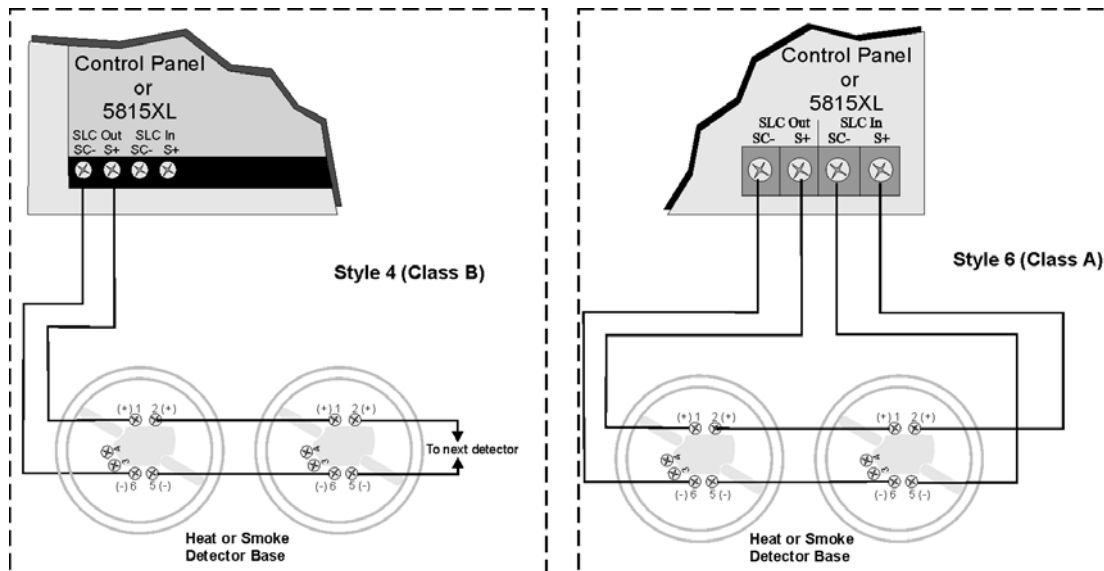

Figure 5-6 Heat or Smoke Detector Connection to the FACP

5.8 Addressing SD Devices

This section explains how to address SD detectors and modules.

5.8.1 SD505-PHOTO or SD505-HEAT

The SD505-PHOTO photoelectric smoke detector and SD505-HEAT heat detector are easily addressed at the FACP. An access code with the option to Set SLC Device Address enabled is required to perform this task.

To address a SD505-PHOTO and SD505-HEAT:

1. Connect a detector base temporarily to the programming terminals as shown in Figure 5-7. (You can use the same base for each detector.)

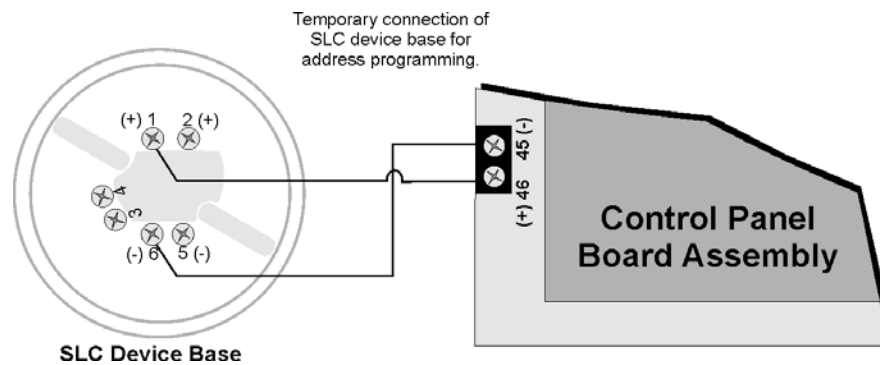



Figure 5-7: Temporary Connection of Detector Base to Panel for Addressing

2. Enter the Installer code. The panel will automatically go to the main menu.
3. Select 2 for Point Functions.
4. Select 3 for Set SLC Device Address.
5. Select “Yes” by pressing the up arrow, then press ENTER. (The panel will go into trouble at this point. You can use the SILENCE key to stop the PZT. The trouble will clear automatically when the panel re-boots when you finish programming.)
6. When the wait message clears, the following options display:
 - 1- for Read Address. Use to read (or check) a single detector’s address.
 - 2- for Write Address. Use to program a single detector’s address.
 - 3- for Seq. Programming. Use to program more than one detector in sequential order.
7. If you are changing addresses, write the programmed address on the back of the device.
8. To exit press left arrow until fully exited.

5.8.2 SLC Devices with DIP Switches

Input and relay module addresses are set using the DIP switches on the module board. The chart below shows the available addresses. For example, to select address 3, place DIP switches 1 and 2 in the up position. The range of valid addresses is 1-127.

0 is an invalid address.

ON 

OFF  **Note: Dip switch 8 must always be OFF.**

1	2	3	4	5	6	7	8	Address	1	2	3	4	5	6	7	8	Address	1	2	3	4	5	6	7	8	Address	1	2	3	4	5	6	7	8	Address
0	0	0	0	0	0	0	0	0	32	0	0	0	0	0	0	0	0	64	0	0	0	0	0	0	0	0	96								
1	1	0	0	0	0	0	0	0	33	1	0	0	0	0	0	0	0	65	1	0	0	0	0	0	0	0	97								
2	0	1	0	0	0	0	0	0	34	0	1	0	0	0	0	0	0	66	0	1	0	0	0	0	0	0	98								
3	1	1	0	0	0	0	0	0	35	1	1	0	0	0	0	0	0	67	1	1	0	0	0	0	0	0	99								
4	0	0	1	0	0	0	0	0	36	0	0	1	0	0	0	0	0	68	0	0	1	0	0	0	0	0	100								
5	1	0	0	1	0	0	0	0	37	1	0	0	1	0	0	0	0	69	1	0	0	1	0	0	0	0	101								
6	0	0	0	0	1	0	0	0	38	0	0	0	0	1	0	0	0	70	0	0	0	0	1	0	0	0	102								
7	1	0	0	0	0	1	0	0	39	1	0	0	0	0	1	0	0	71	1	0	0	0	0	1	0	0	103								
8	0	0	0	0	0	0	1	0	40	0	0	0	0	0	0	1	0	72	0	0	0	0	0	0	1	0	104								
9	1	0	0	0	0	0	0	1	41	1	0	0	0	0	0	0	1	73	1	0	0	0	0	0	0	0	105								
10	0	1	0	0	0	0	0	0	42	0	1	0	0	0	0	0	1	74	0	1	0	0	0	0	0	0	106								
11	1	1	0	0	0	0	0	0	43	1	1	0	0	0	0	0	1	75	1	1	0	0	0	0	0	0	107								
12	0	0	1	0	0	0	0	0	44	0	0	1	0	0	0	0	1	76	0	0	1	0	0	0	0	0	108								
13	1	0	0	1	0	0	0	0	45	1	0	0	1	0	0	0	1	77	1	0	0	1	0	0	0	0	109								
14	0	0	0	0	1	0	0	0	46	0	0	0	0	1	0	0	1	78	0	0	0	0	1	0	0	0	110								
15	1	0	0	0	0	1	0	0	47	1	0	0	0	0	1	0	1	79	1	0	0	0	0	1	0	0	111								
16	0	0	0	0	0	0	1	0	48	0	0	0	0	0	0	1	1	80	0	0	0	0	0	0	1	0	112								
17	1	0	0	0	0	0	0	1	49	1	0	0	0	0	0	0	1	81	1	0	0	0	0	0	0	0	113								
18	0	1	0	0	0	0	0	0	50	0	1	0	0	0	0	0	1	82	0	1	0	0	0	0	0	0	114								
19	1	1	0	0	0	0	0	0	51	1	1	0	0	0	0	0	1	83	1	1	0	0	0	0	0	0	115								
20	0	0	1	0	0	0	0	0	52	0	0	1	0	0	0	0	1	84	0	0	1	0	0	0	0	0	116								
21	1	0	0	1	0	0	0	0	53	1	0	0	1	0	0	0	1	85	1	0	0	1	0	0	0	0	117								
22	0	0	0	1	0	0	0	0	54	0	0	0	1	0	0	0	1	86	0	0	0	1	0	0	0	0	118								
23	1	0	0	0	1	0	0	0	55	1	0	0	0	1	0	0	1	87	1	0	0	0	1	0	0	0	119								
24	0	0	0	0	0	1	0	0	56	0	0	0	0	0	1	0	1	88	0	0	0	0	0	1	0	0	120								
25	1	0	0	0	0	0	1	0	57	1	0	0	0	0	0	1	1	89	1	0	0	0	0	0	0	0	121								
26	0	1	0	0	0	0	0	1	58	0	1	0	0	0	0	1	1	90	0	1	0	0	0	0	0	0	122								
27	1	1	0	0	0	0	0	1	59	1	1	0	0	0	0	1	1	91	1	1	0	0	0	0	0	0	123								
28	0	0	1	0	0	0	0	1	60	0	0	1	0	0	0	1	1	92	0	0	1	0	0	0	0	0	124								
29	1	0	0	1	0	0	0	1	61	1	0	0	1	0	0	1	1	93	1	0	0	1	0	0	0	0	125								
30	0	0	0	1	0	0	0	1	62	0	0	0	1	0	0	1	1	94	0	0	0	1	0	0	0	0	126								
31	1	0	0	0	1	0	0	1	63	1	0	0	0	1	0	1	1	95	1	0	0	0	1	0	0	0	127								

Figure 5-8 SD SLC Device Addressing Using DIP Switches

Section 6

Programming Overview

This section of the manual is intended to give you an overview of the programming process. Please read this section of the manual carefully, especially if you are programming the control panel for the first time.

The JumpStart AutoProgramming feature automates many programming tasks and selects default options for the system. You should run JumpStart at least once when you are installing the system. See Section 6.2 for details. After you run JumpStart, you may need to do some additional programming depending on your installation. Section 7 of this manual covers manual programmable options in detail.

Programming the panel can be thought of as a three part process. You must program:

- System options. These are options that affect general operation of the panel (see Section 7.6 for details).
- Options for input points and zones. These are primarily options that control the detection behavior of devices (see Section 7.5 for details).
- Options for output points and groups. This includes selecting characteristics for output groups and mapping output circuits to output groups (see Section 7.4 for details).

6.1 Security and Data Protection

Communication Security - Level 1

Stored Data Security - Level 0

Physical Security - Level 1

Access Control Security - Level 1

6.2 JumpStart Autoprogramming

The JumpStart AutoProgramming feature allows for faster system setup. When you run JumpStart (immediately after addressing SLC devices), the system scans devices on all SLC loops and determines device type (for example, ionization smoke detector or heat sensor) and selects some system options based on the device type. JumpStart AutoProgramming saves the installer from having to program options for each device. Depending on the application, the installer may need to make some changes after JumpStart AutoProgramming completes.

See Section 6.2.3 for complete details about running JumpStart AutoProgramming.

IMPORTANT

JumpStart is intended to be run one time only, immediately after SLC devices have been addressed and connected. JumpStart will reset all manually programmed options to default settings. Do not run JumpStart after you have configured the system.

6.2.1 Input Points

JumpStart will determine the number and type of input points (detectors or contact monitor modules) on each SLC loop. JumpStart assigns the correct detector type (heat, ionization or photoelectric), so the installer does not need to edit the device type for detectors. Any contact monitor modules on the system will be assigned type “Manual Pull.” The installer will need to manually change the switch type if manual pull is not correct.

JumpStart creates one zone (Zone 1) and assigns all input points to Zone 1. Zone 1 is mapped to Output Group 1. If the system has an EVS-50W, EVS-INT50W, EVS-100W or EVS-125W Amplifier, then Output Group 2 will also be created and all input points will be mapped to both Group 1 and Group 2. After JumpStart completes, you can re-map to configure a multiple zone/output group system (see Section 7.3.1.3). For a general explanation of mapping see Section 6.3.

6.2.2 Output Points

The 5820XL JumpStart creates three output groups. The 5820XL-EVS with amplifiers will create four output groups. The output circuits are assigned as follows:

Circuits 1-6:

Configured as Notification and assigned to Group 1. JumpStart automatically programs Zone 1 to activate Group 1 using constant on output when an alarm condition occurs.

Circuit 7 (Relay 1):

Assigned to Group 249. JumpStart automatically programs Zone 1 to activate Group 249 using constant on output when a supervisory condition occurs.

Circuit 8 (Relay 2):

Assigned to Group 250. JumpStart automatically programs Zone 1 to activate Group 250 using constant on output when an alarm occurs.

Amplifier Circuits:

Assigned to Group 2. JumpStart automatically programs Zone 1 to activate Group 2.

Addressable output points (Relay modules, NAC Modules, Sounder Bases, Relay Bases):

All addressable relay devices will be configured as “Output Pt” (general purpose output point) and assigned to Group 1.

Note: Relay output is constant even if the zone activating the relay is programmed with an output pattern.

6.2.3 Running JumpStart AutoProgramming



Run JumpStart immediately after you have addressed and connected all input devices (detectors, pull stations, and etc.) and output devices (notification appliances, relays, etc.).

Note: If you need to install a few devices after you have run JumpStart, you can install them manually. Follow instructions in Section 7 for configuration.

To run JumpStart, follow these steps:

1. Select 7 for Program Menu. Enter the Access Code
2. Select 6 for JumpStart AutoProgramming.
3. The message “WARNING WILL DELETE all system options” displays on the LCD. Select Yes to continue. A series of messages displays for the next several seconds. JumpStart scans the SLC loops for devices. This can take several minutes, depending on the number of devices attached.
4. When the message, “SLC FAMILY” message appears, select SK or SD; depending on the type of SLC devices the panel is using, and press ENTER to accept.
5. When the message “Configuring System Done” displays, press any key to continue.

6. Select one of the following options from the menu that displays.

1 - Review System	Press 1 if you need to review the JumpStart configuration.
2 - Repeat JumpStart	Press 2 if you need to rerun JumpStart for any reason.
3 - Accept Configuration	<ol style="list-style-type: none"> 1. If you are ready to make the JumpStart configuration permanent, select 3. 2. The system will ask you if the installation contains duct detectors. If there are none, select 2 for No and skip to Step 8. If the system contains duct detectors, select 1 for Yes and continue with Step 3. 3. From the list that displays, select the SLC that contains the duct detectors. 4. The first photoelectric or ionization detector on the system will display. Select 1 for DUCT and 2 for NonDUCT. 5. Press  to select the next detector. Select 1 for DUCT and 2 for NonDUCT. Continue until all duct detectors have been selected. (Note: You can move backwards through the list with ). 6. When you reach the last detector on this device, press the left arrow. 7. The system will ask you if there are more duct detectors in the system. If there are, select 1 for Yes and repeat from Step 3. If there are no more duct detectors, select 2 for No and continue with Step 8. 8. The system will restart in 10 seconds. You can press 1 to restart immediately. 9. After the system resets, it will use the new JumpStart configuration.
4 - Enter Programming	If you want to go directly to Program Mode to configure any devices, press 4. The Programming Menu appears and you can begin programming.

6.3 Mapping Overview

This section of the manual is an overview of mapping. Details about how to select mapping options appear in the appropriate subsections in Section 7.

Mapping is an important concept with the control panel. In general terms, mapping is assigning or linking events to outputs that should activate when events occur. You do this by assigning input points to input zones, output points to output groups and then linking or mapping zones and output groups.

Figure 6-1 is a brief overview of the concept of mapping. The next several pages of the manual show these subjects in detail.

In its simplest application, mapping is determining which outputs are activated by which inputs.

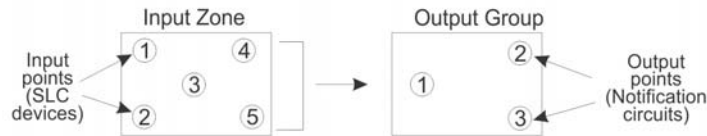

Because the Control Panel programming is so flexible, there are a number of uses for mapping, as shown in the diagram below.

Input zones are mapped by event type to output groups. Cadence patterns are assigned as part of the mapping information. Up to 8 groups/patterns can be selected for each event.

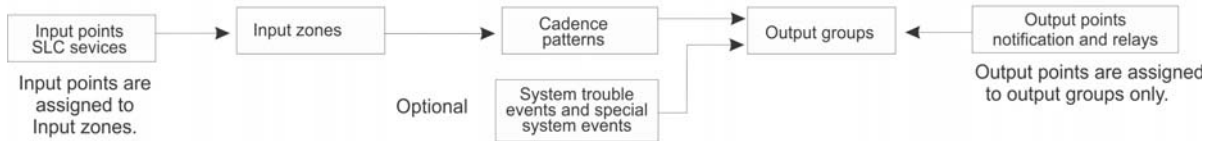

Figure 6-1 Mapping Overview

6.3.1 Input Point Mapping

Input points are assigned to input zones, as the example in Figure 6-2 shows. Any input point can be assigned to any input zone. (Input points can be assigned to one zone only. An input point can be designated as “Unused,” which means it has not been assigned to a zone).

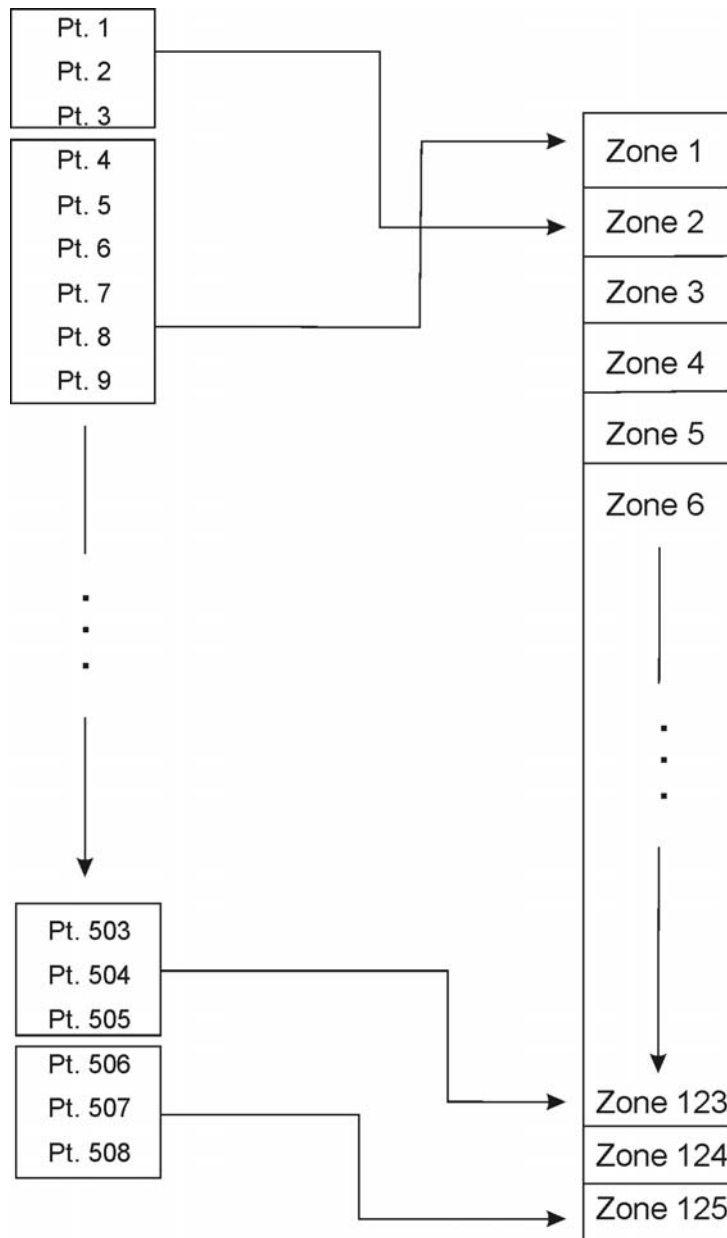

Figure 6-2 Input Point Assignment Example

6.3.2 Output Circuit Mapping

Figure 6-3 is a simple example showing how to assign notification and relay output circuits to groups. For an example of a simple floor above/floor below application, see Figure 6-5.

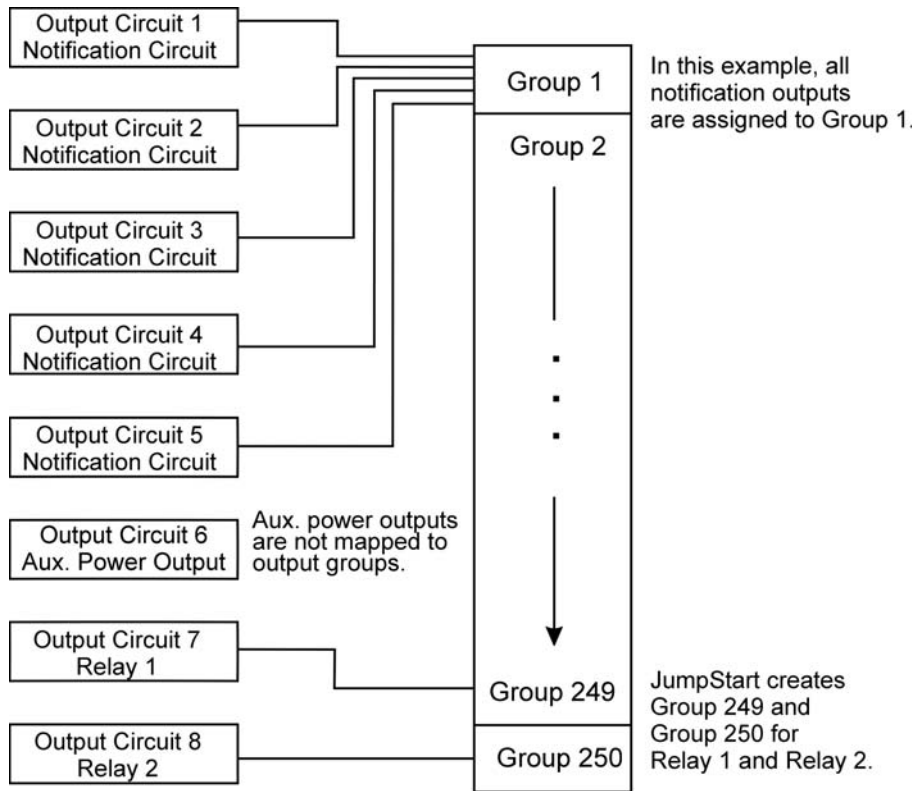

Figure 6-3 Example of Assigning Output Circuits to Groups

6.3.3 Zone Event Mapping

There are 11 types of events that can occur in zones (see below). For each event type, you can activate up to 8 output groups and patterns. If it is necessary to map to more than 8 output groups, an output group template may be used (see Section 7.4.5 for information on output group templates). Event types are:

- Manual Pull Alarm
- Water Flow Alarm
- Detector Alarm (heat or smoke detectors)
- Aux 1 and Aux 2 Alarm (user-specified alarm types)
- Pre-alarm
- Supervisory
- Status Points
- Trouble
- CO Alarm
- CO Supervisory

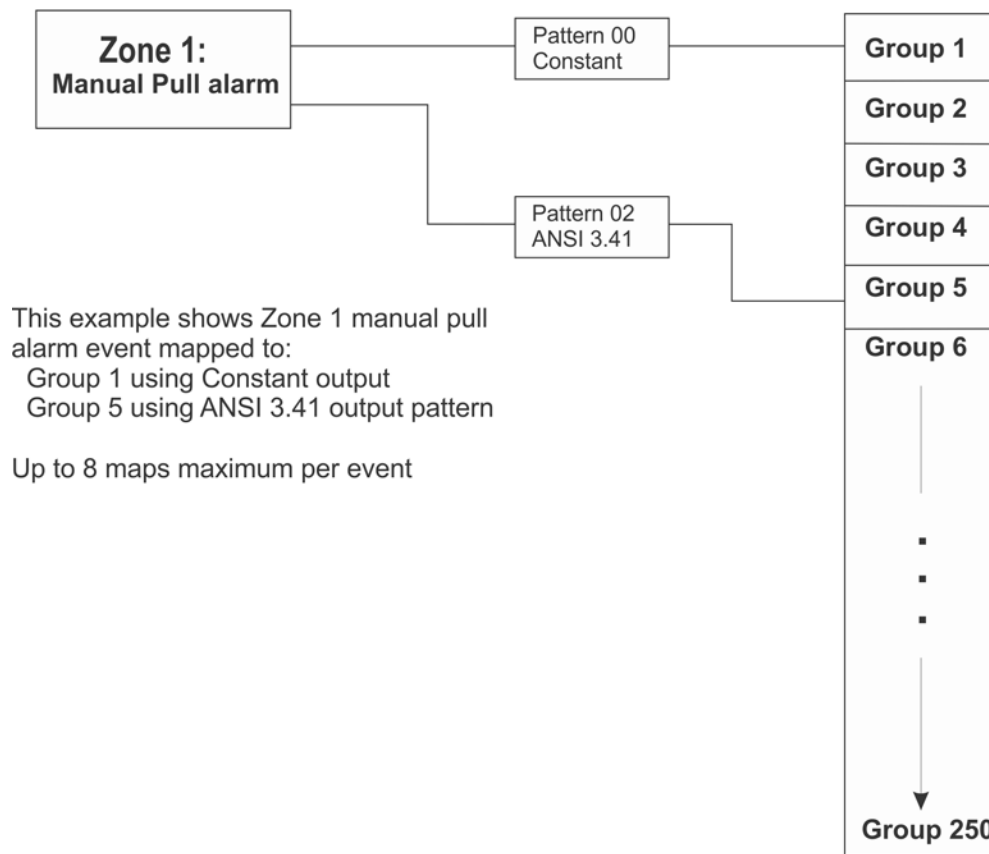

Figure 6-4 Example of Zone Events Mapped to Output Groups and Patterns

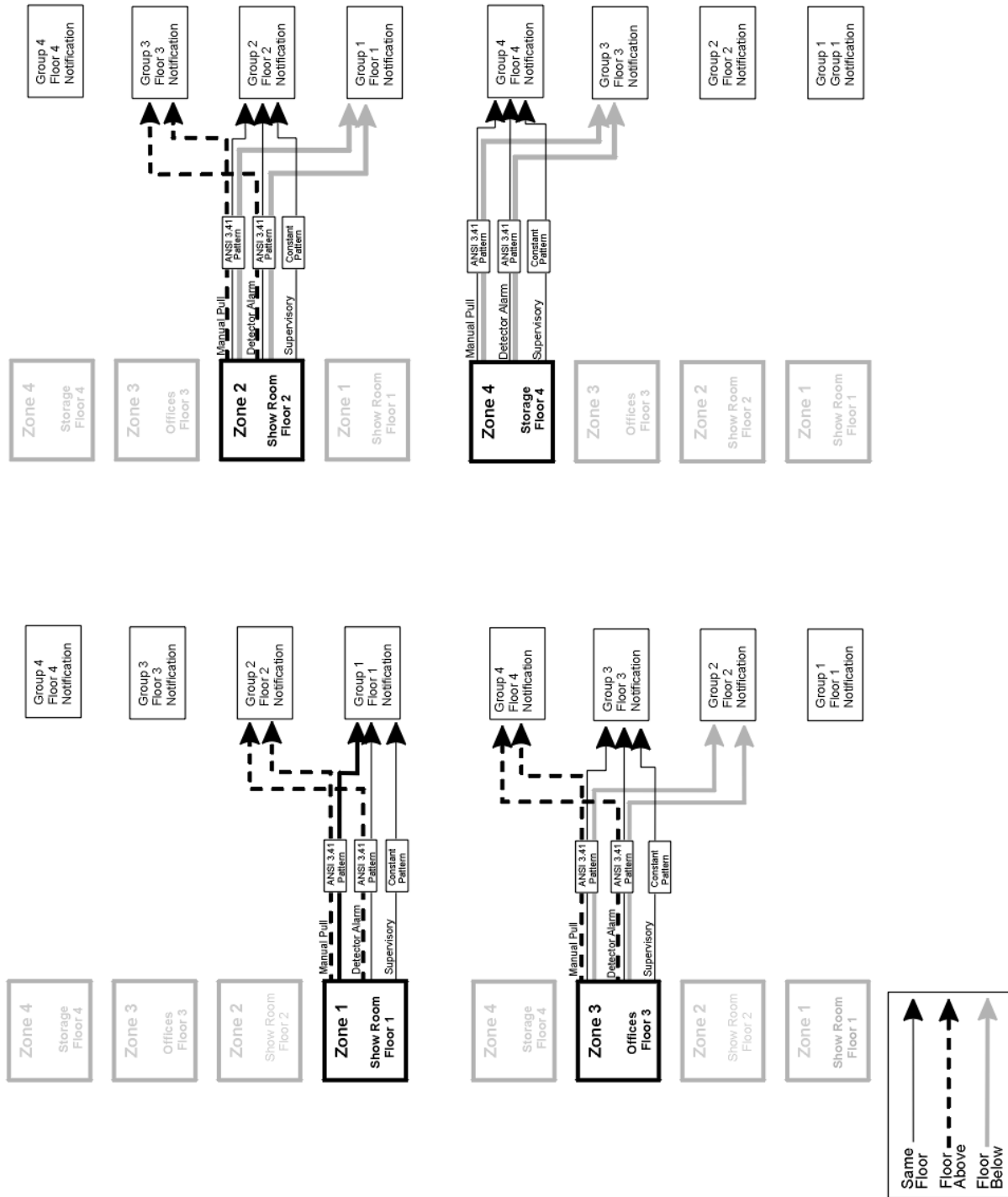

Figure 6-5 Example of Zone Events Mapped to Output Groups and Patterns

6.3.4 Mapping LED Points

Figure 6-6 is a simple example showing how LED points are mapped to zones and output groups. Typically you would create two output groups for each zone, one for alarms and one for troubles. (LED points are available when Models 5865-3/4 and/or 5880 are used with the system.)

Mapping LEDs to Zones and Output Groups

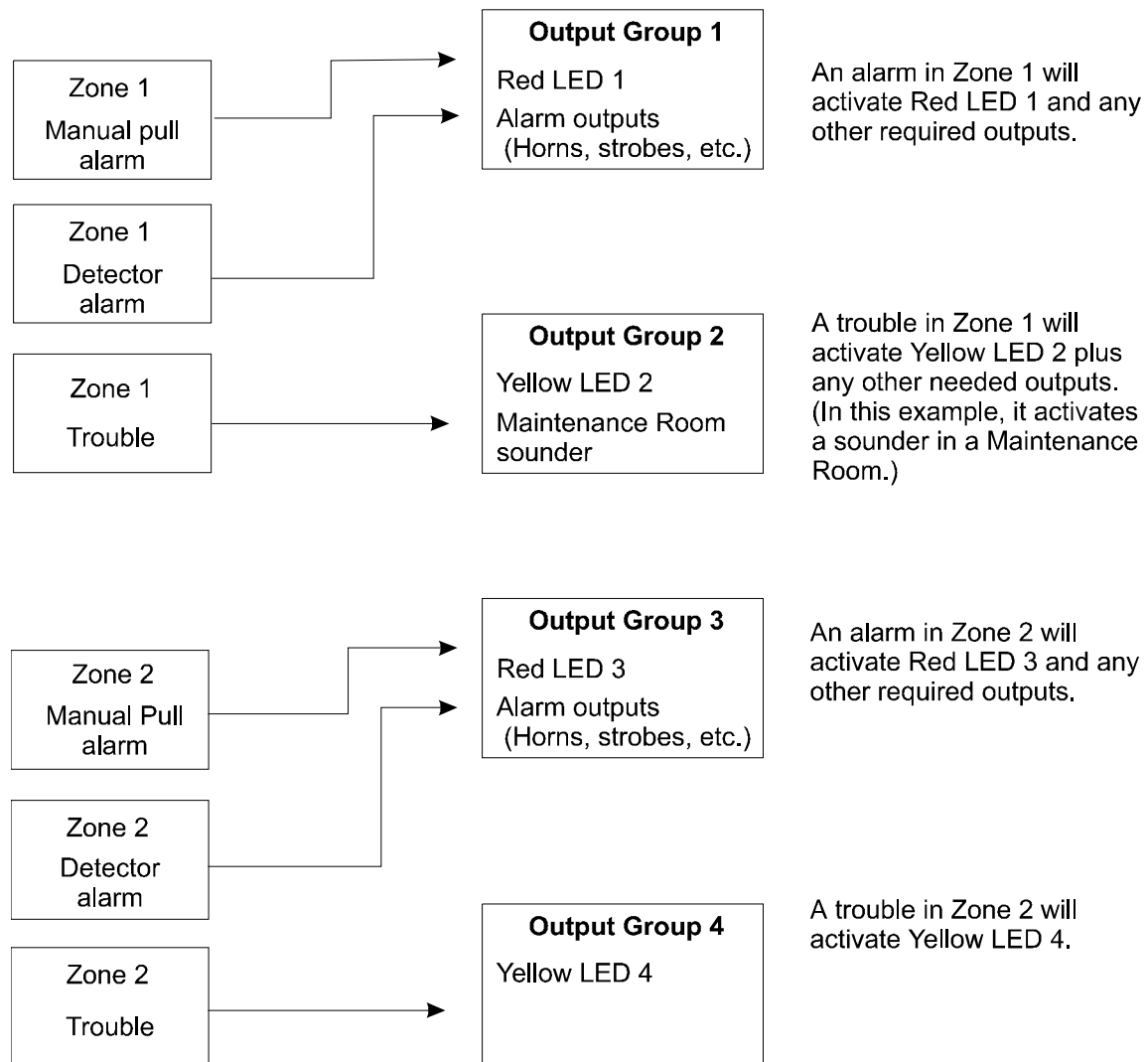

Figure 6-6 Example of LED Points Mapped to Output Groups
(Applies to Models 5865-3/4 and 5880)

6.4 Programming Using the 5660 Silent Knight Software Suite

You can use the 5660 Silent Knight Software Suite (SKSS) to program the control panel onsite or remotely. SKSS is an optional software package that lets you easily program the control panel using a Windows-based computer and a modem*. When using SKSS, you can set up the programming options for the panel, save the options in a file, then download the file to the panel. You connect to the control panel directly using the control

panel's onboard USB or serial port or remotely using a modem. If you need to connect to an older control panel that does not have a USB port, and your laptop does not have a serial port, use a USB to serial converter. SKSS is available for download online. See the SKSS manual (PN 151240) for more information.

*Modems not sold by Silent Knight. See Table 1-2 for a list of modems that have been tested for compatibility with the control panel and SKSS.

6.5 Programming Using an Annunciator

You can program the control panel from a system annunciator, using either the control panel's on-board annunciator or a Remote Annunciator.

The following subsections describe programming basics, including a description of editing keys available for programming and how to move through programming menus. Section 7 contains specific information about individual programming options.

6.5.1 Entering / Exiting the Program Menu

To enter Program Mode:

1. Enter the Installer Code (factory programmed default code is 5820).
2. The display prompts you to press the the right arrow or ENTER key to bring up the Installer Main Menu. (See Figure 6-7).

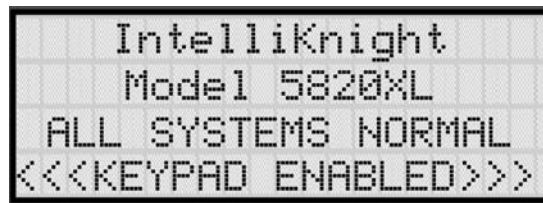

Figure 6-7 Keypad Enabled Screen

3. Then press 7. The menu option displays. See Section 7 for detailed menu information and Section 6.6 for a quick reference listing all programmable options and JumpStart defaults.

To exit Program Mode:

When you have completed working with the menus, press left arrow several times until you are exited from programming mode. Two prompts will display. The first prompt is to make sure you intended to leave the Program Menu (select Yes or No as appropriate). The second prompt is for accepting all changes. If you select No, any changes you have made since you entered the Program Menu will have no effect.

6.5.1.1 Moving through the Menu

Figure 6-8 shows how to move through Program Menu screens, using the System Options screen as an example.

First line of display identifies the menu.

The option available for editing displays next to equal sign (=).

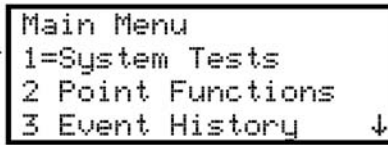

Arrows on LCD indicate that there are more options available by pressing key.



Selects the current option.

From the menu item displayed above, (1=System Test) press the down arrow to move through the options. When the equal sign reaches the last item displayed on the screen, the screen will scroll down. Likewise, when the equal sign reaches the first item on the screen, the screen will scroll up.

Figure 6-8 Moving through Program Menu

6.5.1.2 Selecting Options and Entering Data

There are several ways to make programming selections using the control panel depending on which screen you are currently viewing. The chart below is a generic explanation.

To	Press
Enter the number	The corresponding number on the annunciator.
Enter numeric data	The appropriate number on the annunciator.
Enter text (alphanumeric data)	Enter each character individually by using the or arrow keys until the one you wish to select displays. Then press the right arrow to select the character.
Select from a scrolling list	The or arrow keys to move through the list of available options. When the option you want to select is displayed, press ENTER.

6.5.1.3 Editing Keys

The keys shown in Figure 6-9 are available for use when you are in the program menu.

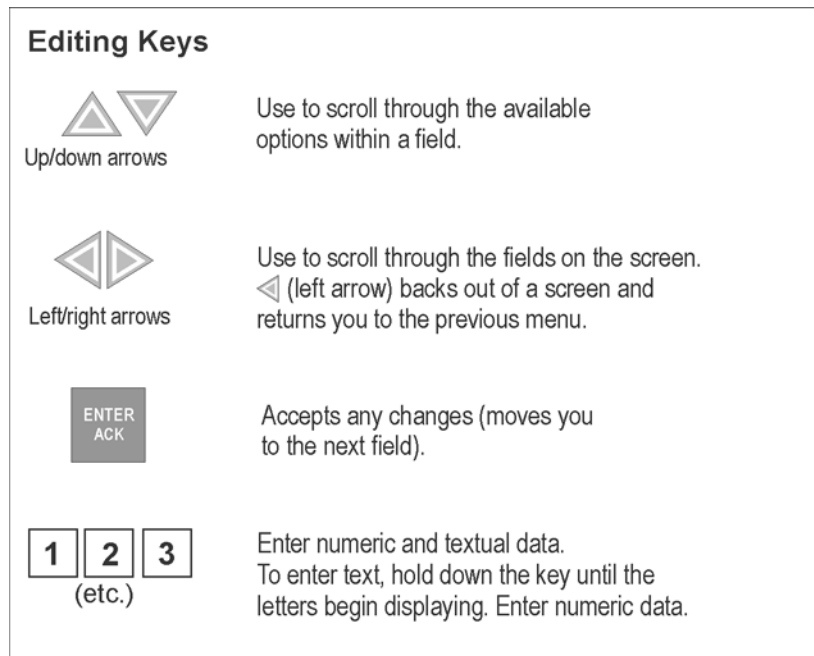

Figure 6-9 Editing Keys available from Program Menu

6.6 Programming Menu Quick Reference

This section of the manual lists all Program Menu options in the order they appear on the sub-menus. Default settings are indicated in text or marked with an asterisk (*). The comments column provide quick information and a reference to a section (if applicable) which has more detailed information.

Table 6-1: Programming Quick Reference Table

Menu	Options/Defaults(*)					Comments
Module	Edit Module	Select Module	Enter Module ID	Enter Module Name	Edit Module Settings (if applicable)	Section 7.2.1
	Add Module	5815XL-SLC				
		5860 Keystat.				
		5824-Ser/Par/IO				
		5895XL Pwr Sup				
		5496 NAC Expand				
		5880-LED/IO Dev				
		5865-LED Annun.				
		EVS-50W				
		EVS-125W				
EVS-INT50W						
EVS-100W						
EVS-VCM						
EVS-RVM						
Delete Module	List of Module				Section 7.2.3	
View Module List	List of Module				Section 7.2.4	
Zone	Edit Zone	Select Zone to Edit	Edit Zone Name		Section 7.3.1.1	
			Zone Properties	Verification Type	*1 Count	Section 7.3.1.2
					2 Count	
					Alarm Ver.	
					PAS	
					SNGL ILOCK	
					DBL ILOCK	
			Heat Temp Set	135° to *150°F	SD devices Section 7.3.1.2	
				135° to 190°F, *150°F	SK devices Section 7.3.1.2	
			Zone Outputs	Manual Pull (MP)	*Groups 01 & 250, (and 02 if voice); Pattern 00	Section 7.3.1.3 Section 7.3.1.4
				Water Flow (WF)		
				Detector Alarm (DE)		
				Aux 1 (A1)	*No Group	
Aux 2 (A2)						
Pre-alarm (PR)	*Group 249, Pattern 00					
Fire Supervisory (SU)						
Trouble (TR)	*No Groups					
Status Point (SP)						

Table 6-1: Programming Quick Reference Table

Menu	Options/Defaults(*)				Comments	
Zone	Edit Zone	Select Zone to Edit	Zone Outputs	CO Alarm (CO)	*Groups 01, 250; Pattern 00	
				CO Supervisory (Sco)	*Group 249; Pattern 00	
			Zone Accessory Opt	Cadence	00-16, 23; *02	SD Devices. Section 7.3.1.4, Section 7.3.1.5
				Fire Cadence	00, 01, *02, 23	SK Devices. Section 7.3.1.4, Section 7.3.1.5
				CO Cadence	00, 01, 02, *23	Section 7.3.1.5
	Local Zone	Y or *N				
	Add Zone				Section 7.3.2	
	Delete Zone	Select Zone to be Deleted			Section 7.3.3	
	View Zone Points	Select Zone to View			Section 7.3.4	
	Group ¹	Edit Group	Select Group	Group Name		Section 7.4.1.1
Latching Options				*Non-Latching (NL)	Section 7.4.1.2	
				Latching (LA)		
Silencing Options				*Silenceable	Silenceable Section 7.4.1.2	
				Non-Silenceable (NON-SIL)	Non-Silenceable Section 7.4.1.2	
				Auto Unsilence (AUT UNSIL)	Auto Un-silenced Section 7.4.1.2	
				Silence After Inhibit Delay (SIL-INHIB)	Silence after inhib delay. Section 7.4.1.2	
				Auto Shutdown (SHUT-DOWN)	Automatic Shutdown Section 7.4.1.2	
Polarity				*NO RP	Section 7.4.1.2	
				RP-TRB		
				RP-NTR		
Group Activates for all Man. Pull				Y or *N	Section 7.4.1.2	
Group Activates for Fire Drill				*Y or N	Section 7.4.1.2	
Group Activates for Aux 1				Y or *N	Section 7.4.1.2	
Group Activates for Aux 2	Y or *N	Section 7.4.1.2				
Ignore Global Cadence	Y or *N	Section 7.4.1.2				

Table 6-1: Programming Quick Reference Table

Menu	Options/Defaults(*)				Comments		
Group ¹	Edit Group	Select Group	Group Properties	Voice EVAC Only	Y or *N (Default Voice Group 2: *Y)	Section 7.4.1.2	
				Allow Override ECS Only	*Y or N		
				Voice Switch #	*00 - 40 (Voice Group: *01)		
				Override Cadence Pattern	*00-21, 23		
				Delay	05-60 minutes (*15)		
	Add Group					Section 7.4.2	
	Delete Group	Select Group to Delete				Section 7.4.3	
	View Group Points	Select Group				Section 7.4.4	
	Edit OPG Template	Select Template Number	Select Group			Section 7.4.5	
			Include in template	Y or *N		Section 7.4.5	
Select Pattern			0-21, 23			Section 7.3.1.4, Section 7.4.5	
Point	Internal and External 5815XL, SK Devices	Sensor Point #	DETECTOR	UNUSED		Section 7.5.1	
				PHOTO, ION, HEAT, ACCLIMATE, HEAT HT, PHOT-HEAT, BEAM	*Latching (LA) or Non-Latching (NL)		
				PHOTO, ION, HEAT, ACCLIMATE, HEAT HT, PHOT-HEAT, BEAM	*Silenceable (SI) or Non-Silenceable (NS)		
				PHOTO, ION, HEAT, ACCLIMATE, HEAT HT, PHOT-HEAT, BEAM	Zone # (*001)		
				PHOTO, ION, HEAT, ACCLIMATE, HEAT HT, PHOT-HEAT, BEAM	*NO ACCESSORY SDR BAS, RLY BAS		
				PHOTO, ION, HEAT, ACCLIMATE, HEAT HT, PHOT-HEAT, BEAM	Single/Multi Station: *NST, SST, MST		
				PHOTO, ION, HEAT, ACCLIMATE, HEAT HT, PHOT-HEAT, BEAM	Station Silenceable: *SIL, NSL		
				PHOTO, ION, HEAT, ACCLIMATE, HEAT HT, PHOT-HEAT, BEAM	Accessory Group # (*001)		
				PHOTO, ION, HEAT, ACCLIMATE, HEAT HT, PHOT-HEAT, BEAM	Point Name		

Table 6-1: Programming Quick Reference Table

Menu	Options/Defaults(*)				Comments	
Point (cont.)	Internal and External 5815XL, SK Devices	Sensor Point #	DETECTOR	PHOT DUCT	*Latching (LA) or Non- Latching (NL)	Section 7.5.1
					*Silenceable (SI) or Non- Silenceable (NS)	
					Zone # (*001)	
					*NO ACCESSORY, DCT RLY	
					Single/Multi Station: *NST, SST, MST	
					Station Silenceable: *SIL, NSL	
					Accessory Group # (*001)	
					Point Name	
			SUP DET	PHOTO, ION, HEAT, ACCLIMATE, HEAT HT, PHOT-HEAT, BEAM	*Latching (LA) or Non- Latching (NL)	
					*Silenceable (SI) or Non- Silenceable (NS)	
					Zone # (*001)	
					*NO ACCESSORY, SDR BAS, RLY BAS, I-SdrBa,	
					Single/Multi Station: *NST, SST, MST	
					Station Silenceable: *SIL, NSL	
					Accessory Group # (*001)	
Point Name						
	PHOT DUCT	*Latching (LA) or Non- Latching (NL)				
		*Silenceable (SI) or Non- Silenceable (NS)				
		Zone # (*001)				
		*NO ACCESSORY, DCT RLY				

Table 6-1: Programming Quick Reference Table

Menu	Options/Defaults(*)			Comments		
Point (cont.)	Internal and External 5815XL, SK Devices	Sensor Point #	SUP DET	PHOT DUCT	Single/Multi Station: *NST, SST, MST	Section 7.5.1
			Station Silenceable: *SIL, NSL			
			Accessory Group # (*001)			
			Point Name			
			CO FIRE	ALRM Fire/ALRM CO, ALRM Fire/SUPR CO, SUPR Fire/ALRM CO, SUPR Fire/SUPR CO	*Latching (LA) or Non-Latching (NL)	
					*Silenceable (SI) or Non-Silenceable (NS)	
					Zone # (*001)	
					*NO ACCESSORY, SDR BAS, RLY BAS, I-SdrBa	
		Single/Multi Station: *NST, SST, MST				
		Station Silenceable: *SIL, NSL				
		Accessory Group # (*001)				
		Point Name				
		Module Point #	UNUSED			
				MAN_PULL, PAS_ACK, DET SW, MAN REL, ILOCK, CO DET SW	*Silenceable (SI) or Non-Silenceable (NS)	
Zone # (*001)						
Point Name						
SWITCH	WATERFLOW, SUPERVSY, ZN_AUX1, ZN_AUX2, TAMPER		*Latching (LA) or Non-Latching (NL)			
			*Silenceable (SI) or Non-Silenceable (NS)			
			Zone # (*001)			
			Point Name			
	FIREDRILL, SILENCE, RESET		*Silenceable (SI) or Non-Silenceable (NS)			
			Point Name			

Table 6-1: Programming Quick Reference Table

Menu	Options/Defaults(*)				Comments		
Point (cont.)	Internal and External 5815XL, SK Device	Module Point #	SWITCH	SYS_AUX1, SYS_AUX2	*Latching (LA) or Non- Latching (NL) *Silenceable (SI) or Non- Silenceable (NS) Point Name	Section 7.5.1	
				STATUS PT	Zone # (*001)		Used to activate an ancillary output group that does not activate alarm, sound PZT, display status, or report events. Reset has no effect on this point. Section 7.5.1
					Point Name		
			NOTIF	OUTPUT PT	Group # (*001)	Section 7.5.1	
	AUX CONST, AUX RESET, AUX DOOR	Point Name					
	Internal and External 5815XL, SK Devices	Module Point #	RELAY	OUTPUT PT	Group # (*001)		
				AUX RESET, AUX DOOR	Point Name		
			DETECTOR	2WIRE SMK	*Silenceable (SI) or Non- Silenceable (NS)		
					Zone # (*001)		
	Point Name						

Table 6-1: Programming Quick Reference Table

Menu	Options/Defaults(*)			Comments			
Point (cont.)	Internal and External 5815XL, SD Devices	Point #	UNUSED		Section 7.5.1		
			DETECTOR	PHOTO, ION, HEAT		*Latching (LA) or Non-Latching (NL)	
						*Silenceable (SI) or Non-Silenceable (NS)	
						Zone # (*001)	
						*NO ACCESSORY, SDR BAS, RLY BAS	
						Single/Multi Station: *NST, SST, MST	
						Station Silenceable: *SIL, NSL	
						Accessory Group # (*001)	
						Point Name	
			DETECTOR	PHOT DUCT, ION DUCT		*Latching (LA) or Non-Latching (NL)	
						*Silenceable (SI) or Non-Silenceable (NS)	
						Zone # (*001)	
						*NO ACCESSORY, DCT RLY	
						Single/Multi Station: *NST, SST, MST	
						Station Silenceable: *SIL, NSL	
Accessory Group # (*001)							
Point Name							
DETECTOR	2 WIRE SMK	*Silenceable (SI) or Non-Silenceable (NS)					
		Zone # (*001)					
		Point Name					

Table 6-1: Programming Quick Reference Table

Menu	Options/Defaults(*)				Comments	
Point (cont.)	Internal and External 5815XL, SD Devices	Point #	SUP DET	PHOTO, ION, HEAT	*Latching (LA) or Non- Latching (NL)	Section 7.5.1
				*Silenceable (SI) or Non- Silenceable (NS)		
				Zone # (*001)		
				*NO ACCESSORY, SDR BAS, RLY BAS		
				Single/Multi Station: *NST, SST, MST		
				Station Silenceable: *SIL, NSL		
				Accessory Group # (*001)		
				Point Name		
				PHOT DUCT, ION DUCT	*Latching (LA) or Non- Latching (NL)	
				*Silenceable (SI) or Non- Silenceable (NS)		
				Zone # (*001)		
				*NO ACCESSORY, DCT RLY		
				Single/Multi Station: *NST, SST, MST		
				Station Silenceable: *SIL, NSL		
Accessory Group # (*001)						
Point Name						

Table 6-1: Programming Quick Reference Table

Menu	Options/Defaults(*)			Comments				
Point (cont.)	Internal and External 5815XL, SD Devices	Point #	SWITCH	MAN_PULL, PAS_ACK, DET SW, MAN REL, ILOCK, CO DET SW	*Silenceable (SI) or Non- Silenceable (NS) Zone # (*001) Point Name	Section 7.5.1		
				WATERFLOW, SUPERVSY, ZN_AUX1, ZN_AUX2, TAMPER	*Latching (LA) or Non- Latching (NL) *Silenceable (SI) or Non- Silenceable (NS) Zone # (*001) Point Name			
				FIREDRILL, SILENCE, RESET	*Silenceable (SI) or Non- Silenceable (NS) Point Name			
				SYS_AUX1, SYS_AUX2	*Latching (LA) or Non- Latching (NL) *Silenceable (SI) or Non- Silenceable (NS) Point Name			
				STATUS PT	Zone # (*001) Point Name		Used to activate an ancillary output group that does not activate alarm, sound PZT, display status, or report events. Reset has no effect on this point. Section 7.5.1	
				NOTIF	OUTPUT PT		Group # (*001) Point Name	Section 7.5.1
					AUX CONST, AUX RESET, AUX DOOR		Point Name	
				RELAY	OUTPUT PT		Group # (*001) Point Name	
					AUX RESET, AUX DOOR		Point Name	
				SLC LED	LED # (01-80)		UNUSED, NOTIF	
			Group # (*001)					
			Point Name					

Table 6-1: Programming Quick Reference Table

Menu	Options/Defaults(*)			Comments			
Point (cont.)	Internal Pwr and External Power	Point #	UNUSED		Section 7.5.2		
			B NOTIF	NOTIF OUT, CTRL CKT		Group # (*001) Point Name	
			A NOTIF	NOTIF OUT, CTRL CKT		Group # (*001) Point Name	
			AUX PWR	CONSTANT, AUX RESET, AUX DOOR, AUX SYNC		Point Name	
			B SWITCH	MAN_PULL, PAS_ACK, MAN REL, ILOCK		*Silenceable (SI) or Non- Silenceable (NS) Zone # (*001) Point Name	
						*Latching (LA) or Non- Latching (NL)	
						*Silenceable (SI) or Non- Silenceable (NS) Zone # (*001) Point Name	
			B SWITCH	FIREDRILL, SILENCE, RESET		*Silenceable (SI) or Non- Silenceable (NS) Point Name	
						*Latching (LA) or Non- Latching (NL) *Silenceable (SI) or Non- Silenceable (NS) Point Name	
			SYS_AUX1, SUS_AUX2			Point Name	
			STATUS PT			Zone # (*001)	Used to activate an ancillary output group that does not activate alarm, sound PZT, display status, or report events. Reset has no effect on this point. Section 7.5.2
						Point Name	

Table 6-1: Programming Quick Reference Table

Menu	Options/Defaults(*)			Comments			
Point (cont.)	Internal Pwr and External Power	Point #	A SWITCH	Same as B SWITCH	Section 7.5.2		
			B DETECTOR	2WIRE SMK, 4WIRE SMK, CO 4WIRE		*Silenceable (SI) or Non- Silenceable (NS)	
						Zone # (*001)	
						Point Name	
			A DETECTOR	2WIRE SMK, 4WIRE SMK, CO 4WIRE		*Silenceable (SI) or Non- Silenceable (NS)	
						Zone # (*001)	
	Point Name						
	EVS-VCM AND EVS-RVM	POINT #	UNUSED		Section 7.5.4		
			SWITCH	MAN_PULL, PAS_ACK, MAN REL, ILOCK		*Silenceable (SI) or Non- Silenceable (NS)	
						Zone # (*001)	
						Point Name	
			SWITCH	WATERFLOW, SUPERVSY, ZN_AUX1, ZN_AUX2, TAMPER		*Latching (LA) or Non- Latching (NL)	
*Silenceable (SI) or Non- Silenceable (NS)							
Zone #(*001)							
SWITCH			FIREDRILL, SILENCE, RESET	*Silenceable (SI) or Non- Silenceable (NS)			
				Point Name			
				SWITCH		SYS_AUX1, SUS_AUX2	*Latching (LA) or Non- Latching (NL)
*Silenceable (SI) or Non- Silenceable (NS)							
Point Name							
SWITCH			STATUS PT	Zone # (*001)			
				Point Name			
SWITCH			V_AuxStat	Point Name			
				SWITCH		V_Aux EVS	*Latching (LA) or Non- Latching (NL)
Point Name							

Table 6-1: Programming Quick Reference Table

Menu	Options/Defaults(*)			Comments		
Point (cont.)	5880	Point #	UNUSED			
			NOTIF	NOTIF OUT, CTRL CKT	Group # (*001) Point Name	
			SWITCH	MAN_PULL, PAS_ACK, MAN REL, ILOCK	*Silenceable (SI) or Non- Silenceable (NS) Zone # (*001) Point Name	
				WATERFLOW, SUPERVSY, ZN_AUX1, ZN_AUX2, TAMPER	*Latching (LA) or Non- Latching (NL) *Silenceable (SI) or Non- Silenceable (NS) Zone # (*001) Point Name	
				FIREDRILL, SILENCE, RESET	*Silenceable (SI) or Non- Silenceable (NS) Point Name	
				SYS_AUX1, SUS_AUX2	*Latching (LA) or Non- Latching (NL) *Silenceable (SI) or Non- Silenceable (NS) Point Name	
			STATUS PT		Zone # (*001) Point Name	
			5865	Point #	UNUSED	
					NOTIF	NOTIF OUT, CTRL CKT
			EVS-50W	Point #	UNUSED	
					NOTIF	Group # (*002) Point Name
			EVS-125W	Point #	UNUSED	
					NOTIF	Group # (*002) Point Name
			EVS-INT50W	Point #	UNUSED	
NOTIF	Group # (*002) Point Name					
EVS-100W	Point #	UNUSED				
		NOTIF	Group # (*002) Point Name			

Section 7.5.3

Table 6-1: Programming Quick Reference Table

Menu	Options/Defaults(*)				Comments	
System Options	Reporting Accounts	Edit Acct.	Choose Account (1-4)	Edit Account #	*123456	Account # (6-digit number, identifies account to central station) Section 7.6.1.1
				Edit Format	*CID, S20, SIA	Reporting Format (SIA, S20, Contact ID) Section 7.6.1.1
				Report Alarms	Yes (Y), *No (N), or Must (M)	Section 7.6.1.1
				Rep. Alarm Restore	Yes (Y), *No (N), or Must (M)	
				Report Troubles, Disables, Supervisories and their Restores	Yes (Y), *No (N), or Must (M)	
				Report Test	Yes (Y), *No (N), or Must (M)	
				Report Resets	Yes (Y), *No (N), or Must (M)	
				Switch attempts (1-5)	*3	
				Edit Phone #		
	Auto Test Time	Set the Hour		Section 7.6.1.2		
		Set the Minutes				
		Select AM/PM				
		Report Every	04, 06, 12, *24 hours			
	Phone Lines	Select Phone Line	Phone Line Disable	Y or *N	Section 7.6.2	
			Dial Tone Detection Disable	Y or *N	Section 7.6.2	
			Dialing Prefix	*none	Up to 9 digits	Section 7.6.2.1
			# of Answer Rings	Range: 00-15	*6	Section 7.6.2.2
			Select Dialing Option	*TT, TT/PL, PULSE		Section 7.6.2.3
			Rotary Pulse Format	U = 60/40 E = 66/34	*U	Section 7.6.2.4
			Line Monitor	*Y or N		Section 7.6.2.5
			Answering Machine Bypass	Yes = Enabled No = Disabled	*Y	Section 7.6.2.6

Table 6-1: Programming Quick Reference Table

Menu	Options/Defaults(*)				Comments	
System Options	System Event Outputs	System Trouble	Select Group (*None)		Section 7.6.3.1	
			Select Cadence (*None)			
		Alarm Silence	Select Group (*None)			
			Select Cadence (*None)			
		Trbl Silence	Select Group (*None)			
			Select Cadence (*None)			
		Trouble Events	User Selected	Group Tr		Select Group (*None) and Cadence (*None)
				SBUS Com		
				SBUS Pwr		
				SLC Loop		
				AC Loss		
				Battery		
				Gnd Flt		
				Phone Ln		
				Account		
				Printer		
	Sys Alarm Cadence	Fire Drill Cadence	00-21, 23	*00 (Constant)	Section 7.6.3.2	
		System Aux1 Cadence	00-21, 23	*00 (Constant)		
		System Aux2 Cadence	00-21, 23	*00 (Constant)		
	Time Options	Water Flow Delay	0 - 90 Seconds	*01	Water Flow delay is the number of sec. before water flow alarm is generated.	Section 7.6.4.1
		Alarm Verification time	1 to 250 seconds	*60		Section 7.6.4.2
		Low AC Delay	0 - 30 hours	*3	Low AC Report Delay	Section 7.6.4.3
		Clock	AM/PM	*AM/PM	System Clock Format (AM/PM or military)	System Clock Format (AM/PM or military). Section 7.6.4.4
Military						
AC Freq:		50 Hz			Section 7.6.4.5	
		60 Hz				
		Neither				

Table 6-1: Programming Quick Reference Table

Menu	Options/Defaults(*)				Comments
System Options (cont.)	Misc. Options	SYNC Strbs w/ Sil	Y (Enabled)	*Disabled	Section 7.6.5.1
			N (Disabled)		
		Auto Display Oldest	Y (Enabled)	*Enabled	Section 7.6.5.2
			N (Disabled)		
		Report By	Zone	*Zone	Section 7.6.5.3
	Point				
	Plex Door	Y (Enabled)	*Disabled	Section 7.6.5.4	
		N (Disabled)			
	Single Key Ack	Y (Enabled)	*Disabled	Section 7.6.5.5	
		N (Disabled)			
	Daylight Savings	DST	Yes (Enabled) or *No (Disabled)	*Enabled	Automatic Daylight Saving Time enable or disable. Section 7.6.6.1
		DST Start	Select week: 1st, *2nd, 3rd, 4th or Last	Select Month (*Mar)	Section 7.6.6.2
		DST End	Select week: *1st, 2nd, 3rd, 4th or Last	Select Month (*Nov)	
Edit Banner	Internal Message				Section 7.6.7
	Custom Message	Edit Line 1			
		Edit Line 2			
SLC Family	SD				Section 7.6.8
	SK				
Jump Start AutoPrg	No				Section 7.7
	Yes				
Computer Account	Computer Account #	*5820			Section 7.8
	Computer Access Code	*0			
	Computer Phone #	Up to 40 digits			

Table 6-1: Programming Quick Reference Table

Menu	Options/Defaults(*)		Comments		
Access Codes	Select Profile (01-20)	Edit Name		<p>Profile 1 is the profile that dictates what functions the Firefighter Key has access to. Because this is the profile for a key the user name and the access code can not be edited for this profile.</p> <p>Profile 2 is the profile for the installer and is referred to as the "Installer Code". This profile's user name and panel functions can not be edited. Section 7.9</p>	
		Edit Access Code			
		Panel Functions	System Reset		
			System Silence		
			System ACK		
			System Test		
			Fire Drill Menu		
			Indicator Test		
			Walk Test no Report		
			Walk Test with Report		
			Dialer Test		
			Clear History Buffer		
			Point Functions		
			Disable/Enable Point		
			Point Status		
			Set SLC Device Address		
			SLC Device Locator		
			SLC Multi-Device Locator		
			I/O Point Control		
			Event History		
			Set Time & Date		
			Printer Options		
			Event Logging		
			Print Event History		
			Print Detector Status		
			Print System Configuration		
			Reset Dialer		
			Program Menu		
System Information					
Upload/Download					
EVS Control Request					
EVS Super User					

Table 6-1: Programming Quick Reference Table

Menu	Options/Defaults(*)				Comments	
Voice Options	VCM Maintenance	PC Connection			Section 7.10.1.1	
		Local Recording	Select Module	Select Circuit	Section 7.10.1.2	
	Edit Voice Commands	Select Command	Message/Tone Only			Section 7.10.2
			Message Select	1-15		
			Tone Select			
			Repeats	1-14		
				Continuous		
				None		
			Initial Delay	0		
				3		
	4-28 (4 sec. increments)					
	Inter Message Delay	4-32 (4 sec. increments)				
	Allow Message Restart with new group activation	Yes (Y) or *No (N)				
	EVS System Options	Enable EVS System	Yes (Y) or No (N)			Section 7.10.3.1
		Edit Cmd Priority				Section 7.10.3.2
Edit Cmd Mapping					Section 7.10.3.3	
Edit Timers		Control Lockout				Section 7.10.3.4
		Auto Reset EC 0-8				
Edit Event Names				Section 7.10.3.5		
1. Use of multiple notification groups may not synchronize with each other.						

Section 7

Programming

This section of the manual describes how to manually program the control panel from the built-in annunciator. Each subsection discusses these menu options in detail. All options described in this section can be performed using 5660 Silent Knight Software Suite (SKSS).

Before any customized programming is done, JumpStart should be run first. After JumpStart is run, thoroughly test the system. The reason the system should be tested after JumpStart is because JumpStart automatically programs the system, searching for and configuring all SLC and SBUS devices it finds. JumpStart allows you to confirm the integrity of the installation prior to performing any custom programming. After determining that the hardware is properly installed, custom programming can be performed. Refer to Section 6.

7.1 UL 864 / UL 2572 Programming Requirements

NOTICE TO USERS, INSTALLERS, AUTHORITIES HAVING JURISDICTION, AND OTHER INVOLVED PARTIES: This product incorporates field programmable software. In order for the product to comply with the requirements in the Standard for Control Units and Accessories for Fire Alarm Systems, UL 864 and UL 2572, certain programming features or options must be limited to specific values or not used at all as indicated below.

Programming Option	Menu Item	Permitted in UL 864 (Y/N)	Permitted in UL 2572 (Y/N)	Possible Settings	Settings Permitted in UL 864	Settings Permitted in UL 2572
Time Options	Low AC Report Delay	Yes	Yes	0-30 hours	1-3	1-3
Display Oldest Event	Y (Enabled)	Yes	Yes	Yes & No	Yes	Yes
	N (Disabled)	No	No	Yes & No	No	No
Initial Delay	0-28	Yes	Yes	0-28	3-10	4-28
Inter Message Delay	4-32	No	No	4-32	4-32	4-28
Alarm Verification	Alarm Verification	Yes	Yes	1-250	1-60	1-60
Auto Reset EVS Custom Event	Auto Reset EVS Custom Event	Yes	Yes	Never Timer Event Disabled	Never Timer Event Disabled	Never Timer Event Disabled
EVS Input	EVS Input	Yes	Yes	Latching Non-Latching	Latching	Latching

7.2 Modules

This section lists the options available under the module option in the program menu. The following modules are available for the control panel: 5815XL SLC expander, 5860 remote fire alarm annunciator, 5824 serial/parallel printer interface module, 5496 intelligent power module, 5895XL intelligent power module, 5880 LED I/O module, and 5865 LED annunciator, EVS-50W, EVS-INT50W, EVS-100W or EVS-125W audio/voice amplifiers, EVS-VCN voice control module, and EVS-RVM remote voice module.

7.2.1 Edit Modules

The features that can be edited when this option is selected are module ID, module name, class of wiring (Class A or Class B), or features that are specific to the module to be edited.

To edit an existing module:

1. Enter the installer code. The panel will automatically go the main menu.
2. Select 7 for Program Menu.
3. Press 1 to enter module menu.
4. Press 1 to edit a module.
5. Use the Up or Down arrow to select the module you wish to edit, then press ENTER.

7.2.1.1 Naming Modules

You can assign an English name to a system hardware module to make it easier to recognize on a display.

6. If you wish to edit the module's name, press the ENTER on the modules name. Then press the number keys corresponding to the character to select each character for the module's name (or press the right arrow to bypass editing the name).

Press the the right arrow to move to the next character.

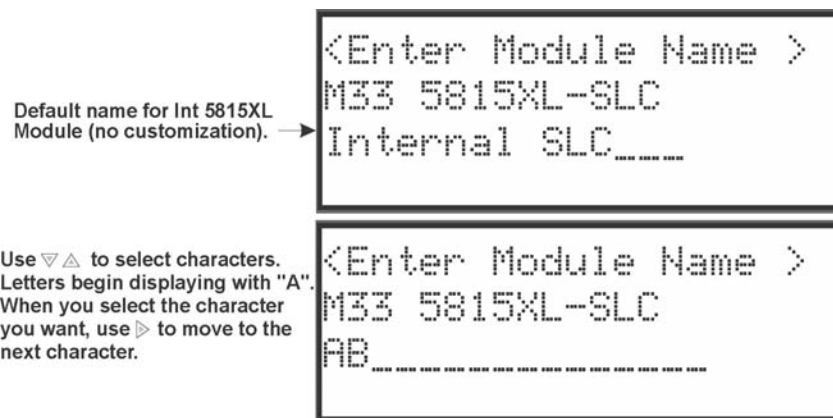

Figure 7-1 Edit module Name Programming Screen Example

7.2.1.2 Editing Module Features

Each module has a unique set of options that specifically applies to the functionality of the module being edited.

7. Use the left and right arrow keys to move between available options.
8. Option settings are edited by pressing the up or down arrow.

7.2.2 Adding a Module

To add a new hardware module to the system, follow these steps:

You must be in the Main Menu to perform this task. If necessary, enter the Installer Code.

1. Enter the installer code. The panel will automatically go the main menu.
2. Select 7 for Program Menu.
3. Press 1 to enter module menu.
4. Press 2 to add a module.

5. From the next screen, use the Up or Down arrow to choose a module type to add from the <New Module Type> screen.

The screen will display “Adding module [#]...” for a few moments. You will be returned to the <New Module Type> screen where you can add additional modules if desired.

You must save changes when you exit the Program Menu or the new module will not be added.

Note: If you Add a Module that has not been physically connected, the panel will go into trouble after it reinitializes (when you exit the Program Menu). When the new module is attached, the trouble will correct itself automatically the next time you power up the system.

7.2.3 Deleting a Module

To delete a module, follow these steps:

You must be in the Main Menu to perform this task. If necessary, enter the Installer Code.

1. Enter the installer code. The panel will automatically go the main menu.
2. Select 7 for Program Menu.
3. Press 1 to enter module menu.
4. Select module to be deleted.
5. Press 3 to delete a module.
6. A warning screen will display. If you want to proceed with deleting the module, select Yes. To cancel, select No.

7.2.4 View Module List

To view a list of all modules, follow these steps:

1. Enter the installer code. The panel will automatically go the main menu.
2. Select 7 for Program Menu.
3. Press 1 to enter module menu.
4. Press 4 to view module list.

7.3 Zone

Through the zone option in the program menu you can edit, add, delete, and view zone points. Selections made here affect all detectors and switches in the zone. Up to 125 zones can be used in the system.

7.3.1 Edit Zone

Features that can be edited through the edit zone option are zone name, zone properties (which includes zone type and detector sensitivity), zone output mapping, and zone accessory options.

To edit a zone, follow these steps:

1. Enter the installer code. The panel will automatically go the main menu.
2. Select 7 for Program Menu.
3. Press 2 to enter zone menu.
4. Press 1 to edit a zone.
5. Enter the zone number, then press ENTER.

7.3.1.1 Edit Zone Name

6. Press 1 to edit the selected zone's name.

A screen similar to the one shown in Figure 7-2 displays.

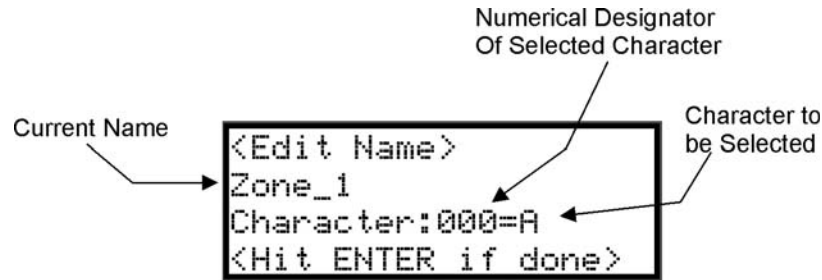

Figure 7-2 Selecting Character for Zone Name

7. Select the characters for the zone name by pressing the Up or Down arrow until the desired character is shown then press the right arrow or see Appendix B of this manual for a list of available characters and their numeric designators.
8. Repeat step 8 until the name is complete.
9. Press ENTER when the name is complete.

7.3.1.2 Edit Zone Properties

Zone properties consist of alarm delay characteristics, heat detector sensitivity.

1. Do steps 1 through 5 of Section 7.3.1.
2. Press 2 to edit the properties of the selected zone.

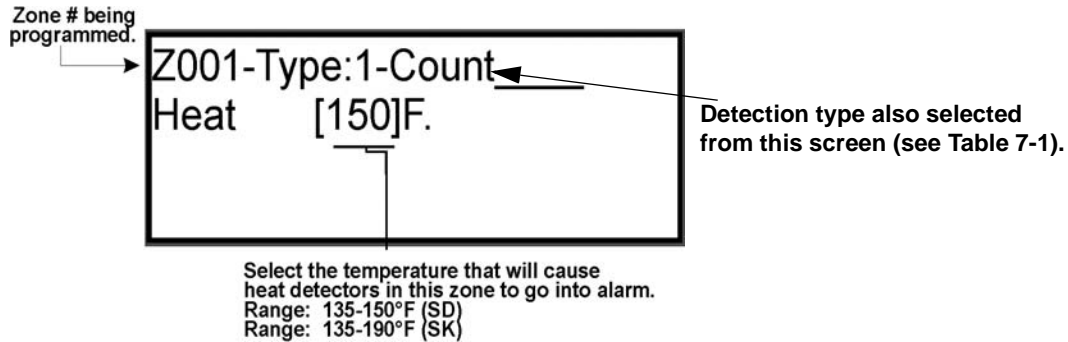

Figure 7-3 Editing Zone Properties

Alarm Delay Characteristics

3. Select the alarm delay characteristics (see Table 7-1) by pressing the Up or Down arrow.

Table 7-1: Alarm Delay Characteristics

Type of Delay	Description
1-Count	One Count (No Delay). When this option is enabled, an alarm occurs immediately when a single device of any of the following types goes into alarm: detector, manual pull, water flow, Zone AUX1 or Zone AUX2. This is considered the most typical operation and is the default for all zones.
2-Count	When this type of alarm delay is used, two or more detectors within the zone must go into alarm in order for the zone to report an alarm. Switches of type manual pull, water flow, Zone AUX1 and Zone AUX2 are an exception; they will cause an alarm when only one switch is in alarm. When a single detector is in alarm in a 2-Count zone, the system enters a prealarm condition. In a prealarm condition, the touchpad PZT beeps and the annunciator display indicates that a prealarm has occurred. If the zone has been mapped to an output group for the prealarm event, the output group will activate. The prealarm will not be reported to the central station.
Alarm Ver.	Alarm verification is an optional false alarm prevention feature that verifies an alarm condition by resetting the smoke detector. If the alarm condition still exists by the time the reset cycle has completed, the detector will go into alarm. If the detector is no longer in alarm, no report will go to the central station. The alarm verification sequence is ignored if the zone is already in alarm.
PAS	This option is intended to be used with an acknowledge switch. An alarm is delayed for 15 seconds, giving on-site personnel a chance to investigate the alarm. If the acknowledge switch is not activated within 15 seconds, an alarm occurs automatically. If this option is enabled for a zone, the zone will respond to an alarm condition as follows: <ul style="list-style-type: none"> The zone will not go into alarm for 15 seconds to allow an on-site operator to activate the acknowledge switch. If the operator does not press the acknowledge switch within 15 seconds, the zone will go into alarm. If the operator presses the acknowledge switch within 15 seconds, a 180-second time-frame will begin counting down. This time-frame allows the operator to investigate the cause of the alarm. If the operator performs a reset within 180 seconds, the alarm will not occur. If the operator does not perform a reset within 180 seconds, an alarm will occur automatically. <ul style="list-style-type: none"> The P.A.S. feature will be overridden if another alarm occurs.
SNGL ILOCK	See Section 8.7.1 for single interlock releasing operation.
DBL ILOCK	See Section 8.7.2 for double interlock releasing operation.
<i>Note: SK-FIRE-CO and other CO detectors can only be installed in a 1 count zone; they will operate as a 1-count point regardless of the programmed zone type (i.e. Alarm Verification, 2 count, etc.).</i>	

4. Press ENTER.

Heat Temperature Setting

Use this feature to set the temperature at which high temperature detectors will respond. All detectors in the zone will respond in the same way. The range for the SD505-HEAT heat detector is from 135°F to 150°F. The range for SK-Heat-HT heat detector is from 135°F to 190°F.

The SD505-HEAT and SK-Heat-HT heat detectors are absolute temperature devices. This means that they respond to an alarm immediately if the temperature in the zone goes above the programmed temperature.

5. Enter the temperature at which the heat detector will respond, or Use the Up or Down arrow to scroll through the range or enter directly from the number keys on the annunciator, then press ENTER.

7.3.1.3 Zone Outputs

Output groups and cadence patterns are mapped to events. They can be programmed to output when an event occurs in a zone. Some system trouble events can be mapped for the entire system. Section 6.3 of this manual contains a general explanation of mapping. The following sections explain how to select mapping options.

Note: Use of multiple notification groups may not synchronize with each other.

Mapping to Zone Events

Eleven types of events can occur in zones. For each event type, you can activate up to 8 output groups or output group templates, specifying a pattern for each. The following is a list of all event types:

Note: Abbreviations in the parentheses are the characters that are displayed in programming (see Figure 7-4).

- Manual Pull Alarm (MP)
- Water Flow Alarm (WF)
- Detector Alarm (DE). This applies to heat or smoke detectors.
- Aux 1 and Aux 2 Alarm (A1 or A2). User-specified alarm types.
- Pre-alarm (PR)
- Supervisory (SU)
- Trouble (TR)
- Status Point (SP)
- CO Alarm (CO)
- CO Supervisory (SCO)

To map zone events to outputs:

1. From the Installer Main Menu, select 7 for Program Menu.
2. From the Program Menu, select 2 for Zone.
3. From the next menu, select 1 for Edit Zone.
4. Enter the zone number you wish to edit.
5. From the next menu, select 3 for Zone Outputs.
6. A screen similar to the one shown in Figure 7-4 will display. Select the event type you want to program using the Up or Down arrow and press ENTER.
7. Press the Up or Down arrow to toggle the group letter to either G = Group or T = output group template depending on what you need for this zone. Press ENTER.
8. Select options for each event that could occur in this zone. Figure 7-4 is a complete example of how you might map a zone.

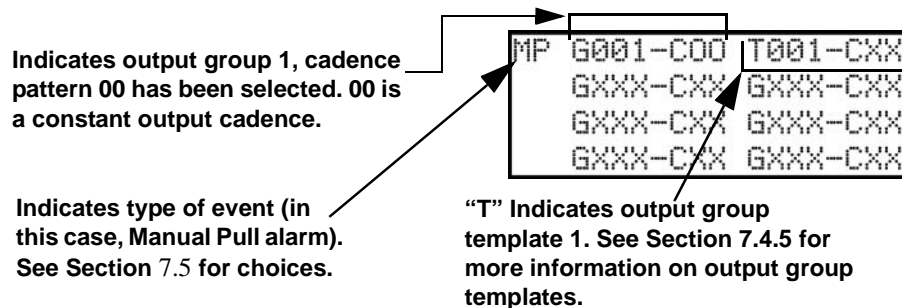

Figure 7-4 Selecting Output Groups/templates and Cadence Patterns for a Zone Event

Zone Mapping Example

Suppose you want to program Zone 1 so that:

- Any alarm (detector, CO, water flow or manual pull) would activate Output Group 1 using the ANSI cadence pattern.
- Manual pull alarm would activate Output Group 3 using constant output.
- Troubles would activate Output Group 2 using the zone-coded cadence pattern.

To accomplish this you need to access the screen for each event and then select your output groups. Figure 7-5 shows how you would program this application.

For this application:

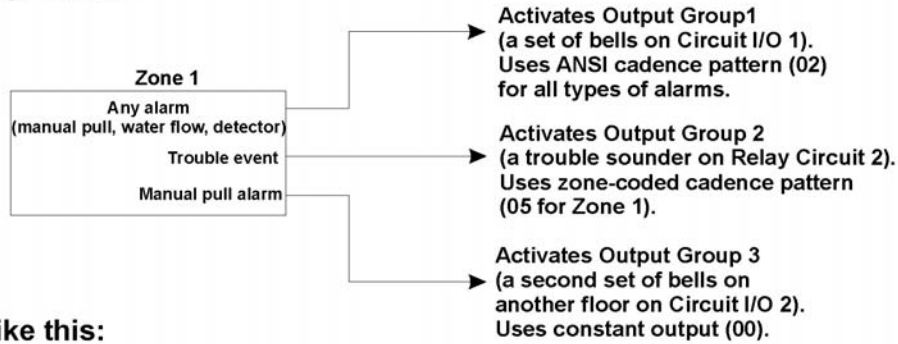

Program like this:

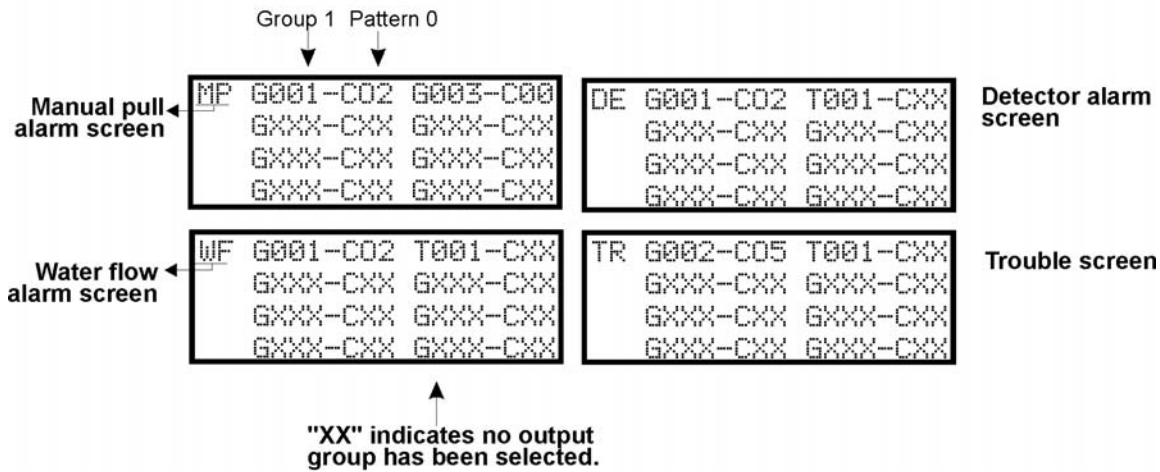

Figure 7-5 Zone Mapping Example

7.3.1.4 Cadence Patterns

The cadence patterns shown in Figure 7-6 are available for use with the control panel. Cadence patterns can be selected by event type for each zone or for the entire system. Special cadence patterns can be selected for fire

drills and any auxiliary system switches used with the system.





#	Name	Pattern Description																										
00	Constant	Continuous sound <small>Note: This is the only pattern that can be used for relay circuits. The system will override any other choice.</small>																										
01	March Code																											
02	ANSI 3.41																											
03	Single Stroke																											
04	California																											
05 ⋮ 16	Zone Coded	<table border="1" data-bbox="324 871 560 1186"> <thead> <tr> <th>Pattern#</th> <th>Zone</th> </tr> </thead> <tbody> <tr><td>5</td><td>Zone 1</td></tr> <tr><td>6</td><td>Zone 2</td></tr> <tr><td>7</td><td>Zone 3</td></tr> <tr><td>8</td><td>Zone 4</td></tr> <tr><td>9</td><td>Zone 5</td></tr> <tr><td>10</td><td>Zone 6</td></tr> <tr><td>11</td><td>Zone 7</td></tr> <tr><td>12</td><td>Zone 8</td></tr> <tr><td>13</td><td>Custom 1</td></tr> <tr><td>14</td><td>Custom 2</td></tr> <tr><td>15</td><td>Custom 3</td></tr> <tr><td>16</td><td>Custom 4</td></tr> </tbody> </table>  <p>This pattern multiplied by # of zone in alarm, followed by 3 seconds off.</p> <p>EXAMPLE: Pattern 06, Zone 2 coded</p> 	Pattern#	Zone	5	Zone 1	6	Zone 2	7	Zone 3	8	Zone 4	9	Zone 5	10	Zone 6	11	Zone 7	12	Zone 8	13	Custom 1	14	Custom 2	15	Custom 3	16	Custom 4
Pattern#	Zone																											
5	Zone 1																											
6	Zone 2																											
7	Zone 3																											
8	Zone 4																											
9	Zone 5																											
10	Zone 6																											
11	Zone 7																											
12	Zone 8																											
13	Custom 1																											
14	Custom 2																											
15	Custom 3																											
16	Custom 4																											
17 ⋮ 21	<table border="1" data-bbox="324 1207 609 1333"> <thead> <tr> <th>Pattern #</th> <th>Sync Type</th> </tr> </thead> <tbody> <tr><td>17</td><td>Faraday</td></tr> <tr><td>18</td><td>Gentex</td></tr> <tr><td>19</td><td>System Sensor</td></tr> <tr><td>20</td><td>Wheelock</td></tr> <tr><td>21</td><td>AMSECO</td></tr> </tbody> </table>	Pattern #	Sync Type	17	Faraday	18	Gentex	19	System Sensor	20	Wheelock	21	AMSECO	These outputs provide synchronization for AMSECO, Faraday, Gentex, System Sensor, or Wheelock synchronized appliances.														
Pattern #	Sync Type																											
17	Faraday																											
18	Gentex																											
19	System Sensor																											
20	Wheelock																											
21	AMSECO																											
22	Unused																											
23	Temporal 4																											

Figure 7-6 Cadence Patterns Available with the Control Panel

7.3.1.5 Zone Accessory Options

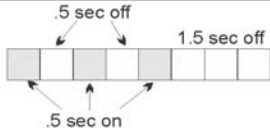
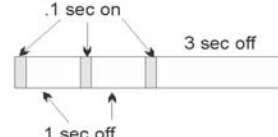
This option applies to detectors that are used with a Sounder base or Relay base.

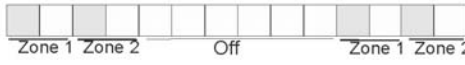
Fire Cadence: __ and CO Cadence: __ (choose from a subset of Cadence Patterns 00 to 23).

Note: The B200S Sounder base is intended to be used along with the CO Cadence setting.

Local Zone (choose Y or N, for Yes or No).

7.3.2 Add Zone

To add a zone, follow these steps:

1. Enter the installer code. The panel will automatically go the main menu.
2. Select 7 for Program Menu.
3. Press 2 to enter zone menu.
4. Press 2 to add a zone.

A zone of the next available zone number will be added. Options for this zone can now be programmed through the Zone Edit sub-menu. Up to 125 zones can be used.

7.3.3 Delete Zone

To delete a zone, follow these steps:

1. Enter the installer code. The panel will automatically go the main menu.
2. Select 7 for Program Menu.
3. Press 2 to enter zone menu.
4. Press 3 to delete a zone.
5. Choose Zone to be deleted.

A warning screen will display. If you want to proceed with deleting the zone, select Yes. To cancel, select No.

7.3.4 View Zone Points

To view the points in a zone, follow these steps:

1. Enter the installer code. The panel will automatically go the main menu.
2. Select 7 for Program Menu.
3. Press 2 to enter zone menu.
4. Press 4 to view zone points.
5. Enter the number of the zone you wish to view, then press ENTER.

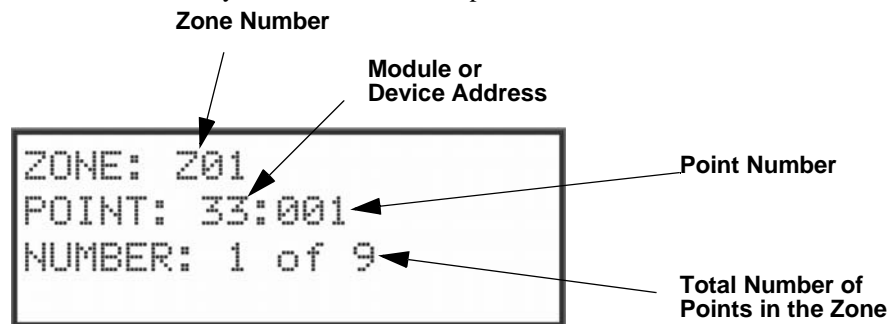

Figure 7-7 View Zone Points Screen

7.4 Group

An output group is made up of output points that have been programmed to respond in the same way. Output groups simplify programming because you only have to program the output characteristics that are common to all of the group points once, instead of programming each individual point. Once you have defined the characteristics of output groups, you can assign each point to the appropriate group. All valid output points are assigned to only one output group. Unused points are not assigned to any output group. Up to 250 output groups can be defined.

Each output group is defined as either a voice output group or a non-voice output group. Output points that are audio circuits (all circuits on the EVS-50W, EVS-INT50W, EVS-100W, EVS-125W and EVS-CE4) can only be assigned to voice output groups. Output points that are non-voice circuits (all other points and circuits that are on all modules except the EVS-50W, EVS-INT50W, EVS-100W, EVS-125W and EVS-CE4) are assigned to non-voice output groups.

7.4.1 Edit Group

In the edit group option you can program the name of an output group (Section 7.4.1.1) and change the properties (Section 7.4.1.2) of that group.

To edit a group, follow these steps:

1. Enter the installer code. The panel will automatically go to the main menu.
2. Select 7 for Program Menu.
3. Press 3 to enter group menu.
4. Press 1 to edit group.
5. Enter the number of the group you wish to edit, then press ENTER.

7.4.1.1 Edit Group Name

6. To edit the group name, press 1.

A screen similar to the one shown in Figure 7-8 displays.

7. Select the characters for the zone name by pressing the Up or Down arrow until the desired character is shown. Refer to Appendix B for a list of available characters.
8. Repeat step 8 until the name is complete.
9. Press ENTER when the name is complete.

You can use words or numbers to create a descriptive name or a group. Press the number (see Appendix B) until the character is shown. Arrow left or right for position, and press Enter to accept.

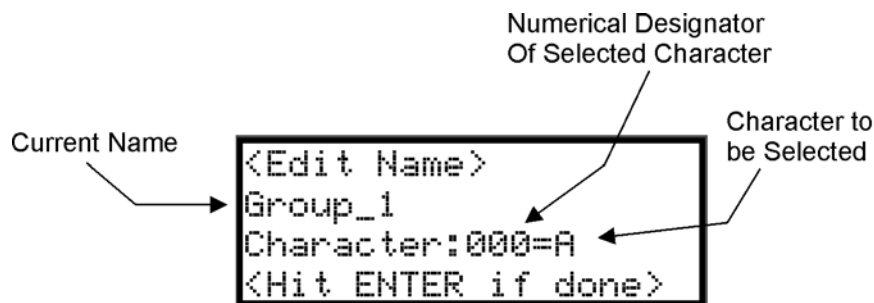

Figure 7-8 Selecting Character for Group Name

7.4.1.2 Edit Group Properties

1. Follow steps 1-5 of section 7.4.1
2. To edit the group properties, press 2.

The Edit Group Menu allows you to select options for each group for the following items:

- Latching or non-latching outputs.
- Silencing operation.
- Reverse Polarity options.
- Operation with system switches.
- Define output group type as voice or non-voice and Allow Override. These options are for EVS Only. See Figure 7-9.

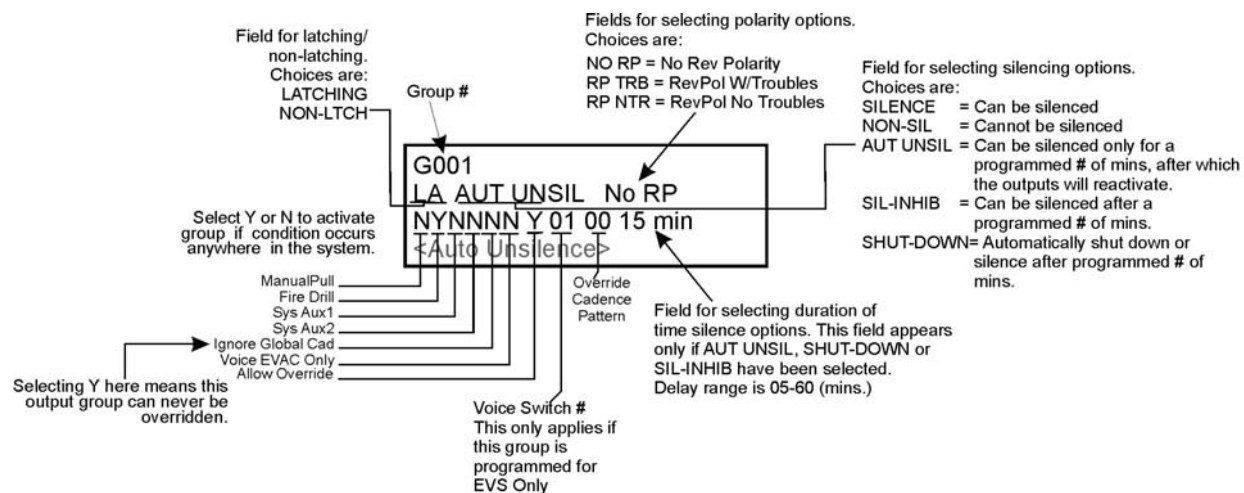

Figure 7-9 Group Properties Screen Programming Options

Latching / Non-latching Outputs

Outputs that are programmed as Latching remain active until the system has been manually reset. Non-latching outputs stop activating automatically when the condition clears.

Silencing Options

The following silencing options are available for each output group.

Table 7-2: Silencing Options

Option	Description
SILENCE	Silenceable. The output group can be silenced through the SILENCE key.
NON-SIL	Not silenceable. The output group cannot be silenced. Activation of the SILENCE key will be ignored for this output group.
AUT UNSIL	Auto Unsilenced. If this option is selected, the output group can be silenced for a programmed time-frame. If the condition that caused the output to activate has not cleared during the time-frame, the output reactivates. If you select this option, select the time-frame in the delay field. Range is 05-60 minutes. (See Figure 7-9 for location of field.)
SIL-INHIB	Timed Silence after Inhibit. If this option is selected, the output group must be audible for a programmed number of minutes before it can be silenced. If the condition that caused the output to activate has not cleared during the time-frame, the output can be silenced. If you select this option, select the timeframe in the delay field. Range is 05-60 minutes. (See Figure 7-9 for location of field.)
SHUT-DOWN	If this option is selected, the output group will automatically silence (shut down) after the programmed time period. If you select this option, select the timeframe in the DLY: field. Range is 01-60 minutes. (See Figure 7-9 for location of field.)

Response with System-Wide Conditions

You can select whether an output group will respond to various system-wide occurrences. (See Figure 7-9 for location of this field.)

Table 7-3: Output Group Response Choices

Option	Description
ManPull	Manual Pull Activation. Select Yes if you want this group to activate for all manual pull alarms that occur in the system. Note: Even though manual pull switches are assigned to zones, activation selected here for manual pull will override zone-programmed activation.
Fire Drill	Fire Drill Activation. Select Yes if you want this group to activate for fire drills.
Sys Aux1 and Sys Aux2	Select Yes if you want this output group to activate for system-wide Aux1 and Aux2 alarms. (Aux 1 and Aux 2 alarm types are for auxiliary alarm conditions. For example, you might want to use Aux 1 to provide a unique alarm type.)
Ignore Global Cad	Ignore Global Cadence. If you want to create an output group that can never be overridden, you can select Yes for this option. Selecting No means that system-wide events that have been assigned an output pattern could override the pattern for the output group. For example, suppose you had assigned a set of strobes to Output Group 3. You would never want these strobes to output in a pattern under any circumstances. To make sure this happens, select Yes for Ignore Global Cadence for Output Group 3.
Reverse Polarity	This option programs the output group for reverse polarity operation. Selecting Reverse Polarity–Troubles will cause the output group to be de-energized for any system trouble. Selecting Reverse Polarity–No Troubles will cause system troubles to be ignored. Activation is accomplished through standard mapping methods. Use with the 7644-L8 assembly to implement reverse polarity. See Section 4.14.3.2 for more information on the 7644-L8.
Voice EVAC Only	This option programs the output group to be a voice output group. A voice group can only be mapped to voice circuits. A non-voice group can only be mapped to non-voice circuits.
Allow Override	This option programs the output group to allow it to be overridden by a higher priority system (e.g. Emergency overriding Fire). Select No if you do not want the group to be overridden.
Voice Switch #	This option links the output group with a voice select switch on a VCM, RVM, or switch expander for dynamic activation. See Section 9.2.3.2 for more information.
Override Pattern #	This setting sets the cadence of the non-voice group mapped to voice select switch when activated using dynamic activation. See Section 9.2.3.2 for more information.

7.4.2 Add Group

To add a group:

1. Enter the installer code. The panel will automatically go to the main menu.
2. Select 7 for Program Menu.
3. Press 3 to enter group menu.
4. Press 2 to add a group.

The system will assign the next available group number. The group can now be edited if desired (see Section 7.4.1). A total of 250 output groups can be defined.

7.4.3 Delete Group

1. Enter the installer code. The panel will automatically go to the main menu.
2. Select 7 for Program Menu.
3. Press 3 to enter group menu.
4. Press 3 to delete a group.

5. Select group to be deleted. Press ENTER to delete.
 A warning screen will display. If you want to proceed with deleting the group, select Yes. To cancel, select No.

7.4.4 View Group Points

1. Enter the installer code. The panel will automatically go to the main menu.
2. Select 7 for Program Menu.
3. Press 3 to enter group menu.
4. Press 4 to view group points.
5. Enter the group number, then press ENTER.

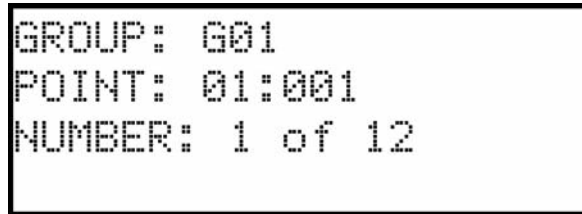

7.4.5 Edit Output Group Templates

Some installations may require that zones be mapped to more than 8 output groups. With output group templates you can combine one or all output groups into one template, which can be used when the same combination of outputs are used for several zones.

For example, lets say an installation has five zones (See Table 7-4). The check mark indicates what output groups are mapped to each zone. You will notice that every zone is mapped to outputs 1 and 2. As an alternative you can create a template that combines output group 1 and 2 as one choice.

Table 7-4: Zone Group Example

Zone	Group Number							
	1	2	3	4	5	6	7	8
1st Floor Smoke Detectors	x	x			x			
2nd Floor Smoke Detectors	x	x			x			
3rd Floor smoke Detectors	x	x			x			
Manual Fire Pull Stations	x	x					x	
Water Flow Switches	x	x						x

This can be done by creating a template which includes output groups 1 and 2. Then you can map all the zones to the template you created. This will free up output group assignments that are common to several zones. This is very useful when you need to map zones to more than eight output groups.

To create Output Group Templates:

1. From the Main Menu, select 7 for Program Menu.
2. From the Program Menu, select 3 for Group.
3. At the next screen, select 5 for Edit OPG Template.
4. Select the template number (01 - 08).

5. Select output group number. See Figure 7-10.

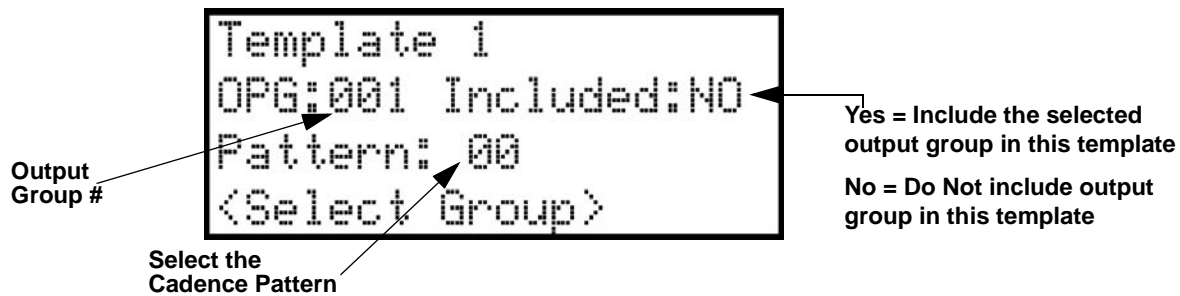

Figure 7-10 Output Group Template Programming Screen

7.5 Point

You may need to change characteristics of individual input points (detectors and switches) even after using JumpStart. This section explains how to change options for: type of point, latching/non-latching, silenceable/non-silenceable, zone assignment (input points), detector accessory base options, group assignment (output points), and point name.

7.5.1 Point Programming For 5815XL Module

To program points on 5815XL Module, follow these steps:

1. Enter the installer code. The panel will automatically go to the main menu.
2. Select 7 for Program Menu.
3. Press 4 to enter point menu.
4. Press the Up or Down arrows to select the desired module. Refer to Section 6.6 Quick Reference Table for available choices.
5. Press ENTER.
6. Enter the number of the point you wish to edit.
7. Press ENTER.
8. Select the type of device by pressing the Up or Down arrows. Refer to Table 7-5 under column heading "Type Selection" for a list of choices
9. Press ENTER.

10. Select the function of the device by pressing the Up or Down arrows. Refer to Table 7-6 under column heading "Function" for a list of choices.

Table 7-5: Point Programming Options for 5815XL Modules

Module Type	Type Selection	Function	Latching Option	Comments
SLC Loop	UNUSED			
	SD DETECTOR	PHOTO		
		ION		
		HEAT		
		PHOT DUCT		
		ION DUCT		
		2WIRE SMK		
	SD SUP DET	SUP PHOTO	Latching Non Latching	
		SUP ION		
		SUP PHOTO DUCT		
		SUP ION Duct		
		SUP HEAT		
	SK DETECTOR	PHOTO		
		ION		
		HEAT		
		PHOTO DUCT		
		2-WIRE SMKE		
		ACCLIMATE		
		HEAT HT		
		PHOTO HEAT		
		BEAM		
	SK SUP DETECTOR	SUP PHOTO DUCT	Latching Non latching	
		SUP SMOKE PHOTO		
		SUP SMOKE ION		
		SUP HEAT		
		SUP ACCLIMATE		
		SUP HEAT HT		
		SUP SMOKE PHOTO/HEAT		
SUP SMOKE BEAM				
CO Fire	ALRMCO ALRM FIRE			
	SUPR CO/SUPR FIRE	Latching Non Latching	Supervisory can be latching or non-latching	
	SUPR CO/ALRM FIRE			
	ALRM CO/SUPR FIRE			
SWITCH	MANUAL PULL		Use this switch type for manual pull stations. This input is always latched. The switch can clear only when an alarm is reset.	

Table 7-5: Point Programming Options for 5815XL Modules

Module Type	Type Selection	Function	Latching Option	Comments
SLC Loop	SWITCH (cont.)	WATERFLOW	Latching	Use this switch type for monitoring water flow in a sprinkler system. Switch closure will cause a sprinkler alarm. Water flow switches can be programmed as latching or non-latching. You can program a delay of up to 90 seconds to be used with a water flow switch. The delay allows for normal, brief changes in sprinkler system water pressure. The water flow alarm will not activate unless the switch is active for the programmed delay time. If a delay is used, the system begins counting down when the switch closes. If the switch opens (restores) before the timer expires, a water flow alarm is not generated. If the water flow switch remains closed after the timer expires, a water flow alarm will be generated.
			Non Latching	
		SUPERVISORY	Latching	Use this switch type for tamper monitoring of sprinklers and other fire protection devices. If a contact closes, a sprinkler supervisory event will be generated. Supervisory switches can be latching or non-latching.
			Non Latching	
		FIREDRILL		System-level, non latching switch. This switch is an alternative way of causing a fire drill. It has the same operation as the fire drill option available from the annunciator. When the switch is activated, a fire drill begins; when the switch is de-activated, the fire drill ends.
		SILENCE		This system-level switch is an alternative way to silence the fire and advisory systems. It has the same effect as pressing the SILENCE key.
		RESET		This system-level switch is an alternative way to reset the fire and advisory systems. It has the same effect as pressing the RESET key.
		P.A.S ACK		Positive acknowledge switch. This switch must be used in zones programmed as Positive Alarm Sequence (see Table 7-1). If an acknowledge switch closes when an alarm or trouble condition is not already in progress, a trouble will occur. You must use a UL listed normally open, momentary switch type. The switch must be rated at 5V, 100 mA (minimum) and be used with an EOL resistor for supervision.
		ZONE AUX1	Latching	Use these switch types if you want to monitor special zone-level conditions (such as operation of a fan or damper).
			Non Latching	
ZONE AUX2	Latching			
	Non Latching			

Table 7-5: Point Programming Options for 5815XL Modules

Module Type	Type Selection	Function	Latching Option	Comments
SLC Loop	SWITCH (cont.)	SYSTEM AUX1	Latching	Use these switch types if you want to monitor special system-wide conditions (such as operation of a fan or damper).
			Non Latching	
		SYSTEM AUX2	Latching	
			Non Latching	
		DETECTOR SW		Used to monitor conventional 4-wire detectors, a contact closure will generate a detector alarm event.
		TAMPER	Latching	Performs identically to a supervisory switch, but will be indicated as a tamper switch on the LCD annunciator.
			Non Latching	
		MANUAL RELEASE	Latching	Manual release switch, typically a pull station.
	INTERLOCK	Non Latching	Interlock release switch input.	
	CO DETECTOR STATUS PT	Status Point Switch	CO Detector Switch	
	NOTIF	OUTPUT PT	Select Group	Output point, a general use notification type. Use for driving standard notification appliances.
		AUX CONST		Use constant power for applications that require a constant auxiliary power source. Power is always present at constant circuits.
		AUX RESET		Use for auxiliary power, resettable applications. See Section 4.12.5.3 for a description of how this option operates.
		AUX DOOR		Use for auxiliary power, door holder applications. For example, if you were using an auxiliary power supply for door holders, you would use this option. See Section 4.12.5.1 for a description of how this option operates.
	RELAY	OUTPUT PT	Select Group	Output point, a general use relay type. Use for applications requiring a relay, such as fan shutdown, elevator recall, and so on.
		AUX RESET	Select Group	Use for auxiliary power, resettable applications. See Section 4.12.5.3 for a description of how this option operates.
		AUX DOOR	Select Group	Use for auxiliary power, door holder applications. For example, if you were using an auxiliary power supply for door holders, you would use this option. See Section 4.12.5.1 for a description of how this option operates.
	SD SLC LED	Select LED No. 01 -80	Select Group	

7.5.2 Point Programming For Internal or External Power Module

To program for an internal or external power module points:

1. Enter the installer code. The panel will automatically go to the main menu.
2. Select 7 for Program Menu.
3. Press 4 to enter point menu.
4. Press the Up or Down arrows to select the desired module. Refer to Section 7.5.2 for available choices.
5. Press ENTER.
6. Enter the number of the circuit or point you wish to edit. Refer to Table 7-6 for available selections.
7. Press ENTER.
8. Select the type by pressing the Up or Down arrows.
9. Press ENTER.
10. Select the function by pressing the Up or Down arrows.
11. Press ENTER.
12. Select the group by pressing the Up or Down arrows.
13. Press ENTER.
14. Edit point name. See Section 7.5.5. Or, press the right arrow to skip point name edit.
15. Repeat Steps 1 through 15 for all circuits.

Table 7-6: Menu choices for Internal/External Power Module

Choices	Type Selections	Function Selections for each Type	Comments	
Enter Point				
Select Type	UNUSED			
	B NOTIF	NOTIF OUT		
	A NOTIF	CTRL CKT		
	AUX PWR	CONSTANT	CONSTANT	Constant auxiliary power.
		RESETTABLE	RESETTABLE	Resettable auxiliary power.
		DOOR	DOOR	Door holder auxiliary power.
		SOUNDER SYNC	SOUNDER SYNC	Sounder Sync auxiliary Power
	B SWITCH	MANUAL PULL	MANUAL PULL	Refer to comments column of Table 7-5 for description of these options. Latch or Non-latching feature only appears for waterflow, supervisory, tamper, zone aux1, zone aux2, system aux1, and system aux2.
		WATERFLOW	WATERFLOW	
		FIRE SUPERVISORY	FIRE SUPERVISORY	
		TAMPER	TAMPER	
		FIREDRILL	FIREDRILL	
		SILENCE	SILENCE	
		RESET	RESET	
		PAS_ACK	PAS_ACK	
		ZONE AUX1	ZONE AUX1	
		ZONE AUX2	ZONE AUX2	
		SYSTEM AUX1	SYSTEM AUX1	
		SYSTEM AUX2	SYSTEM AUX2	
		MANUAL RELEASE	MANUAL RELEASE	
	INTERLOCK	INTERLOCK		
STATUS POINT	STATUS POINT	Non-latching - Used to activate an ancillary Output Group that does not active alarm, sound PZT, display status or report events. Reset has no affect on this point		
A SWITCH	Same as B SWITCH			
B DETECT	2-WIRE SMK	2-WIRE SMK	Used for Class B, 2-wire detectors.	
	4-WIRE SMK	4-WIRE SMK	Used for Class B, 4-wire detectors.	
	4-WIRE CO SMK	4-WIRE CO SMK	Used for Class B, 4-wire CO detectors	
A DETECT	2-WIRE SMK	2-WIRE SMK	Used for Class A, 2-wire detectors.	
	4-WIRE SMK	4-WIRE SMK	Used for Class A, 4-wire detectors.	
	4-WIRE CO SMK	4-WIRE CO SMK	Used for Class A, 4-wire CO detectors.	
Select Zone/Group			Group or Zone selection will appear depending on the type selected.	
Edit Name			See Section 7.5.5.	

7.5.3 Point Programming For 5880, 5865, EVS-50W, EVS-INT50W, EVS-100W, EVS-125W and EVS-CE4 Modules

To program 5880, 5865, EVS-50W, EVS-INT50W, EVS-100W, EVS-125W, or EVS-CE4 module points:

1. Enter the installer code. The panel will automatically go to the main menu.
2. Select 7 for Program Menu.
3. Press 4 to enter point menu.
4. Press the Up or Down arrows to select the desired module. Refer to Section 7.5.3 for available choices.
5. Press ENTER.

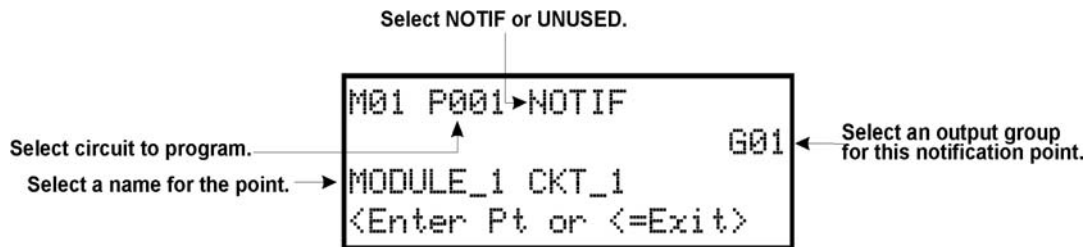

Figure 7-11 Programming Points Screen for 5880, 5865, and Amplifier Modules

6. Enter the point number.
7. Press ENTER.
8. Press the Up or Down arrows to select the type (notification or unused).
9. Press ENTER.
10. Press the Up or Down arrows to select the desired group.
11. Press ENTER.
12. Edit point name. See Section 7.5.5. Or, press right arrow to skip module name edit.
13. Repeat Steps 1 through 12 for all points.

7.5.4 Point Programming For EVS-VCM and EVS-RVM Modules

To program EVS-VCM and EVS-RVM module points:

1. Enter the installer code.
2. Select 7 for Program Menu.
3. Press 4 to enter point menu.
4. Press the Up or Down arrows to select the desired module. Refer to Section 6.6 for available choices.
5. Press ENTER.
6. Enter the point number.
7. Press ENTER.
8. Press the Up or Down arrows to select the type (Switch or unused).
9. Press ENTER.
10. Press the Up or Down arrows to select the function.
11. Press ENTER.

12. Use the Up or Down arrows to modify and remaining options and use ENTER to move to the next field.
13. Edit module name. See Section 7.2.1.1. or, Press the right arrow to skip module name edit.
14. Repeat Steps 1 through 13 for all points.

Table 7-7: Point Programming Options for EVS-VCM and EVS-RVM

Choices	Type Selections	Function Selections for each Type	Comments
Select Type	UNUSED		
	SWITCH	MANUAL PULL	Refer to comments column of Table 7-6 for description of these options. Latch or Non-latching feature only appears for waterflow, supervisory, tamper, zone aux1, zone aux2, system aux1, and system aux2.
		WATERFLOW	
		FIRE SUPERVISORY	
		TAMPER	
		FIREDRILL	
		SILENCE	
		RESET	
		PAS_ACK	
		ZONE AUX1	
		ZONE AUX2	
		SYSTEM AUX1	
		SYSTEM AUX2	
		MANUAL RELEASE	
		INTERLOCK	
		STATUS POINT	
V_AuxStat	No Alarm LED		
V_AuxECS	General Alarm LED		

7.5.5 Assigning a Name to Points

You can assign a name to a point to make it easier to recognize on a display.

To edit a point name:

1. When the display is flashing on the Edit Name field press ENTER.
2. Use the ▲ or ▼ arrow to scroll through the character options. Refer to Appendix B.
3. Use the number keys to select desired characters.
4. Use the LEFT or RIGHT arrows to change character position.
5. Press ENTER when finished. If you wish to bypass the Edit Name field press the right arrow.

7.6 System Options

This section of the manual explains how to customize software options that affect general operation of the system. This includes such items as: AC loss reporting delay, system clock options, telephone and reporting account options. Refer to each individual subsection for complete instructions.

7.6.1 Reporting Account

Up to four reporting accounts can be used with the control panel. Events in accounts are reported by zone.

Each account is assigned an up-to-6-digit account number. Each account is also assigned a unique ID (1-4) which determines the priority for reporting (“1” has the highest priority; “4” has the lowest).

Disable any unused accounts by selecting “N” for all events (see Figure 7-12). If the system is local only (does not connect to a central station), disable all events for all four reporting accounts.

Options for each account can be customized. These options appear on the Reporting Accounts screen. Some related options appear on the Phone Lines screen (see Section 7.6.2).

To access the Reporting Accounts screen:

1. Enter the installer code. The panel will automatically go to the main menu.
2. Select 7 for Program Menu.
3. From the Program Menu, select 5 for System Options.
4. From the next menu, select 0 for Reporting Accounts.

7.6.1.1 Edit Accounts

5. From the next menu, select 1 for Edit Account.

A screen similar to one shown in Figure 7-12 will display. The following subsections describe the options on each field.

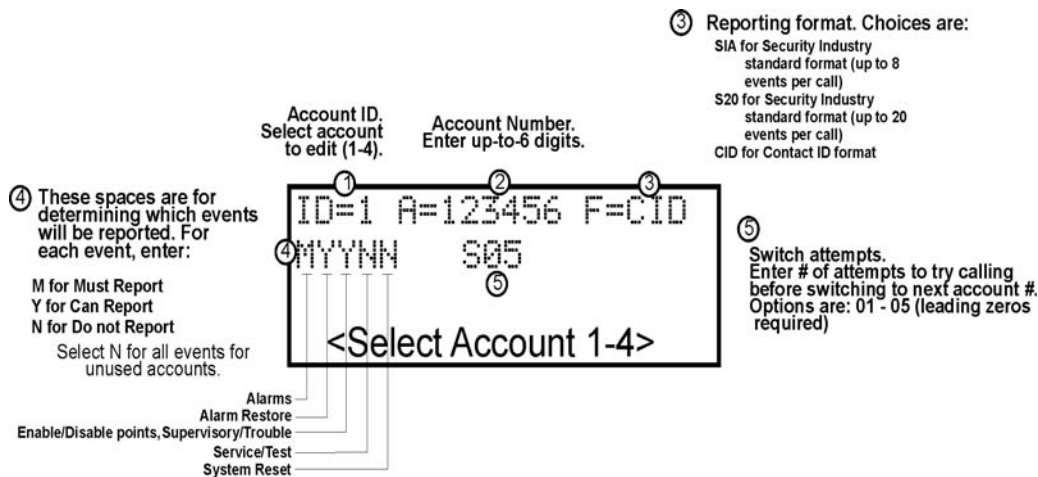

Figure 7-12 Reporting Account Editing Screen

Select Account (ID)

The control panel provides up to 4 reporting accounts. The priority of an account is based on its account ID. Account 1 is highest priority; Account 4 is lowest. Use Account 1 to report the highest priority events.

6. Press the ▲ or ▼ arrow to select account ID number, then press ENTER.

Edit Account Number

Enter an up-to-6-digit number for each account to identify the account to the central station. See Figure 7-12 for location of this option on the screen. The account number should be compatible with the reporting format used. For example, the Contact ID format transmits up to four digits only.

7. Enter the desired account number (up to 6-digits), then press ENTER.

Select Reporting Format

Select a reporting format for each account. Options are:

SIA	SIA format. 8 events per call.
CID	Ademco's Contact ID format
S20	Same as SIA reports up to 20 events per phone call.

8. Press the Up or Down arrow to select the reporting format, then press ENTER.

Events to Report

The next five options select which types of events (or event families) will be reported to this account. (See Figure 7-12 for location of these options on the screen).

Event Family	Events Included in this Family
Alarms	All alarms (Water Flow, Manual Pull, Detectors, Auxiliary Switches, etc.)
Alarm Restore	All alarm restores.
Supervisory/Trouble Enable/Disable Point	All trouble and supervisory conditions and trouble and supervisory restores. Enabling and disabling of input and output points.
Service/Test	Fire drill, walk test, dialer test, automatic test, all programming sessions.
System Reset	All system resets.

9. Press the Up or Down arrow to select Must, Yes, or No (see table below), then press ENTER.
10. Repeat step 9 for all five event report options.

For each event family, select M, Y, or N.

M(ust)	Must Report. Selecting "M" makes this a primary reporting account for this family of events. The dialer MUST report events in this family to this account. Selecting Must makes an account a primary reporting account. The dialer will try to report the event to the primary account until it exceeds the "Switch Attempts" value. When the dialer has exceeded the Switch Attempt retry limit, it will switch to a backup account (a "Can Report" or "Yes" account, see below). If the dialer cannot report the event to any of the backup accounts, it will return to the primary account and repeat the process until it exceeds or, an Account Trouble condition is generated and a local trouble will sound.
Y(es)	Can Report. Selecting Y makes this a backup account for this event family. The dialer will report to this account only if it was previously unable to report the event to a Must account.
N(o)	No events in this family will ever be reported to this account.

Switch Attempts

Specify the number of times the dialer should attempt to report to this account before switching to the next account. Range is 01-5.

11. Enter the number of switch attempts (or press the Up or Down arrow), then press ENTER.

Telephone Number

Enter up to 24 characters for phone number for this account.

Enter up to 24
characters for the
phone of the account.

Comma adds a 2
second pause.



Figure 7-13 Edit Phone Number

The following special characters are available:

Table 7-8: Special Character for Dialing

#	Pound (or number) key on the telephone
*	Star key on the telephone
,	Comma (character for 2-second pause)

- Use the number buttons on the annunciator or the up- and down-arrow keys to select special characters. Characters begin displaying after “9”. See Figure 7-13 for an example.

7.6.1.2 Auto Test Time

To access the automatic dialer test time screen:

- Enter the installer code. The panel will automatically go to the main menu.
- Select 7 for Program Menu.
- From the Program Menu, select 5 for System Options.
- From the next menu, select 0 for Reporting Account.
- From the next menu, select 2 for Auto Test Time.
- Enter the hour you desire the control panel to send an automatic test report (or press the Up or Down arrow), then press ENTER.
- Enter the minutes (or press the Up or Down arrow), then press ENTER.
- Select AM or PM by pressing the Up or Down arrow, then press ENTER.
- Select Report Time Interval by pressing the Up or Down arrow, then press ENTER. Time Interval selections are 24hr, 12hr, 6hr and 4 hr.

7.6.2 Phone Lines

To access the phone lines screen:

- Enter the installer code. The panel will automatically go to the main menu.
- Select 7 for Program Menu.
- From the Program Menu, select 5 for System Options.
- Select 1 for the Phone Lines.

5. Select the phone line to be edited (1 or 2) by pressing the ▲ or ▼ arrow, then press ENTER.

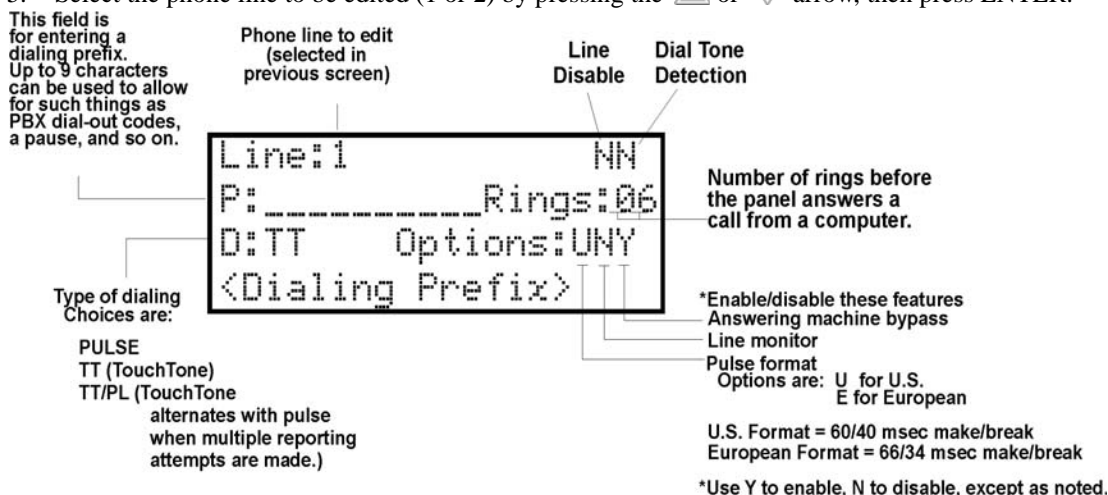

Figure 7-14 Phone Lines Editing Screen

7.6.2.1 Dialing Prefix

Enter up to 9 characters to be used for such things as PBX dial-out codes, a pause, and so on. The following special characters are available:

- # Pound (or number) key on the telephone
- * Star key on the telephone
- , Comma (character for 2-second pause)

Use the number buttons on the annunciator or the up- and down-arrow keys to select special characters. Characters begin displaying after “9”. See Figure 7-14 for an example.

6. Enter a dialing prefix (if needed), then press ENTER. Or Press the right arrow to bypass the dialing prefix option.

7.6.2.2 Number of Answer Rings

This option is used in conjunction with the 5660 SKSS. Use the option to determine the number of rings before the panel answers a call from the computer. Range is 00-15 rings. This option is factory-programmed as 06 rings, which should be compatible for most installations where the answering machine bypass feature is used. You may need to adjust it depending on the installation’s telephone system.

The selection made here must match the programming for this option in the Communication Configuration dialog box of the 5660 SKSS. See the software manual for more information (PN 151240).

7. Enter the desired number of answer rings, then press ENTER.

7.6.2.3 Dial Option (TouchTone or Pulse)

8. Press the ▲ or ▼ arrow to select the dial option, then press ENTER.

Dial Option	Description
PULSE	If this option is selected, only pulse dialing will be used for this phone line.
TT	TouchTone dialing. If this option is selected, only TouchTone dialing will be used for this phone line.

Dial Option	Description
TT/PL	TouchTone alternating with pulse. If this option is selected, the dialer will first attempt to use TouchTone. It will switch to pulse if TouchTone is not successful on the first attempt. It will continue to alternate between TT and pulse for additional attempts.

7.6.2.4 Rotary Format

- Press the Up or Down arrow to select the pulse ratio for rotary dialing option, then press ENTER.

Options are:

- | | |
|---|--|
| U | U.S. standard format. Uses the 60 msec / 40 msec make/break ratio. |
| E | European format. Uses the 66 msec / 34 msec make/break ratio. |

7.6.2.5 Line Monitor

Enable the line monitor for each phone line that will be used. See Figure 7-14 for location of this field on the phone lines screen. When the phone line monitor has been enabled for a phone line, a trouble condition will occur if the line is not connected. If a phone line will not be used, it must be disabled.

- Select Y (monitor line) or N (don't monitor line) by pressing the Up or Down arrow, then press ENTER.

7.6.2.6 Answering Machine Bypass

This option is used in conjunction with the 5660 SKSS. This feature ensures that an answering machine will not interfere with communication between the panel and the computer. If an answering machine is used at the panel site, enable this feature; if an answering machine is not used, disable the feature.

This option is factory-programmed as Yes (enabled).

The selection made here must match the programming for this option in the Communication Configuration dialog box of the 5660 SKSS. See the 5660 SKSS manual for more information (PN 151240).

- Select Y (answering machine bypass enabled) or N (answering machine bypass disabled) by pressing the Up or Down arrow, then press ENTER.

7.6.3 System Event Outputs

- Enter the installer code. The panel will automatically go to the main menu.
- Select 7 for Program Menu.
- Select 5 for System Options.
- Select 2 for Sys. Event Outputs.

7.6.3.1 Trouble Events

You can map certain system trouble events to an output group. To access the screen for selecting output groups and cadence patterns for system trouble events.

5. Press 1 for Trouble Events. A screen similar to the one in Figure 7-15 will display. Select a group and a cadence pattern for each event as needed for your application. The U: field is for a user-specified trouble condition. You can program an output group and cadence pattern for any of the following events:

Battery	Low battery condition
Gnd Flt	Ground fault
Phone Ln	Phone Line 1 or 2 trouble
Account	Account trouble; cannot report to account
Printer	Printer trouble
Aux Pwr	Auxiliary power trouble
Sys Sw	Trouble with a system switch
Group Tr	Trouble with an output group
SBUS Com	SBUS communication trouble
SBUS Pwr	SBUS power trouble
SLC Loop	Trouble on the SLC loop
AC Loss	AC power lost

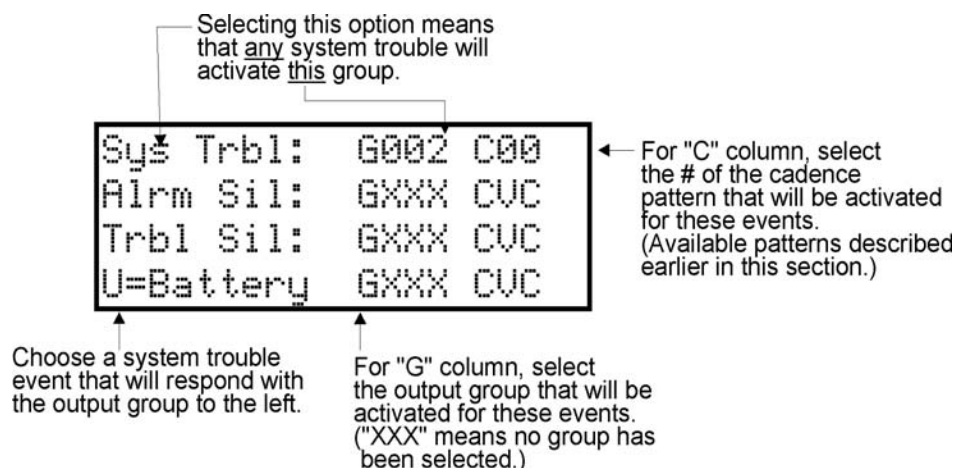

Figure 7-15 System Trouble Event Mapping Example

7.6.3.2 System Alarm Cadence

Fire drill and system auxiliary alarm events can have special cadence patterns to distinguish them from other types of alarms. See Section 7.3.1.4 for available cadence patterns.

A typical use of the System AUX1 and AUX2 patterns is to distinguish fire emergencies from other types of emergencies. The System AUX1 and AUX2 alarms would be triggered by a system-wide switch.

To access the screen for selecting output groups and cadence patterns for system trouble events:

1. Enter the installer code. The panel will automatically go to the main menu.
2. Select 7 for Program Menu.
3. Select 5 for System Options.
4. Select 2 for Sys. Event Outputs.
5. Press 2 for System Alarm Cadence.

A screen similar to the one in Figure 7-16 will display. Select a cadence pattern for these special events if

required for your application.

```

Fire Drill Cad =00
System AUX1 Cad=00
System AUX2 Cad=00
<FireDrill Cadence>

```

Figure 7-16 Special Cadence Patterns for Fire Drill and Auxiliary Alarm Events

7.6.4 Time Options

Through this programming option you can set the water flow delay time, Alarm Verification, low AC report delay, AMPM/Military time and AC Frequency.

To change time options, follow these steps.

1. Enter the installer code. The panel will automatically go to the main menu.
2. Select 7 for Program Menu.
3. Select 5 for System Options.
4. Select 5 for Time Options.

7.6.4.1 Water Flow Delay

You can program a delay of 0-90 seconds (zero means no delay) to be used in conjunction with a water flow switch. The delay is system-wide. All water flow switches on the system will use the same delay period.

To access the screen for programming water flow delay, follow these steps:

1. Enter the installer code. The panel will automatically go to the main menu.
2. Select 7 for Program Menu.
3. Select 5 for System Options.
4. Select 5 for Time Options.

A screen similar to the one shown in Figure 7-17 will display.

```

WF Dly:01s AlmVer060
Low AC Dly:03h
C1k:AMPM AC-Freq:60
<Water Flow Delay>

```

Delay in seconds
before waterflow
alarm occurs.
(00 - 90)

Figure 7-17 Water Flow Delay Programming Screen

5. Enter the number of seconds (0 to 90) to delay an a water flow switch alarm, then press ENTER.

7.6.4.2 Alarm Verification Time

You can set the alarm verification time from 1 to 250 seconds (default is 60 seconds).

To set the alarm verification:

6. Enter the desired number of seconds for the alarm verification time.
7. Press the right arrow or ENTER to make your selection and move to the next programming option.

7.6.4.3 Low AC Report Delay

Note: You must select 1-3 hours in UL central station installations and UL remote signaling installations.

You can adjust the number of hours before a low AC report will be sent to the central station.

To program low AC report delay, follow these steps:



Figure 7-18 Low AC Report Delay Programming Screen

- Enter the number of hours before a low AC report will be sent to the central station, then press ENTER. Refer to Figure 7-18.

7.6.4.4 Clock Display Format (AM/PM or Military)

To change the system clock display format, continue programming from step 8 above:

- Select AMPM (for AM/Pm display format) or MIL (for military or 24 hr display format) by pressing the Up or Down arrow, then press ENTER.

7.6.4.5 Change AC Line Frequency

The panel's AC line frequency is selectable for 50, 60 Hz, or Neither. AC Frequency feature dictates how the control panel will calculate time based on the AC line frequency used in the installation site. The "Neither" option can be used in areas where the AC line frequency is not dependable and you want the panel to calculate time from the internal crystal. The internal crystal is not as accurate as the AC power source and either 60 Hz or 50 Hz should normally be selected. The panel defaults to the 60 Hz. selection.

To change the AC line frequency, continue programming from step 9 above:

- Select 50, 60 or Neither, by pressing the Up or Down arrow, then press ENTER.

7.6.5 Miscellaneous Options

Through this programming option you can turn on or off strobe synchronization during silence, display status at idle (auto display event), report by zone or point, plexiglass door, and single key ack.

To edit miscellaneous options:

- Enter the installer code. The panel will automatically go to the main menu.
- Select 7 for Program Menu.
- Select 5 for System Options.
- Select 6 for Miscellaneous Options.

7.6.5.1 Synchronize Strobes Active During Silence

When "SYNC Strbs w/ Sil:" is Selected as Y (Yes) then strobes will continue to flash when the system is silenced and will stop flashing when the system is reset.

Note: The "SYNC Strbs w/ Sil:" only functions with outputs that use a synchronized output pattern.

- Press the Up or Down arrow to toggle this selection between Y (Yes) or N (No).
- Press the right arrow or ENTER to make your selection and move to the next programming option.

Note: See Section 7.3.1.4 for more information about Synchronization protocol choices.

7.6.5.2 Auto Display Oldest Event

When this feature is programmed Y (Yes) then the oldest un-acknowledge event will automatically display on the control panel and remote annunciators after there has been no activity on any system touchpad for two minutes.

7. Press the Up or Down arrow to toggle this selection between Y (Yes) or N (No).
8. Press the right arrow or ENTER to make your selection and move to the next programming option.

7.6.5.3 Report by Zone or by Point

When the “Report by” option is set to Zone, then the control panel will report events by zone. If Point is selected then the control panel will report events by point.

9. Press the Up or Down arrow to toggle this selection between Zone or Point.
10. Then press the right arrow or ENTER. See Section 10 for reporting codes.

7.6.5.4 Plex Door Option

If installing the plex door hardware (PN Plex-1), you must turn the Plex Door option *On* as described in this section.

To turn the Plex Door option on/off:

11. Press the Up or Down arrow to toggle this selection between Y (Yes) or N (No).
12. Press the right arrow or ENTER to make your selection and move to the next programming option.

7.6.5.5 Single Key Acknowledge

When this feature is programmed Y (Yes) it allows the user to press the ENTER and display the oldest un-acknowledged event in the system. Pressing ENTER again will acknowledge the event, then display the next oldest un-acknowledge event without pressing the Up or Down arrow keys.

7.6.6 Daylight Savings

To edit Daylight Savings:

1. Enter the installer code. The panel will automatically go to the main menu.
2. Select 7 for Program Menu.
3. Select 5 for System Options.
4. Select 7 for Daylight Savings.

7.6.6.1 Automatic Daylight Savings Adjustment

The control panel has an automatic DST (Daylight Saving Time) adjustment feature. Before January 2007, if this feature is enabled (set to *Yes*), the system clock will switch to DST on the first Sunday in April at 2:00 a.m. and revert to standard time on the last Sunday in October at 2:00 a.m. After January 2007, if this feature is enabled, the system clock will start and end DST according to the settings made in Daylight Savings (see Section 7.6.6.2). If this feature is not enabled (set to *No*) the Daylight Saving Time change is not made to the system clock.

To enable or disable DST adjustment continue programming from step 4 above:

5. Select Y (enabled) or N (disabled) by pressing the Up or Down arrow, then press ENTER.

7.6.6.2 Daylight Saving Time Start and End

This option lets you to adjust the week and month Daylight Saving Time (DST) starts and ends. For this feature to work, you must enable (set to *Yes*) the DST option under Daylight Savings (see Section 7.6.6.1). You can view and change the settings in this option anytime, however, settings will not take effect until 2007. The default values for the DST Start and End options reflect the August 8, 2005 DST law that goes into effect in 2007:

DST Start: The second Sunday in March
DST End: The first Sunday in November

To set the start and end for Daylight Saving Time:

1. Press the Up or Down arrow to select the week (1st, 2nd, etc.) Daylight Saving Time starts, then press ENTER to make your selection and move to the month setting.
2. Press the Up or Down arrow to select the month (January – December) Daylight Saving Time starts, then press ENTER to make your selection and move to the DST End option.
3. Press the Up or Down arrow to select the week (1st, 2nd, etc.) Daylight Saving Time ends, then press ENTER to make your selection and move to the month setting.
4. Press the Up or Down arrow to select the month (January – December) Daylight Saving Time ends, then press ENTER two times to make your selection and exit.

7.6.7 Edit Banner

The banner is the message that displays on the panel LCD when the system is normal, that is, when no alarms or troubles exist and the system menus are not in use. A custom message of up to 40 characters can be created.

If a customize message is not created, the system will use the internal banner. You cannot change the internal banner.

To customize the banner display message:

1. Enter the installer code. The panel will automatically go to the main menu.
2. Select 7 for Program Menu.
3. Select 5 for System Options.
4. Select 8 for Edit Banner. A screen similar to the one shown in Figure 7-19 will display.

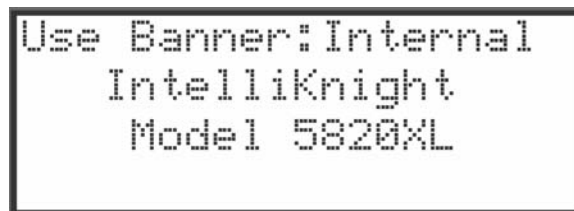

Figure 7-19 Internal Banner Message

5. Press the Up or Down arrow to select “Custom”, then press ENTER. A screen similar to the one shown in Figure 7-20 will display.



Figure 7-20 Custom Banner Edit Screen

6. Select each letter by pressing the Up or Down arrow, then press the right arrow to move to the next character.
7. When done, press ENTER to move to line two of the custom banner. Repeat step 6 and 7.

7.6.8 SLC Family

The 5820XL / 5820XL-EVS supports SD protocol SLC devices or Intelligent Device Protocol (SK) SLC devices. You must configure the 5820XL / 5820XL-EVS to accept the protocol of the devices you are installing. You cannot mix SLC devices of different protocols.

1. Enter the installer code. The panel will automatically go to the main menu.
2. Select 7 for Program Menu.
3. Select 5 for System Options.
4. Press 9 for SLC Family.
5. Press the Up arrow to select the desired SLC device type.
6. Press enter to accept the displayed SLC device type.

7.7 JumpStart Autoprogramming

IMPORTANT!

JumpStart is intended to be used prior to performing any custom programming. Each time JumpStart is executed, all options will be reset to their default values. Do not run JumpStart after you have configured the system through programming.

To run JumpStart:

1. Enter the installer code. The panel will automatically go to the main menu.
2. Select 7 for Program Menu.
3. Select 6 for System Options.
4. Press the Up or Down arrow to select “Yes” from the warning screen.
5. Press ENTER.

7.8 Computer Account

An installer at the panel site can initiate communications between the panel and a computer running the 5660 SKSS (see also Section 8.5.17). In order for this communication to function properly both the computer (running the software) and the control panel must have matching computer account numbers and computer access codes.

Before you program in this location you should know how your control panel will communicate with the downloading computer, either through direct connect (RS232 or USB) or via the phone lines (Internal Modem).

If the panel initiates the call to a downloading computer, a phone number must be programmed in the computer accounts area. If the computer initiates the call, answering machine bypass may need to be selected (see Section 7.6.2.6).

To program computer account information:

1. Enter the installer code. The panel will automatically go to the main menu.
2. Select 7 for Program Menu.
3. Select 5 for System Options.
4. Enter the computer account number, then press ENTER.
5. Enter the computer code (up to 7-digits), then press ENTER.
6. Enter the phone number the panel will dial to connect to a downloading computer (up to 40-digits), then press ENTER. See Table 7-8 for special dialing characters.

7.9 Access Codes

Access codes provide the user access to the control panel functions. Each access code can be customized for each user. This allows some users the ability to access programming and other higher level panel functions, while other users may only need access to lower level functions such as performing fire drills, or acknowledging trouble conditions.

Profile 1 is the profile that dictates what functions the Fire Fighter Key has access to. Because this is the profile for a key the user name and the access code can not be edited for this profile.

Profile 2 is the profile for the installer and is referred to as the "Installer Code". This profile's user name and

panel functions can not be edited. Table 7-9 lists the panel functions that can be selected for each user profile.



Table 7-9: User Profile Selectable Panel Functions

Type of Function	Selectable Functions
Panel Operations	System Reset
	System Silence
	Event Ack
	EVS Control Request
	EVS Super User
Panel Menus	System Test
	Fire Drill Menu
	Indicator Test
	Walk Test no Rpt
	Walk Test with Rpt
	Dialer Test
	Clear History Buf
	Point Functions
	Disable/Enable Pt
	Point Status
	Set SLC Dev Addr
	SLC Dev Locator
	SLC Mult Locator
	I/O Point Control
	Event History
	Set Time & Date
	Printer Options
	Event Logging
	Print Event History
	Print Detector Status
	Print System Cfg
	Reset Dialer
	Program Menu
System Information	
Upload/Download	

To change an access code:

1. Enter the installer code. The panel will automatically go the main menu.
2. Select 7 for Program Menu.
3. Select 8 for System Options.

Display reads: Select Profile 01
 Fire Fighter's Key

4. Select the access code you wish to edit by pressing the  or  arrow.
5. Then press ENTER.

7.9.1 Profile Edit Menu

From the Profile Edit Menu you can change the users name, access code, and the panel functions that the user will have access to with their code.

Note: Profile 1 (Fire Fighter's Key) the user name and access code can not be edited. Profile 2 (Installer) the user name and panel functions can not be edited.

7.9.1.1 Edit Name

6. Select each character of a word by pressing the Up or Down arrow, then press the right arrow to move to the next character.
7. Repeat step 6 until user name is complete.
8. Then press ENTER to finish.

7.9.1.2 Edit Access Code

9. Enter new access code (minimum of 4 digits, maximum of 7 digit).
10. Press ENTER.
11. Enter code again.
12. Press ENTER.

7.9.1.3 Panel Functions

13. Press the Up or Down arrow to move through the list of available functions.
14. Then press the right arrow to move to Y (yes) or N (no) selection column.
15. Press the Up or Down arrow to select Y or N.
16. Press ENTER.
17. Repeat steps 13 through 16 until user profile is complete.

7.10 Voice Options

7.10.1 EVS-VCM Maintenance

The EVS-VCM Maintenance menu is used to program custom messages into the EVS-VCM. Messages.

1. Enter the installer code. The panel will automatically go to the main menu.
2. Select 7 for Program Menu.
3. Select 9 for Voice Options.
4. Select 1 for VCM Maintenance.

7.10.1.1 PC Connection

This option is used when adding or editing user message through the EVS Message Manager Software. Refer to Section 9.10.4 for more information on this procedure.

7.10.1.2 Local Recording

Select this option if you wish to record the user message with the EVS-VCM microphone, or through the sound card of your PC. Refer to Section 9.10.1 and Section 9.10.2 for more information on this procedure.

7.10.2 Edit Voice Commands

When a voice output group is selected to be activated by a zone, the cadence pattern choice listed in Section 7.3.1.4 do not apply. For voice output groups, one of seventeen system wide voice commands will activate

instead of the cadence pattern. Which command is determined by the event type selected for that zone. This menu option allows you to program, the message to be used, the tone used, repeats, and message delays, for each of the seventeen commands. Table 9-3 lists the seventeen different commands and the associated event type. See also Section 7.3.1 for more information.

1. Enter the installer code. The panel will automatically go to the main menu.
2. Select 7 for Program Menu.
3. Select 9 for Voice Options.
4. Select 2 for Edit Voice Cmds.
5. Select the command you wish to edit:
 - Fire Alarm
 - Fire Aux1
 - Fire Aux2
 - Alarm CO
 - Fire Supervisory
 - CO Alarm
 - CO Supervisory
 - Trouble
 - Custom Emergency Comm
 - Emergency Comm 1 thru 8
6. Select the desired message used for that command.
7. Select the tone to be played between messages. (ANSI, March Code, California, Steady, Alert Tone, High-Low, ANSI Whoop, Cont Whoop, Temporal 4, Temp 4 520Hz, ANSI 520Hz, Steady 520Hz, No Tones).

Note: 520Hz tones are available when using EVS-100W or EVS-INT50W. See Table A-3 for a list of compatible speakers.
8. Select how many times you wish the message to repeat. (None, 1 - 14, or Continuous).
9. Enable/Disable AMR (Allow Message to Repeat with New Group Activation). Y = Yes, N = No.
10. Select the initial delay time (0 to 28, or 3 seconds, in 4 second increments).
11. Select the inter message delay time (4 to 32 seconds, in 4 second increments).

7.10.3 EVS System Options

7.10.3.1 Enable EVS System

1. Select 7 for Program Menu.
2. Select 9 for Voice Options.
3. Select 3 for EVS System Options.
4. Then select 1 for Enable EVS System.
5. The following screen will appear:

```
Do you wish to
ENABLE the Emergency
VOICE System?
Yes
```

6. Press the Up or Down arrow to toggle this selection between Yes or No, then press ENTER.

7.10.3.2 Edit Command Priority

1. Select 7 for Program Menu.
2. Select 9 for Voice Options.
3. Select 3 for EVS System Options.
4. Then select 2 for Edit Cmd Priority.
5. Press the Down arrow to select the voice command you want to change. It will be blinking.
6. Press ENTER on the blinking command message to move.
7. Press the Up or Down arrow to move the voice command to the appropriate priority location.
8. Pressing ENTER will lock the message into its location.
9. Repeat process to change priority of other message. Keep in mind the priority limitations described in section 9.11.1.

7.10.3.3 Edit Command Mapping

1. Select 7 for Program Menu.
2. Select 9 for Voice Options.
3. Select 3 for EVS System Options.
4. The select 3 for Edit Cmd Mapping.
5. Select the EVS Message for items described. See Table 9-3.
6. Eight groups or templates can be entered in the following screen:

GXXX -CVC GXXX - CVC

GXXX -CVC GXXX - CVC

GXXX -CVC GXXX - CVC

GXXX -CVC GXXX - CVC
7. If a voice group is entered in the GXXX field, the Cadence field will be filled with a CVC and the field is not able to be edited.
8. If a non-voice group is entered in the GXXX field, the user will be allowed to enter a Cadence value. See example below:

G004 -CVC G001 - C03

7.10.3.4 Edit Timers

1. Select 7 for Program Menu.
2. Select 9 for Voice Options.
3. Select 3 for EVS System Options.
4. The select 4 for Edit Timers.
5. From next menu, select 0 for Control Lockout.
6. Press the Up or Down arrow to select Immed/Timer/Never, then press ENTER. If timer is selected, enter the minutes (Range 0-720), and seconds (Range 0 to 59), then press ENTER. (Default is 30 seconds).
7. To edit Auto Reset:
 - Press 1 for Auto Reset EC 0.

- Press 2 for Auto Reset EC 1.
 - Press 3 for Auto Reset EC 2.
 - Press 4 for Auto Reset EC 3.
 - Press 5 for Auto Reset EC 4.
 - Press 6 for Auto Reset EC 5.
 - Press 7 for Auto Reset EC 6.
 - Press 8 for Auto Reset EC 7.
 - Press 9 for Auto Reset EC 8.
8. Press the Up or Down arrow to select Never/Timer/Event Disabled, then press ENTER. (If timer is selected, a range of 0 to 240 minutes is allowed. Default is Never Auto Reset).

7.10.3.5 Edit Event Names

1. Select 7 for Program Menu.
2. Select 9 for Voice Options.
3. Select 3 for EVS System Options.
4. The select 5 for Edit Event Names.
5. Press the Up or Down arrow to Select Voice Event:
 - Custom Emergency Comm
 - Emergency Comm 1
 - Emergency Comm 2
 - Emergency Comm 3
 - Emergency Comm 4
 - Emergency Comm 5
 - Emergency Comm 6
 - Emergency Comm 7
 - Emergency Comm 8
 - Aux Voice In Events
6. Press ENTER to change Event Name

Section 8

System Operation

Operation of the control panel is simple. Menus guide you step-by-step through operations. This section of the manual is an overview of the operation menus. Please read this entire section carefully before operating the panel.

Press ENTER to view Main Menu: Select the desired menu option. Enter your access code if prompted.

Note: See Section 7.9 for information on how to modify user access code profiles.

8.1 User and Installer Default Codes

User Code (factory-programmed as 1111).

Installer Code (factory-programmed as 5820).

8.2 Annunciator Description

Figure 8-1 shows the annunciator that is part of the control panel board assembly.

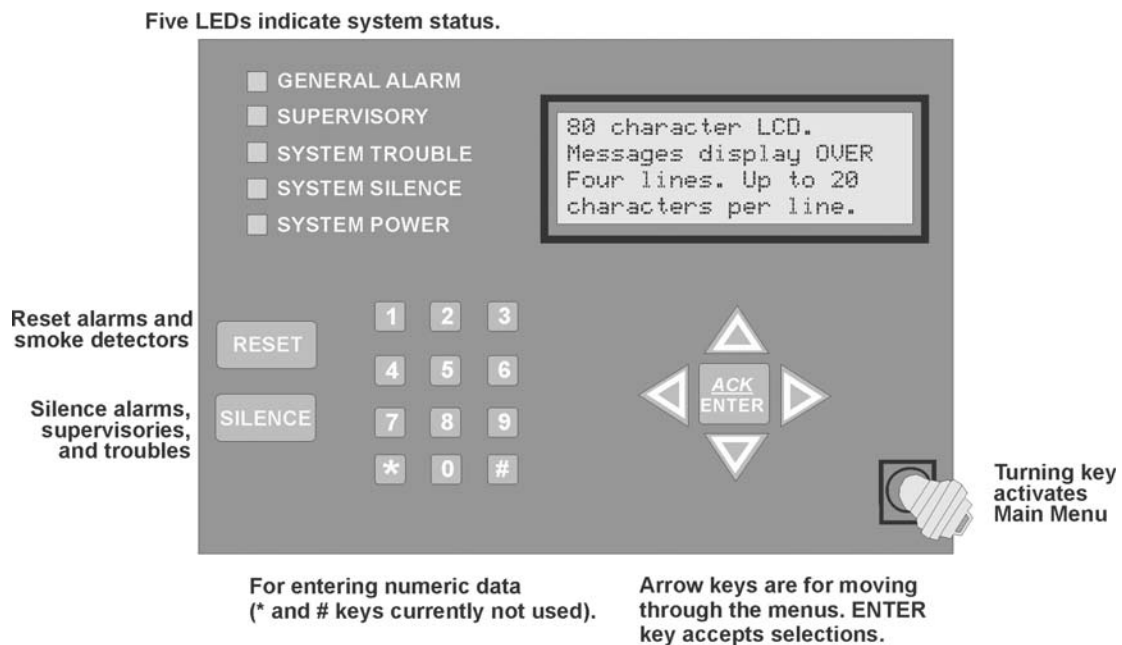

Figure 8-1 Control Panel Annunciator

8.2.1 LCD Display

The control panel LCD displays system messages, annunciates alarms, supervisories and troubles, provides status information, and prompts for input. These messages can be up to 80 characters, displaying over four lines of 20 characters each. Annunciator keys beep when they are pressed.

8.2.2 Banner

The banner is the message that displays on the control panel when the system is in normal mode (no alarm or trouble condition exists and menus are not in use). A custom message can be created that will display instead of

the internal (default) message. See Section 7.6.7 for information on customizing the banner.

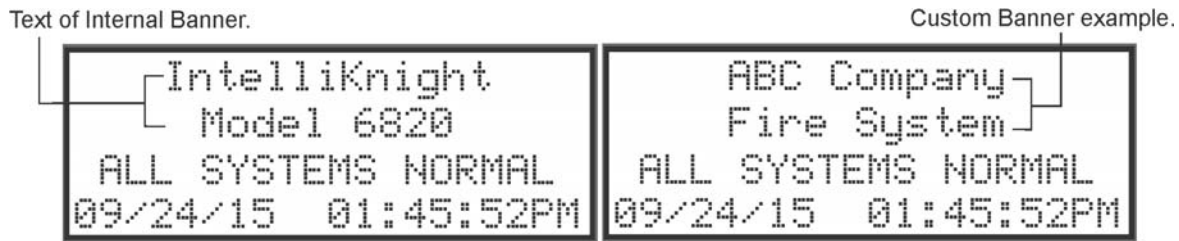

Figure 8-2 Banner Display Examples

8.3 Key Operation

The key on the control panel board assembly is for accessing the Main Menu. The key is activated when it is turned once to the right (clockwise). If the key has been used to activate the menu, it must be turned counter-clockwise to exit the menu.



Figure 8-3 Using a Key to Access the Main Menu

8.4 Menu System

The control panel is easy to operate from the Main Menu. To view the Main Menu press the ENTER or  button on the control panel or remote annunciator, then turn the firefighters key clockwise or enter your access code. The Main Menu will appear as shown in Section 8.4.1. Select the desired option. If you have entered a code or firefighters key does not have access to the menu item you have selected the following display message will appear:

```
-Access denied.-  
Entered PIN does not  
allow access to this  
function.
```

You must enter an access code with the correct profile settings to gain access to that menu item.



The control panel supports up to 20 access codes. The profile for each access code (or user) can be modified through the programming menu option (see Section 7.9 for access code programming).

8.4.1 Main Menu Overview

The chart below is a brief overview of the Main Menu. These options are described in greater detail throughout this section of the manual.



Main Menu Options	Description
1- System Tests	Access to Fire Drill, Indicator Test, Walk Tests, Dialer Test, Clear History Buffer, and Manual Dialer Reset.
2- Point Functions	Enable/disable points, Point Status, Set SLC Address, Device Locator, and I/O Point Control.
3- Event History	Display event history on the LCD. See Section 8.5.4 for more information.
4- Set Time & Date	Set time and date for the system.
5- Printer Options	Options for controlling a printer if attached to the system. If a printer is used, the Model 5824 serial/parallel interface module must be used.
6- Reset Items	Cancel any attempt to call the central station. Any calls awaiting additional attempts will be aborted.
7- Program Menu	Brings up a set of menus for programming the panel, including changing access codes. These options are described in detail in Section 7.
8- System Info	View system information, including model number, serial number, revision number and date.
9- Up/Download	Initiate communication between the panel and a computer running the Silent Knight Software Suite.

8.4.2 Using the Menus



To move through the menus:	Use the  or  to move through the options in a menu. Use the left arrow to move to a previous menu.
To select an option:	Enter the number of the option. -OR- Press ENTER (Enter key) if the option has the = symbol next to it.

8.5 Basic Operation

8.5.1 Setting Time and Date

- From the Main Menu, select 4 for Set Date & Time.
- Make changes in the fields on the screen. Use the right arrow to move through the fields. Use the  or  to select options in the fields.
- When the date and time are correct, press ENTER.

8.5.2 Disable / Enable a Point

- From the Main Menu, select 2 for Point Functions.
- Select 1 for Disable/Enable Point. A list of modules displays.
- Use the  or  arrow to move through the list. Press ENTER to select the module where the point you want to disable/enable is located. Select the point to disable or enable on the module. A description of the point should display. The fourth line of the screen should show "NORMAL" (meaning that the point is currently enabled) or "DISABLED" (the point is currently disabled). Press the right arrow to toggle between NORMAL and DISABLE.

8.5.2.1 Disable / Enable NACs by Template

1. Press 1 for Disable NACs by Template, press 2 to Enable NACs by Template.
2. Use the Up or Down arrow to move through the list of templates. Press ENTER to select the current template.

8.5.3 Disable / Enable NACs by Group

1. Select 1 for Disable/Enable Pt.
2. Select 3 to Disable NACs by group or 4 to Enable NACs by group.
3. Use the Up or Down arrow to move through the list of groups. Press ENTER to select the group highlighted.

8.5.3.1 Disable / Enable Zone Points

1. Press 5 to Disable Zone Points, press 6 to Enable Zone Points.
2. Use the Up or Down arrow to move through the list of zones. Press ENTER to select the zone highlighted.

8.5.4 View Event History

Use the View Event History feature to display events on LCD. From the Main Menu, press 3 to select Event History. Events will begin displaying with most recent events first.

The panel can store up to 1000 events. When it reaches its 1000-event capacity, it begins deleting, starting with the oldest events.

If a printer is attached to the system (via a Module 5824 serial/parallel interface module), you can print event history (see Section 8.5.18).

The 5660 SKSS or 5670 SKSS can be used to retain more than 1000 events and to create event history reports.

8.5.5 To clear the event history

From the main menu select 1 for System Tests. From the test menu select 6 Clear History Buffer.

8.5.6 Conduct a Fire Drill

1. From the Main Menu, press 1 for System Tests.
2. Press 1 for Fire Drill. You will be prompted to press ENTER.
3. The drill will begin immediately after you press ENTER.
4. Press any key to end the drill. (If you do not press any key to end the fire drill manually, it will time out automatically after ten minutes).

If a fire drill switch has been installed, activating the switch will begin the drill; deactivating the switch will end the drill.

8.5.7 Conduct an Indicator Test

The indicator test checks the annunciator LEDs and the PZT sounder.

1. From the Main Menu, press 1 for System Tests.
2. Press 2 for Indicator Test. The system turns on each LED and beeps the PZT. A problem is indicated if any of the following occurs:
 - An LED does not turn on
 - You do not hear a PZT beep

The test will time out after 15 minutes or you can press any key on the annunciator to end the test manually.

When the test ends, you will be returned to the System Test Menu.

8.5.8 Conduct a Walk Test

1. From the Main Menu, press 1 for System Tests.

IMPORTANT!

If any alarm verification zones are being used, the user will be asked if they wish to disable alarm verification during walk test. This occurs for either walk test option.

2. Select 3 for Walk Test-No Report. The LCD will display “WALK TEST STOPPED” on Line 1 and “ENTER = start test” on Line 3. Enter the time period you wish the NAC circuit to be active for each alarm (06 to 180 seconds). If you select this option, central station reporting will be disabled while the test is in progress.

Or

Select 4 for Walk Test-with Report. The LCD will display “WALK TEST STOPPED” on Line 1 and “ENTER = start test” on Line 3. Enter the time period you wish the NAC circuit to be active for each alarm (06 to 180 seconds). If you select this option, central station reporting will occur as normal during the walk test.

The panel generates a TEST report to the central station when the walk test begins. During a walk test, the panel’s normal fire alarm function is completely disabled, placing the panel in a local trouble condition. All zones respond as 1-Count zones (respond when a single detector is in alarm) during a walk test. Each alarm initiated during the walk test will be reported and stored in the event history buffer.

3. Press ENTER to end the walk test. The system will reset. The panel will send a “TEST RESTORE” report to the central station.

If you do not end the walk test manually within four hours, it will end automatically.

If an alarm or pre-alarm condition is occurring in the system, you will not be able to enter the walk test.

Note: The panel does not do a full 30 second reset on resettable power outputs. As soon as the device is back to normal, the panel is ready to go to the next device.

8.5.9 Conduct a Dialer Test

1. From the Main Menu, press 1 for System Tests.
2. Select 5 for Dialer Test. The screen will display “Manual dialer test started”. When the test is completed, you will be returned to the <Test Menu>.

8.5.10 Silence alarms or troubles

Press SILENCE and enter your code or rotate the key at the prompt. If an external silence switch has been installed, activating the switch will silence alarms or troubles. If you are already using system menus when you press SILENCE, you will not need to enter your code or rotate the key.

Note: Alarm and trouble signals that have been silenced, but the detector remains un-restored, will un-silence every 24 hours until the detector is restored.

Note: For EVS system, pressing silence at an LOC will only silence the System in Control. See Section 9.8.1.

8.5.11 Reset alarms

Press RESET and enter your code or rotate the key at the prompt. If an external reset switch has been installed, activating the switch will reset alarms.

Note: For EVS Systems, pressing reset at an LOC will prompt asking which system to reset.

8.5.12 Check Detector Sensitivity Through Point Status

The control panel constantly monitors smoke detectors to ensure that sensitivity levels are in compliance with NFPA 72.

If sensitivity for a detector is not in compliance, the panel goes into trouble, generating a CAL TRBLE condition. A detector enters a CAL MAINT state to indicate that it is approaching an out of compliance condition (but is currently still in compliance).

When a CAL TRBLE condition occurs, the central station receives a detector trouble report ("373" and the zone or point for Contact ID format; "FT" and the zone or point in SIA format).

To check sensitivity for an individual detector, follow the steps below. Section 8.5.18 provides instructions for printing the status of all detectors in the system.

1. From the Main Menu, press 2 for Point Functions.
2. Press 2 for Point Status.
3. Select the module where the point you want to check is located.
4. Enter the number of the point you want to check and press ENTER.
5. A screen similar to those shown in Figure 8-4 will display.

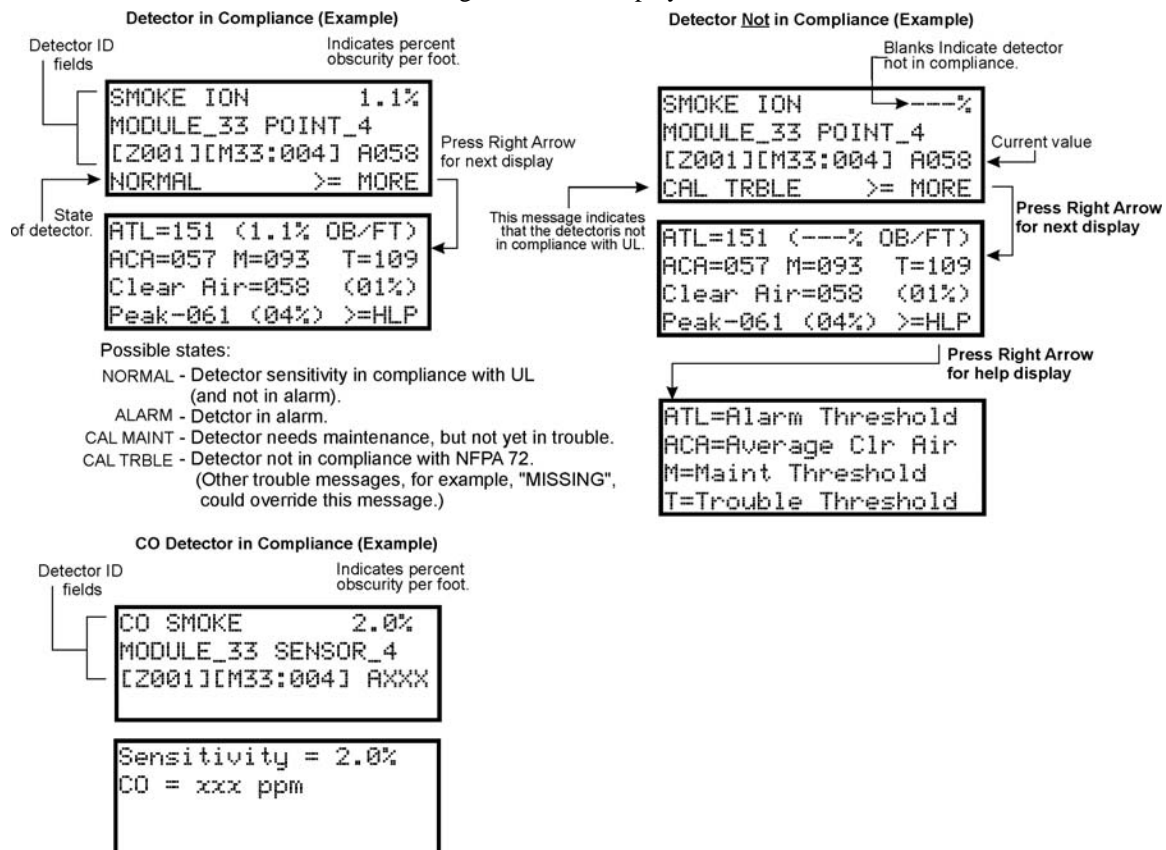

Figure 8-4 Checking Detector Sensitivity Compliance

If a printer is attached to the system (via a 5824 serial/parallel interface module), you can print detector status (see Section 8.5.18).

8.5.13 View Status of a Point

1. From the Main Menu, select 2 for Point Status.
2. From the list that displays, press ENTER to select the module where this point is located. Next, enter the point to display. The screen that displays will show you if the point has a trouble and will provide sensitivity compliance information. (See Section 8.5.12 for complete information about detector sensitivity compliance.)

8.5.14 View Alarms, Supervisories or Troubles

When the system is in alarm, supervisory, or trouble, you can press the down arrow to view the location of an alarm, supervisory, or trouble.

8.5.15 View System Information

Press 8 from the Main Menu to view the panel model and serial number and system version number and date. Press the left arrow to return to the main menu.

8.5.16 Reset Items

From the Main Menu, select 6 for Reset Items.

8.5.16.1 Reset Dialer

This options allows the user to Reset the Dialer. The LCD will display:

“Dialer Reset in progress... Please Wait“

You will be returned to the Main Menu when the reset is complete.

8.5.16.2 Reset DSP USB

This options allows the user to reset both the DSP Controller and USB interface logic. The LCD will display:

“Dialer Reset in progress... Please Wait“

You will be returned to the Main Menu when the reset is complete.

8.5.17 Communicating with a Remote Computer

An installer at the panel site can initiate communications between the panel and a computer running SKSS 5660. You can use this feature to upload a panel configuration. For example, if you have made programming changes to an installation on site using an annunciator, you can send your changes to the computer, so that the central station will have the latest data about the installation. See the software manual for more information (PN 151240).

To initiate communication:

1. From the Main Menu, select 9 for Up/Download.
2. From the next screen that displays, select the communication device. Options are:

- | | |
|----------------------|--|
| 1 = Internal Modem | If you select this option, you will use the panel's built-in modem to call the computer. |
| 2 = RS232 connection | If you select this option, the panel and a computer are both on-site connected via a 9-pin straight-through serial cable. |

3. If you are using the panel's internal modem to communicate, you will be prompted to enter a phone number. If you are communicating via the RS232 connection, a phone number is not needed and this step will be skipped.

If the phone number you will be calling is already displayed, press ENTER. Continue with step 4.

If the phone number you will be calling is not already displayed, enter the number and press ENTER. A phone number can be up to 40 digits long and can contain the following special characters.

#	Pound (or number) key on the telephone
*	Star key on the telephone
,	Comma (character for 2-second pause)

Use the number buttons on the annunciator or the up- and down-arrow keys to select special characters. Special characters begin displaying after "9".

4. You will be prompted to enter an account number. If the account number you want to use is already displayed, just press ENTER to begin communication or view the next screen.
If the account number displayed is not the correct one, enter the account number and press ENTER to begin communication.
5. If you are using the panel's internal modem to communicate, you will be prompted to select a modem speed. Press ENTER on a speed to begin communication.
6. The panel will attempt to communicate with the computer. If communication was established, the upload task you created will be placed in the SKSS 5660 job queue, awaiting processing. When processing is completed, an "Unsolicited Upload" task will appear in the queue.

8.5.18 Working with a Printer

If you are using the Model 5824 serial/parallel interface module, several printing options are available. See Section 4.7 for information about installing the 5824.

1. From the Main Menu, select 5 Printer Options.
2. From the next screen, select the 5824 module where the printer is connected.
3. If the printer is not currently busy printing another report, a screen with the following options will be available. If the printer is busy, a message will display. You can press 1 to cancel the current print job. These options will then display.

1= Event Logging

Enables event logging, which causes the printer to continuously print events as they occur. The date/time will print in 24-hour military format. Once event logging is enabled, it will remain enabled until canceled by the installer. If you need to disable event logging, return to this option and press 1 to disable.

Sample Event Log

```

EVENT LOG:                                     STARTED: 02/17/97 02:23
02/17/97 11:23 Event: System Silenced
02/17/97 11:24 Event: System Reset
02/17/97 14:30 Event: Local Programming Begin
02/17/97 15:01 Event: Local Programming Ended Successfully

EVENT LOG:                                     STOPPED: 02/17/97 15:02
    
```

2 = Print Event History

Prints the up-to-1000 events currently stored in the panel's event history buffer. Events print starting with the newest. The date and time printed will be when the event actually occurred and will print in 24-hour military format.

Sample Event History Print-Out

```

EVENT HISTORY:                                 PRINTED: 02/28/97 13:35
02/20/97 09:02 Event 3 of 10: System Silenced
02/20/97 09:05 Event 2 of 10: System Reset
02/22/97 08:47 Event 4 of 10: Printer Off Line 4
02/22/97 08:52 Event 4 of 10: Printer On Line 4
02/25/97 15:54 Event 5 of 10: Local Programming Begin
02/25/97 16:10 Event 5 of 10: Local Programming Ended Successfully
02/28/97 12:50 Event 6 of 10: Walk Test Begin
02/28/97 13:31 Event 2 of 10: Walk Test End
:
:
:
    
```

3 = Print Detector Status

Prints the current status of all detectors in the system. This is a method for finding out if any detectors are out of NFPA compliance or any detectors need maintenance (are approaching an out of compliance condition).

Sample Detector Status Print-Out

```

DETECTOR STATUS:                             PRINTED: 06/09/98 13:45
                                           NFPA72 Compliant
                                           Peak Percent Alarm
                                           Peak Clear Air
                                           Current Percent Alarm
                                           Clear Air Value
                                           Trouble Threshold
                                           Maintenance Threshold
                                           Average Clear Air
                                           Alarm Threshold Level
                                           Sensitivity %ob/ft or deg F
                                           Zone Number
    
```

ID NAME	TYPE	ZN	SENS	ATL	ACA	MT	TT	CAV	%A	PCA	%A	STATUS
Module 33=												
003 MODULE_33 POINT_3	PHOTO	1	---	240	141	83	94	140	0	141	0	CAL TRBL N
065 MODULE_33 POINT_65	HEAT	1	150	150	0	N/A	N/A	73	48	73	48	NORMAL Y
066 MODULE_33 POINT_66	HEAT	1	150	150	0	N/A	N/A	73	48	73	48	NORMAL Y
067 MODULE_33 POINT_67	HEAT	1	150	150	0	N/A	N/A	73	48	73	48	NORMAL Y
068 MODULE_33 POINT_68	HEAT	1	150	150	0	N/A	N/A	73	48	73	48	NORMAL Y





Note: Detector status can also be viewed and printed using the 5660 SKSS

4 = Print System Cfg

Prints the current system configuration of the panel. The entire configuration can be printed, or just specific sections.

8.6 Operation Mode Behavior

Operation Mode	Occurs When	System Behavior	In This Mode You Can
Normal	No alarm or trouble condition exists and menus are not in use.	<p>SYSTEM POWER LED is on. The All Systems Normal display indicates that the system is in normal mode.</p> <div data-bbox="581 489 992 638" style="border: 1px solid black; padding: 5px; text-align: center;"> <pre> IntelliKnight Model 6820 ALL SYSTEMS NORMAL 09/24/15 01:45:52PM </pre> </div>	Enter the appropriate code to activate the User or Installer Menu, or rotate the key to activate the User Menu.

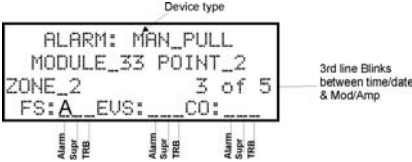
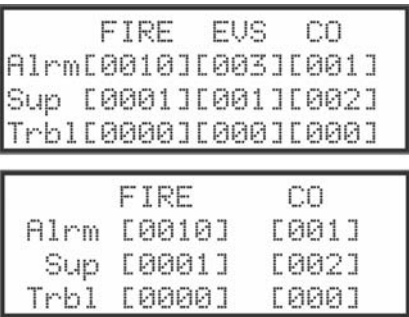
Operation Mode	Occurs When	System Behavior	In This Mode You Can
<p>Alarm</p>	<p>A smoke detector goes into alarm or a pull station is activated.</p>	<p>The dialer seizes control of the phone line and calls the central station. The on-board annunciator sounds a loud, steady beep (any notification devices attached to the system will also sound). GENERAL ALARM LED flashes. The LCD displays a screen similar to this one.</p> 	<p>Press the down arrow to view the alarm. A screen similar to this one displays.</p> 
	<p>CO Detector goes into Alarm.</p>	 <p>Press the down arrow to view the type and location of alarm. (Message alternates with the date/time display.)</p>	<p>Press SILENCE and enter an access code (or activate the key) to silence the annunciator (and any notification devices attached to the system). When the alarm condition clears, press RESET and enter a code (or activate the key) to restore the panel to normal. After sitting idle, events will display in a screen similar to this:</p>
	<p>EVS LOC or point alarm.</p>		
	<p>If more than 3 categories are active at a single time and EVS is enabled, top screen will display. If EVS in not enabled, it will look like bottom screen.</p>		<p>Note: Alarm and Prealarm are combines into single alarm count.</p>

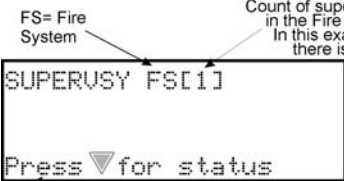
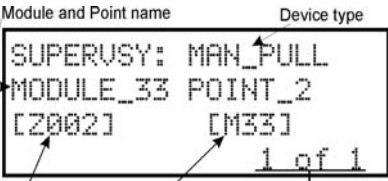
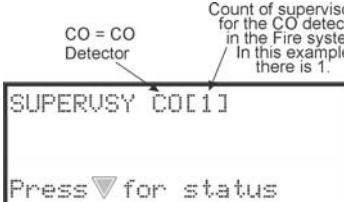
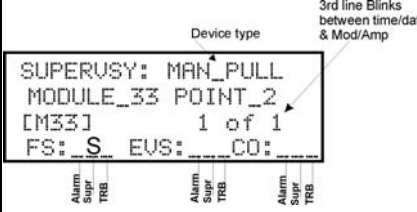
Operation Mode	Occurs When	System Behavior	In This Mode You Can
Supervisory	The system detects a supervisory condition.	<p>The dialer seizes control of the phone line and calls the central station. The on-board annunciator sounds a loud, pulsing beep in the sequence one second on, one second off.</p> <p>SUPERVISORY LED flashes.</p> <p>The LCD displays a screen similar to this one.</p>	<p>Press down arrow to view the supervisory condition. A screen similar to this one displays:</p>
	The system detects a supervisory condition with a CO detector.	 <p>FS= Fire System</p> <p>Count of supervisories in the Fire system In this example there is 1.</p> <p>SUPERVSY FSC[1]</p> <p>Press ▾ for status</p> <p>Press the down arrow to view the type and location of alarm. (Message alternates with the date/time display.)</p>	 <p>Module and Point name</p> <p>Device type</p> <p>SUPERVSY: MAN_PULL</p> <p>MODULE_33 POINT_2</p> <p>[Z002] [M33]</p> <p>1 of 1</p> <p>Zone #</p> <p>Module and Point name</p> <p>Shows which event is currently being displayed In this example there are 8 trouble, 5 is being displayed</p>
	The system detects a supervisory condition with the EVS system	 <p>CO = CO Detector</p> <p>Count of supervisories for the CO detectors in the Fire system In this example there is 1.</p> <p>SUPERVSY CO[1]</p> <p>Press ▾ for status</p> <p>Press the down arrow to view the type and location of alarm. (Message alternates with the date/time display.)</p>	<p>Press SILENCE and enter an access code (or activate the key) to silence the annunciator. Once the supervisory condition has been corrected, the system will restore itself automatically.</p> <p>After sitting idle, events will display in a screen similar to this:</p>  <p>Device type</p> <p>3rd line Blinks between time/date & Mod/Amp</p> <p>SUPERVSY: MAN_PULL</p> <p>MODULE_33 POINT_2</p> <p>[M33] 1 of 1</p> <p>FS: S EVS: CO:</p> <p>Alarm Supr TRB</p>

Operation Mode	Occurs When	System Behavior	In This Mode You Can
<p>Trouble</p>	<p>A system trouble condition occurs.</p>	<p>The dialer seizes control of the phone line and calls the central station. The on-board annunciator sounds a loud, pulsing beep in the sequence one second on, nine seconds off. SYSTEM TROUBLE LED flashes. The LCD displays a screen similar to this one.</p>	<p>Press down arrow to view the trouble, A screen similar tot his one display.</p>
	<p>Trouble condition with a CO detector</p>	<p>FS= Fire System Count of troubles in the system In this example there are 3.</p> <pre> TROUBLE FSC[3] Press ▾ for status </pre> <p>Press the down arrow to view the type and location of trouble condition. (This message alternates with the date / time display.)</p> <p>CO = CO Detector Count of CO detectors in trouble on the system In this example there is 1.</p> <pre> TROUBLE COC[1] Press ▾ for status </pre> <p>Press the down arrow to view the type and location of trouble condition. (This message alternates with the date / time display.)</p>	<p>Device type</p> <pre> TROUBLE: CO Smoke SBUS_33 Sensor_2 [Z001] [M33:S002] Missing 5 of 8 </pre> <p>Type of trouble. In this example, the panel does not see a detector that should be on the loop. Zone # Module and Point name Shows which event is currently being displayed. In this example there are 8 trouble,5 is being displayed</p> <p>Press SILENCE and enter an access code (or activate the key) to silence the annunciator.</p> <p>Once the trouble condition has been fixed, the system will restore itself automatically. After sitting idle, events will display in a screen similar to this:</p>
	<p>Trouble condition with the EVS system.</p>	<pre> TROUBLE EVS [1] <Press ▾ for status> </pre>	<p>Blinks between time/date & Mod/Amp</p> <pre> TROUBLE SBUS COMMUNICATION [M03] 1 of 7 FS: I EVS: CO: </pre> <p>Alarm Supr TRB Alarm Supr TRB Alarm Supr TRB</p>

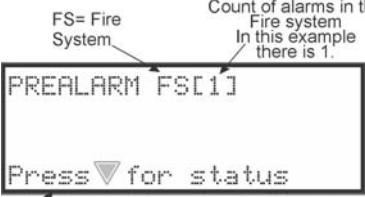
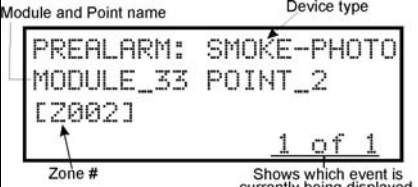
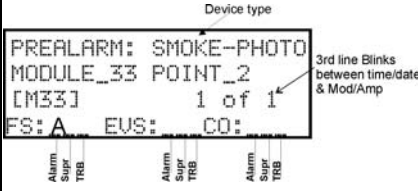
Operation Mode	Occurs When	System Behavior	In This Mode You Can
<p>Prealarm</p>	<p>A single detector trips in a 2-Count zone. (2- Count means two detectors must trip before an alarm is reported.)</p>	<p>Touchpad PZT beeps. The LCD displays a screen similar to this one.</p> 	<p>Press down arrow to view the prealarm. A screen similar to this one displays.</p>  <p>All system operations are available in this mode. After sitting idle, evens will display on a screen similar to this:</p> 
<p>Reset (Fire Alarm Only)</p>	<p>The RESET button is pressed followed by a valid code or rotation of the key</p>	<p>All LEDs are on briefly then the LCD displays "RESET IN PROGRESS". If the reset process completes normally, the date and time normal mode screen displays.</p>	<p>Menus are not available during the reset process.</p>
<p>Reset (EVS and Fire)</p>	<p>The RESET button is pressed.</p>	<p>All LEDs are on briefly then the LCD displays "RESET IN PROGRESS". If the reset process completes normally, the date and time normal mode screen displays.</p>	<p>Menus are not available during the reset process.</p>
<p>Silenced (EVS and Fire)</p>	<p>An alarm or trouble condition has been silenced but still exists. To silence alarms and troubles, press SILENCE followed by the Installer or User Code or rotate the key.</p>	<p>SYSTEM SILENCE LED is on. SYSTEM TROUBLE, SUPERVISORY or GENERAL ALARM LED (depending on condition) is on. The annunciator (and any notification devices attached to the system) will be silenced.</p>	<p>Press down arrow to view the location of the alarm or trouble. When the condition no longer exists, the SYSTEM SILENCED and SYSTEM TROUBLE LED, SUPERVISORY or GENERAL ALARM LEDs turn off.</p>

8.7 Releasing Operations

The control panel supports two types of releasing, Double Interlock Zone, and Single Interlock Zone. The Double Interlock Zone operation requires an interlock switch input in the system, and the Single Interlock zone does not. An interlock switch is typically a dry-contact pressure switch.

When Single or Double Interlock Zone releasing is selected, the system will automatically default the following system parameters:

Note: The defaults created can be modified through programming if desired.

- Output Group 2 is created. Output Group 2 will be defaulted as an "Alarm" output group for all releasing zones. NAC [34:001] is assigned to Output Group 2.
- Output Group 3 is created. Output Group 3 will be defaulted as an "Pre-Alarm" output group for all releasing zones. NAC [34:002] is assigned to Output Group 3.
- Output Group 4 is created. Output Group 4 will be defaulted as a "Release" output group for all releasing zones. NAC circuit [34:003] is assigned to Output Group 4.

Note: The installer must define which input points will be used for detectors, manual release switches, or interlock/pressure switches.

Table 8-1: Approved Releasing Solenoids

Manufacturer	Part Number	Rating	Current	Freq
Asco	T8210A107	24 VDC	3A max	0 Hz
	8210G207	24 VDC	3A max	0 Hz

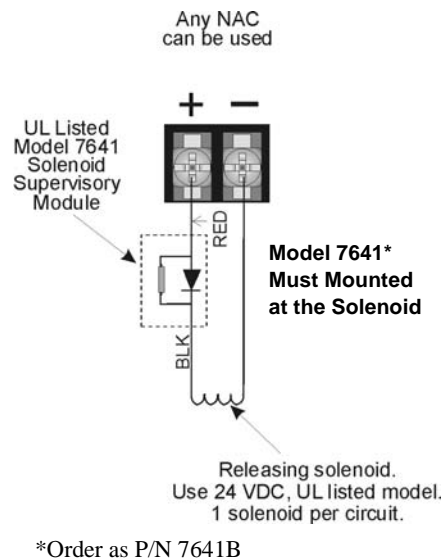

Figure 8-5 Wiring Configuration for Solenoid

Do not mix cross alarming zones with smoke verification zones. There must be at least two automatic detection devices in each protected space. Spacing must be reduced to 0.7 times the linear spacing in accordance with NFPA 72. See Section 7.3 for zone option programming.

8.7.1 Single Interlock Zone Releasing

A single interlock zone utilizes a minimum of two addressable detectors and a designated manual release switch.

Important!
Only addressable detectors can be used. No conventional detectors can be used.
Each Single Interlock Zone input requires at least one manual release switch.

Conditions Required for an Pre-Alarm Output Activation

If any single addressable detector is activated, the “Pre-Alarm” output will activate. This alerts the user that the initial stages required for a release condition are present. (Also refer to Table 8-2.)

Conditions required for an General Alarm and Release Output Activation

If two or more addressable detectors, or a manual release switch activate, the “Alarm” and the “Release” outputs will activate and the “Pre-Alarm” output will deactivate. (Also refer to Table 8-2.)

Table 8-2: Single Interlock Zone Operation

Inputs	Output Results							
1st Addressable Detector		x		x		x		x
2nd Addressable Detector			x	x			x	x
Manual Release Station					x	x	x	x
	Normal	Pre-Alarm	Pre-Alarm	Release and General Alarm	Release and General Alarm	Release and General Alarm	Release and General Alarm	Release and General Alarm

8.7.2 Double Interlock Zone Releasing

A Double Interlock Zone uses a minimum of two addressable detectors, a designated manual release switch, and an interlock switch input. An interlock switch is typically a dry-contact pressure switch and will be referred to as an interlock/pressure switch in this document.

Important!
Only addressable detectors can be used. No conventional detectors can be used.
Each Single Interlock Zone input requires at least one manual release switch.
Each Double Interlock Zone input requires at least one Interlock/pressure switch

Conditions Required for a Pre-Alarm Output Activation

If any single addressable detector is activated, the “Pre-Alarm” output will activate. This alerts the user that the initial stages required for a release condition are present. (Also refer to Table 8-2.)

Conditions Required for a General Alarm Output Activation

If two addressable detectors, a manual release switch is activated, or an interlock switch is active, the “Pre-Alarm”, and “General Alarm” outputs will activate.

Conditions Required for a Release Output Activation

Any release requires the activation of an interlock switch, and either a manual release switch or 2 activated addressable detectors. When these conditions are met, the “Release” and “General Alarm” outputs will activate, and the “Pre-Alarm” output will deactivate.

Table 8-3: Double Interlock Zone Operation

Inputs	Output Results														
1st Addressable Detector	x		x		x		x		x		x		x		x
2nd Addressable Detector		x	x			x	x			x	x			x	x
Manual Release Station				x	x	x	x					x	x	x	x
Interlock/Pressure Switch								x	x	x	x	x	x	x	x
Normal															
Pre-Alarm															
Pre-Alarm															
Pre-Alarm and General Alarm															
Pre-Alarm and General Alarm															
Pre-Alarm and General Alarm															
Pre-Alarm and General Alarm															
Pre-Alarm and General Alarm															
Pre-Alarm and General Alarm															
Pre-Alarm and General Alarm															
Pre-Alarm and General Alarm															
Pre-Alarm and General Alarm															
Release and General Alarm															
Release and General Alarm															
Release and General Alarm															
Release and General Alarm															
Release and General Alarm															

8.8 Smoke Alarm Verification

Figure 8-6 illustrates how the Smoke Alarm Verification cycle operates.

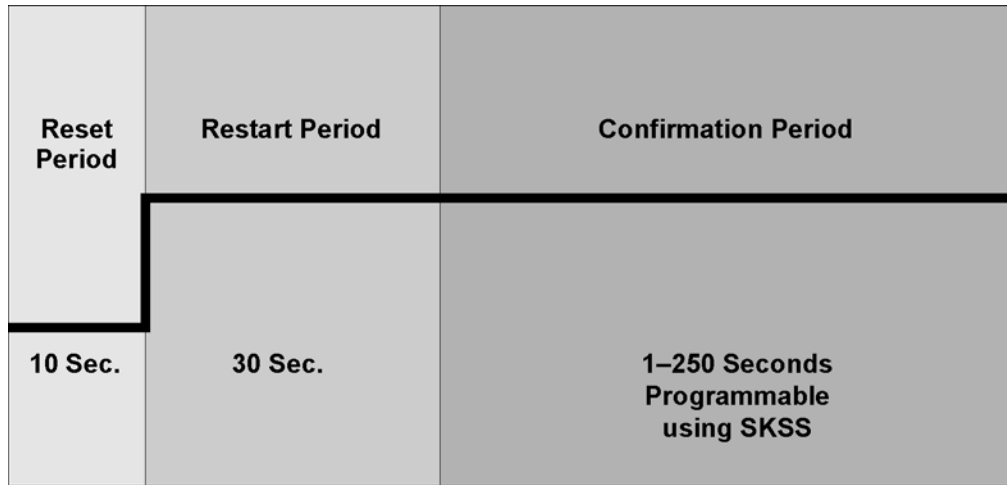

Figure 8-6 Smoke Verification Cycle

During the Confirmation Period if there is no alarm indication then the system will return to normal operation.

Section 9

Emergency Voice System Operation

9.1 Overview

The EVS series control panels and accessories provide features to meet the requirements for Mass Notification Systems as described in NFPA 72 and is compliant with the UL 2572 standard. These features are enabled through a programming option in the fire alarm control panel. EVS (Emergency Voice System) is integrated with the fire alarm and voice evacuation functions of the control panel.

Note: EVS installations are not FM approved.

To start this process, the user gains EVS control. This tells the system that a user is going to be making changes to the EVS; either by activating an EVS event, doing an EVS live page, or resetting EVS. Only one EVS device/user can have EVS control at any given time and there are rules that will be explained that govern when a device/user is able to gain control or pass control. Interface keypads are associated with the EVS-VCM or EVS-RVM that are installed together, will provide feedback as to the system's current state or why a user's request for changing the EVS might have been denied.

There are two ways for activating EVS in the 5820XL-EVS panel:

EVS Point Activations

EVS Point Activation involves using pre-determined EVS Alarm input points to activate EVS Alarm events. These events cause output areas to activate based on mapping that is programmed into the system at installation. This is very similar to the traditional mapping that the fire system has utilized to date.

Manual LOC Activations

Manual LOC Activation involves using the LOC EVS interface to activate EVS Events, choose output areas, and speak through a microphone. These selections are not pre-determined and allow the user to make system functionality decisions when the event is actually happening. This requires the activation of Manual EVS State which bypasses EVS Point Activations. See section 9.2.3.

9.2 LOC Functionality

An LOC consists of either the EVS Series panel (EVS-VCM Voice Control Module and the Fire Alarm Control Panel), or the EVS-RCU Remote Command Unit (EVS-RVM Remote Voice Module and its associated 5860 keypad). An LOC is created by adding a VCM or RVM to the system and associating a keypad to it. The LOC provides eight buttons for activating the EVS messages, a button to gain and relinquish EVS Control, and a microphone for live EVS paging. There can be up to five LOC devices in the system.

9.2.1 Keys and LEDs

This section outlines the functionality of the keys and LEDs on the EVS-VCM and EVS-RVM expander modules.

9.2.1.1 EVS Control Key

Pressing the EVS Control Key will do one of two things:

1. Enter Message Mode of the LOC EVS interface (including trying to gain EVSEVS Control if the user doesn't have it already).
2. Relinquish EVS Control if pressed while in Message Mode.

9.2.1.2 EVS Control LED

The EVS Control LED is used to indicate the status of EVS Control in the system. When the LED is on solid, the LOC has EVS Control within the system. When the LED is blinking, another LOC has gained EVS Control in the system.

9.2.1.3 ALL CALL Key

Used to deliver your verbal message to all voice groups.

1. Key the microphone, press the All Call Key, wait for the Ready-to-Talk LED to light, and then deliver your verbal message.

9.2.1.4 NON-ACTIVE CALL Key

Used to deliver your verbal message to all non-activated output groups.

1. Key the microphone, press the Non-Active Call Key, wait for the Ready-to-Talk LED to light, and then deliver your verbal message.

9.2.1.5 EVS Message Keys

EVS Message Keys are used in Message Mode to select which EVS Message is to be played. If pressed when the LOC does not have EVS Control, the system will automatically try to gain EVS Control before allowing the EVS Event to be activated. See section 9.2.2.

9.2.1.6 EVS Message LEDs

The red EVS Message LEDs indicate the active EVS Message and any previously active EVS messages. The green LEDs indicate the EVS Message was selected in message mode and that the LOC has EVS control.

1. For EVS Point Activation, the red EVS Message LEDs will illuminate on each LOC to indicate which EVS messages have been activated in automatic EVS state.
2. In Manual EVS State, the red EVS Message LEDs will indicate which EVS message has been activated at an LOC. See section 9.2.3.
3. The green EVS Message LEDs will activate for the LOC that activated the EVS Message.

9.2.1.7 Select Keys

The Select Keys are used to toggle which output areas are active.

1. If Message Mode is active (see Section 9.2.3), the Select Keys will toggle which areas the active message is distributed to (also toggles the red Select Key LED).
2. If Microphone Mode is active (see Section 9.2.3), the Select Keys will toggle which areas the microphone audio is distributed to (also toggles the green Select Key LED).

9.2.1.8 Select Key LEDs

The Select Key LEDs are used to indicate which output areas are active for a microphone page (see Section 9.9.5) or system events.

1. Green LEDs: active areas for microphone paging.

Note: These are only active when the microphone PTT is engaged.

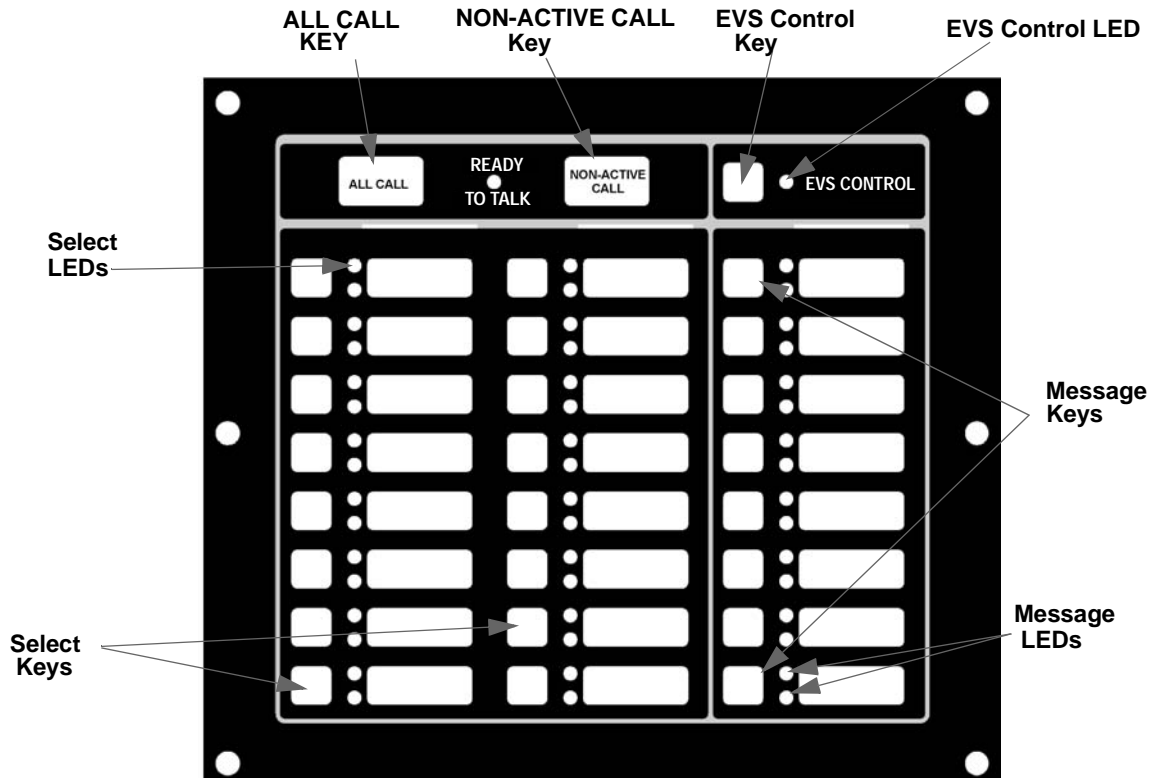

Figure 9-1 EVS Front View

9.2.2 Gaining EVS Control

When attempting to gain EVS Control, there are three things that govern whether or not EVS Control can be obtained:

1. LOC Priority.
2. LOC Lockout.
3. User profile access control.

9.2.2.1 LOC Priority

LOCs are assigned (through panel or SKSS programming of the EVS-VCM or EVS-RVM) an LOC priority of low, normal, or high. LOCs with a higher priority are always able to gain control from a lower priority LOC.

9.2.2.2 LOC Lockout

When LOCs are programmed to the same priority, the setting LOC lockout applies. LOC lockout will not allow an LOC to gain EVS Control from the LOC with EVS Control until one of three things happen:

1. The LOC lockout timer expires. Once the LOC lockout timer expires, an attempt to gain EVS Control can be made again.

Note: The lockout timer must be programmed to expire sometime other than Never.

2. The user at the second LOC requests EVS Control from the LOC with EVS Control and that LOC grants the request. (See Section 9.2.7). If the EVS lockout timer expires while an EVS Control request is in progress, the system will automatically pass EVS Control to the requesting LOC.
3. The user at the second LOC enters an access code with the EVS Super User profile option.

The LOC lockout timer can be set between immediate and 12 hours in increments of 1 second or it can be set to never expire. The default setting is 30 seconds. The LOC lockout timer is restarted upon any key press at the LOC with EVS control. The LOC lockout timer is cleared when EVS Control is relinquished.

9.2.2.3 User Profile Access Control

The user will need to enter an access code containing the EVS Control Request or EVS Super User profile option to gain EVS Control. EVS Control Request and EVS Super User profile options will be mutually exclusive to the system. If the access code has EVS Super User, the EVS Control Request is ignored and activations by that user are always as EVS Super User.

9.2.3 Manual EVS

After gaining EVS Control the system enters the LOC EVS interface which allows you to activate the Emergency System and allows for Emergency Paging. Once an emergency event has been activated the panel enters a Manual EVS State. In this state, all EVS Alarm programmed points that are currently in alarm in the system are changed to an active state. The display status screen reflects this when viewing the system for status. Any outputs that were activated by the EVS Alarm programmed points are deactivated until Manual EVS state is exited. Only an EVS Reset can exit the Manual EVS State. If a user gains EVS Control at an LOC and does not activate an EVS message, the system will automatically generate an EVS Supervisory indicating such. This prevents an LOC from being in an undesired state of EVS Control when an actual event emerges.

There are two modes for interacting with the LOC EVS interface when in Manual EVS State:

1. Message Mode
2. Microphone Mode

These two modes allow you to quickly toggle areas of output for a desired message and toggle output areas to speak to for microphone EVS Paging.

After gaining EVS Control, the system is in Message Mode of the Manual EVS State.

9.2.3.1 Switching between Microphone Mode and Message Mode

At any time while in EVS Control, you can switch between Microphone Mode and Message Mode. Microphone Mode is entered by simply engaging the microphone.

1. Message Mode: Use the EVS Message keys to select which message/event to output to the system. Use the Select Keys to toggle output areas to play the current EVS Message in. The Select Key's red LED will toggle on/off with the activation/deactivation of the EVS Message to the area. Any non-voice groups assigned to this Select Key will also toggle on/off with their Activation Cadence. See Section 9.2.3.2.
2. Microphone Mode: Use the Select Keys while the microphone is active to toggle which areas to do an EVS Microphone Page to. The Select Key's green LED will toggle on/off with the activation/deactivation of the EVS Microphone Page to the area.

9.2.3.2 Activating/Deactivating Output Groups Dynamically

This method allows the system to be setup with minimal or no system mapping. When in Manual EVS State and operating in Message Mode the user can dynamically activate/deactivate output areas for system notification to take place in. The Select Key red LED will become lit and the circuits in the output group(s) will become active and play the currently active EVS event message when activated. When deactivated, the Select Key red LED will become unlit and the circuits in the output group(s) will become inactive. Non-voice output groups can also be assigned to Select Keys and will toggle on/off using the activation cadence assigned to it in output group programming. This is available in the panel and in SKSS. See Section 7.4.1.2.

9.2.4 Microphone Mode

Microphone Mode allows the user to press the Select Keys to toggle which output areas to speak to over the

microphone. The green LEDs next to the Select Keys will activate or deactivate.

9.2.5 Message Mode

In Message Mode, the user is able to press the EVS Message Keys to choose a message and press the Select Keys to activate or deactivate which output areas the message will be played. This will activate or deactivate the green and red LEDs next to the EVS Message Keys and the red LEDs next to the Select Keys.

9.2.6 Custom EVS Event

Custom EVS events allows the user to generate an EVS event and speak a custom message using the microphone. Once the user is done speaking the message, the tone and any associated strobes will continue to be active in the output areas.

To generate a Custom EVS Event:

1. Gain EVS Control using the EVS Control Key when there is not an active Manual EVS State Event.
2. Activate the microphone.
3. Choose desired output areas using the Select Keys.
4. Speak custom message into microphone.

9.2.7 Passing EVS Control

Passing of EVS Control is allowed when two LOCs have the same priority. When it is possible to pass control, a prompt (similar to Figure 9-2) will display in which the user can: request control from the LOC with EVS Control, enter an access code with the EVS Super User profile option to override the other LOC, or wait for the lockout timer to expire (if applicable).

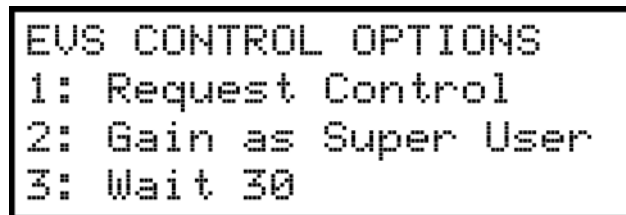

```
EVS CONTROL OPTIONS
1: Request Control
2: Gain as Super User
3: Wait 30
```

Figure 9-2 Request EVS Control with Lockout Timer Active

EVS Control lockout is programmable from immediate to 12 hours in increments of one second. You are also able to select never expire.

When passing EVS Control between two EVS Super Users, the user is not shown the prompt screen. Instead, a request for EVS Control is automatically made. Additionally, the lockout timer does not apply for EVS Super User.

When a request for EVS Control is made, the LOC with EVS Control will be shown a screen indicating that another LOC is requesting EVS Control.

Once EVS Control is passed to another LOC, the new user will assume the system AS IS. This means that the event that was set to be playing at the previous LOC and all output areas it was playing in do not change.

9.2.8 Exit EVS Control Menu

The user can exit the LOC EVS interface by pressing the ◀. The user will be returned to the idle screen.

9.2.9 Relinquish EVS Control

Relinquishing EVS Control is accomplished by pressing the EVS Control Key from within Message Mode. A screen will be displayed to ensure the user wants to relinquish EVS Control. EVS Control will be automatically

relinquished after a time-out on this screen. When EVS Control is relinquished, the system stays in the Manual EVS State. EVS Control can then be gained by another LOC or again at the same LOC.

9.2.10 EVS Reset

An EVS reset is accomplished by pressing the RESET button from an LOC. The user will be prompted to reset either the fire system or emergency system. After an EVS reset, the LOC will automatically exit the LOC EVS interface.

Note: In order to perform an EVS reset, the display must be associated with the EVS-VCM / EVS-RVM. See Section 9.6.2.2.

9.2.11 Access Control

By default, the fire fighter key user profile includes the EVS control request option. This is a programmable option for all user profiles. If the fire fighter key user profile is not specified to have the EVS control request option, upon EVS control request, the system will immediately display the “Enter Pin” dialog on the annunciator and the user will be required to enter the access code for a profile that does.

The second user profile option for the Emergency Voice System is the EVS Super User option. (See section 9.5). If a user at an LOC does something that requires EVS control or they are at the EVS status screen, if they enter the EVS Super User pin and there isn't another EVS Super User already logged in, they will gain EVS Super User status.

9.3 EVS Super User

The EVS Super User access code profile function provides the ability to override all EVS Control rules and gain EVS Control. The EVS Super User is the highest priority user in the system. The EVS Super User has several features that differ from the normal user:

1. Any alarm activated while under EVS Super User Control needs to be reset using an EVS Super User function enabled access code.
2. LOC priority and LOC lockout timer are ignored when passing EVS Control between EVS Super Users at LOCs. If another EVS Super User attempts to gain EVS Control from an LOC, an EVS Control request is presented to the EVS Super User at the LOC that currently has EVS Control.

Note: Only one EVS Super User is allowed EVS control in the system at a time.

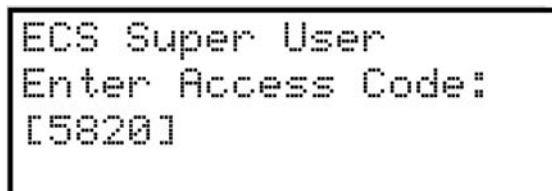

Figure 9-3 EVS Super User Window

9.4 EVS Point Functionality

Any EVS 5880 (5880 LED/Contact module with the EVS Trigger option enabled) can be used for EVS inputs. The Point EVS 1-8 Alarm input types can be used to trigger predetermined EVS events for output areas. EVS-VCM and EVS-RVM points can be programmed to trigger Voice Aux events that can allow external audio to be played through the emergency system.

9.4.1 EVS Point Activations

EVS points can only activate outputs and be placed into an alarm state if the system is not in Manual EVS State. EVS points have no priority and all are allowed to be activated. If the EVS point is a higher priority than the Fire

System, then the system will play the highest event message through all EVS mapped outputs.

For example: Emergency 1 Point Alarm is higher priority than Emergency 2 Point Alarm. Emergency 1 Point Alarm has message 1 mapped to through groups 1 and 2. Emergency 2 Point Alarm has message 2 playing through groups 2 and 3. If a point for Emergency 1 Point Alarm and a point for Emergency 2 Point Alarm are both active, the system will play message 1 through groups 1, 2, and 3.

Once Manual EVS State is active, points in Alarm state switch to an Active state. When the points are changed to the Active state, they do not activate any system mapping or turn any outputs on. Any points that are activated while in Manual EVS are also placed into the Active state and are not allowed to activate any mapping. The system idle screen will show an EVS Alarm counter for any points in the Active state, and the detailed description of the point will show the point as Active.

After an EVS Reset, any EVS points that are still active will again be put into Alarm.

9.4.2 EVS-VCM Points

The EVS-VCM and EVS-RVM modules contain two programmable input points. These also have the ability to be programmed as a trigger for bringing external audio into the system. These special point types are: Voice Aux EVS and Voice Aux Status. When activated, if the event has the highest Event Priority of all activated events, these points will activate the Aux In input to all outputs defined by the respective event program mapping.

9.5 EVS 5880

9.5.1 EVS (1-8) 5880 Module

An EVS 5880 is a 5880 LED/Contact module with the EVS Trigger option enabled. When this option is enabled, input points 41 through 48 on the 5880 are automatically assigned to EVS 1-8 functions respectively. See Section 9.4.1 for further information on EVS point activations. The dry-contacts can be setup as latching or non-latching and silenceable or non-silenceable in the 5880 module programming.

There can be eight EVS 5880s in the system.

Note: The system allows multiple EVS events be active at the same time. Only the highest priority event's message will play through the system.

9.5.2 Enable 5880 EVS

This option only applies to the 5880. Each module has a unique set of options that specifically applies to the functionality being edited.

1. Press ENTER on the Naming Module Screen (See section 7.2) to enter 5880 EVS setting and priority screen.
2. Screen will indicate:
 - EVS Device: Yes or No
 - EVS Latching: Yes or No
 - EVS Silenceable: Yes or No

9.6 EVS LOC Programming

Device Priority is a programmable option for each of the EVS devices:

- EVS-VCM
- EVS-RVM

Each device is assigned a Priority level: Low, Normal, or High.

9.6.1 Adding an LOC

To add new LOCs to the system, follow these steps:

1. Enter the installer code. The panel will automatically go to the main menu.
2. Select 7 for Panel Program Menu.
3. Press 1 to enter Module menu.
4. Press 2 to add a module.
5. From the next screen, add either an *EVS-VCM or **EVS-RVM.

*Note: * Only 1 EVS-VCM may be installed per site.*

*Note: ** Up to 5 EVS-RVMs may be installed per site.*

The screen will display “Adding module [#]...” for a few moments. You will be returned to the <New Module Type> screen where you can select a name for the module if desired.

6. Add a 5860 LCD Annunciator, if desired, to associate with each EVS-VCM or EVS-RVM

You must save changes when you exit the Program Menu or the new module(s) will not be added. For more information see section 7.2.2.

Note: If you Add a Module that has not been physically connected, the panel will go into trouble after it re-initializes (when you exit the Program Menu). When the new module is attached, the trouble will restore automatically the next time you power up the system.

9.6.2 Editing an LOC

When editing EVS LOCs, the features that may be edited are: module ID, module name, number of switch expanders installed, extended features, microphone type, microphone gain, auxiliary gain, tone gain, message gain, keypad priority, and associated keypad

To edit an existing module:

1. Enter the installer code.
2. Select 7 for Program Menu.
3. Press 1 to enter module menu.
4. Press 1 to edit a module.
5. Use the ▲ or ▼ arrow to select the module you wish to edit.
6. Press the ► or ENTER to move to next selection.

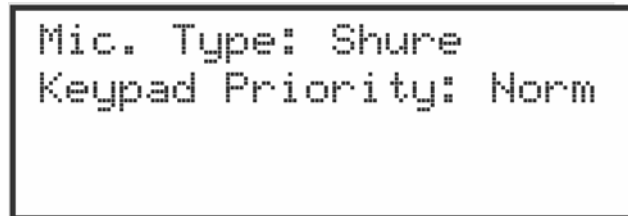

Figure 9-4 Edit Module Mic Type and Device Priority

9.6.2.1 LOC Priority

Each device is assigned a Priority level: Low, Normal, or High. This is modified by editing the LOC’s EVS-VCM or EVS-RVM module. By default, the EVS-VCM has a high LOC priority. The EVS-RVM is defaulted to normal LOC priority.

9.6.2.2 LOC Association

In order to create an LOC, an annunciator must be associated to an EVS-VCM or EVS-RVM. This is done by editing the EVS-VCM or EVS-RVM module and selecting the correct annunciator for the associated device.

During JumpStart, the EVS-VCM is automatically associated with the internal annunciator. The association for other LOCs in the system must be performed in programming.

9.7 Amplifier Programming

9.7.1 Adding an Amplifier

To add a new amplifier to the system, follow these steps:

1. Enter the installer code. The panel will automatically go to the main menu.
2. Select 7 for Program Menu.
3. Press 1 to enter Module menu.
4. Press 2 to add a module.
5. From the next screen, select desired amplifier.



The screen will display “Adding module [#]...” for a few moments. You will be returned to the <New Module Type> screen where you can select another module if desired.

You must save changes when you exit the Program Menu or the new module will not be added. For more information see section 7.2.2.

If you Add a Module that has not been physically connected, the panel will go into trouble after it re-initializes (when you exit the Program Menu). When the new module is attached, the trouble will restore automatically the next time you power up the system.

9.7.2 Editing an Amplifier

When editing amplifiers, the features that may be edited are (dependent upon amplifier model): module ID, module name, CE4 Exp installed (Yes or No), output voltage, and amp mode. To edit an existing module:

1. Enter the installer code. The panel will automatically go to the main menu.
2. Select 7 for Program Menu.
3. Press 1 to enter Module menu.
4. Press 1 to edit a module.
5. Use the  or  arrow to select the module you wish to edit.
6. Press the  or ENTER to move to the next selection.

9.8 Event Priority

This section goes over how event activations are handled by the control panel with regards to priority.

9.8.1 System Control

The 5820XL-EVS control panel integrates both a fire and emergency system into one. When events are active from both systems the control panel makes intelligent decisions to determine which system should be controlling outputs. This is called System Control. This manual will refer to the fire or emergency systems having System Control, this means that the system has an active alarm or supervisory event that has a higher event priority than an active alarm or supervisory event from the other system. For this consideration, the control panel looks at the highest priority event active on each system. When both systems are active, the system with control will activate System Override. System Override is activated on the lower priority, non-System Control panel system (fire or emergency system.)

9.8.2 System Override

System Override temporarily disengages output group activations from the system being overridden. This is done to not provide conflicting messages and signaling and help with reducing confusion of the building occupants.

When output groups are supposed to be active but are not because System Control has activated System Override, they are re-activated every 30 seconds for several seconds to indicate to the building occupants that there is still an event active. This will only occur when the system with System Control is not using the output group. The System Override option is programmable for non-voice output groups on a per output group basis through the panel output group programming menus and in SKSS. In these places the option is called Allow System Override and defaults to YES. It is also possible to not reactivate the output groups every 30 seconds when System Override is active on a per system basis. This option is programmable in SKSS.

There are times when you would not want to allow System Override for an output group. For example: fire is programmed to an elevator relay to bring the elevator to the bottom floor for fire only. If fire and EVS are active with EVS being the higher priority event, you still need the elevator to move to the bottom floor and only audible and visual notification appliances must be overridden. In this case, the output group assigned to the relay would be set to NO on the Allow System Override setting. See Section 7.4.1.2 to edit group properties.

9.8.3 EVS Event Priority

Each event type (see Table 9-2) has a priority level assigned to it. When more than one event type is active, the panel uses this priority to determine which is most important. One is the highest event priority. The panel will activate output groups according to the highest priority active event. These event priorities, with some restrictions, can be changed to allow EVS and fire events to interact. The lower priority event will be ignored until the higher priority event is reset. See section 7.10.3.2 to edit command priority.

Since the system has both fire alarm and EVS functions, a determination must be made as to which will be higher priority when both types of events occur. For each installation a risk assessment must be done to decide the priority of events.

9.8.4 View Active Alarms, Troubles and Supervisory Signals

When looking at the LCD display, the screen will display FS for the “Fire System” and EVS for “Emergency Voice System” after the condition. The highest priority event will display first. (See Figure 9-5). Press the down arrow to view location and type of alarm or trouble. After sitting idle for two minutes, events will display on line 4 of display. (See Figure 9-6).

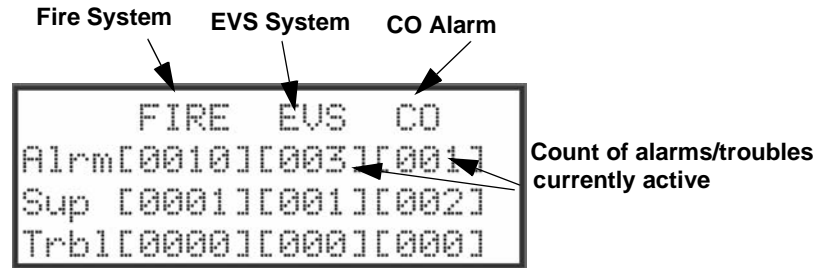

Figure 9-5 Highest Priority Event Display

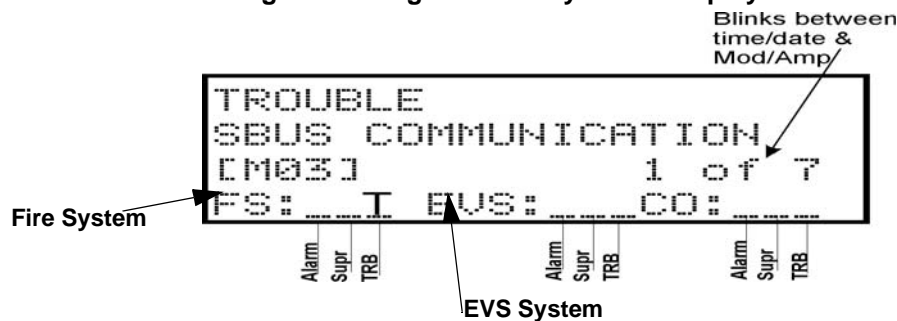

Figure 9-6 Event Screen After Two Minutes Sitting Idle

9.9 Using the Microphone

9.9.1 Microphone Functionality

Each microphone in the system is capable of providing live fire system or EVS paging.

The microphones are housed within the EVS-Series panel enclosure and the EVS-RCU cabinets. A maximum of 8 microphones can be installed in the system.

9.9.2 Custom EVS Event

This event is activated by gaining EVS control at an LOC and using the microphone without any EVS event already active. In this case, the custom EVS mapping and general EVS mapping will be activated and stay activated until a different EVS event is activated at the LOC or the user resets the Emergency Voice System.

9.9.3 Fire Page

A fire page can only occur when:

1. Only the fire alarm is active.
2. Both fire and EVS are active and the fire alarm is programmed to be of higher priority than the active EVS alarm.
 - If the fire alarm has the highest active priority and EVS is also active, any LOC can do a fire page given LOC device priority rules are followed. If the user is at the LOC with EVS Control, and the fire page is of higher priority than the EVS event, the LOC will automatically relinquish EVS Control to do the fire page when the user engages the microphone.
3. Only the fire alarm is active, the user has gained EVS Control and custom EVS event is a lower priority than the fire alarm.
 - In this case, if any LOC has EVS Control, the LOC will automatically relinquish control to allow for the fire page.
4. If both the fire alarm and EVS are active and the active EVS event is programmed for higher priority than fire alarm; the user must also have gained EVS control.
 - In this case a fire page is NOT allowed at all and the LOC must gain EVS control in order to do any live voice.

9.9.4 Emergency Page

An emergency page can occur when:

1. Only the emergency system is active and the user has gained EVS Control.
2. Only fire alarm is active, custom EVS is higher priority than fire alarm and the user has gained EVS Control.
 - This will trigger the EVS system and enable mapping for 'Custom EVS' and 'General EVS'.

9.9.5 Paging

If there are no active emergency or fire system events, the microphone at an LOC can be used for paging by following these steps:

1. Remove the microphone from its cradle.
2. Press the push-to-talk button on the microphone.
3. Use the Select Keys on the LOC to toggle the output areas to page to with the microphone (illuminates the green LEDs).

Note: The Ready to Talk LED will illuminate after an output area has been activated.

4. Speak into the microphone.
5. Release PTT button when finished. Page.

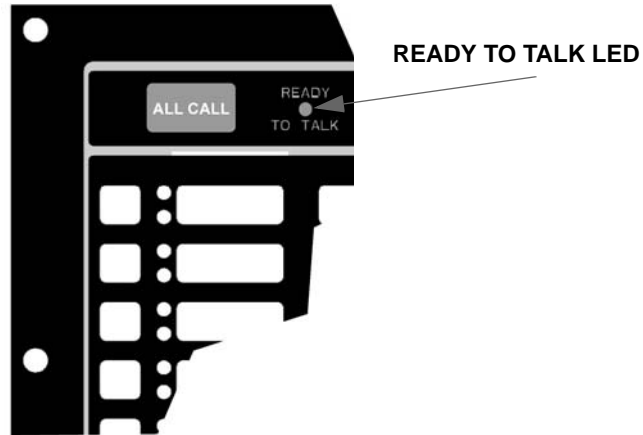

9.10 Recording Custom Messages

The EVS-Series controls come with 15 recordable message slots. (See <http://www.silentknight.com/products/Pages/5820XL-EVS-Voice-Files.aspx> for voice message downloads). Message 1-15 can be recorded from the microphone, Aux Input or by using the EVS Message Manager software. All messages can be a maximum of one minute.

When in the record mode the EVS-VCM switches will function as follows:

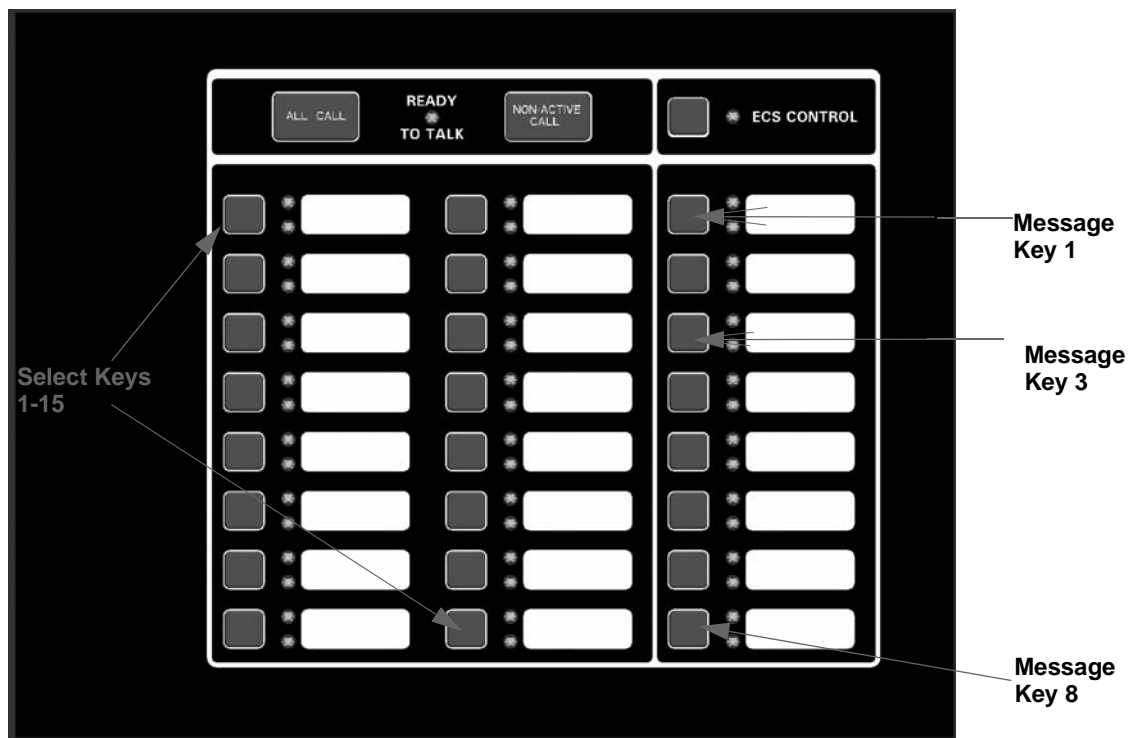

Key	Function
EVS Message Key 1	Select message slot to record to
EVS Message Key 3	Start and stop recording from Aux Audio Input
EVS Message Key 8	Erase user message 1-15
Select Keys 1-15	Message slot 1-15

While in the Local Record mode, select keys 1-15 will be used to reference message slots 1-15. The associated green Select Key will indicate that a message is currently programmed in the corresponding slot. When there is no message recorded (or the message is erased), the associated green Select Key LED will be off. While recording a particular message, the red Select Key will turn on until recording is completed. The Select Key 1-15 will be used to playback a recorded message or to select a message slot to record to or erase.

When in the Local Record mode, the EVS-VCM LEDs will function as follows:

Table 9-1: LED Functions During Programming

Switch LED	Active LED Status	Meaning
Select Key 1-15 Green LED	On	Message is currently programmed in this slot
Select Key 1-15 Red LED	On	Message recording is in progress
Select Key 1-15 Green/Red LED	Off/Off	Message slot is empty
Select Key 1-15 Red LED	Flashing	Message is being played back or message is selected for recording

9.10.1 Recording Messages 1-15 Using Aux Audio Input

Recording messages from the Aux Audio Input enables you to load customized, pre-recorded messages into an EVS message location.

Follow these steps to record user message using Aux Audio Input:

Note: Refer to the Section 7 for detailed programming information.

1. Wire a speaker cable with 1/8" mini plug (Radio Shack Cat. No. 42-2454) to the Aux AUDIO GND and IN terminals. Refer to Figure 9-7.

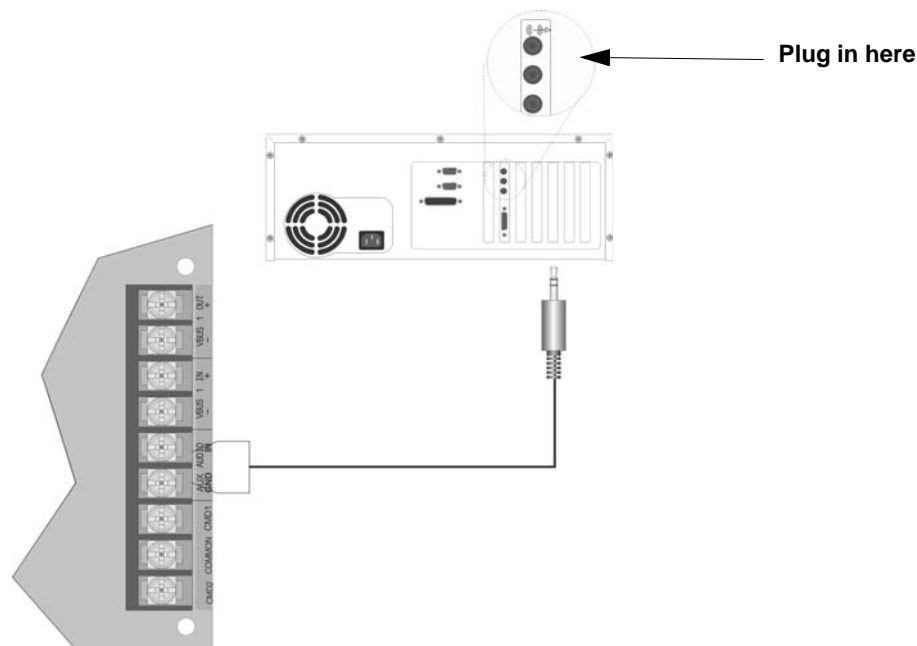

Figure 9-7 AUX Audio Connection for Recording

2. Plug the mini plug into the Line Out/Headphone jack on a PC or laptop. See Figure 9-7.
3. Enter programming mode at main control panel.
4. Select option 9 Voice Options.
5. Select option 1 VCM Maintenance.

6. Select option 2 Local Recording.

Note: The VCM will light the green Select Key LED for message slots that are occupied. If a message is already stored in the desired slot, then you must erase the message first. (see 9.10.3).

7. Select the amplifier and circuit for the audio to play through during programming. A user would generally pick the audio circuit that is in closest proximity to them.
8. Press EVS Message Key 1 to enter the message slot selection mode. Then, press the Select Key 1-15 that corresponds to the message slot that you wish to record to. The associated Select Key red LED will begin flashing, indicating that the message slot is ready for recording.
9. Simultaneously press EVS Message Key 3 and start playing the audio source on the PC or laptop.
10. When the audio file from the PC is finished playing, press EVS Message Key 3 again to stop the recording. The Select Key green LED will come on.
11. To playback the recorded message, press the Select Key 1-15 that was just recorded to.

Recording with Aux Audio Input Example:

The user wants to record into memory slot 2 via the Aux Audio Input channel.

Upon entering the Local Recording mode via the keypad menu, the VCM will light the Select Key green LEDs 1-15 for each occupied message slot.

If a message already exists in message slot 2, it must first be erased. Press EVS Message Key 8, then press Select Key 2, (see Section 9.10.3). When the message has been erased Select Key 2's green LED will turn off.

To record a message, press EVS Message Key 1, then press Select Key 2 (this will use message slot 2 for the recording). Select Key 2's red LED will begin flashing.

Press EVS Message Key 3 while simultaneously pressing play on the PC to start recording the Aux Audio Input. When the PC message is done, press EVS Message Key 3 to stop recording. Select Key 2's red LED will stay on until processing is completed. Select Key 2's green LED comes on after the recording is completed.

Pressing Select Key 2 will start a playback of the recorded message.

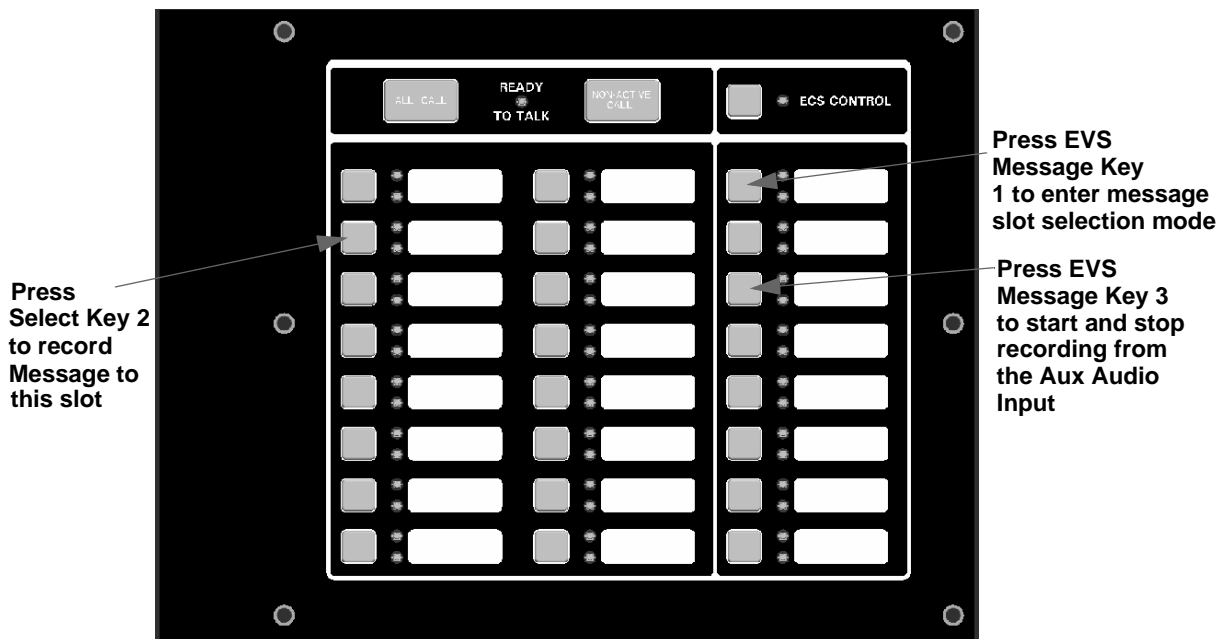

Figure 9-8 Aux Audio Input Example

9.10.2 Recording Messages 1-15 Using the Microphone

Messages can be recorded into the EVS system by using the on board microphone.

Follow these steps to use the microphone to record your message:

1. Enter programming mode at main control panel.
2. Select option 9 Voice Options.
3. Select option 2 Local Recording.

Note: The VCM will light the green Select Key LED for message slots that are occupied. If a message is already stored in the desired slot, then you must erase the message first. (see Section 9.10.3).

4. Select the amplifier and circuit for the audio to play through during programming. A user would generally pick the audio circuit that is in closest proximity to them.
5. Press EVS Message Key 1 to enter the message slot selection mode. Then, press the Select Key 1-15 that corresponds to the message slot that you wish to record to. The associated Select Key red LED will begin flashing, indicating that the message slot is ready for recording.
6. Press the push-to-talk (PTT) button on the microphone and speak your message.
7. Release the PTT button on the microphone to save your message. The Select Key green LED for this location will turn on.
8. To playback the recorded message, press the Select Key 1-15 that was just recorded to.
9. If you are not satisfied with the recorded message, erase it (see Section 9.10.3) and then repeat steps 1 through 7.

Recording with Microphone Example:

User wants to record a message to message slot 5 via the microphone.

Upon entering the Local Recording mode via the keypad menu, the VCM will light the Select Key green LEDs for 1-15 for each occupied message slot.

If a message already exists in message slot 5, it must first be erased. Press EVS Message key 8, then press Select Key 5, (see Section 11.8.3). When the message has been erased Select Key 5's green LED will turn off.

To record a message, press EVS Message Key 1, press Select Key 5 (this will use message slot 5 for the recording). Select Key 5's red LED will begin flashing.

Press the push-to-talk button on the microphone and speak your message. Release the PTT button to save your message. Select Key 5's red LED stays on until processing is completed. Select Key 5's green LED comes on after the recording is completed.

Pressing Select Key 5 will start a playback of the recorded message.

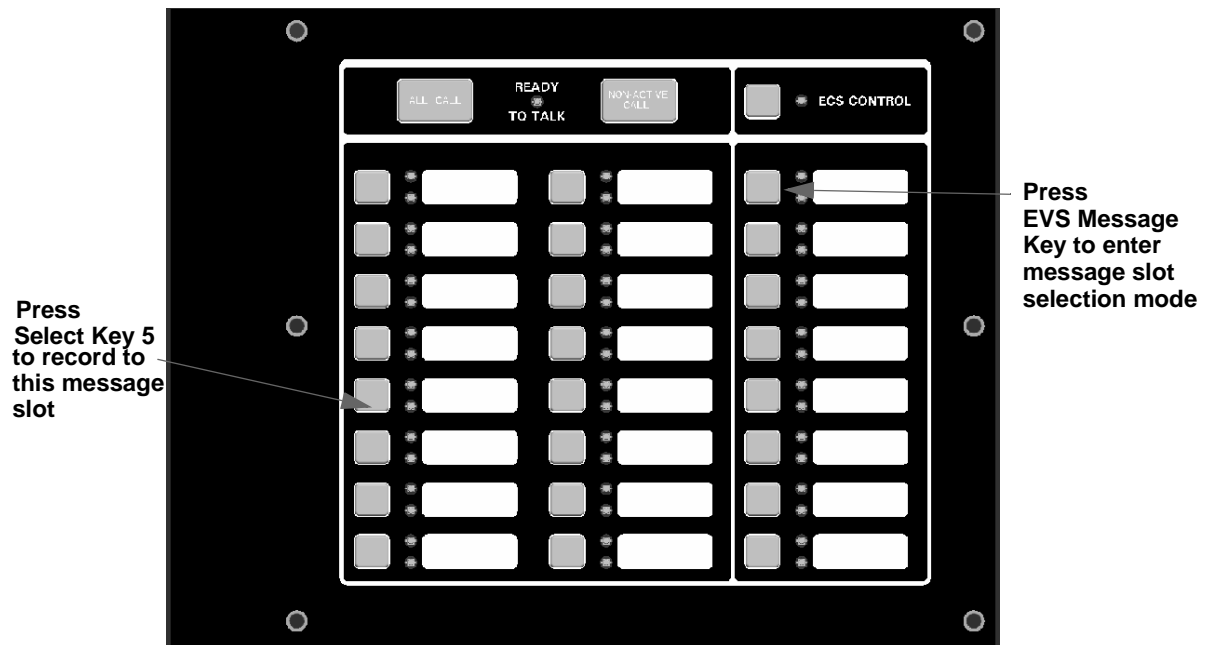

Figure 9-9 Recording with Microphone Example

9.10.3 Erasing User Message

To erase the message stored in switch 1-15 memory location follow these steps:

1. Enter programming mode at main control panel.
2. Select option 9 Voice Options.
3. Select option 1 VCM Maintenance.
4. Select option 2 Local Recording. Once in this mode, the VCM/RVM will light all the green LEDs for switches 1-15 indicating which message slots are occupied.
5. Select the amplifier and circuit for the audio to play through during programming. A user would generally pick the audio circuit that is in closest proximity to them
6. Press EVS Message Key 8 on the EVS-VCM, press the Select Key 1-15 that you wish to erase. The Select Key red LED will stay on until the erase is done. When erased, the Select Key green LED by corresponding to the message slot you erased will go off.

9.10.4 Using EVS Message Manager Software

The EVS Message Manager software is a software support utility that is used to download recorded messages (in .SKE1 format stored on your PC hard drive) to the various message locations of the EVS-Series controls. Messages can be uploaded from the EVS-Series control, stored, and used again in similar installations. The EVS Message Manger software can also be used to move messages to different message locations. For example, move message 1 to message 3 memory location.

To read/write .SKE1 formatted messages to and from the main panel, follow these steps:

1. Make sure that panel is in Normal mode.
2. Connect the PC to the panel using a standard USB cable. See Figure 9-10.

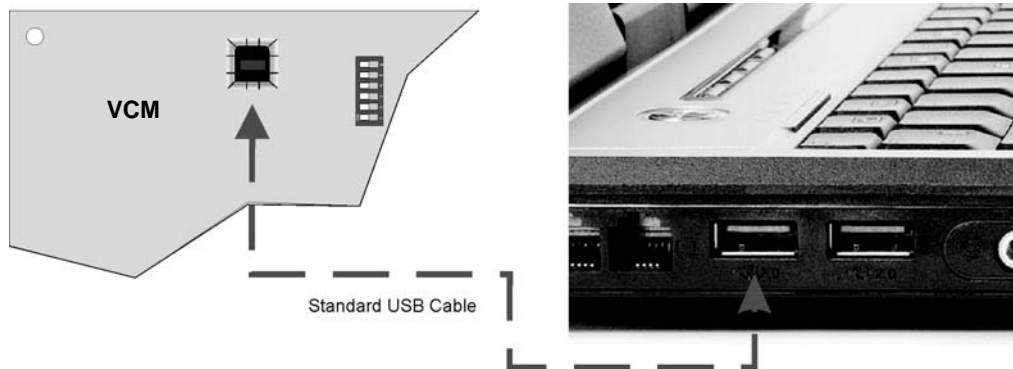

Figure 9-10 USB Cable Connections

3. Run the EVS Message Manager software.
4. Select “Read from Panel” to read a message and store onto your hard drive, or “Write to Panel” to transfer a .SKE1 formatted message to the panel.
5. Select the appropriate message location you wish to read/write.
6. Enter the file name you wish to transfer (Press “Browse” to display a list of files.)
7. Press “Start” to start the transfer.

9.11 EVS Priority

EVS command priority table will contain the following voice events:

Table 9-2: EVS Priority Table

Fire Alarm
Fire Aux 1
Fire Aux 2
CO Alarm
EVS LOC Activations
EVS 1 PT Activation
EVS 2 PT Activation
EVS 3 PT Activation
EVS 4 PT Activation
EVS 5 PT Activation
EVS 6 PT Activation
EVS 7 PT Activation
EVS 8 PT Activation
Emerg Voice Aux 1
Emerg Voice Aux 2
Emerg Voice Aux 3
Emerg Voice Aux 4
Emerg Voice Aux 5

9.11.1 Priority Rules

1. Fire Alarm priority contains zoned manual pull, waterflow, and detector as well as fire drill events.
2. Fire Aux 1-2 priorities contain both zone and system Fire Aux 1-2 events. Additionally, Fire Aux 2 includes zone interlock release.
3. EVS LOC Activations is always higher than all other EVS events.
4. EVS events do not need to be in order by EVS number.
5. General Emergency Comm will always be lower priority than the lowest of all Emergency Communication events.
6. Zone Fire Pre-Alarm and Interlock Alert events will be lower priority than the lowest of all alarms
7. Fire, CO, and Emergency Supervisories will be added in the same order as the corresponding system's alarms at a lower priority than Fire Pre-Alarm and Interlock Alert.
8. Troubles will always follow supervisories in the priority list.
9. Voice Aux Status will be always follow troubles in the priority list.
10. Microphone Engaged, Zoned Status Point, Alarm Silenced, and Trouble Silenced will always follow Voice Aux Status in the priority list.
 - In addition to the standard setting for voice events, the EVS and Voice Aux In events will have a 20 character event text associated with it. This will be displayed on display status and in the EVS Control menu.
 - Any of the 15 messages are selectable for each standard event.

Note: For instructions to enable EVS system see Section 7.10.3.1.

9.12 Defining Output Group Type

Each output group is defined as either a voice output group or a non-voice output group. Output points that are audio circuits (all circuits on the EVS-50W, EVS-125W, EVS-100W, EVS-INT50W and EVS-CE4) can only be assigned to voice output groups. Output points that are non-voice circuits (all other points and circuits that are on all modules except the EVS-50W, EVS-125W, EVS-100W, EVS-INT50W and EVS-CE4) are assigned to non-voice output groups.

Each of the output groups defined as voice can be mapped to a particular switch and LED on the EVS-VCM, EVS-RVM and EVS-SW24. This allows the user to see the state of the voice groups assigned to the switches. This also lets the user individually select which areas they want to do a live page into.

Output groups not defined as voice groups can also be assigned to these switches as long as there is a voice group already assigned to the group. This allows for dynamically activating/deactivating both voice and strobes/other outputs in an area with a single button press. See section 9.2.3.2.

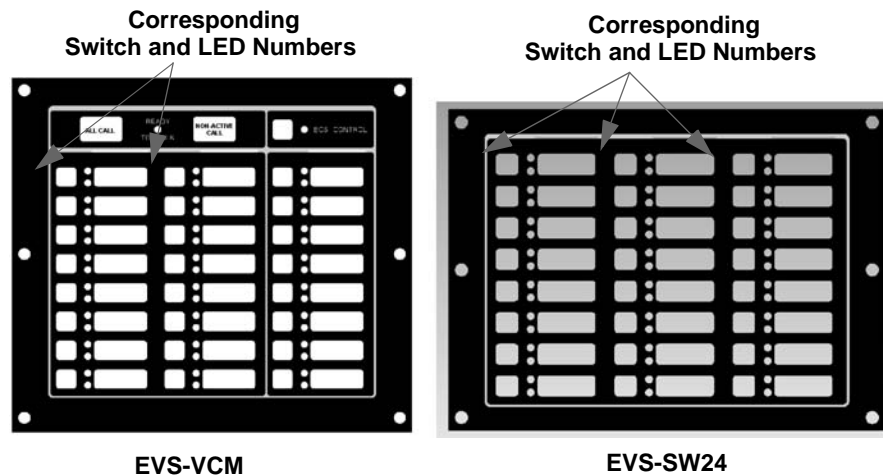









Figure 9-11 Corresponding Switch and LED for Mapping Output Groups

1. To get to this menu item repeat steps 1 through 6 of Section 7.4.1.
2. To edit group properties, press 2.
3. Press the  or  arrows to select the desired latching option.
4. Press ENTER.
5. Press the  or  arrows to select the desired silencing option. Refer to Table 7-2.
6. Press ENTER.
7. Press the  or  arrows to select the desired reverse polarity option
8. Press ENTER.
9. Enable group activation for a condition (see Table 7-4) by pressing the  or  arrows to select Y (yes) or N (no).
10. Press ENTER.
11. Repeat steps 9 and 10 for all the activation options.

9.13 Voice Command Mapping

Where an EVS event is playing can be configured automatically or manually. The automatic method is through voice system mapping and the manual method is using output group override.

9.13.1 Voice System Mapping

Mapping EVS events to activate output groups is just like mapping events for the fire system. These are located under the voice tab of SKSS.

System Event	User Name	Groups
Fire Page	User input not allowed	
Convenience Page	User input not allowed	
Emergency Comm Page	Emergency Page	
General Emergency Comm	User input not allowed	
Emergency Comm 1	Emergency 1 Active	
Emergency Comm 2	Emergency 2 Active	
Emergency Comm 3	Emergency 3 Active	
Emergency Comm 4	Emergency 4 Active	
Emergency Comm 5	Emergency 5 Active	
Emergency Comm 6	Emergency 6 Active	

Figure 9-12 Voice System Mapping in SKSS

9.13.2 EVS Voice Aux Inputs (Dynamic with VCM/RVM in the system)

Voice Aux inputs are in the priority table dynamically based on the number of EVS-VCM and EVS-RVMs in the system. If the system contains the one EVS-VCM and three EVS-RVMs the priority table will show 'EVS Aux Voice In 1' through 4. This is the same with voice mapping except voice mapping doesn't have the EVS tag in front of the event. See Table 9-2.

Note: With the EVS release, we are introducing status points to the system. The priorities associated with these and non-EVS voice aux in are always added (internal to the system) after trouble.

Zone Mapping to Voice Output Groups

When a voice output group is selected to be activated by a zone, the cadence pattern choice listed in Section 7.3.1.4 do not apply. For voice output groups, one of 18 plus all “Aux Voice In” system wide voice commands will activate instead of the cadence pattern. Which command is determined by the event type selected for that zone. The voice commands are programmable by the installer (see Section 7.10 for more information). Table 9-3 lists the voice commands and the associated event type.

Table 9-3: Event Types for Voice Commands

Priority*	Name	Comments
1	Fire	It will sound whenever a request is made to activate a voice output group that was triggered from a manual pull, detector, or water flow event.
2	Fire Aux1	Fire Command
3	Fire Aux 2	Fire Command
4	Fire Pre Alarm	Fire Command
5	Fire Supervisory	Fire Command
6	CO Alarm	CO Command
7	CO Supervisory	CO Command
8	Custom Emergency Comm	Custom EVS command (Microphone triggered EVS)
9	Emergency Communication 1	EVS Message 1
10	Emergency Communication 2	EVS Message 2
11	Emergency Communication 3	EVS Message 3
12	Emergency Communication 4	EVS Message 4
13	Emergency Communication 5	EVS Message 5
14	Emergency Communication 6	EVS Message 6
15	Emergency Communication 7	EVS Message 7
16	Emergency Communication 8	EVS Message 8
17	Aux Voice In 1	First EVS-VCM/RVM configured as lowest SBUS Address.
18 - XX	Aux Voice in 2 - XX	Remaining EVS-VCM/RVM configured as next lowest SBUS Address.
XX	General Emergency Communication	General EVS - Active when any other EVS is active in system
XX	Trouble	Fire Command

*The priorities are not set, they are configurable by the user. For each installation a risk assessment must be done to decide the priority of events.

9.13.3 Edit Command Mapping

Up to 8 groups or templates can be assigned to each voice system event. See Table 9-4.

Table 9-4: Voice Commands Mapping

System Event
Custom Emergency Communication
Emergency Communication 1
Emergency Communication 2
Emergency Communication 3
Emergency Communication 4
Emergency Communication 5
Emergency Communication 6
Emergency Communication 7
Emergency Communication 8
Aux Voice In 1
Aux Voice In 2 - XX
General Emergency Communication
Microphone Engaged

9.13.3.1 Mapping for Voice Commands

To Edit CMD Mapping see Section 7.10.3.3. Select the EVS message for items described. See Table 9-4.

Eight groups or templates can be entered in the following screen

GXXX -CXX GXXX - CXX

GXXX -CXX GXXX - CXX

GXXX -CXX GXXX - CXX

GXXX -CXX GXXX - CXX

If a voice group is entered in the GXXX field, the cadence field will be filled with a CVC and the field is not able to be edited.

If a non-voice group is entered in the GXXX field, the user will be allowed to enter a cadence value. See example: G004 -CVC G001 - C03.

9.14 EVS Timer Options

9.14.0.2 Timers include

- EVS Control Lockout
 - Immediate
 - Never
 - Timer. (If timer is selected, a range of 1-720 minutes and 0-59 seconds are allowed. Default is 30 seconds).
- EVS Event Auto Reset Time (including Custom Emergency Communication 0 and Emergency Communication 1-8).
 - Event Disabled (the event can not be generated)
 - Never
 - Timer (If timer is selected, a range of 0-240 minutes is allowed. Default is Never Reset).

9.14.0.3 EVS Timer Menu

Table 9-5 EVS Timer Menu

EVS Timer	Option
Control Lockout	Immed/Timer/Never
Auto Reset EC0 (Custom EVS Event)	Disabled/Never/Timer (Min XXX)
Auto Reset EC1	Disabled/Never/Timer (Min XXX)
Auto Reset EC2	Disabled/Never/Timer (Min XXX)
Auto Reset EC3	Disabled/Never/Timer (Min XXX)
Auto Reset EC4	Disabled/Never/Timer (Min XXX)
Auto Reset EC5	Disabled/Never/Timer (Min XXX)
Auto Reset EC6	Disabled/Never/Timer (Min XXX)
Auto Reset EC7	Disabled/Never/Timer (Min XXX)
Auto Reset EC8	Disabled/Never/Timer (Min XXX)

Note: Auto Reset settings only apply to the EVS Events when activated from an LOC interface.

Section 10 Reporting

This section lists receivers that are compatible with this control panel and the reporting codes sent by the control panel for SIA and Contact ID formats.

10.1 Receivers Compatible with the Control Panel

The below table shows receivers compatible with the control panel.

Manufacturer	Model	Format
Silent Knight	Model 9800	SIA and Contact ID
	Model 9000 (SIA formats)	SIA
Ademco	Model 685 (Contact ID)	Contact ID
Sur-Gard	SG-MLR2-DG (V. 1.64 or higher)	SIA and Contact ID
Osborne Hoffman	Quickalert	SIA and Contact ID

10.2 Reporting Formats Table

Event Description	Event Family	SIA Reporting Format			Contact ID Reporting Format			
		Module ID # (if any)	SIA Event Code	Parameter (if any)	Qualifier	Event Code	Group #	Contact #
System Events	Note: System events are reported when either "Report by Point" or "Report by Zone" is selected.							
AC Power restore	Trouble		AR	0	3	301	00	000
AC Power lost	Trouble		AT	0	1	301	00	000
Auto dialer test communication trouble	Trouble		YC	Line #	1	350	00	Line #
Auto dialer test communication trouble restore	Trouble		YK	Line #	3	350	00	Line #
Battery Voltage restore	Trouble		YR	Exp. ID	3	302	00	Exp. ID
Battery Voltage low	Trouble		YT	Exp. ID	1	302	00	Exp. ID
Ground Fault condition detected	Trouble		YP	Exp. ID	1	310	00	Exp. ID
Emergency Reset ¹	Reset		OR	1	1	401	00	001
Emergency System Overridden ¹	Trouble		QS	0	1	244	00	000
Emergency System Overridden Restore ¹	Trouble		QR	0	3	244	00	000
Fire System Overridden ¹	Trouble		FS	0	1	245	00	000
Fire System Override Restore ¹	Trouble		FR	0	3	245	00	000
Ground fault condition restore	Trouble		YQ	Exp. ID	3	310	00	Exp. ID
Fire Drill has begun	Test		FI	0	1	604	00	000
Fire Drill ended	Test		FK	0	3	604	00	000
Initial Power up	Trouble		RR	0	1	305	00	000

Event Description	Event Family	SIA Reporting Format			Contact ID Reporting Format			
		Module ID # (if any)	SIA Event Code	Parameter (if any)	Qualifier	Event Code	Group #	Contact #
Local Programming begin	Trouble		LB	0	1	627	00	000
Local Programming ended normally	Trouble		LS	0	1	628	00	000
Local Programming aborted or ended with errors	Trouble		LU	0	1	628	00	000
Panel Date has been changed	Trouble		JD	0	1	625	00	000
Panel Time has been changed	Trouble		JT	0	1	625	00	000
Phone line 1 trouble Restore	Trouble		LR	1	3	351	00	001
Phone line 2 trouble Restore	Trouble		LR	2	3	352	00	002
Phone line 1 trouble detected	Trouble		LT	1	1	351	00	001
Phone line 2 trouble detected	Trouble		LT	2	1	352	00	002
Periodic test event – normal	Test		RP	0	1	602	00	000
Periodic test event – off normal	Test		RY	0	1	608	00	000
Printer paper restore	Trouble		VI	Exp. ID	3	335	00	Exp. ID
Printer is out of paper	Trouble		VO	Exp. ID	1	335	00	Exp. ID
Printer back on-line	Trouble		VY	Exp. ID	3	336	00	Exp. ID
Printer off-line	Trouble		VZ	Exp. ID	1	336	00	Exp. ID
Remote programming ended normally	Trouble		RS	0	1	412	00	000
Remote programming aborted or ended with errors	Trouble		RU	0	1	413	00	000
Report to an account successful	Trouble		YK	Acct #	3	354	Acct #	Acct #
SBUS expander trouble restore	Trouble		ER	Exp. ID	3	333	00	Exp. ID
SBUS Class A supervision restore	Trouble		ER	Exp. ID	3	333	00	Exp. ID
Short circuit removed from SLC communication loop	Trouble		ER	Exp. ID	3	332	00	Exp. ID
SLC Class A supervision restored	Trouble		ER	Exp. ID	3	331	00	Exp. ID
SLC Class A supervision lost	Trouble		ET	Exp. ID	1	331	00	Exp. ID
SLC address programming started; system has been shut down.	Test		TS	0	1	607	00	000
SLC address programming ended; system has been re-enabled.	Test		TE	0	3	607	00	000
SBUS expander trouble	Trouble		ET	Exp. ID	1	333	00	Exp. ID
SBUS Class A supervision lost	Trouble		ET	Exp. ID	1	333	00	Exp. ID
Short circuit detected on SLC communication loop	Trouble		ET	Exp. ID	1	332	00	Exp. ID
User has initiated dialer test	Test		RX	0	1	601	00	000
User initiated a system reset	Reset		OR	0	1	401	00	000
Unable to report to an account	Trouble		RT	Acct #	1	354	Acct #	Acct #
Voice DMR Trouble ¹	Trouble		ET	Exp. ID	1	332	00	Exp. ID
Voice DMR Trouble Restore ¹	Trouble		ER	Exp. ID	3	332	00	Exp. ID
Voice Mic Trouble ¹	Trouble		ET	Exp. ID	1	332	00	Exp. ID
Voice Mic Trouble Restore ¹	Trouble		ER	Exp. ID	3	332	00	Exp. ID
Voice Codec Trouble ¹	Trouble		ET	Exp. ID	1	332	00	Exp. ID

Event Description	Event Family	SIA Reporting Format			Contact ID Reporting Format			
		Module ID # (if any)	SIA Event Code	Parameter (if any)	Qualifier	Event Code	Group #	Contact #
Voice Codec Trouble Restore ¹	Trouble		ER	Exp. ID	3	332	00	Exp. ID
Voice VBUS Trouble ¹	Trouble		ET	Exp. ID	1	332	00	Exp. ID
Voice VBUS Trouble Restore ¹	Trouble		ER	Exp. ID	3	332	00	Exp. ID
Voice Message Trouble ¹	Trouble	pi message ID	ET	Exp. ID	1	332	Message ID	Exp. ID
Voice Message Trouble Restore ¹	Trouble	pi message ID	ER	Exp. ID	3	332	Message ID	Exp. ID
Voice Switch Expander Trouble ¹	Trouble		ET	Exp. ID	1	332	00	Exp. ID
Voice Switch Expander Trouble Restore ¹	Trouble		ER	Exp. ID	3	332	00	Exp. ID
Voice Circuit Expander Trouble ¹	Trouble		ET	Exp. ID	1	332	00	Exp. ID
Voice Circuit Expander Trouble Restore ¹	Trouble		ER	Exp. ID	3	332	00	Exp. ID
Voice Audio Chain Trouble ¹	Trouble		ET	Exp. ID	1	332	00	Exp. ID
Voice Audio Chain Trouble Restore ¹	Trouble		ER	Exp. ID	3	332	00	Exp. ID
Voice VCM/RVM Audio Chain Trouble ¹	Trouble		ET	Exp. ID	1	332	00	Exp. ID
Voice VCM/RVM Audio Chain Trouble Restore ¹	Trouble		ER	Exp. ID	3	332	00	Exp. ID
Voice VCM/RVM Audio Chain Trouble ¹	Trouble		ER	Exp. ID	3	332	00	Exp. ID
Voice Amp 1 Trouble ¹	Trouble		ET	Exp. ID	1	332	00	Exp. ID
Voice Amp 1 Trouble Restore ¹	Trouble		ER	Exp. ID	3	332	00	Exp. ID
Voice Amp 2 Trouble ¹	Trouble		ET	Exp. ID	1	332	00	Exp. ID
Voice Amp 2 Trouble Restore ¹	Trouble		ER	Exp. ID	3	332	00	Exp. ID
Voice Amp External Amp Missing Trouble ¹	Trouble		ET	Exp. ID	1	332	00	Exp. ID
Voice Amp External Amp Missing Trouble Restore ¹	Trouble		ER	Exp. ID	3	332	00	Exp. ID
Voice Amp External Amp Trouble ¹	Trouble		ET	Exp. ID	1	332	00	Exp. ID
Voice Amp External Amp Trouble Restore ¹	Trouble		ER	Exp. ID	3	332	00	Exp. ID
Voice Amp Generic Trouble ¹	Trouble		ET	Exp. ID	1	332	00	Exp. ID
Voice Amp Generic Trouble Restore ¹	Trouble		ER	Exp. ID	3	332	00	Exp. ID
Voice unsupported Expander Trouble ¹	Trouble		ET	Exp. ID	1	332	00	Exp. ID
Voice unsupported Expander Trouble Restore ¹	Trouble		ER	Exp. ID	3	332	00	Exp. ID
Voice unsupported features Trouble ¹	Trouble		ET	Exp. ID	1	332	00	Exp. ID
Voice unsupported features Trouble Restore ¹	Trouble		ER	Exp. ID	3	332	00	Exp. ID

Event Description	Event Family	SIA Reporting Format			Contact ID Reporting Format			
		Module ID # (if any)	SIA Event Code	Parameter (if any)	Qualifier	Event Code	Group #	Contact #
Water release circuit has been disabled	Trouble	pi Exp. ID	SS	Point #	1	203	Exp. ID	Point #
Water release circuit has been re-enabled	Trouble	pi Exp. ID	SR	Point #	3	203	Exp. ID	Point #
Walk test end	Test		TE	0	3	607	00	000
Walk test begin	Test		TS	0	1	607	00	000
Zone Events	Note: Zone events are reported only when "Report by Zone" is selected.							
Auxiliary power trouble	Trouble		FT	0000	1	320	00	000
Auxiliary power trouble restore	Trouble		FJ	0000	3	320	00	000
CO Detector Alarm	Alarm		GA	Zone #	1	162	00	Zone #
CO Detector Alarm Restore	Restore		GH	Zone #	3	162	00	Zone #
CO Detector Trouble	Trouble		GT	Zone #	1	373	00	Zone #
CO Detector Trouble Restore	Trouble		GJ	Zone #	3	373	00	Zone #
CO Supervisory Condition	Trouble		GS	Zone #	1	200	00	Zone #
CO Supervisory Condition Restore	Trouble		GR	Zone #	3	200	00	Zone #
Detector Trouble	Trouble		FT	Zone #	1	373	00	Zone #
Detector Trouble Restore	Trouble		FJ	Zone #	3	373	00	Zone #
Detector Alarm	Alarm		FA	Zone #	1	110	00	Zone #
Detector Alarm Restore	Restore		FH	Zone #	3	110	00	Zone #
Emergency Notification Trouble ¹	Trouble		QT	1000 + Group #	1	320	00	Group #
Emergency Notification Trouble Restored ¹	Trouble		QJ	1000 + Group #	3	320	00	Group #
Emergency Switch Trouble ¹	Trouble		QT	0	1	242	00	000
Emergency Switch Trouble Restore ¹	Trouble		QJ	0	3	242	00	000
External Reset/Silence/Fire Drill switch trouble	Trouble		UT	0000	1	373	00	000
External Reset/Silence/Fire Drill switch trouble restore	Trouble		UJ	0000	3	373	00	000
LOC Mic Activated Emergency Alarm ¹	Alarm		QA	0	1	220	00	000
LOC Mic Activated Emergency Alarm Restore ¹	Restore		QH	0	3	220	00	000
LOC/Point Emergency # Alarm ¹	Alarm		QA	Emergency #	1	220 + Emergency #	00	Emergency #
LOC/Point Emergency # Alarm Restore ¹	Restore		QH	Emergency #	3	220 + Emergency #	00	Emergency #
Manual Pull switch alarm	Alarm		FA	Zone #	1	115	00	Zone #
Manual Pull switch alarm restore	Restore		FH	Zone #	3	115	00	Zone #
Manual Pull switch trouble	Trouble		FT	Zone #	1	373	00	Zone #
Manual Pull switch trouble restore	Trouble		FJ	Zone #	3	373	00	Zone #
Notification Trouble	Trouble		FT	1000+Group #	1	320	00	Group #
Notification Output trouble restore	Trouble		FJ	1000+Group #	3	320	00	Group #

Event Description	Event Family	SIA Reporting Format			Contact ID Reporting Format			
		Module ID # (if any)	SIA Event Code	Parameter (if any)	Qualifier	Event Code	Group #	Contact #
Positive Alarm Sequence acknowledge switch trouble	Trouble		FT	Zone #	1	373	00	Zone #
Positive Alarm Sequence acknowledge switch trouble restore	Trouble		FJ	Zone #	3	373	00	Zone #
SLC LED Module trouble restore	Trouble		ER	0000	3	333	00	000
SLC LED Module trouble	Trouble		ET	0000	1	333	00	000
Status Point Types Trouble	Trouble		UT	0	1	379	00	000
Status Point Types Trouble Restore	Trouble		UJ	0	3	379	00	000
Supervisory/Tamper switch trouble restore	Trouble		FJ	Zone #	3	373	00	Zone #
Supervisory condition restore	Trouble		FR	Zone #	3	200	00	Zone #
Supervisory condition	Trouble		FS	Zone #	1	200	00	Zone #
Supervisory/Tamper switch trouble	Trouble		FT	Zone #	1	373	00	Zone #
System-based AUX1 switch alarm	Alarm		UA	1000	1	140	01	000
System-based AUX2 switch alarm	Alarm		UA	2000	1	140	02	000
System-based AUX1 switch alarm restore	Restore		UH	1000	3	140	01	000
System-based AUX2 switch alarm restore	Restore		UH	2000	3	140	02	000
System-based AUX1 switch trouble restore	Trouble		UJ	1000	3	373	01	000
System-based AUX2 switch trouble restore	Trouble		UJ	2000	3	373	02	000
System-based AUX1 switch trouble	Trouble		UT	1000	1	373	01	000
System-based AUX2 switch trouble	Trouble		UT	2000	1	373	02	000
Voice Aux Emergency X Alarm ¹	Alarm		UA	2 + Emergency #	1	170 + Emergency #	00	002 + Emergency #
Voice Aux Emergency X Alarm Restore ¹	Restore		UH	2 + Emergency #	3	170 + Emergency #	00	002 + Emergency #
Water flow switch alarm	Alarm		SA	Zone #	1	113	00	Zone #
Water flow switch alarm restore	Restore		SH	Zone #	3	113	00	Zone #
Water flow switch trouble	Trouble		ST	Zone #	1	373	00	Zone #
Water flow switch trouble restore	Trouble		SJ	Zone #	3	373	00	Zone #
Zone-based AUX1 switch alarm	Alarm		UA	1000+ Zone #	1	140	01	Zone #
Zone-based AUX2 switch alarm	Alarm		UA	2000+ Zone #	1	140	02	Zone #
Zone-based AUX1 switch alarm restore	Restore		UH	1000+ Zone #	3	140	01	Zone #
Zone-based AUX2 switch alarm restore	Restore		UH	2000+ Zone #	3	140	02	Zone #
Zone-based AUX1 switch trouble restore	Trouble		UJ	1000+ Zone #	3	373	01	Zone #
Zone-based AUX2 switch trouble restore	Trouble		UJ	2000+ Zone #	3	373	02	Zone #
Zone-based AUX1 switch trouble	Trouble		UT	1000+ Zone #	1	373	01	Zone #
Zone-based AUX2 switch trouble	Trouble		UT	2000+ Zone #	1	373	02	Zone #

Event Description	Event Family	SIA Reporting Format			Contact ID Reporting Format			
		Module ID # (if any)	SIA Event Code	Parameter (if any)	Qualifier	Event Code	Group #	Contact #
Point Events	Note: Point events are reported only when “Report by Point” is selected. When IDP protocol devices are used sensors 1–99 are reported as Pnt #s 1–99, and modules 1–99 are reported as Pnt #s 201–299.							
Auxiliary switch input disabled	Disable	pi Exp. ID	UB	Point #	1	571	Exp. ID	Point #
Auxiliary switch input re-enabled	Disable	pi Exp. ID	UU	Point #	3	571	Exp. ID	Point #
An unexpected SLC device has been detected	Trouble	pi Exp. ID	XE	Point #	1	380	Exp. ID	Point #
An unexpected SLC device has been removed	Trouble	pi Exp. ID	XI	Point #	3	380	Exp. ID	Point #
Auxiliary Power trouble	Trouble	pi Exp. ID	FT	Point #	1	320	Exp. ID	Point #
Aux Power trouble restore	Trouble	pi Exp. ID	FJ	Point #	3	320	Exp. ID	Point #
CO Detector Alarm	Alarm	pi Exp. ID	GA	Point #	1	162	Exp. ID	Point #
CO Detector Alarm Restore	Restore	pi Exp. ID	GH	Point #	3	162	Exp. ID	Point #
CO Detector Trouble	Trouble	pi Exp. ID	GT	Point #	1	373	Exp. ID	Point #
CO Detector Trouble Restore	Trouble	pi Exp. ID	GJ	Point #	3	373	Exp. ID	Point #
CO Supervisory Condition	Trouble	pi Exp. ID	GS	Point #	1	200	Exp. ID	Point #
CO Supervisory Condition Restore	Trouble	pi Exp. ID	GR	Point #	3	200	Exp. ID	Point #
CO Detector Input Switch Disabled	Disable	pi Exp. ID	GB	Point #	1	571	Exp. ID	Point #
CO Detector Input Switch Enabled	Disable	pi Exp. ID	GU	Point #	3	571	Exp. ID	Point #
CO Detector Disabled	Disable	pi Exp. ID	GB	Point #	1	571	Exp. ID	Point #
CO Detector Enabled	Disable	pi Exp. ID	GU	Point #	3	571	Exp. ID	Point #
Detector Alarm	Alarm	pi Exp. ID	FA	Point #	1	110	Exp. ID	Point #
Detector Alarm restore	Restore	pi Exp. ID	FH	Point #	3	110	Exp. ID	Point #
Detector Trouble	Trouble	pi Exp. ID	FT	Point #	1	373	Exp. ID	Point #
Detector Trouble restore	Trouble	pi Exp. ID	FJ	Point #	3	373	Exp. ID	Point #
Emergency Alarm # Point Alarm ¹	Alarm	pi Exp. ID	QA	(EPPP) E - Emergency # PPP - Point #	1	220 + Emer- gency #	Exp. ID	Point #
Emergency Alarm # Point Alarm Restore ¹	Restore	pi Exp. ID	QH	(EPPP) E - Emergency # PPP - Point #	3	220 + Emer- gency #	Exp. ID	Point #
Emergency Alarm # Point Trouble ¹	Trouble	pi Exp. ID	QT	Point #	1	242	Exp. ID	Point #
Emergency Alarm # Point Trouble Restore ¹	Trouble	pi Exp. ID	QJ	Point #	3	242	Exp. ID	Point #
Emergency Alarm # Point Disabled ¹	Disable	pi Exp. ID	QB	Point #	1	243	Exp. ID	Point #
Emergency Alarm # Point Enabled ¹	Disable	pi Exp. ID	QU	Point #	3	243	Exp. ID	Point #
Emergency NAC Trouble ¹	Trouble	pi Exp. ID	QT	Point #	1	320	Exp. ID	Point #
Emergency NAC Trouble Restored ¹	Trouble	pi Exp. ID	QJ	Point #	3	320	Exp. ID	Point #
Emergency Control Circuit Trouble ¹	Trouble	pi Exp. ID	QT	Point #	1	320	Exp. ID	Point #
Emergency Control Circuit Trouble Restored ¹	Trouble	pi Exp. ID	QJ	Point #	3	320	Exp. ID	Point #
Emergency Relay Trouble ¹	Trouble	pi Exp. ID	QT	Point #	1	320	Exp. ID	Point #
Emergency Relay Trouble Restored ¹	Trouble	pi Exp. ID	QJ	Point #	3	320	Exp. ID	Point #

Event Description	Event Family	SIA Reporting Format			Contact ID Reporting Format			
		Module ID # (if any)	SIA Event Code	Parameter (if any)	Qualifier	Event Code	Group #	Contact #
External Reset/Silence/Fire Drill switch trouble	Trouble	pi Exp. ID	UT	Point #	1	373	Exp. ID	Point #
External Reset/Silence/Fire Drill switch trouble restore	Trouble	pi Exp. ID	UJ	Point #	3	373	Exp. ID	Point #
External Reset/Silence/Fire Drill Switch Disabled	Disable	pi Exp. ID	UB	Point #	1	571	Exp. ID	Point #
External Reset/Silence/Fire Drill Switch Enabled	Disable	pi Exp. ID	UU	Point #	3	571	Exp. ID	Point #
LOC Emergency # Alarm ¹	Alarm	pi Exp. ID	QA	Emergency #	1	220 + Emergency #	Exp. ID	Emergency #
LOC Emergency # Alarm Restore ¹	Restore	pi Exp. ID	QH	Emergency #	3	220 + Emergency #	Exp. ID	Emergency #
Manual Pull switch alarm	Alarm	pi Exp. ID	FA	Point #	1	115	Exp. ID	Point #
Manual Release switch alarm (Water Release Zone)	Alarm	pi Exp. ID	FA	Point #	1	110	Exp. ID	Point #
Interlock Switch alarm (Water Release Zone)	Alarm	pi Exp. ID	FA	Point #	1	110	Exp. ID	Point #
Point Disabled	Disable	pi Exp. ID	FB	Point #	1	571	Exp. ID	Point #
Manual Pull switch alarm restore	Restore	pi Exp. ID	FH	Point #	3	115	Exp. ID	Point #
Manual Release switch alarm restore (Water Release Zone)	Restore	pi Exp. ID	FH	Point #	3	110	Exp. ID	Point #
Interlock Switch alarm restore (Water Release Zone)	Restore	pi Exp. ID	FH	Point #	3	110	Exp. ID	Point #
Notification Output trouble restore	Trouble	pi Exp. ID	FJ	Point #	3	320	Exp. ID	Point #
Manual Pull switch trouble restore	Trouble	pi Exp. ID	FJ	Point #	3	373	Exp. ID	Point #
Manual Release switch trouble restore (Water Release Zone)	Trouble	pi Exp. ID	FJ	Point #	3	373	Exp. ID	Point #
Interlock Switch trouble restore (Water Release Zone)	Trouble	pi Exp. ID	FJ	Point #	3	373	Exp. ID	Point #
Positive Alarm Sequence acknowledge switch trouble restore	Trouble	pi Exp. ID	FJ	Point #	3	373	Exp. ID	Point #
Notification Output trouble	Trouble	pi Exp. ID	FT	Point #	1	320	Exp. ID	Point #
Manual Pull switch trouble	Trouble	pi Exp. ID	FT	Point #	1	373	Exp. ID	Point #
Manual Release switch trouble (Water Release Zone)	Trouble	pi Exp. ID	FT	Point #	1	373	Exp. ID	Point #
Interlock Switch trouble (Water Release Zone)	Trouble	pi Exp. ID	FT	Point #	1	373	Exp. ID	Point #
Positive Alarm sequence acknowledge switch trouble	Trouble	pi Exp. ID	FT	Point #	1	373	Exp. ID	Point #
Point Enabled	Disable	pi Exp. ID	FU	Point #	3	571	Exp. ID	Pnt #
Status Point Trouble	Trouble	pi Exp. ID	UT	Point #	1	379	Exp. ID	Point #
Status Point Trouble Restored	Trouble	pi Exp. ID	UJ	Point #	3	379	Exp. ID	Point #
Status Point is Disabled	Disable	pi Exp. ID	UB	Point #	1	580	Exp. ID	Point #
Status Point is Enabled	Disable	pi Exp. ID	UU	Point #	3	580	Exp. ID	Point #
Supervisory/Tamper switch or supervisory detector disabled	Disable	pi Exp. ID	FB	Point #	1	571	Exp. ID	Point #

Event Description	Event Family	SIA Reporting Format			Contact ID Reporting Format			
		Module ID # (if any)	SIA Event Code	Parameter (if any)	Qualifier	Event Code	Group #	Contact #
Supervisory/Tamper switch or supervisory detector trouble restore	Trouble	pi Exp. ID	FJ	Point #	3	373	Exp. ID	Point #
Supervisory condition restore	Trouble	pi Exp. ID	FR	Point #	3	200	Exp. ID	Point #
Supervisory Condition	Trouble	pi Exp. ID	FS	Point #	1	200	Exp. ID	Point #
Supervisory/Tamper switch or supervisory detector trouble	Trouble	pi Exp. ID	FT	Point #	1	373	Exp. ID	Point #
Supervisory/Tamper switch or supervisory detector re-enabled	Disable	pi Exp. ID	FU	Point #	3	571	Exp. ID	Point #
System-based AUX1 switch trouble restore	Trouble	pi Exp. ID	UJ	Point #	3	373	Exp. ID	Point #
System-based AUX2 switch trouble restore	Trouble	pi Exp. ID	UJ	Point #	3	373	Exp. ID	Point #
System-based AUX1 switch trouble	Trouble	pi Exp. ID	UT	Point #	1	373	Exp. ID	Point #
System-based AUX2 switch trouble	Trouble	pi Exp. ID	UT	Point #	1	373	Exp. ID	Point #
System-based AUX1 switch alarm restore	Restore	pi Exp. ID	UH	Point #	3	140	Exp. ID	Point #
System-based AUX2 switch alarm restore	Restore	pi Exp. ID	UH	Point #	3	140	Exp. ID	Point #
System-based AUX1 switch alarm	Alarm	pi Exp. ID	UA	Point #	1	140	Exp. ID	Point #
System-based AUX2 switch alarm	Alarm	pi Exp. ID	UA	Point #	1	140	Exp. ID	Point #
Voice Aux Emergency X Point Alarm ¹	Alarm	pi Exp. ID	UA	([2+ Emergency #] PPP - Point #	1	170 + Emergency #	Exp. ID	Point #
Voice Aux Emergency X Point Alarm Restore ¹	Restore	pi Exp. ID	UH	([2+ Emergency #] PPP - Point #	3	170 + Emergency #	Exp. ID	Point #
Voice Aux Emergency Point Trouble ¹	Trouble	pi Exp. ID	UT	Point #	1	379	Exp. ID	Point #
Voice Aux Emergency Point Trouble Restore ¹	Trouble	pi Exp. ID	UJ	Point #	3	379	Exp. ID	Point #
Voice Aux Emergency Point Disabled ¹	Disable	pi Exp. ID	UB	Point #	1	580	Exp. ID	Point #
Voice Aux Emergency Point Enabled ¹	Disable	pi Exp. ID	UU	Point #	3	580	Exp. ID	Point #
Voice Aux Status Switch Trouble ¹	Trouble	pi Exp. ID	UT	Point #	1	379	Exp. ID	Point #
Voice Aux Status Switch Trouble Restored ¹	Trouble	pi Exp. ID	UJ	Point #	3	379	Exp. ID	Point #
Voice Aux Status Switch Disabled ¹	Disable	pi Exp. ID	UB	Point #	1	580	Exp. ID	Point #
Voice Aux Status Switch Enabled ¹	Disable	pi Exp. ID	UU	Point #	3	580	Exp. ID	Point #
Water flow switch alarm	Alarm	pi Exp. ID	SA	Point #	1	113	Exp. ID	Point #
Water flow switch disabled	Disable	pi Exp. ID	SB	Point #	1	571	Exp. ID	Point #
Water flow switch alarm restore	Restore	pi Exp. ID	SH	Point #	3	113	Exp. ID	Point #
Water flow switch trouble restore	Trouble	pi Exp. ID	SJ	Point #	3	373	Exp. ID	Point #
Water flow switch trouble	Trouble	pi Exp. ID	ST	Point #	1	373	Exp. ID	Point #
Water flow switch re-enabled	Disable	pi Exp. ID	SU	Point #	3	571	Exp. ID	Point #
Zone-based AUX1 switch alarm	Alarm	pi Exp. ID	UA	Point #	1	140	Exp. ID	Point #
Zone-based AUX2 switch alarm	Alarm	pi Exp. ID	UA	Point #	1	140	Exp. ID	Point #

Event Description	Event Family	SIA Reporting Format			Contact ID Reporting Format			
		Module ID # (if any)	SIA Event Code	Parameter (if any)	Qualifier	Event Code	Group #	Contact #
Zone-based AUX1 switch alarm restore	Restore	pi Exp. ID	UH	Point #	3	140	Exp. ID	Point #
Zone-based AUX2 switch alarm restore	Restore	pi Exp. ID	UH	Point #	3	140	Exp. ID	Point #
Zone-based AUX1 switch trouble restore	Trouble	pi Exp. ID	UJ	Point #	3	373	Exp. ID	Point #
Zone-based AUX2 switch trouble restore	Trouble	pi Exp. ID	UJ	Point #	3	373	Exp. ID	Point #
Zone-based AUX1 switch trouble	Trouble	pi Exp. ID	UT	Point #	1	373	Exp. ID	Point #
Zone-based AUX2 switch trouble	Trouble	pi Exp. ID	UT	Point #	1	373	Exp. ID	Point #
System-based Wireless Gateway Trouble	Trouble	pi Exp. ID	UT	UTN-NXXPPPP	1	373	Exp. ID	Point #
System-based Wireless Gateway Trouble - restore	Trouble	pi Exp. ID	UJ	UJN-NXXPPPP	3	373	Exp. ID	Point #
Wireless Gateway Trouble	Trouble	pi Exp. ID	UT	UTN-NXXPPPP	1	373	Exp. ID	Point #
Wireless Gateway Trouble restore	Trouble	pi Exp. ID	UJ	UJN-NXXPPPP	3	373	Exp. ID	Point #
¹ Events only applicable to VIP/ECS/EVS panels								

Section 11

Testing and Troubleshooting

11.1 Troubleshooting

This section of the manual offers suggestions for troubleshooting hardware problems. Please read this section if you encounter a problem when installing the control panel. If these suggestions do not solve your problem or if you encounter a problem that is not listed here, contact Silent Knight Technical Support at 800-446-6444 for assistance.

11.2 Common Problems

Problem	Possible Cause / Suggested Actions
Trouble message "DBL ADDR" (Double Address) displays on LCD.	An address has been assigned to more than one detector. Correct the address following the procedure described in Section 5.8 if using SD devices or Section 5.6 if using SK devices.
Auxiliary power or notification circuits have incorrect polarity.	Correct polarity. For notification and auxiliary power circuits: When in alarm or powered, terminals labeled "X" are positive, terminals labeled "O" are negative.
SLC devices are not being recognized (trouble message "Missing" displays).	<p>Check hardware connections.</p> <p>If devices are physically connected, make sure wiring is correct (see Section 5.7 if using SD devices or Section 5.5 if using SK devices). For the main panel, the positive side of device must be connected to terminal 34; the negative side must be connected to Terminal 33. For 5815XL devices, make sure the device connects to the 5815XL via the SLC OUT terminals.</p> <p>There can be only one SLC loop on the main panel and on each 5815XL module. Do not connect devices to terminals labeled SLC IN.</p>
	<p>Make sure SLC devices have been addressed properly following the procedure described in Section 5.7 if using SD devices or Section 5.5 if using SK devices.</p> <p>For contact monitor modules, which are addressed using DIP switches, the DIP switch must be set to the correct address before power is applied to the SLC loop. If this procedure is not followed, the device will have an incorrect address.</p>
	<p>Make sure correct polarity has been observed for SLC device wiring. See Section 5.7 if using SD devices or 5.5 if using SK devices.</p>

Problem	Possible Cause / Suggested Actions
SLC devices are not being recognized (trouble message “Missing” displays on the annunciator).	<p>Check that SLC loop impedance is within the required range. To measure impedance, use the following procedure:</p> <ol style="list-style-type: none"> 1. Disconnect both wires from the terminal block at the panel (SLC devices can remain connected). 2. Measure the impedance from positive to negative and from negative to positive. Both measurements should be greater than 500 K ohms. If the installation uses T-taps, test each T-tap individually. 3. Temporarily connect the positive wire to the negative wire of the SLC loop at the point farthest from the panel (SLC devices can remain connected). 4. Measure the impedance from positive to negative and from negative to positive wires that were disconnected from the panel in step 1. Both measurements must be less than 50 ohms.
The panel indicates a ground fault trouble condition (trouble message “GROUND FAULT” displays).	<p>An earth ground fault occurs when the panel senses an unexpected flow of current from one or more of its terminals to the earth connection (Terminal 2). Isolate the wiring that is causing the fault by removing wiring connections one at a time until the earth fault is no longer present. Pause at least five seconds after removing a wire before removing the next one.</p> <p>The panel will also go into ground fault if a computer is connected to the panel via a serial cable attached to the panel’s 9-pin connector. This is a correct method for on-site communication between a panel and a computer. Ignore the ground fault message in this case. The trouble will clear automatically when you disconnect the computer from the cable</p>
5815XL module that has been physically connected to the panel but is not being recognized.	<p>Check the status of the 5815XL green LED. If it flashes in the pattern .5 sec. on / .5 sec. off, it is likely that the 5815XL has not been added to the system through programming. JumpStart will add any 5815XLs connected to the panel. If you have already run JumpStart, 5815XLs can be added manually (see Section 7.2.2).</p> <p>Check that the correct ID for the 5815XL module has been set through the DIP switches. Assign ID#1 to the first 5815XL and ID#2 to the second 5815XL. See Section 4.10.1 for complete details.</p> <p>If the wiring between the 5815XL and the panel is correct, measure the voltage from 5815XL Terminal (+) to Terminal (-). Voltage should be in the range 27.2-27.4V when AC power is present.</p> <p>If the green LED is not flashing, the likely cause is incorrect wiring from between the 5815XL and the panel. See Section 4.6.1 for wiring details.</p>

11.3 Periodic Testing and Maintenance

To ensure proper and reliable operation, it is recommended that system inspection and testing be scheduled monthly or as required by national and/or local fire codes. Testing should be done by a qualified service representative if a malfunction is encountered.

Before Testing:

1. Notify the fire department and/or central alarm receiving station.
2. Notify facility personnel of a test so that alarm sounding devices are ignored during the test period.

Testing: Conduct a fire drill

1. Rotate the key or enter a code then press ENTER to access the menu.
2. Press 1.
3. Press 1 to select Fire Drill.
4. Press any key to begin the drill. To end the drill, press any key.

To conduct a fire drill from a remote fire drill switch:

Activate the switch to begin the drill; de-activate the switch to end the drill.

Measure battery voltage while the Notification Appliances are sounding. Replace any battery with terminal voltage less than 85% of rating. Reapply AC power and press RESET.

Note: Replace Battery every 5 years.

Return all switches to their normal outward positions. Notify fire department, central station and/or building personnel that the test is complete.

11.4 Event History

The event history can be useful for tracking or recalling a trouble condition.

11.5 Built-in Troubleshooting and Testing Tools

The fire control panel has several built-in testing and troubleshooting tools that can be utilized to save time while testing and troubleshooting points and SLC devices.

11.5.1 SLC Device Locator

SLC device locator can be used to locate a device on a SLC loop.

Follow these steps to locate a particular SLC device:

1. Select 2 (Point Functions) from the Main Menu.
2. Select 4 (SLC Dev Locator).

A message similar to the one shown in Figure 11-1 will display.

```
System will be shut
down during SLC
device locating:
Continue? NO
```

Figure 11-1 Shut Down Warning

3. Press the ▲ or ▼ arrow to toggle NO to YES then press ENTER.
If NO is chosen you will exit back to the Point Function menu.
If Yes is chosen the system will cease normal operation leaving the premise unprotected.
4. Select the SLC loop.
5. Enter the SLC address of the device you wish to locate.
The LED on the selected device will start flashing.
6. Press the left arrow to exit the SLC Device Locator.

Note: Once you exit, the system will resume normal operation.

11.5.2 SLC Multiple Locator

This feature is the same as SLC Device Locator, except you can locate up to 8 devices on a single search.

Follow these instructions to locate multiple SLC devices:

1. Select 2 (Point Functions) from the Main Menu.
2. Select 5 (SLC Multiple Device Locator).

A message similar to the one shown in Figure 11-1 will display.

```
System will be shut
down during SLC
device locating:
Continue? NO
```

Figure 11-2 Shut Down Warning



3. Press the ▲ or ▼ arrow to toggle **NO** to **YES** then press ENTER.
If NO is chosen you will exit back to the Point Function menu.
If Yes is chosen the system will cease normal operation leaving the premise unprotected.
4. Select the SLC loop.
5. Enter up to 8 SLC addresses for the devices you wish to locate.
The LEDs on the selected devices will start flashing.
6. Press the left arrow to exit SLC Multiple Device Locator.

Note: Once you exit, the system will resume normal operation.

11.5.3 I/O Point Control

This feature allows you to toggle any output on or off and trip any input device. This can be useful to test a point's output mapping.

Follow these steps to control a I/O point:

1. Select 2 (Point Functions) from the Main Menu.
2. Select 6 (I/O Point Control).
3. Select the module the point is on.
4. Use the  or  arrow to select the point you wish to test.
5. Press ENTER to generate an alarm for an input point or activate an output point.
6. To exit press the left arrow.

11.5.4 Earth Fault Resistance

Table 11-1 lists the earth fault resistance detection for each applicable terminal on the FACP.

Table 11-1: Earth Fault Resistance Values by Terminal

Function	Terminal Number	Terminal Label		Low Biased		High Biased	
		(Values in Ohms)		High Trip	High Restore	Low Trip	Low Restore
Flexput™ Notification Circuits	4	X	I/O 6	-	-	0	0
	5	O		0	0	-	-
	6	X	I/O 5	-	-	0	0
	7	O		0	0	-	-
	8	X	I/O 4	-	-	0	0
	9	O		0	0	-	-
	10	X	I/O 3	-	-	0	0
	11	O		0	0	-	-
	12	X	I/O 2	-	-	0	0
	13	O		0	0	-	-
	14	X	I/O 1	-	-	0	0
15	O		0	0	-	-	
SBUS Communication	16	B	SBUS OUT	-	-	0	0
	17	A		-	-	0	0
SBUS Power	18	+		0	0	-	-
	19	-		-	-	0	0
SBUS Communication	20	B	SBUS IN	-	-	0	0
	21	A		-	-	0	0
SBUS Power	22	+		0	0	-	-
	23	-		-	-	0	0
SLC Terminals	33	SC-	SLC OUT	-	-	0	0
	34	S+		0	0	-	-
	35	SC-	SLC IN	-	-	0	0
	36	S+		0	0	-	-

Section 12

Installation Records

This section of the manual is for you to use if you wish to track of how points, zones, and groups have been programmed.

12.1 Detector and Module Point Record

If installing SK SLC devices, use Table 12-1 to record detector points (up to 99 per SLC loop) installed on the on-board SLC loop and make a copy of Table 12-2 to record installed modules (up to 99 per SLC loop). If installing SD SLC devices, use Table 12-1 to record sensors and modules (up to 127) installed on the on-board SLC loop and make copies, as needed, of Table 12-2 for 5815XL installed on the system.

Default addresses for ID: On-board: = 33; 5815-1: = 1; 5815-2: = 2

Table 12-1: Installation Record of Onboard Devices

Module	Addr	Zone / Group	Description	Module	Addr	Zone/ Group	Description
On-board	1			On-board	25		
On-board	2			On-board	26		
On-board	3			On-board	27		
On-board	4			On-board	28		
On-board	5			On-board	29		
On-board	6			On-board	30		
On-board	7			On-board	31		
On-board	8			On-board	32		
On-board	9			On-board	33		
On-board	10			On-board	34		
On-board	11			On-board	35		
On-board	12			On-board	36		
On-board	13			On-board	37		
On-board	14			On-board	38		
On-board	15			On-board	39		
On-board	16			On-board	40		
On-board	17			On-board	41		
On-board	18			On-board	42		
On-board	19			On-board	43		
On-board	20			On-board	44		
On-board	21			On-board	45		
On-board	22			On-board	46		
On-board	23			On-board	47		
On-board	24			On-board	48		
On-board	49			On-board	89		
On-board	50			On-board	90		
On-board	51			On-board	91		
On-board	52			On-board	92		

Table 12-1: Installation Record of Onboard Devices

Module	Addr	Zone / Group	Description	Module	Addr	Zone/ Group	Description
On-board	53			On-board	93		
On-board	54			On-board	94		
On-board	55			On-board	95		
On-board	56			On-board	96		
On-board	57			On-board	97		
On-board	58			On-board	98		
On-board	59			On-board	99		
On-board	60			On-board	100		
On-board	61			On-board	101		
On-board	62			On-board	102		
On-board	63			On-board	103		
On-board	64			On-board	104		
On-board	65			On-board	105		
On-board	66			On-board	106		
On-board	67			On-board	107		
On-board	68			On-board	108		
On-board	69			On-board	109		
On-board	70			On-board	110		
On-board	71			On-board	111		
On-board	72			On-board	112		
On-board	73			On-board	113		
On-board	74			On-board	114		
On-board	75			On-board	115		
On-board	76			On-board	116		
On-board	77			On-board	117		
On-board	78			On-board	118		
On-board	79			On-board	119		
On-board	80			On-board	120		
On-board	81			On-board	121		
On-board	82			On-board	122		
On-board	83			On-board	123		
On-board	84			On-board	124		
On-board	85			On-board	125		
On-board	86			On-board	126		
On-board	87			On-board	127		
On-board	88						

Additional SLC Devices

Use the table below to record devices installed on additional 5815XLs. Make a copy of this page if additional

12.2 Conventional Output Point Record

This chart can be used to keep track of how conventional output points (circuits) have been configured.

Point/Circuit	Group	Description
1		
2		
3		
4		
5		
6		
7		
8		

Appendix A

Compatible Device

A.1 Notification Appliances

For proper operation, you must use polarized devices with a Model 7628 4.7k ohm EOL resistor on each loop. All supervised notification appliances used with the control panel must be polarized.

Note: *Not all devices can use the Sync feature, be sure to check table below to ensure the device you have chosen will work with this feature. This control is UL listed for panel wide Synchronization.*

Table below lists notification appliances compatible with the fire alarm control panel. Appliances which can be synchronized indicate the type of SYNC available in the columns marked Audio and Visual.

Table A-1: Compatible Notification Appliances

Manufacturer	Model	Audio	Visual	Type
AMSECO	SH24W-153075	x	x	Horn/Strobe
	SAD24-153075		x	Strobe
	SAD24-75110		x	Strobe
	SL24W-75110		x	Strobe
	SL24C-3075110		x	Strobe
	SLB24-75		x	Strobe
	RSD24-153075		x	Strobe
	RSD24-75110		x	Strobe
	SH24W-75110	x	x	Horn/Strobe
	SH24W-3075110	x	x	Horn/Strobe
	SHB24-75	x	x	Horn/Strobe
	SCM24W-153075	x		Chimes/Strobe
	SCM24W-75110	x		Chimes/Strobe
	SCM24C-3075110	x		Chimes/Strobe
	SCM24C-177	x		Chimes/Strobe
	H24W	x		Horn
	H24R	x		Horn

Table A-1: Compatible Notification Appliances

Manufacturer	Model	Audio	Visual	Type	
FCI	S2415-FC		x	Strobe	
	S241575-FC		x	Strobe	
	S2430-FC		x	Strobe	
	130-3117C	x		Mini Horn	
	130-3147C	x		Mini Horn	
	BLV-6	x		Vibrating Bell	
	BLV-10	x		Vibrating Bell	
	BLVCH	x		Vibrating Chime	
	H12/24-FC	x		Horn	
	H12/24W-FC	x		Horn	
	H12/24K-FC	x		Horn	
	HC12/24-FC	x		Horn	
	HC12/24W-FC	x		Horn	
	HC12/24K-FC	x		Horn	
	P2415-FC	x	x	Horn/Strobe	
	P2415W-FC	x	x	Horn/Strobe	
	P2415K-FC	x	x	Horn/Strobe	
	P241575-FC	x	x	Horn/Strobe	
	P241575W-FC	x	x	Horn/Strobe	
	P241575F-FC	x	x	Horn/Strobe	
	P241575K-FC	x	x	Horn/Strobe	
	P2430-FC	x	x	Horn/Strobe	
	P2430W-FC	x	x	Horn/Strobe	
	P2430K-FC	x	x	Horn/Strobe	
	P2475-FC	x	x	Horn/Strobe	
	P2475W-FC	x	x	Horn/Strobe	
	P2475K-FC	x	x	Horn/Strobe	
	P24110-FC	x	x	Horn/Strobe	
	P24110W-FC	x	x	Horn/Strobe	
	P24110K-FC	x	x	Horn/Strobe	
	S2430W-FC			x	Strobe
	S2430K-FC			x	Strobe
	S2475-FC			x	Strobe
S2475W-FC			x	Strobe	
S2475K-FC			x	Strobe	
S24110-FC			x	Strobe	
S24110W-FC			x	Strobe	
S24110K-FC			x	Strobe	
Federal Signal	450	x		Horn	
Federal Signal	VALS	x	x	Horn/Strobe	

Table A-1: Compatible Notification Appliances

Manufacturer	Model	Audio	Visual	Type
Gentex	GEC-24-15	x	x	Horn/Strobe
	GEC-24-30	x	x	Horn/Strobe
	GEC-24-60	x	x	Horn/Strobe
	GEC-24-75	x	x	Horn/Strobe
	GEC-24-177	x	x	Horn/Strobe
	GEC-24-110	x	x	Horn/Strobe
	GEC-24-15/75	x	x	Horn/Strobe
	GX91	x		MiniHorn Steady Tone
	GX93	x		MiniHorn Temporal Tone
	HG124	x		Horn
	HS24-15	x	x	Horn/Strobe
	HS24-30	x	x	Horn/Strobe
	HS24-60	x	x	Horn/Strobe
	HS24-75	x	x	Horn/Strobe
	HS24-110	x	x	Horn/Strobe
	HS24-1575	x	x	Horn/Strobe
	GCC24	x	x	Multi Candella Horn/Strobe Ceiling Mount
	GCCR24		x	Multi Candella Horn/Strobe Ceiling Mount
	GCS24		x	Multi Candella Strobe Ceiling Mount
	GCSR24		x	Multi Candella Strobe Ceiling Mount
	GEGR-24	x	x	Multi Candella Horn/Strobe
	GES24-15		x	Strobe
	GES24-30		x	Strobe
	GES24-60		x	Strobe
	GES24-75		x	Strobe
	GES24-110		x	Strobe
	GES24-15/75		x	Strobe
	GES24-177		x	Strobe
	GES3-24		x	Multi Candella Strobe
	GESR-24		x	Multi Candella Strobe
	GEH-24	x		Horn
	ST24-30		x	Strobe
	ST24-60		x	Strobe
	ST24-75		x	Strobe
	ST24-110		x	Strobe
	ST24-1575		x	Strobe
	WGEC24-75W	x	x	Weatherproof Horn/Strobe
	WGES24-75W		x	Weatherproof Strobe
	WGMS-24-X	x	x	Horn/Strobe

Table A-1: Compatible Notification Appliances

Manufacturer	Model	Audio	Visual	Type
System Sensor	CHR	x		Chime
	CHW	x		Chime
	CHSR	x	x	2-Wire Chime/Strobe
	CHSW	x	x	2-Wire Chime/Strobe
	HR	x	x	Horn
	HW		x	Horn
	HRK		x	Horn
	HWL		x	Horn WHT Wall 4x4
	HRL		x	Horn Red Wall 4x4
	HGRL		x	Horn Red Wall 2x4
	HGWL		x	Horn WHT Wall 2x4
	CHWL	x		Chime WHT Wall 4x4
	CHRL	x		Chime Red Wall 4x4
	CHSRL	x	x	Chime/Strobe Red Wall 4x4
	CHSWL	x	x	Chime/Strobe WHT Wall 4x4
	CHSCRL	x	x	Chime/Strobe Red Ceil 4x4
	CHSCWL	x	x	Chime/Strobe WHT Ceil 4x4
	P2R	x	x	2-Wire Horn/Strobe
	P2R-P	x	x	2-Wire Horn/Strobe
	PC2R	x	x	2-Wire Horn/Strobe
	PC2R-P	x	x	2-Wire Horn/Strobe
	P2RH	x	x	2-Wire Horn/Strobe High Candela
	P2RH-P	x	x	2-Wire Horn/Strobe High Candela
	PC2RH	x	x	2-Wire Horn/Strobe High Candela
	PC2RH-P	x	x	2-Wire Horn/Strobe High Candela
	P2W	x	x	2-Wire Horn/Strobe
	P2W-P	x	x	2-Wire Horn/Strobe
	PC2W	x	x	2-Wire Horn/Strobe
	PC2W-P	x	x	2-Wire Horn/Strobe
	P2WH	x	x	2-Wire Horn/Strobe High Candela
	P2WH-P	x	x	2-Wire Horn/Strobe High Candela
	PC2WH	x	x	2-Wire Horn/Strobe High Candela
	PC2WH-P	x	x	2-Wire Horn/Strobe High Candela
	P2RK	x	x	2-Wire Horn/Strobe
	PC2RK	x	x	2-Wire Horn/Strobe
	P2RHK	x	x	2-Wire Horn/Strobe High Candela
	PC2RHK	x	x	2-Wire Horn/Strobe High Candela
	P4R	x	x	4-Wire Horn/Strobe
	PC4R	x	x	4-Wire Horn/Strobe
	P4RH	x	x	4-Wire Horn/Strobe High Candela
P4W	x	x	4-Wire Horn/Strobe	

Table A-1: Compatible Notification Appliances

Manufacturer	Model	Audio	Visual	Type	
System Sensor (cont.)	PC4W	x	x	4-Wire Horn/Strobe	
	P4WH	x	x	4-Wire Horn/Strobe High Candela	
	PC4WH	x	x	4-Wire Horn/Strobe High Candela	
	P4RK	x	x	4-Wire Horn/Strobe	
	PC4RK	x	x	4-Wire Horn/Strobe	
	P4RHK	x	x	4-Wire Horn/Strobe High Candela	
	PC4RHK	x	x	4-Wire Horn/Strobe High Candela	
	PC4RH	x	x	4-Wire Horn/Strobe High Candela	
	P2RL, P2RL-P, P2RL-SP*	x	x	Horn/Strobe 2W Red Wall 4x4	
	P2WL, P2WL-P, P2WL-SP*	x	x	Horn/Strobe 2W WHT Wall 4x4	
	PC2RL	x	x	Horn/Strobe 2W Red Ceil 4x4	
	PC2WL	x	x	Horn/Strobe 2W WHT Ceil 4x4	
	P2GRL	x	x	Horn/Strobe 2W Red Wall 2x4	
	P2GWL	x	x	Horn/Strobe 2W WHT Wall 2x4	
	P4RL	x	x	Horn/Strobe 4W Red Wall 4X4	
	P4WL	x	x	Horn/Strobe 4W WHT Wall 4X4	
	PC4RL	x	x	Horn/Strobe 4W Red Ceil 4X4	
	PC4WL	x	x	Horn/Strobe 4W WHT Ceil 4X4	
	SR			x	Strobe
	SR-P			x	Strobe
	SCR			x	Strobe
	SCR-P			x	Strobe
	SRH			x	Strobe High Candela
	SRH-P			x	Strobe High Candela
	SCRH			x	Strobe High Candela
	SCRH-P			x	Strobe High Candela
	SW			x	Strobe
	SW-P			x	Strobe
	SCW			x	Strobe
	SCW-P			x	Strobe
	SWH			x	Strobe High Candela
	SWH-P			x	Strobe High Candela
SCWH			x	Strobe High Candela	

Table A-1: Compatible Notification Appliances

Manufacturer	Model	Audio	Visual	Type
System Sensor (cont.)	SCWH-P		x	Strobe High Candela
	SRK		x	Strobe
	SCRK		x	Strobe
	SRHK		x	Strobe High Candela
	SCRHK		x	Strobe High Candela
	SRL, SRL-P, SRL-SP*		x	Strobe Red Wall 4x4
	SWL, SWL-P, SWL-ALERT SWL-CLR-ALERT*		x	Strobe White Wall 4x4
	SCRL		x	Strobe Red Ceil 4x4
	SCWL		x	Strobe White Ceil 4x4
	SCWL-CLR-ALERT		x	Strobe WHT Ceil CLR Lens 4x4
	SGRL		x	Strobe Red Wall 2x4
	SGWL		x	Strobe White Wall 2x4
	P2RH-LF	x	x	2-Wire Low Frequency Sounder Strobe
	P2WH-LF	x	x	2-Wire Low Frequency Sounder Strobe
	HR-LF	x		Low Frequency Sounder
	HW-LF	x		Low Frequency Sounder
	* P=Plain, ALERT=Pad Printing ALERT, SP=Fuego			
Wheelock	AH-12	x		Horn
	AH-24	x		Horn
	AH-12WP	x		Horn Weatherproof
	AH-24WP	x		Horn Weatherproof
	AMT-241575W	x	x	Multi-Tone Horn Strobe
	AMT-24MCW		x	Mutli-Tone Horn Strobe
	AMT-241575W-NYC	x	x	Multi-Tone Horn Strobe
	AMT-12/24	x		Multi-tone Horn
	AMT-12/24 NYC	x		Multi-tone Horn
	AS-121575W		x	Horn/Strobe
	NH-12/24	x	x	Horn
	AS-241575W	x	x	Horn/Strobe
	AS-24MCC	x	x	Horn/Strobe
	AS-24MCCH	x	x	Horn/Strobe
	AS-24MCW	x	x	Horn/Strobe
	AS-24MCWH	x	x	Horn/Strobe
	ASWP-2475W	x	x	Horn/Strobe Weatherproof
	ASWP-2475C	x	x	Horn/Strobe Weatherproof

Table A-1: Compatible Notification Appliances

Manufacturer	Model	Audio	Visual	Type
Wheelock (cont.)	ASWP-24MCWH	x	x	Horn/Strobe
	ASWP-24MCCH	x	x	Horn/Strobe
	CH-70	x		Chime
	CH-90	x		Chime
	CH70-241575W		x	Chime/Strobe
	CH70-24MCW		x	Chime/Strobe
	CH70-24MCWH		x	Chime/Strobe
	CH90-24MCC		x	Chime/Strobe
	CH90-24MCCH		x	Chime/Strobe
	HS-24	x		Horn
	HS4-241575W	x	x	Horn/Strobe
	HS4-24MCW	x	x	Horn/Strobe
	HS4-24MCWH	x	x	Horn/Strobe
	HS4-24MCC	x	x	Horn/Strobe
	MIZ-24S	x	x	Mini Horn Strobe
	MT-121575W		x	MultitoneHorn Strobe
	MT-241575W	x	x	Multitone Horn Strobe
	MT-24MCW		x	Multitone Horn Strobe
	MTWP-2475W		x	Multitone Horn Strobe
	MTWP-2475C		x	Multitone Horn Strobe
	MTG-121575W	x	x	Multitone Horn Strobe
	MTR-121575W	x	x	Multitone Horn Strobe
	MTWPA-2475W	x	x	Multitone Horn Strobe
	MTWPB-2475W	x	x	Multitone Horn Strobe
	MTWPG-2475W	x	x	Multitone Horn Strobe
	MTWPR-2475W	x	x	Multitone Horn Strobe
	MTWPA-24MCCH	x	x	Multitone Horn Strobe
	ZNH	x		Horn
	NS-121575W	x	x	Horn/Strobe
	NS-241575W	x	x	Horn/Strobe
	NS-24MCW	x	x	Horn/Strobe
	NS-24MCC	x	x	Horn/Strobe
	NS-24MCCH	x	x	Horn/Strobe
	ZNS-MCW	x	x	Horn/Strobe
	ZNS-MCWH	x	x	Horn/Strobe
	ZNS-24MCC	x	x	Horn/Strobe

Table A-1: Compatible Notification Appliances

Manufacturer	Model	Audio	Visual	Type
Wheelock (cont.)	ZNS-24MCCH	x	x	Horn/Strobe
	RSS-121575W		x	Strobe
	RSS-241575W		x	Strobe
	RSS-24MCC		x	Strobe
	RSS-24MCCR		x	Strobe
	RSS-24MCCH		x	Strobe
	RSS-24MCCHR		x	Strobe
	RSS-24MCW		x	Strobe
	RSS-24MCWH		x	Strobe
	RSSP-121575W		x	Strobe
	RSSP-241575W		x	Strobe
	RSSR-2415W		x	Strobe
	RSSR-2415C		x	Strobe
	RSSR-2475W		x	Strobe
	RSSR-2475C		x	Strobe
	RSSR-24110C		x	Strobe
	RSSA-24110W		x	Strobe
	RSSB-24110W		x	Strobe
	RSSG-24110W		x	Strobe
	RSSR-24110W		x	Strobe
	RSSA-24MCC		x	Multi-Cd Strobe
	RSSB-24MCC		x	Multi-Cd Strobe
	RSSG-24MCC		x	Multi-Cd Strobe
	RSSR-24MCC		x	Multi-Cd Strobe
	RSSWPA-2475W		x	Strobe Weatherproof
	RSSWPA-24MCCH		x	Strobe Weatherproof
	RSSWPG-24MCCH		x	Strobe Weatherproof
	RSSWPR-24MCCH		x	Strobe Weatherproof
	RSSWP-2475W		x	Strobe Weatherproof
	RSSWP-2475C		x	Strobe Weatherproof
	RSSWP-24MCWH		x	Strobe Weatherproof

Table A-1: Compatible Notification Appliances

Manufacturer	Model	Audio	Visual	Type
Wheelock (cont.)	ZRS-MCWH		x	Strobe
	ZRS-24MCC		x	Strobe
	ZRS-24MCCH		x	Strobe
	MB-G6-24	x		Motor Bell
	MB-G10-24	x		Motor Bell
	MB-G6-12	x		Motor Bell
	MB-G10-12	x		Motor Bell
	MIZ-24-R	x		Mini-Horn
	MT-12/24-R	x	x	Multitone Horn
	MT4-12/2z	x	x	Multitone Horn
	ZRS-MCW		x	Strobe
	MTWPR-24MCCH	x	x	Multitone Horn Strobe
	NH-12/24R	x		Horn
	HSR		x	Horn/Strobe
	HSW		x	Horn/Strobe
	STR		x	Strobe
	STW		x	Strobe
	HNR		x	Horn
HNW		x	Horn	

A.2 Two-Wire Smoke Detectors

Table A-2 lists two-wire smoke detectors that are compatible with the fire control panel. The table is organized by manufacturer. The columns show the number of detectors per loop that can be used.

5820XL / EVS	
Identifier	24H
Operating Voltage Range	18.5–27.4 VDC

Note: The maximum number of smoke detectors per zone is determined by both the current draw and the impedance of the smoke detector. If too many smoke detectors are used on any zone, false alarms could occur.

Do not mix different models of detectors on any zone; false alarms could occur.

Do not mix detectors of different models unless the system is specifically intended to be installed in that configuration.

Control unit Smoke Reset Time must be programmed for a number greater than or equal to the maximum

reset time of the smoke detector.

Table A-2: Compatible Two-Wire Smoke Detectors

Manufacturer	Model Name or Number (Base model name or number in parenthesis)	Compatibility ID		# per Loop
		Head	Base	
Apollo	55000-350 (45681-200)	55000-350	45681-200	24 / loop
	55000-250 (45681-200)	55000-250	45681-200	24 / loop
	55000-225	55000-225	45681-255, 256,	15 / loop for Ion Detectors
	55000-226	55000-226		
	55000-227	55000-227	45681-200, 220, 230, 232, 251,252	15 / loop for Photo Electric Detectors
	55000-325	55000-325		
	55000-328	55000-328		
	55000-326	55000-326		
55000-327	55000-327			
ESL	429C (S10A)	N/A	S10A	30 / loop
	429CRT (S11A)	N/A	S11A	30 / loop
	429CST (S11A)	N/A	S11A	30 / loop
	429CT (S10A)	N/A	S10A	30 / loop
	609U01-11	S10	S00	40 / loop
	609U02-11	S10	S00/S03	40 / loop
	611U (601U or 602U)	S10	S00/S03	40 / loop
	611UD (601U or 602U)	S10	S00/S03	40 / loop
	611UT (601U or 602U)	S10	S00/S03	40 / loop
	612U (601U or 602U)	S10	S00/S03	40 / loop
	612UD (601U or 602U)	S10	S00/S03	40 / loop
	711U (701E or 701U)	N/A	S10A	25 / loop
	712U (701E or 701U)	N/A	S10A	25 / loop
	713-5U (702E or 701U)	N/A	S10A	25 / loop
	713-6U (702E or 701U)	N/A	S10A	25 / loop
	721-U (S10A)	N/A	S10A	30 / loop
721-UT (S10A)	N/A	S10A	30 / loop	
Falcon	525	FDT1	N/A	17 / loop
	525T	FDT1	N/A	17 / loop
Hochiki	SIH-24F (HS-224D OR HSD-224)	HD-3	HB-5	25 / loop
	SLK-24F (HS-224D)	HD-3	HB-5	25 / loop
	SLK-24FH (HS-224D)	HD-3	HB-5	25 / loop

Table A-2: Compatible Two-Wire Smoke Detectors

Manufacturer	Model Name or Number <i>(Base model name or number in parenthesis)</i>	Compatibility ID		# per Loop
		Head	Base	
System Sensor	1400	A	N/A	20 / loop
	1451 (B401B)	A	N/A	20 / loop
	2100	A	N/A	20 / loop
	2100T	A	N/A	20 / loop
	2151 (B401)	A	N/A	16 / loop
	2151T (B401)	A	N/A	16 / loop
	2300T	A	N/A	20 / loop
	2300	A	N/A	20 / loop
	2300TB	A	N/A	20 / loop
	2400	A	N/A	20 / loop
	2400 (DH400)	A	N/A	20 / loop
	2400AIT	A	N/A	20 / loop
	2400AT	A	N/A	20 / loop
	2400TH	A	N/A	20 / loop
	2451 (B401B)	A	N/A	20 / loop
	2451DH (DH 400)	A	N/A	20 / loop
	2451TH (B401B)	A	N/A	20 / loop
	2W-B	A	N/A	16 / loop
	2WT-B	A	N/A	16 / loop
	2WTR-B	A	N/A	16 / loop

A.3 Compatible 520Hz Signaling Speakers

Table A-3 520Hz Speakers

System Sensor Model Number	Description
SPR	Wall High-Fidelity Speaker, Red
SPW	Wall High-Fidelity Speaker, White
SPCR	Ceiling High-Fidelity Speaker, Red
SPCW	Ceiling High-Fidelity Speaker, White
SPSR	Wall High-Fidelity Speaker Strobe, Red
SPSRH	Wall High-Fidelity Speaker Strobe, High Candela, Red
SPSW	Wall High-Fidelity Speaker Strobe, White
SPSCR	Ceiling High-Fidelity Speaker Strobe, Red
SPSCW	Ceiling High-Fidelity Speaker Strobe, White
SPSCWH	Ceiling High-Fidelity Speaker Strobe, High Candela, White
SPSCRH	Ceiling High-Fidelity Speaker Strobe, High Candela, Red
SPSCW-CLR-ALERT	Ceiling High-Fidelity Speaker Strobe, Clear Lens, ALERT, White
SPSCW-P	Ceiling High-Fidelity Speaker Strobe, Plain, White
SPSCWH-P	Ceiling High-Fidelity Speaker Strobe, High Candela, Plain, White
SPSR-P	Wall High-Fidelity Speaker Strobe, Plain, Red
SPSRH-P	Wall High-Fidelity Speaker Strobe, High Candela, Plain, Red
SPSCWH-P	Ceiling High-Fidelity Speaker Strobe, High Candela, Plain, White
SPSW-ALERT	Wall High-Fidelity Speaker Strobe, Amber Lens, ALERT, White
SPSW-CLR-ALERT	Wall High-Fidelity Speaker Strobe, Clear Lens, ALERT, White
SPSW-P	Wall High-Fidelity Speaker Strobe, Plain, Red
SPSWH	Wall High-Fidelity Speaker Strobe, High Candela, White
SPSWH-P	Wall High-Fidelity Speaker Strobe, High Candela, Plain, Red
SPRL	Wall High-Fidelity Speaker, Red
SPWL	Wall High-Fidelity Speaker, White
SPCRL	Ceiling High-Fidelity Speaker, Red
SPCWL	Ceiling High-Fidelity Speaker, White
SPSCRL	Ceiling High-Fidelity Speaker Strobe, Red
SPSCWL	Ceiling High-Fidelity Speaker Strobe, White
SPSRL	Wall High-Fidelity Speaker Strobe, Red
SPSRL-SP	Wall High-Fidelity Speaker Strobe-FUEGO
SPSWL	Wall High-Fidelity Speaker Strobe, White
SPSCWL-P	Ceiling High-Fidelity Speaker Strobe, Standard, White, Plain
SPSRL-P	Ceiling High-Fidelity Speaker Strobe, Standard, Red, Plain
SPSWL-P	Wall High-Fidelity Speaker Strobe, Standard, White, Plain
SPSCWL-CLR-ALERT	Ceiling High-Fidelity Speaker Strobe, Clear Lens, Standard, White, ALERT
SPSWL-ALERT	Wall High-Fidelity Speaker Strobe, Amber Lens, ALERT, White
SPSWL-CLR-ALERT	Wall High-Fidelity Speaker Strobe, Clear Lens, Standard, ALERT, White
*F=FIRE, P=PLAIN, AL=ALERT, AG=AGENT, EV=EVAC, SP=FUEGO, PG=FOGO	

A.4 Compatible 520Hz Low Frequency Bases

Table A-4 Low Frequency Bases

Model Number	Description
B200S-LF	Low Frequency Intelligent Sounder Base
B200SR-LF	Low Frequency Intelligent Sounder Base

Appendix B

Special Characters Lists

This section contains tables of programmable characters that may be used for device, module, and zone names or phone numbers.

B.1 Characters used for Naming

Table B-1 list the available character and their associated numeric designator. When programming these numbers can be entered as a short cut to using the up or down arrow keys, to select characters when naming a point or zone.

Table B-1: Character Table

000	A	001	B	002	C	003	D
004	E	005	F	006	G	007	H
008	I	009	J	010	K	011	L
012	M	013	N	014	O	015	P
016	Q	017	R	018	S	019	T
020	U	021	V	022	W	023	X
024	Y	025	Z	026	a	027	b
028	c	029	d	030	e	031	f
032	g	033	h	034	i	035	j
036	k	037	l	038	m	039	n
040	o	041	p	042	q	043	r
044	s	045	t	046	u	047	v
048	w	049	x	050	y	051	z
052		053	0	054	1	055	2
056	3	057	4	058	5	059	6
060	7	061	8	062	9	063	:
064	-	065	_	066	.	067	,
068	&	069	*	070	#		

Honeywell Fire Product Warranty and Return Policy

General Terms and Conditions

- All new fire products manufactured by Honeywell Silent Knight have a limited warranty period of 36 months from the date of manufacture against defects in materials and workmanship. See limited warranty statement for details.
- This limited warranty does not apply to those products that are damaged due to misuse, abuse, negligence, exposure to adverse environmental conditions, or have been modified in any manner whatsoever.

Repair and RMA Procedure

- All products that are returned to Honeywell for credit or repair require a RMA (Return Authorization) number. Call Customer Service at 800-328-0103 or 203-484-7161 between 8:00 A.M. and 5:00 P.M. EST, Monday through Friday to obtain a return authorization number.
- Honeywell Silent Knight and Farenhyt Series Technical Support is available at 800-446-6444 between 8:00 A.M. and 5:00 P.M. CST, Monday through Friday.
- All returns for credit are subject to inspection and testing at the factory before actual determination is made to allow credit.
- RMA number must be prominently displayed on the outside of the shipping box. See return address example under Advanced Replacement Policy.
- Included with each return should be: a packing slip that has the RMA number, a content list, and a detailed description of the problem.
- All products returned by Honeywell must be sent freight pre-paid. After the product is processed, Honeywell will pay for shipping product back to customer via UPS ground.
- Return the Honeywell Silent Knight product circuit board only. Products that are returned in cabinets will be charged an additional \$50 to cover the extra shipping and handling costs over board only returns. **Do not return batteries.** Honeywell has the authority to determine if a product is repairable. Products that are deemed un-repairable will be returned to the customer.
- Product that is returned that has a board date code more than 36 months from date of manufacture will be repaired and the customer will be assessed the standard Honeywell Silent Knight repair charge for that model.

Advanced Replacement Policy

- Honeywell Silent Knight and Farenhyt Series offers an option of advance replacement for fire product printed circuit boards that fail during the first 6 months of the warranty period. These items must be returned with transportation charges prepaid and must be accompanied by a return authorization.
- For advance replacement of a defective board, contact your local Honeywell Silent Knight distributor or call Honeywell Silent Knight at 800-328-0103 to obtain a RMA (Return Authorization) number and request advanced replacement.
- A new or refurbished board will be shipped to the customer. The customer will initially be billed for the replacement board but a credit will be issued after the repairable board is received at Honeywell Silent Knight. All returned products must comply with the guidelines described under “General Terms and Conditions” and “Repair and RMA Procedure”.
- The defective board must be returned within 30 days of shipment of replacement board for customer to receive credit. No credit will be issued if the returned board was damaged due to misuse or abuse.

- Repairs and returns should be sent to:
Honeywell Fire Systems
Attn: Repair Department / RA Number _____
12 Clintonville Road
Northford, CT 06472 USA

Manufacturer Warranties and Limitation of Liability

Manufacturer Warranties. Subject to the limitations set forth herein, Manufacturer warrants that the Products manufactured by it in its Northford, Connecticut facility and sold by it to its authorized Distributors shall be free, under normal use and service, from defects in material and workmanship for a period of thirty six months (36) months from the date of manufacture (effective Jan. 1, 2009). The Products manufactured and sold by Manufacturer are date stamped at the time of production. Manufacturer does not warrant Products that are not manufactured by it in its Northford, Connecticut facility but assigns to its Distributor, to extent possible, any warranty offered by the manufacturer of such product. This warranty shall be void if a Product is altered, service repaired by anyone other than Manufacturer or its authorized Distributors. This warranty shall also be void if there is a failure to maintain the Products and the systems in which they operate in proper working conditions.

MANUFACTURER MAKES NO FURTHER WARRANTIES, AND DISCLAIMS ANY AND ALL OTHER WARRANTIES, EITHER EXPRESSED OR IMPLIED, WITH RESPECT TO THE PRODUCTS, TRADEMARKS, PROGRAMS AND SERVICES RENDERED BY MANUFACTURER INCLUDING WITHOUT LIMITATION, INFRINGEMENT, TITLE, MERCHANTABILITY, OR FITNESS FOR ANY PARTICULAR PURPOSE. MANUFACTURER SHALL NOT BE LIABLE FOR ANY PERSONAL INJURY OR DEATH WHICH MAY ARISE IN THE COURSE OF, OR AS A RESULT OF, PERSONAL, COMMERCIAL OR INDUSTRIAL USES OF ITS PRODUCTS.

This document constitutes the only warranty made by Manufacturer with respect to its products and replaces all previous warranties and is the only warranty made by Manufacturer. No increase or alteration, written or verbal, of the obligation of this warranty is authorized. Manufacturer does not represent that its products will prevent any loss by fire or otherwise.

Warranty Claims. Manufacturer shall replace or repair, at Manufacturer's discretion, each part returned by its authorized Distributor and acknowledged by Manufacturer to be defective, provided that such part shall have been returned to Manufacturer with all charges prepaid and the authorized Distributor has completed Manufacturer's Return Material Authorization form. The replacement part shall come from Manufacturer's stock and may be new or refurbished. THE FOREGOING IS DISTRIBUTOR'S SOLE AND EXCLUSIVE REMEDY IN THE EVENT OF A WARRANTY CLAIM.

Warn-HL-08-2009.fm



IntelliKnight 5820XL Basic Operating Instructions

These instructions must be framed and displayed next to the 5820XL panel in accordance with NFPA 72 fire code for Local Protected Fire Alarm Systems.

Operation	Keystrokes
Silence Alarms and Troubles	Press silence then rotate the key or enter a code
Reset alarms	Press reset then rotate the key or enter a code.
Conduct a fire drill	<ol style="list-style-type: none"> 1. Rotate the key or Enter the installer code. The panel will automatically go to the main menu. Press 1. 2. Press 1 to select Fire Drill. 3. Press ENTER to begin the drill. To end the drill, press any key. <p>To conduct a fire drill from a remote fire drill switch: Activate the switch to begin the drill; de-activate the switch to end the drill.</p>
View alarms and troubles	<p>When the system is in alarm or trouble, press Down to view location and type of alarm or trouble.</p> <div style="display: flex; justify-content: space-around;"> <div style="border: 1px solid black; padding: 5px; width: 45%;"> <pre>Alarm FS [1] Alarm CO [1] Press [Down] For Status</pre> </div> <div style="border: 1px solid black; padding: 5px; width: 45%;"> <pre>ALARM: MAN_PULL ZONE_1 MODULE 34 CKT_6 FS: a CO: a</pre> </div> </div> <div style="display: flex; justify-content: space-around; margin-top: 5px;"> <div style="text-align: center;">Alarm Supr Trb</div> <div style="text-align: center;">Alarm Supr Trb</div> </div>
View status of point	<ol style="list-style-type: none"> 1. Rotate the key or Enter the installer code. The panel will automatically go to the main menu. Press 2. 2. Press 2 for Point Status. 3. From the list that displays, select the 5815XL module where the point you want to view is located. The screen that displays tells the status of the point including whether detector sensitivity is in compliance (see below).
Check detector sensitivity	<ol style="list-style-type: none"> 1. Rotate the key or enter a code then press ENTER to access the menu. Press 2. 2. Press 2 for Point Status. 3. From the list that displays, select the 5815XL module where the point you want to view is located. 4. The fourth line of the display shows the sensitivity status. "NORMAL" means the detector is in compliance with NFPA 72. "CAL MAINT" means the detector is in compliance with NFPA 72 but maintenance should be performed soon. "CAL TRBLE" means the detector is not in compliance with NFPA 72.
Set time and date	<ol style="list-style-type: none"> 1. Rotate the key or enter a code then press ENTER to access the menu. Press 4. 2. Make changes in the fields on the screen as necessary. 3. When the time and date are correct, press ENTER.
Enable / Disable point	<ol style="list-style-type: none"> 1. Rotate the key or enter a code to access to access Main Menu. 2. Press 2 to select Point Functions. 3. Press 1 for Disable / Enable Pt. 4. Press 7 for Disable / Enable Pt. 5. Use the Up or Down to move through the list. Then press ENTER to select the module where the point you want to disable/enable is located 6. Enter the point or circuit number that you want to disable/enable. 7. Press the right arrow key to toggle between NORMAL (enable) or DISABLE.
View event history	Rotate the key or enter a code then press ENTER to access the menu, then press 3 to select Event History. Events will display in date order, with most recent events displaying first.
For Service Call:	

Cut Along the Dotted Line



5820XL-EVS Basic Operating Instructions

These instructions must be framed and displayed next to the 5820XL-EVS panel in accordance with NFPA 72 fire code for Local Protected Fire Alarm Systems.

FS= Fire System EVS = Emergency Voice System

Operation	Task to Perform
Silence Alarms and Troubles (FS and EVS)	Press SILENCE then rotate the key or enter a code if prompted. Silence LED will light.
Reset Alarms (Fire Only)	Press RESET then rotate the key or enter a code.
Reset Alarms (EVS & Fire)	<ol style="list-style-type: none"> 1. Press RESET. 2. Press 1 to Reset Fire System. 3. Press 2 to Reset Emerg. System. <p><i>Note: To reset EVS at an LOC, the user must gain EVS Control. (See Figure 1).</i></p>
Conduct a fire drill	<ol style="list-style-type: none"> 1. Rotate the key or enter a code then press ENTER to access the menu. 2. Press 1 for System Test. 3. Press 1 to select Fire Drill. 4. Press ENTER to begin the drill. To end the drill, press any key. <p>To conduct a fire drill from a remote fire drill switch: Activate the switch to begin the drill; de-activate the switch to end the drill.</p>
Acknowledge Alarms and Troubles	Press ACK then enter a code if prompted. When the Alarm or Trouble is acknowledged an A will appear in the annunciator display as shown Below. <div style="border: 1px solid black; padding: 5px; display: inline-block; margin-top: 10px;"> <pre> TROUBLE: SMOKE-ION MODULE_33 POINT_1 [2001] [M33:001] A MISSING 1 OF 1 </pre> <p style="text-align: right; margin-right: 10px;">Acknowledge Mark</p> </div>
View all active alarms, troubles, and supervisory signals	The highest priority event will display first. Press down to view location and type of alarm or trouble. After 2 minutes of sitting idle, events will display on line 4. <div style="display: flex; justify-content: space-around; margin-top: 10px;"> <div style="border: 1px solid black; padding: 5px; width: 45%;"> <pre> Alarm ECS [1] Alarm FS [2] Alarm CO [1] Press ↓ For Status </pre> </div> <div style="border: 1px solid black; padding: 5px; width: 45%;"> <pre> ALARM: MAN_PULL ZONE_1 MODULE 34 CKT_6 ECS:a FS:a CO:a </pre> <div style="display: flex; justify-content: space-around; font-size: small;"> <div style="text-align: center;">Alarm Supr Tib</div> <div style="text-align: center;">Alarm Supr Tib</div> <div style="text-align: center;">Alarm Supr Tib</div> </div> </div> </div>
Set Time and Date	<ol style="list-style-type: none"> 1. Rotate the key or enter a code then press ENTER to access the menu. 2. Press 4 for Set Time and Date. 3. Make changes in the fields on the screen as necessary. 4. When the time and date are correct, press ENTER.
Enable / Disable point	<ol style="list-style-type: none"> 1. Rotate the key or enter a code to access the Main menu. 2. Press 2 for Point Functions. 3. Press 1 for Disable / Enable point. 4. Press 7 for Disable / Enable point. 5. Use the Up or Down to move through the list. Then press ENTER to select the module where the point you want to disable/enable is located 6. Enter the point or circuit number that you want to disable/enable. 7. Press Right arrow key to toggle between NORMAL (enable) or DISABLE
To Gain / Request EVS Control	<ol style="list-style-type: none"> 1. Press the  Button and follow the on-screen Instructions. <p><i>Note: When EVS Control LED is blinking, another LOC has EVS Control. EVS Control LED is on steady when the LOC has EVS Control.</i></p>
For Service Call:	

Cut Along the Dotted Line

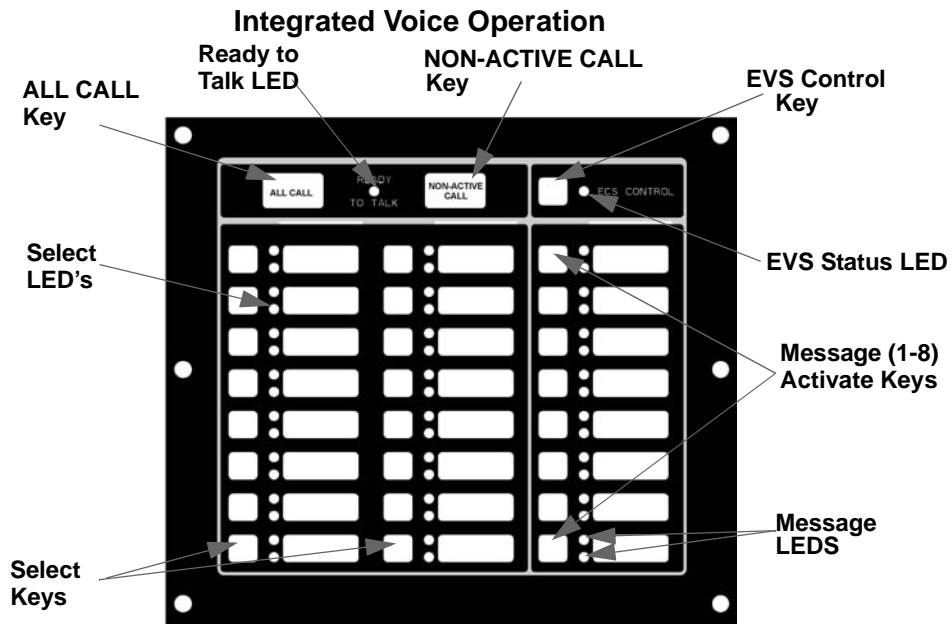

Figure 1: EVS-VCM Front View

Table 1: LED Conditions

LED	Color	States	Meaning
Select Keys	Red	On	The corresponding area is active for the currently playing EVS message.
		Off	The corresponding area is not active.
	Green	On	The corresponding area is active for the microphone.
		Off	The corresponding area is not active for the microphone.
EVS Control LED	Green	On	LOC has EVS Control and the user is able to make changes to the EVS.
		Off	LOC does not have EVS Control.
		Blinking	Another LOC has ECS Control
EVS Message LED	Red	On	The corresponding EVS event was activated by an EVS device.
		Off	The corresponding EVS event is not active.
	Green	On	The corresponding EVS event is active and was generated from the LOC (or was activated from another LOC, but this LOC now has EVS Control).
		Off	The corresponding ECS event was not activated from this LOC or this LOC does not have ECS Control.

Table 2: EVS Control Request

Operation	Task
Gain EVS Control at an LOC	Press the EVS Control Key and enter a code if prompted. If EVS Control is available, the EVS Control LED will illuminate. If another LOC has EVS Control, the display will be similar to the one shown. Press 1 to request control. The LOC with EVS Control will then be able to allow or deny the request.
Gain EVS Control as EVS Super User at an LOC (only one EVS Super User is allowed EVS Control in the system at a time).	From the idle screen, enter an EVS Super User access code and then press the EVS Control Key. If EVS Control as Super User is available, the EVS Control LED will illuminate. If another LOC has Super User EVS Control, a request for Super User EVS Control will automatically be made to the LOC with control. The LOC with Super User EVS Control will then be able to allow or deny the request. (See Figure 1-2 for screen display example).
Select all output group for microphone override	Key the microphone, press the All Call Key, wait for the Ready-to-Talk LED to light, and then deliver your verbal message.
Select all non-activated output groups for microphone override	Key the microphone, press the Non-Active Call Key, wait for the Ready-to-Talk LED to light, and then deliver your verbal message.

Cut Along the Dotted Line



**SILENT
KNIGHT**

by Honeywell

Silent Knight
12 Clintonville Road
Northford, CT 06472-1610
203-484-7161
Fax: 203-484-7118

www.silentknight.com