

HellermannTyton

Product Catalog

North America 2019/2020



1. Bundling and Securing

Technical Information	14
Cable Ties	20
Self Affixing Cable Ties	87
Bundle Separators.....	133
Cable Tie Mounts.....	139
Heavy Duty Cable Tie Mounts	158
Clips	173
Self Affixing Clips.....	178
Clamps	195
Self Affixing Clamps.....	222

2. Routing, Protection and Insulation

Wiring Duct	230
Surface Raceway.....	285
Braided Sleeving	327
Helawrap Protective Tubing	348
Spiralwrap Sheathing	354
Convoluted Tubing	359
Grommet Edging	363
Heat Shrink Tubing	367

3. Identification

Thermal Transfer Printer Labels	386
Laser Printer Labels	407
Ink Jet Printer Labels	414
Dot Matrix Printer Labels.....	418
Heat Shrink Labels	422
Foam Nameplate Labels	426
Hand Writable Labels and Tags	429
Printable Plastic Tags.....	438
Preprinted Wire Labels	439
Solar Identification	444
Paint Masks	470
Safety Labels.....	472
Thermal Transfer Printers	478
Labeling Software	485

4. Application Tools

Automatic Cable Tie Systems	488
Cable Ties for Automatic Systems	493
Pneumatic Tools.....	497
Manual Tools.....	501

5. Electrical Installation

Wire Connectors.....	508
General Purpose Electrical Tape.....	510
Special Purpose Electrical Tape	511

6. Appendix

Standards/Standards Organizations	514
Wire Fill Specifications.....	516
Wiring Duct Material Properties and Capacities.....	518
US Military Standards/Specifications	519
Product Standards and Specifications	525
Part Number Index	564
Type Index	587



Inspired by you

MADE FOR

Our 2019/2020 product catalog

A photograph of two men in a workshop. The man on the left is wearing glasses and a dark shirt, looking towards the right. The man on the right is wearing a dark polo shirt and is pointing at a piece of equipment. The background is a blurred workshop environment.

REAL



We listen. We understand. We invent. We deliver. It's concrete action and not big words that help you effectively manage your cables.

Standard part or custom development: HellermannTyton products help industry professionals reliably fasten, insulate, protect, install, identify, apply and connect electrical cables and network connectivity solutions. Your challenges motivate us to deliver inventive products that make a difference to your business – wherever you are in the world.

Quality and service you can rely on – MADE FOR REAL.



MADE FOR REAL[®]

**Inspired by
innovation**

HellermannTyton develops industry-specific product ranges that raise the bar across the world



Speed, reliability and precision: AT2000 CPK

Our class-leading automatic cable tie application tool features exclusive dual drive motors and the versatility to adapt to any workflow. You'd expect nothing less from the industry's tool leader.

Comprehensive industry expertise

From torsion to weight reduction – every single industry has its own unique demands in terms of cable management. With a high degree of expertise, HellermannTyton develops tailor-made technologies for different markets and industries. These include:



Aerospace



Automotive



Data Communications



Defense



Energies – Solar



Energies – Wind



Industrial Automation



Machines and Equipment Builders (OEM)



Rail



Truck / Heavy Equipment

For more information about our markets and industries please refer to:

www.HellermannTyton.com/industries



MADE FOR REAL[®]

Inspired by
teamwork

HellermannTyton is an international team with a passion to create the best cable management solutions.

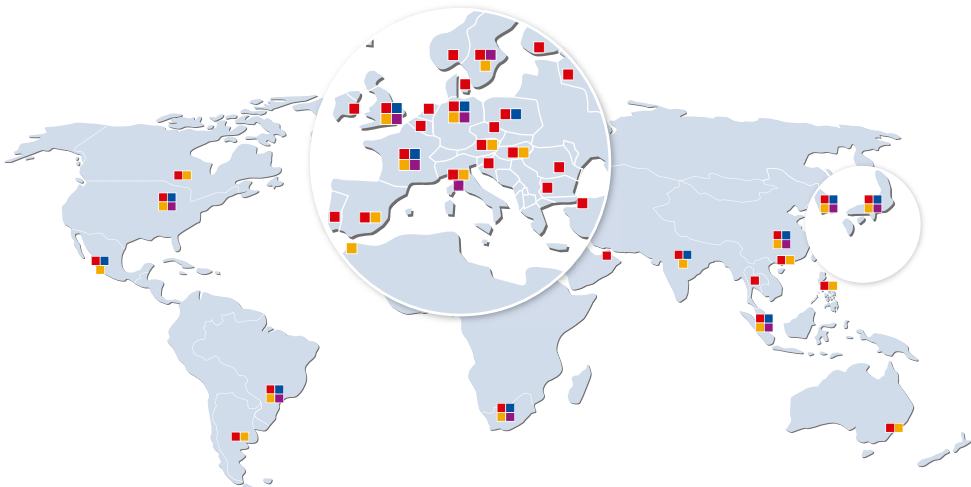

- Sales office
- Distribution
- Manufacturing
- Development

No matter which HellermannTyton sites you visit in person, you can be assured of a friendly, confident atmosphere. In a survey, 10,000 customers confirmed that we are on the right track, with 97 percent saying they would be happy to recommend us.

We want things to stay that way and even improve wherever possible. We will do this with high-quality products and – first and foremost – motivated people who listen carefully, get things done and seek to satisfy all needs.

A large industrial jet engine is shown in a factory setting. The engine is the central focus, with its complex internal components and large fan blades visible. A worker in a blue uniform and safety glasses is standing to the right, working on the engine. The scene is brightly lit, and the engine's metallic surface reflects the light. The text "MADE FOR REAL" is overlaid on the left side of the image.

MADE FOR REAL[®]

Inspired by
extremes

HellermannTyton develops its own products on an ongoing basis. Worldwide, there are about 75,000. We add new ideas every day.



1. Bundling & Securing

TIP: When routing wires or cable near a panel edge, use a self-affixing cable tie. Our integrated edge clip goes on easy and exhibits incredible extraction force.



2. Routing, Protection & Insulation

TIP: Save time installing wire and cable protective sheathing. Choose HelaWrap, which can be applied to your bundle as easily as using a zipper.



3. Identification

TIP: Get an incredible boost in productivity while reducing print errors and label waste. See the technology that will redefine your label printing workflow.



4. Application Tools

TIP: Reduce operator strain and fatigue. The EVO 9 is designed to significantly reduce kickback while consistently tensioning and cutting cable ties up to 250 lb. tensile strength.



5. Electrical Installation

TIP: Make safe, reliable electrical connections in an instant with HelaCon Plus Mini. They're easier to use than wire caps and fit better inside electrical enclosures.





Inspired by design

Edge clips were originally developed for a luxury car. Its cables needed to be routed precisely along an edge where neither drilling nor welding was permitted. The resulting fastener solved the problem so perfectly, this smart cable routing solution was quickly adapted to other models across the world. Today, HellermannTyton makes approximately 90 different edge clips for a wide range of industries.

Technical Information	14
Cable Ties.....	20
Self Affixing Cable Ties	87
Bundle Separators.....	133
Cable Tie Mounts.....	139
Heavy Duty Cable Tie Mounts	158
Clips	173
Self Affixing Clips.....	178
Clamps	195
Self Affixing Clamps.....	222

Bundling and Securing

Material Specification Overview

Material	Material Shortcut	Operating Temperature	Color**	Flammability	Material Properties*	Specifications
Ethylene chlorotrifluoroethylene	E/CTFE	-105°F to +302°F (-76°C to +150°C)	Red (RD)	UL 94 V0	Resistance to radioactivity UV resistant, not moisture sensitive Good chemical resistance to acids, bases, oxidizing agents	
Ethylentetrafluoroethylene	E/TFE	-112°F to +302 °F (-80°C to +150°C)	Blue (BU)	UL 94 V0	Resistance to radioactivity Outstanding UV resistance, not moisture sensitive Good chemical resistance to acids, bases, oxidizing agents	ASTM D-3159 Type 1 Grade 1UL 2043
Polyacetal	POM	-40°F to +194°F (-40°C to +90°C)	Natural (NA)	UL 94 HB	Limited brittleness sensitivity Flexible at low temperature Not moisture sensitive Robust on impact Not recommended for UV resistance	ASTM D6778 POM 0213
Polyacetal, UV stabilized	POMUV	-40°F to +221°F (-40°C to +105°C)	Natural (NA)	UL 94 HB	Limited brittleness sensitivity Flexible at low temperature Not moisture sensitive Robust on impact Excellent UV resistance	
Polyamide 12	PA12	-40°F to +248°F (-40°C to +120°C)	Black (BK)	UL 94 HB	Good chemical resistance to acids, bases, oxidizing agents Excellent UV resistance	ASTM D-4066PA411
Polyamide 4.6	PA46	-40°F to +266°F (-40°C to +130°C)	Brown (BN), Gray (GY), Natural (NA)	UL 94 V2	Resistance to high temperatures Very moisture sensitive Low smoke sensitivity Poor UV resistance	ASTM D-4066PA0922
Polyamide 6	PA6	-40°F to +176°F (-40°C to +80°C)	Black (BK)	UL 94 V2	High yield strength	
Polyamide 6.6	PA66	-40°F to +185°F (-40°C to +85°C)	Black (BK), Natural (NA)	UL 94 V2	High yield strength Poor UV resistance	ASTM D-4066PA0111FDA CFR177.1500
Polyamide 6.6, heat stabilized, glass fiber reinforced	PA66GF30	-40°F to +284°F (-40°C to +140°C)	Black (BK), Natural (NA)	UL 94 HB	High yield strength Poor UV resistance	UL
Polyamide 6.6, high impact modified, heat and UV stabilized, proprietary blend	PA66HIR-HSUVR5	-40°F to +230°F (-40°C to +110°C)	Black (BK)	UL 94 HB	Limited brittleness sensitivity Higher flexibility at low temperature Modified elevated maximum temperature High yield strength, Very good UV resistance	ASTM D-4066PA0151
Polyamide 6.6, high impact modified, heat stabilized	PA66HIRHS	-40°F to +230°F (-40°C to +110°C)	Black (BK)	UL 94 HB	Limited brittleness sensitivity Higher flexibility at low temperature Modified elevated maximum temperature Very good UV resistance	ASTM D-4066PA0161
Polyamide 6.6, high impact modified, heat stabilized, glass fiber reinforced	PA-66HIRHSGF	-40°F to +257°F (-40°C to +125°C)	Black (BK), Natural (NA), Green (GN), Blue (BU), Red (RD)	UL 94 HB	High yield strength Poor UV resistance	
Polyamide 6.6, with metal particles	PA66MP	-40°F to +185°F (-40°C to +85°C)	Blue (BU)	UL 94 HB	High yield strength Metal and X-Ray detectable	
Polyamide 6.6 glass fiber reinforced	PA66GF15	-40°F to +284°F (-40°C to +140°C)	Black (BK), Natural (NA)	UL 94 HB	High yield strength Poor UV resistance	UL
Polyamide 6.6 glass filled impact modified heat stabilized	PA66GF13	-40°F to +284°F (-40°C to +140°C)	Black (BK), Natural (NA)	UL 94 HB	High yield strength Poor UV resistance	UL

*These details are only guide values. They should not be regarded as a exhaustive material specification and are no substitute for suitability tests. Please see our datasheets for further details.

**Additional colors available on request.

HF = Halogen free

LFH = Limited Fire Hazard

RoHS = Restriction of Hazardous Substances

Bundling and Securing

Material Specification Overview

Material	Material Shortcut	Operating Temperature	Color**	Flammability	Material Properties*	Specifications
Polyamide 6.6 heat stabilized	PA66HS	-40°F to +257°F (-40°C to +125°C)	Black (BK), Natural (NA)	UL 94 V2	High yield strength Modified elevated maximum temperature Poor UV resistance	ASTM D-4066PA0121
Polyamide 6.6 high impact modified, heat and UV stabilized	PA66HIR-HSUV	-40°F to +230°F (-40°C to +110°C)	Black (BK)	UL 94 HB	Limited brittleness sensitivity Higher flexibility at low temperature Modified elevated maximum temperature High yield strength Very good UV resistance	ASTM D-4066PA0151UL
Polyamide 6.6 V0	PA66V0	-40°F to +212°F (-40°C to +100°C)	White (WH)	UL 94 V0	High yield strength Low smoke emission	ASTM D-4066PA0110
Polyaryletherketone	PAEK	-67°F to +392°F (-55°C to +200°C)	Beige (BGE)	UL 94 V0	Resistance to radioactivity Not moisture sensitive Good chemical resistance to acids, bases, oxidizing agents Poor UV resistance	21CFR 177.2415EEC 93/9/ EEC 151G
Polyetheretherketone	PEEK	-67°F to +464°F (-55°C to +240°C)	Beige (BGE)	UL 94 V0	Resistance to radioactivity Not moisture sensitive Good chemical resistance to acids, bases, oxidizing agents	DNV GL EN 62275:2009VDE DIN EN 62275:2016- 0121CFR 177.2415EEC 93/9/ EEC 151G
Polyethylene	PE	-40°F to +220°F (-40°C to +104°C)		UL 94 V2	Moderate yield strength Not moisture sensitive Good chemical resistance to acids, bases and solvents	
Polyphenylene sulfide	PPS	-40°F to +302°F (-40°C to +150°C)	Black (BK), Gray (GY)	UL 94 HB	Good UV resistance	
Polypropylene	PP	-40°F to +239°F (-40°C to +115°C)	Black (BK), Natural (NA)	UL 94 HB	Floats in water Moderate yield strength Good chemical resistance to acids, bases and solvents Good UV resistance	ASTM D-4101PP0327
Polypropylene 20% talcum	PPT20	-40°F to +149°F (-40°C to +65°C)		UL 94 HB	Low moisture absorption Good chemical resistance to most acids, bases, alcohol, oils	
Polyvinylchloride	PVC	+122°F (+50°C)	Black (BK), Natural (NA)	UL 94 V0	Low moisture absorption Good chemical resistance to acids, bases, salts, alcohol, oils	
Stainless steel	SS304, SS316	-112°F to +1000°F (-80°C to +538°C)	Metal (ML)	Non-Burning	Corrosion resistant Antimagnetic Weather resistant Outstanding chemical resistance	
Thermoplastic elastomer	TPE	-40°F to +122°F (-40°C to +50°C)		UL 94 HB	Low moisture absorption Good chemical resistance to acids, bases, salts, alcohol, oils	
Thermoplastic vulcanized rubber	TPV	-40°F to +194°F (-40°C to +90°C)	Black (BK)	UL 94 HB	High elasticity Good chemical resistance to acids, bases and oxidizing agents No UV resistance	

*These details are only guide values. They should not be regarded as a exhaustive material specification and are no substitute for suitability tests. Please see our datasheets for further details.

**Additional colors available on request.

HF = Halogen free

LFH = Limited Fire Hazard

RoHS = Restriction of Hazardous Substances

Bundling and Securing

Chemical Resistance of Various Plastics

A = resistant

B = partly resistant

C = not resistant

N/A = not applicable

These values are only rough guides. They should not be regarded as a material specification and are no substitute for a suitability test. Please see our technical datasheets for further details.

	Conc (%)	Temp. (°C)	MATERIAL SHORTCUT									
			PA66	PA46	PA12	PA11	POM	PP	ETFE	TPV	PAEK	PPS
Acetaldehyde	90	52°	B	B	N/A	C	N/A	A	A	B	A	N/A
Acetic Acid	5	23°	B	B	B	B	A	A	A	A	A	N/A
Acetone	100	23°	A	A	A	A	B	A	A	B	A	A
Ammonium chloride	10	52°	C	B	N/A	N/A	N/A	A	A	N/A	N/A	N/A
Benzaldehyde	N/A	23°	A	B	N/A	A	N/A	N/A	A	C	A	N/A
Benzene	100	23°	A	A	A	A	B	B	A	C	A	N/A
Bromine	100	23°	C	C	C	C	N/A	C	A	N/A	N/A	N/A
Calcium chloride	5	60°	A	A	N/A	A	A	A	A	A	A	A
Carbon tetrachloride	100	23°	A	A	B	C	B	C	A	C	N/A	N/A
Chlorine water	Dilute	23°	C	C	N/A	C	N/A	N/A	A	C	N/A	N/A
Chloroform	100	23°	B	C	C	N/A	C	C	A	C	N/A	N/A
Chromic acid	10	23°	C	C	N/A	C	B	A	A	C	A	N/A
Copper sulfate	10	23°	A	A	A	A	A	A	A	N/A	N/A	N/A
Cyclohexanone	100	23°	A		N/A	C	N/A	B	A	B	A	N/A
Diethyl ether	100	23°	A	A	A	A	A	N/A	A	N/A	A	A
Engine oil	100	23°	N/A	N/A	A	A	A	A	A	B	A	A
Ethyl acetate	95	50°	A	A	A	A	B	B	A	B	A	N/A
Ethylene glycol	N/A	23°	A	A	N/A	N/A	N/A	A	A	A	N/A	A
Ether	N/A	23°	A	A	A	N/A	A	N/A	N/A	B	N/A	N/A
Formic acid	98	23°	C	C	C	C	B	A	A	B	N/A	N/A
Gasoline	N/A	23°	A		N/A	A	N/A	B	A	C	N/A	A
Hydrochloric acid	Dilute	23°	C	C	C	B	C	A	A	A	A	A
Hydrogen peroxide	5	43°	C	C	N/A	B	C	A	A	B	N/A	N/A
Methyl alcohol	100	23°	A	N/A	N/A	N/A	A	A	A	A	N/A	A
Methyl isobutyl ketone	100	23°	A	N/A	N/A	N/A	A	N/A	A	N/A	N/A	N/A
Nitric acid	10	23°	C	C	C	C	C	A	A	B	A	A
Petroleum	N/A	23°	A	A	A	A	A	B	A	B	A	A
Phenol	90	23°	C	C	C	C	C	A	A	C	N/A	N/A
Potassium hydroxide	30	98°	B	B	B	C	A	A	A	A	A	N/A
Potassium permanganate	5	23°	C	C	C	C	A	A	A	B	A	N/A
Sodium acetate	60	38°	A	N/A	N/A	C	N/A	A	A	A	N/A	N/A
Sodium chloride	10	23°	A	A	A	A	A	A	A	A	N/A	N/A
Sodium hydroxide	10	23°	A	A	A	A	A	A	A	A	N/A	A
Sulfuric acid	30	23°	C	C	B	B	C	A	A	B	A	A
Toluene	100	50°	A	A	A	A	A	C	A	C	A	A
Xylene	100	23°	A	A	A	A	A	C	A	C	A	A

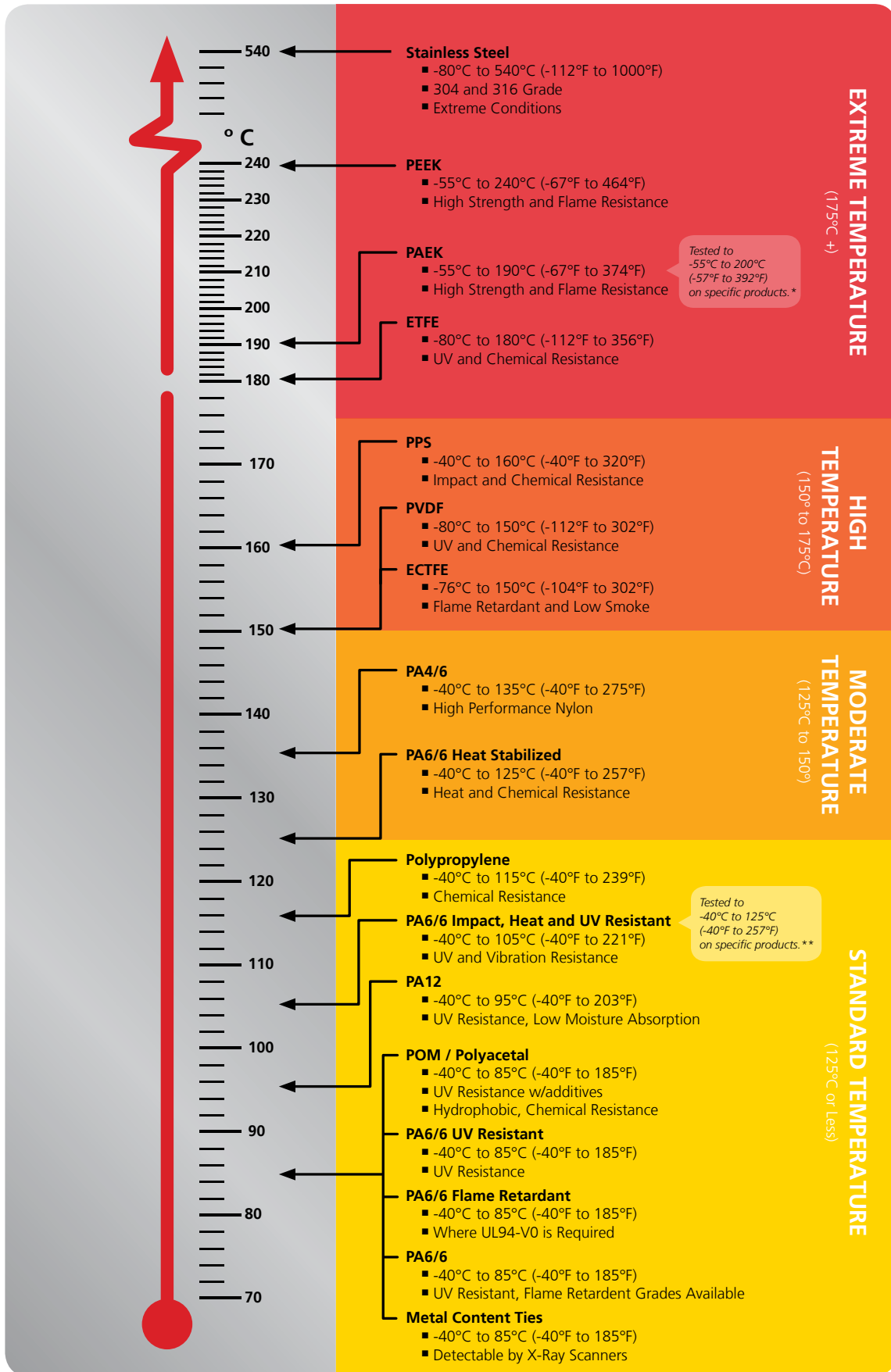

* Ratchet P-Clamps, Cable Ties and Fir Tree Assemblies
 ** Ratchet P-Clamps

Quality Certifications, Specification & Warranty

ISO 9001

The International Standards Organization (ISO) establishes worldwide standards for products and services in recognition of increasing globalization of markets. The ISO program determines the requirements for the quality assurance programs. HellermannTyton has achieved ISO 9001 certifications at all of its U.S. locations.

AS9100

AS9100 is a recognized standard for manufacturers maintaining a strict Quality Management System servicing the aerospace industry. HellermannTyton has achieved and maintains registration to this standard.

ISO/TS16949

ISO/TS16949 is a recognized standard for manufacturers maintaining a strict Quality Management System servicing the automotive industry. HellermannTyton has achieved and maintains certification to this standard.

International Electro-Technical Commision (IEC)

Representatives from key industry suppliers participate in creating standards that provide continuous improvement for products and services. HellermannTyton chaired the committee that created standard 62275 (replaced 1565) for Wire Positioning Devices.

ISO 14001

ISO/TS16949 is a recognized standard for manufacturers maintaining a strict Quality Management System servicing the automotive industry. HellermannTyton has achieved and maintains certification to this standard.

RoHS/WEEE

The scope of the European Union's Restriction of Hazardous Substances (RoHS) and the Waste Electrical and Electronic Equipment (WEEE) directives covers all electrical and electronic equipment and their components sold into the European Union. Throughout this catalog, you will see designations where materials are RoHS compliant.

In addition to the IEC62275, we are proud to offer our customers products which have been certified by well-known and independent laboratories such as:

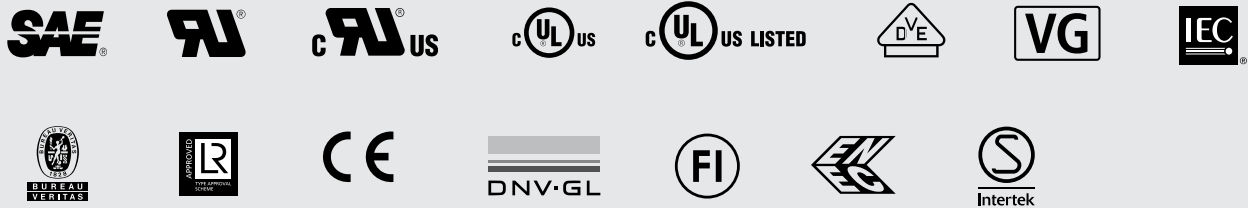

For California Proposition 65 information, please see our website.

Warranty Policy

HellermannTyton products are warranted to be free from defects in material and workmanship at the time sold by us; but our obligation under this warranty and that of the seller is limited to the replacement of the product, and neither we nor the seller are bound by any other warranty, expressed, implied or statutory. Under no circumstances are we or the seller liable for any loss, damage, expenses or consequential damages of any kind arising out of the use and/or inability to use these products. All are sold with the understanding that the user will test them in actual use and determine their adaptability for the intended use.

Optimum storage conditions for cable ties made of Polyamide (PA)

HellermannTyton cable ties and mounts are manufactured from high-quality polyamide (PA.) This industrial synthetic material is mainly processed using injection molding, but can also be extruded.

Polyamide is a hygroscopic material. This means that the material absorbs and loses moisture. For optimum handling of cable ties it is important that the material is in a condition of equilibrium with a water content of approximately 2.5%.

The packaging used by HellermannTyton ensures that the water content in the material remains constant. Therefore, it is important to store the products in their original packaging to preserve the quality of the ties and mounts.

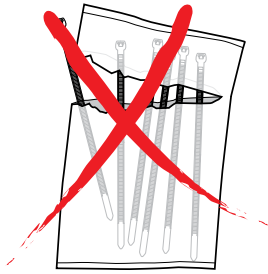

Once opened you should use the ties as quickly as possible



Do not expose the product to direct sunlight

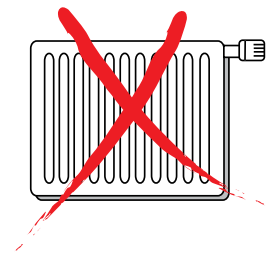

Store the product away from direct sources of heat

Ideal storage conditions:

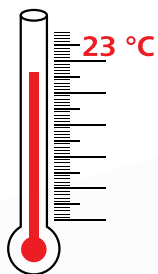

73°F

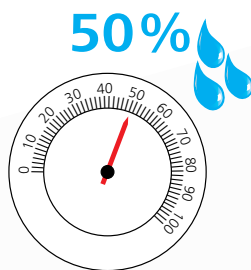

50% relative humidity



Bundling and Securing

Cable Ties

Standard Cable Ties

T18 - T30 Series in Natural and Black

T-Series Cable Ties feature inside serrations to provide a positive hold on wire and cable bundles. The head design guarantees high tensile strength and a low insertion force. The bent tail design allows quick and simple installations by hand. For high-volume applications, tensioning tools are available to ensure consistent and safe installation.

Features and Benefits

- Engineered and manufactured for maximum performance and quality.
- Made from 100% high-quality plastic to ensure efficient recycling.
- Inside serration for a strong grip onto bundles.
- Easy application either manually or with a tensioning tool.
- Bent tail allows for simpler insertion.

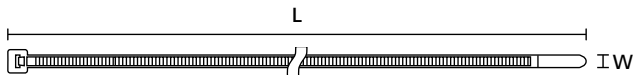
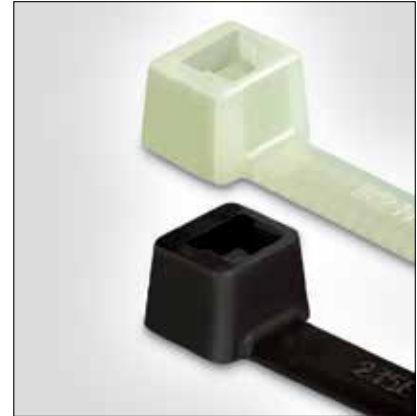

PART NO.	TYPE	Min. Tensile Strength lbs. (N)	Length (L) in. (mm)	Max. Bundle Diameter in. (mm)	Width (W) in. (mm)	Material	Color	Pkg. Qty.
T18I0C2*	T18I	18.0 (80.0)	5.5 (140.0)	1.4 (35.0)	0.1 (2.5)	PA66	Black	100
T18I0M4*		18.0 (80.0)	5.5 (140.0)	1.4 (35.0)	0.1 (2.5)	PA66	Black	1000
T18I9C2*		18.0 (80.0)	5.5 (140.0)	1.4 (35.0)	0.1 (2.5)	PA66	Natural	100
T18I9M4*		18.0 (80.0)	5.5 (140.0)	1.4 (35.0)	0.1 (2.5)	PA66	Natural	1000
T18L0C2*	T18L	18.0 (80.0)	8.0 (205.0)	2.2 (55.0)	0.1 (2.5)	PA66	Black	100
T18L0M4*		18.0 (80.0)	8.0 (205.0)	2.2 (55.0)	0.1 (2.5)	PA66	Black	1000
T18L9C2*		18.0 (80.0)	8.0 (205.0)	2.2 (55.0)	0.1 (2.5)	PA66	Natural	100
T18L9M4*		18.0 (80.0)	8.0 (205.0)	2.2 (55.0)	0.1 (2.5)	PA66	Natural	1000
T18R0C2*	T18R	18.0 (80.0)	4.0 (100.0)	0.9 (22.0)	0.1 (2.5)	PA66	Black	100
T18R0M4*		18.0 (80.0)	4.0 (100.0)	0.9 (22.0)	0.1 (2.5)	PA66	Black	1000
T18R9C2*		18.0 (80.0)	4.0 (100.0)	0.9 (22.0)	0.1 (2.5)	PA66	Natural	100
T18R9M4*		18.0 (80.0)	4.0 (100.0)	0.9 (22.0)	0.1 (2.5)	PA66	Natural	1000
T18S0C2*	T18S	18.0 (80.0)	3.3 (83.0)	0.6 (16.0)	0.1 (2.3)	PA66	Black	100
T18S0M4*		18.0 (80.0)	3.3 (83.0)	0.6 (16.0)	0.1 (2.3)	PA66	Black	1000
T18S9C2*		18.0 (80.0)	3.3 (83.0)	0.6 (16.0)	0.1 (2.3)	PA66	Natural	100
T18S9M4*		18.0 (80.0)	3.3 (83.0)	0.6 (16.0)	0.1 (2.3)	PA66	Natural	1000

Dimensions are approximate and subject to technical changes. Use Part No. for ordering and Type for specification purposes.

Installation tools: EVO7, EVO7SP, EVO9, EVO9HT, MK7P, MK7HT, MK9P. EVO9 and MK9P cannot be used with T18S cable ties. Military black available. Contact HellermannTyton for more information.

*This product meets UL standards. Please see appendix for specific file numbers.



Please note! Not all products listed on this page may have this approval. Please check our website for latest approvals.

Standard Cable Ties

T18 - T30 Series in Natural and Black

PART NO.	TYPE	Min. Tensile Strength lbs. (N)	Length (L) in. (mm)	Max. Bundle Diameter in. (mm)	Width (W) in. (mm)	Material	Color	Pkg. Qty.
T30L0C2*	T30L	30.0 (135.0)	7.8 (198.0)	2.0 (50.0)	0.1 (3.6)	PA66	Black	100
T30L0M4*		30.0 (135.0)	7.8 (198.0)	2.0 (50.0)	0.1 (3.6)	PA66	Black	1000
T30L9C2*		30.0 (135.0)	7.8 (198.0)	2.0 (50.0)	0.1 (3.6)	PA66	Natural	100
T30L9M4*		30.0 (135.0)	7.8 (198.0)	2.0 (50.0)	0.1 (3.6)	PA66	Natural	1000
T30LL0C2*	T30LL	30.0 (135.0)	11.4 (290.0)	3.2 (80.0)	0.1 (3.6)	PA66	Black	100
T30LL0M4*		30.0 (135.0)	11.4 (290.0)	3.2 (80.0)	0.1 (3.6)	PA66	Black	1000
T30LL9C2*		30.0 (135.0)	11.4 (290.0)	3.2 (80.0)	0.1 (3.6)	PA66	Natural	100
T30LL9M4*		30.0 (135.0)	11.4 (290.0)	3.2 (80.0)	0.1 (3.6)	PA66	Natural	1000
T30R0C2*	T30R	30.0 (135.0)	5.8 (148.0)	1.4 (35.0)	0.1 (3.6)	PA66	Black	100
T30R0M4*		30.0 (135.0)	5.8 (148.0)	1.4 (35.0)	0.1 (3.6)	PA66	Black	1000
T30R9C2*		30.0 (135.0)	5.8 (148.0)	1.4 (35.0)	0.1 (3.6)	PA66	Natural	100
T30R9M4*		30.0 (135.0)	5.8 (148.0)	1.4 (35.0)	0.1 (3.6)	PA66	Natural	1000
T30XL0C2*	T30XL	30.0 (135.0)	14.0 (365.0)	4.1 (104.9)	0.1 (3.6)	PA66	Black	100
T30XL0M4*		30.0 (135.0)	14.0 (365.0)	4.1 (104.9)	0.1 (3.6)	PA66	Black	1000
T30XL9C2*		30.0 (135.0)	14.0 (365.0)	4.1 (104.9)	0.1 (3.6)	PA66	Natural	100
T30XL9M4*		30.0 (135.0)	14.0 (365.0)	4.1 (104.9)	0.1 (3.6)	PA66	Natural	1000

Dimensions are approximate and subject to technical changes. Use Part No. for ordering and Type for specification purposes.

Installation tools: EVO7, EVO7SP, EVO9, EVO9HT, MK7P, MK7HT, MK9P. EVO9 and MK9P cannot be used with T18S cable ties. Military black available. Contact HellermannTyton for more information.

*This product meets UL standards. Please see appendix for specific file numbers.



Please note! Not all products listed on this page may have this approval. Please check our website for latest approvals.

Bundling and Securing

Cable Ties

Standard Cable Ties

T40 - T50 Series in Natural and Black

T-Series Cable Ties feature inside serrations to provide a positive hold on wire and cable bundles. The head design guarantees high tensile strength and a low insertion force. The bent tail design allows quick and simple installations by hand. For high-volume applications, tensioning tools are available to ensure consistent and safe installation.

Features and Benefits

- Engineered and manufactured for maximum performance and quality.
- Made from 100% high-quality plastic to ensure efficient recycling.
- Inside serration for a strong grip onto bundles.
- Easy application either manually or with a tensioning tool.
- Bent tail allows for simpler insertion.

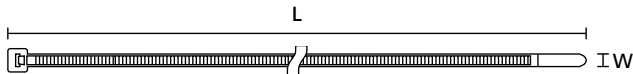
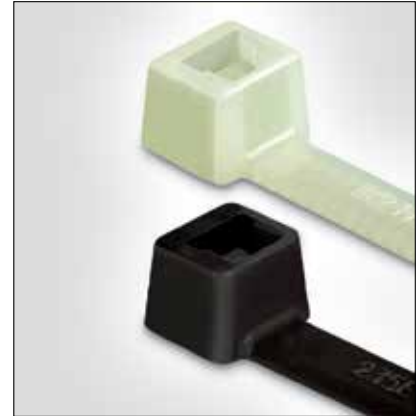

PART NO.	TYPE	Min. Tensile Strength lbs. (N)	Length (L) in. (mm)	Max. Bundle Diameter in. (mm)	Width (W) in. (mm)	Material	Color	Pkg. Qty.
T40R0C2*	T40R(U)	40.0 (180.0)	8.3 (212.0)	2.2 (55.9)	0.2 (4.0)	PA66	Black	100
T40R0M4*		40.0 (180.0)	8.3 (212.0)	2.2 (55.9)	0.2 (4.0)	PA66	Black	1000
T40R9C2*		40.0 (180.0)	8.3 (212.0)	2.2 (55.9)	0.2 (4.0)	PA66	Natural	100
T40R9M4*		40.0 (180.0)	8.3 (212.0)	2.2 (55.9)	0.2 (4.0)	PA66	Natural	1000
T40I0C2*	T40I	40.0 (180.0)	11.6 (295.0)	3.2 (80.0)	0.2 (4.0)	PA66	Black	100
T40I0M4*		40.0 (180.0)	11.6 (295.0)	3.2 (80.0)	0.2 (4.0)	PA66	Black	1000
T40I9C2*		40.0 (180.0)	11.6 (295.0)	3.2 (80.0)	0.2 (4.0)	PA66	Natural	100
T40I9M4*		40.0 (180.0)	11.6 (295.0)	3.2 (80.0)	0.2 (4.0)	PA66	Natural	1000
T40L0C2*	T40L	40.0 (180.0)	14.6 (370.0)	4.1 (104.9)	0.2 (4.0)	PA66	Black	100
T40L0M4*		40.0 (180.0)	14.6 (370.0)	4.1 (104.9)	0.2 (4.0)	PA66	Black	1000
T40L9C2*		40.0 (180.0)	14.6 (370.0)	4.1 (104.9)	0.2 (4.0)	PA66	Natural	100
T40L9M4*		40.0 (180.0)	14.6 (370.0)	4.1 (104.9)	0.2 (4.0)	PA66	Natural	1000
T50S0C2*	T50S	50.0 (225.0)	6.3 (160.0)	1.4 (35.0)	0.2 (4.6)	PA66	Black	100
T50S0M4*		50.0 (225.0)	6.3 (160.0)	1.4 (35.0)	0.2 (4.6)	PA66	Black	1000
T50S9C2*		50.0 (225.0)	6.3 (160.0)	1.4 (35.0)	0.2 (4.6)	PA66	Natural	100
T50S9M4*		50.0 (225.0)	6.3 (160.0)	1.4 (35.0)	0.2 (4.6)	PA66	Natural	1000

Dimensions are approximate and subject to technical changes. Use Part No. for ordering and Type for specification purposes.

Installation tools: EVO7, EVO7SP, EVO9, EVO9HT, MK7P, MK7HT, MK9P. Military black available. Contact HellermannTyton for more information. *This product meets UL standards. Please see appendix for specific file numbers. *This product meets UL standards. Please see appendix for specific file numbers.



Please note! Not all products listed on this page may have this approval. Please check our website for latest approvals.

Standard Cable Ties

T40 - T50 Series in Natural and Black

PART NO.	TYPE	Min. Tensile Strength lbs. (N)	Length (L) in. (mm)	Max. Bundle Diameter in. (mm)	Width (W) in. (mm)	Material	Color	Pkg. Qty.
T50R0C2*	T50R	50.0 (225.0)	8.0 (202.0)	2.0 (50.0)	0.2 (4.6)	PA66	Black	100
T50R0M4*		50.0 (225.0)	8.0 (202.0)	2.0 (50.0)	0.2 (4.6)	PA66	Black	1000
T50R9C2*		50.0 (225.0)	8.0 (202.0)	2.0 (50.0)	0.2 (4.6)	PA66	Natural	100
T50R9M4*		50.0 (225.0)	8.0 (202.0)	2.0 (50.0)	0.2 (4.6)	PA66	Natural	1000
T50I0C2*	T50I	50.0 (225.0)	12.0 (305.0)	3.2 (81.3)	0.2 (4.6)	PA66	Black	100
T50I0M4*		50.0 (225.0)	12.0 (305.0)	3.2 (81.3)	0.2 (4.6)	PA66	Black	1000
T50I9C2*		50.0 (225.0)	12.0 (305.0)	3.2 (81.3)	0.2 (4.6)	PA66	Natural	100
T50I9M4*		50.0 (225.0)	12.0 (305.0)	3.2 (81.3)	0.2 (4.6)	PA66	Natural	1000
T50L0C2*	T50L	50.0 (225.0)	15.4 (390.0)	4.3 (109.2)	0.2 (4.8)	PA66	Black	100
T50L0M4*		50.0 (225.0)	15.4 (390.0)	4.3 (109.2)	0.2 (4.8)	PA66	Black	1000
T50L9C2*		50.0 (225.0)	15.4 (390.0)	4.3 (109.2)	0.2 (4.8)	PA66	Natural	100
T50L9M4*		50.0 (225.0)	15.4 (390.0)	4.3 (109.2)	0.2 (4.8)	PA66	Natural	1000

Dimensions are approximate and subject to technical changes. Use Part No. for ordering and Type for specification purposes.

Installation tools: EVO7, EVO7SP, EVO9, EVO9HT, MK7P, MK7HT, MK9P. Military black available. Contact HellermannTyton for more information. *This product meets UL standards. Please see appendix for specific file numbers. *This product meets UL standards. Please see appendix for specific file numbers.



Please note! Not all products listed on this page may have this approval. Please check our website for latest approvals.

Bundling and Securing

Cable Ties

Standard Cable Ties

T18R and T30R Series in Colors

T-Series Cable Ties feature inside serrations to provide a positive hold on wire and cable bundles. The head design guarantees high tensile strength and a low insertion force. The bent tail design allows quick and simple installations by hand. For high-volume applications, tensioning tools are available to ensure consistent and safe installation.

Features and Benefits

- Engineered and manufactured for maximum performance and quality.
- Made from 100% high-quality plastic to ensure efficient recycling.
- Inside serration for a strong grip onto bundles.
- Easy application either manually or with a tensioning tool.
- Bent tail allows for simpler insertion.

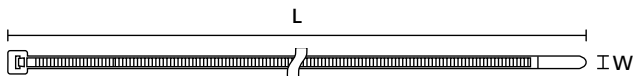

PART NO.	TYPE	Min. Tensile Strength lbs. (N)	Length (L) in. (mm)	Max. Bundle Diameter in. (mm)	Width (W) in. (mm)	Material	Color	Pkg. Qty.
116-01816	T18R	18.0 (80.0)	4.0 (100.0)	0.9 (22.0)	0.1 (2.5)	PA66	Blue	100
T18R6M4*		18.0 (80.0)	4.0 (100.0)	0.9 (22.0)	0.1 (2.5)	PA66	Blue	1000
111-01933		18.0 (80.0)	4.0 (100.0)	0.9 (22.0)	0.1 (2.5)	PA66	Brown	100
T18R1M4*		18.0 (80.0)	4.0 (100.0)	0.9 (22.0)	0.1 (2.5)	PA66	Brown	1000
116-01818		18.0 (80.0)	4.0 (100.0)	0.9 (22.0)	0.1 (2.5)	PA66	Gray	100
T18R8M4*		18.0 (80.0)	4.0 (100.0)	0.9 (22.0)	0.1 (2.5)	PA66	Gray	1000
116-01815		18.0 (80.0)	4.0 (100.0)	0.9 (22.0)	0.1 (2.5)	PA66	Green	100
T18R5M4*		18.0 (80.0)	4.0 (100.0)	0.9 (22.0)	0.1 (2.5)	PA66	Green	1000
111-01934		18.0 (80.0)	4.0 (100.0)	0.9 (22.0)	0.1 (2.5)	PA66	Orange	100
T18R3M4*		18.0 (80.0)	4.0 (100.0)	0.9 (22.0)	0.1 (2.5)	PA66	Orange	1000
T18R7M4*		18.0 (80.0)	4.0 (100.0)	0.9 (22.0)	0.1 (2.5)	PA66	Purple	1000
116-01812		18.0 (80.0)	4.0 (100.0)	0.9 (22.0)	0.1 (2.5)	PA66	Red	100
T18R2M4*		18.0 (80.0)	4.0 (100.0)	0.9 (22.0)	0.1 (2.5)	PA66	Red	1000
111-01935		18.0 (80.0)	4.0 (100.0)	0.9 (22.0)	0.1 (2.5)	PA66	Violet	100
111-01936		18.0 (80.0)	4.0 (100.0)	0.9 (22.0)	0.1 (2.5)	PA66	White	100
T18R10M4*		18.0 (80.0)	4.0 (100.0)	0.9 (22.0)	0.1 (2.5)	PA66	White	1000
116-01814		18.0 (80.0)	4.0 (100.0)	0.9 (22.0)	0.1 (2.5)	PA66	Yellow	100
T18R4M4*		18.0 (80.0)	4.0 (100.0)	0.9 (22.0)	0.1 (2.5)	PA66	Yellow	1000

Dimensions are approximate and subject to technical changes. Use Part No. for ordering and Type for specification purposes. Installation tools: EVO7 and EVO7SP. *This product meets UL standards. Please see appendix for specific file numbers.



Please note! Not all products listed on this page may have this approval. Please check our website for latest approvals.

Standard Cable Ties

T18R and T30R Series in Colors

PART NO.	TYPE	Min. Tensile Strength lbs. (N)	Length (L) in. (mm)	Max. Bundle Diameter in. (mm)	Width (W) in. (mm)	Material	Color	Pkg. Qty.
T30R6C2*	T30R	30.0 (135.0)	5.8 (148.0)	1.4 (35.0)	0.1 (3.6)	PA66	Blue	100
T30R6M4*		30.0 (135.0)	5.8 (148.0)	1.4 (35.0)	0.1 (3.6)	PA66	Blue	1000
T30R1C2*		30.0 (135.0)	5.8 (148.0)	1.4 (35.0)	0.1 (3.6)	PA66	Brown	100
T30R1M4*		30.0 (135.0)	5.8 (148.0)	1.4 (35.0)	0.1 (3.6)	PA66	Brown	1000
T30R8C2*		30.0 (135.0)	5.8 (148.0)	1.4 (35.0)	0.1 (3.6)	PA66	Gray	100
T30R8M4*		30.0 (135.0)	5.8 (148.0)	1.4 (35.0)	0.1 (3.6)	PA66	Gray	1000
T30R5C2*		30.0 (135.0)	5.8 (148.0)	1.4 (35.0)	0.1 (3.6)	PA66	Green	100
T30R5M4*		30.0 (135.0)	5.8 (148.0)	1.4 (35.0)	0.1 (3.6)	PA66	Green	1000
T30R3C2*		30.0 (135.0)	5.8 (148.0)	1.4 (35.0)	0.1 (3.6)	PA66	Orange	100
T30R3M4*		30.0 (135.0)	5.8 (148.0)	1.4 (35.0)	0.1 (3.6)	PA66	Orange	1000
T30R7C2*		30.0 (135.0)	5.8 (148.0)	1.4 (35.0)	0.1 (3.6)	PA66	Purple	100
T30R7M4*		30.0 (135.0)	5.8 (148.0)	1.4 (35.0)	0.1 (3.6)	PA66	Purple	1000
T30R2C2*		30.0 (135.0)	5.8 (148.0)	1.4 (35.0)	0.1 (3.6)	PA66	Red	100
T30R2M4*		30.0 (135.0)	5.8 (148.0)	1.4 (35.0)	0.1 (3.6)	PA66	Red	1000
T30R10C2*		30.0 (135.0)	5.8 (148.0)	1.4 (35.0)	0.1 (3.6)	PA66	White	100
T30R10M4*		30.0 (135.0)	5.8 (148.0)	1.4 (35.0)	0.1 (3.6)	PA66	White	1000
T30R4C2*		30.0 (135.0)	5.8 (148.0)	1.4 (35.0)	0.1 (3.6)	PA66	Yellow	100
T30R4M4*		30.0 (135.0)	5.8 (148.0)	1.4 (35.0)	0.1 (3.6)	PA66	Yellow	1000

Dimensions are approximate and subject to technical changes. Use Part No. for ordering and Type for specification purposes.
 Installation tools: EVO7 and EVO7SP. *This product meets UL standards. Please see appendix for specific file numbers.



Please note! Not all products listed on this page may have this approval. Please check our website for latest approvals.

Bundling and Securing

Cable Ties

Standard Cable Ties

T50R and T50L Series in Colors

T-Series Cable Ties feature inside serrations to provide a positive hold on wire and cable bundles. The head design guarantees high tensile strength and a low insertion force. The bent tail design allows quick and simple installations by hand. For high-volume applications, tensioning tools are available to ensure consistent and safe installation.

Features and Benefits

- Engineered and manufactured for maximum performance and quality.
- Made from 100% high-quality plastic to ensure efficient recycling.
- Inside serration for a strong grip onto bundles.
- Easy application either manually or with a tensioning tool.
- Bent tail allows for simpler insertion.

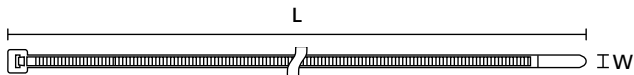

PART NO.	TYPE	Min. Tensile Strength lbs. (N)	Length (L) in. (mm)	Max. Bundle Diameter in. (mm)	Width (W) in. (mm)	Material	Color	Pkg. Qty.
T50R6C2*	T50R	50.0 (225.0)	8.0 (202.0)	2.0 (50.0)	0.2 (4.6)	PA66	Blue	100
T50R6M4*		50.0 (225.0)	8.0 (202.0)	2.0 (50.0)	0.2 (4.6)	PA66	Blue	1000
T50R1C2*		50.0 (225.0)	8.0 (202.0)	2.0 (50.0)	0.2 (4.6)	PA66	Brown	100
T50R1M4*		50.0 (225.0)	8.0 (202.0)	2.0 (50.0)	0.2 (4.6)	PA66	Brown	1000
T50R8C2*		50.0 (225.0)	8.0 (202.0)	2.0 (50.0)	0.2 (4.6)	PA66	Gray	100
T50R8M4*		50.0 (225.0)	8.0 (202.0)	2.0 (50.0)	0.2 (4.6)	PA66	Gray	1000
T50R5C2*		50.0 (225.0)	8.0 (202.0)	2.0 (50.0)	0.2 (4.6)	PA66	Green	100
T50R5M4*		50.0 (225.0)	8.0 (202.0)	2.0 (50.0)	0.2 (4.6)	PA66	Green	1000
T50R3C2*		50.0 (225.0)	8.0 (202.0)	2.0 (50.0)	0.2 (4.6)	PA66	Orange	100
T50R3M4*		50.0 (225.0)	8.0 (202.0)	2.0 (50.0)	0.2 (4.6)	PA66	Orange	1000
T50R7C2*		50.0 (225.0)	8.0 (202.0)	2.0 (50.0)	0.2 (4.6)	PA66	Purple	100
T50R7M4*		50.0 (225.0)	8.0 (202.0)	2.0 (50.0)	0.2 (4.6)	PA66	Purple	1000
T50R2C2*		50.0 (225.0)	8.0 (202.0)	2.0 (50.0)	0.2 (4.6)	PA66	Red	100
T50R2M4*		50.0 (225.0)	8.0 (202.0)	2.0 (50.0)	0.2 (4.6)	PA66	Red	1000
T50R10C2*		50.0 (225.0)	8.0 (202.0)	2.0 (50.0)	0.2 (4.6)	PA66	White	100
T50R10M4*		50.0 (225.0)	8.0 (202.0)	2.0 (50.0)	0.2 (4.6)	PA66	White	1000
T50R4C2*		50.0 (225.0)	8.0 (202.0)	2.0 (50.0)	0.2 (4.6)	PA66	Yellow	100
T50R4M4*		50.0 (225.0)	8.0 (202.0)	2.0 (50.0)	0.2 (4.6)	PA66	Yellow	1000

Dimensions are approximate and subject to technical changes. Use Part No. for ordering and Type for specification purposes.

Installation tools: EVO7, EVO7SP, EVO9, EVO9HT, MK7P, MK7HT, MK9P. *This product meets UL standards. Please see appendix for specific file numbers.



Please note! Not all products listed on this page may have this approval. Please check our website for latest approvals.

Standard Cable Ties

T50L and T50R Series in Colors

PART NO.	TYPE	Min. Tensile Strength lbs. (N)	Length (L) in. (mm)	Max. Bundle Diameter in. (mm)	Width (W) in. (mm)	Material	Color	Pkg. Qty.
T50L6C2*	T50L	50.0 (225.0)	15.4 (390.0)	4.3 (109.2)	0.2 (4.8)	PA66	Blue	100
T50L6M4*		50.0 (225.0)	15.4 (390.0)	4.3 (109.2)	0.2 (4.8)	PA66	Blue	1000
T50L1C2*		50.0 (225.0)	15.4 (390.0)	4.3 (109.2)	0.2 (4.8)	PA66	Brown	100
T50L8C2*		50.0 (225.0)	15.4 (390.0)	4.3 (109.2)	0.2 (4.8)	PA66	Gray	100
T50L8M4*		50.0 (225.0)	15.4 (390.0)	4.3 (109.2)	0.2 (4.8)	PA66	Gray	1000
T50L5C2*		50.0 (225.0)	15.4 (390.0)	4.3 (109.2)	0.2 (4.8)	PA66	Green	100
T50L5M4*		50.0 (225.0)	15.4 (390.0)	4.3 (109.2)	0.2 (4.8)	PA66	Green	1000
T50L3C2*		50.0 (225.0)	15.4 (390.0)	4.3 (109.2)	0.2 (4.8)	PA66	Orange	100
T50L3M4*		50.0 (225.0)	15.4 (390.0)	4.3 (109.2)	0.2 (4.8)	PA66	Orange	1000
T50L2C2*		50.0 (225.0)	15.4 (390.0)	4.3 (109.2)	0.2 (4.8)	PA66	Red	100
T50L2M4*		50.0 (225.0)	15.4 (390.0)	4.3 (109.2)	0.2 (4.8)	PA66	Red	1000
T50L10C2*		50.0 (225.0)	15.4 (390.0)	4.3 (109.2)	0.2 (4.8)	PA66	White	100
T50L10M4*		50.0 (225.0)	15.4 (390.0)	4.3 (109.2)	0.2 (4.8)	PA66	White	1000
T50L4C2*		50.0 (225.0)	15.4 (390.0)	4.3 (109.2)	0.2 (4.8)	PA66	Yellow	100
T50L4M4*		50.0 (225.0)	15.4 (390.0)	4.3 (109.2)	0.2 (4.8)	PA66	Yellow	1000

Dimensions are approximate and subject to technical changes. Use Part No. for ordering and Type for specification purposes.

Installation tools: EVO7, EVO7SP, EVO9, EVO9HT, MK7P, MK7HT, MK9P. *This product meets UL standards. Please see appendix for specific file numbers.



Please note! Not all products listed on this page may have this approval. Please check our website for latest approvals.

Bundling and Securing

Cable Ties

Cable Ties in Special Materials

T18 - T150 Series, Heat Stabilized

HellermannTyton's heat stabilized cable ties provide excellent resistance when exposed to high heat. T-Series Cable Ties feature inside serrations to provide a positive hold on wire and cable bundles. The head design guarantees high tensile strength and a low insertion force. The bent tail design allows quick and simple installations by hand. For high-volume applications, tensioning tools are available to ensure consistent and safe installation.

Features and Benefits

- Heat-stabilized cable ties deliver high heat resistance.
- Inside serrations provide strong grip on cables and wire bundles.
- Easy application either manually or with a tensioning tool.
- Bent tail ensures a quick and simple installation.

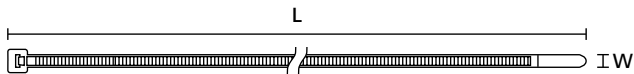

PART NO.	TYPE	Min. Tensile Strength lbs. (N)	Length (L) in. (mm)	Max. Bundle Diameter in. (mm)	Width (W) in. (mm)	Material	Color	Pkg. Qty.
T1850HSM4*	T18S	18.0 (80.0)	3.3 (83.0)	0.6 (16.0)	0.1 (2.3)	PA66HS	Black	1000
T18R0HSC2*	T18R	18.0 (80.0)	4.0 (100.0)	0.9 (22.0)	0.1 (2.5)	PA66HS	Black	100
T18R0HSM4*		18.0 (80.0)	4.0 (100.0)	0.9 (22.0)	0.1 (2.5)	PA66HS	Black	1000
T18I0HSM4*	T18I	18.0 (80.0)	5.5 (140.0)	1.4 (35.0)	0.1 (2.5)	PA66HS	Black	1000
T18L0HSC2*	T18L	18.0 (80.0)	8.0 (203.2)	2.2 (55.0)	0.1 (2.5)	PA66HS	Black	100
T18L0HSM4*		18.0 (80.0)	8.0 (203.2)	2.2 (55.0)	0.1 (2.5)	PA66HS	Black	1000
T30R0HSC2*	T30R	30.0 (135.0)	5.8 (148.0)	1.4 (35.0)	0.1 (3.6)	PA66HS	Black	100
T30R0HSM4*		30.0 (135.0)	5.8 (148.0)	1.4 (35.0)	0.1 (3.6)	PA66HS	Black	1000
T30L0HSM4*	T30LL	30.0 (135.0)	11.4 (290.0)	3.2 (80.0)	0.1 (3.6)	PA66HS	Black	1000
T40R0HSM4*	T40R(U)	40.0 (180.0)	8.3 (212.0)	2.2 (55.9)	0.2 (4.0)	PA66HS	Black	1000
T40L0HSC2*	T40L	40.0 (180.0)	14.6 (370.0)	4.1 (104.9)	0.2 (4.0)	PA66HS	Black	100
T50R0HSC2*	T50R	50.0 (225.0)	8.0 (203.2)	2.0 (50.0)	0.2 (4.6)	PA66HS	Black	100
T50R0HSM4*		50.0 (225.0)	8.0 (203.2)	2.0 (50.0)	0.2 (4.6)	PA66HS	Black	1000
T50I0HSC2*	T50I	50.0 (225.0)	12.0 (305.0)	3.2 (81.3)	0.2 (4.6)	PA66HS	Black	100
T50I0HSM4*		50.0 (225.0)	12.0 (305.0)	3.2 (81.3)	0.2 (4.6)	PA66HS	Black	1000
T50L0HSC2*	T50L	50.0 (225.0)	15.4 (390.0)	4.3 (109.2)	0.2 (4.8)	PA66HS	Black	100
T50L0HSM4*		50.0 (225.0)	15.4 (390.0)	4.3 (109.2)	0.2 (4.8)	PA66HS	Black	1000

Dimensions are approximate and subject to technical changes. Use Part No. for ordering and Type for specification purposes.

Installation tools: EVO7, EVO7SP, EVO9, EVO9HT, MK7P, MK7HT, MK9P. EVO9 and MK9P cannot be used with T18S cable ties. *This product meets UL standards. Please see appendix for specific file numbers.



Please note! Not all products listed on this page may have this approval. Please check our website for latest approvals.

Cable Ties in Special Materials

T18 - T150 Series, Heat Stabilized

PART NO.	TYPE	Min. Tensile Strength lbs. (N)	Length (L) in. (mm)	Max. Bundle Diameter in. (mm)	Width (W) in. (mm)	Material	Color	Pkg. Qty.
T120S0HSH4*	T120S	120.0 (535.0)	8.9 (225.0)	2.2 (55.9)	0.3 (7.6)	PA66HS	Black	500
T120I0HSH4*	T120I	120.0 (535.0)	11.8 (300.0)	3.2 (81.3)	0.3 (7.6)	PA66HS	Black	500
T120R0HSK2*	T120R	120.0 (535.0)	15.2 (387.0)	4.1 (104.1)	0.3 (7.6)	PA66HS	Black	50
T120R0HSH4*		120.0 (535.0)	15.2 (387.0)	4.1 (104.1)	0.3 (7.6)	PA66HS	Black	500
T120L0HSK2*	T120L	120.0 (535.0)	30.0 (760.0)	8.9 (224.8)	0.3 (7.6)	PA66HS	Black	50
T150M0HSX2*	T150M	175.0 (780.0)	21.0 (530.0)	5.9 (150.0)	0.4 (8.9)	PA66HS	Black	25
T150XL0HSX2*	T150XL	175.0 (780.0)	43.1 (1,095.0)	13.0 (330.2)	0.4 (8.9)	PA66HS	Black	25

Dimensions are approximate and subject to technical changes. Use Part No. for ordering and Type for specification purposes.

Installation tools: EVO7, EVO7SP, EVO9, EVO9HT, MK7P, MK7HT, MK9P. EVO9 and MK9P cannot be used with T18S cable ties. *This product meets UL standards. Please see appendix for specific file numbers.



Please note! Not all products listed on this page may have this approval. Please check our website for latest approvals.

Bundling and Securing

Cable Ties

Cable Ties in Special Materials

High-Temperature Ties in PA46

HellermannTyton's high-temperature cable ties provide excellent resistance in operating temperatures up to 275°F (135°C), while still maintaining tensile strength properties. T-Series Cable Ties feature inside serrations to provide a positive hold on wire and cable bundles. The head design guarantees high tensile strength and a low insertion force. The bent tail design allows quick and simple installations by hand. For high-volume applications, tensioning tools are available to ensure consistent and safe installation.

Features and Benefits

- PA46 cable ties deliver high heat resistance.
- Inside serrations provide strong grip on cables and wire bundles.
- Easy application either manually or with a tensioning tool.
- Bent tail ensures a quick and simple installation.

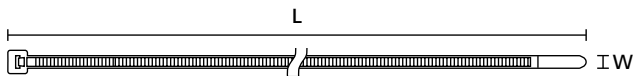

PART NO.	TYPE	Min. Tensile Strength lbs. (N)	Length (L) in. (mm)	Max. Bundle Diameter in. (mm)	Width (W) in. (mm)	Material	Color	Pkg. Qty.
111-00968	T30R	30.0 (135.0)	5.8 (148.0)	1.4 (35.0)	0.1 (3.6)	PA46	Gray	100
111-01459		30.0 (135.0)	5.8 (148.0)	1.4 (35.0)	0.1 (3.6)	PA46	Gray	1000
111-01703	T50R	50.0 (225.0)	8.0 (202.0)	2.0 (50.0)	0.2 (4.6)	PA46	Brown	1000
111-01568		50.0 (225.0)	8.0 (202.0)	2.0 (50.0)	0.2 (4.6)	PA46	Gray	1000
111-00815		50.0 (225.0)	8.0 (202.0)	2.0 (50.0)	0.2 (4.6)	PA46	Natural	100
T50L15TNLM4	T50L	50.0 (225.0)	15.4 (390.0)	4.3 (109.2)	0.2 (4.8)	PA46	Brown	1000
111-01619	T120I	120.0 (535.0)	11.8 (300.0)	3.2 (81.3)	0.3 (7.6)	PA46	Brown	500
111-00966	T150R(U)	175.0 (780.0)	15.4 (390.0)	4.1 (104.1)	0.4 (8.9)	PA46	Brown	25
111-00965	T150M	175.0 (780.0)	21.0 (530.0)	5.9 (150.0)	0.4 (8.9)	PA46	Brown	25

Dimensions are approximate and subject to technical changes. Use Part No. for ordering and Type for specification purposes.
Installation tools: EVO7, EVO7SP, EVO9, EVO9HT, MK7P, MK7HT, MK9P.

Cable Ties in Special Materials

PEEK Cable Ties

PEEK Ties withstand temperatures from -67 to 464°F and provide excellent resistance to chemicals, acids, radiation and abrasion. The low-profile, contoured head takes up less space and protects sensitive wires running adjacent to it.

Features and Benefits

- Extreme temperature range for excellent performance in a range of environments.
- Low-profile, contoured head takes up less space and protects sensitive wires.
- Delivers the performance of a metal tie with the ease of use of plastic.

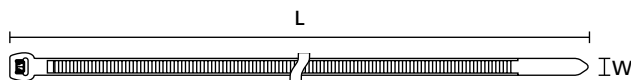

PART NO.	TYPE	Min. Tensile Strength lbs. (N)	Length (L) in. (mm)	Max. Bundle Diameter in. (mm)	Width (W) in. (mm)	Material	Color	Pkg. Qty.
118-00032	PT2A	52.0 (230.0)	5.7 (145.0)	1.4 (35.0)	0.1 (3.4)	PEEK	Beige	100
111-01235	PT220	85.0 (380.0)	8.7 (220.0)	2.2 (56.0)	0.2 (4.7)	PEEK	Beige	100

Dimensions are approximate and subject to technical changes. Use Part No. for ordering and Type for specification purposes.
Installation tools: EVO7, EVO7SP, EVO9, EVO9HT, MK7P, MK7HT, MK9P.



Please note! Not all products listed on this page may have this approval. Please check our website for latest approvals.

Bundling and Securing

Cable Ties

Cable Ties in Special Materials

PAEK Cable Ties

HellermannTyton PAEK cable ties offer very high temperature resistance for use in demanding applications such as in engine compartments, near exhaust, and in enclosed industrial cabinets. PAEK ties are inside serrated and feature a high performance design that, along with the material, offer extremely high tensile strength for demanding applications.

Features and Benefits

- Very high heat resistance up to 200°C (392°F).
- PAEK material has double the tensile strength than nylon.
- PAEK material offers very good chemical resistance against hydrocarbons.

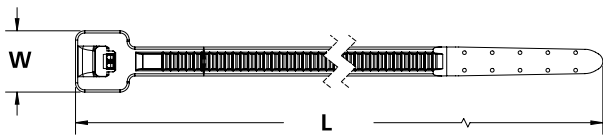

PART NO.	TYPE	Min. Tensile Strength lbs. (N)	Length (L) in. (mm)	Max. Bundle Diameter in. (mm)	Width (W) in. (mm)	Material	Color	Pkg. Qty.
111-01670	PAT100R	100.0 (445.0)	5.9 (149.9)	1.4 (35.0)	0.3 (8.0)	PAEK	Beige	100
111-01699	PAT100L	100.0 (445.0)	7.9 (200.7)	2.0 (50.8)	0.3 (8.0)	PAEK	Beige	100

Dimensions are approximate and subject to technical changes. Use Part No. for ordering and Type for specification purposes.
Installation tools: EVO7, EVO7SP, EVO9, EVO9HT, MK7P, MK7HT, MK9P.

Cable Ties in Special Materials

UV Stabilized Cable Ties

Used in the solar industry and other applications, HellermannTyton offers cable ties made of UV stabilized PA66UV material. This material provides additional protection against UV radiation for long-term outdoor use and is available in various styles, tensile strengths, and bundle diameters. T-Series Cable Ties feature inside serrations to provide a positive hold on wire and cable bundles. The head design guarantees high tensile strength and a low insertion force. The bent tail design allows quick and simple installations by hand. For high-volume applications, tensioning tools are available to ensure consistent and safe installation.



Features and Benefits

- UV stabilized cable ties are designed for extended use outdoors.
- Inside serrations provide strong grip on cables and wire bundles.
- Easy application either manually or with a tensioning tool.
- Bent tail ensures a quick and simple installation.

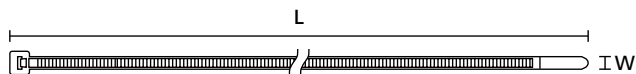

PART NO.	TYPE	Min. Tensile Strength lbs. (N)	Length (L) in. (mm)	Max. Bundle Diameter in. (mm)	Width (W) in. (mm)	Material	Color	Pkg. Qty.
T18R0UVM4*	T18R	18.0 (80.0)	4.0 (100.0)	0.9 (22.0)	0.1 (2.5)	PA66UV	Black	1000
T18R0UVC2*		18.0 (80.0)	4.0 (100.0)	0.9 (22.0)	0.1 (2.5)	PA66UV	Black	100
T30R0UVM4*	T30R	30.0 (135.0)	5.8 (148.0)	1.4 (35.0)	0.1 (3.6)	PA66UV	Black	1000
T30R0UVC2*		30.0 (135.0)	5.8 (148.0)	1.4 (35.0)	0.1 (3.6)	PA66UV	Black	100
T30L0UVM4*	T30L	30.0 (135.0)	7.8 (198.0)	2.0 (50.8)	0.1 (3.6)	PA66UV	Black	1000
T30L0UVC2*		30.0 (135.0)	7.8 (198.0)	2.0 (50.8)	0.1 (3.6)	PA66UV	Black	100
T50R0UVM4*	T50R	50.0 (225.0)	8.0 (202.0)	2.0 (50.0)	0.2 (4.6)	PA66UV	Black	1000
T50R0UVC2*		50.0 (225.0)	8.0 (202.0)	2.0 (50.0)	0.2 (4.6)	PA66UV	Black	100
T50I0UVC2*	T50I	50.0 (225.0)	12.0 (305.0)	3.2 (81.3)	0.2 (4.6)	PA66UV	Black	100
T50I0UVM4*		50.0 (225.0)	12.0 (305.0)	3.2 (81.3)	0.2 (4.6)	PA66UV	Black	1000
T50L0UVM4*	T50L	50.0 (225.0)	15.4 (390.0)	4.3 (109.2)	0.2 (4.8)	PA66UV	Black	1000
T50L0UVC2*		50.0 (225.0)	15.4 (390.0)	4.3 (109.2)	0.2 (4.8)	PA66UV	Black	100
T120S0UVC2*	T120S	120.0 (535.0)	8.9 (225.0)	2.2 (55.9)	0.3 (7.6)	PA66UV	Black	50
T120I0UVC2*	T120I	120.0 (535.0)	11.8 (300.0)	3.2 (81.3)	0.3 (7.6)	PA66UV	Black	50
T120R0UVM4*	T120R	120.0 (535.0)	15.2 (387.0)	4.1 (104.1)	0.3 (7.6)	PA66UV	Black	500
T120R0UVC2*		120.0 (535.0)	15.2 (387.0)	4.1 (104.1)	0.3 (7.6)	PA66UV	Black	100
T120L0UVC2*	T120L	120.0 (535.0)	30.0 (760.0)	8.9 (224.8)	0.3 (7.6)	PA66UV	Black	50

Dimensions are approximate and subject to technical changes. Use Part No. for ordering and Type for specification purposes.

Installation tools: EVO7, EVO7SP, EVO9, EVO9HT, MK7P, MK7HT, MK9P. *This product meets UL standards. Please see appendix for specific file numbers.



Please note! Not all products listed on this page may have this approval. Please check our website for latest approvals.

Bundling and Securing

Cable Ties

Cable Ties in Special Materials

UV Stabilized Cable Ties

PART NO.	TYPE	Min. Tensile Strength lbs. (N)	Length (L) in. (mm)	Max. Bundle Diameter in. (mm)	Width (W) in. (mm)	Material	Color	Pkg. Qty.
T150R0UVX2*	T150R(U)	175.0 (780.0)	15.4 (390.0)	4.1 (104.1)	0.4 (8.9)	PA66UV	Black	25
T150M0UVX2*	T150M	175.0 (780.0)	21.0 (530.0)	5.9 (150.0)	0.4 (8.9)	PA66UV	Black	25
T150L0UVX2*	T150L	175.0 (780.0)	32.3 (820.0)	9.6 (243.8)	0.4 (8.9)	PA66UV	Black	25
T150LL0UVX2*	T150LL	175.0 (780.0)	36.4 (925.0)	10.8 (274.3)	0.4 (8.9)	PA66UV	Black	25
T150XL0UVX2*	T150XL	175.0 (780.0)	43.1 (1,095.0)	13.0 (330.2)	0.4 (8.9)	PA66UV	Black	25
T150XLL0UVX2*	T150XLL	175.0 (780.0)	52.2 (1,325.0)	16.0 (406.4)	0.4 (8.9)	PA66UV	Black	25
111-00925*	T250M	250.0 (1,115.0)	22.3 (565.3)	5.9 (150.0)	0.5 (12.4)	PA66UV	Black	25

Dimensions are approximate and subject to technical changes. Use Part No. for ordering and Type for specification purposes.

Installation tools: EVO7, EVO7SP, EVO9, EVO9HT, MK7P, MK7HT, MK9P. *This product meets UL standards. Please see appendix for specific file numbers.



Please note! Not all products listed on this page may have this approval. Please check our website for latest approvals.

Cable Ties in Special Materials

High Impact, Heat and UV Stabilized Cable Ties

Manufactured from a specially formulated impact-resistant, heat and UV stabilized PA66 material, these cable ties offer increased flexibility, impact strength, heat and UV resistance to endure moisture fluctuations. T-Series Cable Ties feature inside serrations to provide a positive hold on wire and cable bundles. The head design guarantees high tensile strength and a low insertion force. The bent tail design allows quick and simple installations by hand. For high-volume applications, tensioning tools are available to ensure consistent and safe installation.



Features and Benefits

- High impact, heat and UV stabilized cable ties contain an impact modifier allowing greater flexibility and greater resistance to vibration.
- Inside serrations allow for strong grip on cables and wire bundles.
- Head design provides high tensile strength with very low insertion force.
- Bent tail ensures a quick and simple installation.

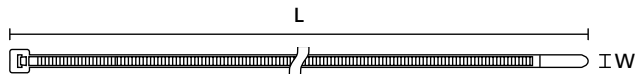

PART NO.	TYPE	Min. Tensile Strength lbs. (N)	Length (L) in. (mm)	Max. Bundle Diameter in. (mm)	Width (W) in. (mm)	Material	Color	Pkg. Qty.
T30R0HIRM4*	T30R	30.0 (135.0)	5.8 (148.0)	1.4 (35.0)	0.1 (3.6)	PA66HIRHSUV	Black	1000
T50R0HIRM4*	T50R	50.0 (225.0)	8.0 (202.0)	2.0 (50.0)	0.2 (4.6)	PA66HIRHSUV	Black	1000
111-00931*		50.0 (225.0)	8.0 (202.0)	2.0 (50.0)	0.2 (4.6)	PA66HIRHSUV	Black	500
111-01601*	T50I	50.0 (225.0)	12.0 (305.0)	3.2 (81.3)	0.2 (4.6)	PA66HIRHSUV	Black	1000
111-01128*	T50L	50.0 (225.0)	15.4 (390.0)	4.3 (109.2)	0.2 (4.8)	PA66HIRHSUV	Black	1000
111-01138*	T120S	120.0 (535.0)	8.9 (225.0)	2.2 (55.9)	0.3 (7.6)	PA66HIRHSUV	Black	500
T120I0HIRUVH4*	T120I	120.0 (535.0)	11.8 (300.0)	3.2 (81.3)	0.3 (7.6)	PA66HIRHSUV	Black	500
T250R0HIRUVX2*	T250R	250.0 (1,115.0)	20.3 (515.0)	4.9 (124.5)	0.5 (12.4)	PA66HIRHSUV	Black	25
111-01196*	T250M	250.0 (1,115.0)	22.3 (565.3)	5.9 (150.0)	0.5 (12.4)	PA66HIRHSUV	Black	25
111-01126*	T250XL	250.0 (1,115.0)	40.6 (1,030.0)	12.0 (304.8)	0.5 (12.4)	PA66HIRHSUV	Black	25

Dimensions are approximate and subject to technical changes. Use Part No. for ordering and Type for specification purposes.

Installation tools: EVO7, EVO7SP, EVO9, EVO9HT, MK7P, MK7HT, MK9P. *This product meets UL standards. Please see appendix for specific file numbers.



Please note! Not all products listed on this page may have this approval. Please check our website for latest approvals.

Bundling and Securing

Cable Ties

Cable Ties in Special Materials

PA12 Ties

These inside serrated cable ties are manufactured from PA12, which provides excellent UV, chemical and moisture resistance to allow for a longer lifespan in outdoor use. PA12 material absorbs slightly less moisture than PA11, yet is equally resistant to metal oxides. T-Series Cable Ties feature inside serrations to provide a positive hold on wire and cable bundles. The head design guarantees high tensile strength and a low insertion force. The bent tail allows quick and simple installation by hand. For high-volume applications, tensioning tools are available to ensure consistent and safe installation.

Features and Benefits

- PA12 cable ties deliver excellent UV, chemical and moisture resistance.
- Inside serrations provide strong grip on cables and wire bundles.
- Easy application either manually or with a tensioning tool.
- Bent tail ensures a quick and simple installation.

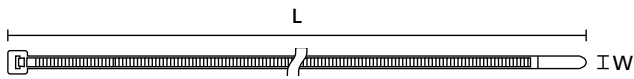

PART NO.	TYPE	Min. Tensile Strength lbs. (N)	Length (L) in. (mm)	Max. Bundle Diameter in. (mm)	Width (W) in. (mm)	Material	Color	Pkg. Qty.
111-01564	T50R	45.0 (200.0)	8.0 (202.0)	2.0 (50.0)	0.2 (4.6)	PA12	Black	1000
111-01560		45.0 (200.0)	8.0 (202.0)	2.0 (50.0)	0.2 (4.6)	PA12	Black	100
111-01562	T50L(US)	45.0 (200.0)	15.4 (390.0)	4.3 (109.2)	0.2 (4.8)	PA12	Black	100
111-01561		45.0 (200.0)	15.4 (390.0)	4.3 (109.2)	0.2 (4.8)	PA12	Black	1000
111-01563	T50XL(US)	45.0 (200.0)	18.4 (467.6)	5.3 (134.0)	0.2 (4.8)	PA12	Black	100
111-01752	T150M	175.0 (780.0)	21.0 (530.0)	5.9 (150.0)	0.4 (8.9)	PA12	Black	25

Dimensions are approximate and subject to technical changes. Use Part No. for ordering and Type for specification purposes.

Installation tools: EVO7, EVO7SP, EVO9, EVO9HT, MK7P, MK7HT, MK9P.

Cable Ties in Special Materials

T18 - T50 Series, Flame Retardant

HellermannTyton's flame retardant cable ties meet the UL 94 V-0 flammability requirements. T-Series Cable Ties feature inside serrations to provide a positive hold on wire and cable bundles. The head design guarantees high tensile strength and a low insertion force. The bent tail design allows quick and simple installations by hand. For high-volume applications, tensioning tools are available to ensure consistent and safe installation.

Features and Benefits

- Feature a UL 94 V-0 rating to comply with low flame and smoke requirements.
- Inside serrations provide strong grip on cables and wire bundles.
- Easy application either manually or with a tensioning tool.
- Bent tail ensures a quick and simple installation.

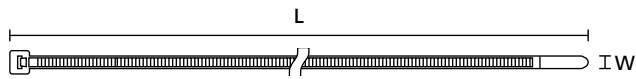

PART NO.	TYPE	Min. Tensile Strength lbs. (N)	Length (L) in. (mm)	Max. Bundle Diameter in. (mm)	Width (W) in. (mm)	Material	Color	Pkg. Qty.
T18R0VOC2*	T18R	18.0 (80.0)	4.0 (100.0)	0.9 (22.0)	0.1 (2.5)	PA66V0	Black	100
T18R9VOM4*		18.0 (80.0)	4.0 (100.0)	0.9 (22.0)	0.1 (2.5)	PA66V0	Natural	1000
T18R9VOC2*		18.0 (80.0)	4.0 (100.0)	0.9 (22.0)	0.1 (2.5)	PA66V0	Natural	100
T18I9VOM4*	T18I	18.0 (80.0)	5.5 (140.0)	1.4 (35.0)	0.1 (2.5)	PA66V0	Natural	1000
T18L0VOC2*	T18L	18.0 (80.0)	8.0 (205.0)	2.2 (55.0)	0.1 (2.5)	PA66V0	Black	100
T18L9VOM4*		18.0 (80.0)	8.0 (205.0)	2.2 (55.0)	0.1 (2.5)	PA66V0	Natural	1000
T30R0VOC2*	T30R	30.0 (135.0)	6.0 (150.0)	1.4 (35.0)	0.1 (3.6)	PA66V0	Black	100
T50R9VOM4*	T50R	50.0 (225.0)	8.0 (202.0)	2.0 (50.0)	0.2 (4.6)	PA66V0	Natural	1000
T50R9VOC2*		50.0 (225.0)	8.0 (202.0)	2.0 (50.0)	0.2 (4.6)	PA66V0	Natural	100
T50I0VOC2*	T50I	50.0 (225.0)	12.0 (305.0)	3.2 (81.3)	0.2 (4.6)	PA66V0	Black	100
T50I9VOM4*		50.0 (225.0)	12.0 (305.0)	3.2 (81.3)	0.2 (4.6)	PA66V0	Natural	1000
T50I9VOC2*		50.0 (225.0)	12.0 (305.0)	3.2 (81.3)	0.2 (4.6)	PA66V0	Natural	100

Dimensions are approximate and subject to technical changes. Use Part No. for ordering and Type for specification purposes.
 Installation tools: EVO7, EVO7SP, EVO9, EVO9HT, MK7P, MK7HT, MK9P. *This product meets UL standards. Please see appendix for specific file numbers.



Please note! Not all products listed on this page may have this approval. Please check our website for latest approvals.

Bundling and Securing

Cable Ties

Cable Ties in Special Materials

T18 - T120 Series, Polypropylene

HellermannTyton's polypropylene cable ties offer added resistance to most chemicals. T-Series Cable Ties feature inside serrations to provide a positive hold on wire and cable bundles. The head design guarantees high tensile strength and a low insertion force. The bent tail design allows quick and simple installations by hand. For high-volume applications, tensioning tools are available to ensure consistent and safe installation.

Features and Benefits

- Polypropylene cable ties deliver excellent resistance to chemicals and salts.
- Inside serrations provide strong grip on cables and wire bundles.
- Easy application either manually or with a tensioning tool.
- Bent tail ensures a quick and simple installation.

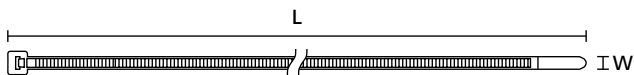

PART NO.	TYPE	Min. Tensile Strength lbs. (N)	Length (L) in. (mm)	Max. Bundle Diameter in. (mm)	Width (W) in. (mm)	Material	Color	Pkg. Qty.
T18R0PPC2	T18R	8.0 (36.0)	4.0 (100.0)	0.9 (22.0)	0.1 (2.5)	PP	Black	100
T18R9PPM4		8.0 (36.0)	4.0 (100.0)	0.9 (22.0)	0.1 (2.5)	PP	Natural	1000
T30R9PPC2	T30R	20.0 (89.0)	6.0 (150.0)	1.4 (35.0)	0.1 (3.6)	PP	Natural	100
T50R0PPM4	T50R	25.0 (111.0)	8.0 (202.0)	1.8 (44.5)	0.2 (4.6)	PP	Black	1000
T50R0PPC2		25.0 (111.0)	8.0 (202.0)	1.8 (44.5)	0.2 (4.6)	PP	Black	100
T50R9PPC2		25.0 (111.0)	8.0 (202.0)	1.8 (44.5)	0.2 (4.6)	PP	Natural	100
T120S0PPH4	T120S	60.0 (267.0)	8.9 (225.0)	2.2 (55.9)	0.3 (7.6)	PP	Black	500
T120R0PPK2	T120R	60.0 (267.0)	15.2 (387.0)	4.1 (104.1)	0.3 (7.6)	PP	Black	50
T120R0PPH4		60.0 (267.0)	15.2 (387.0)	4.1 (104.1)	0.3 (7.6)	PP	Black	500

Dimensions are approximate and subject to technical changes. Use Part No. for ordering and Type for specification purposes.
Installation tools: EVO7, EVO7SP, EVO9, EVO9HT, MK7P, MK7HT, MK9P.

Cable Ties in Special Materials

ETFE Cable Ties

ETFE ties provide excellent protection against radiation, ultraviolet light, and a wide range of chemicals. They are also rated for low outgassing applications. HellermannTyton's ETFE ties come in a standard color of blue for easy identification. T-Series Cable Ties feature inside serrations to provide a positive hold on wire and cable bundles. The head design guarantees high tensile strength and a low insertion force. The bent tail design allows quick and simple installations by hand. For high-volume applications, tensioning tools are available to ensure consistent and safe installation.



Features and Benefits

- ETFE cable ties provide excellent resistance to chemicals, radiation, high temperatures and UV exposure.
- Inside serrations allows for strong grip on cables and wire bundles.
- Head design provides high tensile strength with very low insertion force.
- Bent tail ensures a quick and simple installation.

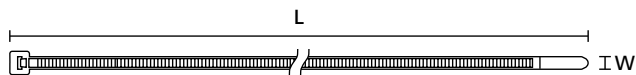

PART NO.	TYPE	Min. Tensile Strength lbs. (N)	Length (L) in. (mm)	Max. Bundle Diameter in. (mm)	Width (W) in. (mm)	Material	Color	Pkg. Qty.
111-00659*	T18R	18.0 (80.0)	4.0 (100.0)	0.9 (22.0)	0.1 (2.5)	E/TFE	Blue	100
111-00698*	T30R	30.0 (133.3)	6.0 (150.0)	1.4 (36.0)	0.1 (3.5)	E/TFE	Blue	100
111-00732*	T50R	50.0 (222.3)	8.0 (202.0)	2.0 (50.0)	0.2 (4.7)	E/TFE	Blue	100
111-00718*	T50L	50.0 (222.3)	15.0 (382.0)	4.1 (105.0)	0.2 (4.7)	E/TFE	Blue	100
111-01125*	T120R	120.0 (535.0)	15.2 (387.0)	4.1 (105.0)	0.3 (7.4)	E/TFE	Blue	50

Dimensions are approximate and subject to technical changes. Use Part No. for ordering and Type for specification purposes.

Installation tools: EVO7, EVO7SP, EVO9, EVO9HT, MK7P, MK7HT, MK9P. *This product meets UL standards. Please see appendix for specific file numbers.



Please note! Not all products listed on this page may have this approval. Please check our website for latest approvals.

Bundling and Securing

Cable Ties

Cable Ties in Special Materials

Halar Cable Ties

The raw material used to manufacture HellermannTyton Halar cable ties is UL 94 V-0 rated. The Halar ties come in a distinct red color for easy identification. T-Series Cable Ties feature inside serrations to provide a positive hold on wire and cable bundles. The head design guarantees high tensile strength and a low insertion force. The bent tail design allows quick and simple installations by hand. For high-volume applications, tensioning tools are available to ensure consistent and safe installation.

Features and Benefits

- Halar cable ties feature a UL 94 V-0 rating to comply with low flame and smoke requirements.
- Inside serrations provide strong grip on cables and wire bundles.
- Easy application either manually or with a tensioning tool.
- Bent tail ensures a quick and simple installation.

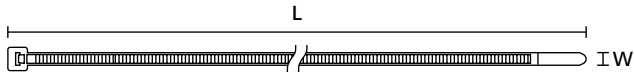

PART NO.	TYPE	Min. Tensile Strength lbs. (N)	Length (L) in. (mm)	Max. Bundle Diameter in. (mm)	Width (W) in. (mm)	Material	Color	Pkg. Qty.
T18R2HALM4	T18R	18.0 (80.0)	4.0 (100.0)	0.9 (22.0)	0.1 (2.5)	E/CTFE	Red	1000
T18R2HALC2		18.0 (80.0)	4.0 (100.0)	0.9 (22.0)	0.1 (2.5)	E/CTFE	Red	100
T50R2HALM4	T50R	40.0 (180.0)	8.0 (202.0)	1.8 (44.5)	0.2 (5.1)	E/CTFE	Red	1000
T50R2HALC2		40.0 (180.0)	8.0 (202.0)	1.8 (44.5)	0.2 (5.1)	E/CTFE	Red	100

Dimensions are approximate and subject to technical changes. Use Part No. for ordering and Type for specification purposes. Installation tools: EVO7, EVO7SP, EVO9, EVO9HT, MK7P, MK7HT, MK9P.
 Note: Halar ties are also available in natural color, contact HellermannTyton for availability. Halar is a registered trademark of Solvay S.A.

Cable Ties in Special Materials

Metal Content Ties

HellermannTyton's Metal Content Tie is specifically designed for the food, beverage and pharmaceutical processing industries to meet the safety standards set by the Hazardous Analysis of Critical Control Point (HACCP) to minimize the risk of contamination. The tie is nylon-based with metal content dispersed throughout the head and strap allowing any part of the tie to be identified by metal detectors or X-ray inspections. It is ideally suited for the management of cables and tubing in processing and packaging areas. The plastic tie can be identified in food and other products that have been contaminated either through human error or malfunctioning machinery.



Features and Benefits

- Metal content dispersed throughout the head and strap ensures identification by metal detectors and X-ray machines.
- Industry standard blue color assists with visual detection and reduces the risk of contamination.

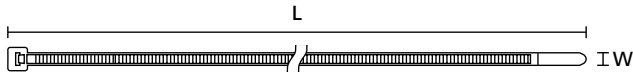

PART NO.	TYPE	Min. Tensile Strength lbs. (N)	Length (L) in. (mm)	Max. Bundle Diameter in. (mm)	Width (W) in. (mm)	Material	Color	Pkg. Qty.
111-01225	MCT18R	18.0 (80.0)	4.0 (100.0)	0.9 (22.0)	0.1 (2.5)	PA66MP	Blue	100
111-01664	MCTPP18R	19.0 (85.0)	3.9 (100.0)	0.9 (22.0)	0.1 (2.5)	PPMP	Blue	100
111-01665	MCTPP30R	29.0 (130.0)	5.9 (150.0)	1.4 (35.0)	0.1 (3.5)	PPMP	Blue	100
111-00829	MCT30R	30.0 (135.0)	6.0 (150.0)	1.4 (35.0)	0.1 (3.5)	PA66MP	Blue	100
111-01386	MCTS200	31.5 (140.0)	7.9 (201.0)	2.0 (50.0)	0.2 (4.7)	PPMP+	Blue	100
111-01666	MCTPP50R	33.7 (150.0)	8.0 (200.0)	2.0 (50.0)	0.2 (4.6)	PPMP	Blue	100
111-01667	MCTPP50L	33.7 (150.0)	15.0 (390.0)	4.3 (110.0)	0.2 (4.6)	PPMP	Blue	100
111-00830	MCT50R	50.0 (225.0)	8.0 (202.0)	2.0 (50.0)	0.2 (4.6)	PA66MP	Blue	100
111-00937	MCTRELK2M	50.0 (225.0)	9.8 (250.0)	2.6 (65.0)	0.2 (4.6)	PA66MP	Blue	100
111-00831	MCT50L	50.0 (225.0)	15.0 (380.0)	4.3 (110.0)	0.2 (4.7)	PA66MP	Blue	100
111-01668	MCTPP120R	85.4 (380.0)	15.2 (387.0)	3.9 (100.0)	0.3 (7.6)	PPMP	Blue	100
111-01136	MCT120R	120.0 (535.0)	15.2 (387.0)	3.9 (100.0)	0.3 (7.6)	PA66MP	Blue	100

Dimensions are approximate and subject to technical changes. Use Part No. for ordering and Type for specification purposes. Installation tools: EVO7, EVO7SP, EVO9, EVO9HT, MK7P, MK7HT, MK9P.

Bundling and Securing

Cable Ties

Heavy-Duty Cable Ties

T120 Series

Heavy-Duty T-Series Cable Ties feature inside serrations to provide a positive hold on wire and cable bundles. Durable head design guarantees high tensile strength and a low insertion force. The bent tail allows quick and simple installations by hand. For high-volume applications, tensioning tools are available to ensure consistent and safe installation.

Features and Benefits

- Engineered and manufactured for maximum performance and quality.
- Made from 100% high-quality plastic to ensure efficient recycling.
- Inside serration for a strong grip onto bundles.
- Easy application either manually or with a tensioning tool.
- Bent tail allows for simpler insertion.

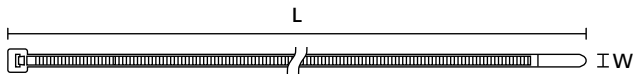

PART NO.	TYPE	Min. Tensile Strength lbs. (N)	Length (L) in. (mm)	Max. Bundle Diameter in. (mm)	Width (W) in. (mm)	Material	Color	Pkg. Qty.
T120S0H4*	T120S	120.0 (535.0)	8.9 (225.0)	2.2 (55.9)	0.3 (7.6)	PA66	Black	500
T120S0K2*		120.0 (535.0)	8.9 (225.0)	2.2 (55.9)	0.3 (7.6)	PA66	Black	50
T120S9K2*		120.0 (535.0)	8.9 (225.0)	2.2 (55.9)	0.3 (7.6)	PA66	Natural	50
T120S9H4*		120.0 (535.0)	8.9 (225.0)	2.2 (55.9)	0.3 (7.6)	PA66	Natural	500
T120I0H4*	T120I	120.0 (535.0)	11.8 (300.0)	3.2 (81.3)	0.3 (7.6)	PA66	Black	500
T120I0K2*		120.0 (535.0)	11.8 (300.0)	3.2 (81.3)	0.3 (7.6)	PA66	Black	50
T120I9H4*		120.0 (535.0)	11.8 (300.0)	3.2 (81.3)	0.3 (7.6)	PA66	Natural	500
T120I9K2*		120.0 (535.0)	11.8 (300.0)	3.2 (81.3)	0.3 (7.6)	PA66	Natural	50
T120R0H4*	T120R	120.0 (535.0)	15.2 (387.0)	4.1 (104.1)	0.3 (7.6)	PA66	Black	500
T120R0K2*		120.0 (535.0)	15.2 (387.0)	4.1 (104.1)	0.3 (7.6)	PA66	Black	50
T120R9H4*		120.0 (535.0)	15.2 (387.0)	4.1 (104.1)	0.3 (7.6)	PA66	Natural	500
T120R9K2*		120.0 (535.0)	15.2 (387.0)	4.1 (104.1)	0.3 (7.6)	PA66	Natural	50
T120L0K2*	T120L	120.0 (535.0)	30.0 (760.0)	8.9 (224.8)	0.3 (7.6)	PA66	Black	50
T120L9K2*		120.0 (535.0)	30.0 (760.0)	8.9 (224.8)	0.3 (7.6)	PA66	Natural	50

Dimensions are approximate and subject to technical changes. Use Part No. for ordering and Type for specification purposes. Installation tools: EVO9, EVO9HT, MK9P. *This product meets UL standards. Please see appendix for specific file numbers.



Please note! Not all products listed on this page may have this approval. Please check our website for latest approvals.

Heavy-Duty Cable Ties

T150 Series

Heavy-Duty T-Series Cable Ties feature inside serrations to provide a positive hold on wire and cable bundles. Durable head design guarantees high tensile strength and a low insertion force. The bent tail allows quick and simple installations by hand. For high-volume applications, tensioning tools are available to ensure consistent and safe installation.

Features and Benefits

- Engineered and manufactured for maximum performance and quality.
- Made from 100% high-quality plastic to ensure efficient recycling.
- Inside serration for a strong grip onto bundles.
- Easy application either manually or with a tensioning tool.
- Bent tail allows for simpler insertion.

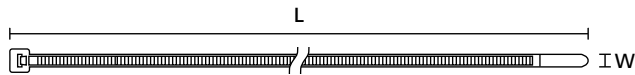

PART NO.	TYPE	Min. Tensile Strength lbs. (N)	Length (L) in. (mm)	Max. Bundle Diameter in. (mm)	Width (W) in. (mm)	Material	Color	Pkg. Qty.
T150R0X2*	T150R(U)	175.0 (780.0)	15.4 (390.0)	4.1 (104.1)	0.4 (8.9)	PA66	Black	25
T150R9X2*		175.0 (780.0)	15.4 (390.0)	4.1 (104.1)	0.4 (8.9)	PA66	Natural	25
T150M0X2*	T150M	175.0 (780.0)	21.0 (530.0)	5.9 (150.0)	0.4 (8.9)	PA66	Black	25
T150M9X2*		175.0 (780.0)	21.0 (530.0)	5.9 (150.0)	0.4 (8.9)	PA66	Natural	25
T150L0X2*	T150L	175.0 (780.0)	32.3 (820.0)	9.6 (243.8)	0.4 (8.9)	PA66	Black	25
T150L9X2*		175.0 (780.0)	32.3 (820.0)	9.6 (243.8)	0.4 (8.9)	PA66	Natural	25
T150LL0X2*	T150LL	175.0 (780.0)	36.4 (925.0)	10.8 (274.3)	0.4 (8.9)	PA66	Black	25
T150LL9X2*		175.0 (780.0)	36.4 (925.0)	10.8 (274.3)	0.4 (8.9)	PA66	Natural	25
T150XL0X2*	T150XL	175.0 (780.0)	43.1 (1,095.0)	13.0 (330.2)	0.4 (8.9)	PA66	Black	25
T150XL9X2*		175.0 (780.0)	43.1 (1,095.0)	13.0 (330.2)	0.4 (8.9)	PA66	Natural	25
T150XLL0X2*	T150XLL	175.0 (780.0)	52.2 (1,325.0)	16.0 (406.4)	0.4 (8.9)	PA66	Black	25
T150XLL9X2*		175.0 (780.0)	52.2 (1,325.0)	16.0 (406.4)	0.4 (8.9)	PA66	Natural	25

Dimensions are approximate and subject to technical changes. Use Part No. for ordering and Type for specification purposes. Installation tools: EVO9, EVO9HT, MK9P. *This product meets UL standards. Please see appendix for specific file numbers.



Please note! Not all products listed on this page may have this approval. Please check our website for latest approvals.

Bundling and Securing

Cable Ties

Heavy-Duty Cable Ties

T250 Series

These cable ties offer a high minimum tensile strength and have a buckle feature which allows the end of the cable tie to be tucked away if necessary. The buckle also snaps into HellermannTyton lashing tie mounts (LTM.) T-Series Cable Ties feature inside serrations to provide a positive hold on wire and cable bundles. The head design guarantees high tensile strength and a low insertion force. The bent tail design allows quick and simple installations by hand. For high-volume applications, tensioning tools are available to ensure consistent and safe installation.

Features and Benefits

- Engineered and manufactured for maximum performance and quality.
- Made from 100% high-quality plastic to ensure efficient recycling.
- Inside serration for a strong grip onto bundles.
- Easy application either manually or with a tensioning tool.
- Bent tail allows for simpler insertion.

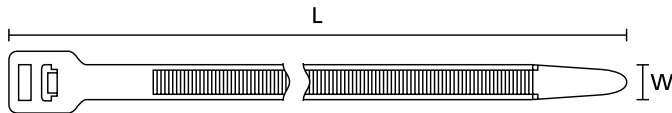

PART NO.	TYPE	Min. Tensile Strength lbs. (N)	Length (L) in. (mm)	Max. Bundle Diameter in. (mm)	Width (W) in. (mm)	Material	Color	Pkg. Qty.
T250S0X2*	T250S	250.0 (1,115.0)	9.1 (230.0)	2.0 (50.0)	0.5 (12.4)	PA66	Black	25
T250S9X2*		250.0 (1,115.0)	9.1 (230.0)	2.0 (50.0)	0.5 (12.4)	PA66	Natural	25
T250R0X2*	T250R	250.0 (1,115.0)	20.3 (515.0)	4.9 (124.5)	0.5 (12.4)	PA66	Black	25
T250R9X2*		250.0 (1,115.0)	20.3 (515.0)	4.9 (124.5)	0.5 (12.4)	PA66	Natural	25
T250M0X2*	T250M	250.0 (1,115.0)	22.3 (565.3)	5.9 (150.0)	0.5 (12.4)	PA66	Black	25
T250M9X2*		250.0 (1,115.0)	22.3 (565.3)	5.9 (150.0)	0.5 (12.4)	PA66	Natural	25
T250I0X2*	T250I	250.0 (1,115.0)	28.7 (730.0)	8.0 (203.0)	0.5 (12.4)	PA66	Black	25
T250I9X2*		250.0 (1,115.0)	28.7 (730.0)	8.0 (203.0)	0.5 (12.4)	PA66	Natural	25
T250L0X2*	T250L	250.0 (1,115.0)	34.7 (880.0)	10.0 (254.0)	0.5 (12.4)	PA66	Black	25
T250L9X2*		250.0 (1,115.0)	34.7 (880.0)	10.0 (254.0)	0.5 (12.4)	PA66	Natural	25
T250XL0X2*	T250XL	250.0 (1,115.0)	40.6 (1,030.0)	12.0 (305.0)	0.5 (12.4)	PA66	Black	25
T250XL9X2*		250.0 (1,115.0)	40.6 (1,030.0)	12.0 (305.0)	0.5 (12.4)	PA66	Natural	25

Dimensions are approximate and subject to technical changes. Use Part No. for ordering and Type for specification purposes.
Installation tools: EVO9, EVO9HT, MK9P. *This product meets UL standards. Please see appendix for specific file numbers.



Please note! Not all products listed on this page may have this approval. Please check our website for latest approvals.

Heavy-Duty Cable Ties

T255 Series

HellermannTyton's T255 series heavy duty cable ties are ideal for bundles demanding a strong cable tie that may also require a higher impact resistance than the T250 series. These ties have a tensile strength of 250 lbs. Heavy-Duty T-Series Cable Ties feature inside serrations to provide a positive hold on wire and cable bundles. Durable head design guarantees high tensile strength and a low insertion force. The bent tail allows quick and simple installations by hand. For high-volume applications, tensioning tools are available to ensure consistent and safe installation.

Features and Benefits

- Engineered and manufactured for maximum performance and quality.
- Made from 100% high-quality plastic to ensure efficient recycling.
- Inside serration for a strong grip onto bundles.
- Easy application either manually or with a tensioning tool.
- Bent tail allows for simpler insertion.

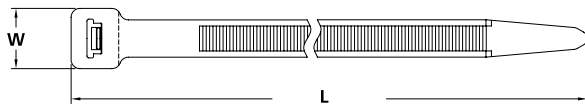

PART NO.	TYPE	Min. Tensile Strength lbs. (N)	Length (L) in. (mm)	Max. Bundle Diameter in. (mm)	Width (W) in. (mm)	Material	Color	Pkg. Qty.
T255S0HIRX2*	T255S	250.0 (1,115.0)	8.9 (225.0)	2.2 (55.9)	0.5 (12.7)	PA66HIRHSUV	Black	25
T255R0HIRX2*	T255R	250.0 (1,115.0)	20.0 (508.0)	5.0 (127.0)	0.5 (12.7)	PA66HIRHSUV	Black	25
T255M0HIRX2*	T255M	250.0 (1,115.0)	22.0 (560.0)	6.3 (160.0)	0.5 (12.7)	PA66HIRHSUV	Black	25

Dimensions are approximate and subject to technical changes. Use Part No. for ordering and Type for specification purposes.
 Installation tools: EVO9, EVO9HT, MK95P, MK9HT. *This product meets UL standards. Please see appendix for specific file numbers.

Bundling and Securing

Cable Ties

Wide Strap Cable Ties

Wide Strap Heavy Duty Cable Ties

The Heavy Duty Wide-Strap Cable Tie was designed to minimize the pinching of soft bundles and the potential of lateral movement along the bundle. The low-profile head and underside clamping rails increase the grip around the bundle and provide a better fit than traditional cable ties. These are used primarily in the trucking and heavy equipment industries, but can be used in a wide variety of applications where strength is needed.

Features and Benefits

- Wide strap is designed to minimize pinching of soft hoses and convoluted tubing.
- Low-profile head with clamping rails provide compact bundling with a full circumferential compression around bundles.
- Wider and thinner strap design increases flexibility, provides low insertion and minimizes pinching of bundles.
- Bent tail allows for quick insertion into head or mounts.

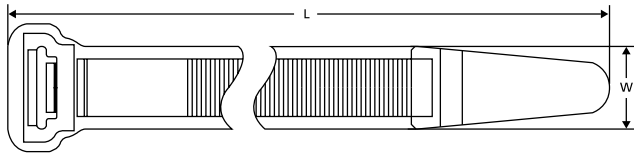

PART NO.	TYPE	Min. Tensile Strength lbs. (N)	Length (L) in. (mm)	Max. Bundle Diameter in. (mm)	Width (W) in. (mm)	Material	Color	Pkg. Qty.
111-12300	WSS	120.0 (535.0)	9.1 (231.0)	2.2 (58.4)	0.5 (12.7)	PA66HIRHSUV	Black	300
111-12301	WSI	120.0 (535.0)	12.1 (307.0)	3.2 (83.8)	0.5 (12.7)	PA66HIRHSUV	Black	300
111-12302	WSR	120.0 (535.0)	15.1 (383.5)	4.1 (104.1)	0.5 (12.7)	PA66HIRHSUV	Black	300

Dimensions are approximate and subject to technical changes. Use Part No. for ordering and Type for specification purposes.
Installation tools: EVO9, EVO9HT, MK9SP, MK9HT.

Outside Serrated Cable Ties

T18ROS - T50LOS Series in Black

HellermannTyton outside serrated cable ties are designed with a smooth inside surface to help minimize indentation or damage to wire and cable insulation, while offering high tensile strength and low insertion force. The contour style head takes up less space than traditional style cable ties making it ideal for space constrained areas. For high volume applications, tensioning tools are available to ensure consistent and safe installation.

Features and Benefits

- Outside serrations minimize damage to cables, while still providing high tensile strength and low insertion force.
- Contour style head design provides additional space in constrained areas.
- Heat stabilized material provides excellent resistance to high heat exposures.

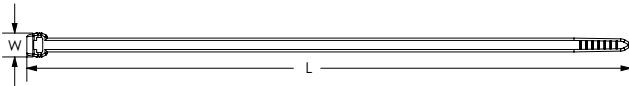

PART NO.	TYPE	Min. Tensile Strength lbs. (N)	Length (L) in. (mm)	Max. Bundle Diameter in. (mm)	Width (W) in. (mm)	Material	Color	Pkg. Qty.
118-04700	T18ROS	18.0 (80.0)	4.0 (100.0)	0.8 (20.0)	0.1 (2.5)	PA66HS	Black	100
118-04800	T30ROS	30.0 (135.0)	5.7 (145.0)	1.4 (35.0)	0.1 (3.4)	PA66HS	Black	100
118-04900	T30LOS	30.0 (135.0)	8.0 (200.0)	2.0 (50.0)	0.1 (3.4)	PA66HS	Black	100
118-05850	T50SOS	50.0 (225.0)	5.9 (150.0)	1.4 (35.0)	0.2 (4.6)	PA66HS	Black	100
118-00110		50.0 (225.0)	5.9 (150.0)	1.4 (35.0)	0.2 (4.6)	PA66HS	Black	1000
118-05050	T50ROS	50.0 (225.0)	8.0 (200.0)	2.0 (50.0)	0.2 (4.6)	PA66HS	Black	100
118-00111		50.0 (225.0)	8.0 (200.0)	2.0 (50.0)	0.2 (4.6)	PA66HS	Black	1000
118-05900	T50LOS	50.0 (225.0)	15.2 (384.0)	4.3 (110.0)	0.2 (4.6)	PA66HS	Black	100

Dimensions are approximate and subject to technical changes. Use Part No. for ordering and Type for specification purposes.
 Installation tools: EVO7, EVO7SP, EVO9, EVO9HT, MK7P, MK7HT, MK9P.

Bundling and Securing

Cable Ties

Cable Ties with Open Head

Q-Ties in PA66

Q-Ties have a distinctive open-style head, a pre-lock function, and a large ribbed tail. The easily detectable slot opening offered with the tail and tie head provides ease of placement when working with gloves or for blind applications with limited view of the installation. The pre-lock feature allows for temporary holding of cable and wire bundles, permitting additional cables and wires to be placed without destroying the cable tie. Q-Ties can be tensioned by hand or with one of HellermannTyton's mechanical cable tie application tools.

Features and Benefits

- Open-head design with easily detectable slot opening allows for swift and easy insertion.
- Pre-lock feature allows for a temporary hold.
- The large ribbed tail permits an ergonomic installation.
- Two rails on the strap ensure guidance through the cable tie head.

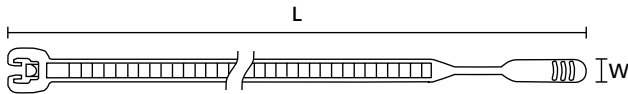

PART NO.	TYPE	Min. Tensile Strength lbs. (N)	Length (L) in. (mm)	Max. Bundle Diameter in. (mm)	Width (W) in. (mm)	Material	Color	Pkg. Qty.
109-00030*	Q18R	18.0 (80.0)	4.1 (105.0)	0.9 (24.0)	0.1 (2.6)	PA66	Black	100
109-00001*		18.0 (80.0)	4.1 (105.0)	0.9 (24.0)	0.1 (2.6)	PA66	Natural	100
109-00033*	Q18I	18.0 (80.0)	6.1 (155.0)	1.6 (40.0)	0.1 (2.6)	PA66	Black	100
109-00004*		18.0 (80.0)	6.1 (155.0)	1.6 (40.0)	0.1 (2.6)	PA66	Natural	100
109-00036*	Q18L	18.0 (80.0)	7.7 (195.0)	2.0 (50.0)	0.1 (2.6)	PA66	Black	100
109-00007*		18.0 (80.0)	7.7 (195.0)	2.0 (50.0)	0.1 (2.6)	PA66	Natural	100
109-00039*	Q30R	30.0 (130.0)	6.3 (160.0)	1.5 (38.0)	0.1 (3.6)	PA66	Black	100
109-00010*		30.0 (130.0)	6.3 (160.0)	1.5 (38.0)	0.1 (3.6)	PA66	Natural	100
109-00041*	Q30L	30.0 (130.0)	7.9 (200.0)	2.0 (50.0)	0.1 (3.6)	PA66	Black	100
109-00012*		30.0 (130.0)	7.9 (200.0)	2.0 (50.0)	0.1 (3.6)	PA66	Natural	100
109-00043	Q30LR	30.0 (130.0)	9.8 (250.0)	2.6 (65.0)	0.1 (3.6)	PA66	Black	100
109-00014		30.0 (130.0)	9.8 (250.0)	2.6 (65.0)	0.1 (3.6)	PA66	Natural	100

Dimensions are approximate and subject to technical changes. Use Part No. for ordering and Type for specification purposes.

Installation tools: EVO7, EVO7SP, EVO9, EVO9HT, MK7P, MK7HT, MK9P. *This product meets UL standards. Please see appendix for specific file numbers.



Please note! Not all products listed on this page may have this approval. Please check our website for latest approvals.

Cable Ties with Open Head

Q-Ties in PA66

PART NO.	TYPE	Min. Tensile Strength lbs. (N)	Length (L) in. (mm)	Max. Bundle Diameter in. (mm)	Width (W) in. (mm)	Material	Color	Pkg. Qty.
109-00047*	Q50R	50.0 (220.0)	8.3 (210.0)	2.0 (50.0)	0.2 (4.7)	PA66	Black	100
109-00018*		50.0 (220.0)	8.3 (210.0)	2.0 (50.0)	0.2 (4.7)	PA66	Natural	100
109-00049*	Q50I	50.0 (220.0)	11.4 (290.0)	3.0 (75.0)	0.2 (4.7)	PA66	Black	100
109-00020*		50.0 (220.0)	11.4 (290.0)	3.0 (75.0)	0.2 (4.7)	PA66	Natural	100
109-00051*	Q50L	50.0 (220.0)	16.1 (410.0)	4.3 (110.0)	0.2 (4.7)	PA66	Black	100
109-00022*		50.0 (220.0)	16.1 (410.0)	4.3 (110.0)	0.2 (4.7)	PA66	Natural	100
109-00053*	Q120I	120.0 (530.0)	11.8 (300.0)	2.8 (70.0)	0.3 (7.7)	PA66	Black	100
109-00024*		120.0 (530.0)	11.8 (300.0)	2.8 (70.0)	0.3 (7.7)	PA66	Natural	100
109-00055*	Q120R	120.0 (530.0)	16.5 (420.0)	4.3 (110.0)	0.3 (7.7)	PA66	Black	100
109-00026*		120.0 (530.0)	16.5 (420.0)	4.3 (110.0)	0.3 (7.7)	PA66	Natural	100
109-00057*	Q120M	120.0 (530.0)	20.5 (520.0)	5.1 (130.0)	0.3 (7.7)	PA66	Black	100
109-00028*		120.0 (530.0)	20.5 (520.0)	5.1 (130.0)	0.3 (7.7)	PA66	Natural	100

Dimensions are approximate and subject to technical changes. Use Part No. for ordering and Type for specification purposes.

Installation tools: EVO7, EVO7SP, EVO9, EVO9HT, MK7P, MK7HT, MK9P. *This product meets UL standards. Please see appendix for specific file numbers.

Bundling and Securing

Cable Ties

Cable Ties with Open Head

Q-Ties in Heat Stabilized PA66HS

Q-Ties have a distinctive open-style head, a pre-lock function, and a large ribbed tail. The easily detectable slot opening offered with the tail and tie head provides ease of placement when working with gloves or for blind applications with limited view of the installation. The pre-lock feature allows for temporary holding of cable and wire bundles, permitting additional cables and wires to be placed without destroying the cable tie. Q-Ties can be tensioned by hand or with one of HellermannTyton's mechanical cable tie application tools.

Features and Benefits

- PA66HS cable ties are heat stabilized for excellent heat resistance.
- Open-head design with easily detectable slot opening allows for fast and easy insertion.
- Pre-lock feature allows for a temporary hold while preparing bundle.
- Large ribbed tail ensures simple, ergonomic installation.

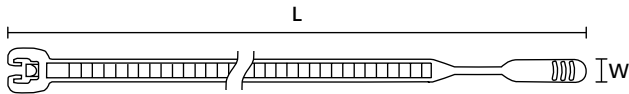

PART NO.	TYPE	Min. Tensile Strength lbs. (N)	Length (L) in. (mm)	Max. Bundle Diameter in. (mm)	Width (W) in. (mm)	Material	Color	Pkg. Qty.
109-00088*	Q18R	18.0 (80.0)	4.1 (105.0)	0.9 (24.0)	0.1 (2.6)	PA66HS	Black	100
109-00117*		18.0 (80.0)	4.1 (105.0)	0.9 (24.0)	0.1 (2.6)	PA66HS	Natural	100
109-00091*	Q18I	18.0 (80.0)	6.1 (155.0)	1.6 (40.0)	0.1 (2.6)	PA66HS	Black	100
109-00120*		18.0 (80.0)	6.1 (155.0)	1.6 (40.0)	0.1 (2.6)	PA66HS	Natural	100
109-00094*	Q18L	18.0 (80.0)	7.7 (195.0)	2.0 (50.0)	0.1 (2.6)	PA66HS	Black	100
109-00123*		18.0 (80.0)	7.7 (195.0)	2.0 (50.0)	0.1 (2.6)	PA66HS	Natural	100
109-00097*	Q30R	30.0 (130.0)	6.3 (160.0)	1.5 (38.0)	0.1 (3.6)	PA66HS	Black	100
109-00126*		30.0 (130.0)	6.3 (160.0)	1.5 (38.0)	0.1 (3.6)	PA66HS	Natural	100
109-00099*	Q30L	30.0 (130.0)	7.9 (200.0)	2.0 (50.0)	0.1 (3.6)	PA66HS	Black	100
109-00128*		30.0 (130.0)	7.9 (200.0)	2.0 (50.0)	0.1 (3.6)	PA66HS	Natural	100
109-00101	Q30LR	30.0 (130.0)	9.8 (250.0)	2.6 (65.0)	0.1 (3.6)	PA66HS	Black	100
109-00130		30.0 (130.0)	9.8 (250.0)	2.6 (65.0)	0.1 (3.6)	PA66HS	Natural	100

Dimensions are approximate and subject to technical changes. Use Part No. for ordering and Type for specification purposes.

Installation tools: EVO7, EVO7SP, EVO9, EVO9HT, MK7P, MK7HT, MK9P. *This product meets UL standards. Please see appendix for specific file numbers.



Please note! Not all products listed on this page may have this approval. Please check our website for latest approvals.

Cable Ties with Open Head

Q-Ties in Heat Stabilized PA66HS

PART NO.	TYPE	Min. Tensile Strength lbs. (N)	Length (L) in. (mm)	Max. Bundle Diameter in. (mm)	Width (W) in. (mm)	Material	Color	Pkg. Qty.
109-00105*	Q50R	50.0 (220.0)	8.3 (210.0)	2.0 (50.0)	0.2 (4.7)	PA66HS	Black	100
109-00134*		50.0 (220.0)	8.3 (210.0)	2.0 (50.0)	0.2 (4.7)	PA66HS	Natural	100
109-00107*	Q50I	50.0 (220.0)	11.4 (290.0)	3.0 (75.0)	0.2 (4.7)	PA66HS	Black	100
109-00136*		50.0 (220.0)	11.4 (290.0)	3.0 (75.0)	0.2 (4.7)	PA66HS	Natural	100
109-00109*	Q50L	50.0 (220.0)	16.1 (410.0)	4.3 (110.0)	0.2 (4.7)	PA66HS	Black	100
109-00138*		50.0 (220.0)	16.1 (410.0)	4.3 (110.0)	0.2 (4.7)	PA66HS	Natural	100
109-00111*	Q120I	120.0 (530.0)	11.8 (300.0)	2.8 (70.0)	0.3 (7.7)	PA66HS	Black	100
109-00140*		120.0 (530.0)	11.8 (300.0)	2.8 (70.0)	0.3 (7.7)	PA66HS	Natural	100
109-00113*	Q120R	120.0 (530.0)	16.5 (420.0)	4.3 (110.0)	0.3 (7.7)	PA66HS	Black	100
109-00142*		120.0 (530.0)	16.5 (420.0)	4.3 (110.0)	0.3 (7.7)	PA66HS	Natural	100
109-00115*	Q120M	120.0 (530.0)	20.5 (520.0)	5.1 (130.0)	0.3 (7.7)	PA66HS	Black	100
109-00144*		120.0 (530.0)	20.5 (520.0)	5.1 (130.0)	0.3 (7.7)	PA66HS	Natural	100

Dimensions are approximate and subject to technical changes. Use Part No. for ordering and Type for specification purposes.

Installation tools: EVO7, EVO7SP, EVO9, EVO9HT, MK7P, MK7HT, MK9P. *This product meets UL standards. Please see appendix for specific file numbers.

Bundling and Securing

Cable Ties

Releasable Cable Ties

RT Series

HellermannTyton Releasable Cable Ties feature an extended pawl for easy access to wire bundles when changes are necessary. The head design guarantees high tensile strength even after repeated use, as well as a low insertion force. For high-volume applications, tensioning tools are available to ensure consistent and safe installation.

Features and Benefits

- Special design with extended pawl offers a release feature for quick and easy access to wire bundles.
- Head design provides high tensile strength with very low insertion force even after repeated use.



PART NO.	TYPE	Min. Tensile Strength lbs. (N)	Length (L) in. (mm)	Max. Bundle Diameter in. (mm)	Width (W) in. (mm)	Material	Color	Pkg. Qty.
RT40R0M4*	RT40R	40.0 (180.0)	8.5 (215.0)	2.0 (51.0)	0.2 (4.0)	PA66	Black	1000
RT40R0C2*		40.0 (180.0)	8.5 (215.0)	2.0 (51.0)	0.2 (4.0)	PA66	Black	100
RT40R9C2*		40.0 (180.0)	8.5 (215.0)	2.0 (51.0)	0.2 (4.0)	PA66	Natural	100
RT40R9M4*		40.0 (180.0)	8.5 (215.0)	2.0 (51.0)	0.2 (4.0)	PA66	Natural	1000
RT50S0C2*	RT50S	50.0 (225.0)	6.3 (160.0)	1.4 (35.0)	0.2 (4.6)	PA66	Black	100
RT50S9C2*		50.0 (225.0)	6.3 (160.0)	1.4 (35.0)	0.2 (4.6)	PA66	Natural	100
RT50S9M4*		50.0 (225.0)	6.3 (160.0)	1.4 (35.0)	0.2 (4.6)	PA66	Natural	1000
RT50LL0M4*	RT50LL	50.0 (225.0)	15.0 (380.0)	4.0 (101.0)	0.2 (4.6)	PA66	Black	1000
RT50LL9M4*		50.0 (225.0)	15.0 (380.0)	4.0 (101.0)	0.2 (4.6)	PA66	Natural	1000
RT50LL9C2*		50.0 (225.0)	15.0 (380.0)	4.0 (101.0)	0.2 (4.6)	PA66	Natural	100
RT50LL0UVC2		50.0 (225.0)	15.0 (380.0)	4.0 (101.0)	0.2 (4.6)	PA66UV	Black	100

Dimensions are approximate and subject to technical changes. Use Part No. for ordering and Type for specification purposes.

Installation tools: EVO7, EVO7SP, EVO9, EVO9HT, MK7P, MK7HT, MK9P. *This product meets UL standards. Please see appendix for specific file numbers.



Please note! Not all products listed on this page may have this approval. Please check our website for latest approvals.

Releasable Cable Ties

REZ Series Pinch Releasable Ties

Patented pinch release mechanism for easy handling allows tie to be released using one hand. The head design guarantees high tensile strength even after repeated use. For high-volume applications, tensioning tools are available to ensure consistent and safe installation.

Features and Benefits

- The unique, patented head design enables the tie to be inserted through a standard style head for permanent locking or can be twisted into the pinch-releasable style head for easy opening at a later time.
- The quick pinch-release mechanism can be released by one hand even when the tie is under tension.

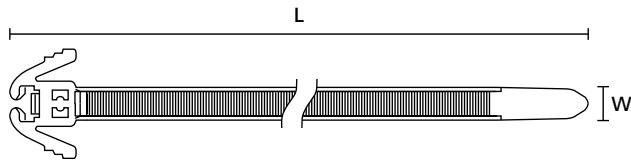

PART NO.	TYPE	Min. Tensile Strength lbs. (N)	Length (L) in. (mm)	Max. Bundle Diameter in. (mm)	Width (W) in. (mm)	Material	Color	Pkg. Qty.
REZ200.NB3P	REZ200	30.0 (135.0)	7.9 (200.0)	2.0 (50.0)	0.2 (4.7)	PA66	Black	100
REZ300.NB3P	REZ300	30.0 (135.0)	12.0 (305.0)	3.2 (80.0)	0.2 (4.7)	PA66	Black	100

Dimensions are approximate and subject to technical changes. Use Part No. for ordering and Type for specification purposes.
 Installation tools: EVO7, EVO7SP, EVO9, EVO9HT, MK7P, MK7HT, MK9P.

Bundling and Securing

Cable Ties

Releasable Cable Ties

RT150 Heavy Duty Releasable Cable Ties

HellermannTyton heavy-duty releasable cable ties feature an extended pawl that allows for simple and quick tie release. The head design guarantees high tensile strength even after repeated use, as well as a low insertion force. For high-volume applications, tensioning tools are available to ensure consistent and safe installation.

Features and Benefits

- Special design with extended pawl offers a release feature for quick and easy access to wire bundles.
- Head design provides high tensile strength with very low insertion force even after repeated use.

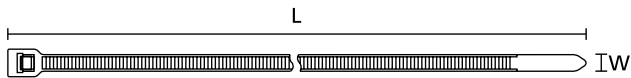

PART NO.	TYPE	Min. Tensile Strength lbs. (N)	Length (L) in. (mm)	Max. Bundle Diameter in. (mm)	Width (W) in. (mm)	Material	Color	Pkg. Qty.
RT150REPOX2	RT150REP	175.0 (780.0)	15.4 (390.0)	4.1 (105.0)	0.4 (8.8)	PA66	Black	25
RT150MEPOX2	RT150MEP	175.0 (780.0)	21.0 (535.0)	5.9 (150.0)	0.4 (8.8)	PA66	Black	25
RT150LEPOX2	RT150LEP	175.0 (780.0)	32.3 (820.0)	9.6 (245.0)	0.4 (8.8)	PA66	Black	25

Dimensions are approximate and subject to technical changes. Use Part No. for ordering and Type for specification purposes.
Installation tools: EVO9, EVO9HT, MK9P.

Heavy Duty Releasable Cable Ties

RT250 Heavy Duty Releasable Cable Ties

HellermannTyton heavy-duty releasable cable ties offer a release feature in the head allowing for easy access to wire bundles when changes are necessary. The head design guarantees high tensile strength even after repeated use, as well as a low insertion force. For high volume applications, tensioning tools are available to ensure consistent and safe installation.

Features and Benefits

- Special extended-pawl design offers a release feature for quick and easy access to wire bundles.
- Head design provides high tensile strength with very low insertion force even after repeated use.
- Buckle feature on head allows excess strap to be tucked away after installation.

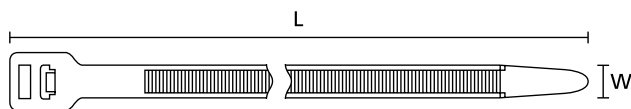
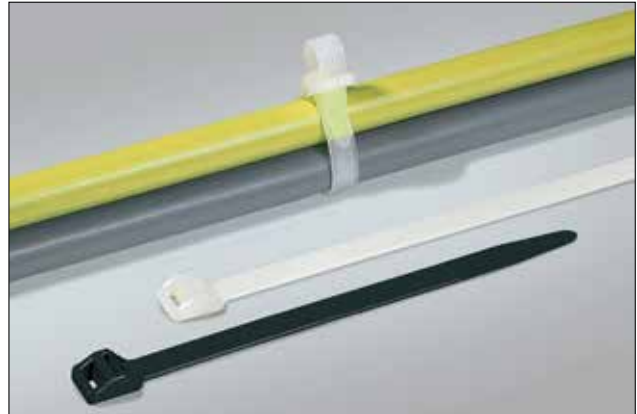

PART NO.	TYPE	Min. Tensile Strength lbs. (N)	Length (L) in. (mm)	Max. Bundle Diameter in. (mm)	Width (W) in. (mm)	Material	Color	Pkg. Qty.
RT250S0X2*	RT250S	250.0 (1,115.0)	9.1 (230.0)	2.0 (50.0)	0.5 (12.5)	PA66	Black	25
RT250S9X2*		250.0 (1,115.0)	9.1 (230.0)	2.0 (50.0)	0.5 (12.5)	PA66	Natural	25
RT250S0UVX2		250.0 (1,115.0)	9.1 (230.0)	2.0 (50.0)	0.5 (12.5)	PA66UV	Black	25
RT250R0X2*	RT250R	250.0 (1,115.0)	20.3 (515.0)	4.9 (125.0)	0.5 (12.5)	PA66	Black	25
RT250R9X2*		250.0 (1,115.0)	20.3 (515.0)	4.9 (125.0)	0.5 (12.5)	PA66	Natural	25
RT250R0UVX2		250.0 (1,115.0)	20.3 (515.0)	4.9 (125.0)	0.5 (12.5)	PA66UV	Black	25
RT250M0X2*	RT250M	250.0 (1,115.0)	22.3 (565.3)	5.9 (150.0)	0.5 (12.5)	PA66	Black	25
RT250M9X2*		250.0 (1,115.0)	22.3 (565.3)	5.9 (150.0)	0.5 (12.5)	PA66	Natural	25
RT250M0UVX2*		250.0 (1,115.0)	22.3 (565.3)	5.9 (150.0)	0.5 (12.5)	PA66UV	Black	25
RT250I0X2*	RT250I	250.0 (1,115.0)	28.7 (730.0)	8.0 (203.0)	0.5 (12.5)	PA66	Black	25
RT250I9X2*		250.0 (1,115.0)	28.7 (730.0)	8.0 (203.0)	0.5 (12.5)	PA66	Natural	25
RT250I0UVX2		250.0 (1,115.0)	28.7 (730.0)	8.0 (203.0)	0.5 (12.5)	PA66UV	Black	25
RT250L0X2*	RT250L	250.0 (1,115.0)	34.6 (880.0)	10.0 (254.0)	0.5 (12.5)	PA66	Black	25
RT250L9X2*		250.0 (1,115.0)	34.6 (880.0)	10.0 (254.0)	0.5 (12.5)	PA66	Natural	25
RT250L0UVX2		250.0 (1,115.0)	34.6 (880.0)	10.0 (254.0)	0.5 (12.5)	PA66UV	Black	25
RT250XL0X2*	RT250XL	250.0 (1,115.0)	40.6 (1,030.0)	12.0 (305.0)	0.5 (12.5)	PA66	Black	25
RT250XL9X2*		250.0 (1,115.0)	40.6 (1,030.0)	12.0 (305.0)	0.5 (12.5)	PA66	Natural	25
RT250XL0UVX2		250.0 (1,115.0)	40.6 (1,030.0)	12.0 (305.0)	0.5 (12.5)	PA66UV	Black	25

Dimensions are approximate and subject to technical changes. Use Part No. for ordering and Type for specification purposes. Installation tools: EVO9, EVO9HT, MK9P. *This product meets UL standards. Please see appendix for specific file numbers.



Please note! Not all products listed on this page may have this approval. Please check our website for latest approvals.

Bundling and Securing

Cable Ties

Releasable Cable Ties

Speedy Tie

An entirely innovative design in cable management, the Speedy Tie is a fully reusable, easily releasable tie. The Speedy Tie's unique design allows it to be released with one hand. HellermannTyton releasable cable ties offer a release feature in the head allowing for easy access to wire bundles when changes or temporary bundling are necessary. The head design guarantees high tensile strength even after repeated use.

Features and Benefits

- The heavy-duty Speedy tie features a specially designed head and patented trigger to allow for repeated use in temporary bundling applications.
- Additional design feature on the head allows excess strap to be tucked away after installation.

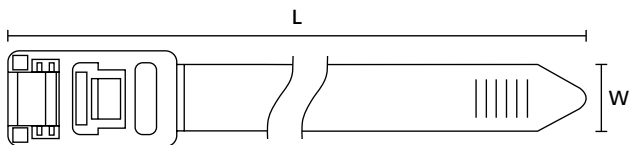

PART NO.	TYPE	Min. Tensile Strength lbs. (N)	Length (L) in. (mm)	Max. Bundle Diameter in. (mm)	Width (W) in. (mm)	Material	Color	Pkg. Qty.
RTT750HR.NX900	SpeedyTie (RTT750HR)	200.0 (888.0)	29.6 (752.0)	8.3 (210.0)	0.5 (13.0)	PA66	Yellow, Red	5
RTT750HR.NX1P		200.0 (888.0)	29.6 (752.0)	8.3 (210.0)	0.5 (13.0)	PA66	Yellow, Red	25
115-00030		200.0 (888.0)	29.6 (752.0)	8.3 (210.0)	0.5 (13.0)	PA66HIR(S)	Black	5

Dimensions are approximate and subject to technical changes. Use Part No. for ordering and Type for specification purposes.

Releasable Cable Ties

RT255 Heavy Duty Releasable Ties

HellermannTyton releasable cable ties offer a release feature in the head allowing for easy access to wire bundles when changes are necessary. The head design guarantees high tensile strength even after repeated use, as well as a low insertion force. For high volume applications, tensioning tools are available to ensure consistent and safe installation.

Features and Benefits

- High impact, heat and UV stabilized releasable cable ties contain an impact modifier allowing greater flexibility and greater resistance to vibration.
- Special design offers a release feature for quick and easy access to wire bundles.
- Head design provides high tensile strength with very low insertion force even after repeated use.

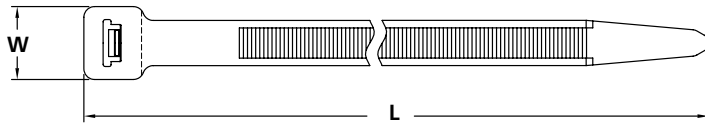

PART NO.	TYPE	Min. Tensile Strength lbs. (N)	Length (L) in. (mm)	Max. Bundle Diameter in. (mm)	Width (W) in. (mm)	Material	Color	Pkg. Qty.
RT255S0HIRX2*	RT255S	250.0 (1,115.0)	8.9 (225.0)	2.0 (50.0)	0.5 (12.6)	PA66HIRHSUV	Black	25
RT255R0HIRX2*	RT255R	250.0 (1,115.0)	20.0 (508.0)	5.0 (127.0)	0.5 (12.6)	PA66HIRHSUV	Black	25

Dimensions are approximate and subject to technical changes. Use Part No. for ordering and Type for specification purposes. Installation tools: EVO9, EVO9HT, MK9P. *This product meets UL standards. Please see appendix for specific file numbers.



Please note! Not all products listed on this page may have this approval. Please check our website for latest approvals.

Bundling and Securing

Cable Ties

Releasable Cable Ties

SR255 Heavy Duty Sub-Releasable Ties

HellermannTyton SR255 Series heavy-duty cable ties offer a release feature in the head allowing for easy installation with the use of a cable tie tool. The head design guarantees high tensile strength even after repeated use, as well as a low insertion force.

Features and Benefits

- Impact-resistant, heat and UV stabilized releasable cable ties contain an impact modifier allowing greater flexibility and greater resistance to vibration.
- Special design offers a release feature for quick and easy access to wire bundles.
- Head design provides high tensile strength with very low insertion force even after repeated use.

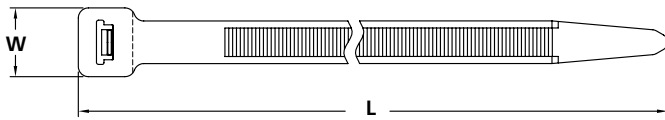

PART NO.	TYPE	Min. Tensile Strength lbs. (N)	Length (L) in. (mm)	Max. Bundle Diameter in. (mm)	Width (W) in. (mm)	Material	Color	Pkg. Qty.
SR255S0HIHSUVX2	SR255S	250.0 (1,115.0)	8.9 (225.0)	2.0 (50.0)	0.5 (12.6)	PA66HIRHSUV	Black	25
SR255X0HIHSUVX2	SR255X	250.0 (1,115.0)	14.6 (370.0)	3.9 (100.0)	0.5 (12.6)	PA66HIRHSUV	Black	25
SR255X0HIHSUVC2		250.0 (1,115.0)	14.6 (370.0)	3.9 (100.0)	0.5 (12.6)	PA66HIRHSUV	Black	100

Dimensions are approximate and subject to technical changes. Use Part No. for ordering and Type for specification purposes.
Installation tools: EVO9, EVO9HT, MK9P.

Releasable Cable Ties

RF Series

Releasable Cable Ties feature an integrated release mechanism on the head, allowing for changeouts without destroying the cable tie. The head design ensures consistently high tensile strength, even after repeated use. Rounded tail glides into head with low insertion force.

Features and Benefits

- Release feature allows maintenance or changeouts as needed.
- Polypropylene cable ties deliver excellent resistance to chemicals and salts.
- Inside serrations provide strong grip on cables and wire bundles.
- Reliable bundle fastening plus low insertion force for ease of use.

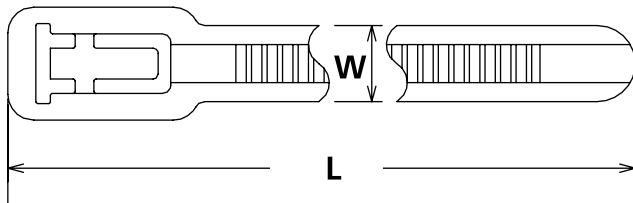

PART NO.	TYPE	Min. Tensile Strength lbs. (N)	Length (L) in. (mm)	Max. Bundle Diameter in. (mm)	Width (W) in. (mm)	Material	Color	Pkg. Qty.
115-00046	RF140	50.0 (222.3)	5.5 (140.0)	1.3 (32.0)	0.3 (7.4)	PA66	Black	100
115-00047		50.0 (222.3)	5.5 (140.0)	1.3 (32.0)	0.3 (7.4)	PA66	Natural	100
115-00049*	RF250	50.0 (222.3)	9.8 (250.0)	2.8 (72.0)	0.3 (7.4)	PA66	Black	100
115-00054		50.0 (222.3)	9.8 (250.0)	2.8 (72.0)	0.3 (7.4)	PA66	Natural	100

Dimensions are approximate and subject to technical changes. Use Part No. for ordering and Type for specification purposes.

Installation tools: EVO7, EVO7SP, EVO9, EVO9HT, MK7P, MK7HT, MK9P. *This product meets UL standards. Please see appendix for specific file numbers.



Please note! Not all products listed on this page may have this approval. Please check our website for latest approvals.

Bundling and Securing

Cable Ties

Clamp Ties

CTT Series in Natural and Black

HellermannTyton clamp tie has triangular shaped tabs extending beneath the head for optimal surface contact and complete circumferential compression to 360 degrees. The bent tail design allows quick and simple installations by hand. The clamps are recommended for soft rubber hose applications including fuel, water, and air vacuum lines.

Features and Benefits

- Head design contains clamping rails to provide full circumferential compression around bundles.
- Bent tail allows for quick insertion into head.

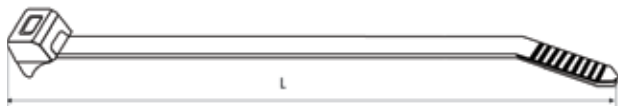
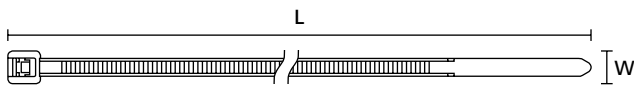

PART NO.	TYPE	Min. Tensile Strength lbs. (N)	Length (L) in. (mm)	Max. Bundle Diameter in. (mm)	Width (W) in. (mm)	Material	Color	Pkg. Qty.
CTT20R0C2*	CTT20R	20.0 (90.0)	4.0 (101.6)	0.5 (13.0)	0.1 (2.5)	PA66	Black	100
CTT20R9C2*		20.0 (90.0)	4.0 (101.6)	0.5 (13.0)	0.1 (2.5)	PA66	Natural	100
CTT20R0HSC2*		20.0 (90.0)	4.0 (101.6)	0.5 (13.0)	0.1 (2.5)	PA66HS	Black	100
CTT20R9M4*		20.0 (90.0)	4.0 (101.6)	0.5 (13.0)	0.1 (2.5)	PA66	Natural	1000
CTT20R0HSM4*		20.0 (90.0)	4.0 (101.6)	0.5 (13.0)	0.1 (2.5)	PA66HS	Black	1000
CTT60R0C2*	CTT60R	60.0 (265.0)	8.0 (205.0)	1.8 (45.0)	0.2 (4.7)	PA66	Black	100
CTT60R9C2*		60.0 (265.0)	8.0 (205.0)	1.8 (45.0)	0.2 (4.7)	PA66	Natural	100
CTT60R0HSC2*		60.0 (265.0)	8.0 (205.0)	1.8 (45.0)	0.2 (4.7)	PA66HS	Black	100
CTT60R0HIRC2		60.0 (265.0)	8.0 (205.0)	1.8 (45.0)	0.2 (4.7)	PA66HIRHSUV	Black	100
CTT60R9M4*		60.0 (265.0)	8.0 (205.0)	1.8 (45.0)	0.2 (4.7)	PA66	Natural	1000
CTT60R0HSM4*		60.0 (265.0)	8.0 (205.0)	1.8 (45.0)	0.2 (4.7)	PA66HS	Black	1000
CTT60R0HIRHSM4		60.0 (265.0)	8.0 (205.0)	1.8 (45.0)	0.2 (4.7)	PA66HIRHSUV	Black	1000

Dimensions are approximate and subject to technical changes. Use Part No. for ordering and Type for specification purposes.

Installation tools: EVO7, EVO7SP, EVO9, EVO9HT, MK7P, MK7HT, MK9P. *This product meets UL standards. Please see appendix for specific file numbers.



Please note! Not all products listed on this page may have this approval. Please check our website for latest approvals.

Double Head Ties

DH Series Cable Ties

The double head cable tie was designed with a dual locking head that creates two loops to secure two bundles simultaneously. The head also provides separation between bundles or bundles running parallel to each other. The bent tail design allows quick and simple installations by hand. For high volume applications, tensioning tools are available to ensure consistent and safe installation.

Features and Benefits

- Create separate bundles with only one cable tie.
- Cable tie with two heads can be used for parallel routing applications.

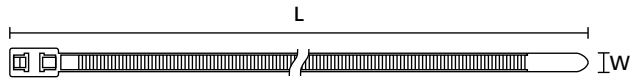

PART NO.	TYPE	Min. Tensile Strength lbs. (N)	Length (L) in. (mm)	Width (W) in. (mm)	Bundle Diameter Max. 1st Hole in. (mm)	Bundle Diameter Max. 2nd Hole in. (mm)	Material	Color	Pkg. Qty.
117-00018*	T50SDH	50.0 (225.0)	6.3 (159.0)	0.2 (4.7)	1.2 (31.0)	1.3 (32.0)	PA66	Black	100
117-00017*		50.0 (225.0)	6.3 (159.0)	0.2 (4.7)	1.2 (31.0)	1.3 (32.0)	PA66	Natural	1000
117-00019*		50.0 (225.0)	6.3 (159.0)	0.2 (4.7)	1.2 (31.0)	1.3 (32.0)	PA66	Black	1000
T50RDH9C2*	T50RDH	50.0 (225.0)	8.3 (210.0)	0.2 (4.7)	1.7 (44.4)	0.8 (19.0)	PA66	Natural	100
T50RDH0C2*		50.0 (225.0)	8.3 (210.0)	0.2 (4.7)	1.7 (44.4)	0.8 (19.0)	PA66	Black	100
T50RDH0UVC2		50.0 (225.0)	8.3 (210.0)	0.2 (4.7)	1.7 (44.4)	0.8 (19.0)	PA66UV	Black	100
T50RDH9M4*		50.0 (225.0)	8.3 (210.0)	0.2 (4.7)	1.7 (44.4)	0.8 (19.0)	PA66	Natural	1000
T50RDH0M4*		50.0 (225.0)	8.3 (210.0)	0.2 (4.7)	1.7 (44.4)	0.8 (19.0)	PA66	Black	1000
T50RDH0HSM4*		50.0 (225.0)	8.3 (210.0)	0.2 (4.7)	1.7 (44.4)	0.8 (19.0)	PA66HS	Black	1000

Dimensions are approximate and subject to technical changes. Use Part No. for ordering and Type for specification purposes.

Maximum bundle diameter is variable due to double loops. Installation tools: EVO7, EVO7SP, EVO9, EVO9HT, MK7P, MK7HT, MK9P. *This product meets UL standards. Please see appendix for specific file numbers.



Please note! Not all products listed on this page may have this approval. Please check our website for latest approvals.

Bundling and Securing

Cable Ties

Double Head Ties

DH Series Cable Ties

PART NO.	TYPE	Min. Tensile Strength lbs. (N)	Length (L) in. (mm)	Width (W) in. (mm)	Bundle Diameter Max. 1st Hole in. (mm)	Bundle Diameter Max. 2nd Hole in. (mm)	Material	Color	Pkg. Qty.
T50IDH9C2*	T50IDH	50.0 (225.0)	12.0 (305.0)	0.2 (4.7)	3.0 (76.2)	1.5 (38.1)	PA66	Natural	100
T50IDH0C2*		50.0 (225.0)	12.0 (305.0)	0.2 (4.7)	3.0 (76.2)	1.5 (38.1)	PA66	Black	100
T50IDH0UVC2*		50.0 (225.0)	12.0 (305.0)	0.2 (4.7)	3.0 (76.2)	1.5 (38.1)	PA66UV	Black	100
T50IDH9M4*		50.0 (225.0)	12.0 (305.0)	0.2 (4.7)	3.0 (76.2)	1.5 (38.1)	PA66	Natural	1000
T50IDH0M4*		50.0 (225.0)	12.0 (305.0)	0.2 (4.7)	3.0 (76.2)	1.5 (38.1)	PA66	Black	1000
T50IDH0HSM4*		50.0 (225.0)	12.0 (305.0)	0.2 (4.7)	3.0 (76.2)	1.5 (38.1)	PA66HS	Black	1000
T50LDH9C2*	T50LDH	50.0 (225.0)	15.6 (395.0)	0.2 (4.7)	4.0 (101.6)	2.0 (50.8)	PA66	Natural	100
T50LDH0C2*		50.0 (225.0)	15.6 (395.0)	0.2 (4.7)	4.0 (101.6)	2.0 (50.8)	PA66	Black	100
T50LDH0UVC2		50.0 (225.0)	15.6 (395.0)	0.2 (4.7)	4.0 (101.6)	2.0 (50.8)	PA66UV	Black	100
T50LDH9M4*		50.0 (225.0)	15.6 (395.0)	0.2 (4.7)	4.0 (101.6)	2.0 (50.8)	PA66	Natural	1000
T50LDH0M4*		50.0 (225.0)	15.6 (395.0)	0.2 (4.7)	4.0 (101.6)	2.0 (50.8)	PA66	Black	1000
T50LDH0HSM4*		50.0 (225.0)	15.6 (395.0)	0.2 (4.7)	4.0 (101.6)	2.0 (50.8)	PA66HS	Black	1000
T120RDH0K2*	T120RDH	120.0 (535.0)	15.7 (398.0)	0.3 (7.6)	4.0 (101.6)	2.0 (50.8)	PA66	Black	50
T120RDH0H4*		120.0 (535.0)	15.7 (398.0)	0.3 (7.6)	4.0 (101.6)	2.0 (50.8)	PA66	Black	500

Dimensions are approximate and subject to technical changes. Use Part No. for ordering and Type for specification purposes.

Maximum bundle diameter is variable due to double loops. Installation tools: EVO7, EVO7SP, EVO9, EVO9HT, MK7P, MK7HT, MK9P. *This product meets UL standards. Please see appendix for specific file numbers.



Please note! Not all products listed on this page may have this approval. Please check our website for latest approvals.

Identification Ties

IT Series Ties

Identification Cable Ties feature an identification plate that allows wire and cable bundles to be easily marked and identified. These ties enable wire and cables to be secured and identified using just one product, saving installation time. The plates can be marked using a permanent marker or with a HellermannTyton adhesive label.

Features and Benefits

- Identification plate feature allows bundles to be easily marked and identified.
- Wire and cable harnesses can be secured and identified using just one product, which saves time.
- Plates can be marked manually with a permanent marker or with a pre-printed adhesive label.

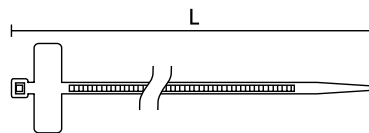

PART NO.	TYPE	Description	Min. Tensile Strength lbs. (N)	Length (L) in. (mm)	Max. Bundle Diameter in. (mm)	Material	Color	Pkg. Qty.
IT18R0C2*	IT18R	Marking pad size: .98" x .32" (25 x 8mm)	18.0 (80.0)	3.9 (100.0)	0.8 (19.0)	PA66	Black	100
IT18R0L4*		Marking pad size: .98" x .32" (25 x 8mm)	18.0 (80.0)	3.9 (100.0)	0.8 (19.0)	PA66	Black	200
IT18R9C2*		Marking pad size: .98" x .32" (25 x 8mm)	18.0 (80.0)	3.9 (100.0)	0.8 (19.0)	PA66	Natural	100
IT18R9L4*		Marking pad size: .98" x .32" (25 x 8mm)	18.0 (80.0)	3.9 (100.0)	0.8 (19.0)	PA66	Natural	200
IT18R2C2*		Marking pad size: .98" x .32" (25 x 8mm)	18.0 (80.0)	3.9 (100.0)	0.8 (19.0)	PA66	Red	100
IT18R2L4*		Marking pad size: .98" x .32" (25 x 8mm)	18.0 (80.0)	3.9 (100.0)	0.8 (19.0)	PA66	Red	200
IT18R3C2*		Marking pad size: .98" x .32" (25 x 8mm)	18.0 (80.0)	3.9 (100.0)	0.8 (19.0)	PA66	Orange	100
IT18R3L4*		Marking pad size: .98" x .32" (25 x 8mm)	18.0 (80.0)	3.9 (100.0)	0.8 (19.0)	PA66	Orange	200
IT18R4L4*		Marking pad size: .98" x .32" (25 x 8mm)	18.0 (80.0)	3.9 (100.0)	0.8 (19.0)	PA66	Yellow	200
IT18R6C2*		Marking pad size: .98" x .32" (25 x 8mm)	18.0 (80.0)	3.9 (100.0)	0.8 (19.0)	PA66	Blue	100
IT18R6L4*		Marking pad size: .98" x .32" (25 x 8mm)	18.0 (80.0)	3.9 (100.0)	0.8 (19.0)	PA66	Blue	200
IT18R8C2*		Marking pad size: .98" x .32" (25 x 8mm)	18.0 (80.0)	3.9 (100.0)	0.8 (19.0)	PA66	Gray	100
IT18R10C2*		Marking pad size: .98" x .32" (25 x 8mm)	18.0 (80.0)	3.9 (100.0)	0.8 (19.0)	PA66	White	100
IT18R10L4*		Marking pad size: .98" x .32" (25 x 8mm)	18.0 (80.0)	3.9 (100.0)	0.8 (19.0)	PA66	White	200

Dimensions are approximate and subject to technical changes. Use Part No. for ordering and Type for specification purposes.

Installation tools: EVO7, EVO7SP, EVO9, EVO9HT, MK7P, MK7HT, MK9P. Military black available, contact HellermannTyton for more information. *This product meets UL standards. Please see appendix for specific file numbers.



Please note! Not all products listed on this page may have this approval. Please check our website for latest approvals.

Bundling and Securing

Cable Ties

Identification Ties

IT Series Ties

PART NO.	TYPE	Description	Min. Tensile Strength lbs. (N)	Length (L) in. (mm)	Max. Bundle Diameter in. (mm)	Material	Color	Pkg. Qty.
IT18FL0C2*	IT18FL	Marking pad size: .81" x .35" (20.5 x 9mm)	18.0 (80.0)	4.3 (110.0)	0.8 (19.0)	PA66	Black	100
IT18FL0L4*		Marking pad size: .81" x .35" (20.5 x 9mm)	18.0 (80.0)	4.3 (110.0)	0.8 (19.0)	PA66	Black	200
IT18FL9C2*		Marking pad size: .81" x .35" (20.5 x 9mm)	18.0 (80.0)	4.3 (110.0)	0.8 (19.0)	PA66	Natural	100
IT18FL9L4*		Marking pad size: .81" x .35" (20.5 x 9mm)	18.0 (80.0)	4.3 (110.0)	0.8 (19.0)	PA66	Natural	200
IT18FL2L4*		Marking pad size: .81" x .35" (20.5 x 9mm)	18.0 (80.0)	4.3 (110.0)	0.8 (19.0)	PA66	Red	200
IT18FL3L4*		Marking pad size: .81" x .35" (20.5 x 9mm)	18.0 (80.0)	4.3 (110.0)	0.8 (19.0)	PA66	Orange	200
IT18FL4L4*		Marking pad size: .81" x .35" (20.5 x 9mm)	18.0 (80.0)	4.3 (110.0)	0.8 (19.0)	PA66	Yellow	200
IT18FL6L4*		Marking pad size: .81" x .35" (20.5 x 9mm)	18.0 (80.0)	4.3 (110.0)	0.8 (19.0)	PA66	Blue	200
IT18FL10L4*		Marking pad size: .81" x .35" (20.5 x 9mm)	18.0 (80.0)	4.3 (110.0)	0.8 (19.0)	PA66	White	200
IT50R0C2*		IT50R	Marking pad size: 1.10" x .51" (28 x 12.9mm)	50.0 (225.0)	8.0 (203.0)	1.8 (44.5)	PA66	Black
IT50R0M4*	Marking pad size: 1.10" x .51" (28 x 12.9mm)		50.0 (225.0)	8.0 (203.0)	1.8 (44.5)	PA66	Black	1000
IT50R9C2*	Marking pad size: 1.10" x .51" (28 x 12.9mm)		50.0 (225.0)	8.0 (203.0)	1.8 (44.5)	PA66	Natural	100
IT50R9M4*	Marking pad size: 1.10" x .51" (28 x 12.9mm)		50.0 (225.0)	8.0 (203.0)	1.8 (44.5)	PA66	Natural	1000
IT50R2C2*	Marking pad size: 1.10" x .51" (28 x 12.9mm)		50.0 (225.0)	8.0 (203.0)	1.8 (44.5)	PA66	Red	100
IT50R3M4*	Marking pad size: 1.10" x .51" (28 x 12.9mm)		50.0 (225.0)	8.0 (203.0)	1.8 (44.5)	PA66	Orange	1000
IT50R4C2*	Marking pad size: 1.10" x .51" (28 x 12.9mm)		50.0 (225.0)	8.0 (203.0)	1.8 (44.5)	PA66	Yellow	100
IT50R10C2*	Marking pad size: 1.10" x .51" (28 x 12.9mm)		50.0 (225.0)	8.0 (203.0)	1.8 (44.5)	PA66	White	100
IT50RD0K2*	IT50RD	Marking pad size: 1.14" x 1.04" (29 x 26.3mm)	50.0 (225.0)	8.0 (205.0)	1.7 (44.0)	PA66	Black	50
IT50RD9K2*		Marking pad size: 1.14" x 1.04" (29 x 26.3mm)	50.0 (225.0)	8.0 (205.0)	1.7 (44.0)	PA66	Natural	50
IT50RD4K2*		Marking pad size: 1.14" x 1.04" (29 x 26.3mm)	50.0 (225.0)	8.0 (205.0)	1.7 (44.0)	PA66	Yellow	50

Dimensions are approximate and subject to technical changes. Use Part No. for ordering and Type for specification purposes.

Installation tools: EVO7, EVO7SP, EVO9, EVO9HT, MK7P, MK7HT, MK9P. Military black available, contact HellermannTyton for more information. *This product meets UL standards. Please see appendix for specific file numbers.



Please note! Not all products listed on this page may have this approval. Please check our website for latest approvals.

Identification Ties

IT Series Ties

PART NO.	TYPE	Description	Min. Tensile Strength lbs. (N)	Length (L) in. (mm)	Max. Bundle Diameter in. (mm)	Material	Color	Pkg. Qty.
IT50RT0K2*	IT50RT	Marking pad size: 1.81" x 1.04" (46 x 26.3mm)	50.0 (225.0)	8.0 (205.0)	1.7 (44.0)	PA66	Black	50
IT50RT9K2*		Marking pad size: 1.81" x 1.04" (46 x 26.3mm)	50.0 (225.0)	8.0 (205.0)	1.7 (44.0)	PA66	Natural	50
IT50RT4K2*		Marking pad size: 1.81" x 1.04" (46 x 26.3mm)	50.0 (225.0)	8.0 (205.0)	1.7 (44.0)	PA66	Yellow	50
IT50L0M4*	IT50L	Marking pad size: .5" x 2.20" (12.8 x 56mm)	50.0 (225.0)	15.4 (390.0)	3.9 (100.0)	PA66	Black	1000
IT50L9C2*		Marking pad size: .5" x 2.20" (12.8 x 56mm)	50.0 (225.0)	15.4 (390.0)	3.9 (100.0)	PA66	Natural	100
IT50L3M4*		Marking pad size: .5" x 2.20" (12.8 x 56mm)	50.0 (225.0)	15.4 (390.0)	3.9 (100.0)	PA66	Orange	1000
IT50L4M4*		Marking pad size: .5" x 2.20" (12.8 x 56mm)	50.0 (225.0)	15.4 (390.0)	3.9 (100.0)	PA66	Yellow	1000
IT50L6M4*		Marking pad size: .5" x 2.20" (12.8 x 56mm)	50.0 (225.0)	15.4 (390.0)	3.9 (100.0)	PA66	Blue	1000

Dimensions are approximate and subject to technical changes. Use Part No. for ordering and Type for specification purposes.

Installation tools: EVO7, EVO7SP, EVO9, EVO9HT, MK7P, MK7HT, MK9P. Military black available, contact HellermannTyton for more information. *This product meets UL standards. Please see appendix for specific file numbers.



Please note! Not all products listed on this page may have this approval. Please check our website for latest approvals.

Bundling and Securing

Cable Ties

Stainless Steel Cable Ties

MBT Series in 304 Material

HellermannTyton's stainless steel ties are designed with a ball bearing locking mechanism to assure high tensile strength and easy insertion when securing hoses, cables, pipes, and more. Stainless steel ties can be used in virtually any indoor, outdoor, or underground application. Grade 304 material is commonly used for stainless steel bundling applications and suits most general purpose requirements. It features the ability to withstand most environmental conditions, particularly in applications where vibration, general weathering, radiation, and temperature extremes are a concern.

Features and Benefits

- Self locking, ball bearing mechanism assures high tensile strength and easy insertion.
- Fully enclosed head does not allow dirt or grit to interfere with locking mechanism.
- High tensile strength for dependability and safety on heavy duty applications.



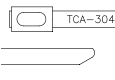
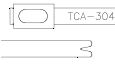
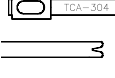
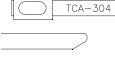
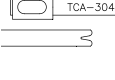
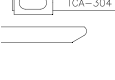

PART NO.	TYPE	Min. Tensile Strength lbs. (N)	Length (L) in. (mm)	Max. Bundle Diameter in. (mm)	Width (W) in. (mm)	Pkg. Qty.	Drawing
MBT55-S	MBT55S	202.0 (900.0)	5.0 (127.0)	1.0 (25.0)	0.2 (4.6)	100	
MBT85-S	MBT85S	202.0 (900.0)	7.9 (201.0)	2.0 (50.0)	0.2 (4.6)	100	
MBT145-S	MBT145S	202.0 (900.0)	14.3 (362.0)	4.0 (102.0)	0.2 (4.6)	100	
MBT205-S	MBT205S	202.0 (900.0)	20.5 (521.0)	6.0 (152.0)	0.2 (4.6)	100	
MBT275-S	MBT275S	202.0 (900.0)	27.0 (685.0)	8.0 (203.0)	0.2 (4.6)	100	
MBT335-S	MBT335S	202.0 (900.0)	33.0 (838.0)	10.0 (254.0)	0.2 (4.6)	100	

Dimensions are approximate and subject to technical changes. Use Part No. for ordering and Type for specification purposes.

Installation tool: MK95ST. Stainless steel ties and materials should be tested thoroughly under end-use conditions to determine suitability for the application.

Stainless Steel Cable Ties

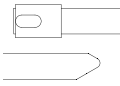
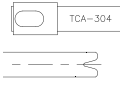
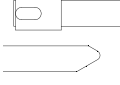
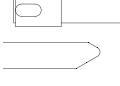
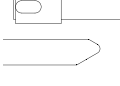
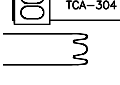
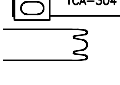
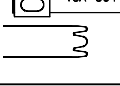
MBT Series in 304 Material

PART NO.	TYPE	Min. Tensile Strength lbs. (N)	Length (L) in. (mm)	Max. Bundle Diameter in. (mm)	Width (W) in. (mm)	Pkg. Qty.	Drawing
MBT8H-S	MBT8HS	450.0 (2,000.0)	7.9 (201.0)	2.0 (50.0)	0.3 (7.9)	50	
MBT14H-S	MBT14HS	450.0 (2,000.0)	14.3 (362.0)	4.0 (102.0)	0.3 (7.9)	50	
MBT20H-S	MBT20HS	450.0 (2,000.0)	20.5 (521.0)	6.0 (152.0)	0.3 (7.9)	50	
MBT27H-S	MBT27HS	450.0 (2,000.0)	27.0 (685.0)	8.0 (203.0)	0.3 (7.9)	50	
MBT33H-S	MBT33HS	450.0 (2,000.0)	33.0 (838.0)	10.0 (254.0)	0.3 (7.9)	50	
111-95148	MBT14XHS	607.0 (2,700.0)	14.3 (362.0)	4.0 (102.0)	0.5 (12.3)	50	
111-95208	MBT20XHS	607.0 (2,700.0)	20.5 (521.0)	6.0 (152.0)	0.5 (12.3)	50	
111-95278	MBT27XHS	607.0 (2,700.0)	26.8 (681.0)	8.0 (203.0)	0.5 (12.3)	50	
111-95338	MBT33XHS	607.0 (2,700.0)	33.0 (838.0)	10.0 (254.0)	0.5 (12.3)	50	

Dimensions are approximate and subject to technical changes. Use Part No. for ordering and Type for specification purposes.

Installation tool: MK95ST. Stainless steel ties and materials should be tested thoroughly under end-use conditions to determine suitability for the application.

Bundling and Securing

Cable Ties

Stainless Steel Cable Ties

MBT Series in 316 Material

HellermannTyton's stainless steel ties are designed with a ball bearing locking mechanism to assure high tensile strength and easy insertion when securing hoses, cables, pipes, and more. Stainless steel ties can be used in virtually any indoor, outdoor, or underground application. Grade 316 material is highly resistant to corrosion and widely used in marine environments where chemicals, salts, acids, and temperature extremes may affect the bundling application. MBT stainless steel ties in 316 stainless steel material are also available with a polyester protective coating. This coating creates a barrier and protectant from chemical reactions of dissimilar metals.



Features and Benefits

- Self locking, ball bearing mechanism for quick and easy installation, either by hand or by tensioning tool.
- Fully enclosed head prevents dirt or grit from interfering with locking mechanism.
- High tensile strength for maximum strength and safety on heavy duty applications.

PART NO.	TYPE	Min. Tensile Strength lbs. (N)	Length (L) in. (mm)	Max. Bundle Diameter in. (mm)	Width (W) in. (mm)	Pkg. Qty.	Drawing
MBT5S	MBT5S	202.0 (900.0)	5.0 (127.0)	1.0 (25.0)	0.2 (4.6)	100	
MBT8S	MBT8S	202.0 (900.0)	7.9 (201.0)	2.0 (50.0)	0.2 (4.6)	100	
MBT14S	MBT14S	202.0 (900.0)	14.3 (362.0)	4.0 (102.0)	0.2 (4.6)	100	
MBT20S	MBT20S	202.0 (900.0)	20.5 (521.0)	6.0 (152.0)	0.2 (4.6)	100	
MBT27S	MBT27S	202.0 (900.0)	27.0 (685.0)	8.0 (203.0)	0.2 (4.6)	100	

Dimensions are approximate and subject to technical changes. Use Part No. for ordering and Type for specification purposes.

Installation tool: MK95ST. Stainless steel ties and materials should be tested thoroughly under end-use conditions to determine suitability for the application.



Please note! Not all products listed on this page may have this approval. Please check our website for latest approvals.

Stainless Steel Cable Ties

MBT Series in 316 Material

PART NO.	TYPE	Min. Tensile Strength lbs. (N)	Length (L) in. (mm)	Max. Bundle Diameter in. (mm)	Width (W) in. (mm)	Pkg. Qty.	Drawing
MBT33S	MBT33S	202.0 (900.0)	33.0 (838.0)	10.0 (254.0)	0.2 (4.6)	100	
MBT8H	MBT8H	450.0 (2,000.0)	7.9 (201.0)	2.0 (50.0)	0.3 (7.9)	50	
MBT14H	MBT14H	450.0 (2,000.0)	14.3 (362.0)	4.0 (102.0)	0.3 (7.9)	50	
MBT20H	MBT20H	450.0 (2,000.0)	20.5 (521.0)	6.0 (152.0)	0.3 (7.9)	50	
MBT27H	MBT27H	450.0 (2,000.0)	27.0 (685.0)	8.0 (203.0)	0.3 (7.9)	50	
MBT33H	MBT33H	450.0 (2,000.0)	33.0 (838.0)	10.0 (254.0)	0.3 (7.9)	50	
111-95149	MBT14XH	607.0 (2,700.0)	14.3 (362.0)	4.0 (102.0)	0.5 (12.3)	50	
111-95209	MBT20XH	607.0 (2,700.0)	20.5 (521.0)	6.0 (152.0)	0.5 (12.3)	50	
111-95279	MBT27XH	607.0 (2,700.0)	26.8 (681.0)	8.0 (203.0)	0.5 (12.3)	50	

Dimensions are approximate and subject to technical changes. Use Part No. for ordering and Type for specification purposes.

Installation tool: MK95ST. Stainless steel ties and materials should be tested thoroughly under end-use conditions to determine suitability for the application.



Please note! Not all products listed on this page may have this approval. Please check our website for latest approvals.

Bundling and Securing

Cable Ties

Stainless Steel Cable Ties

MBT Series in 316 Material

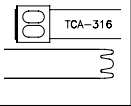
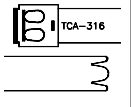
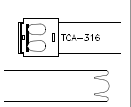
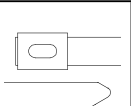
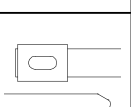
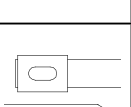
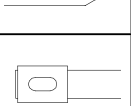
PART NO.	TYPE	Min. Tensile Strength lbs. (N)	Length (L) in. (mm)	Max. Bundle Diameter in. (mm)	Width (W) in. (mm)	Pkg. Qty.	Drawing
111-95339	MBT33XH	607.0 (2,700.0)	33.0 (838.0)	10.0 (254.0)	0.5 (12.3)	50	
111-01301	MBT14UH	922.0 (4,100.0)	14.3 (362.0)	4.0 (102.0)	0.6 (16.0)	50	
111-01302	MBT20UH	922.0 (4,100.0)	20.5 (521.0)	6.0 (152.0)	0.6 (16.0)	50	
111-01303	MBT27UH	922.0 (4,100.0)	26.8 (681.0)	8.0 (203.0)	0.6 (16.0)	50	
111-01304	MBT33UH	922.0 (4,100.0)	33.0 (838.0)	10.0 (254.0)	0.6 (16.0)	50	
111-01305	MBT43UH	922.0 (4,100.0)	43.0 (1,092.0)	13.0 (330.0)	0.6 (16.0)	25	
111-01306	MBT49UH	922.0 (4,100.0)	49.0 (1,245.0)	15.0 (380.0)	0.6 (16.0)	25	

Dimensions are approximate and subject to technical changes. Use Part No. for ordering and Type for specification purposes.

Installation tool: MK9SST. Stainless steel ties and materials should be tested thoroughly under end-use conditions to determine suitability for the application.



Please note! Not all products listed on this page may have this approval. Please check our website for latest approvals.

Hook and Loop Grip Ties

Grip Tie Straps in 6" and 8" Lengths

The Grip Tie is a low-profile, one-piece fastening device. Constructed of a hook and loop design, laminated back to back, the Grip Tie features quick release for repetitive access to cable and wire. Reusable, adjustable, releasable, and easy to install, it can be successfully opened and closed numerous times. Grip Ties are available in a variety of colors and are versatile enough for applications ranging from network installations to bundling power cords.

Features and Benefits

- Features quick release for repetitive access to cable and wire.
- Can be opened and closed numerous times without failure.
- Adjustable so one size can accommodate multiple bundle diameters.

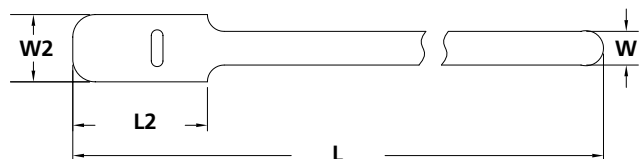

PART NO.	TYPE	Min. Tensile Strength lbs. (N)	Length (L) in. (mm)	Max. Bundle Diameter in. (mm)	Width (W) in. (mm)	Width (W2) in. (mm)	Length (L2) in. (mm)	Material	Color	Pkg. Qty.	
GT.375X60C2	GT.375X6	40.0 (177.9)	6.0 (152.4)	1.0 (25.4)	0.4 (9.5)	0.8 (19.1)	1.5 (38.1)	PA66, PE	Black	100	
GT.50X60P2*	GT.50X6	40.0 (177.9)	6.0 (152.4)	1.0 (25.4)	0.5 (12.7)	1.0 (25.4)	1.5 (38.1)	PA66, PE	Black	10	
GT.50X60C2*		40.0 (177.9)	6.0 (152.4)	1.0 (25.4)	0.5 (12.7)	1.0 (25.4)	1.5 (38.1)	PA66, PE	Black	100	
GT.50X62P2*		40.0 (177.9)	6.0 (152.4)	1.0 (25.4)	0.5 (12.7)	1.0 (25.4)	1.5 (38.1)	PA66, PE	Red	10	
GT.50X62C2*		40.0 (177.9)	6.0 (152.4)	1.0 (25.4)	0.5 (12.7)	1.0 (25.4)	1.5 (38.1)	PA66, PE	Red	100	
GT.50X63P2*		40.0 (177.9)	6.0 (152.4)	1.0 (25.4)	0.5 (12.7)	1.0 (25.4)	1.5 (38.1)	PA66, PE	Orange	10	
GT.50X63C2*		40.0 (177.9)	6.0 (152.4)	1.0 (25.4)	0.5 (12.7)	1.0 (25.4)	1.5 (38.1)	PA66, PE	Orange	100	
GT.50X64P2*		40.0 (177.9)	6.0 (152.4)	1.0 (25.4)	0.5 (12.7)	1.0 (25.4)	1.5 (38.1)	PA66, PE	Yellow	10	
GT.50X64C2*		40.0 (177.9)	6.0 (152.4)	1.0 (25.4)	0.5 (12.7)	1.0 (25.4)	1.5 (38.1)	PA66, PE	Yellow	100	
GT.50X65P2*		40.0 (177.9)	6.0 (152.4)	1.0 (25.4)	0.5 (12.7)	1.0 (25.4)	1.5 (38.1)	PA66, PE	Green	10	
GT.50X65C2*		40.0 (177.9)	6.0 (152.4)	1.0 (25.4)	0.5 (12.7)	1.0 (25.4)	1.5 (38.1)	PA66, PE	Green	100	
GT.50X66P2*		40.0 (177.9)	6.0 (152.4)	1.0 (25.4)	0.5 (12.7)	1.0 (25.4)	1.5 (38.1)	PA66, PE	Blue	10	
GT.50X66C2*		40.0 (177.9)	6.0 (152.4)	1.0 (25.4)	0.5 (12.7)	1.0 (25.4)	1.5 (38.1)	PA66, PE	Blue	100	
GT.50X80P2*		GT.50X8	40.0 (177.9)	8.0 (203.2)	1.8 (44.5)	0.5 (12.7)	1.0 (25.4)	1.5 (38.1)	PA66, PE	Black	10
GT.50X80C2*			40.0 (177.9)	8.0 (203.2)	1.8 (44.5)	0.5 (12.7)	1.0 (25.4)	1.5 (38.1)	PA66, PE	Black	100
GT.50X82P2*	40.0 (177.9)		8.0 (203.2)	1.8 (44.5)	0.5 (12.7)	1.0 (25.4)	1.5 (38.1)	PA66, PE	Red	10	
GT.50X82C2*	40.0 (177.9)		8.0 (203.2)	1.8 (44.5)	0.5 (12.7)	1.0 (25.4)	1.5 (38.1)	PA66, PE	Red	100	
GT.50X83P2*	40.0 (177.9)		8.0 (203.2)	1.8 (44.5)	0.5 (12.7)	1.0 (25.4)	1.5 (38.1)	PA66, PE	Orange	10	
GT.50X83C2*	40.0 (177.9)		8.0 (203.2)	1.8 (44.5)	0.5 (12.7)	1.0 (25.4)	1.5 (38.1)	PA66, PE	Orange	100	
GT.50X84P2*	40.0 (177.9)		8.0 (203.2)	1.8 (44.5)	0.5 (12.7)	1.0 (25.4)	1.5 (38.1)	PA66, PE	Yellow	10	
GT.50X84C2*	40.0 (177.9)		8.0 (203.2)	1.8 (44.5)	0.5 (12.7)	1.0 (25.4)	1.5 (38.1)	PA66, PE	Yellow	100	
GT.50X85P2*	40.0 (177.9)		8.0 (203.2)	1.8 (44.5)	0.5 (12.7)	1.0 (25.4)	1.5 (38.1)	PA66, PE	Green	10	
GT.50X85C2*	40.0 (177.9)		8.0 (203.2)	1.8 (44.5)	0.5 (12.7)	1.0 (25.4)	1.5 (38.1)	PA66, PE	Green	100	
GT.50X86P2*	40.0 (177.9)		8.0 (203.2)	1.8 (44.5)	0.5 (12.7)	1.0 (25.4)	1.5 (38.1)	PA66, PE	Blue	10	
GT.50X86C2*	40.0 (177.9)		8.0 (203.2)	1.8 (44.5)	0.5 (12.7)	1.0 (25.4)	1.5 (38.1)	PA66, PE	Blue	100	

Dimensions are approximate and subject to technical changes. Use Part No. for ordering and Type for specification purposes.

*This product meets UL standards. Please see appendix for specific file numbers.



Please note! Not all products listed on this page may have this approval. Please check our website for latest approvals.

Bundling and Securing

Cable Ties

Hook and Loop Grip Ties

Grip Tie Straps in 11" and 15" Lengths

The Grip Tie is a low-profile, one-piece fastening device. Constructed of a hook and loop design, laminated back to back, the Grip Tie features quick release for repetitive access to cable and wire. Reusable, adjustable, releasable, and easy to install, it can be successfully opened and closed numerous times. Grip Ties are available in a variety of colors and are versatile enough for applications ranging from network installations to bundling power cords.

Features and Benefits

- Features quick release for repetitive access to cable and wire.
- Can be opened and closed numerous times without failure.
- Adjustable so one size can accommodate multiple bundle diameters.

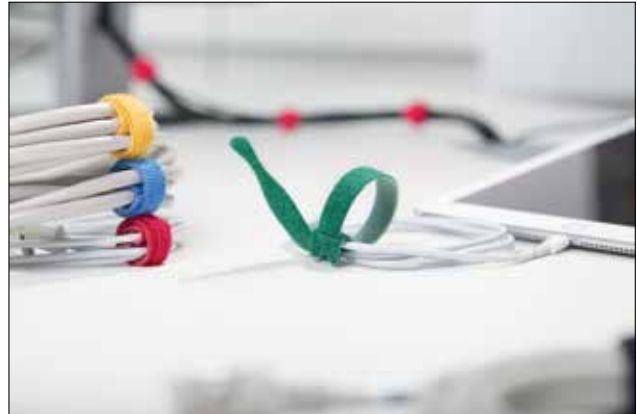

PART NO.	TYPE	Min. Tensile Strength lbs. (N)	Length (L) in. (mm)	Max. Bundle Diameter in. (mm)	Width (W) in. (mm)	Width (W2) in. (mm)	Length (L2) in. (mm)	Material	Color	Pkg. Qty.
GT.50X110P2*	GT.50X11	40.0 (177.9)	11.0 (279.4)	2.6 (66.8)	0.5 (12.7)	1.0 (25.4)	1.5 (38.1)	PA66, PE	Black	10
GT.50X110C2*		40.0 (177.9)	11.0 (279.4)	2.6 (66.8)	0.5 (12.7)	1.0 (25.4)	1.5 (38.1)	PA66, PE	Black	100
GT.50X112P2*		40.0 (177.9)	11.0 (279.4)	2.6 (66.8)	0.5 (12.7)	1.0 (25.4)	1.5 (38.1)	PA66, PE	Red	10
GT.50X112C2*		40.0 (177.9)	11.0 (279.4)	2.6 (66.8)	0.5 (12.7)	1.0 (25.4)	1.5 (38.1)	PA66, PE	Red	100
GT.50X113P2*		40.0 (177.9)	11.0 (279.4)	2.6 (66.8)	0.5 (12.7)	1.0 (25.4)	1.5 (38.1)	PA66, PE	Orange	10
GT.50X113C2*		40.0 (177.9)	11.0 (279.4)	2.6 (66.8)	0.5 (12.7)	1.0 (25.4)	1.5 (38.1)	PA66, PE	Orange	100
GT.50X114P2*		40.0 (177.9)	11.0 (279.4)	2.6 (66.8)	0.5 (12.7)	1.0 (25.4)	1.5 (38.1)	PA66, PE	Yellow	10
GT.50X114C2*		40.0 (177.9)	11.0 (279.4)	2.6 (66.8)	0.5 (12.7)	1.0 (25.4)	1.5 (38.1)	PA66, PE	Yellow	100
GT.50X115P2*		40.0 (177.9)	11.0 (279.4)	2.6 (66.8)	0.5 (12.7)	1.0 (25.4)	1.5 (38.1)	PA66, PE	Green	10
GT.50X115C2*		40.0 (177.9)	11.0 (279.4)	2.6 (66.8)	0.5 (12.7)	1.0 (25.4)	1.5 (38.1)	PA66, PE	Green	100
GT.50X116P2*		40.0 (177.9)	11.0 (279.4)	2.6 (66.8)	0.5 (12.7)	1.0 (25.4)	1.5 (38.1)	PA66, PE	Blue	10
GT.50X116C2*		40.0 (177.9)	11.0 (279.4)	2.6 (66.8)	0.5 (12.7)	1.0 (25.4)	1.5 (38.1)	PA66, PE	Blue	100

Dimensions are approximate and subject to technical changes. Use Part No. for ordering and Type for specification purposes.

*This product meets UL standards. Please see appendix for specific file numbers.



Please note! Not all products listed on this page may have this approval. Please check our website for latest approvals.

Hook and Loop Grip Ties

Grip Tie Straps in 11" and 15" Lengths

PART NO.	TYPE	Min. Tensile Strength lbs. (N)	Length (L) in. (mm)	Max. Bundle Diameter in. (mm)	Width (W) in. (mm)	Width (W2) in. (mm)	Length (L2) in. (mm)	Material	Color	Pkg. Qty.
GT.75X150P2*	GT.75X15	50.0 (222.4)	15.0 (381.0)	3.9 (98.6)	0.8 (19.1)	1.5 (38.1)	2.5 (63.5)	PA66, PE	Black	10
GT.75X150C2*		50.0 (222.4)	15.0 (381.0)	3.9 (98.6)	0.8 (19.1)	1.5 (38.1)	2.5 (63.5)	PA66, PE	Black	100
GT.75X152P2*		50.0 (222.4)	15.0 (381.0)	3.9 (98.6)	0.8 (19.1)	1.5 (38.1)	2.5 (63.5)	PA66, PE	Red	10
GT.75X152C2*		50.0 (222.4)	15.0 (381.0)	3.9 (98.6)	0.8 (19.1)	1.5 (38.1)	2.5 (63.5)	PA66, PE	Red	100
GT.75X153P2*		50.0 (222.4)	15.0 (381.0)	3.9 (98.6)	0.8 (19.1)	1.5 (38.1)	2.5 (63.5)	PA66, PE	Orange	10
GT.75X153C2*		50.0 (222.4)	15.0 (381.0)	3.9 (98.6)	0.8 (19.1)	1.5 (38.1)	2.5 (63.5)	PA66, PE	Orange	100
GT.75X154P2*		50.0 (222.4)	15.0 (381.0)	3.9 (98.6)	0.8 (19.1)	1.5 (38.1)	2.5 (63.5)	PA66, PE	Yellow	10
GT.75X154C2*		50.0 (222.4)	15.0 (381.0)	3.9 (98.6)	0.8 (19.1)	1.5 (38.1)	2.5 (63.5)	PA66, PE	Yellow	100
GT.75X155P2*		50.0 (222.4)	15.0 (381.0)	3.9 (98.6)	0.8 (19.1)	1.5 (38.1)	2.5 (63.5)	PA66, PE	Green	10
GT.75X155C2*		50.0 (222.4)	15.0 (381.0)	3.9 (98.6)	0.8 (19.1)	1.5 (38.1)	2.5 (63.5)	PA66, PE	Green	100
GT.75X156P2*		50.0 (222.4)	15.0 (381.0)	3.9 (98.6)	0.8 (19.1)	1.5 (38.1)	2.5 (63.5)	PA66, PE	Blue	10
GT.75X156C2*		50.0 (222.4)	15.0 (381.0)	3.9 (98.6)	0.8 (19.1)	1.5 (38.1)	2.5 (63.5)	PA66, PE	Blue	100

Dimensions are approximate and subject to technical changes. Use Part No. for ordering and Type for specification purposes.

*This product meets UL standards. Please see appendix for specific file numbers.



Please note! Not all products listed on this page may have this approval. Please check our website for latest approvals.

Bundling and Securing

Cable Ties

Hook and Loop Grip Ties

Grip Tie Rolls

For custom-cut lengths, HellermannTyton offers the hook and loop strap on five-yard and 25-yard rolls. Ideal for jobsites where custom lengths are needed. The Grip Tie is a low-profile, one-piece fastening device. Constructed of a hook and loop design, laminated back to back, the Grip Tie features quick release for repetitive access to cable and wire. Grip Ties are available in a variety of colors and are versatile enough for applications ranging from network installations to bundling power cords.

Features and Benefits

- Features quick release for repetitive access to cable and wire.
- Can be opened and closed numerous times without failure.
- Supplied on a roll to create custom lengths on demand.



PART NO.	TYPE	Length (L) ft. (m)	Width (W) in. (mm)	Material	Color	Pkg. Qty.
GT.75X1800*	GT.75X180	15.0 (4.5)	0.8 (19.1)	PA66, PE	Black	1
GT.75X1802*		15.0 (4.5)	0.8 (19.1)	PA66, PE	Red	1
GT.75X1803*		15.0 (4.5)	0.8 (19.1)	PA66, PE	Orange	1
GT.75X1804*		15.0 (4.5)	0.8 (19.1)	PA66, PE	Yellow	1
GT.75X1805*		15.0 (4.5)	0.8 (19.1)	PA66, PE	Green	1
GT.75X1806*		15.0 (4.5)	0.8 (19.1)	PA66, PE	Blue	1
GT.75X18010*		15.0 (4.5)	0.8 (19.1)	PA66, PE	White	1
GT.75X1800W*	GT.75X180W	15.0 (4.5)	0.8 (19.1)	PA66, PE	Black	1
GT.75X6000	GT.75X600	50.0 (15.2)	0.8 (19.1)	PA66, PE	Black	1
GT.75X9000	GT.75X900	75.0 (22.9)	0.8 (19.1)	PA66, PE	Black	1
GT.75X9004		75.0 (22.9)	0.8 (19.1)	PA66, PE	Yellow	1

Dimensions are approximate and subject to technical changes. Use Part No. for ordering and Type for specification purposes.
*This product meets UL standards. Please see appendix for specific file numbers.



Please note! Not all products listed on this page may have this approval. Please check our website for latest approvals.

Hook and Loop Grip Ties

Low-Profile Grip Ties

The Low-Profile Grip Tie is a self gripping hook and loop strap that can be easily wrapped around a bundled and fastened onto themselves for a secure hold. The modest thickness of the back-to-back hook and loop is ideal for small areas without the worry of snagging.

Features and Benefits

- Features quick release for repetitive access to cable and wire.
- Can be opened and closed numerous times without failure.
- Head size is twice as wide as the strap to provide extra strength.
- Low-profile design provides dependable cable management in tight spaces.



PART NO.	TYPE	Length (L) in. (mm)	Width (W) in. (mm)	Width (W2) in. (mm)	Length (L2) in. (mm)	Material	Color	Pkg. Qty.
GTLP50X60P2	GTLP50X6	6.0 (152.4)	0.5 (12.7)	1.5 (25.4)	1.5 (38.1)	PA66, PE	Black	10
GTLP50X80P2	GTLP50X8	8.0 (203.2)	0.5 (12.7)	1.5 (25.4)	1.5 (38.1)	PA66, PE	Black	10
GTLP50X110P2	GTLP50X11	11.0 (279.4)	0.5 (12.7)	1.5 (25.4)	1.5 (38.1)	PA66, PE	Black	10

Dimensions are approximate and subject to technical changes. Use Part No. for ordering and Type for specification purposes.

Bundling and Securing

Cable Ties

Hook and Loop Grip Ties

Grip Ties for Plenum Applications

HellermannTyton offers UL 94 V-2 flame rated Grip Ties for use in air handling spaces. Grip Ties are UL Listed in accordance with the National Electric Code regulations. Grip Ties are low-profile, one-piece fastening devices. Constructed of a hook and loop design, laminated back to back, the Grip Tie features quick release for repetitive access to cable and wire. Grip Ties are available in a variety of colors and are versatile enough for applications ranging from network installations to bundling power cords.

Features and Benefits

- UL 94 V-2 flame rated material allows use in air handling spaces.
- Features quick release for repetitive access to cable and wire.
- Can be opened and closed numerous times without failure.
- Adjustable so one size can accommodate multiple bundle diameters.

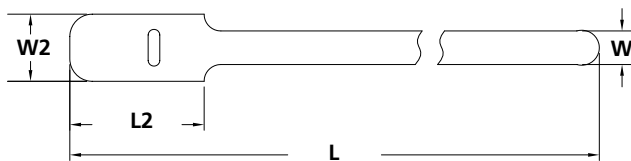

PART NO.	TYPE	Min. Tensile Strength lbs. (N)	Length (L) in. (mm)	Max. Bundle Diameter in. (mm)	Width (W) in. (mm)	Width (W2) in. (mm)	Length (L2) in. (mm)	Material	Color	Pkg. Qty.
GT.50X6MP2V2*	GT.50X6	40.0 (177.9)	6.0 (152.4)	1.0 (25.4)	0.5 (12.7)	1.0 (25.4)	1.5 (38.1)	PA, PP	Maroon	10
GT.50X8MP2V2*	GT.50X8	40.0 (177.9)	8.0 (203.2)	1.9 (48.5)	0.5 (12.7)	1.0 (25.4)	1.5 (38.1)	PA6, PP	Maroon	10
GT.50X12MP2V2*	GT.50X12	40.0 (177.9)	12.0 (304.8)	3.2 (80.8)	0.5 (12.7)	1.0 (25.4)	1.5 (38.1)	PA6, PP	Maroon	10

Dimensions are approximate and subject to technical changes. Use Part No. for ordering and Type for specification purposes.

*This product meets UL standards. Please see appendix for specific file numbers.



Please note! Not all products listed on this page may have this approval. Please check our website for latest approvals.

Hook and Loop Grip Ties

Write-On Grip Ties

In situations where instant identification is needed, HellermannTyton provides Grip Ties with a white write-on area. This smudge-free surface is ideal for fast and easy identification with a ballpoint pen or felt-tip marker. The write-on area is approximately 3/8"H x 1-1/4"W. It is positioned in the center of the black 6", 8", and 11" straps, as well as spaced every 12" on the Grip Tie rolls.

Features and Benefits

- Features quick release for repetitive access to cable and wire.
- Can be opened and closed numerous times without failure.
- Adjustable so one size can accommodate multiple bundle sizes.



PART NO.	TYPE	Min. Tensile Strength lbs. (N)	Length (L) in. (mm)	Max. Bundle Diameter in. (mm)	Width (W) in. (mm)	Width (W2) in. (mm)	Length (L2) in. (mm)	Material	Color	Pkg. Qty.
GT.50X60P2W	GT.50X6W	40.0 (177.9)	6.0 (152.4)	1.0 (25.4)	0.5 (12.7)	1.0 (25.4)	1.5 (38.1)	PA66, PE	Black	10
GT.50X60C2W		40.0 (177.9)	6.0 (152.4)	1.0 (25.4)	0.5 (12.7)	1.0 (25.4)	1.5 (38.1)	PA66, PE	Black	100
GT.50X80P2W	GT.50X8W	40.0 (177.9)	8.0 (203.2)	1.8 (44.5)	0.5 (12.7)	1.0 (25.4)	1.5 (38.1)	PA66, PE	Black	10
GT.50X80C2W		40.0 (177.9)	8.0 (203.2)	1.8 (44.5)	0.5 (12.7)	1.0 (25.4)	1.5 (38.1)	PA66, PE	Black	100
GT.50X110P2W	GT.50X11W	40.0 (177.9)	11.0 (279.4)	2.6 (66.8)	0.5 (12.7)	1.0 (25.4)	1.5 (38.1)	PA66, PE	Black	10
GT.50X110C2W		40.0 (177.9)	11.0 (279.4)	2.6 (66.8)	0.5 (12.7)	1.0 (25.4)	1.5 (38.1)	PA66, PE	Black	100

Dimensions are approximate and subject to technical changes. Use Part No. for ordering and Type for specification purposes.

Bundling and Securing

Cable Ties

Aerial Support Ties

Extended Length Ties

Extended Length Ties support, secure, fasten, and space cables, as well as a variety of other applications requiring extra-long, extremely durable strapping. The high tensile strength strapping system consists of a continuous strap and separate locking head, making it suitable for any bundle diameter. The smooth strap and specially designed heads with stainless steel pawls provide a strong hold on cables and wires without damage during vibration or in extreme environments. Spacers are available for dual bundle applications.

Features and Benefits

- Continuous strap and separate heads allow for any bundle diameter, eliminating waste.
- Smooth strap prevents cable damage.
- UV resistant materials contain an inhibitor which prolongs the life of the tie in outdoor environments.



PART NO.	TYPE	Description	Material	Color	Pkg. Qty.
TELS-SPOOL	TELS-SPOOL	1 - 50ft. reel of strap	POM	Black	1
TELS-1	EL-TY (TELS1)	1 - 50ft. reel of strap and 30 heads	POM	Black	1
TELS-13	TELS-13	10 - 13.5" straps and 10 double-locking heads	POM	Black	10
TELS-27	TELS-27	10 - 27" straps and 10 double-locking heads	POM	Black	10
TELS-H	EL-TY (TELSH)	Double entry and locking heads	POM	Black	25
TELS-SPK2	EL-TY (TELS-SPK2)	EL-TY spacers	PP	Black	50

Dimensions are approximate and subject to technical changes. Use Part No. for ordering and Type for specification purposes.

Aerial Support Ties

Spacer Ties

Aerial Support Spacer Ties feature a built-in spacer to separate cables from support wires and prevent abrasion. A one-piece design combining the tie and spacer into one part reduces installation time and inventory costs. The outside serrations along the strap prevent damage to cables. Formulated from a special nylon blend, these ties are specifically suited for long-term outdoor use. The bent tail allows for quick and simple installation by hand.



Features and Benefits

- UV resistant materials contain an inhibitor which prolongs the life of the tie in outdoor environments.
- One-piece design reduces installation time.
- Outside serrations prevent cable damage.

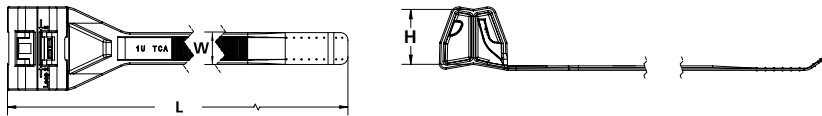

PART NO.	TYPE	Min. Tensile Strength lbs. (N)	Length (L) in. (mm)	Max. Bundle Diameter in. (mm)	Width (W) in. (mm)	Height (H) in. (mm)	Material	Color	Pkg. Qty.
111-01671	TAS120M	120.0 (535.0)	12.4 (270.0)	2.7 (70.0)	0.5 (12.7)	0.8 (19.0)	PA66HIRHSUV	Black	500
111-01672	TAS120L	120.0 (535.0)	17.4 (420.0)	4.5 (114.0)	0.5 (12.7)	0.8 (19.0)	PA66HIRHSUV	Black	500

Dimensions are approximate and subject to technical changes. Use Part No. for ordering and Type for specification purposes.

Bundling and Securing

Cable Ties

Cable Ties - Special Function

Kabelrap Bundling System

The patented Kabelrap cable tie design offers a smooth strap which is locked into place with a glass fiber reinforced pin. The curved head design provides full circumferential compression around the bundle or harness. Once applied with the required KR6/8 manual tool, the tie offers a secure and vibration resistant assembly.

Features and Benefits

- Kabelrap tie offers a smooth strap providing secure assembly without damaging cables or hoses.
- Curved head design provides full circumferential compression which offers vibration resistance.

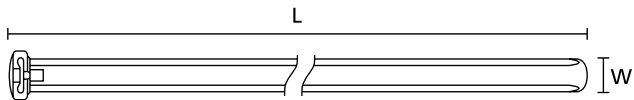

PART NO.	TYPE	Min. Tensile Strength lbs. (N)	Length (L) in. (mm)	Max. Bundle Diameter in. (mm)	Width (W) in. (mm)	Material	Color	Pkg. Qty.
121-63560	KR6/35	110.0 (490.0)	14.0 (360.0)	3.7 (93.0)	0.2 (6.1)	PA66UV	Black	50
121-82119	KR8/21	176.0 (785.0)	8.3 (210.0)	1.9 (47.0)	0.3 (8.0)	PA66	Natural	50
121-82160		176.0 (785.0)	8.3 (210.0)	1.9 (47.0)	0.3 (8.0)	PA66UV	Black	50
121-83378	KR8/33	176.0 (785.0)	13.3 (337.0)	3.4 (86.0)	0.3 (8.0)	PA46	Gray	50
121-83355		176.0 (785.0)	13.3 (337.0)	3.4 (86.0)	0.3 (8.0)	PA66HS	Natural	50
121-83360		176.0 (785.0)	13.3 (337.0)	3.4 (86.0)	0.3 (8.0)	PA66UV	Black	50
121-74359	KR8/43	176.0 (785.0)	16.8 (426.0)	4.1 (105.0)	0.3 (8.0)	PA66HS	Natural	50

Dimensions are approximate and subject to technical changes. Use Part No. for ordering and Type for specification purposes.
Required installation tool: 121-00680.

EN 45545-2



Please note! Not all products listed on this page may have this approval. Please check our website for latest approvals.

Cable Ties - Special Function

Wire Clamping Ties

Wire Clamping Cable Ties secure easily to wire frames for a tight fit and are available in four different wire frame sizes and two separate orientations to provide both perpendicular and parallel routing. The wire clamp design is ideally suited for easing the application process on the production floor by allowing for an easy snap fit of the harness assembly to the wire frame.

Features and Benefits

- Clamp provides low insertion and high extraction force.
- Various sizes available to accommodate all different bundle diameters.
- Clamp can be installed both before and after installation of bundles.



PART NO.	TYPE	Min. Tensile Strength lbs. (N)	Length (L) in. (mm)	Max. Bundle Diameter in. (mm)	Attaches to Diameter in. (mm)	Material	Color	Pkg. Qty.	Drawing
148-00089	T50SOSWA1.8E	50.0 (225.0)	6.0 (150.0)	1.4 (35.0)	0.1 (1.8)	PA66HS	Black	500	
148-00090	T50SOSWB1.8E	50.0 (225.0)	6.0 (150.0)	1.4 (35.0)	0.1 (1.8)	PA66HS	Black	500	
148-00088	T50SOSWA2.0E	50.0 (225.0)	6.0 (150.0)	1.4 (35.0)	0.1 (2.2)	PA66HS	Black	500	
148-00093	T50SOSWB2.0E	50.0 (225.0)	6.0 (150.0)	1.4 (35.0)	0.1 (2.2)	PA66HS	Black	500	
148-00095	T50SOSWA3.4E	50.0 (225.0)	6.0 (150.0)	1.4 (35.0)	0.1 (3.4)	PA66HS	Black	500	
148-00096	T50SOSWB3.4E	50.0 (225.0)	6.0 (150.0)	1.4 (35.0)	0.1 (3.4)	PA66HS	Black	500	
148-00092	T50SOSWA4.3E	50.0 (225.0)	6.0 (150.0)	1.4 (35.0)	0.2 (4.3)	PA66HS	Black	500	
148-00091	T50SOSWB4.3E	50.0 (225.0)	6.0 (150.0)	1.4 (35.0)	0.2 (4.3)	PA66HS	Black	500	

Dimensions are approximate and subject to technical changes. Use Part No. for ordering and Type for specification purposes.
Installation tools: EVO7, EVO7SP, EVO9, EVO9HT, MK7P, MK7HT, MK9P.

Bundling and Securing

Cable Ties

Cable Ties - Special Function

1-Piece Fixing Ties with Pipe Clip

HellermannTyton's 1-Piece Cable Tie with Pipe Clip secures cables to tubular frame rails. The cable tie bundles wires, cables or tubes, and the C-clip snaps onto the tubular frame rail. The clip can be removed from the mounting surface and reinstalled without additional fasteners.

Features and Benefits

- Bundle can rotate to any orientation, allowing routing in any direction regardless of mounting point.
- Clip is reusable, making relocation or adjustments simple.
- All-in-one bundling and mounting solution reduces costs.



PART NO.	TYPE	Min. Tensile Strength lbs. (N)	Length (L) in. (mm)	Max. Bundle Diameter in. (mm)	Attaches to Diameter in. (mm)	Material Cable Tie	Material Foot Part	Color	Pkg. Qty.	Drawing
156-02383	T50SMVCLOC10-14	50.0 (225.0)	8.3 (210.0)	2.0 (50.0)	0.4 - 0.6 (10.0 - 14.0)	PA66HIRHSUV	PA66HIRHSUV	Black	1000	
156-01690	T50SMVCLOC15-19	50.0 (225.0)	8.3 (210.0)	2.0 (50.0)	0.6 - 0.8 (15.0 - 19.0)	PA66HIRHS	PA66HIRHS	Black	1000	
156-01714	T50SMVCLOC20-25	50.0 (225.0)	8.3 (210.0)	2.0 (50.0)	0.8 - 1.0 (20.0 - 25.0)	PA66HIRHS	PA66HIRHS	Black	1000	
156-02384	T50SMVCLOC5-9	50.0 (225.0)	8.3 (210.0)	2.0 (50.0)	0.2 - 0.4 (5.0 - 9.0)	PA66HIRHS	PA66HIRHS	Black	1000	
156-01340	T50SMVCO15-18	50.0 (222.0)	8.3 (210.0)	2.0 (50.0)	0.6 - 0.7 (15.0 - 18.0)	PA66HS	PA66HIRHS	Black	500	

Dimensions are approximate and subject to technical changes. Use Part No. for ordering and Type for specification purposes.
Installation tools: EVO7, EVO7SP, EVO9, EVO9HT, MK7P, MK7HT, MK9P.

Cable Ties - Special Function

1-Piece Fixing Ties with Pipe Clip

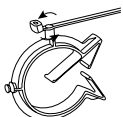
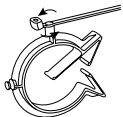
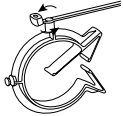
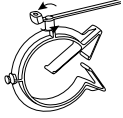
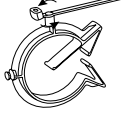
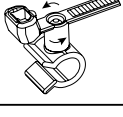
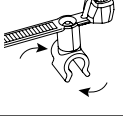
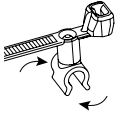
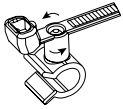
PART NO.	TYPE	Min. Tensile Strength lbs. (N)	Length (L) in. (mm)	Max. Bundle Diameter in. (mm)	Attaches to Diameter in. (mm)	Material Cable Tie	Material Foot Part	Color	Pkg. Qty.	Drawing
156-00577	T50SMVCOC19-24.5	50.0 (222.0)	8.3 (210.0)	2.0 (50.0)	0.8 - 1.0 (19.0 - 24.5)	PA46	PA46	Gray	500	
156-01342		50.0 (222.0)	8.3 (210.0)	2.0 (50.0)	0.8 - 1.0 (19.0 - 24.5)	PA66HS	PA66HIRHS	Black	500	
156-01344	T50SMVCOC25-31	50.0 (222.0)	8.3 (210.0)	2.0 (50.0)	1.0 - 1.2 (25.0 - 31.0)	PA66HS	PA66HIRHS	Black	250	
156-01346	T50SMVCOC31-39	50.0 (222.0)	8.3 (210.0)	2.0 (50.0)	1.2 - 1.5 (31.0 - 39.0)	PA66HS	PA66HIRHS	Black	250	
156-01348	T50SMVCOC39-45	50.0 (222.0)	8.3 (210.0)	2.0 (50.0)	1.5 - 1.8 (39.0 - 45.0)	PA66HS	PA66HIRHS	Black	250	
156-01350	T50SVC3.5	50.0 (222.0)	6.1 (155.0)	1.4 (35.0)	0.1 - 0.1 (3.5 - 3.6)	PA66HS	PA66HIRHS	Black	500	
156-01349	T50SVC4S	50.0 (222.0)	6.1 (155.0)	1.4 (35.0)	0.2 - 0.2 (3.8 - 4.2)	PA66HS	PP	Black	500	
156-01516	T50SVC5	50.0 (222.0)	6.1 (155.0)	1.4 (35.0)	0.2 - 0.2 (4.5 - 5.2)	PA66HS	PA66HS	Black	500	
156-01670	T50SVC6.5	50.0 (222.0)	6.1 (155.0)	1.4 (35.0)	0.3 - 0.3 (6.5 - 8.0)	PA66HS	PA66HIRHS	Black	500	



Dimensions are approximate and subject to technical changes. Use Part No. for ordering and Type for specification purposes.
Installation tools: EVO7, EVO7SP, EVO9, EVO9HT, MK7P, MK7HT, MK9P.

Bundling and Securing

Cable Ties

Cable Ties - Special Function

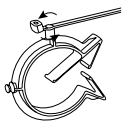
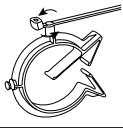
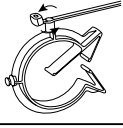
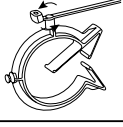
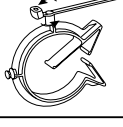
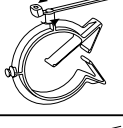
1-Piece Fixing Ties with Pipe Clip

PART NO.	TYPE	Min. Tensile Strength lbs. (N)	Length (L) in. (mm)	Max. Bundle Diameter in. (mm)	Attaches to Diameter in. (mm)	Material Cable Tie	Material Foot Part	Color	Pkg. Qty.	Drawing
156-01385	T50SVCOC10-14	50.0 (222.0)	6.1 (155.0)	1.4 (35.0)	0.4 - 0.6 (10.0 - 14.0)	PA46	PA46	Gray	500	
156-01337		50.0 (222.0)	6.1 (155.0)	1.4 (35.0)	0.4 - 0.6 (10.0 - 14.0)	PA66HS	PA66HIRHS	Black	500	
156-01339	T50SVCOC15-18	50.0 (222.0)	6.1 (155.0)	1.4 (35.0)	0.6 - 0.7 (15.0 - 18.0)	PA66HS	PA66HIRHS	Black	500	
156-01341	T50SVCOC19-24.5	50.0 (222.0)	6.1 (155.0)	1.4 (35.0)	0.8 - 1.0 (19.0 - 24.5)	PA66HS	PA66HIRHS	Black	500	
156-01343	T50SVCOC25-31	50.0 (222.0)	6.1 (155.0)	1.4 (35.0)	1.0 - 1.2 (25.0 - 31.0)	PA66HS	PA66HIRHS	Black	250	
156-01345	T50SVCOC31-39	50.0 (222.0)	6.1 (155.0)	1.4 (35.0)	1.2 - 1.5 (31.0 - 39.0)	PA66HS	PA66HIRHS	Black	250	
156-01347	T50SVCOC39-45	50.0 (222.0)	6.1 (155.0)	1.4 (35.0)	1.5 - 1.8 (39.0 - 45.0)	PA66HS	PA66HIRHS	Black	250	

Dimensions are approximate and subject to technical changes. Use Part No. for ordering and Type for specification purposes.
Installation tools: EVO7, EVO7SP, EVO9, EVO9HT, MK7P, MK7HT, MK9P.

Cable Ties - Special Function

2-Piece Fixing Ties with Pipe Clip

HellermannTyton's 2-Piece Cable Tie with Pipe Clip secures cables to tubular frame rails. The cable tie bundles wires, cables or tubes, and the C-clip snaps onto the tubular frame rail. The clip can be removed from the mounting surface and reinstalled without additional fasteners.

Features and Benefits

- Bundle can rotate to any orientation, allowing routing in any direction regardless of mounting point.
- 2-piece design allows installer to slide clip around cable tie to obtain optimum orientation
- Clip is reusable, making relocation or adjustments simple.



PART NO.	TYPE	Min. Tensile Strength lbs. (N)	Length (L) in. (mm)	Max. Bundle Diameter in. (mm)	Attaches to Diameter in. (mm)	Material Cable Tie	Material Foot Part	Color	Pkg. Qty.	Drawing
156-00012	T30ROC1A	30.0 (135.0)	5.8 (148.0)	1.2 (31.0)	0.2 - 0.4 (4.0 - 10.0)	PA66HS	PA66HIRHS	Black	500	
156-00014	T30ROC2A	30.0 (135.0)	5.8 (148.0)	1.2 (31.0)	0.3 - 0.3 (6.5 - 7.5)	PA46	PA46	Gray	500	
156-00013		30.0 (135.0)	5.8 (148.0)	1.2 (31.0)	0.3 - 0.3 (6.5 - 7.5)	PA66HS	PA66HIRHS	Black	500	
156-00838	T30ROC2B	30.0 (135.0)	5.8 (148.0)	1.2 (31.0)	0.3 - 0.3 (6.5 - 7.5)	PA46	PA66HIRHS	Natural, Black	500	
156-00520	T30ROC5J	30.0 (135.0)	6.0 (152.0)	1.2 (31.0)	0.4 (11.0)	PA66HSUV	PA66HSUV	Black	100	





Dimensions are approximate and subject to technical changes. Use Part No. for ordering and Type for specification purposes.
Installation tools: EVO7, EVO7SP, MK7HT, MK7P.

Bundling and Securing

Cable Ties

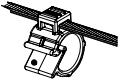
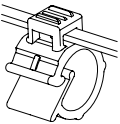
Cable Ties - Special Function

2-Piece Fixing Ties with Pipe Clip

PART NO.	TYPE	Min. Tensile Strength lbs. (N)	Length (L) in. (mm)	Max. Bundle Diameter in. (mm)	Attaches to Diameter in. (mm)	Material Cable Tie	Material Foot Part	Color	Pkg. Qty.	Drawing
156-00895	T30ROC5J-P	30.0 (135.0)	6.0 (152.0)	1.2 (31.0)	0.4 (11.0)	PA66HS	PA66HS	Gray	2000	
156-00894		30.0 (135.0)	6.0 (152.0)	1.2 (31.0)	0.4 (11.0)	PA66HSUV	PA66HSUV	Black	100	
156-01795	T50IOC1B	50.0 (225.0)	12.0 (305.0)	1.8 (45.0)	0.2 - 0.4 (4.0 - 10.0)	PA66HS	PA66HIRHS	Black	500	
156-01060	T50IOC2A	50.0 (225.0)	12.0 (305.0)	1.8 (45.0)	0.2 - 0.4 (4.0 - 10.0)	PA66HS	PA66HIRHS	Black	500	
156-01031	T50LOC1A	50.0 (225.0)	15.4 (390.0)	1.8 (45.0)	0.2 - 0.4 (4.0 - 10.0)	PA66HIRHSUV	PA66HIRHSUV	Black	3000	
156-00036	T50ROC1A	50.0 (225.0)	8.0 (202.0)	1.8 (45.0)	0.2 - 0.4 (4.0 - 10.0)	PA66HS	PA66HIRHS	Black	500	

Dimensions are approximate and subject to technical changes. Use Part No. for ordering and Type for specification purposes.
Installation tools: EVO7, EVO7SP, MK7HT, MK7P.

Arrowhead Mount Cable Ties

Domed Low Profile Push Mount Ties

The low-profile push mount design provides an overall shortened length, which assists in limiting protrusion on the opposing side of application surfaces. The mount's rounded tip allows for a smoother surface in case of contact with surrounding components or hands. The dome provides firm, rattle-free performance and keeps out debris. One-piece mounting ties offer a complete solution by both bundling and mounting.

Features and Benefits

- All-in-one bundling and mounting solution reduces costs.
- Low-profile design provides dependable cable management in tight spaces.

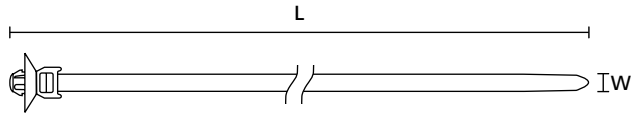

PART NO.	TYPE	Min. Tensile Strength lbs. (N)	Mounting Hole Dia. in. (mm)	Panel Thickness in. (mm)	Length (L) in. (mm)	Max. Bundle Diameter in. (mm)	Width (W) in. (mm)	Material	Color	Pkg. Qty.
126-00111	T50SOSKSFT5SE	40.0 (180.0)	0.19 - 0.20 (4.8 - 5.2)	0.02 - 0.05 (0.7 - 1.3)	6.1 (156.0)	1.4 (35.0)	0.2 (4.6)	PA66HS	Natural	1000
126-00099		40.0 (180.0)	0.19 - 0.21 (4.8 - 5.2)	0.03 - 0.05 (0.7 - 1.3)	6.0 (156.0)	1.4 (35.0)	0.2 (4.6)	PA66HS	Black	1000
126-00081	T50SOSKSFT6.5E	40.0 (180.0)	0.25 - 0.26 (6.3 - 6.7)	0.03 - 0.05 (0.7 - 1.3)	6.0 (156.0)	1.4 (35.0)	0.2 (4.6)	PA66HS	Black	500
126-00075	T50SOSKSFT5.4E	50.0 (225.0)	0.20 - 0.22 (5.2 - 5.6)	0.03 - 0.05 (0.7 - 1.3)	6.0 (156.0)	1.4 (35.0)	0.2 (4.6)	PA66HS	Black	500
126-00326	T50SOSKSFT6.5S2-E	50.0 (225.0)	0.25 - 0.26 (6.3 - 6.7)	0.07 - 0.09 (1.7 - 2.3)	6.0 (157.0)	1.4 (35.0)	0.2 (4.6)	PA66HS	Black	500

Dimensions are approximate and subject to technical changes. Use Part No. for ordering and Type for specification purposes.
Installation tools: EVO7, EVO7SP, EVO9, EVO9HT, MK7P, MK7HT, MK9P.

Bundling and Securing

Self-Affixing Cable Ties

Arrowhead Mount Cable Ties

Domed Push Mount Ties

The Domed Push Mount Tie provides a tight, rattle-free installation and acts as a seal to keep out dust and debris. One-piece mounting ties offer a complete solution by both bundling cable and at the same time providing a mounting solution.

Features and Benefits

- An all-in-one bundling and fixing solution reduces costs.
- Disc provides secure insertion and minimizes access of dust, dirt and water.

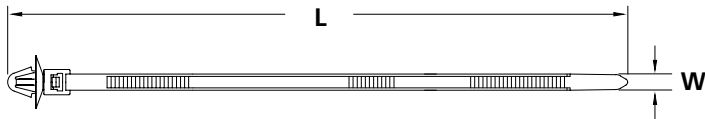

PART NO.	TYPE	Min. Tensile Strength lbs. (N)	Mounting Hole Dia. in. (mm)	Panel Thickness in. (mm)	Length (L) in. (mm)	Max. Bundle Diameter in. (mm)	Width (W) in. (mm)	Material	Color	Pkg. Qty.
126-02300	T50SST5	50.0 (225.0)	0.24 - 0.26 (6.1 - 6.5)	0.03 - 0.06 (0.7 - 1.5)	7.0 (170.0)	1.2 (31.0)	0.2 (4.6)	PA66	Natural	1000
126-00017		50.0 (225.0)	0.24 - 0.26 (6.1 - 6.5)	0.03 - 0.06 (0.7 - 1.5)	7.0 (170.0)	1.2 (31.0)	0.2 (4.6)	PA66HS	Black	1000
150-15395		50.0 (225.0)	0.24 - 0.26 (6.1 - 6.5)	0.03 - 0.06 (0.7 - 1.5)	7.0 (170.0)	1.2 (31.0)	0.2 (4.6)	PA66HIRHS	Black	1000
126-00015	T50SDOP	50.0 (225.0)	0.24 - 0.27 (6.2 - 12.2)	0.04 - 0.08 (1.0 - 1.9)	6.3 (160.0)	1.2 (30.0)	0.2 (5.0)	PA66HS	Black	500
126-00114	T50ROSAH6U	50.0 (225.0)	0.24 - 0.27 (6.1 - 6.9)	0.07 - 0.12 (1.8 - 3.0)	8.5 (215.9)	2.0 (50.0)	0.2 (5.0)	PA66HIRHS	Natural	500
126-00115		50.0 (225.0)	0.24 - 0.27 (6.1 - 6.9)	0.07 - 0.12 (1.8 - 3.0)	8.5 (215.9)	2.0 (50.0)	0.2 (5.0)	PA66HIRHS	Black	500
126-03102	T50SOSSFT6.5E	50.0 (225.0)	0.25 - 0.26 (6.3 - 6.7)	0.07 - 0.10 (1.9 - 2.5)	6.0 (158.8)	1.2 (30.0)	0.2 (4.6)	PA66HS	Black	500
T50SD60HSH4	T50SD6	50.0 (200.0)	0.25 - 0.30 (6.3 - 7.5)	0.02 - 0.07 (0.6 - 1.8)	6.0 (160.0)	1.2 (31.0)	0.2 (5.0)	PA66HS	Black	500
111-85850	T50MD7	50.0 (225.0)	0.27 - 0.28 (6.8 - 7.2)	0.03 - 0.08 (1.2 - 2.0)	9.0 (225.0)	2.3 (59.0)	0.2 (5.0)	PA66HS	Black	100
126-00183	PT2ASFT6.5 PT0.7-1.5-E	51.7 (230.0)	0.24 - 0.26 (6.3 - 6.7)	0.03 - 0.06 (0.7 - 1.5)	4.4 (112.7)	0.8 (20.0)	0.1 (3.4)	PEEK	Beige	7000

Dimensions are approximate and subject to technical changes. Use Part No. for ordering and Type for specification purposes.
Installation tools: EVO7, EVO7SP, EVO9, EVO9HT, MK7P, MK7HT, MK9P.

Arrowhead Mount Cable Ties

2-Piece Arrowhead Ties

HellermannTyton's Arrowhead Push Mount Tie Assembly is a two piece design allowing the mount to slide along the strap of the tie to ensure proper orientation. The arrowhead mount is designed for low insertion into a pre-drilled hole, while providing a high extraction force. The disc also protects against dirt and other impurities.

Features and Benefits

- Two-piece assembly allows mount to slide along strap, ensuring proper orientation.
- Arrowhead-style mount provides low insertion and high extraction force.
- Multiple material options provide solutions for any environment.

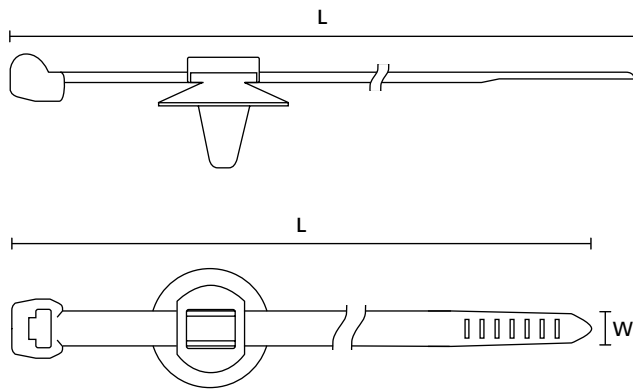

PART NO.	TYPE	Min. Tensile Strength lbs. (N)	Mounting Hole Dia. in. (mm)	Panel Thickness in. (mm)	Length (L) in. (mm)	Max. Bundle Diameter in. (mm)	Width (W) in. (mm)	Material Cable Tie	Material Arrowhead	Color	Pkg. Qty.
150-37791	T50ROSS FT6.5 16-3	50.0 (225.0)	0.25 - 0.26 (6.3 - 6.7)	0.10 - 0.14 (2.5 - 3.5)	7.9 (200.0)	1.8 (45.0)	0.2 (4.6)	PA66HS	PA66HIRHS	Black	500
156-01090	PT2AP1SFT6.5	51.7 (230.0)	0.25 - 0.26 (6.3 - 6.7)	0.03 - 0.05 (0.7 - 1.3)	5.7 (145.0)	1.4 (35.0)	0.1 (3.4)	PEEK	PEEK	Beige	500
156-01091	PT2AP2SFT6.5	51.7 (230.0)	0.25 - 0.26 (6.3 - 6.7)	0.07 - 0.09 (1.7 - 2.3)	5.7 (145.0)	1.4 (35.0)	0.1 (3.4)	PEEK	PEEK	Beige	500
156-01146	PT2AP3SFT6.5	51.7 (230.0)	0.25 - 0.26 (6.3 - 6.7)	0.05 - 0.07 (1.2 - 1.8)	5.7 (145.0)	1.3 (32.0)	0.1 (3.4)	PEEK	PEEK	Beige	100

Dimensions are approximate and subject to technical changes. Use Part No. for ordering and Type for specification purposes.
Installation tools: EVO7, EVO7SP, EVO9, EVO9HT, MK7P, MK7HT, MK9P.

Bundling and Securing

Self-Affixing Cable Ties

Arrowhead Mount Cable Ties

2-Piece Arrowhead Ties with Seal

HellermannTyton's Arrowhead Push Mount Tie Assembly is a two piece design allowing the mount to slide along the strap of the tie to ensure proper orientation. The arrowhead mount is designed for low insertion into a pre-drilled hole, while providing a high extraction force. The disc with seal minimizes the ingress of dirt, debris and water.

Features and Benefits

- Two piece assembly allows the mount to slide along the strap ensuring proper orientation.
- Arrowhead style mount provides low insertion and high extraction force.
- Arrowhead disc protects against dirt and other impurities.

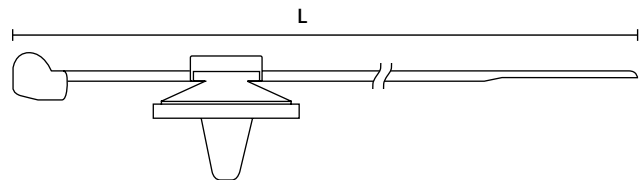
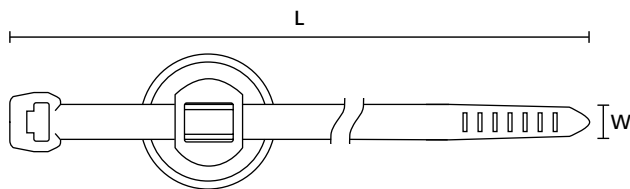

PART NO.	TYPE	Min. Tensile Strength lbs. (N)	Mounting Hole Dia. in. (mm)	Panel Thickness in. (mm)	Length (L) in. (mm)	Max. Bundle Diameter in. (mm)	Width (W) in. (mm)	Material Cable Tie	Material Arrowhead	Color	Pkg. Qty.
150-37799	T50ROSSFT 6.5 16-3MD	50.0 (225.0)	0.24 - 0.28 (6.1 - 7.0)	0.10 - 0.12 (2.5 - 3.0)	7.9 (200.0)	1.8 (45.0)	0.2 (4.6)	PA66HS	PA66HIRHS	Black	500
150-93100	T50ROSSFT 6.5-D16-2 MD	50.0 (222.0)	0.25 - 0.26 (6.3 - 6.7)	0.03 - 0.79 (0.7 - 1.8)	7.9 (200.0)	1.8 (45.0)	0.2 (4.6)	PA66HS	PA66HIRHS	Black	500

Dimensions are approximate and subject to technical changes. Use Part No. for ordering and Type for specification purposes.
Installation tools: EVO7, EVO7SP, EVO9, EVO9HT, MK7P, MK7HT, MK9P.

Arrowhead Mount Cable Ties

Push Mount Ties

One-piece mounting ties offer a complete solution by both bundling cable and simultaneously providing a mounting solution. The arrowhead design of this push mount inserts easily and locks securely in place. HellermannTyton's one-piece mounting ties combine high-specification materials with superior design to deliver dependable performance in a range of applications.

Features and Benefits

- All-in-one bundling and fastening solution reduces costs and assembly time.
- The arrowhead design of these ties offers a low insertion force and a high extraction force.
- High-spec materials and superior design deliver versatility, performance and value.

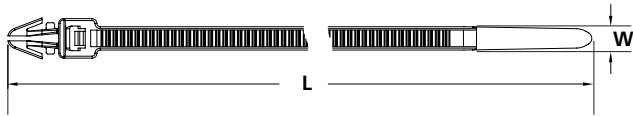

PART NO.	TYPE	Min. Tensile Strength lbs. (N)	Mounting Hole Dia. in. (mm)	Panel Thickness in. (mm)	Length (L) in. (mm)	Max. Bundle Diameter in. (mm)	Width (W) in. (mm)	Material	Color	Pkg. Qty.
T30RSF9C2*	T30RSF(U)	30.0 (136.0)	0.19 - 0.22 (4.7 - 5.6)	0.03 - 0.09 (0.75 - 2.1)	6.3 (158.0)	1.3 (32.0)	0.1 (3.6)	PA66	Natural	100
T30RSF9M4*		30.0 (135.0)	0.19 - 0.22 (4.7 - 5.6)	0.04 - 0.09 (0.9 - 2.4)	6.3 (161.0)	1.3 (31.0)	0.1 (3.6)	PA66	Natural	1000
T30RSF0C2*		30.0 (135.0)	0.19 - 0.22 (4.7 - 5.6)	0.04 - 0.09 (0.9 - 2.4)	6.3 (161.0)	1.3 (31.0)	0.1 (3.6)	PA66HS	Black	100
T30RSF0M4*		30.0 (135.0)	0.19 - 0.22 (4.7 - 5.6)	0.04 - 0.09 (0.9 - 2.4)	6.3 (161.0)	1.3 (31.0)	0.1 (3.6)	PA66HS	Black	1000
126-00043*	T50SSF	50.0 (225.0)	0.25 - 0.28 (6.4 - 7.1)	0.04 - 0.14 (1.0 - 3.56)	6.3 (159.0)	1.4 (35.0)	0.2 (4.7)	PA66	Natural	100
126-00044*		50.0 (225.0)	0.25 - 0.28 (6.4 - 7.1)	0.04 - 0.14 (1.0 - 3.56)	6.3 (159.0)	1.4 (35.0)	0.2 (4.7)	PA66	Natural	1000
126-00045*		50.0 (225.0)	0.25 - 0.28 (6.4 - 7.1)	0.04 - 0.14 (1.0 - 3.56)	6.3 (159.0)	1.4 (35.0)	0.2 (4.7)	PA66HS	Black	100
126-00046*		50.0 (225.0)	0.25 - 0.28 (6.4 - 7.1)	0.04 - 0.14 (1.0 - 3.56)	6.3 (159.0)	1.4 (35.0)	0.2 (4.7)	PA66HS	Black	1000

Dimensions are approximate and subject to technical changes. Use Part No. for ordering and Type for specification purposes.

Installation tools: EVO7, EVO7SP, EVO9, EVO9HT, MK7P, MK7HT, MK9P. *This product meets UL standards. Please see appendix for specific file numbers.



Please note! Not all products listed on this page may have this approval. Please check our website for latest approvals.

Bundling and Securing

Self-Affixing Cable Ties

Arrowhead Mount Cable Ties

Push Mount Ties

PART NO.	TYPE	Min. Tensile Strength lbs. (N)	Mounting Hole Dia. in. (mm)	Panel Thickness in. (mm)	Length (L) in. (mm)	Max. Bundle Diameter in. (mm)	Width (W) in. (mm)	Material	Color	Pkg. Qty.
T50RSF9C2*	T50RSF(U)	50.0 (225.0)	0.25 - 0.28 (6.4 - 7.1)	0.04 - 0.14 (1.0 - 3.56)	8.3 (210.0)	1.7 (44.0)	0.2 (4.7)	PA66	Natural	100
T50RSF9M4*		50.0 (225.0)	0.25 - 0.28 (6.4 - 7.1)	0.04 - 0.14 (1.0 - 3.56)	8.3 (210.0)	1.7 (44.0)	0.2 (4.7)	PA66	Natural	1000
T50RSF0C2*		50.0 (225.0)	0.25 - 0.28 (6.4 - 7.1)	0.04 - 0.14 (1.0 - 3.56)	8.3 (210.0)	1.7 (44.0)	0.2 (4.7)	PA66HS	Black	100
T50RSF0M4*		50.0 (225.0)	0.25 - 0.28 (6.4 - 7.1)	0.04 - 0.14 (1.0 - 3.56)	8.3 (210.0)	1.7 (44.0)	0.2 (4.7)	PA66HS	Black	1000

Dimensions are approximate and subject to technical changes. Use Part No. for ordering and Type for specification purposes.

Installation tools: EVO7, EVO7SP, EVO9, EVO9HT, MK7P, MK7HT, MK9P. *This product meets UL standards. Please see appendix for specific file numbers.



Please note! Not all products listed on this page may have this approval. Please check our website for latest approvals.

Arrowhead Mount Cable Ties

Wing Push Mount Ties

Wing design helps stabilize the tie in high vibration applications. One-piece mounting ties offer a complete solution by both bundling cable and at the same time providing a mounting solution. HellermannTyton's one-piece mounting ties offer the ideal combination of high specification materials and superior design to suit the mounting and bundling needs of complex applications.

Features and Benefits

- Two piece assembly allows the mount to slide along the strap ensuring proper orientation.
- Arrowhead style mount provides low insertion and high extraction force.
- Arrowhead disc protects against dirt and other impurities.



PART NO.	TYPE	Min. Tensile Strength lbs. (N)	Mounting Hole Dia. in. (mm)	Panel Thickness in. (mm)	Length (L) in. (mm)	Max. Bundle Diameter in. (mm)	Width (W) in. (mm)	Material	Color	Pkg. Qty.	Drawing
111-85519	T18RSF	18.0 (80.0)	0.18 - 0.19 (4.6 - 4.8)	0.03 - 0.12 (0.8 - 3.0)	4.0 (100.0)	0.6 (16.0)	0.1 (2.5)	PA66HS	Natural	100	
111-85560		18.0 (80.0)	0.18 - 0.19 (4.6 - 4.8)	0.03 - 0.12 (0.8 - 3.0)	4.0 (100.0)	0.6 (16.0)	0.1 (2.5)	PA66UV	Black	100	
126-00042*	T18RWPM	18.0 (80.0)	0.19 - 0.22 (4.8 - 5.6)	0.06 - 0.13 (1.52 - 3.2)	4.5 (113.0)	0.9 (22.0)	0.1 (2.5)	PA66HS	Black	1000	
T18RWP M9M4*		18.0 (80.0)	0.19 - 0.22 (4.8 - 5.6)	0.06 - 0.13 (1.52 - 3.2)	4.5 (113.0)	0.9 (22.0)	0.1 (2.5)	PA66	Natural	1000	
126-00041*		18.0 (80.0)	0.19 - 0.22 (4.8 - 5.6)	0.06 - 0.13 (1.52 - 3.2)	4.5 (113.0)	0.9 (22.2)	0.1 (2.5)	PA66	Natural	100	

Dimensions are approximate and subject to technical changes. Use Part No. for ordering and Type for specification purposes.
 Installation tools: EVO7, EVO7SP, EVO9, EVO9HT, MK7P, MK7HT, MK9P. *This product meets UL standards. Please see appendix for specific file numbers.



Please note! Not all products listed on this page may have this approval. Please check our website for latest approvals.

Bundling and Securing

Self-Affixing Cable Ties

Arrowhead Mount Cable Ties

Wing Push Mount Ties

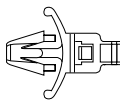
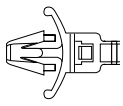
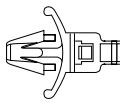
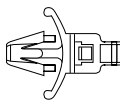
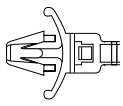
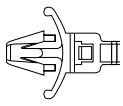
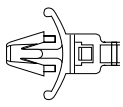
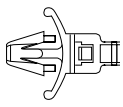
PART NO.	TYPE	Min. Tensile Strength lbs. (N)	Mounting Hole Dia. in. (mm)	Panel Thickness in. (mm)	Length (L) in. (mm)	Max. Bundle Diameter in. (mm)	Width (W) in. (mm)	Material	Color	Pkg. Qty.	Drawing
126-00074	T50RSFM	50.0 (225.0)	0.24 - 0.26 (6.0 - 6.6)	0.03 - 0.12 (0.7 - 3.0)	8.0 (200.0)	1.8 (45.0)	0.2 (4.6)	PA66HS	Black	100	
126-00117		50.0 (225.0)	0.24 - 0.26 (6.0 - 6.6)	0.03 - 0.12 (0.7 - 3.0)	8.0 (200.0)	1.8 (45.0)	0.2 (4.6)	PA66	Natural	500	
126-00116		50.0 (225.0)	0.24 - 0.26 (6.0 - 6.6)	0.03 - 0.12 (0.7 - 3.0)	8.0 (205.0)	1.8 (45.0)	0.2 (4.6)	PA66HS	Black	500	
111-85720		50.0 (225.0)	0.24 - 0.26 (6.0 - 6.6)	0.03 - 0.12 (0.7 - 3.0)	8.0 (205.0)	1.8 (45.0)	0.2 (4.6)	PA66HS	Black	500	
126-00001	T50SL5	50.0 (222.0)	0.24 - 0.26 (6.1 - 6.5)	0.03 - 0.10 (0.8 - 2.5)	6.5 (165.0)	1.3 (34.0)	0.2 (4.7)	PA66HS	Black	500	
126-00005		50.0 (222.0)	0.24 - 0.26 (6.1 - 6.5)	0.03 - 0.11 (0.8 - 2.7)	6.5 (163.0)	1.3 (34.0)	0.2 (4.6)	PA66HIRHS	Black	500	
111-85460	T50SL6	50.0 (225.0)	0.25 - 0.30 (6.3 - 7.5)	0.02 - 0.10 (0.5 - 2.5)	6.5 (165.0)	1.3 (34.0)	0.2 (4.6)	PA66	Black	500	
T50SL6. NN6P		50.0 (225.0)	0.25 - 0.30 (6.3 - 7.5)	0.02 - 0.10 (0.5 - 2.5)	6.5 (165.0)	1.3 (34.0)	0.2 (4.6)	PA66	Natural	500	

Dimensions are approximate and subject to technical changes. Use Part No. for ordering and Type for specification purposes.

Installation tools: EVO7, EVO7SP, EVO9, EVO9HT, MK7P, MK7HT, MK9P. *This product meets UL standards. Please see appendix for specific file numbers.



Please note! Not all products listed on this page may have this approval. Please check our website for latest approvals.

Arrowhead Mount Cable Ties

Wing Push Mount Ties

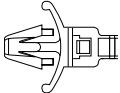
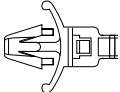
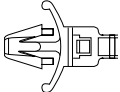
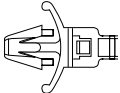
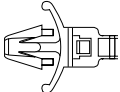
PART NO.	TYPE	Min. Tensile Strength lbs. (N)	Mounting Hole Dia. in. (mm)	Panel Thickness in. (mm)	Length (L) in. (mm)	Max. Bundle Diameter in. (mm)	Width (W) in. (mm)	Material	Color	Pkg. Qty.	Drawing
T50SL7. NN6P	T50SL7	50.0 (225.0)	0.27 - 0.28 (6.9 - 7.1)	0.03 - 0.10 (0.8 - 2.5)	6.5 (165.0)	1.3 (34.0)	0.2 (4.6)	PA66	Natural	500	
126-00082	T50SSF	50.0 (225.0)	0.24 - 0.26 (6.0 - 6.6)	0.03 - 0.12 (0.7 - 3.0)	6.3 (160.0)	1.4 (35.0)	0.2 (4.6)	PA66HIRHS	Natural	500	
126-00049		50.0 (225.0)	0.24 - 0.26 (6.0 - 6.6)	0.03 - 0.12 (0.7 - 3.0)	6.3 (160.0)	1.4 (35.0)	0.2 (4.6)	PA66HIRHS	Black	500	
126-00069		50.0 (225.0)	0.24 - 0.26 (6.0 - 6.6)	0.03 - 0.12 (0.7 - 3.0)	6.3 (160.0)	1.4 (35.0)	0.2 (4.6)	PA66	Natural	500	
126-02204	T50SSL5	50.0 (200.0)	0.24 - 0.26 (6.1 - 6.5)	0.02 - 0.11 (0.5 - 2.7)	5.3 (135.0)	1.0 (27.0)	0.2 (4.6)	PA66HS	Black	500	

Dimensions are approximate and subject to technical changes. Use Part No. for ordering and Type for specification purposes.
 Installation tools: EVO7, EVO7SP, EVO9, EVO9HT, MK7P, MK7HT, MK9P. *This product meets UL standards. Please see appendix for specific file numbers.

Bundling and Securing

Self-Affixing Cable Ties

Arrowhead Mount Cable Ties

Push Mount Ties with Seal - Round Holes

The arrowhead design of these ties offers a low insertion force and a high extraction force. The foam rubber seal provides additional protection against moisture and debris. One-piece mounting ties offer a complete solution by simultaneously bundling and mounting cables, wires and hoses.

Features and Benefits

- An all-in-one bundling and fastening solution that saves time and reduces costs.
- Foam seal prevents ingress of moisture and debris and prevents vibration.

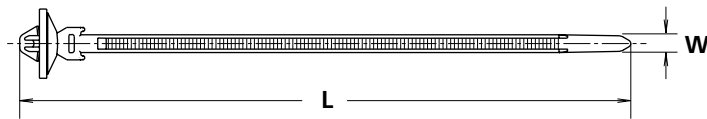

PART NO.	TYPE	Min. Tensile Strength lbs. (N)	Mounting Hole Dia. in. (mm)	Panel Thickness in. (mm)	Length (L) in. (mm)	Max. Bundle Diameter in. (mm)	Width (W) in. (mm)	Material	Color	Pkg. Qty.
126-00245	T50SOSSFT6.5E-MS-MD	40.0 (180.0)	0.25 - 0.27 (6.4 - 7.0)	0.03 - 0.07 (0.7 - 1.8)	6.5 (163.0)	1.4 (35.0)	0.2 (4.6)	PA66HS	Natural	500
156-00444	T50ROSAH6MDU	50.0 (225.0)	0.25 - 0.25 (6.2 - 6.6)	0.03 - 0.08 (0.8 - 2.1)	8.5 (216.0)	2.0 (50.0)	0.2 (5.0)	PA66HIRHS	Natural	500
126-00243	T50SOSSFT6.5E-MD	50.0 (225.0)	0.25 - 0.26 (6.3 - 6.7)	0.02 - 0.07 (0.6 - 1.8)	6.3 (158.8)	1.2 (30.0)	0.2 (4.6)	PA66HS	Green	500
126-00244		50.0 (225.0)	0.25 - 0.26 (6.3 - 6.7)	0.02 - 0.07 (0.6 - 1.8)	6.3 (158.8)	1.2 (30.0)	0.2 (4.6)	PA66HS	Black	500

Dimensions are approximate and subject to technical changes. Use Part No. for ordering and Type for specification purposes.
Installation tools: EVO7, EVO7SP, EVO9, EVO9HT, MK7P, MK7HT, MK9P.

Arrowhead Mount Cable Ties

Push Mount Ties with Seal for Oval Holes

Push Mount Ties with Seal for Oval Holes provide a one-piece bundling and mounting solution. The oval arrowhead fastener won't rotate once inserted into a panel hole, ensuring proper routing of wires and hoses. The welded rubber seal protects against the ingress of water and debris.

Features and Benefits

- Design helps silence and stabilize the tie in high-vibration applications.
- Arrowhead-style mount provides low insertion and high extraction force.
- Anti-rotational oval fastener forces bundle to travel in intended direction.
- Rubber seal restricts water and debris from passing through mounting hole.

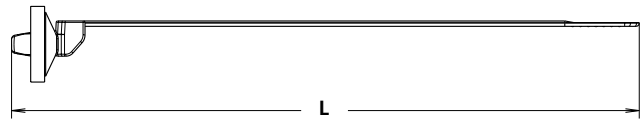

PART NO.	TYPE	Min. Tensile Strength lbs. (N)	Mounting Hole Dia. in. (mm)	Panel Thickness in. (mm)	Length (L) in. (mm)	Max. Bundle Diameter in. (mm)	Width in. (mm)	Material	Color	Pkg. Qty.
126-00080	T60SOSSFT62x122-E-MD	67.0 (300.0)	0.24 - 0.48 (6.2 x 12.2)	0.02 - 0.08 (0.6 - 2.0)	6.2 (157.5)	1.2 (30.0)	0.2 (5.5)	PA66HS	Black	500
126-00076	T60SOSSFT65x130-E-MD	67.0 (300.0)	0.25 - 0.51 (6.5 x 13.0)	0.02 - 0.08 (0.6 - 2.0)	6.0 (157.6)	1.2 (30.0)	0.2 (5.5)	PA66HS	Natural	500
126-00186	T60SOSSFT65x130-E-MS-MD	67.0 (300.0)	0.26 - 0.51 (6.5 x 13.0)	0.02 - 0.08 (0.6 - 2.0)	6.2 (158.0)	1.2 (30.0)	0.2 (5.5)	PA66HS	Black	500
126-00079	T60SOSSFT70x120-E-MD	67.0 (300.0)	0.28 - 0.47 (7.0 x 12.0)	0.03 - 0.08 (0.6 - 2.0)	6.2 (157.7)	1.2 (30.0)	0.2 (5.5)	PA66HS	Black	500

Dimensions are approximate and subject to technical changes. Use Part No. for ordering and Type for specification purposes.
Installation tools: EVO7, EVO7SP, EVO9, EVO9HT, MK7P, MK7HT, MK9P.

Bundling and Securing

Self-Affixing Cable Ties

Arrowhead Mount Cable Ties

Push Mount Ties with Disc

The Arrowhead Mount Tie is a two-piece bundling and fastening solution that delivers strong extraction force. The cap blocks debris ingress through the mounting hole. This convenient combination is used in many markets, including automobile, aircraft and appliance.

Features and Benefits

- The arrowhead design of this push mount offers a low insertion force and a high extraction force.
- Integrated cap keeps out debris.

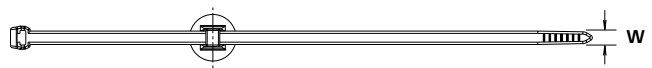
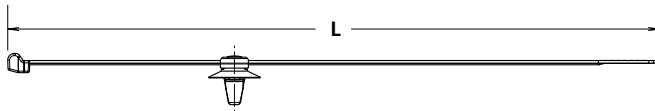

PART NO.	TYPE	Min. Tensile Strength lbs. (N)	Mounting Hole Dia. in. (mm)	Panel Thickness in. (mm)	Length (L) in. (mm)	Max. Bundle Diameter in. (mm)	Width (W) in. (mm)	Material Cable Tie	Material Arrowhead	Color	Pkg. Qty.
156-00455	T50ROS P1SFT6.5	50.0 (225.0)	0.25 - 0.26 (6.3 - 6.7)	0.03 - 0.05 (0.7 - 1.3)	7.9 (200.0)	1.8 (45.0)	0.2 (4.6)	PA46	PEEK	Gray, Beige	100
156-00456	T50ROS P2SFT6.5	50.0 (225.0)	0.25 - 0.26 (6.3 - 6.7)	0.07 - 0.09 (1.7 - 2.3)	7.9 (200.0)	1.8 (45.0)	0.2 (4.6)	PA46	PEEK	Gray, Beige	100

Dimensions are approximate and subject to technical changes. Use Part No. for ordering and Type for specification purposes.

Arrowhead Mount Cable Ties

Releasable Wing Push Mount Ties

One-piece mounting ties offer a complete solution by bundling cables while at the same time providing a mounting solution. This tie features an extended pawl, allowing the user to release the tie for bundle maintenance. Push mount ties offer the ideal combination of high specification materials and superior design to suit the mounting and bundling needs of complex applications.

Features and Benefits

- An all-in-one bundling and fixing solution reduces costs.
- High-specification materials and superior design suit the fixing and bundling needs of complex applications.
- Releasable to provide quick access to bundles.

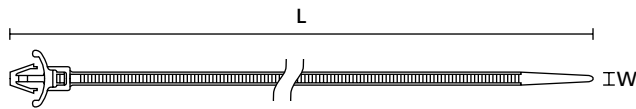

PART NO.	TYPE	Min. Tensile Strength lbs. (N)	Mounting Hole Dia. in. (mm)	Panel Thickness in. (mm)	Length (L) in. (mm)	Max. Bundle Diameter in. (mm)	Width (W) in. (mm)	Material	Color	Pkg. Qty.
115-06960	RT50SFK	50.0 (225.0)	0.25 - 0.28 (6.4 - 7.0)	0.03 - 0.31 (0.8 - 3.0)	9.0 (225.0)	2.0 (50.0)	0.2 (5.0)	PA66	Black	1000

Dimensions are approximate and subject to technical changes. Use Part No. for ordering and Type for specification purposes.
Installation tools: EVO7, EVO7SP, EVO9, EVO9HT, MK7P, MK7HT, MK9P.

Bundling and Securing

Self-Affixing Cable Ties

Fir Tree Mount Cable Ties

2-Piece Fir Tree Mount and Cable Tie Assemblies

HellermannTyton's fir tree mounts provide a secure grip in a mounting hole. The mount can slide along the cable tie to adjust orientation as needed. Fir tree mounts are designed to provide a low insertion force and high extraction force. This mount is sold as an assembly with the cable tie.

Features and Benefits

- Friction tab inside the fir tree allows the tie to sit in mount without falling out prior to installation.
- Fir tree provides low insertion effort yet demonstrates high extraction resistance.
- Disc feature prevents rattling in high-vibration applications and protects against debris ingress.

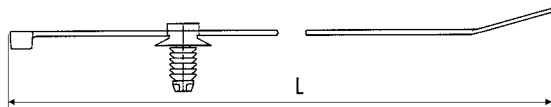

PART NO.	TYPE	Min. Tensile Strength lbs. (N)	Max. Bundle Diameter in. (mm)	Length (L) in. (mm)	Mounting Hole Dia. in. (mm)	Panel Thickness in. (mm)	Material Cable Tie	Material Fir Tree	Color	Pkg. Qty.
156-00953	T30RFT4	30.0 (135.0)	1.4 (35.0)	6.0 (148.0)	0.13 - 0.16 (3.3 - 4.0)	0.04-0.12 (1.0-3.0)	PA66HS	PA66HIRHS	Black	500
150-55948	T30RFT5	30.0 (135.0)	1.4 (34.0)	6.0 (150.0)	0.17 - 0.2 (4.5 - 5.0)	0.03-0.12 (0.7-3.0)	PA46	PA46	Natural, Gray	500
150-55850		30.0 (135.0)	1.4 (34.0)	6.0 (150.0)	0.17 - 0.2 (4.5 - 5.0)	0.03-0.12 (0.7-3.0)	PA66HS	PA66HIRHS	Black	500
150-31090	T30RFT6LG	30.0 (135.0)	1.4 (30.0)	6.0 (148.0)	0.25 - 0.28 (6.5 - 7.0)	0.03-0.24 (0.75-6.0)	PA66HS	PA66HIRHS	Black	500
150-77940	T30RFT6	30.0 (135.0)	1.4 (35.0)	6.0 (148.0)	0.25 - 0.28 (6.4 - 7.1)	0.03-0.12 (0.75-3.0)	PA66HS	PA66HIRHS	Black	500
156-00057	T30RFT7	30.0 (135.0)	1.4 (35.0)	6.0 (150.0)	0.26 - 0.28 (6.5 - 7.0)	0.03-0.28 (0.8-7.0)	PA66HS	PA66HS	Black	500
156-00375	T30RFT8	30.0 (135.0)	1.4 (36.0)	6.0 (148.0)	0.3 - 0.31 (7.7 - 8.0)	0.03-0.31 (0.8-7.9)	PA66HS	PA66HS	Black	500
156-00089	T30RFT10	30.0 (135.0)	1.4 (35.0)	6.0 (148.0)	0.38 - 0.39 (9.7 - 10.0)	0.03-0.20 (0.8-5.0)	PA66HS	PA66HS	Black	500
156-00025	T50RFT5	50.0 (225.0)	2.0 (45.0)	7.9 (200.0)	0.17 - 0.2 (4.5 - 5.0)	0.03-0.12 (0.7-3.0)	PA66HS	PA66HIRHS	Black	500

Dimensions are approximate and subject to technical changes. Use Part No. for ordering and Type for specification purposes.
Installation tools: EVO7, EVO7SP, EVO9, EVO9HT, MK7P, MK7HT, MK9P.

Fir Tree Mount Cable Ties

2-Piece Fir Tree Mount and Cable Tie Assemblies

PART NO.	TYPE	Min. Tensile Strength lbs. (N)	Max. Bundle Diameter in. (mm)	Length (L) in. (mm)	Mounting Hole Dia. in. (mm)	Panel Thickness in. (mm)	Material Cable Tie	Material Fir Tree	Color	Pkg. Qty.
156-00882	T50RFT 5.5SD	50.0 (225.0)	2.0 (45.0)	8.0 (203.2)	0.2 - 0.22 (5.0 - 5.7)	0.03-0.12 (0.7-4.5)	PA66HS	PA66HIRHS	Black	500
156-00457	T50RFT7HD	50.0 (225.0)	1.8 (50.0)	8.0 (200.0)	0.24 - 0.28 (6.2 - 7.2)	0.03-0.28 (0.8-7.0)	PA46	PA46	Brown	500
156-00329		50.0 (225.0)	1.8 (45.0)	8.0 (200.0)	0.24 - 0.28 (6.3 - 7.1)	0.03-0.28 (0.8-7.0)	PA66HS	PA66HIRHS	Black	500
150-31093	T50SFT6LG	50.0 (225.0)	1.4 (30.0)	6.0 (160.0)	0.25 - 0.28 (6.5 - 7.0)	0.03-0.24 (0.75-6.0)	PA66HS	PA66HIRHS	Black	500
150-31098	T50RFT6LG	50.0 (222.0)	2.0 (45.0)	8.0 (200.0)	0.25 - 0.28 (6.5 - 7.0)	0.03-0.24 (0.75-6.0)	PA46	PA46	Gray	500
150-31091		50.0 (225.0)	2.0 (45.0)	8.0 (202.0)	0.25 - 0.28 (6.5 - 7.0)	0.03-0.24 (0.75-6.0)	PA66HS	PA66HIRHS	Black	500
156-00157	T50RFT6	50.0 (225.0)	2.0 (45.0)	8.0 (202.0)	0.25 - 0.28 (6.4 - 7.1)	0.03-0.12 (0.75-3.0)	PA66HS	PA66HIRHS	Black	500
156-00156	T50SFT6	50.0 (225.0)	1.4 (35.0)	6.0 (160.0)	0.26 - 0.28 (6.5 - 7.0)	0.03-0.12 (0.75-3.0)	PA66HS	PA66HIRHS	Black	500
156-00056	T50SFT7	50.0 (225.0)	1.4 (35.0)	6.0 (160.0)	0.26 - 0.28 (6.5 - 7.0)	0.03-0.28 (0.8-7.0)	PA66HS	PA66HS	Black	500
111-85871	T50RFT7	50.0 (225.0)	2.0 (45.0)	7.9 (202.0)	0.26 - 0.28 (6.5 - 7.0)	0.03-0.28 (0.8-7.0)	PA66HS	PA66HS	Black	500
111-05350	T50IFT7	50.0 (225.0)	3.3 (85.0)	11.8 (305.0)	0.26 - 0.28 (6.5 - 7.0)	0.03-0.28 (0.8-7.0)	PA66HS	PA66HS	Black	500
156-00054	T50IFT6LG	50.0 (225.0)	3.3 (85.0)	12.0 (305.0)	0.26 - 0.28 (6.5 - 7.0)	0.03-0.24 (0.75-6.0)	PA66HS	PA66HIR	Black	500
156-00066	T50LFT6	50.0 (225.0)	4.3 (110.0)	15.0 (390.0)	0.26 - 0.28 (6.5 - 7.0)	0.03-0.12 (0.75-3.0)	PA66HS	PA66HIRHS	Black	500
156-00055	T50LFT7	50.0 (225.0)	4.3 (110.0)	15.0 (390.0)	0.26 - 0.28 (6.5 - 7.0)	0.03-0.28 (0.8-7.0)	PA66HS	PA66HS	Black	500
156-00282		50.0 (225.0)	3.4 (85.0)	15.0 (380.0)	0.26 - 0.28 (6.5 - 7.0)	0.03-0.28 (0.8-7.0)	PA66HS	PA66HS	Black	500
156-00376	T50RFT8	50.0 (225.0)	1.8 (48.0)	8.0 (202.0)	0.3 - 0.31 (7.7 - 8.0)	0.02-0.26 (0.8-6.0)	PA66HS	PA66HS	Black	500
156-00377	T50IFT8	50.0 (225.0)	3.4 (81.0)	12.0 (305.0)	0.3 - 0.31 (7.7 - 8.0)	0.03-0.24 (0.8-5.0)	PA66HS	PA66HS	Black	500
156-00378	T50LFT8	50.0 (225.0)	4.2 (105.0)	15.0 (380.0)	0.3 - 0.31 (7.7 - 8.0)	0.03-0.20 (0.8-5.0)	PA66HS	PA66HS	Black	500

Dimensions are approximate and subject to technical changes. Use Part No. for ordering and Type for specification purposes.
Installation tools: EVO7, EVO7SP, EVO9, EVO9HT, MK7P, MK7HT, MK9P.

Bundling and Securing

Self-Affixing Cable Ties

Fir Tree Mount Cable Ties

2-Piece Fir Tree Mount and Cable Tie Assemblies

PART NO.	TYPE	Min. Tensile Strength lbs. (N)	Max. Bundle Diameter in. (mm)	Length (L) in. (mm)	Mounting Hole Dia. in. (mm)	Panel Thickness in. (mm)	Material Cable Tie	Material Fir Tree	Color	Pkg. Qty.
156-00091	T50RFT10	50.0 (225.0)	1.8 (45.0)	8.0 (203.2)	0.38 - 0.39 (9.7 - 10.0)	0.03-0.20 (0.8-5.0)	PA66HS	PA66HS	Black	500
111-85810		50.0 (225.0)	1.8 (45.0)	8.0 (200.0)	0.38 - 0.39 (9.7 - 10.0)	0.03-0.20 (0.8-5.0)	PA66HS	PA66HS	Black	500
156-00092	T50IFT10	50.0 (225.0)	3.4 (81.0)	12.0 (305.0)	0.38 - 0.39 (9.7 - 10.0)	0.03-0.20 (0.8-5.0)	PA66HS	PA66HS	Black	500
156-00093	T50LFT10	50.0 (225.0)	4.3 (110.0)	15.0 (380.0)	0.38 - 0.39 (9.7 - 10.0)	0.03-0.20 (0.8-5.0)	PA66HS	PA66HS	Black	500
156-01336	PT2AFT6LG	51.7 (230.0)	1.4 (35.0)	5.7 (145.0)	0.25 - 0.28 (6.4 - 7.1)	0.03-0.24 (0.75-6.0)	PEEK	PA46	Beige, Gray	500
156-01555	PAT100R FT6LG	100.0 (445.0)	1.4 (35.0)	5.9 (149.9)	0.22 - 0.25 (5.6 - 6.4)	0.05-0.24 (1.25-6.0)	PAEK	PAEK	Beige	500
156-01513	PAT100L FT6LG	100.0 (445.0)	2.0 (50.8)	7.9 (200.7)	0.22 - 0.25 (5.6 - 6.4)	0.05-0.24 (1.25-6.0)	PAEK	PAEK	Beige	500
156-00068	WSSFT9A	120.0 (535.0)	2.3 (57.0)	9.0 (228.0)	0.34 - 0.36 (8.7 - 9.2)	0.04-0.26 (1.0-6.5)	PA66HIRHSUV	PA66HIRHSUV	Black	100
156-00072	WSSFT9B	120.0 (535.0)	2.3 (57.0)	9.0 (228.0)	0.34 - 0.36 (8.7 - 9.2)	0.04-0.62 (1.0-15.8)	PA66HS	PA66HIRHSUV	Black	100
156-00071	T120RFT9B	120.0 (535.0)	4.0 (100.0)	15.0 (380.0)	0.34 - 0.36 (8.7 - 9.2)	0.04-0.62 (1.0-15.8)	PA66HS	PA66HIRHSUV	Black	100
156-00067	T120RFT9A	120.0 (535.0)	4.0 (100.0)	15.0 (380.0)	0.34 - 0.36 (8.7 - 9.2)	0.04-0.26 (1.0-6.5)	PA66HS	PA66HIRHSUV	Black	100
156-00069	WSIFT9A	120.0 (535.0)	4.0 (102.0)	15.0 (387.0)	0.34 - 0.36 (8.7 - 9.2)	0.04-0.62 (1.0-6.5)	PA66HS	PA66HIRHSUV	Black	100
156-00070	WSRFT9A	120.0 (535.0)	4.1 (105.0)	15.0 (380.0)	0.34 - 0.36 (8.7 - 9.2)	0.04-0.62 (1.0-6.5)	PA66HS	PA66HIRHSUV	Black	100
156-00074	WSRFT9B	120.0 (535.0)	4.1 (105.0)	15.0 (380.0)	0.34 - 0.36 (8.7 - 9.2)	0.04-0.62 (1.0-15.8)	PA66HS	PA66HIRHSUV	Black	100

Dimensions are approximate and subject to technical changes. Use Part No. for ordering and Type for specification purposes.
Installation tools: EVO7, EVO7SP, EVO9, EVO9HT, MK7P, MK7HT, MK9P.

Fir Tree Mount Cable Ties

1-Piece Cable Ties with Fir Tree Mount with Disc

One-piece mounting ties offer a complete solution by both bundling and mounting wires, cables and tubes. The fir tree mount provides low insertion force with a high extraction force. Outside serrations on the cable tie leave a smooth interior surface that's gentler on sensitive wire insulation. The unique head design allows the cable tie to firmly hold bundles as small as .06" diameter. The disc offers added protection against debris.

Features and Benefits

- All-in-one bundling and fastening solution reduces costs and assembly time.
- Disc feature provides anti-rattle protection in high-vibration applications.

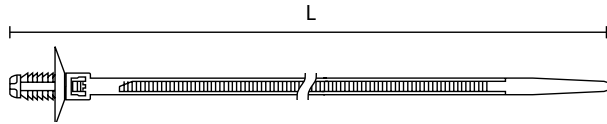

PART NO.	TYPE	Min. Mounting Hole Dia. in. (mm)	Max. Mounting Hole Dia. in. (mm)	Length (L) in. (mm)	Min. Tensile Strength lbs. (N)	Max. Bundle Diameter in. (mm)	Panel Thickness in. (mm)	Material	Color	Pkg. Qty.
157-00052	T50ROSFT6LGU	0.3 (6.5)	0.3 (7.2)	8.6 (220.0)	50.0 (225.0)	2.0 (50.0)	0.02 – 0.33 (0.6 – 8.5)	PA66HS	Black	500
157-00306	T50ROSFT6.5LG-E4	0.2 (6.1)	0.3 (6.9)	8.6 (218.1)	50.0 (225.0)	2.0 (50.0)	0.02 – 0.32 (0.6 – 8.3)	PA66HIRHS	Black	500
155-05800	T50SOSFT6E	0.3 (6.5)	0.3 (7.0)	6.0 (160.0)	50.0 (150.0)	1.4 (32.0)	0.03 – 0.12 (0.75 – 3.0)	PA66HIRHS	Black	1500
157-00050	T50SOSFT6LGU	0.3 (6.5)	0.3 (7.2)	6.5 (169.0)	50.0 (225.0)	1.4 (35.0)	0.02 – 0.33 (0.6 – 8.5)	PA66HS	Black	500
157-00376	T50SOSFT6.5-E4	0.2 (6.1)	0.3 (6.9)	6.3 (161.5)	50.0 (225.0)	1.4 (35.0)	0.02 – 0.17 (0.6 – 4.2)	PA66HS	Black	1000
157-00355	T50SOSFT6.5LG-E4	0.2 (6.1)	0.3 (6.9)	6.6 (167.9)	50.0 (225.0)	1.4 (35.0)	0.02 – 0.32 (0.6 – 8.3)	PA66HIRHS	Natural	4000
157-00296		0.2 (6.1)	0.3 (6.9)	6.6 (167.9)	50.0 (225.0)	1.4 (35.0)	0.02 – 0.32 (0.6 – 8.3)	PA66HIRHSUV	Black	4000
157-00373		0.2 (6.1)	0.3 (6.9)	6.6 (167.9)	50.0 (225.0)	1.4 (35.0)	0.02 – 0.32 (0.6 – 8.3)	PA66HIRHSUV	Black	500
157-00303		0.2 (6.1)	0.3 (6.9)	6.6 (168.0)	50.0 (225.0)	1.4 (35.0)	0.02 – 0.32 (0.6 – 8.3)	PA66HS	Gray	5000
157-00287	T50SOSFT6.5LG-E4X	0.3 (6.3)	0.3 (7.0)	6.5 (165.0)	50.0 (225.0)	1.4 (35.0)	0.03 – 0.28 (0.7 – 7.0)	PA66HS	Black	500
157-00359		0.3 (6.3)	0.3 (7.0)	6.5 (165.0)	50.0 (227.0)	1.4 (35.0)	0.03 – 0.28 (0.7 – 7.0)	PA66HS	Black	500
157-00302		0.3 (6.3)	0.3 (7.0)	6.5 (165.0)	50.0 (225.0)	1.4 (35.0)	0.03 – 0.28 (0.7 – 7.0)	PA66HIRHSUV	Black	4000
157-00115	T50SOSFT8E	0.3 (8.0)	0.3 (8.5)	6.4 (163.0)	50.0 (225.0)	1.4 (35.0)	0.02 – 0.24 (0.6 – 6.0)	PA46	Gray	1000
157-00072		0.3 (8.0)	0.3 (8.5)	6.4 (163.0)	50.0 (225.0)	1.4 (35.0)	0.02 – 0.24 (0.6 – 6.0)	PA66HS	Black	1000

Dimensions are approximate and subject to technical changes. Use Part No. for ordering and Type for specification purposes.
 Installation tools: EVO7, EVO7SP, EVO9, EVO9HT, MK7P, MK7HT, MK9P.

Bundling and Securing

Self-Affixing Cable Ties

Fir Tree Mount Cable Ties

1-Piece Cable Ties with Fir Tree

One-piece mounting ties offer a complete solution by both bundling cable and at the same time providing a mounting solution. HellermannTyton's one-piece mounting ties offer the ideal combination of high specification materials and superior design to suit the mounting and bundling needs of complex applications. Fir Tree design grips to the inside of a hole. They can be used on sheet metal, wood, and cast iron. Type T50RTM25E has a longer fir tree for larger panel thicknesses.

Features and Benefits

- Friction tab inside of fir tree allows tie to sit in mount without falling out prior to installation.
- Disc feature provides anti-rattle protection in high-vibration applications.
- All-in-one bundling and mounting solution reduces costs.

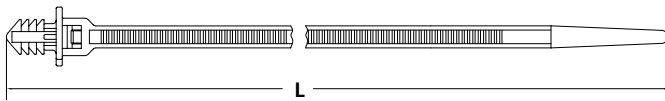
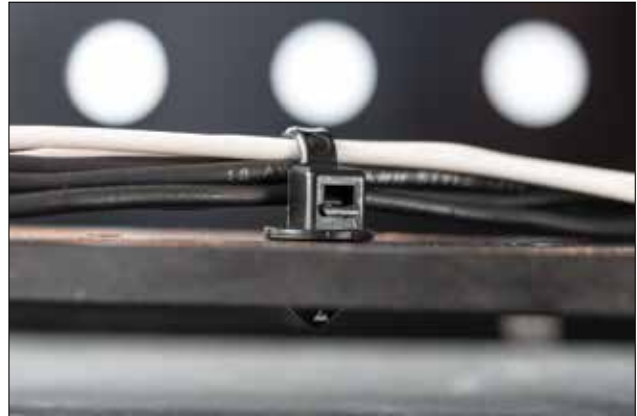

PART NO.	TYPE	Min. Mounting Hole Dia. in. (mm)	Max. Mounting Hole Dia. in. (mm)	Length (L) in. (mm)	Min. Tensile Strength lbs. (N)	Max. Bundle Diameter in. (mm)	Panel Thickness in. (mm)	Material	Color	Pkg. Qty.
T50RTM250HSM4	T50RTM25	0.3 (6.4)	0.3 (7.1)	8.0 (203.2)	50.0 (225.0)	2.0 (50.0)	0.05 – 0.28 (1.32 – 7.0)	PA66HS	Black	1000
T50RTM250HSC2		0.3 (6.2)	0.3 (7.0)	8.0 (213.1)	50.0 (222.0)	2.0 (50.8)	0.05 – 0.28 (1.32 – 7.0)	PA66HS	Black	100
157-00073	T50RTM25E	0.3 (6.3)	0.3 (7.0)	8.0 (209.6)	50.0 (222.0)	2.0 (50.0)	0.09 – 0.50 (2.3 – 13.9)	PA66HIRHS	Black	1000
T50RTM25E8HM4		0.3 (6.4)	0.3 (7.1)	8.0 (203.2)	50.0 (222.0)	2.0 (50.8)	0.09 – 0.50 (2.3 – 13.9)	PA66HIRHS	Gray	1000
T50RTM25E0HSM4		0.3 (6.3)	0.3 (7.0)	8.0 (213.8)	50.0 (222.0)	2.0 (50.8)	0.09 – 0.50 (2.3 – 13.9)	PA66HS	Black	1000

Dimensions are approximate and subject to technical changes. Use Part No. for ordering and Type for specification purposes.
Installation tools: EVO7, EVO7SP, EVO9, EVO9HT, MK7P, MK7HT, MK9P.

Fir Tree Mount Cable Ties

Offset Fir Tree Cable Ties

Offset cable ties route and position bundles away from a mounting hole. Rigid offset bar eliminates potential bending of wire or cables once installed. Multiple offset distances and fir tree sizes cover the majority of industry offset applications. The tie strap's outside serration design provides a smooth surface to protect soft bundles. HellermannTyton's one-piece mounting ties offer a complete solution by both bundling and mounting. Their ideal combination of high-specification materials and superior design suit the needs of complex applications.

Features and Benefits

- All-in-one bundling and fastening solution reduces costs and assembly time.
- Variety of fir tree diameters and offset lengths address most offset applications.
- High-spec materials and superior design deliver excellent performance and value.

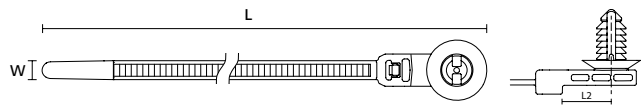

PART NO.	TYPE	Mounting Hole Dia. in. (mm)	Panel Thickness in. (mm)	Length (L) in. (mm)	Length (L2) in. (mm)	Min. Tensile Strength lbs. (N)	Max. Bundle Diameter in. (mm)	Material	Color	Pkg. Qty.
157-00145	T50ROSFT6SO12.5A	0.2 - 0.3 (6.1 - 7.0)	0.02 - 0.26 (0.60 - 6.65)	8.5 (215.5)	0.5 (12.5)	50.0 (222.0)	2.0 (50.0)	PA66HIRHS	Black	4000
157-00130		0.2 - 0.3 (6.1 - 7.0)	0.02 - 0.26 (0.60 - 6.65)	8.5 (215.5)	0.5 (12.5)	50.0 (222.0)	2.0 (50.0)	PA66HIRHS	Gray	4000
157-00165	T50ROSFT6SO12.5R	0.2 - 0.3 (6.1 - 7.0)	0.02 - 0.32 (0.60 - 8.25)	8.8 (223.1)	0.5 (12.5)	50.0 (222.0)	2.0 (50.0)	PA66HIRHS	Black	500
157-00158	T50ROSFT6SO25A	0.2 - 0.3 (6.1 - 7.0)	0.02 - 0.26 (0.60 - 6.65)	9.1 (230.0)	1.0 (25.0)	50.0 (222.0)	2.0 (50.0)	PA46	Brown	500
157-00150		0.2 - 0.3 (6.1 - 7.0)	0.02 - 0.26 (0.60 - 6.65)	9.1 (230.0)	1.0 (25.0)	50.0 (222.0)	2.0 (50.0)	PA66HIRHS	Black	500
157-00119		0.2 - 0.3 (6.1 - 7.0)	0.02 - 0.26 (0.60 - 6.65)	9.1 (230.0)	1.0 (25.0)	50.0 (222.0)	2.0 (50.0)	PA66HIRHS	Gray	3000
157-00164	T50ROSFT6SO25R	0.2 - 0.3 (6.1 - 7.0)	0.02 - 0.32 (0.60 - 8.25)	9.4 (237.7)	1.0 (25.0)	50.0 (222.0)	2.0 (50.0)	PA66HIRHS	Black	500
157-00120	T50ROSFT8SO25A	0.3 - 0.3 (7.6 - 8.4)	0.02 - 0.26 (0.60 - 6.65)	9.1 (230.0)	1.0 (25.0)	50.0 (222.0)	2.0 (50.0)	PA66HIRHS	Gray	500
157-00216	T50ROSFT612.5SO	0.2 - 0.3 (6.1 - 6.9)	0.02 - 0.24 (0.60 - 6.0)	9.2 (234.2)	0.5 (12.5)	50.0 (222.0)	2.0 (50.0)	PA66HIRHS	Black	3000
157-00195	T50ROSFT625SO	0.2 - 0.3 (6.1 - 6.9)	0.02 - 0.32 (0.60 - 8.25)	9.7 (247.2)	1.0 (25.0)	50.0 (222.0)	2.0 (50.0)	PA66HIRHS	Black	500
157-00217	T50ROSFT812.5SO	0.3 - 0.3 (7.6 - 8.4)	0.02 - 0.20 (0.60 - 5.0)	9.1 (222.9)	0.5 (12.5)	50.0 (222.0)	2.0 (50.0)	PA66HIRHS	Black	1000
157-00196	T50ROSFT825SO	0.3 - 0.3 (7.6 - 8.4)	0.02 - 0.24 (0.60 - 6.0)	9.6 (245.1)	1.0 (25.0)	50.0 (222.0)	2.0 (50.0)	PA66HIRHS	Black	500
157-00118	T50ROSFTM6SO12.5A	0.2 (M6)	0.02 - 0.26 (0.60 - 6.65)	8.5 (215.5)	0.5 (12.5)	50.0 (222.0)	2.0 (50.0)	PA66HIRHS	Gray	500
157-00131	T50ROSFTM6SO12.5B	0.2 (M6)	0.02 - 0.26 (0.60 - 6.65)	8.5 (215.5)	0.5 (12.5)	50.0 (222.0)	2.0 (50.0)	PA66HIRHS	Black	500

Dimensions are approximate and subject to technical changes. Use Part No. for ordering and Type for specification purposes.
Installation tools: EVO7, EVO7SP, EVO9, EVO9HT, MK7P, MK7HT, MK9P.

Bundling and Securing

Self-Affixing Cable Ties

Fir Tree Mount Cable Ties

Offset Oval Fir Tree Cable Ties

One-piece offset cable tie and mount offers a simple bundling and mounting solution. The innovative design of this fir tree establishes a 360-degree interface with the panel hole, ensuring a more secure fit. The oval shape won't rotate once inserted, ensuring proper routing of wires and hoses. Offset feature positions bundles away from a mounting hole. The disc feature prevents rattling in high-vibration applications and protects against debris ingress.

Features and Benefits

- All-in-one bundling and fastening solution reduces costs and assembly time.
- Anti-rotational oval fastener forces bundle to travel in intended direction.
- Offset cable ties route and position bundles away from a mounting hole to protect them from rubbing, heat or obstructions.

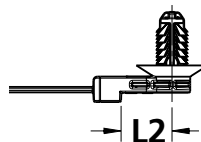

PART NO.	TYPE	Mounting Hole Dia. in. (mm)	Panel Thickness in. (mm)	Length (L) in. (mm)	Length (L2) in. (mm)	Min. Tensile Strength lbs. (N)	Max. Bundle Diameter in. (mm)	Material	Color	Pkg. Qty.
157-00224	T50ROSFT OVAL12.5A	0.2 x 0.48; 0.25 x 0.50; 0.25 x 0.51; 0.27 x 0.47 (6.2 x 12.2), (6.5 x 12.5), (6.5 x 13.0), (7.0 x 12.0)	0.02 – 0.27 (0.6 – 6.75)	8.5 (216.8)	0.5 (12.5)	50.0 (225.0)	2.0 (50.0)	PA66HIRHS	Black	500
157-00225		0.2 x 0.48; 0.25 x 0.50; 0.25 x 0.51; 0.27 x 0.47 (6.2 x 12.2), (6.5 x 12.5), (6.5 x 13.0), (7.0 x 12.0)	0.02 – 0.27 (0.6 – 6.75)	8.5 (216.8)	0.5 (12.5)	50.0 (225.0)	2.0 (50.0)	PA66HIRHS	Gray	500
157-00249	T50ROSFT OVAL12.5B	0.2 x 0.48; 0.25 x 0.50; 0.25 x 0.51; 0.27 x 0.47 (6.2 x 12.2), (6.5 x 12.5), (6.5 x 13.0), (7.0 x 12.0)	0.02 – 0.27 (0.6 – 6.75)	8.5 (216.8)	0.5 (12.5)	50.0 (225.0)	2.0 (50.0)	PA66HIRHS	Black	1000
157-00221	T50ROSFT OVAL25R	0.2 x 0.48; 0.25 x 0.50; 0.25 x 0.51; 0.27 x 0.47 (6.2 x 12.2), (6.5 x 12.5), (6.5 x 13.0), (7.0 x 12.0)	0.02 – 0.27 (0.6 – 6.75)	9.3 (237.4)	1.0 (25.0)	50.0 (225.0)	2.0 (50.0)	PA66HIRHS	Black	500

Dimensions are approximate and subject to technical changes. Use Part No. for ordering and Type for specification purposes.
Installation tools: EVO7, EVO7SP, EVO9, EVO9HT, MK7P, MK7HT, MK9P.

Fir Tree Mount Cable Ties

Oval Fir Tree Cable Ties

One-piece cable tie and mount offers a simple bundling and mounting solution. The innovative design of this fir tree establishes a 360-degree interface with the panel hole, ensuring a more secure fit. The oval shape won't rotate once inserted, ensuring proper routing of wires and hoses. The disc feature prevents rattling in high-vibration applications and protects against debris ingress.

Features and Benefits

- All-in-one bundling and fastening solution reduces costs and assembly time.
- Anti-rotational oval fastener forces bundle to travel in intended direction.
- High-spec materials and superior design deliver excellent performance and value.

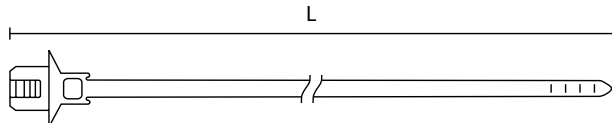

PART NO.	TYPE	Min. Mounting Hole Dia. in. (mm)	Max. Mounting Hole Dia. in. (mm)	Panel Thickness in. (mm)	Length (L) in. (mm)	Min. Tensile Strength lbs. (N)	Max. Bundle Diameter in. (mm)	Material	Color	Pkg. Qty.
157-00288	T50ROSFTOVAL25A	0.2 (6.2)	0.5 (13.0)	0.02 – 0.27 (0.6 – 6.75)	9.0 (229.3)	50.0 (225.0)	2.0 (50.0)	PA46	Brown	500
157-00222		0.2 (6.2)	0.5 (13.0)	0.02 – 0.27 (0.6 – 6.75)	9.0 (229.3)	50.0 (225.0)	2.0 (50.0)	PA66HIRHS	Black	500
157-00205		0.2 (6.2)	0.5 (13.0)	0.02 – 0.27 (0.6 – 6.75)	9.0 (229.3)	50.0 (225.0)	2.0 (50.0)	PA66HIRHS	Gray	500
157-00332	T50ROSFTOVAL25B	0.2 (6.2)	0.5 (13.0)	0.02 – 0.27 (0.6 – 6.75)	9.0 (229.3)	50.0 (225.0)	2.0 (50.0)	PA46	Black	1000
157-00247		0.2 (6.2)	0.5 (13.0)	0.02 – 0.27 (0.6 – 6.75)	9.0 (229.3)	50.0 (225.0)	2.0 (50.0)	PA66HIRHS	Black	1000
157-00323	T50ROSFTOVALIL25A	0.2 (6.2)	0.5 (13.0)	0.02 – 0.27 (0.6 – 6.75)	9.0 (232.3)	50.0 (225.0)	2.0 (50.0)	PA66HIRHS	Black	1000
157-00333	T50ROSFTOVALIL25B	0.2 (6.2)	0.5 (13.0)	0.02 – 0.27 (0.6 – 6.75)	9.0 (232.3)	50.0 (225.0)	2.0 (50.0)	PA66HIRHS	Black	2000
157-00232	T50ROSFTOVALR	0.2 (6.2)	0.5 (13.0)	0.02 – 0.24 (0.6 – 6.0)	8.6 (219.3)	50.0 (225.0)	2.0 (50.0)	PA66HIRHS	Black	500
157-00391	T50ROSFTOVALU	0.2 (6.2)	0.5 (12.2)	0.02 – 0.24 (0.6 – 6.0)	8.9 (225.0)	50.0 (222.0)	2.0 (50.0)	PA66HIRHS	Black	3000
157-00153		0.2 (6.2)	0.5 (12.2)	0.02 – 0.24 (0.6 – 6.0)	8.9 (225.0)	50.0 (222.0)	2.0 (50.0)	PA66HIRHS	Gray	500
157-00254		0.2 (6.2)	0.5 (12.2)	0.02 – 0.24 (0.6 – 6.0)	8.9 (225.0)	50.0 (222.0)	2.0 (50.0)	PA66HS	Black	500
157-00157		0.2 (6.2)	0.5 (12.2)	0.02 – 0.27 (0.6 – 6.75)	8.6 (219.0)	50.0 (225.0)	2.0 (50.0)	PA46	Brown	500
157-00142		0.2 (6.2)	0.5 (13.0)	0.02 – 0.27 (0.6 – 6.75)	8.6 (219.0)	50.0 (225.0)	2.0 (50.0)	PA66HIRHS	Black	3000

Dimensions are approximate and subject to technical changes. Use Part No. for ordering and Type for specification purposes.
Installation tools: EVO7, EVO7SP, EVO9, EVO9HT, MK7P, MK7HT, MK9P.

Bundling and Securing

Self-Affixing Cable Ties

Fir Tree Mount Cable Ties

Oval Fir Tree Cable Ties

PART NO.	TYPE	Min. Mounting Hole Dia. in. (mm)	Max. Mounting Hole Dia. in. (mm)	Panel Thickness in. (mm)	Length (L) in. (mm)	Min. Tensile Strength lbs. (N)	Max. Bundle Diameter in. (mm)	Material	Color	Pkg. Qty.
157-00268	T50ROSFTSOVAL	0.2 (6.2)	0.5 (13.0)	0.02 – 0.12 (0.6 – 3.0)	8.5 (215.0)	50.0 (225.0)	2.0 (50.0)	PA66HIRHS	Black	500
157-00069	T50SOS2DOP62X122-E	0.2 (6.2)	0.5 (12.2)	0.02 – 0.24 (0.6 – 6.0)	6.5 (164.0)	45.0 (200.0)	1.4 (35.0)	PA46	Gray	1000
157-00014		0.2 (6.2)	0.5 (12.2)	0.02 – 0.24 (0.6 – 6.0)	6.5 (164.0)	50.0 (225.0)	1.4 (35.0)	PA66HS	Black	500
157-00184	T50SOS3DOP65X130-E	0.3 (6.5)	0.5 (13.0)	0.03 – 0.20 (0.7 – 5.0)	6.5 (165.0)	50.0 (180.0)	1.4 (35.0)	PA66HS	Black	500
157-00053	T50SOSFT7X12U	0.3 (7.0)	0.5 (12.0)	0.02 – 0.16 (0.6 – 4.0)	6.5 (165.0)	50.0 (225.0)	1.4 (35.0)	PA66HS	Black	500
157-00253	T50SOSFTOVALU	0.2 (6.2)	0.5 (13.0)	0.02 – 0.27 (0.6 – 6.75)	6.6 (168.2)	50.0 (225.0)	1.4 (35.0)	PA66HS	Black	500
157-00143		0.2 (6.2)	0.5 (13.0)	0.02 – 0.27 (0.6 – 6.75)	6.6 (168.2)	50.0 (225.0)	1.4 (35.0)	PA66HS	Black	3000
157-00266		0.2 (6.2)	0.5 (13.0)	0.02 – 0.27 (0.6 – 6.75)	6.6 (168.2)	50.0 (225.0)	1.4 (35.0)	PA66HS	Gray	500
157-00154		0.2 (6.2)	0.5 (13.0)	0.02 – 0.27 (0.6 – 6.75)	6.6 (168.2)	50.0 (225.0)	1.4 (35.0)	PA66HS	Gray	1000

Dimensions are approximate and subject to technical changes. Use Part No. for ordering and Type for specification purposes.
Installation tools: EVO7, EVO7SP, EVO9, EVO9HT, MK7P, MK7HT, MK9P.

Fir Tree Mount Cable Ties

Stand-Off Oval Fir Tree Cable Ties

One-piece standoff cable tie and mount offers a simple bundling and mounting solution. The innovative design of this fir tree establishes a 360-degree interface with the panel hole, ensuring a more secure fit. The oval shape won't rotate once inserted, ensuring proper routing of wires and hoses. Standoff feature positions bundles above a mounting hole. The disc feature prevents rattling in high-vibration applications and protects against debris ingress.

Features and Benefits

- All-in-one bundling and fastening solution reduces costs and assembly time.
- Anti-rotational oval fastener forces bundle to travel in intended direction.
- Stand-off cable ties route and position bundles above a mounting hole to protect them from rubbing, heat or obstructions.

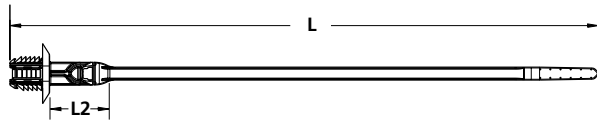

PART NO.	TYPE	Mounting Hole Dia. in. (mm)	Panel Thickness in. (mm)	Length (L) in. (mm)	Length (L2) in. (mm)	Min. Tensile Strength lbs. (N)	Max. Bundle Diameter in. (mm)	Material	Color	Pkg. Qty.
157-00218	T50ROSFT OVAL 12.5SO	0.2 x 0.48; 0.25 x 0.50; 0.25 x 0.51; 0.27 x 0.47 (6.2 x 12.2), (6.5 x 12.5), (6.5 x 13.0), (7.0 x 12.0)	0.02 – 0.27 (0.6 – 6.75)	9.1 (231.3)	0.5 (12.5)	50.0 (220.0)	2.0 (50.0)	PA66HIRHS	Black	1000
157-00219	T50ROSFT OVAL 25SO	0.2 x 0.48; 0.25 x 0.50; 0.25 x 0.51; 0.27 x 0.47 (6.2 x 12.2), (6.5 x 12.5), (6.5 x 13.0), (7.0 x 12.0)	0.02 – 0.27 (0.6 – 6.75)	9.6 (243.8)	1.0 (25.0)	50.0 (220.0)	2.0 (50.0)	PA66HIRHS	Black	500
157-00379	T50ROSFT OVALIL 125SO	0.2 x 0.48; 0.25 x 0.50; 0.25 x 0.51; 0.27 x 0.47 (6.2 x 12.2), (6.5 x 12.5), (6.5 x 13.0), (7.0 x 12.0)	0.02 - 0.27 (0.6 - 6.75)	6.5 (164.0)	0.5 (12.5)	50.0 (225.0)	1.4 (35.0)	PA66HIRHSUV	Black	500

Dimensions are approximate and subject to technical changes. Use Part No. for ordering and Type for specification purposes. Installation tools: EVO7, EVO7SP, EVO9, EVO9HT, MK7P, MK7HT, MK9P.

Bundling and Securing

Self-Affixing Cable Ties

Fir Tree Mount Cable Ties

Releasable Cable Tie with Fir Tree Mount

The releasable cable tie with fir tree mount offers a complete bundling and fastening solution. The extended pawl allows the user to release the tie for bundle maintenance. HellermannTyton's one-piece mounting ties deliver the ideal combination of high-specification materials and superior design.

Features and Benefits

- An all-in-one bundling and mounting solution that reduces parts and costs.
- High-specification materials and superior design suit the bundling and fastening requirements of complex applications.
- Release feature allows maintenance or changeouts as needed.

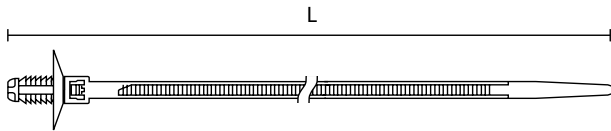
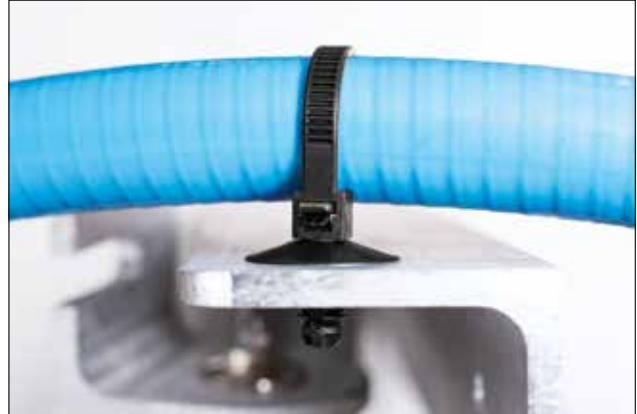

PART NO.	TYPE	Min. Mounting Hole Dia. in. (mm)	Max. Mounting Hole Dia. in. (mm)	Length (L) in. (mm)	Min. Tensile Strength lbs. (N)	Max. Bundle Diameter in. (mm)	Panel Thickness in. (mm)	Material	Color	Pkg. Qty.
150-55500	REL30SDP6	0.3 (6.3)	0.3 (7.1)	6.7 (170.0)	30.0 (135.0)	1.2 (31.0)	0.12 – 0.28 (3.0 – 7.0)	PA66	Black	500

Dimensions are approximate and subject to technical changes. Use Part No. for ordering and Type for specification purposes.
Installation tools: EVO7, EVO7SP, EVO9, EVO9HT, MK7P, MK7HT, MK9P.

Stud Mount Cable Ties

Stud Mount Ties

Stud Mount Ties offer outstanding stud retention. With their low insertion force and high extraction performance, HellermannTyton mounting ties offer the ideal combination of high-grade materials and superior design to suit the mounting and bundling needs of complex applications. Available in standard and high-heat material options.

Features and Benefits

- Covers top of stud for protection from stud end.
- Four-pawl, three-tooth design delivers outstanding stud retention to keep bundles secure.
- PA46 material option allows use in high-heat applications.

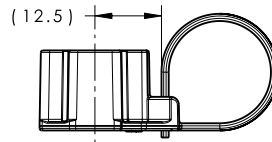
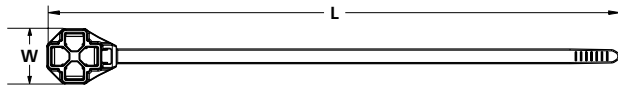

PART NO.	TYPE	Stud Dia. in.	Stud Dia. (mm)	Min. Tensile Strength lbs. (N)	Length (L) in. (mm)	Max. Bundle Diameter in. (mm)	Width (W) in. (mm)	Material	Color	Pkg. Qty.
157-00233	T50ROSSB5-6U	0.20, 0.24	(5.0, 6.0)	50.0 (225.0)	8.6 (218.5)	2.0 (50.0)	0.6 (14.2)	PA66HIRHS	Black	1500
157-00290	T80ROSSB8U	0.31	(8.0)	80.0 (335.0)	8.3 (212.0)	2.0 (50.0)	0.7 (17.8)	PA66HIRHSUV	Black	3000
157-00293		0.31	(8.0)	80.0 (355.0)	8.3 (212.0)	2.0 (50.0)	0.7 (17.8)	PA46	Brown	3000
157-00291	T80ROSSB10U	0.39	(10.0)	80.0 (335.0)	8.5 (215.0)	2.0 (50.0)	0.2 (5.5)	PA66HIRHSUV	Black	2000
157-00294		0.39	(10.0)	80.0 (335.0)	8.5 (215.0)	2.0 (50.0)	0.2 (5.5)	PA46	Brown	2000
157-00292	T80ROSSB12U	0.47	(12.0)	80.0 (355.0)	8.6 (218.0)	2.0 (50.0)	0.9 (23.8)	PA66HIRHSUV	Black	3000
157-00295		0.47	(12.0)	80.0 (355.0)	8.6 (218.0)	2.0 (50.0)	0.9 (23.8)	PA46	Brown	3000

Dimensions are approximate and subject to technical changes. Use Part No. for ordering and Type for specification purposes.
Installation tools: EVO9, EVO9HT, MK9P.

Bundling and Securing

Self-Affixing Cable Ties

Stud Mount Cable Ties

Oval Shaped Variable Stud Mount Ties

Oval Shaped Stud Mount's special design allows for a .20" (5.5 mm) lateral adjustment, allowing for any misalignment of the stud or incorrect position of the tie on the cables. The mount allows it to be installed onto a weld stud without the use of any tools.

Features and Benefits

- Head allows for a .2" lateral adjustment on stud during installation.
- Quick and easy installation ideal for manufacturing environment.

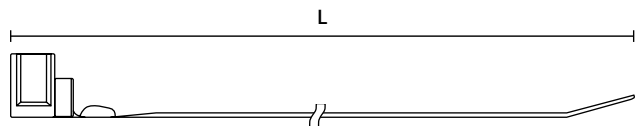
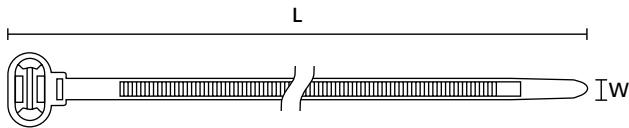
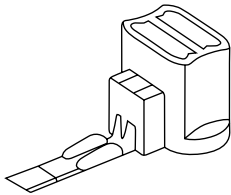

PART NO.	TYPE	Stud Dia. in.	Stud Dia. (mm)	Min. Tensile Strength lbs. (N)	Length (L) in. (mm)	Max. Bundle Diameter in. (mm)	Width (W) in. (mm)	Material	Color	Pkg. Qty.
155-46302	T50SOSSB6HE	0.24	(6.0)	50.0 (170.0)	6.0 (160.0)	1.4 (35.0)	0.2 (4.7)	PA66HS	Black	500
157-00151	T50SOSSB5-High-E-C-CC	0.20, 0.24	(5.0), M6	225.0 (225.0)	6.6 (167.0)	1.4 (35.0)	0.2 (5.0)	PA66HS	Gray	5000
157-00105		0.20	(5.0)	50.0 (225.0)	6.6 (167.0)	1.4 (35.0)	0.2 (5.0)	PA66HS	Black	3000
157-00106	T50SOSSB5-High-E-O-US	0.20	(5.0)	50.0 (225.0)	6.6 (167.0)	1.4 (35.0)	0.2 (5.0)	PA66HS	Black	3000

Dimensions are approximate and subject to technical changes. Use Part No. for ordering and Type for specification purposes.
 Installation tools: EVO7, EVO7SP, EVO9, EVO9HT, MK7P, MK7HT, MK9P.

Stud Mount Cable Ties

Offset Stud Mount Ties

This mount features an offset design, which positions bundles away from obstructions, heat or sources of abrasion. With their low insertion force and high extraction performance, HellermannTyton mounting ties offer the ideal combination of high-grade materials and superior design to suit the mounting and bundling needs of complex applications. Available in standard and high-heat material options.

Features and Benefits

- Offset design positions bundles away from obstructions, heat or sources of abrasion.
- Four-pawl, three-tooth design delivers outstanding stud retention to keep bundles secure.
- PA46 material option allows use in high-heat applications.

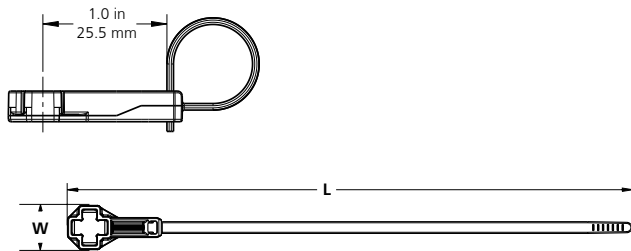

PART NO.	TYPE	Stud Dia. in.	Stud Dia. (mm)	Min. Tensile Strength lbs. (N)	Length (L) in. (mm)	Max. Bundle Diameter in. (mm)	Width (W) in. (mm)	Material	Color	Pkg. Qty.
157-00325	T50ROSM6SMS025	0.20, 0.24	(5.0, 6.0)	50.0 (225.0)	8.8 (224.0)	2.0 (50.0)	0.6 (14.2)	PA66HIRHSUV	Black	2000
157-00326		0.20, 0.24	(5.0, 6.0)	50.0 (223.0)	8.8 (224.0)	2.0 (50.0)	0.6 (14.2)	PA46	Brown	2000
157-00327	T50ROSM8SMS025	0.31	(8.0)	50.0 (223.0)	8.9 (226.0)	2.0 (50.0)	0.7 (17.8)	PA66HIRHSUV	Black	3000
157-00328		0.31	(8.0)	50.0 (223.0)	8.9 (226.1)	2.0 (50.0)	0.7 (17.8)	PA46	Brown	3000

Dimensions are approximate and subject to technical changes. Use Part No. for ordering and Type for specification purposes.
Installation tools: EVO7, EVO7SP, EVO9, EVO9HT, MK7P, MK7HT, MK9P.

Bundling and Securing

Self-Affixing Cable Ties

Stud Mount Cable Ties

Offset Low-Profile Stud Mount Ties

This mount's offset design positions bundles away from obstructions, heat or sources of abrasion. It features a low-profile head, allowing multiple tie mounts to be stacked on a single bolt and providing space savings in tight areas. With their low insertion force and high extraction performance, HellermannTyton mounting ties offer the ideal combination of high-grade materials and superior design to suit the mounting and bundling needs of complex applications. Available in standard and high-heat material options.

Features and Benefits

- Offset design positions bundles away from obstructions, heat or sources of abrasion.
- Low profile head allows mounts to stack, providing more mounting versatility from a single stud.
- Four-pawl, three-tooth design delivers outstanding stud retention to keep bundles secure.
- PA46 material option allows use in high-heat applications.

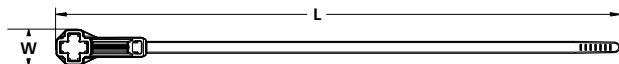
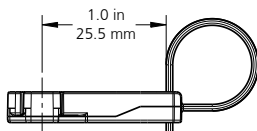

PART NO.	TYPE	Stud Dia. in.	Stud Dia. (mm)	Min. Tensile Strength lbs. (N)	Length (L) in. (mm)	Max. Bundle Diameter in. (mm)	Width (W) in. (mm)	Material	Color	Pkg. Qty.
157-00335	T50ROSLPM6SMS025	0.20, 0.24	(5.0, 6.0)	50.0 (223.0)	8.8 (224.0)	2.0 (50.0)	0.6 (4.7)	PA66HIRHSUV	Black	3000
157-00338		0.20, 0.24	(5.0, 6.0)	50.0 (223.0)	8.8 (224.0)	2.0 (50.0)	0.6 (4.7)	PA46	Brown	3000
157-00362	T50ROSLPM8SMS025	0.31	(8.0)	50.0 (223.0)	8.9 (226.1)	2.0 (50.0)	0.7 (17.8)	PA66HIRHSUV	Black	3000
157-00361		0.31	(8.0)	50.0 (223.0)	8.9 (226.1)	2.0 (50.0)	0.7 (17.8)	PA46	Brown	3000

Dimensions are approximate and subject to technical changes. Use Part No. for ordering and Type for specification purposes.
Installation tools: EVO7, EVO7SP, EVO9, EVO9HT, MK7P, MK7HT, MK9P.

Stud Mount Cable Ties

Two-Piece Stud Mount Ties

Unique, two-piece design allows routing to be above, parallel or perpendicular to stud. This also enables up to three separate bundles to be fastened to the same stud. With their low insertion force and high extraction performance, HellermannTyton mounting ties offer the ideal combination of high-grade materials and superior design to suit the mounting and bundling needs of complex applications. Available in standard and high-heat material options.

Features and Benefits

- Versatile design allows cable routing above, perpendicular or parallel to stud.
- Can mount up to three bundles simultaneously, making efficient use of a single mounting point.
- Four-pawl, three-tooth design delivers outstanding stud retention to keep bundles secure.
- PA46 material option allows use in high-heat applications.

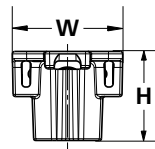
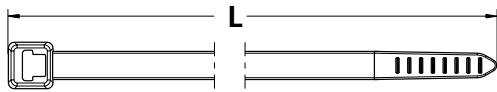

PART NO.	TYPE	Stud Dia. in.	Stud Dia. (mm)	Min. Tensile Strength lbs. (N)	Length (L) in. (mm)	Max. Bundle Diameter in. (mm)	Width (W) in. (mm)	Material Cable Tie	Material Stud Mount	Color	Pkg. Qty.
156-01547	T50R0SB55-6U-SET	0.20, 0.24	(5.0, 6.0)	50.0 (223.0)	8.0 (202.0)	2.0 (50.0)	0.9 (23.3)	PA66HS	PA66HIRHS	Black	3000
156-01668	T50R1SB5-6USET	0.20, 0.24	(5.0, 6.0)	50.0 (223.0)	8.0 (202.0)	2.0 (50.0)	0.9 (23.3)	PA46	PA46	Gray, Brown	3000
156-02232	PAT100LSB55-6U2SET	0.20, 0.24	(5.0, 6.0)	50.0 (223.0)	8.0 (202.0)	2.0 (50.0)	0.9 (23.3)	PPS	PAEK	Silver, Beige	3000

Dimensions are approximate and subject to technical changes. Use Part No. for ordering and Type for specification purposes.
 Installation tools: EVO7, EVO7SP, EVO9, EVO9HT, MK7P, MK7HT, MK9P.

Bundling and Securing

Self-Affixing Cable Ties

Stud Mount Cable Ties

Low-Profile Stud Mount Ties

Mount features a low-profile head, allowing multiple tie mounts to be stacked on a single bolt and providing space savings in tight areas. With their low insertion force and high extraction performance, HellermannTyton mounting ties offer the ideal combination of high-grade materials and superior design to suit the mounting and bundling needs of complex applications. Available in standard and high-heat material options.

Features and Benefits

- Low-profile head allows mounts to stack, providing more mounting versatility from a single stud.
- Four-pawl, three-tooth design delivers outstanding stud retention to keep bundles secure.
- PA46 material option allows use in high-heat applications.

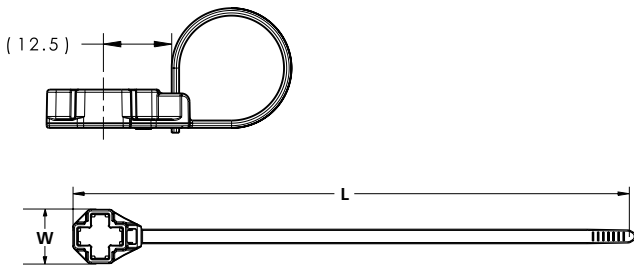

PART NO.	TYPE	Stud Dia. in.	Stud Dia. (mm)	Min. Tensile Strength lbs. (N)	Length (L) in. (mm)	Max. Bundle Diameter in. (mm)	Width (W) in. (mm)	Material	Color	Pkg. Qty.
157-00340	T80ROSLPSB8U	0.31	(8.0)	80.0 (355.0)	8.3 (212.0)	2.0 (50.0)	0.7 (17.8)	PA66HIRHSUV	Black	3000
157-00341		0.31	(8.0)	80.0 (355.0)	8.3 (212.0)	2.0 (50.0)	0.7 (17.8)	PA46	Brown	3000
157-00342	T80ROSLPSB10U	0.39	(10.0)	80.0 (355.0)	8.5 (215.0)	2.0 (50.0)	0.2 (5.5)	PA66HIRHSUV	Black	3500
157-00343		0.39	(10.0)	80.0 (355.0)	8.5 (215.0)	2.0 (50.0)	0.2 (5.5)	PA46	Brown	3500
157-00344	T80ROSLPSB12U	0.47	(12.0)	80.0 (355.0)	8.6 (218.0)	2.0 (50.0)	0.9 (23.8)	PA66HIRHSUV	Black	3000
157-00345		0.47	(12.0)	80.0 (355.0)	8.6 (218.0)	2.0 (50.0)	0.9 (23.8)	PA46	Brown	3000

Dimensions are approximate and subject to technical changes. Use Part No. for ordering and Type for specification purposes.
Installation tools: EVO7, EVO7SP, EVO9, EVO9HT, MK7P, MK7HT, MK9P.

Stud Mount Cable Ties

Wide Strap Heavy Duty Stud Mount Cable Ties

The Wide Strap Stud Mount Cable Tie minimizes pinching on soft bundles and features a low profile head to provide compact bundling. A thinner strap provides increased flexibility for improved ergonomics. Available in various stud mount sizes, the wide strap tie utilizes a strong hinge between the stud mount and head to provide superior holding ability on a threaded stud.

Features and Benefits

- Mount provides low insertion and high extraction forces which makes for a strong and easy installation.
- Tie utilizes a strong hinge between the stud mount and strap head to provide superior holding ability.
- Clamping rails increase grip on round bundles.
- Thinner strap provides increased flexibility for improved ergonomics.

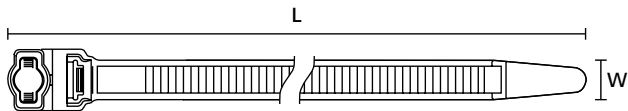

PART NO.	TYPE	Stud Dia. in. (mm)	Min. Tensile Strength lbs. (N)	Length (L) in. (mm)	Max. Bundle Diameter in. (mm)	Width (W) in. (mm)	Material	Color	Pkg. Qty.
157-00281	WSS6MM	1/4 (M6)	120.0 (534.0)	9.7 (246.4)	2.2 (57.1)	0.5 (12.7)	PA66HIRHSUV	Black	300
157-00282	WSI6MM	1/4 (M6)	120.0 (534.0)	12.7 (322.6)	3.2 (82.5)	0.5 (12.7)	PA66HIRHSUV	Black	300
157-00402	WSR250	1/4 (M6)	120.0 (534.0)	15.7 (398.8)	4.1 (104.1)	0.5 (12.7)	PA66HIRHSUV	Black	300
157-00283	WSR6MM	1/4 (M6)	120.0 (534.0)	15.7 (398.8)	4.1 (104.1)	0.5 (12.7)	PA66HIRHSUV	Black	300
157-00400	WSS250	1/4 (M6)	120.0 (534.0)	9.7 (246.4)	2.2 (57.1)	0.5 (12.7)	PA66HIRHSUV	Black	300
157-00401	WSI250	1/4 (M6)	120.0 (534.0)	12.7 (322.6)	3.2 (82.5)	0.5 (12.7)	PA66HIRHSUV	Black	300
157-00403	WSS380	3/8 (M10)	120.0 (534.0)	9.7 (246.4)	2.2 (57.1)	0.5 (12.7)	PA66HIRHSUV	Black	300
157-00404	WSI380	3/8 (M10)	120.0 (534.0)	12.7 (322.6)	3.2 (82.5)	0.5 (12.7)	PA66HIRHSUV	Black	300
157-00405	WSR380	3/8 (M10)	120.0 (534.0)	15.7 (398.8)	4.1 (104.1)	0.5 (12.7)	PA66HIRHSUV	Black	300
157-00034	WSS8MM	5/16 (M8)	120.0 (534.0)	9.7 (246.4)	2.2 (57.1)	0.5 (12.7)	PA66HIRHSUV	Black	300

Dimensions are approximate and subject to technical changes. Use Part No. for ordering and Type for specification purposes. Installation tools: EVO9, EVO9HT, MK9P.

Bundling and Securing

Self-Affixing Cable Ties

Stud Mount Cable Ties

Wide Strap Heavy Duty Stud Mount Cable Ties

PART NO.	TYPE	Stud Dia. in. (mm)	Min. Tensile Strength lbs. (N)	Length (L) in. (mm)	Max. Bundle Diameter in. (mm)	Width (W) in. (mm)	Material	Color	Pkg. Qty.
157-00035	WSI8MM	5/16 (M8)	120.0 (534.0)	12.7 (322.6)	3.2 (82.5)	0.5 (12.7)	PA66HIRHSUV	Black	300
157-00036	WSR8MM	5/16 (M8)	120.0 (534.0)	15.7 (398.8)	4.1 (104.1)	0.5 (12.7)	PA66HIRHSUV	Black	300
157-00284	WSS10MM	7/16 (M10)	120.0 (534.0)	9.7 (246.4)	2.2 (57.1)	0.5 (12.7)	PA66HIRHSUV	Black	300
157-00285	WSI10MM	7/16 (M10)	120.0 (534.0)	12.7 (322.6)	3.2 (82.5)	0.5 (12.7)	PA66HIRHSUV	Black	300
157-00286	WSR10MM	7/16 (M10)	120.0 (534.0)	15.7 (398.8)	4.1 (104.1)	0.5 (12.7)	PA66HIRHSUV	Black	300

Dimensions are approximate and subject to technical changes. Use Part No. for ordering and Type for specification purposes.
Installation tools: EVO9, EVO9HT, MK9P.

Screw Mount Cable Ties

Screw Mount Ties

One-piece Screw Mount Cable Ties fasten with a screw or bolt to provide secure routing of cable bundles. Multiple configurations are available to cover a range of bundle sizes and tensile strengths.

Features and Benefits

- Screw mount style creates low insertion and high extraction force.
- Choose from several tensile strengths and lengths to accommodate a range of applications.

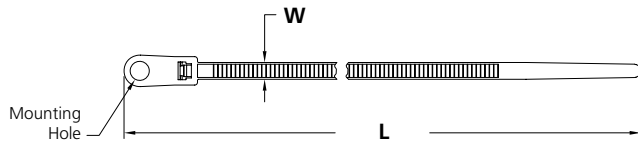

PART NO.	TYPE	Mounting Screw Type	Min. Tensile Strength lbs. (N)	Length (L) in. (mm)	Max. Bundle Diameter in. (mm)	Width in. (mm)	Material	Color	Pkg. Qty.
T18MR0C2*	T18MR	#4 (M2.5)	18.0 (80.0)	4.3 (110.0)	0.8 (20.0)	0.1 (2.5)	PA66HS	Black	100
T18MR0M4*		#4 (M2.5)	18.0 (80.0)	4.3 (110.0)	0.8 (20.0)	0.1 (2.5)	PA66	Black	1000
T18MR9C2*		#4 (M2.5)	18.0 (80.0)	4.3 (110.0)	0.8 (20.0)	0.1 (2.5)	PA66	Natural	100
T18MR9M4*		#4 (M2.5)	18.0 (80.0)	4.3 (110.0)	0.8 (20.0)	0.1 (2.5)	PA66	Natural	1000
T30MR0M4*	T30MR	#8 (M4)	30.0 (135.0)	6.3 (160.0)	1.3 (32.0)	0.1 (3.5)	PA66	Black	1000
T30MR9C2*		#8 (M4)	30.0 (135.0)	6.3 (160.0)	1.3 (32.0)	0.1 (3.5)	PA66	Natural	100
T30MR9M4*		#8 (M4)	30.0 (135.0)	6.3 (160.0)	1.3 (32.0)	0.1 (3.5)	PA66	Natural	1000
T30MR0C2*		#8 (M4)	30.0 (135.0)	6.3 (160.0)	1.3 (32.0)	0.1 (3.5)	PA66	Black	100
T50MI0C2	T50MI	#10 (M5)	50.0 (225.0)	12.4 (315.0)	3.4 (85.0)	0.2 (4.7)	PA66	Black	100
T50MI9C2		#10 (M5)	50.0 (225.0)	12.4 (315.0)	3.4 (85.0)	0.2 (4.7)	PA66	Natural	100
T50MI9M4		#10 (M5)	50.0 (225.0)	12.4 (315.0)	3.4 (85.0)	0.2 (4.7)	PA66	Natural	1000

Dimensions are approximate and subject to technical changes. Use Part No. for ordering and Type for specification purposes.
 Installation tools: EVO7, EVO7SP, EVO9, EVO9HT, MK7P, MK7HT, MK9P. *This product meets UL standards. Please see appendix for specific file numbers.



Please note! Not all products listed on this page may have this approval. Please check our website for latest approvals.

Bundling and Securing

Self-Affixing Cable Ties

Screw Mount Cable Ties

Screw Mount Ties

PART NO.	TYPE	Mounting Screw Type	Min. Tensile Strength lbs. (N)	Length (L) in. (mm)	Max. Bundle Diameter in. (mm)	Width in. (mm)	Material	Color	Pkg. Qty.
T50ML0C2*	T50ML	#10 (M5)	50.0 (225.0)	15.4 (390.0)	4.0 (100.0)	0.2 (4.7)	PA66	Black	100
T50ML0M4*		#10 (M5)	50.0 (225.0)	15.4 (390.0)	4.0 (100.0)	0.2 (4.7)	PA66	Black	1000
T50ML9M4*		#10 (M5)	50.0 (225.0)	15.4 (390.0)	4.0 (100.0)	0.2 (4.7)	PA66	Natural	1000
T50ML9C2*		#10 (M5)	50.0 (225.0)	15.4 (390.0)	4.0 (100.0)	0.2 (4.7)	PA66	Natural	100
T50MR0C2*	T50MR	#10 (M5)	50.0 (225.0)	8.5 (215.0)	1.8 (45.0)	0.2 (4.7)	PA66	Black	100
T50MR0M4*		#10 (M5)	50.0 (225.0)	8.5 (215.0)	1.8 (45.0)	0.2 (4.7)	PA66	Black	1000
T50MR9M4*		#10 (M5)	50.0 (225.0)	8.5 (215.0)	1.8 (45.0)	0.2 (4.7)	PA66	Natural	1000
T50MR9X2*		#10 (M5)	50.0 (225.0)	8.5 (215.0)	1.8 (45.0)	0.2 (4.7)	PA66	Natural	25
T50MR0HSM4*		#10 (M5)	50.0 (225.0)	8.5 (215.0)	1.8 (45.0)	0.2 (4.7)	PA66	Black	1000
T50MR9C2*		#10 (M5)	50.0 (225.0)	8.5 (215.0)	1.8 (45.0)	0.2 (4.7)	PA66	Natural	100
T120MR0K2*	T120MR	1/4" (M6)	120.0 (535.0)	15.6 (395.0)	4.0 (102.0)	0.3 (7.6)	PA66	Black	50
T120MR0UVK2		1/4" (M6)	120.0 (535.0)	15.6 (395.0)	4.0 (102.0)	0.3 (7.6)	PA66HIRHSUV	Black	50
T120MR9K2*		1/4" (M6)	120.0 (535.0)	15.6 (395.0)	4.0 (102.0)	0.3 (7.6)	PA66	Natural	50
T120MR9H4*		1/4" (M6)	120.0 (535.0)	15.6 (395.0)	4.0 (102.0)	0.3 (7.6)	PA66	Natural	500
T120MR0H4*		1/4" (M6)	120.0 (535.0)	15.6 (395.0)	4.0 (102.0)	0.3 (7.6)	PA66	Black	500

Dimensions are approximate and subject to technical changes. Use Part No. for ordering and Type for specification purposes.

Installation tools: EVO7, EVO7SP, EVO9, EVO9HT, MK7P, MK7HT, MK9P. *This product meets UL standards. Please see appendix for specific file numbers.



Please note! Not all products listed on this page may have this approval. Please check our website for latest approvals.

Screw Mount Cable Ties

Screw Mount Ties - Extra Strength

Screw Mount Cable Ties attach to existing holes using a screw or bolt to provide a fastening point to secure and route wire and cable bundles. Reinforced ribs between the screw mount and cable tie head provide additional strength for added bundle stability and security.

Features and Benefits

- Screw mount style creates low insertion and high extraction force.
- Unique design adds strength between the screw mount and cable tie head to keep bundles secure.

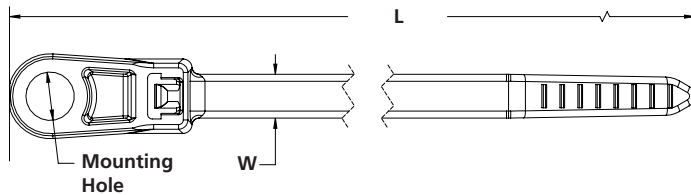

PART NO.	TYPE	Mounting Screw Type	Min. Tensile Strength lbs. (N)	Length (L) in. (mm)	Max. Bundle Diameter in. (mm)	Width in. (mm)	Material	Color	Pkg. Qty.
113-00060	T50MRX	1/4" (M6)	50.0 (225.0)	8.0 (211.0)	1.8 (45.0)	0.2 (4.7)	PA66HIRHSUV	Black	100
113-00061		1/4" (M6)	50.0 (255.0)	8.0 (211.0)	1.8 (45.0)	0.2 (4.7)	PA66HIRHSUV	Black	1000

Dimensions are approximate and subject to technical changes. Use Part No. for ordering and Type for specification purposes.
Installation tools: EVO7, EVO7SP, EVO9, EVO9HT, MK7P, MK7HT, MK9P.

Bundling and Securing

Self-Affixing Cable Ties

Edge Clip Cable Ties

1-Piece Cable Tie with Edge Clip

HellermannTyton's Cable Tie with Edge Clip is designed to route bundles by securing them to the edge of a plastic or metal sheet without the need for a mounting hole. The clip is easy to secure, and the extraction force is high due to the integrated metal clamp that holds the edge clip in place. This fastener is molded as a one-piece clip and tie combination.

Features and Benefits

- An all-in-one bundling and fastening solution that saves time and reduces costs.
- Ideal for mounting in a way that requires no holes or drilling.

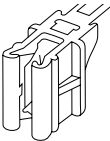
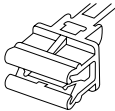
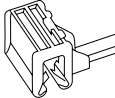

PART NO.	TYPE	Panel Thickness in. (mm)	Min. Tensile Strength lbs. (N)	Length (L) in. (mm)	Max. Bundle Diameter in. (mm)	Material	Color	Pkg. Qty.	Drawing
133-00059	T40XEC5SP-E	0.04 – 0.12 (1.0 – 3.0)	40.0 (178)	3.5 (85.0)	0.6 (15.0)	PA66HS	Black	500	
148-00200	T50SOSEC12E	0.04 – 0.12 (1.0 – 3.0)	40.0 (180)	6.0 (160.0)	1.40 (35.0)	PA66HS	Black	500	
126-00000	T50SOSEC13E	0.04 – 0.12 (1.0 – 3.0)	40.0 (180)	6.0 (160.0)	1.40 (35.0)	PA66HS	Black	500	
126-00036	T50SOSEC34E	0.04 – 0.12 (1.0 – 3.0)	40.0 (180)	6.0 (155.0)	1.40 (35.0)	PA66HS	Black	500	

Dimensions are approximate and subject to technical changes. Use Part No. for ordering and Type for specification purposes.
Installation tools: EVO7, EVO7SP, EVO9, EVO9HT, MK7P, MK7HT, MK9P.

Edge Clip Cable Ties

2-Piece Cable Tie with Edge Clip

HellermannTyton's Two Piece Edge Clip with Cable Tie Assemblies are designed specifically to route bundles by securing them to the edge of a plastic or metal sheet without the need for a mounting hole. The clip is easy to secure and the extraction force is high due to the integrated metal clamp that holds the edge clip in place.

Features and Benefits

- Edge Clip applies easily to plastic and metal sheets without the need for a mounting hole.
- Edge Clip provides low insertion force and high extraction force ideal for assembly environments.



PART NO.	TYPE	Panel Thickness in. (mm)	Min. Tensile Strength lbs. (N)	Length (L) in. (mm)	Max. Bundle Diameter in. (mm)	Material Cable Tie	Material Edge Clip	Color	Pkg. Qty.	Drawing
156-01601	CBT050R	0.04 – 0.12 (1.0 – 3.0)	50.0 (225)	8.0 (202)	1.9 (47.0)	PA66HS	PA66HIRHSUV	Black	500	
156-02230	T50REC4A	0.04 – 0.12 (1.0 – 3.0)	50.0 (225)	8.0 (202.0)	2.0 (50.0)	PA66HIRHSUV	PA66HIRHSUVR5	Black	100	
156-02231		0.04 – 0.12 (1.0 – 3.0)	50.0 (225)	8.0 (202.0)	2.0 (50.0)	PA66HIRHSUV	PA66HIRHSUVR5	Black	500	
156-00539		0.04 – 0.12 (1.0 – 3.0)	50.0 (225)	8.0 (202.0)	2.0 (50.0)	PA66HS	PA66HIRHSUV	Black	500	
156-00635		0.04 – 0.12 (1.0 – 3.0)	50.0 (225)	8.0 (202.0)	2.0 (50.0)	PA66UV	PA66HIRHSUV	Black	100	
156-00564		0.04 – 0.12 (1.0 – 3.0)	25.0 (110)	8.0 (202.0)	2.0 (50.0)	PP	PA66HIRHSUV	Black	500	
156-02228		0.04 – 0.12 (1.0 – 3.0)	50.0 (225)	8.0 (202.0)	2.0 (50.0)	PA66HIRHSUV	PA66HIRHSUVR5	Black	100	
156-02229	0.04 – 0.12 (1.0 – 3.0)	50.0 (225)	8.0 (202.0)	2.0 (50.0)	PA66HIRHSUV	PA66HIRHSUVR5	Black	500		
156-00538	T50REC4B	0.04 – 0.12 (1.0 – 3.0)	50.0 (225)	8.0 (202.0)	2.0 (50.0)	PA66HS	PA66HIRHSUV	Black	500	
156-00588	0.04 – 0.12 (1.0 – 3.0)	50.0 (225)	8.0 (202.0)	2.0 (50.0)	PA66UV	PA66HIRHSUV	Black	100		
156-00565	0.04 – 0.12 (1.0 – 3.0)	25.0 (110)	8.0 (202.0)	2.0 (50.0)	PP	PA66HIRHSUV	Black	500		

Dimensions are approximate and subject to technical changes. Use Part No. for ordering and Type for specification purposes.
Installation tools: EVO7, EVO7SP, EVO9, EVO9HT, MK7P, MK7HT, MK9P.

Bundling and Securing

Self-Affixing Cable Ties

Edge Clip Cable Ties

Cable Tie with Edge Clip

PART NO.	TYPE	Panel Thickness in. (mm)	Min. Tensile Strength lbs. (N)	Length (L) in. (mm)	Max. Bundle Diameter in. (mm)	Material Cable Tie	Material Edge Clip	Color	Pkg. Qty.	Drawing
156-02226	T50REC5A	0.04 – 0.12 (1.0 – 3.0)	50.0 (225)	8.0 (202.0)	2.0 (50.0)	PA66HIRHSUV	PA66HIRHSUVR5	Black	100	
156-02227		0.04 – 0.12 (1.0 – 3.0)	50.0 (225)	8.0 (202.0)	2.0 (50.0)	PA66HIRHSUV	PA66HIRHSUVR5	Black	500	
156-00541		0.04 – 0.12 (1.0 – 3.0)	50.0 (225)	8.0 (202.0)	2.0 (50.0)	PA66HS	PA66HIRHSUV	Black	500	
156-00589		0.04 – 0.12 (1.0 – 3.0)	50.0 (225)	8.0 (202.0)	2.0 (50.0)	PA66UV	PA66HIRHSUV	Black	100	
156-02224	T50REC5B	0.04 – 0.12 (1.0 – 3.0)	50.0 (225)	8.0 (202.0)	2.0 (50.0)	PA66HIRHSUV	PA66HIRHSUVR5	Black	100	
156-02225		0.04 – 0.12 (1.0 – 3.0)	50.0 (225)	8.0 (202.0)	2.0 (50.0)	PA66HIRHSUV	PA66HIRHSUVR5	Black	500	
156-00540		0.04 – 0.12 (1.0 – 3.0)	50.0 (225)	8.0 (202.0)	2.0 (50.0)	PA66HS	PA66HIRHSUV	Black	500	
156-00468		0.04 – 0.12 (1.0 – 3.0)	50.0 (225)	8.0 (202.0)	2.0 (50.0)	PA66UV	PA66HIRHSUV	Black	100	
156-00551	T50REC9SD	0.04 – 0.12 (1.0 – 3.0)	50.0 (225)	8.0 (202.0)	2.0 (50.0)	PA66HS	PA66HIRHSUV	Black	500	
156-00537	T50REC19	0.12 – 0.24 (3.0 – 6.0)	50.0 (225)	8.0 (202.0)	2.0 (50.0)	PA66HS	PA66HIRHSUV	Black	500	
156-00590		0.12 – 0.24 (3.0 – 6.0)	50.0 (225)	8.0 (202.0)	2.0 (50.0)	PA66UV	PA66HIRHSUV	Black	100	
156-00555	T50REC20	0.12 – 0.24 (3.0 – 6.0)	50.0 (225)	8.0 (202.0)	2.0 (50.0)	PA66HS	PA66HIRHSUV	Black	500	
156-00591		0.12 – 0.24 (3.0 – 6.0)	50.0 (225)	8.0 (202.0)	2.0 (50.0)	PA66UV	PA66HIRHSUV	Black	100	
156-00561		0.12 – 0.24 (3.0 – 6.0)	50.0 (225)	8.0 (202.0)	2.0 (50.0)	PP	PA66HIRHSUV	Black	500	
156-00553	T50REC21	0.04 – 0.12 (1.0 – 3.0)	50.0 (225)	8.0 (202.0)	2.0 (45.0)	PA66HS	PA66HIRHSUV	Black	500	
156-00554	T50REC22	0.04 – 0.12 (1.0 – 3.0)	50.0 (225)	8.0 (202.0)	2.0 (45.0)	PA66HS	PA66HIRHSUV	Black	500	

Dimensions are approximate and subject to technical changes. Use Part No. for ordering and Type for specification purposes.
Installation tools: EVO7, EVO7SP, EVO9, EVO9HT, MK7P, MK7HT, MK9P.

Edge Clip Cable Ties

Cable Tie with Edge Clip

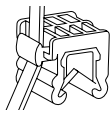
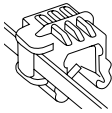
PART NO.	TYPE	Panel Thickness in. (mm)	Min. Tensile Strength lbs. (N)	Length (L) in. (mm)	Max. Bundle Diameter in. (mm)	Material Cable Tie	Material Edge Clip	Color	Pkg. Qty.	Drawing
156-00556	T50REC23	0.12 – 0.24 (3.0 – 6.0)	50.0 (225)	8.0 (202.0)	2.0 (50.0)	PA66HS	PA66HIRHSUV	Black	500	
156-00592		0.12 – 0.24 (3.0 – 6.0)	50.0 (225)	8.0 (202.0)	2.0 (50.0)	PA66UV	PA66HIRHSUV	Black	100	
156-01162		0.12 – 0.24 (3.0 – 6.0)	50.0 (225)	8.0 (202.0)	2.0 (45.0)	PA66UV	PA66HIRHSUV	Black	500	
156-00567		0.12 – 0.24 (3.0 – 6.0)	50.0 (225)	8.0 (202.0)	2.0 (50.0)	PP	PA66HIRHSUV	Black	500	
156-00593	T50REC24	0.12 – 0.24 (3.0 – 6.0)	50.0 (225)	8.0 (202.0)	2.0 (50.0)	PA66UV	PA66HIRHSUV	Black	100	
156-00557		0.12 – 0.24 (3.0 – 6.0)	50.0 (225)	8.0 (202.0)	2.0 (50.0)	PA66UV	PA66HIRHSUV	Black	500	

Dimensions are approximate and subject to technical changes. Use Part No. for ordering and Type for specification purposes.
 Installation tools: EVO7, EVO7SP, EVO9, EVO9HT, MK7P, MK7HT, MK9P.

Bundling and Securing

Self-Affixing Cable Ties

Edge Clip Cable Ties

Outside Serrated Cable Tie with Edge Clip

HellermannTyton's Two Piece Edge Clip with Cable Tie Assemblies are designed specifically to route bundles by securing them to the edge of a plastic or metal sheet without the need for a mounting hole. The clip is easy to secure and the extraction force is high due to the integrated metal clamp that holds the edge clip in place.

Features and Benefits

- Edge Clip applies easily to plastic and metal sheets without the need for a mounting hole.
- Edge Clip provides low insertion force and high extraction force ideal for assembly environments.
- Two piece assembly allows the mount to slide along the strap ensuring proper orientation.
- Cable tie is outside serrated to reduce bundle chafing.



PART NO.	TYPE	Panel Thickness in. (mm)	Min. Tensile Strength lbs. (N)	Length (L) in. (mm)	Max. Bundle Diameter in. (mm)	Material Cable Tie	Material Edge Clip	Color	Pkg. Qty.	Drawing
156-01797	T30ROSEC0.5-2.5SP-SVA	0.01 – 0.10 (0.5 – 2.5)	30.0 (133.0)	5.7 (145.0)	1.4 (35.0)	PA66HS	PA66HIRHS	Black	500	
156-01546	T30ROSEC0.5-2.5SP-SVB	0.01 – 0.10 (0.5 – 2.5)	30.0 (135.0)	5.7 (145.0)	1.4 (35.0)	PA66HS	PA66HIRHS	Black	500	
156-00858	T50SOSEC4A	0.04 – 0.12 (1.0 – 3.0)	50.0 (225.0)	6.0 (150.0)	1.4 (35.0)	PA66HS	PA66HIRHS	Black	500	
156-00860	T50ROSEC4A	0.04 – 0.12 (1.0 – 3.0)	50.0 (225.0)	8.0 (202.0)	2.0 (50.0)	PA66HS	PA66HIRHS	Black	500	
156-00859	T50SOSEC4B	0.04 – 0.12 (1.0 – 3.0)	50.0 (225.0)	6.0 (150.0)	1.4 (35.0)	PA66HS	PA66HIRHS	Black	500	
156-00861	T50ROSEC4B	0.04 – 0.12 (1.0 – 3.0)	50.0 (225.0)	8.0 (202.0)	2.0 (50.0)	PA66HS	PA66HIRHS	Black	500	
156-00865	T50SOSEC5A	0.04 – 0.12 (1.0 – 3.0)	50.0 (225.0)	6.0 (150.0)	1.4 (35.0)	PA66HS	PA66HIRHS	Black	500	
156-00864	T50ROSEC5A	0.04 – 0.12 (1.0 – 3.0)	50.0 (225.0)	8.0 (202.0)	2.0 (50.0)	PA66HS	PA66HIRHS	Black	500	
156-00863	T50SOSEC5B	0.04 – 0.12 (1.0 – 3.0)	50.0 (225.0)	6.0 (150.0)	1.4 (35.0)	PA66HS	PA66HIRHS	Black	500	

Dimensions are approximate and subject to technical changes. Use Part No. for ordering and Type for specification purposes.
Installation tools: EVO7, EVO7SP, EVO9, EVO9HT, MK7P, MK7HT, MK9P.

Edge Clip Cable Ties

Outside Serrated Cable Tie with Edge Clip

PART NO.	TYPE	Panel Thickness in. (mm)	Min. Tensile Strength lbs. (N)	Length (L) in. (mm)	Max. Bundle Diameter in. (mm)	Material Cable Tie	Material Edge Clip	Color	Pkg. Qty.	Drawing
156-00862	T50ROSEC5B	0.04 – 0.12 (1.0 – 3.0)	50.0 (225.0)	8.0 (202.0)	2.0 (50.0)	PA66HS	PA66HIRHS	Black	500	
156-00866	T50SOSEC9SD	0.04 – 0.12 (1.0 – 3.0)	50.0 (225.0)	6.0 (150.0)	1.4 (31.0)	PA66HS	PA66HIRHS	Black	500	
156-00867	T50ROSEC9	0.04 – 0.12 (1.0 – 3.0)	50.0 (225.0)	8.0 (200.0)	2.0 (45.0)	PA66HS	PA66HIRHS	Black	500	
156-00870	T50SOSEC10	0.04 – 0.12 (1.0 – 3.0)	50.0 (225.0)	6.0 (150.0)	1.4 (31.0)	PA66HS	PA66HIRHS	Black	500	
156-00871	T50ROSEC10	0.04 – 0.12 (1.0 – 3.0)	50.0 (225.0)	8.0 (200.0)	2.0 (45.0)	PA66HS	PA66HIRHS	Black	500	
156-04601	T50SOSEC19	0.12 – 0.24 (3.0 – 6.0)	50.0 (225.0)	6.0 (150.0)	1.4 (35.0)	PA66HS	PA66HIRHS	Black	500	
156-00872	T50ROSEC19	0.12 – 0.24 (3.0 – 6.0)	50.0 (225.0)	8.0 (200.0)	2.0 (45.0)	PA66HS	PA66HIRHS	Black	500	
156-00016	T50SOSEC20	0.12 – 0.24 (3.0 – 6.0)	50.0 (225.0)	6.0 (150.0)	1.4 (35.0)	PA66HS	PA66HIRHS	Black	500	
156-00873	T50ROSEC20	0.12 – 0.24 (3.0 – 6.0)	50.0 (225.0)	8.0 (200.0)	2.0 (45.0)	PA66HS	PA66HIRHS	Black	500	
156-00017	T50SOSEC21	0.04 – 0.12 (1.0 – 3.0)	50.0 (225.0)	6.0 (150.0)	1.4 (35.0)	PA66HS	PA66HIRHS	Black	500	
156-00874	T50ROSEC21	0.04 – 0.12 (1.0 – 3.0)	50.0 (225.0)	8.0 (200.0)	2.0 (45.0)	PA66HS	PA66HIRHS	Black	500	
156-00875	T50SOSEC22	0.04 – 0.12 (1.0 – 3.0)	50.0 (225.0)	6.0 (150.0)	1.4 (35.0)	PA66HS	PA66HIRHS	Black	500	
156-00876	T50ROSEC22	0.04 – 0.12 (1.0 – 3.0)	50.0 (225.0)	8.0 (200.0)	2.0 (45.0)	PA66HS	PA66HIRHS	Black	500	
156-00877	T50ROSEC23	0.12 – 0.24 (3.0 – 6.0)	50.0 (225.0)	8.0 (200.0)	2.0 (45.0)	PA66HS	PA66HIRHS	Black	500	
156-00878	T50ROSEC24	0.12 – 0.24 (3.0 – 6.0)	50.0 (225.0)	8.0 (200.0)	2.0 (45.0)	PA66HS	PA66HIRHS	Black	500	

Dimensions are approximate and subject to technical changes. Use Part No. for ordering and Type for specification purposes.
Installation tools: EVO7, EVO7SP, EVO9, EVO9HT, MK7P, MK7HT, MK9P.

Bundling and Securing

Self-Affixing Cable Ties

Button Head Cable Ties

Button Head Ties

HellermannTyton's Button Head Tie is a two-piece tie designed for parallel entry and exit through the head. The strap is inserted through a panel hole, the bundle is put in position beneath the hole, and the strap is looped and reinserted up through the panel hole and the tie head. Since the strap is serrated on both sides, the installer can loop it either way.

Features and Benefits

- Excellent bundle fastening method for through-the-hole applications.
- Ribs add stability on the bottom of the head.
- Serrations and wedge shape combine to provide optimal strength when strap serrations are seated in the head.
- Low-profile head is unobtrusive.

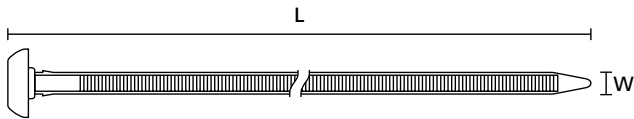

PART NO.	TYPE	Max. Bundle Diameter in. (mm)	Min. Tensile Strength lbs. (N)	Length (L) in. (mm)	Width (W) in. (mm)	Material	Color	Pkg. Qty.
132-00033	BT105R	2.6 (66.7)	105.0 (467.0)	9.6 (244.4)	0.2 (5.6)	PA66HIRHSUV	Black	2000
132-00035	BT130RDP	2.9 (73.0)	130.0 (578.0)	10.5 (267.0)	0.3 (7.6)	PA66HIRHSUV	Black	2000
132-00032	BT105L	4.3 (110.0)	105.0 (467.0)	15.0 (381.5)	0.2 (5.6)	PA66HIRHSUV	Black	2000
132-00034	BT130LDP	4.3 (110.0)	130.0 (578.0)	15.0 (381.5)	0.3 (7.6)	PA66HIRHSUV	Black	2000

Dimensions are approximate and subject to technical changes. Use Part No. for ordering and Type for specification purposes.
Installation tools: EVO9, EVO9HT, MK9P.

Button Head Cable Ties

Button Mount with Cable Tie

This Button Mount with Cable Tie is used to secure cables and wire bundles on solar modules. The mount conveniently fits existing holes in most solar modules with zero insertion force. Made from impact-modified, heat-resistant, UV stabilized Polyamide 6.6 material, it is specifically formulated for extreme environments. The mount is designed to withstand movement, particularly on single-axis tracker systems, for years of dependable performance.

Features and Benefits

- Capable of holding several cables, depending on cable tie size, for ultimate flexibility.
- Withstands tracker movement to prevent chafing of wires.
- Zero-insertion-force design requires no tools for quick and easy mounting to most solar modules.
- High impact modified, heat-resistant, UV stabilized material is ideal for long-term performance in extreme weather.

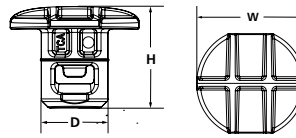
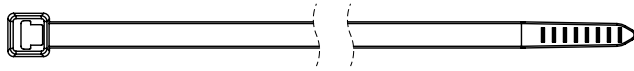

PART NO.	TYPE	Cable Tie Series	Mounting Hole Dia. (D) in. (mm)	Max. Panel Thickness in. (mm)	Max. Bundle Diameter in. (mm)	Width (W) in. (mm)	Height (H) in. (mm)	Material	Color	Pkg. Qty.
156-02512	T50RPBM9SET	T50R	0.35 x 0.47, 0.35 x 0.55 (9.0 x 12.0), (9.0 x 14.0)	0.12 (3.0)	2.0 (50.0)	0.7 (17.0)	0.5 (13.4)	PA66HIRHSUV	Black	500
156-02513		T50R	0.35 x 0.47, 0.35 x 0.55 (9.0 x 12.0), (9.0 x 14.0)	0.12 (3.0)	2.0 (50.0)	0.7 (17.0)	0.5 (13.4)	PA66HIRHSUV	Black	1000

Dimensions are approximate and subject to technical changes. Use Part No. for ordering and Type for specification purposes.
Installation tools: EVO9, EVO9HT, MK9P.

Bundling and Securing

Self-Affixing Cable Ties

Blind Hole Mount Cable Ties

Blind Hole Mount Cable Ties for Threaded Holes

HellermannTyton Blind Hole Mount Cable Tie for Threaded Holes offers an easy-to-use method for bundling and affixing cables. The one-piece mount offers a low insertion force and aggressively resists pull off, for secure attachment to panels with thicknesses from 0.02" to 0.28" or threaded blind holes. The disc on top of the mount covers the hole and minimizes ingress of water and debris.

Features and Benefits

- One-piece design allows installers to mount and bundle wire or cables single-handedly.
- Fastener delivers high extraction force for reliable performance, yet it's easy to install.
- Can be unscrewed or extracted from threaded holes for easy removal.

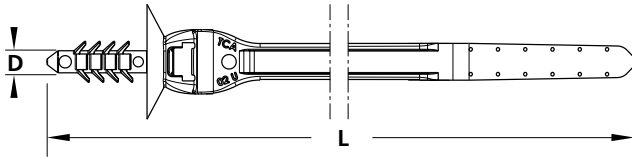

PART NO.	TYPE	Diameter (D) in. (mm)	Panel Thickness in. (mm)	Min. Bundle Diameter in. (mm)	Max. Bundle Diameter in. (mm)	Length (L) in. (mm)	Min. Tensile Strength lbs. (N)	Material	Color	Pkg. Qty.
157-00144	T50ROSFTQM6	0.3 (6.0)	0.02 – 0.28 (0.6 – 7.0)	0.1 (1.6)	2.0 (50.0)	8.0 (203.6)	50.0 (222.0)	PA46	Brown	500
157-00163		0.3 (6.0)	0.02 – 0.28 (0.6 – 7.0)	0.1 (1.6)	2.0 (50.0)	8.0 (203.6)	50.0 (222.0)	PA66HIRHS	Gray	500
157-00112		0.3 (6.0)	0.02 – 0.28 (0.6 – 7.0)	0.1 (1.6)	2.0 (50.0)	8.0 (203.6)	50.0 (222.0)	PA66HIRHSUV	Black	500

Dimensions are approximate and subject to technical changes. Use Part No. for ordering and Type for specification purposes.
Installation tools: EVO9, MK9HT, MK9P.

Blind Hole Mount Cable Ties

2-Piece Cable Tie and Blind Hole Mount Assemblies

HellermannTyton Blind Hole Mount Cable Ties for threaded and nonthreaded holes offer an easy-to-use method for bundling and affixing cables. The two-piece design includes a heat stabilized cable tie and formula-matched, 1/4" mount that features a low insertion force and aggressively resists pull off. Performs equally well in threaded or nonthreaded blind holes. Mount can slide along cable tie to adjust orientation if needed. Fastener can be removed from hole using a hex driver. This ensures fastener can be reused.

Features and Benefits

- Delivers high extraction force for reliable performance, yet it's easy to install.
- Reusable fastener can be removed from threaded or nonthreaded holes using a 5/16" hex driver.
- Heat stabilized material provides excellent resistance to high temperatures.



Outside Serrated

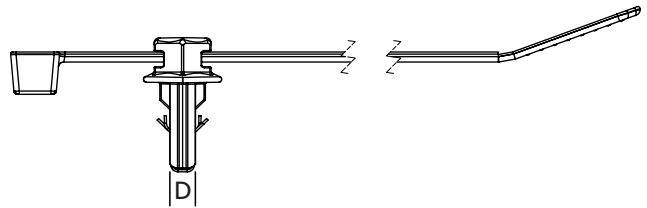
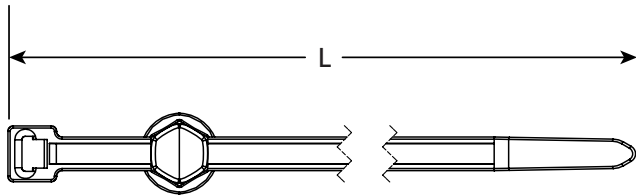
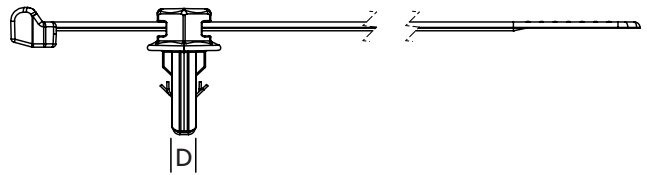
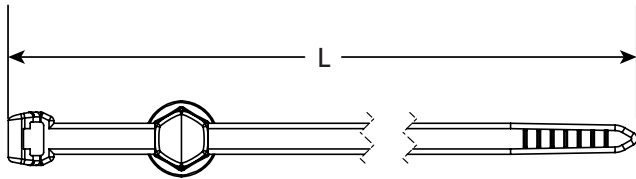

Inside Serrated

PART NO.	TYPE	Diameter (D) in. (mm)	Min. Bundle Diameter in. (mm)	Max. Bundle Diameter in. (mm)	Length (L) in. (mm)	Min. Tensile Strength lbs. (N)	Material Cable Tie	Color	Pkg. Qty.
156-01807	T50SOSBHMB	0.3 (6.0)	0.1 (2.5)	1.4 (35.0)	6.0 (150.0)	50.0 (225.0)	PA66HS	Black	500
156-01726	T50RBHMB	0.3 (6.0)	0.1 (2.5)	2.0 (50.0)	8.0 (200.0)	50.0 (225.0)	PA66HS	Black	500
156-01796	T50ROSBHMB	0.3 (6.0)	0.1 (2.5)	2.0 (50.0)	8.0 (200.0)	50.0 (225.0)	PA66HS	Black	500

Dimensions are approximate and subject to technical changes. Use Part No. for ordering and Type for specification purposes.
Installation tools: EVO9, MK9HT, MK9P.

Bundling and Securing

Self-Affixing Cable Ties

Blind Hole Mount Cable Ties

Offset Cable Tie and Blind Hole Mount Assembly

Blind Hole Mount Offset Cable Ties secure bundles beside the mounting hole instead of directly above it. The unique design includes a heat stabilized cable tie and formula-matched, hex-head fastener that features a low insertion force and aggressively resists pull off. Performs equally well in threaded or non-threaded blind holes. Since cable or wire bundle is beside the fastener, the assembly can be removed using a hex driver from the mounting hole without cutting the cable tie. The fastener can then be reused.

Features and Benefits

- Offset mount allows wire or cable to be attached beside mounting hole instead of directly above it.
- Reusable fastener can be extracted from threaded or nonthreaded holes using a 5/16" hex driver.
- Delivers high extraction force for reliable performance, yet it's easy to install.
- Heat stabilized material provides excellent resistance to high temperatures.

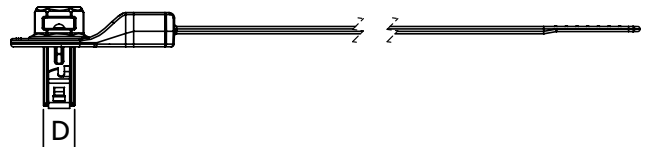
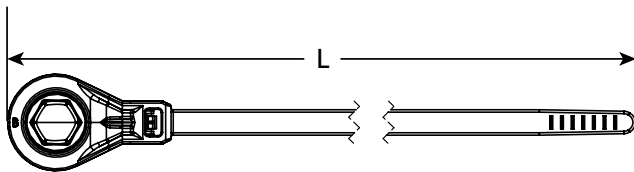

PART NO.	TYPE	Offset Length in. (mm)	Diameter (D) in. (mm)	Min. Bundle Diameter in. (mm)	Max. Bundle Diameter in. (mm)	Length (L) in. (mm)	Min. Tensile Strength lbs. (N)	Material	Color	Pkg. Qty.
157-00329	T50ROS BH MBSO18	0.7 (18.0)	0.3 (6.0)	0.1 (2.0)	2.0 (50.0)	8.0 (200.0)	50.0 (225.0)	PA66HS	Black	500

Dimensions are approximate and subject to technical changes. Use Part No. for ordering and Type for specification purposes.
Installation tools: EVO9, MK9HT, MK9P.

Dual Clamp Ties

Dual Clamp Ties

HellermannTyton's Dual-Clamp Ties are designed to provide parallel separation between hoses, wires, cables, and tubing to protect them from abrasion. These ties have an optional mounting hole for securing bundles along the chassis of trucks, trailers, and heavy duty equipment. The unique one-piece design features the dual head centered on the strap.

Features and Benefits

- Provides dual separation between bundles to prevent abrasion.
- High tensile strength delivers reliable performance for heavy duty applications.
- Wide strap is designed to minimize pinching of soft hoses and convoluted tubing.

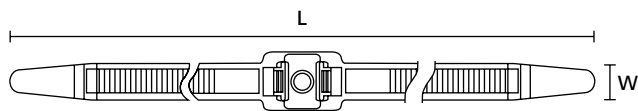

PART NO.	TYPE	Stud Dia. in. (mm)	Min. Tensile Strength lbs. (N)	Length (L) in. (mm)	Max. Bundle Diameter in. (mm)	Width (W) in. (mm)	Material	Color	Pkg. Qty.
DCT90HIRK2	DCT9	1/4 (M6)	150.0 (667.0)	13.0 (330.2)	1.3 (33.0)	0.5 (12.7)	PA66HIRHSUV	Black	50
DCT90HIRH1		1/4 (M6)	150.0 (667.0)	13.0 (330.2)	1.3 (33.0)	0.5 (12.7)	PA66HIRHSUV	Black	50
DCT90HIRC2		1/4 (M6)	150.0 (667.0)	13.0 (331.0)	1.3 (33.0)	0.5 (12.7)	PA66HIRHS	Black	100
DCT110HIRK2	DCT11	1/4 (M6)	150.0 (667.0)	19.2 (487.7)	2.3 (58.0)	0.5 (12.7)	PA66HIRHSUV	Black	50
DCT110HIRH1		1/4 (M6)	150.0 (667.0)	19.2 (487.7)	2.3 (58.0)	0.5 (12.7)	PA66HIRHSUV	Black	500
DCT110HIRC2		1/4 (M6)	150.0 (667.0)	19.2 (487.7)	2.3 (58.0)	0.5 (12.7)	PA66HIRHSUV	Black	100

Dimensions are approximate and subject to technical changes. Use Part No. for ordering and Type for specification purposes.
Installation tools: EVO9, EVO9HT, MK9P.

Bundling and Securing

Bundle Separators

Dual Clamp Ties

Stand Off Mounting Dual Clamp Tie

HellermannTyton's Stand Off Dual Clamp Ties offer the same features as the standard dual clamp tie, with a standoff mount that secures the bundle away from the surface. This protects the bundles from bolts and other protrusions.

Features and Benefits

- Wide strap minimizes pinching of soft hoses and convoluted tubing.
- Locking stud mount pawls allow for easy hand insertion.
- Nut or weld nesting counterbore provides flush mounting at the base.

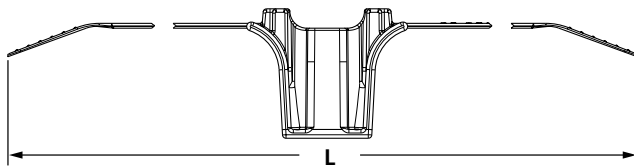

PART NO.	TYPE	Stud Dia. in. (mm)	Min. Tensile Strength lbs. (N)	Length (L) in. (mm)	Max. Bundle Diameter in. (mm)	Width in. (mm)	Material	Color	Pkg. Qty.
117-00012	SDCTR312	5/16 (M8)	100.0 (445.0)	20.1 (510.5)	2.3 (58.4)	0.5 (12.7)	PA66HIRHSUV	Black	250
157-00060	SDCTL	5/16 (M8)	100.0 (445.0)	26.1 (663.0)	3.4 (86.4)	0.5 (12.7)	PA66HIRHSUV	Black	250

Dimensions are approximate and subject to technical changes. Use Part No. for ordering and Type for specification purposes.
Installation tools: EVO9, EVO9HT, MK9P.

Dual Swivel Saddle Spacers

DSWS4 Series

These saddle spacers are installed between two bundles (such as wires, cables, hoses, tubing, conduit, etc.) to separate and prevent chafing and wear. The mounts can be easily rotated by hand, allowing the bundles to be crossed and rotated at any angle. Cable ties, which secure the bundles, are used with the mounts. The dual swivel saddle spacers accommodate cable ties up to 1/2" wide.

Features and Benefits

- H-profile of the saddles allows for broad surface contact with the bundle, which minimizes pinching and crushing of the bundle.
- Swivels in 360-degree motion to accommodate any area.
- Accommodates T50–T250 ties to handle both light-duty and heavy-duty applications.

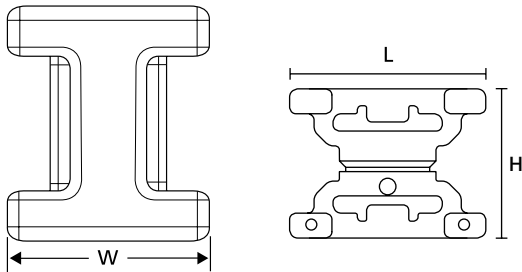

PART NO.	TYPE	Cable Tie Series	Min. Bundle Diameter in. (mm)	Max. Bundle Diameter in. (mm)	Min. Extraction Force lbs. (N)	Length (L) in. (mm)	Width (W) in. (mm)	Height (H) in. (mm)	Material	Color	Pkg. Qty.
151-00644	DSWS4	T50 - T250	0.3 (6.0)	3.0 (76.0)	100.0 (445.0)	0.9 (23.6)	0.8 (20.3)	0.7 (18.0)	PA66HS, POM	Black	50
151-06500		T50 - T250	0.3 (6.0)	3.0 (76.0)	100.0 (445.0)	0.9 (23.6)	0.8 (20.3)	0.7 (18.0)	PA66HS, POM	Black	2200

Dimensions are approximate and subject to technical changes. Use Part No. for ordering and Type for specification purposes.

Bundling and Securing

Bundle Separators

Dual Swivel Saddle Spacers

DSWS5 Series

These saddle spacers are installed between two bundles (such as wires, cables, hoses, tubing, conduit, etc.) to separate and prevent chafing and wear. The mounts can be easily rotated by hand, allowing the bundles to be crossed and rotated at any angle. Cable ties, which secure the bundles, are used with the mounts. The dual swivel saddle spacers accommodate cable ties up to 1/2" wide.

Features and Benefits

- H-profile of the saddles allows for broad surface contact with the bundle, which minimizes pinching and crushing of the bundle.
- Swivels in 360-degree motion to accommodate any area.
- Accommodates T50–T250 ties to handle both light-duty and heavy-duty applications.

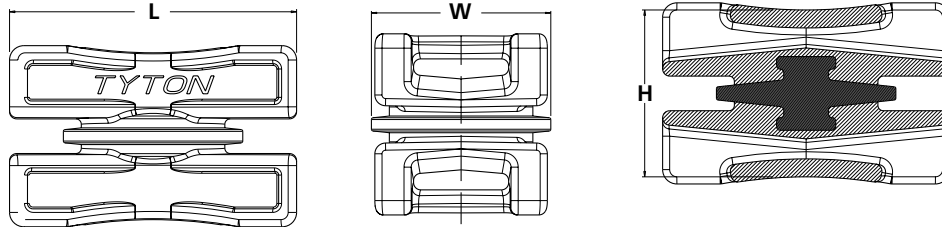

PART NO.	TYPE	Cable Tie Series	Min. Bundle Diameter in. (mm)	Max. Bundle Diameter in. (mm)	Min. Extraction Force lbs. (N)	Length (L) in. (mm)	Width (W) in. (mm)	Height (H) in. (mm)	Material	Color	Pkg. Qty.
DSWS50HSH1	DSWS5	T50 - T250	0.7 (16.0)	6.0 (152.0)	250.0 (1,112.0)	1.6 (40.6)	1.0 (25.4)	0.9 (23.6)	PA66HS, POM	Black	500
DSWS50HSHK2		T50 - T250	0.7 (16.0)	6.0 (152.0)	250.0 (1,112.0)	1.6 (40.6)	1.0 (25.4)	0.9 (23.6)	PA66HS, POM	Black	50

Dimensions are approximate and subject to technical changes. Use Part No. for ordering and Type for specification purposes.

Bundle Separation Clamps







HC Clamp Bundle Separators

HC Clamps separate multiple bundles and secure them to brackets or frame rails. Each mount has two pawls for easy pre-installation on a threaded fastener prior to securing with a mechanical fastener. HC Clamps have ribs, making them ideal for convoluted tubing.

Features and Benefits

- Separates and secures bundles avoiding abrasion.
- Comes in a variety of sizes and colors to be easily identified.



PART NO.	TYPE	Bundle Diameter Max. 1st Hole in. (mm)	Bundle Diameter Max. 2nd Hole in. (mm)	Bundle Diameter Max. 3rd Hole in. (mm)	Length (L) in. (mm)	Width (W) in. (mm)	Height (H) in. (mm)	Material	Color	Pkg. Qty.	
133-00993	HC2A	1.0 (24.4)	1.0 (24.4)	-	2.7 (67.8)	1.1 (27.9)	1.38 (34.94)	PA66HIRHSGF	Black	500	
133-00994	HC2B	0.7 (17.4)	0.7 (17.4)	-	2.7 (67.8)	1.1 (27.9)	1.38 (34.94)	PA66HIRHSGF	Green	500	
133-00995	HC2C	0.7 (17.4)	1.0 (24.4)	-	2.7 (67.8)	1.1 (27.9)	1.38 (34.94)	PA66HIRHSGF	Blue	500	
133-00996	HC2D	0.7 (16.5)	1.0 (24.4)	-	2.7 (67.8)	1.1 (27.9)	1.38 (34.94)	PA66HIRHSGF	Natural	500	
133-00997	HC2E	0.5 (13.0)	0.5 (13.0)	-	2.7 (67.8)	1.1 (27.9)	1.38 (34.94)	PA66HIRHSGF	Red	500	
133-00998	HC3A	1.0 (24.4)	1.0 (24.4)	1.0 (24.4)	4.2 (107.9)	1.1 (27.9)	1.38 (34.94)	PA66HIRHSGF	Black	500	

Dimensions are approximate and subject to technical changes. Use Part No. for ordering and Type for specification purposes.

Bundling and Securing

Bundle Separators

Bundle Separation Clamps

Heavy Duty Hinge Clamps

These clamps separate multiple bundles and secure them to any surface with a 6.8 mm stud or bolt. The one-piece hinged design snaps together to keep bundles such as tubing or battery cables separated. The mounting hole features two pawls for easy preinstallation on a threaded fastener prior to securing with a mechanical fastener.

Features and Benefits

- High-heat material can be used near engines and other sources of heat.
- Hinged design keeps two halves together and simplifies assembly.
- Secures with a single bolt or stud, providing quick installation.

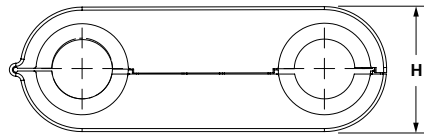
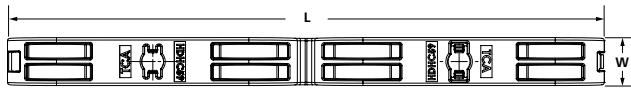

PART NO.	TYPE	Max. Bundle Diameter in. (mm)	Mounting Hole Dia. in. (mm)	Length (L) in. (mm)	Width (W) in. (mm)	Height (H) in. (mm)	Material	Color	Pkg. Qty.
151-01231	HDHC59	0.6 (15.0)	0.3 (6.8)	7.3 (186.0)	0.6 (14.5)	1.22 (30.9)	PA46	Black	250

Dimensions are approximate and subject to technical changes. Use Part No. for ordering and Type for specification purposes.

Adhesive Mounting Bases

Cable Tie Mounting Bases - Rubber Adhesive

HellermannTyton Adhesive Cable Tie Mounting Bases are used with T18 through T150 Series cable ties to provide stability when securing bundles. The mounts are installed using the adhesive backing and/or by securing two or four screws. The 4-way opening allows the cable ties to be inserted parallel or perpendicular to the wire bundles. Rubber-based adhesive allows for a permanent bond to most surfaces.

Features and Benefits

- Durable adhesive achieves high pull-off force and is unaffected by vibration.
- 4-way opening allows cable ties to be installed parallel or perpendicular to bundles.
- Pre-drilled holes extend mounting options and security.
- Extended adhesive liner is easy to remove quickly.

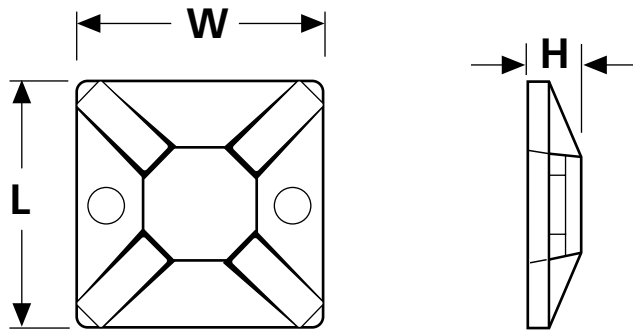

PART NO.	TYPE	Cable Tie Series	Length (L) in. (mm)	Width (W) in. (mm)	Height (H) in. (mm)	Material	Color	Pkg. Qty.
MB2.5A0C2	MB2.5A	T18	0.6 (15.9)	0.6 (15.9)	0.2 (4.1)	PA66	Black	100
MB2.5A10C2		T18	0.6 (15.9)	0.6 (15.9)	0.2 (4.1)	PA66	White	100
MB2.5A0M4		T18	0.6 (15.9)	0.6 (15.9)	0.2 (4.1)	PA66	Black	1000
MB2.5A10M4		T18	0.6 (15.9)	0.6 (15.9)	0.2 (4.1)	PA66	White	1000
MB3A0C2	MB3A	T18 - T30	0.8 (19.0)	0.8 (19.0)	0.2 (4.6)	PA66	Black	100
MB3A10C2		T18 - T30	0.8 (19.0)	0.8 (19.0)	0.2 (4.6)	PA66	White	100
MB3A0M4		T18 - T30	0.8 (19.0)	0.8 (19.0)	0.2 (4.6)	PA66	Black	1000
MB3A10M4		T18 - T30	0.8 (19.0)	0.8 (19.0)	0.2 (4.6)	PA66	White	1000
MB4A0C2	MB4A	T18 - T50	1.1 (28.5)	1.1 (28.5)	0.2 (5.6)	PA66	Black	100
MB4A10C2		T18 - T50	1.1 (28.5)	1.1 (28.5)	0.2 (5.6)	PA66	White	100
MB4A0H4		T18 - T50	1.1 (28.5)	1.1 (28.5)	0.2 (5.6)	PA66	Black	500
MB4A10H4		T18 - T50	1.1 (28.5)	1.1 (28.5)	0.2 (5.6)	PA66	White	500

Dimensions are approximate and subject to technical changes. Use Part No. for ordering and Type for specification purposes.

*This product meets UL standards. Please see appendix for specific file numbers.

Bundling and Securing

Cable Tie Mounts

Adhesive Mounting Bases

Cable Tie Mounting Bases - Rubber Adhesive

PART NO.	TYPE	Cable Tie Series	Length (L) in. (mm)	Width (W) in. (mm)	Height (H) in. (mm)	Material	Color	Pkg. Qty.
MB4SHA0C2	MB4SHA	T18 - T50	1.1 (28.3)	1.1 (28.3)	0.2 (5.8)	PA66	Black	100
MB4SHA0H4		T18 - T50	1.1 (28.3)	1.1 (28.3)	0.2 (5.8)	PA66	Black	500
MB4SHA10H4		T18 - T50	1.1 (28.3)	1.1 (28.3)	0.2 (5.8)	PA66	White	500
MB4SHA10C2		T18 - T50	1.1 (28.3)	1.1 (28.3)	0.2 (5.8)	PA66	White	100
MB5A0C2	MB5A	T18 - T150	1.5 (37.7)	1.5 (37.7)	0.3 (7.1)	PA66	Black	100
MB5A10C2		T18 - T150	1.5 (37.7)	1.5 (37.7)	0.3 (7.1)	PA66	White	100
MB5A0F4		T18 - T150	1.5 (37.7)	1.5 (37.7)	0.3 (7.1)	PA66	Black	250
MB5A10F4		T18 - T150	1.5 (37.7)	1.5 (37.7)	0.3 (7.1)	PA66	White	250

Dimensions are approximate and subject to technical changes. Use Part No. for ordering and Type for specification purposes.

*This product meets UL standards. Please see appendix for specific file numbers.

Adhesive Mounting Bases

Cable Tie Mounting Bases - Acrylic Adhesive

HellermannTyton Adhesive Cable Tie Mounting Bases are used with T18 through T150 Series cable ties to provide stability when securing bundles. The mounts are installed using the adhesive backing and/or by securing two or four screws. The 4-way opening allows the cable ties to be inserted parallel or perpendicular to the wire bundles. Acrylic-based adhesive allows for a permanent bond to a wide range of wood, metal and plastic surfaces.

Features and Benefits

- Acrylic adhesive offers excellent chemical, water and salt resistance and is unaffected by vibration.
- 4-way opening allows cable ties to be installed parallel or perpendicular to bundles.
- Predrilled holes extend mounting options and security.
- Extended adhesive liner is easy to remove quickly.

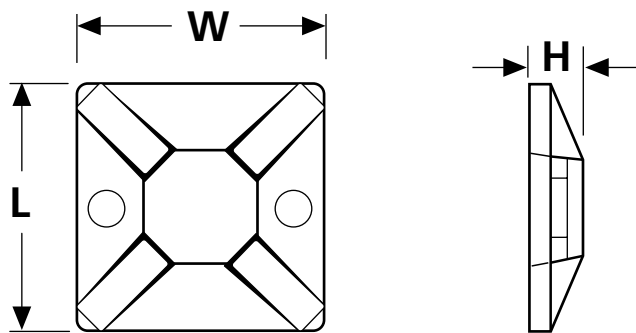

PART NO.	TYPE	Cable Tie Series	Length (L) in. (mm)	Width (W) in. (mm)	Height (H) in. (mm)	Material	Color	Pkg. Qty.
MB3A0A2H4	MB3A	T18 - T30	0.8 (19.0)	0.8 (19.0)	0.2 (4.8)	PA66	Black	500
MB3A10A2H4		T18 - T30	0.8 (19.0)	0.8 (19.0)	0.2 (4.8)	PA66	White	500
MB3A10A2C2		T18 - T30	0.8 (19.0)	0.8 (19.0)	0.2 (4.8)	PA66	White	100
MB4A0A2H4	MB4A	T18 - T50	1.1 (28.5)	1.1 (28.5)	0.2 (5.8)	PA66	Black	500
MB4A10A2C2		T18 - T50	1.1 (28.5)	1.1 (28.5)	0.2 (5.8)	PA66	White	100
MB4A10A2H4		T18 - T50	1.1 (28.5)	1.1 (28.5)	0.2 (5.8)	PA66	White	500
151-00810		T18 - T50	1.1 (28.5)	1.1 (28.5)	0.2 (5.8)	PA66UV	Black	100
151-00646		T18 - T50	1.1 (28.5)	1.1 (28.5)	0.2 (5.8)	PA66UV	Black	500
MB5A0A2F4		MB5A	T18 - T150	1.5 (37.7)	1.5 (37.7)	0.3 (7.1)	PA66	Black
MB5A10A2F4	T18 - T150		1.5 (37.7)	1.5 (37.7)	0.3 (7.1)	PA66	White	250

Dimensions are approximate and subject to technical changes. Use Part No. for ordering and Type for specification purposes.

*This product meets UL standards. Please see appendix for specific file numbers.

Bundling and Securing

Cable Tie Mounts

Adhesive Mounting Bases

Cable Tie Mounting Bases - Acrylic Foam Adhesive

Adhesive Fastened Mounting Bases are used with 18 through 150 lb. cable ties to provide stability when securing bundles. The mounts are installed using the adhesive backing and/or by securing two or four screws. The four-way opening allows the cable ties to be inserted parallel or perpendicular to the wire bundles.

Features and Benefits

- Screwable or self-adhesive versions.
- Simple to install with a screw or bolt.
- Excellent security, particularly in areas of high vibration.
- Maximum surface area with adhesive to achieve high pull-off force.
- 4-way entry for cable tie for quicker and more flexible installation.

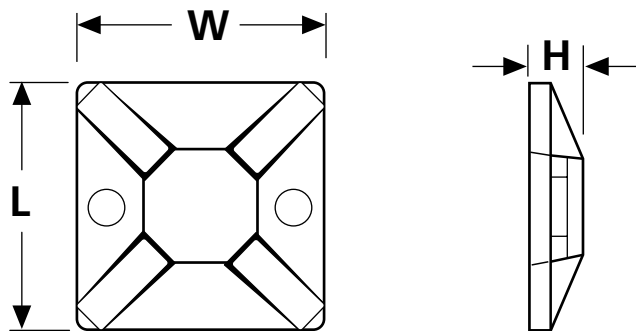

PART NO.	TYPE	Cable Tie Series	Length (L) in. (mm)	Width (W) in. (mm)	Height (H) in. (mm)	Material	Color	Pkg. Qty.
151-01630	MB3A	T18 - T30	0.8 (19.0)	0.8 (19.0)	0.2 (4.8)	PA66HIRHSUV	Black	500
151-01629		T18 - T30	0.8 (19.0)	0.8 (19.0)	0.2 (4.8)	PA66HIRHSUV	Black	100
151-01632	MB4A	T18 - T50	1.1 (28.5)	1.1 (28.5)	0.2 (5.6)	PA66HIRHSUV	Black	500
151-01631		T18 - T50	1.1 (28.5)	1.1 (28.5)	0.2 (5.6)	PA66HIRHSUV	Black	100
151-01634	MB5A	T18 - T150	1.5 (37.7)	1.5 (37.7)	0.3 (7.1)	PA66HIRHSUV	Black	250
151-01633		T18 - T150	1.5 (37.7)	1.5 (37.7)	0.3 (7.1)	PA66HIRHSUV	Black	100

Dimensions are approximate and subject to technical changes. Use Part No. for ordering and Type for specification purposes.

Adhesive Mounting Bases

Q-Series Self-Adhesive Screwable Mounting Bases

Q-Mounts are designed to work exclusively with the Q-Tie cable tie series. This mounting component is available with adhesive and can alternatively be secured with screws. The Q-Mount allows either a 2- or 4-way entry for the Q-Tie, providing a quick and simple insertion into the mount. Once in place, the Q-Tie will not slip out, even in vertical mounting applications.

Features and Benefits

- 2- or 4-way entry options for the Q-Tie, offering flexibility and stability
- Designed for use with 18- through 50-pound cable ties to provide stability when securing bundles.
- Secures with adhesive or two screws, providing versatile installation options.

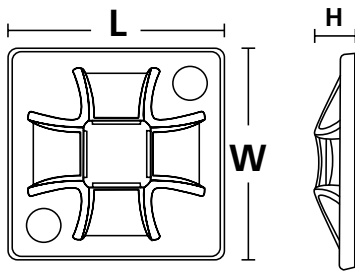

PART NO.	TYPE	Length (L) in. (mm)	Width (W) in. (mm)	Height (H) in. (mm)	Material	Color	Pkg. Qty.
151-10914	QM20A	0.8 (20.0)	0.8 (20.0)	0.2 (3.7)	PA66	Black	100
151-10904		0.8 (20.0)	0.8 (20.0)	0.2 (3.7)	PA66	Natural	100
151-10915	QM30A	1.2 (30.0)	1.2 (30.0)	0.2 (4.5)	PA66	Black	100
151-10905		1.2 (30.0)	1.2 (30.0)	0.2 (4.5)	PA66	Natural	100
151-10916	QM40A	1.6 (40.0)	1.6 (40.0)	0.3 (5.5)	PA66	Black	50
151-10906		1.6 (40.0)	1.6 (40.0)	0.3 (5.5)	PA66	Natural	50

Dimensions are approximate and subject to technical changes. Use Part No. for ordering and Type for specification purposes.

Bundling and Securing

Cable Tie Mounts

Adhesive Mounting Bases

Wide Strap Adhesive Mounting Base

HellermannTyton's Wide Strap Adhesive Mount pairs with our exclusive line of Wide Strap Cable Ties and is ideal for extreme-duty applications. The mount features 3M™ VHB™ (Very High Bond) adhesive, which actually builds strength over time and holds securely to difficult materials such as aluminum, steel, plastics and painted and powder-coated surfaces.

Features and Benefits

- Wide slot extends the versatility of our Wide Strap Cable Ties.
- Extremely durable adhesive achieves high pull-off force and is unaffected by vibration.
- Mount made of proprietary, impact-modified PA66 material for extraordinary durability, and is heat stabilized and UV resistant for extended life outdoors.
- Peel and stick for quick, convenient use in extreme-duty applications.

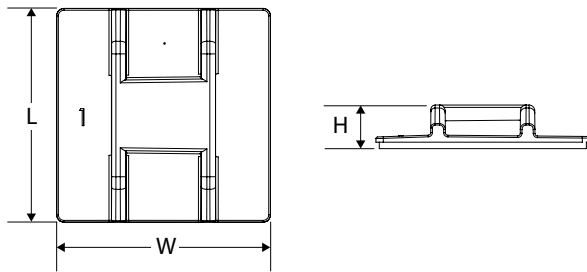

PART NO.	TYPE	Cable Tie Series	Length (L) in. (mm)	Width (W) in. (mm)	Height (H) in. (mm)	Material	Color	Pkg. Qty.
151-01857	WSMB5AHB	T18 - T150	1.5 (37.7)	1.5 (37.7)	0.3 (7.7)	PA66HIRHSUV	Black	100

Dimensions are approximate and subject to technical changes. Use Part No. for ordering and Type for specification purposes.

Adhesive Mounting Bases

FlexTack Self Adhesive Mounts

HellermannTyton FlexTack Adhesive Cable Tie Mounts deliver excellent mounting performance on flat, curved and moderately angled surfaces. Use in combination with 18- through 50-pound cable ties to provide stability when securing bundles. Excellent performance in extreme environmental conditions for a wide range of indoor and outdoor applications; on varnished, powder coated, metal or plastic surfaces; in electrical equipment; and where drilling a hole is not possible or desirable. The 4-way saddle allows cable ties to be inserted parallel or perpendicular to the wire bundles.

Features and Benefits

- One base fits more surfaces – flat, curved and moderately angled – for versatile applications.
- High-strength, weather-resistant adhesive offers excellent performance indoors and out.
- 4-way opening allows parallel or perpendicular cable routing options.

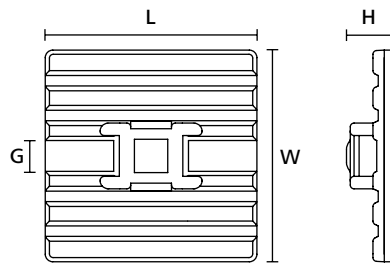

PART NO.	TYPE	Cable Tie Series	Length (L) in. (mm)	Width (W) in. (mm)	Height (H) in. (mm)	Cable Tie Width Max. (G) in. (mm)	Material	Color	Pkg. Qty.
151-01527	FMB4APT-I	T18 - T50	1.1 (28.0)	1.1 (28.0)	0.3 (6.3)	0.2 (5.4)	PA66HS	Black	100
151-01528		T18 - T50	1.1 (28.0)	1.1 (28.0)	0.3 (6.3)	0.2 (5.4)	PA66HS	White	100

Dimensions are approximate and subject to technical changes. Use Part No. for ordering and Type for specification purposes.

Bundling and Securing

Cable Tie Mounts

Screw Mounting Bases

Cable Tie Mounting Bases - Screw Mount

These cable tie mounts are compact in size. They are designed for simple yet robust installation. They pair with a cable tie for mounting applications including telecom equipment, switchgear and control cabinets.

Features and Benefits

- Compact size fits most mounting applications.
- Simple to install with a screw or rivet.
- Single hole attachment with two-way entry for cable tie.

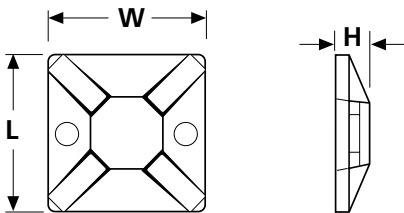

PART NO.	TYPE	Cable Tie Series	Mounting Screw Type	Length (L) in. (mm)	Width (W) in. (mm)	Height (H) in. (mm)	Material	Color	Pkg. Qty.
MB2.510C2*	MB2.5	T18	#3 Screw	0.6 (15.9)	0.6 (15.9)	0.1 (3.3)	PA66	White	100
MB2.510M4*		T18	#3 Screw	0.6 (15.9)	0.6 (15.9)	0.1 (3.3)	PA66	White	1000
MB2.50C2*		T18	#3 Screw	0.6 (15.9)	0.6 (15.9)	0.1 (3.3)	PA66	Black	100
151-01169	MCMB3	MCT18 - MCT30	#4 Screw	0.8 (19.0)	0.8 (19.0)	0.2 (3.8)	PA66MP	Blue	100
MB310C2*	MB3	T18 - T30	#4 Screw	0.8 (19.0)	0.8 (19.0)	0.2 (3.8)	PA66	White	100
MB310M4*		T18 - T30	#4 Screw	0.8 (19.0)	0.8 (19.0)	0.2 (3.8)	PA66	White	1000
MB30C2*		T18 - T30	#4 Screw	0.8 (19.0)	0.8 (19.0)	0.2 (3.8)	PA66	Black	100
MB30M4*		T18 - T30	#4 Screw	0.8 (19.0)	0.8 (19.0)	0.2 (3.8)	PA66	Black	1000
MB4SH10C2*	MB4SH	T18 - T50	#6 Screw	1.1 (28.3)	1.1 (28.3)	0.2 (5.1)	PA66	White	100
MB4SH10H4*		T18 - T50	#6 Screw	1.1 (28.3)	1.1 (28.3)	0.2 (5.1)	PA66	White	500
151-01170	MCMB4	MCT18 - MCT50	#8 Screw	1.1 (28.0)	1.1 (28.0)	0.2 (4.7)	PA66MP	Blue	100
MB410C2*	MB4	T18 - 50	#8 Screw	1.1 (28.5)	1.1 (28.5)	0.2 (4.8)	PA66	White	100
MB410H4*		T18 - 50	#8 Screw	1.1 (28.5)	1.1 (28.5)	0.2 (4.8)	PA66	White	500
MB40C2*		T18 - 50	#8 Screw	1.1 (28.5)	1.1 (28.5)	0.2 (4.8)	PA66	Black	100
MB40H4*		T18 - 50	#8 Screw	1.1 (28.5)	1.1 (28.5)	0.2 (4.8)	PA66	Black	500
MB510C2*	MB5	T18 - T150	#8 Screw	1.5 (37.7)	1.5 (37.7)	0.3 (6.2)	PA66	White	100
MB510F4*		T18 - T150	#8 Screw	1.5 (37.7)	1.5 (37.7)	0.3 (6.2)	PA66	White	250
MB50C2*		T18 - T150	#8 Screw	1.5 (37.7)	1.5 (37.7)	0.3 (6.2)	PA66	Black	100
MB50F4*		T18 - T150	#8 Screw	1.5 (37.7)	1.5 (37.7)	0.3 (6.2)	PA66	Black	250

Dimensions are approximate and subject to technical changes. Use Part No. for ordering and Type for specification purposes.

*This product meets UL standards. Please see appendix for specific file numbers.



Please note! Not all products listed on this page may have this approval. Please check our website for latest approvals.

Screw Mounting Bases

Low-Profile Cable Tie Mounts

These cable tie mounts are compact in size. They are designed for simple yet robust installation particularly in areas with limited space. They pair with a cable tie for mounting applications including telecom equipment, switchgear and control cabinets.

Features and Benefits

- Compact size for areas with limited mounting space.
- Simple to install with a screw or rivet.
- Single hole attachment with two-way entry for cable tie.

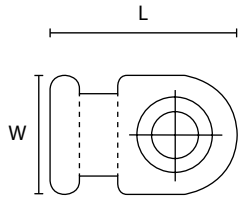

PART NO.	TYPE	Cable Tie Series	Mounting Screw Type	Length (L) in. (mm)	Width (W) in. (mm)	Height in. (mm)	Material	Color	Pkg. Qty.
MB19C2	MB1	T18	#8 (M4) Screw	0.5 (12.7)	0.3 (7.9)	0.1 (3.3)	PA66	Natural	100
MB19M4		T18	#8 (M4) Screw	0.5 (12.7)	0.3 (7.9)	0.1 (3.3)	PA66	Natural	1000
MB10C2		T18	#8 (M4) Screw	0.5 (12.7)	0.3 (7.9)	0.1 (3.3)	PA66	Black	100
MB10M4		T18	#8 (M4) Screw	0.5 (12.7)	0.3 (7.9)	0.1 (3.3)	PA66	Black	1000
MB29C2	MB2	T18 - T50	#8 (M4) Screw	0.8 (20.6)	0.5 (12.5)	0.1 (3.3)	PA66	Natural	100
MB29M4		T18 - T50	#8 (M4) Screw	0.8 (20.6)	0.5 (12.5)	0.1 (3.3)	PA66	Natural	1000

Dimensions are approximate and subject to technical changes. Use Part No. for ordering and Type for specification purposes.

Bundling and Securing

Cable Tie Mounts

Screw Mounting Bases

Cable Tie Anchor Mounts

Anchor Mounts for cable ties are suitable for applications with minimal space. Anchors are mounted onto the equipment prior to cable installation and take up no more space than the cable itself. Choose between a four-way entry design that can be used either 'in line' or at 90° to the cable run.

Features and Benefits

- Suitable for applications with minimal space.
- CTAM has 4-way entry design for use in line or at 90° angle to cable run.
- CTAM mounts are available in different sizes and materials.

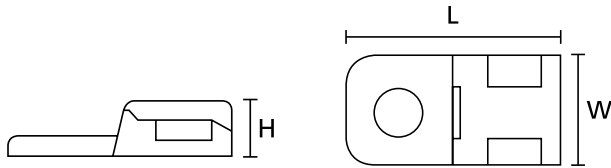

PART NO.	TYPE	Cable Tie Series	Mounting Screw Type	Length (L) in. (mm)	Width (W) in. (mm)	Height (H) in. (mm)	Material	Color	Pkg. Qty.
CTAM110C2*	CTAM1	T18 - T50	#8 (M4) Screw	0.8 (20.4)	0.4 (10.2)	0.2 (5.1)	PA66	White	100
CTAM10C2*		T18 - T50	#8 (M4) Screw	0.8 (20.4)	0.4 (10.2)	0.2 (5.1)	PA66	Black	100
CTAM10M4*		T18 - T50	#8 (M4) Screw	0.8 (20.4)	0.4 (10.2)	0.2 (5.1)	PA66	Black	1000
CTAM110M4*		T18 - T50	#8 (M4) Screw	0.8 (20.4)	0.4 (10.2)	0.2 (5.1)	PA66	White	1000
151-00757		T18 - T50	#8 (M4) Screw	0.8 (20.5)	0.4 (10.2)	0.2 (5.5)	PEEK	Beige	100
CTAM20C2*	CTAM2	T18 - T50	#10 (M5) Screw	0.8 (20.4)	0.4 (10.2)	0.2 (5.1)	PA66	Black	100
CTAM20M4*		T18 - T50	#10 (M5) Screw	0.8 (20.4)	0.4 (10.2)	0.2 (5.1)	PA66	Black	1000
CTAM210C2*		T18 - T50	#10 (M5) Screw	0.8 (20.4)	0.4 (10.2)	0.2 (5.1)	PA66	White	100
CTAM210M4*		T18 - T50	#10 (M5) Screw	0.8 (20.4)	0.4 (10.2)	0.2 (5.1)	PA66	White	1000
151-00758		T18 - T50	#10 (M5) Screw	0.8 (20.5)	0.4 (10.2)	0.2 (5.5)	PEEK	Beige	100
151-00997	MCCTAM1	MCT18 - MCT50	#8 (M4) Screw	0.8 (20.7)	0.4 (10.3)	0.2 (5.1)	PA66MP+	Blue	100

Dimensions are approximate and subject to technical changes. Use Part No. for ordering and Type for specification purposes.

*This product meets UL standards. Please see appendix for specific file numbers.



Please note! Not all products listed on this page may have this approval. Please check our website for latest approvals.

Screw Mounting Bases

Cable Tie Anchor Plates

HellermannTyton Cable Tie Anchor Plates are designed as a "stand-off" mount for perpendicular wire bundles. These mounts offer an elongated mounting hole for easier alignment of wire bundles. The mounts are installed quickly and easily by securing a single screw.

Features and Benefits

- Mount provides a "stand-off" for perpendicular bundles.
- Secures with a single screw providing quick installation.

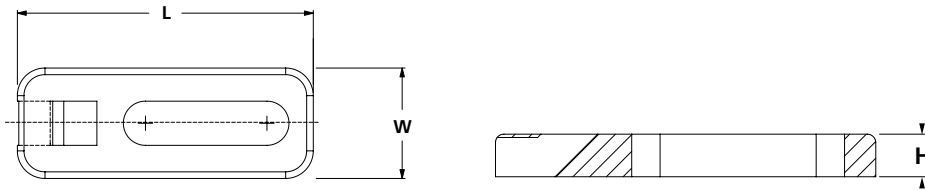

PART NO.	TYPE	Cable Tie Series	Mounting Screw Type	Length (L) in. (mm)	Width (W) in. (mm)	Height (H) in. (mm)	Material	Color	Pkg. Qty.
CTAP110C2*	CTAP1	T18 - T50	#10 (M5) Screw	1.3 (34.0)	0.5 (12.7)	0.2 (3.8)	PA66	White	100
CTAP110M4*		T18 - T50	#10 (M5) Screw	1.3 (34.0)	0.5 (12.7)	0.2 (3.8)	PA66	White	1000
CTAP10C2*		T18 - T50	#10 (M5) Screw	1.3 (34.0)	0.5 (12.7)	0.2 (3.8)	PA66	Black	100
CTAP10M4*		T18 - T50	#10 (M5) Screw	1.3 (34.0)	0.5 (12.7)	0.2 (3.8)	PA66	Black	1000
CTAP210C2*	CTAP2	T18 - T50	#10 (M5) Screw	2.1 (54.1)	0.5 (12.7)	0.1 (3.5)	PA66	White	100

Dimensions are approximate and subject to technical changes. Use Part No. for ordering and Type for specification purposes.

*This product meets UL standards. Please see appendix for specific file numbers.



Please note! Not all products listed on this page may have this approval. Please check our website for latest approvals.

Bundling and Securing

Cable Tie Mounts

Screw Mounting Bases

Cable Tie Mounts

Designed specifically for holding heavier cable bundles these mounting bases can be used in many industries from agriculture to truck manufacture. They offer a very secure fixing and can be used with a wide variety of heavy duty cable ties up to 8.3 mm width.

Features and Benefits

- The CTM series is designed to provide stability to wire bundles.
- These mounts can accommodate miniature, intermediate, or standard cross-section cable ties.
- Each mount is secured with a single screw.

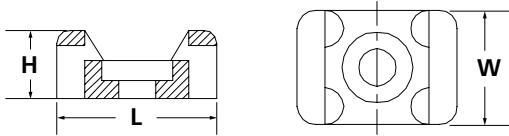

PART NO.	TYPE	Cable Tie Series	Mounting Screw Type	Length (L) in. (mm)	Width (W) in. (mm)	Height (H) in. (mm)	Material	Color	Pkg. Qty.
CTM010M4*	CTM0	T18 - T50	#6 (M3) Screw	0.6 (14.7)	0.4 (9.4)	0.3 (6.9)	PA66	White	1000
CTM00C2*		T18 - T50	#6 (M3) Screw	0.6 (14.7)	0.4 (9.4)	0.3 (6.9)	PA66	Black	100
CTM00M4*		T18 - T50	#6 (M3) Screw	0.6 (14.7)	0.4 (9.4)	0.3 (6.9)	PA66	Black	1000
CTM010C2*		T18 - T50	#6 (M3) Screw	0.6 (14.7)	0.4 (9.4)	0.3 (6.9)	PA66	White	100
CTM10C2*	CTM1	T18 - T50	#8 (M4) Screw	0.6 (14.7)	0.4 (9.4)	0.3 (6.9)	PA66	Black	100
CTM10M4*		T18 - T50	#8 (M4) Screw	0.6 (14.7)	0.4 (9.4)	0.3 (6.9)	PA66	Black	1000
CTM110C2*		T18 - T50	#8 (M4) Screw	0.6 (14.7)	0.4 (9.4)	0.3 (6.9)	PA66	White	100
CTM110M4*		T18 - T50	#8 (M4) Screw	0.6 (14.7)	0.4 (9.4)	0.3 (6.9)	PA66	White	1000
CTM20C2*	CTM2	T18 - T120	#8 (M4) Screw	0.9 (21.8)	0.6 (15.5)	0.4 (9.4)	PA66	Black	100
CTM20M4*		T18 - T120	#8 (M4) Screw	0.9 (21.8)	0.6 (15.5)	0.4 (9.4)	PA66	Black	1000
CTM210C2*		T18 - T120	#8 (M4) Screw	0.9 (21.8)	0.6 (15.5)	0.4 (9.4)	PA66	White	100
CTM210M4*		T18 - T120	#8 (M4) Screw	0.9 (21.8)	0.6 (15.5)	0.4 (9.4)	PA66	White	1000

Dimensions are approximate and subject to technical changes. Use Part No. for ordering and Type for specification purposes.

*This product meets UL standards. Please see appendix for specific file numbers.



Please note! Not all products listed on this page may have this approval. Please check our website for latest approvals.

Screw Mounting Bases

Cable Tie Mounts

PART NO.	TYPE	Cable Tie Series	Mounting Screw Type	Length (L) in. (mm)	Width (W) in. (mm)	Height (H) in. (mm)	Material	Color	Pkg. Qty.
CTM30C2*	CTM3	T18 - T120	#10 (M5) Screw	0.9 (21.8)	0.6 (15.5)	0.4 (9.4)	PA66	Black	100
CTM30M4*		T18 - T120	#10 (M5) Screw	0.9 (21.8)	0.6 (15.5)	0.4 (9.4)	PA66	Black	1000
CTM310C2*		T18 - T120	#10 (M5) Screw	0.9 (21.8)	0.6 (15.5)	0.4 (9.4)	PA66	White	100
CTM310M4*		T18 - T120	#10 (M5) Screw	0.9 (21.8)	0.6 (15.5)	0.4 (9.4)	PA66	White	1000
CTM40C2*	CTM4	T18 - T120	1/4" (M6) Screw	0.9 (21.8)	0.6 (15.8)	0.4 (9.4)	PA66	Black	100
CTM40M4*		T18 - T120	1/4" (M6) Screw	0.9 (21.8)	0.6 (15.8)	0.4 (9.4)	PA66	Black	1000
CTM410C2*		T18 - T120	1/4" (M6) Screw	0.9 (21.8)	0.6 (15.8)	0.4 (9.4)	PA66	White	100
CTM410M4*		T18 - T120	1/4" (M6) Screw	0.9 (21.8)	0.6 (15.8)	0.4 (9.4)	PA66	White	1000
151-00950	MCKR6G5	MCTS series	M4	0.7 (17.8)	0.5 (11.8)	0.4 (8.8)	PA66MP+	Blue	100
151-01020	MCKR8G5-5	MCTS series	M5	1.0 (24.8)	0.4 (14.3)	0.5 (12.0)	PA66MP+	Blue	100

Dimensions are approximate and subject to technical changes. Use Part No. for ordering and Type for specification purposes.

*This product meets UL standards. Please see appendix for specific file numbers.



Please note! Not all products listed on this page may have this approval. Please check our website for latest approvals.

Bundling and Securing

Cable Tie Mounts

Screw Mounting Bases

Q-Series Screw Mounting Bases

Q-Series mounting bases are designed to work exclusively with the Q-Tie® cable tie series. This mounting component can be secured with screws. The Q-Mount allows either a two- or four-way entry for the Q-Tie, providing a quick and simple insertion into the mount. Once in place, the Q-Tie will not slip out, even in vertical mounting applications.

Features and Benefits

- 2- or 4-way entry options for the Q-Tie, offering flexibility and stability
- Designed for use with 18- through 120-pound cable ties to provide stability when securing bundles.
- Secures with a single screw, providing quick installation.

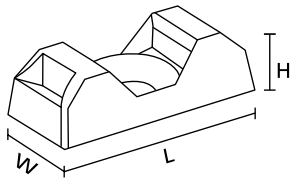

PART NO.	TYPE	Mounting Screw Type	Length (L) in. (mm)	Width (W) in. (mm)	Height (H) in. (mm)	Material	Color	Pkg. Qty.
151-10901*	QM20	#5 (M3) Screw	0.8 (20.0)	0.8 (20.0)	0.1 (3.7)	PA66	Natural	100
151-10911*		#5 (M3) Screw	0.8 (20.0)	0.8 (20.0)	0.1 (3.7)	PA66	Black	100
151-10920*	CTQM5	#8 (M4) Screw	0.8 (21.0)	0.4 (9.5)	0.3 (6.7)	PA66	Natural	100
151-10930*		#8 (M4) Screw	0.8 (21.0)	0.4 (9.5)	0.3 (6.7)	PA66	Black	100
151-10902	QM30	#8 (M4) Screw	1.2 (30.0)	1.2 (30.0)	0.2 (4.5)	PA66	Natural	100
151-10912		#8 (M4) Screw	1.2 (30.0)	1.2 (30.0)	0.2 (4.5)	PA66	Black	100
151-10903	QM40	#8 (M4) Screw	1.6 (40.0)	1.6 (40.0)	0.2 (5.5)	PA66	Natural	50
151-10913		#8 (M4) Screw	1.6 (40.0)	1.6 (40.0)	0.2 (5.5)	PA66	Black	50

Dimensions are approximate and subject to technical changes. Use Part No. for ordering and Type for specification purposes.



Please note! Not all products listed on this page may have this approval. Please check our website for latest approvals.

Mounting Plates

Cable Tie Mounting Plates

Mounting Plates allow multiple cables to be run in parallel. Mounts are secured with two screws. Cables are attached to the plates by running a cable tie through any of the available slots.

Features and Benefits

- Mounting plates allow multiple bundles to run parallel.
- The mounts are secured using two screws, while the bundles are attached using cable ties in any of the available slots.

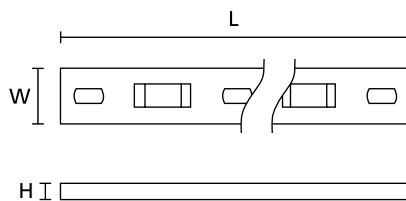
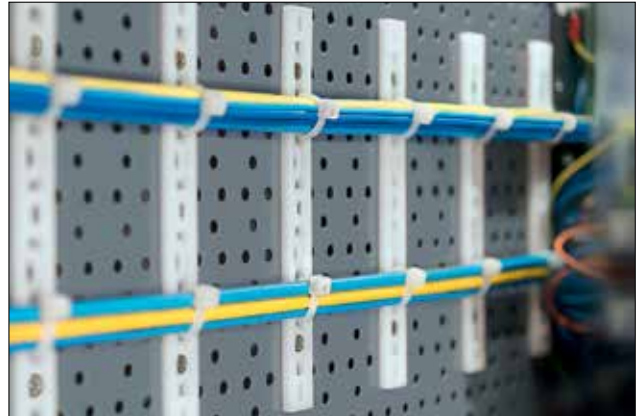

PART NO.	TYPE	Cable Tie Series	Mounting Screw Type	Length (L) in. (mm)	Width (W) in. (mm)	Height (H) in. (mm)	Material	Color	Pkg. Qty.
MP1M5.NN3P	MP1M5	T18 - T50	#10 (M5) Screw	1.8 (44.4)	0.5 (12.7)	0.1 (3.2)	PA66	Natural	100
MP1M3.NN3P	MP1M3	T18 - T50	#6 (M3) Screw	1.8 (44.4)	0.5 (12.7)	0.1 (3.2)	PA66	Natural	100
MP2M3.NN3P	MP2M3	T18 - T50	#6 (M3) Screw	3.0 (76.2)	0.5 (12.7)	0.1 (3.2)	PA66	Natural	100
MP2M5.NN3P	MP2M5	T18 - T50	#10 (M5) Screw	3.0 (76.2)	0.5 (12.7)	0.1 (3.2)	PA66	Natural	100
MP3M3.NN3P	MP3M3	T18 - T50	#6 (M3) Screw	4.3 (108.0)	0.5 (12.7)	0.1 (3.2)	PA66	Natural	100
MP3M5.NN3P	MP3M5	T18 - T50	#10 (M5) Screw	4.3 (108.0)	0.5 (12.7)	0.1 (3.2)	PA66	Natural	100
MP4M3.NN3P	MP4M3	T18 - T50	#6 (M3) Screw	5.5 (139.8)	0.5 (12.7)	0.1 (3.2)	PA66	Natural	100
MP4M5.NN3P	MP4M5	T18 - T50	#10 (M5) Screw	5.5 (139.8)	0.5 (12.7)	0.1 (3.2)	PA66	Natural	100
MP5M3.NN3P	MP5M3	T18 - T50	#6 (M3) Screw	6.8 (171.6)	0.5 (12.7)	0.1 (3.2)	PA66	Natural	100
MP5M5.NN3P	MP5M5	T18 - T50	#10 (M5) Screw	6.8 (171.6)	0.5 (12.7)	0.1 (3.2)	PA66	Natural	100
MSMP6-109C2*	MSMP6/10	T18 - T120	#10 (M5) Screw	9.5 (241.0)	0.6 (15.8)	0.2 (5.3)	PA66	Natural	100
MSMP6-69C2*	MSMP6/6	T18 - T120	#6 (M3) Screw	9.6 (244.0)	0.6 (15.8)	0.2 (5.3)	PA66	Natural	100

Dimensions are approximate and subject to technical changes. Use Part No. for ordering and Type for specification purposes.

*This product meets UL standards. Please see appendix for specific file numbers.

EN 45545-2



Please note! Not all products listed on this page may have this approval. Please check our website for latest approvals.

Bundling and Securing

Cable Tie Mounts

Push Mounts

TM Series Push Mounts

HellermannTyton Push Mounts are used with our standard cable ties and offer a permanent bundling solution for quick installation by pushing the mount through a pre-drilled hole. The low profile head is suitable in space constrained areas.

Features and Benefits

- Push Mounts, when used with standard cable ties, provide a permanent bundling solution.
- The low profile style head is ideal for space constrained areas and is easily inserted through a pre-drilled hole.

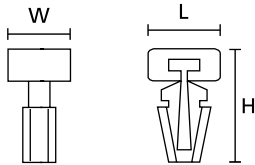

PART NO.	TYPE	Cable Tie Series	Mounting Hole Dia. in. (mm)	Max. Panel Thickness in. (mm)	Length (L) in. (mm)	Width (W) in. (mm)	Height (H) in. (mm)	Material	Color	Pkg. Qty.
TM1SF0C2*	TM1SF	T18 - T50	0.3 (6.4)	0.1 (3.3)	0.6 (15.8)	0.4 (10.2)	0.2 (4.6)	PA66	Black	100
TM1SF0M4*		T18 - T50	0.3 (6.4)	0.1 (3.3)	0.6 (15.8)	0.4 (10.2)	0.2 (4.6)	PA66	Black	1000
TM1SF9M4*		T18 - T50	0.3 (6.4)	0.1 (3.3)	0.6 (15.8)	0.4 (10.2)	0.2 (4.6)	PA66	Natural	1000
TM1SF10C2*		T18 - T50	0.3 (6.4)	0.1 (3.4)	0.6 (15.8)	0.4 (10.2)	0.2 (4.6)	PA66	White	100
TM1SF10M4*		T18 - T50	0.3 (6.4)	0.1 (3.3)	0.6 (15.8)	0.4 (10.2)	0.2 (4.6)	PA66	White	1000

Dimensions are approximate and subject to technical changes. Use Part No. for ordering and Type for specification purposes.

*This product meets UL standards. Please see appendix for specific file numbers.

EN 45545-2



Please note! Not all products listed on this page may have this approval. Please check our website for latest approvals.

Push Mounts

Push Button Mounts

HellermannTyton Push Mounts are used with our standard cable ties and offer a permanent bundling solution for installation below or underneath a panel. Designed for simple installation by pushing the mount through a pre-drilled hole. The low profile "button" style head is suitable in space constrained areas.

Features and Benefits

- Push Mounts, when used with standard cable ties, provide a permanent bundling solution below a panel.
- The "button" style head is ideal for space constrained areas and is easily inserted through a pre-drilled hole.

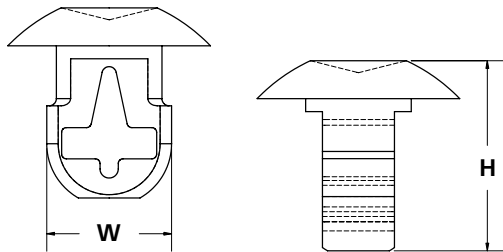

PART NO.	TYPE	Cable Tie Series	Mounting Hole Dia. in. (mm)	Max. Panel Thickness in. (mm)	Width (W) in. (mm)	Height (H) in. (mm)	Material	Color	Pkg. Qty.
PBM0C2*	PBM	T18 - T50	0.3 - 0.3 (6.3 - 6.6)	0.1 (3.0)	0.3 (6.6)	0.4 (10.2)	PA66	Black	100
PBM0M4*		T18 - T50	0.3 - 0.3 (6.3 - 6.6)	0.1 (3.0)	0.3 (6.6)	0.4 (10.2)	PA66	Black	1000
PBM9C2*		T18 - T50	0.3 - 0.3 (6.3 - 6.6)	0.1 (3.0)	0.3 (6.6)	0.4 (10.2)	PA66	Natural	100
PBM9M4*		T18 - T50	0.3 - 0.3 (6.3 - 6.6)	0.1 (3.0)	0.3 (6.6)	0.4 (10.2)	PA66	Natural	1000
PBM10C2*		T18 - T50	0.3 - 0.3 (6.3 - 6.6)	0.1 (3.0)	0.3 (6.6)	0.4 (10.2)	PA66	White	100
PBM10M4*		T18 - T50	0.3 - 0.3 (6.3 - 6.6)	0.1 (3.0)	0.3 (6.6)	0.4 (10.2)	PA66	White	1000

Dimensions are approximate and subject to technical changes. Use Part No. for ordering and Type for specification purposes.

*This product meets UL standards. Please see appendix for specific file numbers.



Please note! Not all products listed on this page may have this approval. Please check our website for latest approvals.

Bundling and Securing

Cable Tie Mounts

Masonry Mounts

MMB Series

HellermannTyton Masonry Mounts provide a permanent method of attaching wire and cable to masonry surfaces. Masonry mounts simply tap into predrilled holes and can be used for indoor and outdoor applications.

Features and Benefits

- Masonry Mounts provide a permanent solution when fastening wire and cables to masonry surfaces.
- The mounts have easy installation into predrilled holes allowing for faster use.

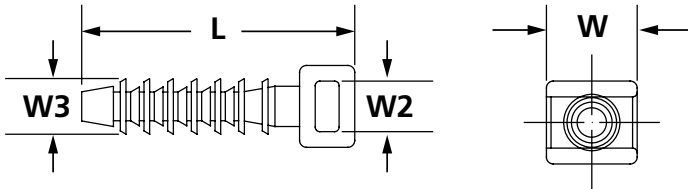

PART NO.	TYPE	Cable Tie Series	Mounting Hole Dia. in. (mm)	Hole Depth Min. in. (mm)	Length (L) in. (mm)	Width (W) in. (mm)	Width (W2) in. (mm)	Width (W3) in. (mm)	Material	Color	Pkg. Qty.
MMB00C2	MMB0	T18 - T50	0.2 (4.7)	1.0 (25.4)	1.2 (30.1)	0.4 (9.0)	0.2 (5.5)	0.2 (6.0)	PA46	Black	100
MMB.50C2	MMB.5	T18 - T50	0.3 (6.4)	1.0 (25.4)	1.2 (31.5)	0.4 (9.5)	0.2 (5.6)	0.3 (7.8)	PA46	Black	100
MMB.50M4		T18 - T50	0.3 (6.4)	1.0 (25.4)	1.2 (31.5)	0.4 (9.5)	0.2 (5.6)	0.3 (7.8)	PA46	Black	1000
MMB10C2	MMB1	T18 - T50	0.3 (8.0)	1.5 (38.1)	1.7 (43.5)	0.5 (12.9)	0.4 (9.5)	0.4 (9.2)	PA46	Black	100
MMB10H4		T18 - T50	0.3 (8.0)	1.5 (38.1)	1.7 (43.5)	0.5 (12.9)	0.4 (9.5)	0.4 (9.2)	PA46	Black	500

Dimensions are approximate and subject to technical changes. Use Part No. for ordering and Type for specification purposes.

Grip Tie Mounts

Hook-and-Loop Series

To secure bundles to flat surfaces, HellermannTyton offers a mounting base to be used with the Grip Ties. Available with or without adhesive, two sizes of Grip Tie mounts cover every size of Grip Tie. The mounts are manufactured from nylon 6/6 material and are UV-stabilized for outdoor applications.

Features and Benefits

- Adhesive or nonadhesive with 1/4" screw hole mount secures .75" grip ties for use on flat surfaces.

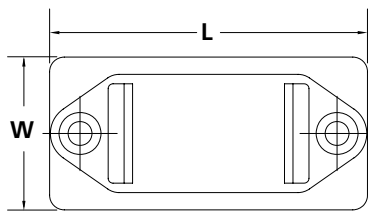

PART NO.	TYPE	Description	Bolt Size in. (mm)	Adhesive	Length (L) in. (mm)	Width (W) in. (mm)	Material	Color	Pkg. Qty.
GTM500C2	GTM50	For use with .5" wide grip tie	1/4" (M6) Screw	-	2.5 (63.5)	1.0 (25.4)	PA66UV	Black	100
GTM50A0C2	GTM50A	For use with .5" wide grip tie	1/4" (M6) Screw	Urethane foam	2.5 (63.5)	1.0 (25.4)	PA66UV	Black	100
GTM1000C2	GTM100	For use with .75" wide grip tie	1/4" (M6) Screw	-	3.3 (82.6)	1.5 (38.1)	PA66UV	Black	100
GTM100A0C2	GTM100A	For use with .75" wide grip tie	1/4" (M6) Screw	Urethane foam	3.3 (82.6)	1.5 (38.1)	PA66UV	Black	100

Dimensions are approximate and subject to technical changes. Use Part No. for ordering and Type for specification purposes.

Bundling and Securing

Heavy Duty Cable Tie Mounts

Mounts Secured with Mechanical Fasteners - Single Bundles

Heavy Duty Mounts - Standard Torque

These mounts contain a small tab inside the mounting hole to temporarily engage the threads, which allows assemblers to preinstall the mount on a stud before securing with a washer and a nut. For use with HellermannTyton heavy duty T120, T250, T255 and Wide Strap Cable Ties.

Features and Benefits

- Mount and tie combination makes it easy to service bundles in the field.
- Made from impact modified, heat stabilized, UV resistant material, ideal for heavy duty environments.
- Eliminates the needs for multiple sized fix diameter clamps.

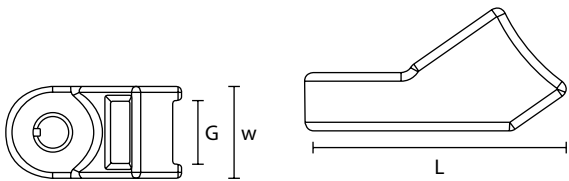

PART NO.	TYPE	Cable Tie Width Max. (G) in. (mm)	Mounting Screw Type	Max. Torque lbf-ft. (kgf-cm)	Length (L) in. (mm)	Width (W) in. (mm)	Material	Color	Pkg. Qty.
HDM190HIRC2	HDM19	0.5 (12.7)	#10 (M5) Screw	9.6 (132.5)	1.4 (36.3)	0.8 (19.3)	PA66HIRHSUV	Black	100
HDM190HIRH4		0.5 (12.7)	#10 (M5) Screw	9.6 (132.5)	1.4 (36.3)	0.8 (19.3)	PA66HIRHSUV	Black	500
HDM250HIRC2	HDM25	0.5 (12.7)	1/4" (M6) Screw	9.6 (132.5)	1.4 (36.3)	0.8 (19.3)	PA66HIRHSUV	Black	100
HDM250HIRH4		0.5 (12.7)	1/4" (M6) Screw	9.6 (132.5)	1.4 (36.3)	0.8 (19.3)	PA66HIRHSUV	Black	500
HDM3120HIRC2	HDM312	0.5 (12.7)	5/16" (M8) Screw	9.6 (132.5)	1.4 (36.3)	0.8 (19.3)	PA66HIRHSUV	Black	100
HDM3120HIRH4		0.5 (12.7)	5/16" (M8) Screw	9.6 (132.5)	1.4 (36.3)	0.8 (19.3)	PA66HIRHSUV	Black	500

Dimensions are approximate and subject to technical changes. Use Part No. for ordering and Type for specification purposes.

Mounts Secured with Mechanical Fasteners - Single Bundles

Heavy Duty Mounts - Medium Torque

The arched H-profile of the saddle surface allows for a broad surface contact with the bundle, minimizing pinching and crushing of the bundles, and adjusts to a wide variety of bundle diameters when used with HellermannTyton heavy duty T120, T250, T255 and Wide Strap Cable Ties.

Features and Benefits

- Mount and tie combination makes it easy to service bundles in the field.
- Made from impact modified, heat stabilized, UV resistant material, ideal for heavy duty environments.
- Eliminates the need for multiple size fixed-diameter clamps.

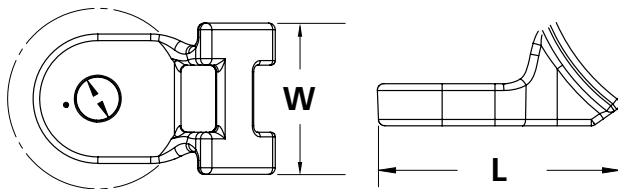

PART NO.	TYPE	Cable Tie Width Max. (G) in. (mm)	Mounting Screw Type	Max. Torque lbf-ft. (kgf-cm)	Length (L) in. (mm)	Width (W) in. (mm)	Material	Color	Pkg. Qty.
HDM321HIHSUVH4	HDM321	0.5 (12.7)	5/16" (M8) Screw	40.0 (553.0)	1.8 (46.0)	1.0 (24.0)	PA66HIRHSUV	Black	500
HDM401HIHSUVH4	HDM401	0.5 (12.7)	3/8" (M10) Screw	40.0 (553.0)	1.8 (46.0)	1.0 (24.0)	PA66HIRHSUV	Black	500
HDM501HIHSUVH4	HDM501	0.5 (12.7)	1/2" (M12) Screw	40.0 (553.0)	1.8 (46.0)	1.0 (24.0)	PA66HIRHSUV	Black	500

Dimensions are approximate and subject to technical changes. Use Part No. for ordering and Type for specification purposes.

Bundling and Securing

Heavy Duty Cable Tie Mounts

Mounts Secured with Mechanical Fasteners - Single Bundles

Heavy Duty Mounts - High Torque

The high-torque mount is designed for use with power-assisted impact wrenches and is molded with a heavy bushing to withstand the forces required to tighten grade 8 bolts. The arched H-profile of the saddle surface allows for a broad surface contact with the bundle, minimizing pinching and crushing of the bundles, and adjusts to a wide variety of bundle diameters when used with HellermannTyton heavy duty T120, T250, T255 and Wide Strap Cable Ties.

Features and Benefits

- Mount and tie combination makes it easy to service bundles in the field.
- Made from impact modified, heat stabilized, UV resistant material, ideal for heavy duty environments.
- Eliminates the need for multiple size fixed-diameter clamps.

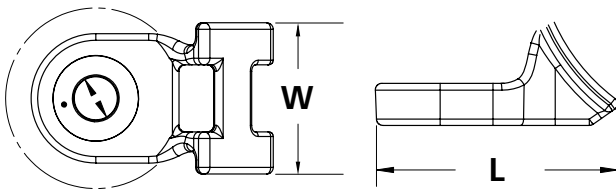

PART NO.	TYPE	Cable Tie Width Max. (G) in. (mm)	Mounting Screw Type	Max. Torque lbf-ft. (kgf-cm)	Length (L) in. (mm)	Width (W) in. (mm)	Material	Color	Pkg. Qty.
151-02098	HDM320	0.5 (12.7)	5/16" (M8) Screw	114.0 (1,576.0)	1.9 (47.0)	1.0 (25.0)	PA66HIRHSUV	Black	100
151-02094		0.5 (12.7)	5/16" (M8) Screw	114.0 (1,576.0)	1.9 (47.0)	1.0 (25.0)	PA66HIRHSUV	Black	500
151-02097	HDM500	0.5 (12.7)	1/2" (M12) Screw	114.0 (1,576.0)	1.9 (47.0)	1.0 (25.0)	PA66HIRHSUV	Black	100
151-02096		0.5 (12.7)	1/2" (M12) Screw	114.0 (1,576.0)	1.9 (47.0)	1.0 (25.0)	PA66HIRHSUV	Black	500

Dimensions are approximate and subject to technical changes. Use Part No. for ordering and Type for specification purposes.

Mounts Secured with Mechanical Fasteners - Single Bundles

High Torque Double Mounts

High Torque Double Mounts are designed for use with power assisted impact wrenches and are molded with a metal bushing to withstand the forces required to tighten grade 8 bolts. Mounts are designed for routing multiple bundles with HellermannTyton heavy duty T250, T255, and wide strap cable ties to harness wires and hoses. The bundle is secured directly over the mounting fastener. The arched saddle surface allows for a broad surface contact with the bundle, minimizing pinching and crushing of the bundles. Mounts accept all standard cable ties up to .5" wide.



Features and Benefits

- Arched H-profile surface allows for broad surface contact with the bundle, minimizing pinching and crushing of the bundles.
- High torque metal bushing allows for strength in heavy duty applications.
- These mounts contain a small tab inside the mounting hole to temporarily engage the threads which allows assemblers to pre-install the mount on a stud with a washer and nut.

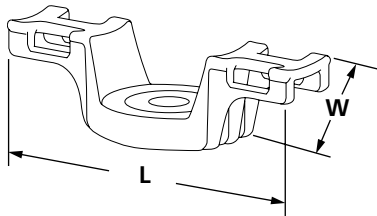

PART NO.	TYPE	Cable Tie Width Max. (G) in. (mm)	Mounting Screw Type	Length (L) in. (mm)	Width (W) in. (mm)	Material	Color	Pkg. Qty.
151-02104	HDM375BDM4W	0.5 (12.7)	3/8" (M10) Screw	3.5 (89.0)	1.4 (35.6)	PA66HIRHSUV	Black	100

Dimensions are approximate and subject to technical changes. Use Part No. for ordering and Type for specification purposes.

Bundling and Securing

Heavy Duty Cable Tie Mounts

Mounts Secured with Mechanical Fasteners - Single Bundles

Axial Oval Mounts

HellermannTyton Axial Oval Mounts stand-off bundles from frame rails and cross members to prevent them from rubbing and chafing. The axial oval mount accommodates HellermannTyton heavy duty T120, T250, T255 and Wide Strap Cable Ties. It is designed to fit a 5/16" bolt.

Features and Benefits

- Positions bundles off cross members and frame rails to prevent abrasion and chafing.
- Metal insert bushing accommodates high-torque installation.
- Made with high-impact, heat stabilized, and UV material ideal for trucking and heavy equipment environments.

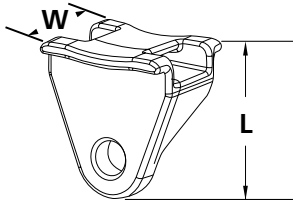

PART NO.	TYPE	Cable Tie Width Max. in. (mm)	Mounting Screw Type	Length (L) in. (mm)	Width (W) in. (mm)	Material	Color	Pkg. Qty.
SAM83HIRHSH1	SAM83	0.5 (12.7)	5/16" (M8) Screw	1.4 (34.0)	1.0 (26.0)	PA66HIRHSUV	Gray	500
SAOM80HIRHSH1	SAOM8	0.5 (12.7)	5/16" (M8) Screw	1.4 (34.0)	1.0 (26.0)	PA66HIRHSUV	Black	500
SAOM820HIRHSH1	SAOM82	0.5 (12.7)	5/16" (M8) Screw	1.4 (34.0)	1.0 (26.0)	PA66HIRHSUV	Black	500

Dimensions are approximate and subject to technical changes. Use Part No. for ordering and Type for specification purposes.

Mounts Secured with Mechanical Fasteners - Single Bundle

Cable Guide Standoff

This cable guide standoff is designed for the use with HellermannTyton's button head ties. The cable guide standoff stands off bundles from frame rails, providing clearance from bolts and other protrusions for protection against abrasion. This mount also allows the flow-through of salt, dirt and other impurities from the road, preventing unwanted build-up on hoses and harnesses. This product perfectly secures convoluted tubing's up to 26mm in diameter.

Features and Benefits

- Tubes are fixed a defined distance from the substructure.
- Defined diameter for the wire entry.
- Retainer is fixed in the hole with BHT-tie.

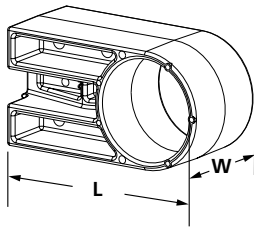

PART NO.	TYPE	Length (L) in. (mm)	Width (W) in. (mm)	Material	Color	Pkg. Qty.
151-00006	CGS1	2.2 (56.6)	1.0 (25.4)	PA66HIRHSUV	Black	250
133-00285	CGS2	3.2 (82.0)	1.5 (38.1)	PA66HIRHS	Black	150

Dimensions are approximate and subject to technical changes. Use Part No. for ordering and Type for specification purposes.

Bundling and Securing

Heavy Duty Cable Tie Mounts

Mounts Secured with Mechanical Fasteners - Single Bundles

Axial Mounts - High Torque

HellermannTyton Axial Mounts stand-off bundles from frame rails and cross members to prevent them from rubbing and chafing. The axial mount accommodates HellermannTyton heavy duty T120, T250, T255 and Wide Strap Cable Ties. It is designed to fit a 5/16" bolt.

Features and Benefits

- Positions bundles off cross members and frame rails to prevent abrasion and chafing.
- Metal insert bushing accommodates high-torque installation.
- Made with high-impact, heat stabilized, and UV material ideal for trucking and heavy equipment environments.

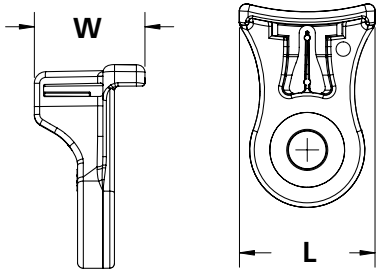

PART NO.	TYPE	Length (L) in. (mm)	Width (W) in. (mm)	Material	Color	Pkg. Qty.
151-02099	SAM320B	1.2 (29.9)	1.0 (25.0)	PA66HIRHSUV	Black	500
151-02102	SAM400B	1.2 (29.9)	1.0 (25.0)	PA66HIRHSUV	Black	500
151-02103	SAM500B	1.2 (29.9)	1.0 (25.0)	PA66HIRHSUV	Black	500

Dimensions are approximate and subject to technical changes. Use Part No. for ordering and Type for specification purposes.

Mounts Secured with Mechanical Fasteners - Single Bundle

Lashing Tie Mounts

The lashing tie mount is designed to snap into the T250 lashing tie. The tie head is assembled perpendicular to the mount. The strap is parallel to the mount when inserted into the head. The lashing tie mount is recommended for indoor or outdoor wall mount cable applications.

Features and Benefits

- The strap is parallel to the mount when inserted into the head, providing a fixed insertion point for the cable tie.

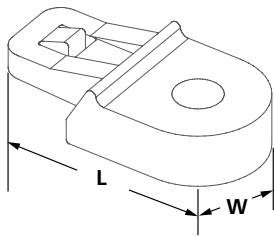

PART NO.	TYPE	Cable Tie Width Max. in. (mm)	Mounting Screw Type	Length (L) in. (mm)	Width (W) in. (mm)	Material	Color	Pkg. Qty.
LTM2500C2	LTM250	0.5 (12.5)	1/4" (M6) Screw	1.5 (37.1)	0.7 (18.5)	PA66HS	Black	100

Dimensions are approximate and subject to technical changes. Use Part No. for ordering and Type for specification purposes.

Bundling and Securing

Heavy Duty Cable Tie Mounts

Mounts Secured with Mechanical Fasteners - Multiple Bundles

Low Profile Mount

Low Profile Mounts secure bundles close to mounting surfaces, making them ideal for applications where bundle mounting space is limited. These are secured to the mounting surface with a .25" mechanical fastener and features a counter bore for easy access with a socket. The mount accommodates cable ties up to .5" in width. Single bundles can be positioned on top of the mount, or two bundles can be separated using the two side saddles.

Features and Benefits

- Separates bundles to help prevent chafing and wear.
- Single bundles can be mounted on top of the mount, or two bundles can be separated using the two side saddles; giving the mount versatility.
- Low profile design allows mount to be placed in areas where space is limited.

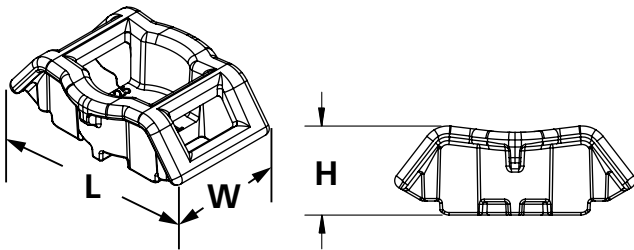

PART NO.	TYPE	Cable Tie Series	Mounting Screw Type	Length (L) in. (mm)	Width (W) in. (mm)	Height (H) in. (mm)	Material	Color	Pkg. Qty.
151-01122	LPM25	T50 - T250	1/4" (M6) Screw	1.8 (45.1)	1.0 (24.9)	0.7 (16.7)	PA66HIRHSUV	Black	500

Dimensions are approximate and subject to technical changes. Use Part No. for ordering and Type for specification purposes.

Mounts Secured with Mechanical Fasteners - Multiple Bundles

Two Way Saddle Mounts

HellermannTyton's saddle mount can be installed between two bundles (such as wires, cables, hoses, tubing, conduit, etc.) to separate them and prevent chafing and wear. Fastened to a frame rail or mounting bracket, the H-profile on the saddle mount provides a tight circumferential loop on large and small bundles. Cable ties up to 1/2" wide are used to secure the bundles.

Features and Benefits

- Separates bundles from wear and chafing, providing additional longevity.
- Hexagonal retention feature (S2HM25) captures a bolt or nut requiring tool access from the back side only.
- A socket counterbore allows securing with a socket wrench from the top side for use with a weld stud or bolt (S2CM25.)
- Made from impact modified, heat stabilized, UV resistant material making it ideal for heavy duty applications.

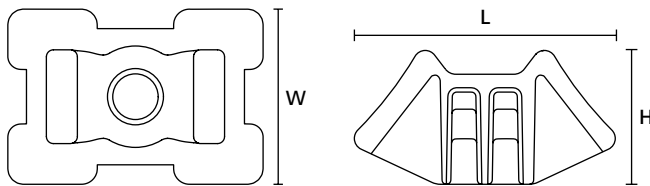

PART NO.	TYPE	Cable Tie Series	Mounting Screw Type	Length (L) in. (mm)	Width (W) in. (mm)	Height (H) in. (mm)	Material	Color	Pkg. Qty.
S2CM258HIRHSH1	S2CM25	T50 - T250	1/4" (M6) Screw	1.8 (45.0)	1.2 (30.0)	0.9 (23.0)	PA66HIRHS	Gray	500
S2CM258HIRHSH2		T50 - T250	1/4" (M6) Screw	1.8 (45.0)	1.2 (30.0)	0.9 (23.0)	PA66HIRHS	Gray	50
S2HM250HIRHSH1	S2HM25	T50 - T250	1/4" (M6) Screw	1.8 (45.0)	1.2 (30.0)	0.9 (23.0)	PA66HIRHSUV	Black	500
S2HM250HIRHSH2		T50 - T250	1/4" (M6) Screw	1.8 (45.0)	1.2 (30.0)	0.9 (23.0)	PA66HIRHSUV	Black	50

Dimensions are approximate and subject to technical changes. Use Part No. for ordering and Type for specification purposes.

Bundling and Securing

Heavy Duty Cable Tie Mounts

Mounts Secured with Mechanical Fasteners - Multiple Bundles

Saddle Mount for the Button Head Tie

HellermannTyton's saddle mounts are designed to be used with button head ties, the saddle mount stands off bundles from frame rails, providing clearance from bolts and other protrusions for protection against abrasion. This mount also allows the flow-through of salt, dirt, and other impurities from the road which prevent unwanted build-up on hoses and harnesses. The tie is snapped into the mount which allows the strap and tie assembly to be pre-installed on the frame rail or panel. The mount can secure three separate bundles, providing parallel spacing between the frame rail and adjacent bundles. The saddle mount is manufactured with a pilot bushing which prevents the cable tie from chafing against the burr edge of the mounting hole.



Features and Benefits

- Secures up to three bundles for multiple routing.
- Provides parallel spacing between frame rail and adjacent bundles to reduce wear.
- Manufactured with a pilot bushing which prevent the cable tie from chafing against the burr edge of the mounting hole.

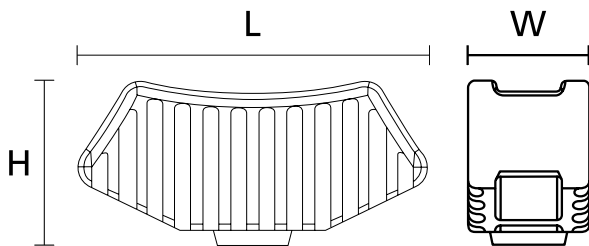

PART NO.	TYPE	Length (L) in. (mm)	Width (W) in. (mm)	Height (H) in. (mm)	Material	Color	Pkg. Qty.
MSBT1200HIRHSH1	MSBT120	1.9 (48.3)	0.7 (16.5)	0.8 (20.6)	PA66HIRHSUV	Black	500
MSBT1200HIRHSX2		1.9 (48.3)	0.7 (16.5)	0.8 (20.6)	PA66HIRHSUV	Black	25

Dimensions are approximate and subject to technical changes. Use Part No. for ordering and Type for specification purposes.

Stud Bolt Mounts

H-Mount Series

HellermannTyton H-Mounts offer a secure bundling solution that utilizes existing frame rail bolts which reduces component costs and improves installation time. The H-mounts have three bundle mounting locations each accommodating ties up to 1/2" wide. H-Mounts fasten with three bolt sizes: 1/2", 5/8", and 3/4". The top tie slot allows the bundle to be positioned directly over the bolt. The two curved tie slots on the sides position the bundles adjacent to the bolt yet away from the frame.

Features and Benefits

- H-Mounts utilize existing frame rail bolts eliminating the need for additional fasteners.
- When used with cable ties, the H-Mounts eliminate the need to carry multiple sizes of fixed bundle diameter clamps which reduces inventory and purchasing costs.
- Top tie slot allows bundles to be positioned in up to three locations, to provide multiple use options.
- Side tie slots are curved to minimize bundle abrasion and position the bundles adjacent to the bolt yet away from the frame.

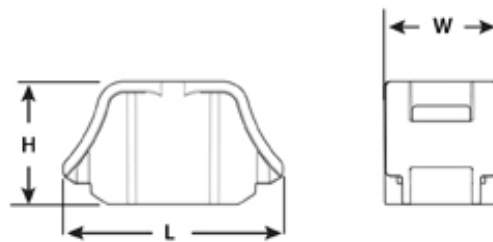

PART NO.	TYPE	Stud Dia. in. (mm)	Length (L) in. (mm)	Width (W) in. (mm)	Height (H) in. (mm)	Material	Color	Pkg. Qty.
151-00973	HM4	0.375 (9.5)	2.0 (50.0)	1.2 (29.8)	1.0 (24.3)	PA66HIRHSUV	Black	900
151-00812	HM5	0.50 (12.7)	2.0 (50.0)	1.0 (26.0)	1.1 (28.0)	PA66HIRHSUV	Black	900
151-00813	HM6	0.625 (15.9)	2.0 (50.0)	1.0 (26.0)	1.1 (28.0)	PA66HIRHSUV	Black	900
151-00814	HM7	0.75 (19.05)	2.0 (50.0)	1.0 (26.0)	1.1 (28.0)	PA66HIRHSUV	Black	900

Dimensions are approximate and subject to technical changes. Use Part No. for ordering and Type for specification purposes.

Stud Bolt Mounts

H-Mount Drill Bit

The H-Mount drill bit applies the H-mount series to studs. Bit fits all 1/4" drills.

Features and Benefits

- Applies easily to tool for quick and easy installation of H-Mounts.



PART NO.	TYPE	Material	Color	Pkg. Qty.
904-00284	HBIT	ST	Black	1

Dimensions are approximate and subject to technical changes. Use Part No. for ordering and Type for specification purposes.

Bundling and Securing

Heavy Duty Cable Tie Mounts

Stud Bolt Mounts

H-Mount Series - Huckspin II Bolt Mounts

HellermannTyton H-Mounts offer a secure bundling solution that utilizes existing frame rail bolts, which reduces component costs and installation times. H-Mounts have three bundle mounting locations, each accommodating ties up to 1/2" wide. These H-Mounts fasten with two Huckspin II bolt sizes: 1/2" and 5/8". The top tie slot allows the bundle to be positioned directly over the bolt. The two curved tie slots on the sides position the bundles adjacent to the bolt yet away from the frame.

Features and Benefits

- H-Mounts utilize existing frame rail bolts eliminating the need for additional fasteners.
- When used with cable ties, the H-Mounts eliminate the need to carry multiple sizes of fixed bundle diameter clamps which reduces inventory and purchasing costs.

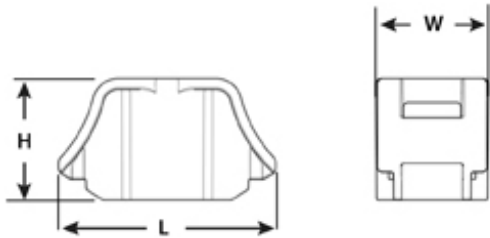

PART NO.	TYPE	Bolt Size in. (mm)	Length (L) in. (mm)	Width (W) in. (mm)	Height (H) in. (mm)	Material	Color	Pkg. Qty.
151-00975	HM5A	1/2 (12.7)	2.0 (50.0)	1.0 (26.0)	1.1 (28.0)	PA66HIRHSUV	Black	900
151-00976	HM6A	5/8 (15.9)	2.0 (50.0)	1.0 (26.0)	1.1 (28.0)	PA66HIRHSUV	Black	900

Dimensions are approximate and subject to technical changes. Use Part No. for ordering and Type for specification purposes.

Fir Tree Mounts

Fir Tree Saddle Mounts

The saddle mount acts as a standoff, elevating bundles above bolt protrusions commonly found in frame rails and panels. A tension tab on the mount allows cable ties to be pre-assembled in a ready position prior to bundles being brought to the mount. The mount can secure up to four separate bundles, providing parallel spacing between the frame rail and adjacent bundles. Fir tree eliminates the need for mounting hardware. For use with HellermannTyton T50-T255 ties.

Features and Benefits

- Heavy duty fir tree mount requires low insertion force and high extraction force.
- Impact modified, heat stabilized, UV material makes it ideal for heavy-duty solutions.

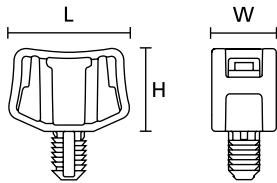

PART NO.	TYPE	Mounting Hole Dia. in. (mm)	Panel Thickness in. (mm)	Length (L) in. (mm)	Width (W) in. (mm)	Height (H) in. (mm)	Material	Color	Pkg. Qty.
S3STM500HIRHSC2	S3STM50	0.5 (12.7 - 13.7)	0.1 - 0.5 (1.9 - 13.0)	2.0 (50.0)	0.9 (22.0)	1.4 (35.0)	PA66HIRHSUV	Black	100
S3STM500HIRHSF1		0.5 (12.7 - 13.7)	0.1 - 0.5 (1.9 - 13.0)	2.0 (50.0)	0.9 (22.0)	1.4 (35.0)	PA66HIRHSUV	Black	250

Dimensions are approximate and subject to technical changes. Use Part No. for ordering and Type for specification purposes.

Endless ways to bundle routings with a single solution? Go configure.

How many ways can you route hoses, pipes, harnesses and cables in automotive and electrical applications? The options are endless – and the varying diameters of bundles add to the complexity of creating a universal solution.

That's why we've developed hundreds of configurations for our open clips and locking clamps. And there's always room for one more.

MADE FOR REAL 

Learn what makes this innovative fastener different from the rest: www.hellermann.tyton.com/MOCFamily



C-Clips

C-Clip with Fir Tree Mount

The C Clip with fir tree mount is ideal for panels with pre-drilled holes. Easy installation by hand eliminates the need for any tools. Once installed, the cable simply snaps into the clip. The cable can be removed and reinstalled without removing the clip. Made from PA66HIRHSUV material, the clip offers increased flexibility along with heat resistance and UV stability.

Features and Benefits

- Pre-drilled holes allows for easy installation by hand.
- Cable can be removed and reinstalled without removing the clip, providing multiple use options.
- Made of PA66HIRHSUV material for withstanding extreme conditions.

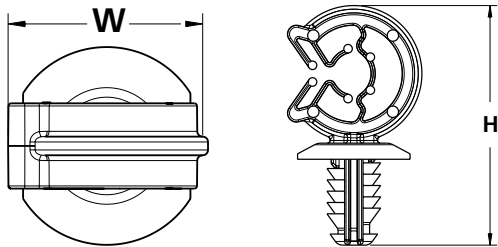

PART NO.	TYPE	Max. Bundle Diameter in. (mm)	Mounting Hole Dia. in. (mm)	Height (H) in. (mm)	Width (W) in. (mm)	Material	Color	Pkg. Qty.
151-00927	SC6.6	0.3 (7.6)	0.3 (6.6)	1.3 (33.4)	0.7 (18.3)	PA66HIRHSUV	Black	100

Dimensions are approximate and subject to technical changes. Use Part No. for ordering and Type for specification purposes.

Screw Mount Clips

Screw Mount Wire Retainer

HellermannTyton's screw mount wire retainer was designed for use in harness board assemblies. These wire retainers "stand-off" wire and cable bundles for easier cable tie application. Wires are individually inserted, and bundles are preformed, making harnessing easier. Can be used in conjunction with HellermannTyton's Auto Tool Systems.

Features and Benefits

- Screw mount wire retainer designed for use in harness board assemblies.
- The wire retainers provide a stand-off to the wire and cable bundles for easier cable tie application.
- Wires are individually inserted, and bundles are preformed, making harnessing easier.



PART NO.	TYPE	Max. Bundle Diameter in. (mm)	Mounting Hole Dia. in. (mm)	Height (H) in. (mm)	Width (W) in. (mm)	Length (L) in. (mm)	Material	Color	Pkg. Qty.
HH-20	HH20	0.8 (20.0)	0.2 (3.9)	2.1 (54.0)	1.2 (31.0)	4.0 (100.0)	PA66	Natural	25

Dimensions are approximate and subject to technical changes. Use Part No. for ordering and Type for specification purposes.

Screw Mount Clips

D-Clip Series

Developed for fixing pipes, cables and hoses, the D-Clips elastic locking system ensures optimal fixing and at the same time, easy removal of the fixed elements by simply pressing the lower latch down and pulling the fixed element.

Features and Benefits

- Available in three sizes, HellermannTyton screw mount clips offer quick, snap-in action.
- These clips allow for easy release for wiring changes or replacements, saving both time and money.

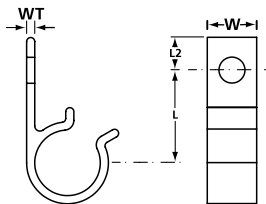

PART NO.	TYPE	Max. Bundle Diameter in. (mm)	Mounting Hole Dia. in. (mm)	Wall Thickness (WT) in. (mm)	Width (W) in. (mm)	Length in. (mm)	Length (L2) in. (mm)	Material	Color	Pkg. Qty.
D10H4	8D10	0.4 (10.0)	0.3 (8.0)	0.1 (2.0)	0.6 (15.0)	0.7 (17.0)	0.3 (8.0)	POM	Black	500
D15L4	8D15	0.6 (15.0)	0.3 (8.0)	0.1 (2.0)	0.6 (15.0)	1.0 (25.0)	0.4 (10.0)	POM	Black	200
D20L4	8D20	0.8 (20.0)	0.3 (8.0)	0.1 (2.5)	0.6 (15.0)	1.1 (28.0)	0.4 (10.0)	POM	Black	200

Dimensions are approximate and subject to technical changes. Use Part No. for ordering and Type for specification purposes.

Bundling and Securing

Clips

Nail Clips

Nail Clips

HellermannTyton nail clips are easy to use and highly reliable. Tough, precision engineered Nail Clips hold wire and cable securely in place. The nail is made of hardened steel for driving into wood, masonry joints, cinder block, and mortar. The nail clips do not have sharp edges, which reduces the chance of cutting cable jackets or sheaths, causing signal loss. Available in white or black.

Features and Benefits

- Hardened steel nail allows easy installation into wood, masonry joints, cinder block and mortar.
- No sharp edges reduce risk of cutting cables or sheaths.

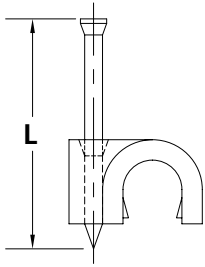

PART NO.	TYPE	Nominal Dia. in. (mm)	Description	Length (L) in. (mm)	Material	Color	Pkg. Qty.
FC140	FC14	1/2 (14.0)	RG59 and RG6 Flat twin and ground	1.0 (25.0)	PE, ST	Black	100
FC1410		1/2 (14.0)	RG59 and RG6 Flat twin and ground	1.0 (25.0)	PE, ST	White	100
NC70	NC7	1/4 (7.0)	RG6 and RG59 Double shielded	0.8 (20.0)	PE, ST	Black	100
NC710		1/4 (7.0)	RG6 and RG59 Double shielded	0.8 (20.0)	PE, ST	White	100
NC60	NC6	1/4 (6.0)	Telecom, 6 pair, RG59	0.6 (16.0)	PE, ST	Black	100
NC610		1/4 (6.0)	Telecom, 6 pair, RG59	0.6 (16.0)	PE, ST	White	100
NC3.50	NC3.5	1/8 (3.5)	14# Ground wire, telecom, 1 pair	0.6 (16.0)	PE, ST	Black	100
NC3.510		1/8 (3.5)	14# Ground wire, telecom, 1 pair	0.6 (16.0)	PE, ST	White	100
NC90	NC9	3/8 (9.0)	Telecom, 12 pair	0.8 (20.0)	PE, ST	Black	100
NC910		3/8 (9.0)	Telecom, 12 pair	0.8 (20.0)	PE, ST	White	100
NC50	NC5	3/16 (5.0)	Telecom, 4 pair	0.6 (16.0)	PE, ST	Black	100
NC510		3/16 (5.0)	Telecom, 4 pair	0.6 (16.0)	PE, ST	White	100
NC80	NC8	5/16 (8.0)	Telecom, 10 pair RG7 and RG6 double and quad shielded	0.8 (20.0)	PE, ST	Black	100
NC810		5/16 (8.0)	Telecom, 10 pair RG7 and RG6 double and quad shielded	0.8 (20.0)	PE, ST	White	100
NC110	NC11	7/16 (11.0)	Telecom, 25 pair	1.0 (25.0)	PE, ST	Black	100
NC1110		7/16 (11.0)	Telecom, 25 pair	1.0 (25.0)	PE, ST	White	100

Dimensions are approximate and subject to technical changes. Use Part No. for ordering and Type for specification purposes.

Pipe and Hose Clips

Fir Tree Mount Tube Clip

Designed to offer a durable single-hole mounting, this tube clip allows the installer to insert the fir tree with minimal force while providing a secure hold.

Features and Benefits

- Clip is designed for fixation and bundling of tubes and pipes.

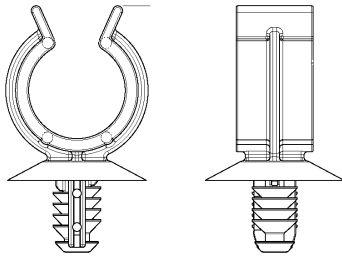

PART NO.	TYPE	Max. Bundle Diameter in. (mm)	Mounting Hole Dia. in. (mm)	Min. Panel Thickness in. (mm)	Max. Panel Thickness in. (mm)	Height in. (mm)	Width in. (mm)	Material	Color	Pkg. Qty.
PC15FT7	PC15FT7	0.6 (15.7)	0.25 - 0.27 (6.4 - 6.8)	0.04 (1.0)	0.31 (6.0)	1.5 (38.1)	0.9 (21.6)	PA66HIRHSUV	Black	1000

Dimensions are approximate and subject to technical changes. Use Part No. for ordering and Type for specification purposes.

Bundling and Securing

Self-Affixing Clips

Bundling Clips

Straight Mini Channels

The mini channel family allows a cost effective routing solution that provides protection and configurable routing. Pieces are modular and interchangeable, providing high levels of customization. Mini channels replace engineered channels that are costly to design and develop.

Features and Benefits

- U-Shape channel that provides 3 sides of protection for wire or bundle.
- High-quality polypropylene material with high heat resistance.



PART NO.	TYPE	Length (L) in. (mm)	Width (W) in. (mm)	Height (H) in. (mm)	Material	Color	Pkg. Qty.	Drawing
133-01476	MINICHNLU	2.0 (50.0)	1.2 (30.0)	0.3 (8.0)	PPT20	Black	3000	

Dimensions are approximate and subject to technical changes. Use Part No. for ordering and Type for specification purposes.

Bundling Clips

Angled Mini Channels

The mini channel family allows a cost effective routing solution that provides protection and configurable routing. Pieces are modular and interchangeable, providing high levels of customization. Mini channels replace engineered channels that are costly to design and develop.

Features and Benefits

- Angled channel allows specific guidance around corners or obstructions.
- U-Shape channel provides three sides of protection for wire or bundle.
- High-quality polypropylene material with high heat resistance.
- Protects against abrasion and other environmental factors.



PART NO.	TYPE	Length (L) in. (mm)	Width (W) in. (mm)	Height (H) in. (mm)	Mounting Hole Dia. in. (mm)	Material	Color	Pkg. Qty.	Drawing
133-01480	45MINICHNL	2.1 (52.0)	1.1 (28.5)	0.1 (1.5)	-	PPT20	Black	4000	
133-01478	45MINICHNL2	3.5 (89.7)	1.9 (47.6)	0.1 (1.5)	0.25 - 0.26 (6.4 - 6.7)	PPT20	Black	900	
133-01479	90MINICHNL	1.5 (38.5)	1.5 (38.5)	0.1 (1.5)	-	PPT20	Black	3500	
133-01477	90MINICHNL2	2.5 (63.5)	2.5 (63.5)	0.1 (1.5)	0.25 - 0.26 (6.4 - 6.7)	PPT20	Black	1600	

Dimensions are approximate and subject to technical changes. Use Part No. for ordering and Type for specification purposes.

Bundling and Securing

Self-Affixing Clips

Bundling Clips

90-Degree Fir Tree Mini Channels

HellermannTyton's Bundling Clips create a solution that allows the harness to be routed around a corner and fixated into the panel at this location.

Features and Benefits

- The 90-degree configuration of this mini channel creates a solution for routing a wire harness around a corner.
- Design allows the mini channel to be used with a wide range of panel thicknesses and hole diameters.



PART NO.	TYPE	Width (W) in. (mm)	Height (H) in. (mm)	Panel Thickness in. (mm)	Mounting Hole Dia. in. (mm)	Material	Color	Pkg. Qty.	Drawing
151-00993	BC90FT6	0.4 (10.0)	1.0 (26.2)	0.02 – 0.23 (0.7 – 6.0)	0.2 - 0.3 (6.1 - 6.9)	PA66HIRHS	Black	2000	
151-01051	BC90FT6B	1.2 (30.5)	1.0 (24.5)	0.02 – 0.22 (0.6 – 5.5)	0.2 - 0.3 (6.1 - 6.9)	PA66HIRHS	Black	4000	

Dimensions are approximate and subject to technical changes. Use Part No. for ordering and Type for specification purposes.

Bundling Clips

90-Degree Arrowhead Mini Channels

HellermannTyton's Bundling Clips create a solution that allows the harness to be routed around a corner, and fixated into the panel at this location.

Features and Benefits

- The 90-degree configuration of this mini channel creates a solution for routing a wire harness around a corner.

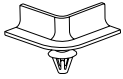
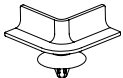

PART NO.	TYPE	Length (L) in. (mm)	Width (W) in. (mm)	Height (H) in. (mm)	Panel Thickness in. (mm)	Mounting Hole Dia. in. (mm)	Material	Color	Pkg. Qty.	Drawing
151-01109	BC90AH2	1.2 (29.5)	0.4 (10.0)	0.9 (23.6)	0.04 – 0.06 (1.0 – 1.5)	0.2 (6.5)	PA66HIRHSUV	Black	4000	
151-00994	BC90AH	1.2 (29.5)	0.4 (10.0)	1.0 (24.0)	0.02 – 0.07 (0.5 – 1.8)	0.2 (6.5)	PA66HIRHSUV	Black	4000	

Dimensions are approximate and subject to technical changes. Use Part No. for ordering and Type for specification purposes.

Bundling and Securing

Self-Affixing Clips

Bundling Clips

Standard Bundling Clips

HellermannTyton Bundling Clips are designed to provide simple and easy methods for securing cable bundles, hoses, or pipes. They are fastened onto the tape bar using tape or cable ties.

Features and Benefits

- The different fixing orientations allow tape clips to be used with a wide range of panel thicknesses and hole diameters.

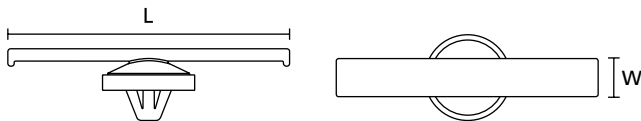

PART NO.	TYPE	Tape Bar Length (L) in. (mm)	Panel Thickness in. (mm)	Min. Mounting Hole Dia. in. (mm)	Max. Mounting Hole Dia. in. (mm)	Material	Color	Pkg. Qty.	Drawing
150-95500	TC5FT6S	1.5 (37.0)	0.03 – 0.06 (0.75 – 1.5)	0.26 (6.4)	0.28 (7.1)	PA66HIRHS	Black	1000	
102-69067	ATSBCKSFT6.5	1.5 (39.0)	0.03 – 0.05 (0.7 – 1.3)	0.25 (6.3)	0.26 (6.7)	PA66HIRHS	Black	500	
151-00651	TC6FT6LG	1.5 (39.3)	0.03 – 0.71 (0.7 – 18.0)	0.24 (6.8)	0.24 (6.2)	PA66HIRHS	Natural	2000	
151-00663	TC6FT6	1.5 (38.1)	0.03 – 0.71 (0.7 – 5.75)	0.24 (6.8)	0.27 (6.2)	PA66HIRHS	Black	10000	
151-01884	BCSFTOVAL2	1.5 (38.7)	0.02 – 0.10 (0.6 – 2.5)	0.24 (6.2)	0.51 (13.0)	PA66HIRHSUV	Natural	8000	
151-01240	BCFTOVAL2	1.5 (38.7)	0.02 – 0.24 (0.6 – 6.0)	0.24 (6.2)	0.51 (13.0)	PA66HIRHS	Natural	10000	
155-16301	WICKELCLIP-VDS	1.6 (40.0)	0.02 – 0.10 (0.6 – 2.5)	0.25 (6.3)	0.35 (9.0)	PA66HIRHS	Black	1000	
150-08110	CHA1	2.1 (54.0)	0.02 – 0.05 (0.5 – 1.2)	0.25 (6.3)	0.26 (7.0)	PA66HS	Black	500	
151-02901	CHA2	2.1 (54.0)	0.02 – 0.08 (0.8 – 2.0)	0.26 (6.5)	0.28 (7.0)	PA66	Black	500	
155-30802	TC2FT6LG	2.2 (55.0)	0.02 – 0.20 (0.6 – 5.1)	0.25 (6.3)	0.28 (7.0)	PA66HIRHS	Black	14000	
155-11601	BCSFT6.5 16-3MD	2.2 (55.0)	0.06 – 0.12 (1.5 – 3.0)	0.25 (6.3)	0.26 (6.7)	PA66HIRHS	Black	500	
151-00029	TCOP70x120	2.2 (55.0)	0.02 – 0.24 (0.6 – 6.0)	0.28 (7.0)	0.47 (12.0)	PA66HIRHS	Black	5000	

Dimensions are approximate and subject to technical changes. Use Part No. for ordering and Type for specification purposes.

Bundling Clips

Standard Bundling Clips

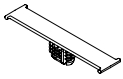
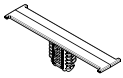
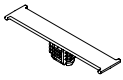
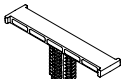
PART NO.	TYPE	Tape Bar Length (L) in. (mm)	Panel Thickness in. (mm)	Min. Mounting Hole Dia. in. (mm)	Max. Mounting Hole Dia. in. (mm)	Material	Color	Pkg. Qty.	Drawing
151-01883	BCSFTOVAL	2.3 (58.0)	0.02 – 0.10 (0.6 – 2.5)	0.24 (6.2)	0.51 (13.0)	PA66HIRHSUV	Natural	8000	
151-01403	BCFTOVAL	2.3 (58.0)	0.02 – 0.24 (0.5 – 6.0)	0.24 (6.2)	0.51 (13.0)	PA66HIRHS	Black	8000	
151-01239		2.3 (58.0)	0.02 – 0.24 (0.6 – 6.0)	0.24 (6.2)	0.51 (13.0)	PA66HIRHS	Natural	8000	
151-01888	BCFTOVALXL	2.3 (58.0)	0.02 – 0.43 (0.6 – 11.0)	0.24 (6.2)	0.51 (13.0)	PA66HIRHSUV	Natural	3000	

Dimensions are approximate and subject to technical changes. Use Part No. for ordering and Type for specification purposes.

Bundling and Securing

Self-Affixing Clips

Bundling Clips

Standoff Bundling Clips

Standoff bundling clips provide a straightforward way to secure cable bundles, hoses or pipes. The bundle fastens to the tape bar using tape or cable ties. Multiple orientations allow tape clips to be used with a wide range of panel thicknesses and hole diameters. Standoff keeps bundles away from mounting area to prevent them from damage due to rubbing.

Features and Benefits

- Clip can be installed by hand – no need for hardware or tools.
- Design provides low insertion and high extraction force, for simple, secure performance.
- Clip keeps bundle away from areas that could cause damage due to rubbing.

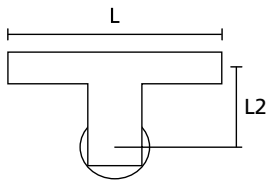



PART NO.	TYPE	Length (L) in. (mm)	Panel Thickness in. (mm)	Mounting Hole Dia. in.	Mounting Hole Dia. (mm)	Offset Length (L2) in. (mm)	Material	Color	Pkg. Qty.	Drawing
151-00077	CH20D6	2.0 (50.0)	0.03 – 0.06 (0.6 – 1.4)	0.25 - 0.28	(6.4 - 7.0)	0.8 (20.0)	PA66HS	Black	100	
151-02600	CH20D7	2.0 (50.0)	0.03 – 0.06 (0.6 – 1.4)	0.25 - 0.28	(6.4 - 7.0)	0.8 (20.0)	PA66	Black	100	
150-09201	COW20DP7	0.8 (42.0)	0.03 – 0.18 (0.8 – 4.5)	0.25 - 0.28	(6.4 - 6.8)	0.8 (20.0)	PA66	Brown	500	
151-00080	COW30DP7	1.7 (43.2)	0.03 – 0.18 (0.8 – 4.5)	0.25 - 0.28 0.24 - 0.26	(6.3 - 7.0), (6.1 - 6.6) (hexagonal)	1.2 (30.0)	PA66HS	Black	500	
155-30902	SOC4 M.FT6	2.2 (55.0)	0.03 – 0.20 (0.7 – 5.1)	0.25 - 0.28	(6.5 - 7.0)	0.8 (20.0)	PA66HIRHS	Black	500	
151-00074	SOC5FT6LG	2.2 (55.0)	0.03 – 0.20 (0.7 – 5.1)	0.25 - 0.28 0.24 - 0.26	(6.5 - 7.0), (6.1 - 6.6) (hexagonal)	0.5 (13.0)	PA66HIRHS	Black	500	
151-00023	SOC6	2.2 (55.0)	0.03 – 0.14 (0.8 – 3.5)	0.25 - 0.28 0.24 - 0.26	(6.3 - 7.0), (6.1 - 6.6) (hexagonal)	0.9 (22.0)	PA66HIRHS	Black	500	
151-00629	SOC7FT6	2.2 (56.0)	0.03 – 0.22 (0.7-5.75)	0.25 - 0.27	6.4 - 7.1)	1.2 (31.0)	PA66HIRHSUV	Black	3000	
151-00650	SOC8FT6	2.2 (61.0)	0.03 – 0.22 (0.7 – 5.75)	0.24 - 0.27	(6.2 - 6.8)	0.6 (15.9)	PA66HIRHS	Natural	2000	

Dimensions are approximate and subject to technical changes. Use Part No. for ordering and Type for specification purposes.

Bundling Clips

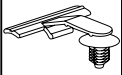
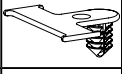
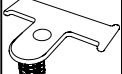
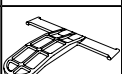
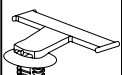
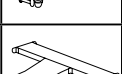
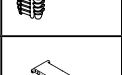
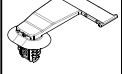
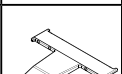

Standoff Bundling Clips

PART NO.	TYPE	Length (L) in. (mm)	Panel Thickness in. (mm)	Mounting Hole Dia. in.	Mounting Hole Dia. (mm)	Offset Length (L2) in. (mm)	Material	Color	Pkg. Qty.	Drawing
151-00665	SOC8FT6LG	1.6 (40.0)	0.03 – 0.23 (0.7 – 5.75)	0.26 - 0.28	(6.5 - 7.0)	0.9 (22.0)	PA66HIRHS	Black	1000	
151-01153	SOC9FT6	1.4 (35.5)	0.02 – 0.24 (0.51 – 6.1)	0.24 - 0.27	(6.1 - 6.9)	0.8 (20.3)	PA66HIRHSUV	Natural	4000	
151-01154	SOC9FT6XLG	1.4 (35.5)	0.02 – 0.09 (0.51 – 12.3)	0.24 - 0.27	(6.1 - 6.9)	0.6 (15.8)	PA66HIRHS	Natural	5000	
151-00903	SOC10FT6LG	2.3 (58.0)	0.02 – 0.23 (0.6 - 5.75)	0.24 x 0.27	(6.1 - 6.9), 6.35) (hexagonal)	1.7 (43.4)	PA66HIRHS	Natural	3000	
151-00992	SOC11FTOVAL	2.0 (50.2)	0.02 – 0.27 (0.51 – 6.86)	0.24 x 0.48 0.26 x 0.50 0.26 x 0.51 0.28 x 0.47	(6.2 x 12.2), (6.5 x 12.5), (6.5 x 13.0), (7.0 x 12.0)	0.8 (20.0)	PA66HIRHS	Black	3000	
151-00932		2.0 (50.2)	0.02 – 0.27 (0.51 – 6.86)	0.24 x 0.48 0.25 x 0.50 0.25 x 0.50 0.27 x 0.47	(6.2 x 12.2), (6.5 x 12.5), (6.5 x 13.0), (7.0 x 12.0)	0.8 (20.0)	PA66HIRHS	Natural	3000	
151-01117	SOC12FTOVAL	2.0 (50.0)	0.02 – 0.27 (0.51 – 6.86)	0.24 x 0.48 0.26 x 0.50 0.26 x 0.51 0.28 x 0.47	(6.2 x 12.2), (6.5 x 12.5), (6.5 x 13.0), (7.0 x 12.0)	1.3 (32.0)	PA66HIRHS	Black	1500	
151-01238		2.0 (50.0)	0.02 – 0.27 (0.51 – 6.86)	0.24 x 0.48 0.25 x 0.50 0.25 x 0.50 0.27 x 0.47	(6.2 x 12.2), (6.5 x 12.5), (6.5 x 13.0), (7.0 x 12.0)	1.3 (32.0)	PA66HIRHS	Natural	1500	
151-01125	SOC13FT6LGL	1.7 (43.2)	0.02 – 0.23 (0.6 - 5.75)	0.24 - 0.27	(6.1 - 6.9), 6.35) (hexagonal)	0.8 (20.3)	PA66HIRHS	Gray	5000	
151-01126	SOC13FT6LGR	1.7 (43.2)	0.02 – 0.23 (0.51 – 5.8)	0.24 - 0.27	(6.1 - 6.9)	0.8 (20.3)	PA66HIRHSUV	Black	5000	

Dimensions are approximate and subject to technical changes. Use Part No. for ordering and Type for specification purposes.

Bundling Clips

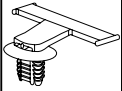
Standoff Bundling Clips

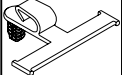
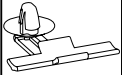
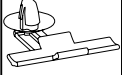
PART NO.	TYPE	Length (L) in. (mm)	Panel Thickness in. (mm)	Mounting Hole Dia. in.	Mounting Hole Dia. (mm)	Offset Length (L2) in. (mm)	Material	Color	Pkg. Qty.	Drawing
151-01018	SOC13FTOVAL	2.0 (50.0)	0.02 – 0.16 (0.6 – 4.0)	0.24 x 0.48 0.25 x 0.50 0.25 x 0.50 0.27 x 0.47	(6.2 x 12.2), (6.5 x 12.5), (6.5 x 13.0), (7.0 x 12.0)	0.8 (20.0)	PA66HIRHS	Black	1000	
133-01497	SOC14FT6	1.8 (45.0)	0.02 – 0.20 (0.51 – 5.08)	0.24 - 0.27	(6.1 - 6.9)	0.8 (20.3)	PA66HIRHSUV	Natural	5000	
151-00623	SOCHFT6	2.2 (56.0)	0.03 – 0.22 (0.76 – 5.59)	0.25 - 0.27	(6.35 - 7.0)	1.2 (31.0)	PA66HIRHSUV	Black	1500	
150-45397	STAND OFF CLIP	1.6 (40.0)	0.02 – 0.06 (0.4 – 1.6)	0.26 - 0.27	(6.5 - 6.8)	1.2 (31.0)	PA66HIRHS	Black	500	
155-01600	STAND-OFF-CLIP-2	1.6 (40.0)	0.02 – 0.06 (0.4 – 1.6)	0.26 - 0.27	(6.5 - 6.8)	1.0 (25.0)	PA66HIRHS	Black	500	

Dimensions are approximate and subject to technical changes. Use Part No. for ordering and Type for specification purposes.

Bundling Clips



Stud Mount Bundling Clips

HellermannTyton Stud Mount Bundling Clips are easily inserted on a 5mm stud and secure the bundle away from the mounting hole. They are designed to provide simple and easy methods of securing cable bundles, hoses, or pipes. They are fastened onto the tape bar using tape or cable ties.

Features and Benefits

- Tape clips are designed to provide simple and easy methods of securing cable bundles, hoses, or pipes.
- They are fastened onto the tape bar using tape or cable ties.
- The different fixing orientations allow tape clips to be used with a wide range of panel thicknesses and hole diameters.

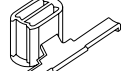

PART NO.	TYPE	Length (L) in. (mm)	Stud Dia. in. (mm)	Weld Distance Stud to Bundle in. (mm)	Material	Color	Pkg. Qty.	Drawing
151-00016	BC30	2.2 (55.0)	0.2 (5.0)	1.9 (30.0)	PA66HIRHS	Black	1000	
151-00017	BC2212	2.2 (55.0)	0.2 (5.0)	0.9 (22.8)	PA66HIRHS	Black	1000	
151-26101	TC-SB5C	2.2 (55.0)	0.2 (5.0)	0.5 (12.5)	PA66HS	Black	500	

Dimensions are approximate and subject to technical changes. Use Part No. for ordering and Type for specification purposes.

Bundling and Securing

Self-Affixing Clips

Connector Clips

Connector Clips

Connector Clips feature various attachment point configurations to accommodate the many connectors on the market. They are first mated with a connector on a wire harness or cable assembly, then secured to a surface using the integrated mount. With so many configurations available, attachment surfaces can be a hole, stud or even another harness assembly.

Features and Benefits

- HellermannTyton Connector Clips provide a single method to mount connectors to various surfaces in a variety of applications.
- Highly engineered designs feature anti-rattle discs, anti-rotation oval fir trees and clamps for mounting on edges.
- An assortment of Connector Clips is available to fit the variety of connector slot designs made by most of the largest global connector manufacturers.



PART NO.	TYPE	Panel Thickness in. (mm)	Mounting Hole Dia. in. (mm)		Material	Color	Pkg. Qty.
151-00513	YCCSFT62122	0.02 - 0.04 (0.6 - 1.0)	0.24 - 0.48	(6.2 x 12.2)	PA66HIRHS	Black	500
151-01033	CCOVAL6	0.02 - 0.12 (0.6 - 3.0)	0.24 x 0.48 0.25 x 0.50 0.25 x 0.50 0.27 x 0.47	(6.2 x 12.2), (6.5 x 12.5), (6.5 x 13.0), (7.0 x 12.0)	PA66HIRHS	Black	4000
155-36002	STECKERHALTER SITZ	0.02 - 0.12 (0.6 - 3.0)	0.26 - 0.28	(6.5 - 7.0)	PA66HIRHS	Black	1000
151-00180	YCCFT62x122	0.02 - 0.24 (0.6 - 6.0)	0.24 x 0.48	(6.2 x 12.2)	PA66HIRHS	Black	1000
151-01108	CCOVAL2	0.02 - 0.24 (0.6 - 6.0)	0.24 x 0.48 0.25 x 0.50 0.25 x 0.50 0.27 x 0.47	(6.2 x 12.2), (6.5 x 12.5), (6.5 x 13.0), (7.0 x 12.0)	PA66HIRHS	Black	5000
151-00925	CCOVAL	0.02 - 0.24 (0.6 - 6.0)	0.24 x 0.48 0.25 x 0.50 0.25 x 0.50 0.27 x 0.47	(6.2 x 12.2), (6.5 x 12.5), (6.5 x 13.0), (7.0 x 12.0)	PA66HIRHS	Black	5000
151-01259		0.02 - 0.24 (0.5 - 6.0)	0.24 x 0.48 0.26 x 0.50 0.26 x 0.51 0.28 x 0.47	(6.2 x 12.2), (6.5 x 12.5), (6.5 x 13.0), (7.0 x 12.0)	PA66HIRHS	Natural	5000
151-00765	CC09	0.02 - 0.25 (0.6 - 6.4)	0.35 x 0.67	(9.0 x 17.0)	PA66HIRHS	Black	1000
151-01136	CC12	0.02 - 0.26 (0.5 - 6.5)	0.31 x 0.59	(8.0 x 15.0)	PA66HIRHS	Black	4000
151-01244	CCOVAL3	0.02 - 0.27 (0.5 - 6.8)	0.24 x 0.48 0.26 x 0.50 0.26 x 0.51 0.28 x 0.47	(6.2 x 12.2), (6.5 x 12.5), (6.5 x 13.0), (7.0 x 12.0)	PA66HIRHS	Black	3500
151-01286	CCOVAL5	0.02 - 0.27 (0.5 - 6.8)	0.24 x 0.48 0.26 x 0.50 0.26 x 0.51 0.28 x 0.47	(6.2 x 12.2), (6.5 x 12.5), (6.5 x 13.0), (7.0 x 12.0)	PA66HIRHS	Black	4000

Dimensions are approximate and subject to technical changes. Use Part No. for ordering and Type for specification purposes.

Connector Clips

Connector Clips

PART NO.	TYPE	Panel Thickness in. (mm)	Mounting Hole Dia. in. (mm)		Material	Color	Pkg. Qty.
151-01246	CCOVAL4	0.02 - 0.27 (0.5 - 6.8)	0.24 x 0.48 0.26 x 0.50 0.26 x 0.51 0.28 x 0.47	(6.2 x 12.2), (6.5 x 12.5), (6.5 x 13.0), (7.0 x 12.0)	PA66HIRHS	Black	5000
151-00835	YCCKSFT62x122PT0.7-1.3	0.03 - 0.05 (0.7 - 1.3)	0.24 - 0.48	(6.2 x 12.2)	PA66HIRHS	Black	10000
151-00833	YCCKSFT62x122PT0.7-1.3 90°	0.03 - 0.05 (0.7 - 1.3)	0.24 x 0.48	(6.2 x 12.2)	PA66HIRHS	Black	10000
151-00785	CCFT6LG	0.03 - 0.16 (0.7 - 4.0)	0.24 - 0.26	(6.0 - 6.7)	PA66HIRHS	Black	5000
155-30702	FT6LG.YAZ.CONNECT-TS	0.03 - 0.2 (0.7 - 5.1)	0.25 - 0.28	(6.4 - 7.1)	PA66HIRHS	Black	500
155-32602	FT6LG.M.St.Aufn.II	0.03 - 0.2 (0.8 - 5.0)	0.26 - 0.28	(6.5 - 7.0)	PA66HIRHS	Black	500
151-00677	CC08	0.03 - 0.23 (0.8 - 5.75)	0.08 x 0.26	6.25 - 6.75)	PA66HIRHS	Natural	5000
155-03800	FT6LG-AMP	0.03 - 0.24 (0.7 - 6.0)	0.26 - 0.28	(6.5 - 7.0)	PA66HIRHS	Black	500
151-00786	CCFT6XLG	0.03 - 0.43 (0.7 - 11.0)	0.24 - 0.26	(6.0 - 6.7)	PA66HIRHS	Black	5000
155-38102	YCC-FT6-S	0.04 - 0.06 (0.8 - 1.5)	0.26 - 0.28	(6.5 - 7.0)	PA66HIRHS	Black	500
151-00464	EC6mod	0.04 - 0.12 (1.0 - 3.0)	-	-	PA66HIRHS	Black	1000
151-01113	EC46	0.04 - 0.12 (1.0 - 3.0)	-	-	PA66HIRHSUV	Black	5000
151-00620	CCIISFT6.5x13	0.04 - 0.12 (0.7 - 3.0)	0.26 - 0.51	(6.5 x 13.0)	PA66HIRHS	Black	500
151-00459	FT6LG.JAE.CONNECT.TS	0.04 - 0.20 (0.7 - 5.1)	0.26 - 0.28	(6.5 - 7.0)	PA66HIRHS	Black	500
151-00235	Big YCC TS	0.04 - 0.20 (0.7 - 5.1)	0.26 - 0.28	(6.4 - 7.1)	PA66HIRHS	Black	500
151-00430	EC43	0.06 - 0.16 (1.5 - 4.0)	-	-	PA66HIRHS	Black	500
151-00429	EC42	0.06 - 0.16 (1.5 - 4.0)	-	-	PA66HIRHS	Black	500
151-00836	YCCKSFT62x122PT1.7-2.3	0.07 - 0.09 (1.7 - 2.3)	0.24 - 0.48	(6.2 x 12.2)	PA66HIRHS	Black	10000
151-00834	YCCKSFT62x122PT1.7-2.3 90°	0.07 - 0.09 (1.7 - 2.3)	0.24 - 0.48	(6.2 x 12.2)	PA66HIRHS	Black	10000
151-00775	CCSFT6.5	0.07 - 0.09 (1.7 - 2.3)	0.25 - 0.26	(6.3 - 6.7)	PA66HIRHS	Black	5000
151-00194	CCSFT7x12	0.08 - 0.31 (0.8 - 2.0)	0.28 - 0.47	(7.0 x 12.0)	PA66HIRHS	Black	500
151-00499	ECC1CPT	0.12 - 0.31 (3.0 - 6.0)	-	-	PA66HIRHS	Black	500

Dimensions are approximate and subject to technical changes. Use Part No. for ordering and Type for specification purposes.

Bundling and Securing

Self-Affixing Clips

Edge Clips



Edge Clip and Tape Clip Combination

HellermannTyton's edge clips are designed specifically to route bundles by securing them to the edge of a plastic or metal sheet without the need for a mounting hole. These edge clips are molded to a tape bar, which can be secured to cables with cable ties or tape. The clip is easy to secure, and the extraction force is high due to the integrated metal clamp that holds the edge clip in place.

Features and Benefits

- Edge clip applies easily to plastic and metal edges without the need for a mounting hole.
- Tape bar provides a convenient surface for securing a bundle using a cable tie or tape.

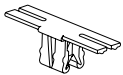
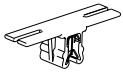
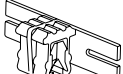
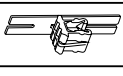
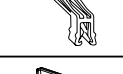
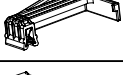

PART NO.	TYPE	Panel Thickness in. (mm)	Length (L) in. (mm)	Width (W) in. (mm)	Material	Color	Pkg. Qty.	Drawing
151-03404	EC14	0.04 – 0.12 (1.0 – 3.0)	1.6 (40.0)	0.4 (10.0)	PA66HIRHS	Black	500	
151-03401	EC15	0.04 – 0.12 (1.0 – 3.0)	1.6 (40.0)	0.4 (10.0)	PA66HIRHS	Black	500	
151-03402	EC16	0.04 – 0.12 (1.0 – 3.0)	1.6 (40.0)	0.4 (10.0)	PA66HIRHS	Black	500	
151-03403	EC17	0.04 – 0.12 (1.0 – 3.0)	1.8 (46.5)	0.4 (10.0)	PA66HIRHS	Black	500	
EC30.HB6P	EC30	0.04 – 0.12 (1.0 – 3.0)	2.0 (50.0)	0.4 (9.0)	PA66HIRHS	Black	500	
151-00152	EC31	0.04 – 0.12 (1.0 – 3.0)	2.4 (60.0)	0.4 (9.0)	PA66HIRHS	Black	500	
151-01206	EC48	0.12 – 0.24 (3.0 – 6.0)	2.0 (50.0)	1.2 (29.7)	PA66HIRHS	Black	5000	

Dimensions are approximate and subject to technical changes. Use Part No. for ordering and Type for specification purposes.

Edge Clips

90° Metal Edge Clip

HellermannTyton's 90-Degree Metal Edge Clip provides an excellent alternative to managing wire and PV cables where plastic fasteners are not the preferred method. Designed for effortless insertion, this edge clip also has a high extraction force. The 90-degree configuration secures cables to a panel in a perpendicular orientation. Metal construction tolerates extreme environments, and a low-profile design allows the clip to be installed on a wide variety of module edges.

Features and Benefits

- Integrated design allows for easy insertion by hand.
- 1.5–2mm panel thickness range allows for multiple applications.
- Double-compression design that accommodates various sizes of wire and cable.
- Presents a high extraction force for withstanding extreme conditions.

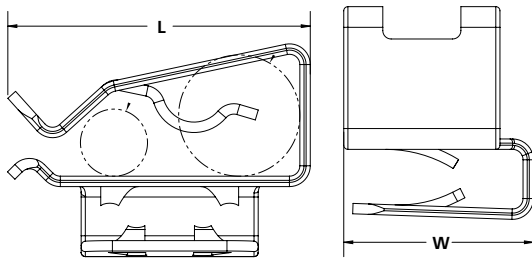

PART NO.	TYPE	Min. Panel Thickness in. (mm)	Max. Panel Thickness in. (mm)	Min. Cable Diameter in. (mm)	Max. Cable Diameter in. (mm)	Length (L) in. (mm)	Width (W) in. (mm)	Material	Color	Pkg. Qty.
151-02189*	MSC90	0.06 (1.5)	0.078 (2.0)	0.2 (4.1)	0.3 (7.0)	0.7 (18.4)	0.5 (11.6)	SS304	Metal	100

Dimensions are approximate and subject to technical changes. Use Part No. for ordering and Type for specification purposes.
 *This product meets UL standards. Please see appendix for specific file numbers.

Bundling and Securing

Self-Affixing Clips

Edge Clips

Heavy Duty Metal Edge Clip

HellermannTyton's Heavy Duty Metal Edge Clip provides an excellent alternative to managing wire and PV cables where plastic fasteners are not the preferred method. Designed for effortless insertion, the Heavy Duty Edge Clip has a high extraction force that tolerates extreme environments and provides assurance that the cables are secure on a panel. This Metal Edge Clip is simple to install and can easily be removed with a flathead screwdriver.

Features and Benefits

- Integrated design allows for easy insertion by hand.
- 1–3mm panel thickness range allows for multiple applications.
- Double-compression design that accommodates various sizes of wire and cable.
- Presents a high extraction force for withstanding extreme conditions.



PART NO.	TYPE	Panel Thickness in. (mm)	Min. Cable Diameter in. (mm)	Max. Cable Diameter in. (mm)	Length (L) in. (mm)	Width (W) in. (mm)	Material	Color	Pkg. Qty.
151-00982*	MSC2	0.0 - 0.1 (1.0 - 3.0)	0.2 (5.0)	0.3 (7.6)	1.0 (24.1)	0.5 (13.0)	SS304	Metal	100

Dimensions are approximate and subject to technical changes. Use Part No. for ordering and Type for specification purposes.
 *This product meets UL standards. Please see appendix for specific file numbers.

Edge Clips

Low Profile Metal Edge Clip

Designed for more confined areas, HellermannTyton's Low Profile Metal Edge Clip provides an excellent alternative to managing wire and PV cables where plastic fasteners are not the preferred method. Designed for effortless insertion, the Metal Edge Clip has a high extraction force that tolerates extreme environments and provides assurance that the cables are secure on a panel. The Metal Edge Clip is simple to install and can easily be removed with a flathead screwdriver.

Features and Benefits

- Integrated design allows for easy insertion by hand.
- 1.5–2.0mm panel thickness range allows for multiple applications.
- Double-compression design that accommodates various sizes of wire and cable.
- Presents a high extraction force for withstanding extreme conditions.

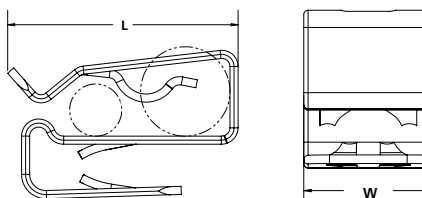

PART NO.	TYPE	Panel Thickness in. (mm)	Min. Cable Diameter in. (mm)	Max. Cable Diameter in. (mm)	Length (L) in. (mm)	Width (W) in. (mm)	Material	Color	Pkg. Qty.
151-01699*	MSC2LP	0.1 - 0.1 (1.5 - 2.0)	0.2 (4.1)	0.3 (7.0)	0.7 (17.0)	0.4 (9.5)	SS304	Metal	100

Dimensions are approximate and subject to technical changes. Use Part No. for ordering and Type for specification purposes.
 *This product meets UL standards. Please see appendix for specific file numbers.

Edge Clips

Heavy Duty Wedge Clips

The Wedge Clip, paired with any HellermannTyton heavy duty Cable Tie, routes cables along a frame or rail in vertical or horizontal applications. A robust design and durable materials make it ideal for extreme-duty applications. The integrated wedge mechanism slides along a stepped grade until snug against the mounting surface. Inside the clip is a 3M™ VHB™ (Very High Bond) adhesive pad, which actually builds strength over time. This holds the clip to the work surface instantly, enabling installers to place it into position without worrying about it falling off prior to fastening. The combination of adhesive and the clip's vice-like compression result in incredible extraction force without the need to drill holes. The Wedge Clip is offered in three sizes.



Features and Benefits

- Two-piece ratcheting wedge design allows for easy, positive-locking size adjustment.
- Peel and stick 3M™ VHB™ adhesive inside clip increases grip and enables one-hand installation.
- Heat-stabilized, glass-filled PA66 assembly delivers remarkable extraction force without drilling.
- Three sizes cover a wide range of mounting thicknesses, reducing part inventory.
- 4-way, wide slot accommodates our heavy-duty and Wide-Strap Series Cable Ties.

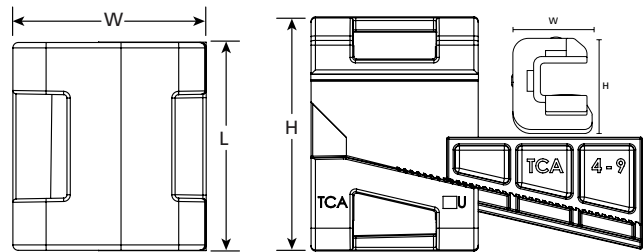

PART NO.	TYPE	Panel Thickness in. (mm)	Length (L) in. (mm)	Width (W) in. (mm)	Height (H) in. (mm)	Material	Color	Pkg. Qty.
151-01565	BCAA	0.0 - 0.2 (0.0 - 5.0)	1.2 (30.8)	1.1 (28.6)	1.7 (43.1)	PA66HSGF30	Black, Green	200
151-01566	BCBLGA	0.2 - 0.4 (4.0 - 9.0)	1.2 (30.8)	1.1 (28.6)	1.7 (43.1)	PA66HSGF30	Black	200
151-01567	BCCLGA	0.3 - 0.5 (8.0 - 13.0)	1.2 (30.8)	1.1 (28.6)	1.7 (43.1)	PA66HSGF30	Black, Gray	200

Dimensions are approximate and subject to technical changes. Use Part No. for ordering and Type for specification purposes. 3M and VHB are trademarks of 3M Company.

Bundling and Securing

Self-Affixing Clips

Convolute Tubing Clips

Convolute Tubing Mounts

Convolute Tubing Clips provide a quick and easy method for firmly securing corrugated covered cables and wires to a surface. Applications such as this can be found in a wide variety of industries such as the wire harness, automotive, trucking, and heavy equipment manufacturing industries.

Features and Benefits

- Clip includes an internal rib that spans the inside of the bracket to fit securely into the profile of the tubing to prevent lateral movement and slipping of the tubing.
- Fir tree design provides low insertion forces and high extraction forces.
- Extended fir tree allows for a wide range of panel thicknesses.

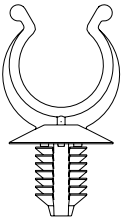

PART NO.	TYPE	Nominal Dia. in. (mm)	Min. Panel Thickness in. (mm)	Max. Panel Thickness in. (mm)	Mounting Hole Dia. in. (mm)	Material	Color	Pkg. Qty.
151-00018	CTC10FT6LG	3/8 (10.0)	0.04 (0.75)	0.03 (6.0)	0.26 - 0.28 (6.5 - 7.0)	PA66HIRHS	Black	500
155-17801	CTC10FT9	3/8 (10.0)	0.12 (3.0)	0.12 (5.0)	0.34 - 0.35 (8.7 - 9.0)	PA66HIRHS	Black	500
151-14312	CTC13FT6	1/2 (13.0)	0.04 (0.75)	0.03 (3.0)	0.26 - 0.28 (6.5 - 7.0)	PA66HIRHS	Black	500
151-00019	CTC13FT6LG	1/2 (13.0)	0.04 (0.75)	0.24 (6.0)	0.26 - 0.28 (6.5 - 7.0)	PA66HIRHS	Black	500
151-00783	CTCFT6	1-9/16 (15.0)	0.04 (0.7)	0.03 (4.5)	0.25 - 0.28 (6.3 - 6.7)	PA66HIRHS	Black	5000
151-00621	CTCL16FT6LG	5/8 (16.0)	0.02 (0.7)	0.5 (13.0)	0.25 - 0.28 (6.3 - 7.0)	PA66HIRHS	Black	1500

Dimensions are approximate and subject to technical changes. Use Part No. for ordering and Type for specification purposes.

Hose Clamps

Snapper Hose Clamps Polyamide 6.6 Glass Filled Impact Modified Heat Stabilized

The Snapper Hose Clamp features a ratchet-style closure for reduced assembly time. It can be added after connection of the hose. Release by sliding the ratchet ends apart. Snappers can be used in under-hood applications and are stable in a wide variety of chemicals including salts, bases, alcohols, ethers, detergents, gasoline, lubricating oils and greases. They are manufactured in black PA66 glass filled, impact modified, heat stabilized material. Custom design and color options are available based upon application and volume requirements.

Features and Benefits

- Installation and removal can be five times faster than conventional clamps.
- Heat stabilized material is suitable for high-temperature applications.
- Can be installed with hose in place.
- One-handed installation in tight places.

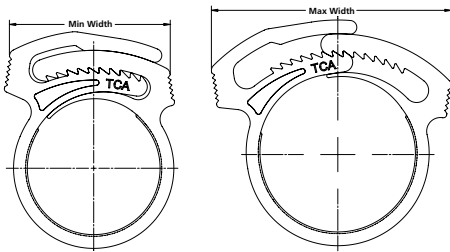

PART NO.	TYPE	Min. Diameter in. (mm)	Max. Diameter in. (mm)	Width in. (mm)	Wall Thickness in. (mm)	Min. Width in. (mm)	Max. Width in. (mm)	Material	Color	Pkg. Qty.
SNP1GHS0C2	SNP1	0.2 (6.0)	0.3 (6.7)	0.1 (3.8)	0.0 (1.0)	0.3 (8.4)	0.5 (11.7)	PA66GF13	Black	100
SNP1GHS0M4		0.2 (6.0)	0.3 (6.7)	0.1 (3.8)	0.0 (1.0)	0.3 (8.6)	0.5 (11.8)	PA66GF13	Black	1000
SNP1.25GHS0M4	SNP1.25	0.3 (7.2)	0.3 (7.7)	0.2 (3.8)	0.0 (1.1)	0.4 (10.6)	0.5 (12.6)	PA66GF13	Black	1000
SNP1.25GHS0C2		0.3 (7.2)	0.3 (7.7)	0.2 (3.8)	0.0 (1.1)	0.4 (10.6)	0.5 (12.6)	PA66GF13	Black	100
SNP1.5GHS0M4	SNP1.5	0.3 (8.0)	0.4 (8.9)	0.1 (3.7)	0.1 (1.4)	0.4 (10.5)	0.6 (15.0)	PA66GF13	Black	1000
SNP1.5GHS0C2		0.3 (8.0)	0.4 (8.9)	0.1 (3.7)	0.1 (1.4)	0.4 (10.5)	0.6 (15.0)	PA66GF13	Black	100
SNP2GHS0C2	SNP2	0.4 (9.3)	0.4 (10.4)	0.2 (5.9)	0.1 (1.7)	0.5 (12.2)	0.7 (17.6)	PA66GF13	Black	100
SNP2GHS0M4		0.4 (9.3)	0.4 (10.4)	0.2 (5.9)	0.1 (1.7)	0.5 (12.2)	0.7 (17.5)	PA66GF13	Black	1000
SNP3GHS0C2	SNP3	0.4 (10.1)	0.5 (11.4)	0.2 (5.9)	0.1 (1.8)	0.6 (14.4)	0.8 (20.5)	PA66GF13	Black	100
SNP3GHS0M4		0.4 (10.1)	0.5 (11.4)	0.2 (5.9)	0.1 (1.8)	0.6 (14.4)	0.8 (20.5)	PA66GF13	Black	1000
SNP4GHS0C2	SNP4	0.4 (10.4)	0.5 (11.6)	0.2 (5.9)	0.1 (1.7)	0.5 (13.3)	0.8 (19.2)	PA66GF13	Black	100
SNP4GHS0M4		0.4 (10.4)	0.5 (11.6)	0.2 (5.9)	0.1 (1.7)	0.5 (13.4)	0.8 (19.2)	PA66GF13	Black	1000
SNP6GHS0C2	SNP6	0.5 (11.6)	0.5 (13.2)	0.2 (5.9)	0.1 (1.7)	0.6 (14.7)	0.8 (21.6)	PA66GF13	Black	100
SNP6GHS0M4		0.5 (11.6)	0.5 (13.2)	0.2 (5.9)	0.1 (1.8)	0.6 (14.7)	0.8 (21.5)	PA66GF13	Black	1000
SNP7GHS0C2	SNP7	0.5 (11.7)	0.6 (14.0)	0.2 (5.9)	0.1 (1.7)	0.7 (18.4)	1.1 (28.5)	PA66GF13	Black	100
SNP7GHS0M4		0.5 (11.7)	0.6 (14.0)	0.2 (5.9)	0.1 (1.8)	0.7 (18.6)	1.1 (28.7)	PA66GF13	Black	1000
SNP8GHS0M4	SNP8	0.5 (13.1)	0.6 (15.0)	0.2 (5.7)	0.1 (1.8)	0.7 (16.7)	1.0 (24.9)	PA66GF13	Black	1000
SNP8GHS0C2		0.5 (13.1)	0.6 (15.0)	0.2 (5.7)	0.1 (1.7)	0.7 (16.7)	1.0 (24.9)	PA66GF13	Black	100

Dimensions are approximate and subject to technical changes. Use Part No. for ordering and Type for specification purposes. Snapper performance varies on application and environmental factors; end use testing is highly recommended.

Bundling and Securing

Clamps

Hose Clamps

Snapper Hose Clamps Polyamide 6.6 Glass Filled Impact Modified Heat Stabilized

PART NO.	TYPE	Min. Diameter in. (mm)	Max. Diameter in. (mm)	Width in. (mm)	Wall Thickness in. (mm)	Min. Width in. (mm)	Max. Width in. (mm)	Material	Color	Pkg. Qty.
SNP10GHS0M4	SNP10	0.6 (14.5)	0.7 (16.6)	0.2 (5.9)	0.1 (1.7)	0.7 (17.6)	1.1 (26.9)	PA66GF13	Black	1000
SNP10GHS0C2		0.6 (14.5)	0.7 (16.6)	0.2 (5.9)	0.1 (1.8)	0.7 (17.6)	1.1 (26.9)	PA66GF13	Black	100
SNP12AGHS0M4	SNP12A	0.6 (15.6)	0.7 (18.3)	0.2 (5.9)	0.1 (1.8)	0.8 (21.0)	1.2 (29.9)	PA66GF13	Black	1000
SNP12AGHS0C2		0.6 (15.6)	0.7 (18.3)	0.2 (5.9)	0.1 (1.8)	0.8 (21.0)	1.2 (29.9)	PA66GF13	Black	100
109-00301	SNP14A	0.7 (18.5)	0.8 (21.0)	0.2 (5.9)	0.1 (1.8)	0.8 (20.9)	1.2 (30.1)	PA66GF13	Black	1000
109-00300		0.7 (18.5)	0.8 (21.0)	0.2 (5.9)	0.1 (1.8)	0.8 (20.9)	1.2 (30.1)	PA66GF13	Black	100
SNP16GHS0M4	SNP16	0.8 (19.1)	0.9 (21.7)	0.2 (5.8)	0.1 (1.7)	0.8 (19.9)	1.2 (30.8)	PA66GF13	Black	1000
SNP16GHS0C2		0.8 (19.1)	0.9 (21.7)	0.2 (5.8)	0.1 (1.5)	0.8 (19.9)	1.2 (30.8)	PA66GF13	Black	100
SNP18AGHS0C2	SNP18A	0.8 (19.9)	0.9 (23.6)	0.2 (5.9)	0.1 (1.8)	0.9 (24.0)	1.4 (35.5)	PA66GF13	Black	100
SNP18AGHS0M4		0.8 (19.9)	0.9 (23.6)	0.2 (5.9)	0.1 (1.8)	0.9 (24.0)	1.4 (35.5)	PA66GF13	Black	1000
SNP22GHS0M4	SNP22	0.9 (23.7)	1.1 (27.4)	0.2 (6.0)	0.1 (1.8)	0.9 (23.9)	1.5 (37.7)	PA66GF13	Black	1000
SNP22GHS0C2		0.9 (23.7)	1.1 (27.4)	0.2 (6.0)	0.1 (1.8)	0.9 (23.9)	1.5 (37.7)	PA66GF13	Black	100
SNP19GHS0M4	SNP19	1.0 (24.4)	1.0 (25.3)	0.2 (5.9)	0.1 (1.8)	0.9 (22.3)	1.4 (36.1)	PA66GF13	Black	1000
SNP19GHS0C2		1.0 (24.4)	1.0 (25.3)	0.2 (5.9)	0.1 (1.7)	0.9 (24.4)	1.4 (36.1)	PA66GF13	Black	100
SNP24GHS0H4	SNP24	1.0 (25.8)	1.2 (29.7)	0.3 (7.4)	0.1 (1.7)	1.0 (26.5)	1.6 (39.4)	PA66GF13	Black	500
SNP24GHS0C2		1.0 (25.8)	1.2 (29.7)	0.3 (7.3)	0.1 (1.7)	1.0 (26.5)	1.6 (39.4)	PA66GF13	Black	100
SNP28GHS0H4	SNP28	1.1 (28.5)	1.3 (32.7)	0.3 (7.3)	0.1 (1.7)	1.0 (25.9)	1.6 (41.8)	PA66GF13	Black	500
SNP28GHS0C2		1.1 (28.5)	1.3 (32.7)	0.3 (7.3)	0.1 (1.7)	1.0 (26.0)	1.6 (42.1)	PA66GF13	Black	100
SNP32GHS0K2	SNP32	1.2 (31.2)	1.4 (35.8)	0.3 (7.3)	0.1 (1.8)	1.1 (27.3)	1.7 (44.4)	PA66GF13	Black	50
SNP32GHS0H4		1.2 (31.2)	1.4 (35.8)	0.3 (7.3)	0.1 (1.7)	1.1 (27.3)	1.7 (44.4)	PA66GF13	Black	500
SNP33GHS0H4	SNP33	1.3 (32.8)	1.6 (40.4)	0.3 (7.3)	0.1 (1.7)	1.6 (41.4)	2.6 (65.1)	PA66GF13	Black	500
SNP34GHS0H4	SNP34	1.4 (34.7)	1.6 (40.5)	0.3 (7.4)	0.1 (1.7)	1.2 (30.6)	2.0 (50.7)	PA66GF13	Black	500
SNP34GHS0K2		1.4 (34.7)	1.6 (40.5)	0.3 (7.4)	0.1 (1.7)	1.2 (30.6)	2.0 (50.7)	PA66GF13	Black	50
SNP36GHS0H4	SNP36	1.5 (37.8)	1.7 (44.0)	0.3 (7.3)	0.1 (1.7)	1.3 (32.4)	1.7 (44.0)	PA66GF13	Black	500
SNP36GHS0K2		1.5 (37.8)	1.7 (44.0)	0.3 (7.3)	0.1 (1.7)	1.3 (32.4)	2.1 (53.8)	PA66GF13	Black	50
SNP38GHS0K2	SNP38	1.6 (41.0)	1.9 (48.1)	0.3 (7.3)	0.1 (1.8)	1.4 (35.6)	2.3 (57.5)	PA66GF13	Black	50
SNP38GHS0H4		1.6 (41.0)	1.9 (48.1)	0.3 (7.3)	0.1 (1.7)	1.4 (35.6)	2.3 (57.5)	PA66GF13	Black	500
SNP42NGHS0C2	SNP42N	1.7 (44.2)	2.0 (51.3)	0.3 (7.3)	0.1 (1.7)	1.4 (35.1)	2.3 (58.9)	PA66GF13	Black	100
SNP42NGHS0K2	SNP42	1.7 (44.2)	2.0 (51.3)	0.3 (7.3)	0.1 (1.7)	1.4 (35.7)	2.3 (59.8)	PA66GF13	Black	50
SNP50GHS0C2	SNP50	2.1 (52.2)	2.3 (58.6)	0.3 (7.3)	0.1 (1.7)	1.4 (36.5)	2.4 (60.4)	PA66GF13	Black	100
SNP60GHS0C2	SNP60	2.3 (58.6)	2.6 (65.7)	0.3 (7.2)	0.1 (1.7)	1.5 (38.4)	2.6 (65.4)	PA66GF13	Black	100
SNP70GHS0C2	SNP70	2.6 (66.9)	3.1 (79.9)	0.3 (7.5)	0.1 (2.0)	1.8 (46.5)	3.1 (77.7)	PA66GF13	Black	100
SNP76GHS0C2	SNP76	2.9 (73.6)	3.3 (82.7)	0.4 (9.9)	0.1 (1.7)	1.7 (44.1)	2.9 (73.7)	PA66GF13	Black	100
SNP76GHS0X2		2.9 (73.6)	3.3 (82.7)	0.4 (9.9)	0.7 (1.7)	1.7 (44.1)	2.9 (73.7)	PA66GF13	Black	25
SNP80GHS0C2	SNP80	3.1 (79.4)	3.5 (88.3)	0.3 (8.4)	0.1 (2.5)	1.9 (47.5)	3.1 (78.7)	PA66GF13	Black	100
SNP90GHS0X2	SNP90	3.5 (87.8)	3.8 (97.1)	0.4 (9.8)	0.1 (2.4)	1.9 (48.8)	3.2 (81.5)	PA66GF13	Black	25
SNP100GHS0C2	SNP100	3.8 (97.6)	4.3 (110.0)	0.4 (9.9)	0.1 (2.5)	2.1 (52.6)	3.5 (89.9)	PA66GF13	Black	100
SNP101GHS0X2	SNP101	4.1 (104.7)	4.7 (119.9)	0.4 (11.3)	0.1 (2.5)	2.4 (61.6)	4.3 (108.3)	PA66GF13	Black	25

Dimensions are approximate and subject to technical changes. Use Part No. for ordering and Type for specification purposes. Snapper performance varies on application and environmental factors; end use testing is highly recommended.

Hose Clamps

Snapper Hose Clamps Polyacetal (POM)

The Snapper Hose Clamp features a ratchet-style closure for reduced assembly time. It can be added after connection of the hose. Release by sliding the ratchet ends apart. These white polyacetal Snappers can be used in under-hood applications and are stable in a wide variety of chemicals including salts, bases, alcohols, ethers, detergents, gasoline, lubricating oils and greases. Custom design and color options are available based upon application and volume requirements.

Features and Benefits

- Installation and removal can be five times faster than conventional clamps.
- Can be installed with hose in place.
- One-handed installation in tight places.

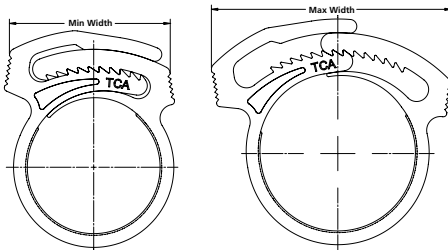

PART NO.	TYPE	Min. Diameter in. (mm)	Max. Diameter in. (mm)	Width in. (mm)	Wall Thickness in. (mm)	Min. Width in. (mm)	Max. Width in. (mm)	Material	Color	Pkg. Qty.
SNP110C2	SNP1	0.2 (6.0)	0.3 (6.7)	0.1 (3.8)	0.0 (1.0)	0.3 (8.3)	0.5 (11.7)	POM	White	100
SNP110M4		0.2 (6.0)	0.3 (6.7)	0.1 (3.8)	0.0 (1.0)	0.3 (8.3)	0.5 (11.7)	POM	White	1000
SNP1.2510C2	SNP1.25	0.3 (7.0)	0.3 (7.5)	0.2 (3.8)	0.0 (1.1)	0.4 (10.4)	0.5 (12.5)	POM	White	100
SNP1.2510M4		0.3 (7.0)	0.3 (7.5)	0.2 (3.8)	0.0 (1.1)	0.4 (10.4)	0.5 (12.5)	POM	White	1000
SNP1.510C2	SNP1.5	0.3 (7.9)	0.3 (8.8)	0.1 (3.8)	0.1 (1.4)	0.4 (10.4)	0.6 (14.9)	POM	White	100
SNP1.510M4		0.3 (7.9)	0.3 (8.8)	0.1 (3.8)	0.1 (1.4)	0.4 (10.4)	0.6 (14.9)	POM	White	1000
SNP210C2	SNP2	0.4 (9.0)	0.4 (10.1)	0.2 (5.8)	0.1 (1.7)	0.5 (12.0)	0.7 (17.1)	POM	White	100
SNP210M4		0.4 (9.0)	0.4 (10.1)	0.2 (5.8)	0.1 (1.7)	0.5 (12.0)	0.7 (17.1)	POM	White	1000
SNP410C2	SNP4	0.4 (9.6)	0.4 (10.7)	0.2 (5.8)	0.1 (1.7)	0.5 (13.2)	0.7 (18.9)	POM	White	100
SNP410M4		0.4 (9.6)	0.4 (10.7)	0.2 (5.8)	0.1 (1.7)	0.5 (13.2)	0.7 (18.9)	POM	White	1000
SNP310C2	SNP3	0.4 (9.8)	0.4 (11.2)	0.2 (5.9)	0.1 (1.8)	0.6 (14.2)	0.8 (20.4)	POM	White	100
SNP310M4		0.4 (9.8)	0.4 (11.2)	0.2 (5.9)	0.1 (1.8)	0.6 (14.2)	0.8 (20.4)	POM	White	1000
SNP610C2	SNP6	0.5 (11.5)	0.5 (13.0)	0.2 (5.9)	0.1 (1.8)	0.6 (14.2)	0.8 (20.9)	POM	White	100
SNP610M4		0.5 (11.5)	0.5 (13.0)	0.2 (5.9)	0.1 (1.8)	0.6 (14.2)	0.8 (20.9)	POM	White	1000
SNP710C2	SNP7	0.5 (11.6)	0.6 (14.2)	0.2 (5.9)	0.1 (1.8)	0.7 (18.6)	1.1 (29.0)	POM	White	100
SNP710M4		0.5 (11.6)	0.6 (14.2)	0.2 (5.9)	0.1 (1.8)	0.7 (18.6)	1.1 (29.0)	POM	White	1000
SNP810C2	SNP8	0.5 (13.1)	0.6 (14.9)	0.2 (5.8)	0.1 (1.8)	0.6 (16.0)	1.0 (24.5)	POM	White	100
SNP810M4		0.5 (13.1)	0.6 (14.9)	0.2 (5.8)	0.1 (1.8)	0.6 (16.0)	1.0 (24.5)	POM	White	1000
SNP1010C2	SNP10	0.6 (14.5)	0.7 (16.5)	0.2 (6.0)	0.1 (1.7)	0.7 (16.8)	1.0 (25.6)	POM	White	100
SNP1010M4		0.6 (14.5)	0.7 (16.5)	0.2 (6.0)	0.1 (1.7)	0.7 (16.8)	1.0 (25.6)	POM	White	1000

Dimensions are approximate and subject to technical changes. Use Part No. for ordering and Type for specification purposes.

Acetal black is also available based upon minimum volume requirements. Snapper performance varies on application and environmental factors; end use testing is highly recommended.

Bundling and Securing

Clamps

Hose Clamps

Snapper Hose Clamps Polyacetal (POM)

PART NO.	TYPE	Min. Diameter in. (mm)	Max. Diameter in. (mm)	Width in. (mm)	Wall Thickness in. (mm)	Min. Width in. (mm)	Max. Width in. (mm)	Material	Color	Pkg. Qty.
SNP12A10C2	SNP12A	0.6 (15.5)	0.7 (18.2)	0.2 (5.9)	0.1 (1.8)	0.8 (20.6)	1.2 (29.4)	POM	White	100
SNP12A10M4		0.6 (15.5)	0.7 (18.2)	0.2 (5.9)	0.1 (1.8)	0.8 (20.6)	1.2 (29.4)	POM	White	1000
SNP14A10C2	SNP14A	0.7 (18.1)	0.8 (20.6)	0.2 (5.9)	0.1 (1.8)	0.8 (20.5)	1.2 (29.4)	POM	White	100
SNP14A10M4		0.7 (18.1)	0.8 (20.6)	0.2 (5.9)	0.1 (1.8)	0.8 (20.5)	1.2 (29.4)	POM	White	1000
SNP1610C2	SNP16	0.7 (18.9)	0.8 (21.3)	0.2 (5.8)	0.1 (1.7)	0.8 (19.5)	1.2 (30.1)	POM	White	100
SNP1610M4		0.7 (18.9)	0.8 (21.3)	0.2 (5.8)	0.1 (1.7)	0.8 (19.5)	1.2 (30.1)	POM	White	1000
SNP18A10C2	SNP18A	0.8 (19.7)	0.9 (23.6)	0.2 (5.9)	0.1 (1.7)	0.9 (23.6)	1.4 (35.0)	POM	White	100
SNP18A10M4		0.8 (19.7)	0.9 (23.6)	0.2 (5.9)	0.1 (1.7)	0.9 (23.6)	1.4 (35.0)	POM	White	1000
SNP1910C2	SNP19	0.9 (22.5)	1.0 (25.3)	0.2 (5.8)	0.1 (1.8)	0.9 (24.0)	1.4 (35.5)	POM	White	100
SNP1910M4		0.9 (22.5)	1.0 (25.3)	0.2 (5.8)	0.1 (1.8)	0.9 (24.0)	1.4 (35.5)	POM	White	1000
SNP2210C2	SNP22	0.9 (23.3)	1.0 (26.6)	0.2 (5.9)	0.1 (1.8)	0.9 (23.4)	1.5 (37.0)	POM	White	100
SNP2210M4		0.9 (23.3)	1.0 (26.6)	0.2 (5.9)	0.1 (1.8)	0.9 (23.4)	1.5 (37.0)	POM	White	1000
SNP2410C2	SNP24	1.0 (25.2)	1.1 (28.3)	0.3 (7.4)	0.1 (1.8)	1.0 (26.0)	1.5 (38.6)	POM	White	100
SNP2410H4		1.0 (25.2)	1.1 (28.3)	0.3 (7.4)	0.1 (1.8)	1.0 (26.0)	1.5 (38.6)	POM	White	500
SNP2810C2	SNP28	1.1 (28.1)	1.3 (32.2)	0.3 (7.4)	0.1 (1.7)	1.0 (25.4)	1.6 (41.1)	POM	White	100
SNP2810H4		1.1 (28.1)	1.3 (32.2)	0.3 (7.4)	0.1 (1.7)	1.0 (25.4)	1.6 (41.1)	POM	White	500
SNP3210K2	SNP32	1.2 (30.8)	1.4 (35.2)	0.3 (7.3)	0.1 (1.7)	1.1 (26.7)	1.7 (43.4)	POM	White	50
SNP3210H4		1.2 (30.8)	1.4 (35.2)	0.3 (7.3)	0.1 (1.7)	1.1 (26.7)	1.7 (43.4)	POM	White	500
SNP3310K2	SNP33	1.3 (32.8)	1.6 (40.2)	0.3 (7.4)	0.1 (1.7)	1.6 (39.7)	2.5 (63.9)	POM	White	50
SNP3310H4		1.3 (32.8)	1.6 (40.2)	0.3 (7.4)	0.1 (1.7)	1.6 (41.5)	2.6 (65.1)	POM	White	500
SNP3410K2	SNP34	1.3 (33.7)	1.5 (39.2)	0.3 (7.5)	0.1 (1.7)	1.2 (30.0)	1.9 (49.5)	POM	White	50
SNP3410H4		1.3 (33.7)	1.5 (39.2)	0.3 (7.5)	0.1 (1.7)	1.2 (30.0)	1.9 (49.5)	POM	White	500
SNP3610H4	SNP36	1.5 (37.1)	1.7 (42.9)	0.3 (7.3)	0.1 (1.7)	1.2 (31.7)	2.0 (52.0)	POM	White	500
SNP3610K2		1.5 (37.1)	1.7 (42.9)	0.3 (7.3)	0.1 (1.7)	1.2 (31.7)	2.0 (52.0)	POM	White	50
SNP3810K2	SNP38	1.6 (41.0)	1.9 (47.9)	0.3 (7.3)	0.1 (1.7)	1.3 (34.2)	2.3 (57.7)	POM	White	50
SNP3810H4		1.6 (41.0)	1.9 (47.9)	0.3 (7.3)	0.1 (1.7)	1.3 (34.2)	2.3 (57.7)	POM	White	500
SNP42N10C2	SNP42N	1.7 (44.2)	2.0 (51.3)	0.3 (7.3)	0.1 (1.7)	1.4 (35.1)	2.3 (58.9)	POM	White	100
SNP42N10K2	SNP42	1.7 (44.2)	2.0 (51.3)	0.3 (7.3)	0.1 (1.7)	1.4 (35.1)	2.3 (58.9)	POM	White	50
SNP5010C2	SNP50	2.0 (50.6)	2.3 (59.0)	0.3 (7.3)	0.1 (1.7)	1.4 (35.7)	2.3 (57.2)	POM	White	100
SNP6010C2	SNP60	2.3 (57.4)	2.6 (65.6)	0.3 (7.4)	0.1 (1.7)	1.4 (36.8)	2.6 (65.0)	POM	White	100
SNP7010C2	SNP70	2.6 (66.7)	3.1 (78.7)	0.4 (9.5)	0.1 (2.0)	1.8 (46.1)	3.0 (76.3)	POM	White	100
SNP7010X2		2.6 (66.7)	3.1 (78.7)	0.4 (9.5)	0.1 (2.0)	1.8 (46.1)	3.0 (76.3)	POM	White	25
SNP7610C2	SNP76	2.9 (72.4)	3.2 (80.5)	0.4 (9.8)	0.1 (1.7)	1.8 (44.6)	2.8 (72.2)	POM	White	100
SNP8010C2	SNP80	3.1 (79.4)	3.5 (88.3)	0.4 (11.2)	0.1 (2.5)	1.9 (47.5)	3.1 (78.7)	POM	White	100
SNP9010C2	SNP90	3.5 (87.8)	3.8 (97.1)	0.4 (9.8)	0.1 (1.7)	1.9 (48.8)	3.2 (81.5)	POM	White	100
SNP10010X2	SNP100	3.8 (96.6)	4.2 (101.8)	0.4 (9.9)	0.1 (2.4)	2.0 (51.9)	3.5 (89.3)	POM	White	25
SNP10110X2	SNP101	4.0 (102.4)	4.6 (117.3)	0.4 (11.2)	0.1 (2.5)	2.4 (61.0)	4.2 (107.2)	POM	White	25

Dimensions are approximate and subject to technical changes. Use Part No. for ordering and Type for specification purposes.

Acetal black is also available based upon minimum volume requirements. Snapper performance varies on application and environmental factors; end use testing is highly recommended.

Hose Clamps

Snapper Hose Clamp Tools

Snapper installation tools are available in both pneumatic and mechanical version. They are specifically developed to increase reliability, reduce operator fatigue and installation time.

Features and Benefits

- For efficient fixing of the snapper hose clips.



PART NO.	TYPE	Operation	Application	Description	Application Range	Material	Color	Pkg. Qty.
MSNP1-70	MSNP1-70	manually	Maintenance/Removal	Vertical stroke	1 - 70	MET, PL	Yellow	1
ASNP2-22	ASNP2-22	manually	Production	Vertical stroke	2 - 22	MET, PL	Blue	1
ASNP24-70	ASNP24-70	manually	Production	Vertical stroke	24 - 70	MET, PL	Red	1
PSNP2-22	PSNP2-22	pneumatic	Production	Vertical stroke	2 - 22	MET	Black, Metal	1
PHSNP2-36	PHSNP2-36	pneumatic	Production	Horizontal stroke	2 - 36	MET	Metal	1
PHSNP38-100	PHSNP38-100	pneumatic	Production	Horizontal stroke	38 - 100	MET	Metal	1

Dimensions are approximate and subject to technical changes. Use Part No. for ordering and Type for specification purposes.

Bundling and Securing

Clamps

Plastic P-Clamps

HP-Series

HellermannTyton P-Clamps easily guide and locate wires and cables. The clamps are designed with radius edges to prevent chafing and cutting into insulation. Available sizes up to 1" bundle diameters.

Features and Benefits

- P-Clamps easily guide and locate wire and cables up to 1" in diameter.
- Designed with a radius edge to prevent chafing and cutting into insulation.

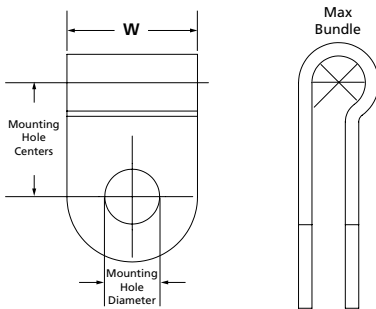

PART NO.	TYPE	Max. Bundle Diameter in. (mm)	Width (W) in. (mm)	Mounting Hole Centers in. (mm)	Mounting Hole Dia. in. (mm)	Material	Color	Pkg. Qty.
211-60019	H1P	0.1 (3.2)	0.4 (10.0)	0.3 (8.5)	0.2 (4.2)	PA66	Natural	1000
211-00261		0.1 (3.2)	0.4 (10.0)	0.3 (8.5)	0.2 (4.2)	PA66	Natural	100
211-60010		0.1 (3.2)	0.4 (10.0)	0.3 (8.5)	0.2 (4.2)	PA66HS	Black	1000
211-60000		0.1 (3.2)	0.4 (10.0)	0.3 (8.5)	0.2 (4.2)	PA66HS	Black	100
211-60029	H2P	0.2 (5.0)	0.4 (10.0)	0.4 (9.5)	0.2 (4.2)	PA66	Natural	1000
211-00263		0.2 (5.0)	0.4 (10.0)	0.4 (9.5)	0.2 (4.2)	PA66	Natural	100
211-60001		0.2 (5.0)	0.4 (10.0)	0.4 (9.5)	0.2 (4.2)	PA66HS	Black	100
211-00262		0.2 (5.0)	0.4 (10.0)	0.4 (9.5)	0.2 (4.2)	PA66HS	Black	1000
211-60039	H3P	0.3 (6.5)	0.4 (10.0)	0.4 (10.0)	0.2 (4.2)	PA66	Natural	1000
211-00264		0.3 (6.5)	0.4 (10.0)	0.4 (10.0)	0.2 (4.2)	PA66	Natural	100
211-60040		0.3 (6.5)	0.4 (10.0)	0.4 (10.0)	0.2 (4.2)	PA66HS	Black	1000
211-60002		0.3 (6.5)	0.4 (10.0)	0.4 (10.0)	0.2 (4.2)	PA66HS	Black	100
211-60049	H4P	0.3 (8.0)	0.4 (10.0)	0.4 (10.0)	0.2 (4.2)	PA66	Natural	1000
211-60050		0.3 (8.0)	0.4 (10.0)	0.4 (10.0)	0.2 (4.2)	PA66HS	Black	1000
211-60003		0.3 (8.0)	0.4 (10.0)	0.4 (10.0)	0.2 (4.2)	PA66HS	Black	100
211-00266	H5P	0.4 (9.5)	0.4 (10.0)	0.4 (11.0)	0.2 (4.2)	PA66	Black	1000
211-60059		0.4 (9.5)	0.4 (10.0)	0.4 (11.0)	0.2 (4.2)	PA66	Natural	1000
211-00267		0.4 (9.5)	0.4 (10.0)	0.4 (11.0)	0.2 (4.2)	PA66	Natural	100
211-60004		0.4 (9.5)	0.4 (10.0)	0.4 (11.0)	0.2 (4.2)	PA66HS	Black	100
211-60061	H6P	0.4 (11.0)	0.4 (10.0)	0.5 (13.0)	0.2 (4.2)	PA66HS	Black	1000
211-60005		0.4 (11.0)	0.4 (10.0)	0.5 (13.0)	0.2 (4.2)	PA66HS	Black	100

Dimensions are approximate and subject to technical changes. Use Part No. for ordering and Type for specification purposes.

Plastic P-Clamps

HP-Series

PART NO.	TYPE	Max. Bundle Diameter in. (mm)	Width (W) in. (mm)	Mounting Hole Centers in. (mm)	Mounting Hole Dia. in. (mm)	Material	Color	Pkg. Qty.
211-60079	H7P	0.5 (12.5)	0.4 (10.0)	0.6 (14.0)	0.2 (4.2)	PA66	Natural	1000
211-00269		0.5 (12.5)	0.4 (10.0)	0.6 (14.0)	0.2 (4.2)	PA66	Natural	100
211-60078		0.5 (12.5)	0.4 (10.0)	0.6 (14.0)	0.2 (4.2)	PA66HS	Black	1000
211-60006		0.5 (12.5)	0.4 (10.0)	0.6 (14.0)	0.2 (4.2)	PA66HS	Black	100
211-60089	H8P	0.6 (14.0)	0.4 (10.0)	0.6 (15.0)	0.2 (4.2)	PA66	Natural	1000
211-60090		0.6 (14.0)	0.4 (10.0)	0.6 (15.0)	0.2 (4.2)	PA66HS	Black	1000
211-60007		0.6 (14.0)	0.4 (10.0)	0.6 (15.0)	0.2 (4.2)	PA66HS	Black	100
211-60099	H9P	0.6 (16.0)	0.4 (10.0)	0.6 (16.0)	0.2 (4.2)	PA66	Natural	1000
211-00271		0.6 (16.0)	0.4 (10.0)	0.6 (16.0)	0.2 (4.2)	PA66	Natural	100
211-60008		0.6 (16.0)	0.4 (10.0)	0.6 (16.0)	0.2 (4.2)	PA66HS	Black	100
211-60009	H10P	0.7 (17.5)	0.4 (10.0)	0.7 (17.0)	0.2 (4.2)	PA66HS	Black	100
211-60130	H12P	0.8 (20.5)	0.4 (10.0)	0.8 (19.0)	0.2 (4.2)	PA66HS	Black	1000
211-60140	H13P	0.9 (22.0)	0.5 (12.0)	0.8 (20.5)	0.2 (5.2)	PA66HS	Black	1000
211-60150	H14P	1.0 (24.0)	0.5 (12.0)	0.9 (21.5)	0.2 (5.2)	PA66HS	Black	1000
211-60160	H15P	1.0 (25.5)	0.5 (12.0)	0.9 (23.0)	0.2 (5.2)	PA66HS	Black	1000

Dimensions are approximate and subject to technical changes. Use Part No. for ordering and Type for specification purposes.

Bundling and Securing

Clamps

Flat Ribbon Clamps

Dual Adjustable Flat Ribbon Cable Clamps - Adhesive Mount

HellermannTyton's flat ribbon clamps route, protect, and secure flat ribbon cables without damage to sensitive wires and cables. The unique, adjustable height feature allows the clamp to close to the exact height of the ribbon cable, using only as much force as needed to secure the cable. The releasable feature allows simple opening when access to the cable is necessary.

Features and Benefits

- Adjustable height feature allows the clamp to close to the exact height of the ribbon cable.
- Releasable for easy access to cables when necessary.

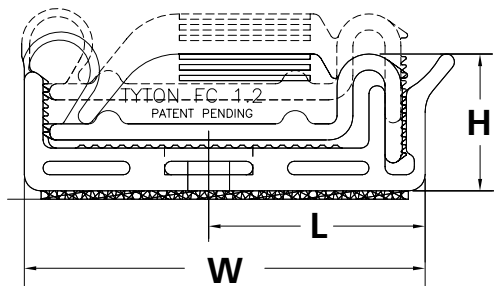

PART NO.	TYPE	Length (L) in. (mm)	Width (W) in. (mm)	Height (H) in. (mm)	Max. Cable Width in. (mm)	Material	Color	Pkg. Qty.
FC1.2AK2	FC1.2A	0.8 (19.0)	1.5 (38.1)	0.5 (12.7)	1.2 (30.5)	PA66	Gray	50
FC1.2AH4		0.8 (19.0)	1.5 (38.1)	0.5 (12.7)	1.2 (30.5)	PA66	Gray	500
FC2.2AK2	FC2.2A	0.8 (19.0)	2.6 (66.0)	0.5 (12.7)	2.2 (55.9)	PA66	Gray	50
FC2.2AH4		0.8 (19.0)	2.6 (66.0)	0.5 (12.7)	2.2 (55.9)	PA66	Gray	500

Dimensions are approximate and subject to technical changes. Use Part No. for ordering and Type for specification purposes.

Flat Ribbon Clamps

Dual Adjustable Flat Ribbon Cable Clamps - Screw Mount

HellermannTyton's flat ribbon clamps route, protect and secure flat ribbon cables without damage to sensitive wires and cables. The unique, adjustable height feature allows the clamp to close to the exact height of the ribbon cable, using only as much force as needed to secure the cable. The releasable feature allows simple opening when access to the cable is necessary.

Features and Benefits

- Adjustable-height feature allows the clamp to close to the exact height of the ribbon cable.
- Releasable for easy access to cables when necessary.

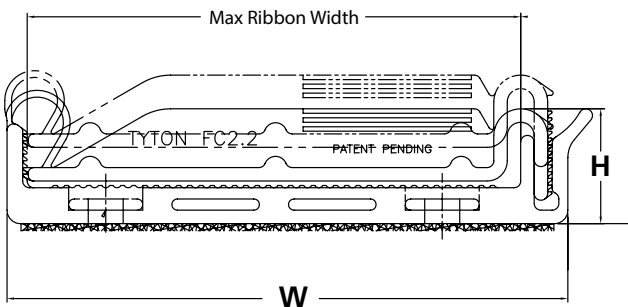

PART NO.	TYPE	Length in. (mm)	Width (W) in. (mm)	Width in. (mm)	Height (H) in. (mm)	Mounting Hole Dia. in. (mm)	Max. Cable Width in. (mm)	Material	Color	Pkg. Qty.
FC1.2K2	FC1.2	0.8 (19.0)	1.5 (38.1)	1.6 (41.2)	0.5 (12.7)	0.2 (4.0)	1.2 (30.5)	PA66	Gray	50
FC2.2K2	FC2.2	0.8 (19.0)	2.6 (66.0)	1.5 (38.1)	0.5 (12.7)	0.2 (4.0)	2.2 (55.9)	PA66	Gray	50
FC2.2H4		0.8 (19.0)	2.6 (66.0)	1.5 (38.1)	0.5 (12.7)	0.2 (4.0)	2.2 (55.9)	PA66	Gray	500

Dimensions are approximate and subject to technical changes. Use Part No. for ordering and Type for specification purposes.

Bundling and Securing

Clamps

Ratchet P-Clamps

Size A - For bundle diameters from ¼" to ½" (6.2 mm to 13.7 mm)

The Ratchet P-Clamp family offers versatility when managing wires, cables and hoses. The robust design and durable materials make it ideal for heavy duty applications, both indoors and out. The one-piece adjustable clamp can be closed by hand to the desired diameter. The release feature provides easy and nondestructive removal of cables simply by using a flat-head screwdriver. This nondestructive release allows the clamp to be reused without removing or replacing any bolts or screws. The Ratchet P-Clamp is offered in four sizes and multiple mounting configurations.

Features and Benefits

- One-piece ratchet closure design allows for easy installation during pre- or final assembly.
- Four sizes and multiple configurations handle a wide range of diameters and applications, reducing part inventory.
- Clamp interior is designed to guide and center bundle to reduce pinching.
- Easy release feature allows for quick adjustments and maintenance.
- Impact modified, heat and UV stabilized PA66 provides long-term durability, indoors and out.
- Steel mounting plate tolerates high torque mounting and is treated to resist chemicals and salt spray.

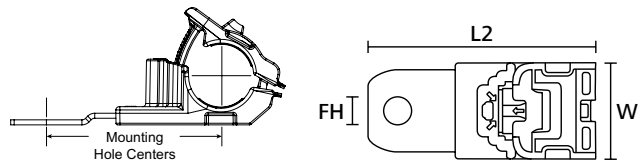

PART NO.	TYPE	Min. Tensile Strength lbs. (N)	Mounting Hole Centers in. (mm)	Mounting Hole Dia. in. (mm)	Angle/Length	Length (L2) in. (mm)	Width (W) in. (mm)	Material	Pkg. Qty.
151-01640*	RCA15SM6	100.0 (445.0)	2.2 (54.7)	0.3 (6.5)	15 ° Short	3.4 (86.9)	1.4 (34.9)	PA66HIRHSUV, ST, ZN	300
151-01425*	RCA15SM8	100.0 (445.0)	2.2 (54.7)	0.3 (8.31)	15 ° Short	3.4 (86.9)	1.4 (34.9)	PA66HIRHSUV, ST, ZN	300
151-01426*	RCA15SM10	100.0 (445.0)	2.2 (54.7)	0.4 (10.29)	15 ° Short	3.4 (86.9)	1.4 (34.9)	PA66HIRHSUV, ST, ZN	300
151-01427*	RCA15SM12	100.0 (445.0)	2.2 (54.7)	0.5 (12.95)	15 ° Short	3.4 (86.9)	1.4 (34.9)	PA66HIRHSUV, ST, ZN	300
151-01642*	RCA30LM6	100.0 (445.0)	2.9 (72.4)	0.3 (6.5)	30 ° Long	4.1 (103.2)	1.4 (34.9)	PA66HIRHSUV, ST, ZN	200
151-01431*	RCA30LM8	100.0 (445.0)	2.9 (72.4)	0.3 (8.31)	30 ° Long	4.1 (103.2)	1.4 (34.9)	PA66HIRHSUV, ST, ZN	200
151-01432*	RCA30LM10	100.0 (445.0)	2.9 (72.4)	0.4 (10.29)	30 ° Long	4.1 (103.2)	1.4 (34.9)	PA66HIRHSUV, ST, ZN	200
151-01433*	RCA30LM12	100.0 (445.0)	2.9 (72.4)	0.5 (12.95)	30 ° Long	4.1 (103.2)	1.4 (34.9)	PA66HIRHSUV, ST, ZN	200
151-01641*	RCA30SM6	100.0 (445.0)	1.9 (47.7)	0.3 (6.5)	30 ° Short	3.1 (78.5)	1.4 (34.9)	PA66HIRHSUV, ST, ZN	300
151-01428*	RCA30SM8	100.0 (445.0)	1.9 (47.7)	0.3 (8.31)	30 ° Short	3.1 (78.5)	1.4 (34.9)	PA66HIRHSUV, ST, ZN	300
151-01429*	RCA30SM10	100.0 (445.0)	1.9 (47.7)	0.4 (10.29)	30 ° Short	3.1 (78.5)	1.4 (34.9)	PA66HIRHSUV, ST, ZN	300

Dimensions are approximate and subject to technical changes. Use Part No. for ordering and Type for specification purposes.

*This product meets UL standards. Please see appendix for specific file numbers.



Please note! Not all products listed on this page may have this approval. Please check our website for latest approvals.

Ratchet P-Clamps

Size A - For bundle diameters from ¼" to ½" (6.2 mm to 13.7 mm)

PART NO.	TYPE	Min. Tensile Strength lbs. (N)	Mounting Hole Centers in. (mm)	Mounting Hole Dia. in. (mm)	Angle/Length	Length (L2) in. (mm)	Width (W) in. (mm)	Material	Pkg. Qty.
151-01430*	RCA30SM12	100.0 (445.0)	1.9 (47.7)	0.5 (12.95)	30 ° Short	3.1 (78.5)	1.4 (34.9)	PA66HIRHSUV, ST, ZN	300
151-01644*	RCA90LM6	100.0 (445.0)	1.0 (24.9)	0.3 (6.5)	90 ° Long	3.8 (96.8)	1.4 (34.9)	PA66HIRHSUV, ST, ZN	200
151-01437*	RCA90LM8	100.0 (445.0)	1.0 (24.9)	0.3 (8.31)	90 ° Long	3.8 (96.8)	1.4 (34.9)	PA66HIRHSUV, ST, ZN	200
151-01438*	RCA90LM10	100.0 (445.0)	1.0 (24.9)	0.4 (10.29)	90 ° Long	3.8 (96.8)	1.4 (34.9)	PA66HIRHSUV, ST, ZN	200
151-01439*	RCA90LM12	100.0 (445.0)	1.0 (24.9)	0.5 (12.95)	90 ° Long	3.8 (96.8)	1.4 (34.9)	PA66HIRHSUV, ST, ZN	200
151-01643*	RCA90SM6	100.0 (445.0)	1.0 (24.9)	0.3 (6.5)	90 ° Short	2.7 (68.8)	1.4 (34.9)	PA66HIRHSUV, ST, ZN	300
151-01434*	RCA90SM8	100.0 (445.0)	1.0 (24.9)	0.3 (8.31)	90 ° Short	2.7 (68.8)	1.4 (34.9)	PA66HIRHSUV, ST, ZN	300
151-01435*	RCA90SM10	100.0 (445.0)	1.0 (24.9)	0.4 (10.29)	90 ° Short	2.7 (68.8)	1.4 (34.9)	PA66HIRHSUV, ST, ZN	300
151-01436*	RCA90SM12	100.0 (445.0)	1.0 (24.9)	0.5 (12.95)	90 ° Short	2.7 (68.8)	1.4 (34.9)	PA66HIRHSUV, ST, ZN	300
151-01639*	RCA180LM6	100.0 (445.0)	4.0 (101.5)	0.3 (6.5)	180 ° Long	5.3 (134.1)	1.4 (34.9)	PA66HIRHSUV, ST, ZN	200
151-01422*	RCA180LM8	100.0 (445.0)	4.0 (101.5)	0.3 (8.31)	180 ° Long	5.3 (134.1)	1.4 (34.9)	PA66HIRHSUV, ST, ZN	200
151-01423*	RCA180LM10	100.0 (445.0)	4.0 (101.5)	0.4 (10.29)	180 ° Long	5.3 (134.1)	1.4 (34.9)	PA66HIRHSUV, ST, ZN	200
151-01424*	RCA180LM12	100.0 (445.0)	4.0 (101.5)	0.5 (12.95)	180 ° Long	5.3 (134.1)	1.4 (34.9)	PA66HIRHSUV, ST, ZN	200
151-01638*	RCA180MM6	100.0 (445.0)	2.9 (72.5)	0.3 (6.5)	180 ° Medium	4.1 (105.1)	1.4 (34.9)	PA66HIRHSUV, ST, ZN	200
151-01419*	RCA180MM8	100.0 (445.0)	2.9 (72.5)	0.3 (8.31)	180 ° Medium	4.1 (105.1)	1.4 (34.9)	PA66HIRHSUV, ST, ZN	200
151-01420*	RCA180MM10	100.0 (445.0)	2.9 (72.5)	0.4 (10.29)	180 ° Medium	4.1 (105.1)	1.4 (34.9)	PA66HIRHSUV, ST, ZN	200
151-01421*	RCA180MM12	100.0 (445.0)	2.9 (72.5)	0.5 (12.95)	180 ° Medium	4.1 (105.1)	1.4 (34.9)	PA66HIRHSUV, ST, ZN	200
151-01637*	RCA180SM6	100.0 (445.0)	2.0 (50.5)	0.3 (6.5)	180 ° Short	3.3 (83.1)	1.4 (34.9)	PA66HIRHSUV, ST, ZN	300
151-01670*		100.0 (445.0)	2.0 (50.5)	0.3 (6.5)	180 ° Short	3.3 (83.1)	1.4 (34.9)	PA66HIRHSUV, ST, ZN	5
151-01416*	RCA180SM8	100.0 (445.0)	2.0 (50.5)	0.3 (8.31)	180 ° Short	3.3 (83.1)	1.4 (34.9)	PA66HIRHSUV, ST, ZN	300

Dimensions are approximate and subject to technical changes. Use Part No. for ordering and Type for specification purposes.

*This product meets UL standards. Please see appendix for specific file numbers.



Please note! Not all products listed on this page may have this approval. Please check our website for latest approvals.

Bundling and Securing

Clamps

Ratchet P-Clamps

Size A - For bundle diameters from ¼" to ½" (6.2 mm to 13.7 mm)

PART NO.	TYPE	Min. Tensile Strength lbs. (N)	Mounting Hole Centers in. (mm)	Mounting Hole Dia. in. (mm)	Angle/Length	Length (L2) in. (mm)	Width (W) in. (mm)	Material	Pkg. Qty.
151-01417*	RCA180SM10	100.0 (445.0)	2.0 (50.5)	0.4 (10.29)	180 ° Short	3.3 (83.1)	1.4 (34.9)	PA66HIRHSUV, ST, ZN	300
151-01418*	RCA180SM12	100.0 (445.0)	2.0 (50.5)	0.5 (12.95)	180 ° Short	3.3 (83.1)	1.4 (34.9)	PA66HIRHSUV, ST, ZN	300

Dimensions are approximate and subject to technical changes. Use Part No. for ordering and Type for specification purposes.

*This product meets UL standards. Please see appendix for specific file numbers.



Please note! Not all products listed on this page may have this approval. Please check our website for latest approvals.

Ratchet P-Clamps

Size B - For bundle diameters from 1/2" to 3/4" (12.7 mm to 19.5 mm)

The Ratchet P-Clamp family offers versatility when managing wires, cables and hoses. The robust design and durable materials make it ideal for heavy duty applications, both indoors and out. The one-piece adjustable clamp can be closed by hand to the desired diameter. The release feature provides easy and nondestructive removal of cables simply by using a flat-head screwdriver. This nondestructive release allows the clamp to be reused without removing or replacing any bolts or screws. The Ratchet P-Clamp is offered in four sizes and multiple mounting configurations.

Features and Benefits

- One-piece ratchet closure design allows for easy installation during pre- or final assembly.
- Four sizes and multiple configurations handle a wide range of diameters and applications, reducing part inventory.
- Clamp interior is designed to guide and center bundle to reduce pinching.
- Easy release feature allows for quick adjustments and maintenance.
- Impact modified, heat and UV stabilized PA66 provides long-term durability, indoors and out.
- Steel mounting plate tolerates high torque mounting and is treated to resist chemicals and salt spray.

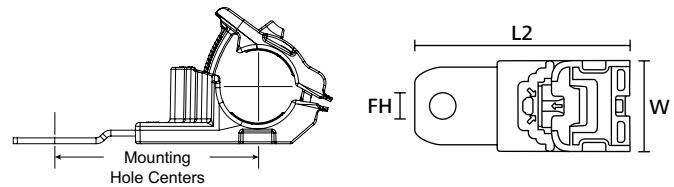

PART NO.	TYPE	Min. Tensile Strength lbs. (N)	Mounting Hole Centers in. (mm)	Mounting Hole Dia. in. (mm)	Angle/Length	Length (L2) in. (mm)	Width (W) in. (mm)	Material	Pkg. Qty.
151-01648*	RCB15SM6	100.0 (445.0)	2.2 (56.5)	0.3 (6.5)	15 ° Short	3.4 (86.9)	1.4 (34.9)	PA66HIRHSUV, ST, ZN	280
151-01448*	RCB15SM8	100.0 (445.0)	2.2 (56.5)	0.3 (8.31)	15 ° Short	3.4 (86.9)	1.4 (34.9)	PA66HIRHSUV, ST, ZN	280
151-01449*	RCB15SM10	100.0 (445.0)	2.2 (56.5)	0.4 (10.29)	15 ° Short	3.4 (86.9)	1.4 (34.9)	PA66HIRHSUV, ST, ZN	280
151-01450*	RCB15SM12	100.0 (445.0)	2.2 (56.5)	0.5 (12.95)	15 ° Short	3.4 (86.9)	1.4 (34.9)	PA66HIRHSUV, ST, ZN	280
151-01650*	RCB30LM6	100.0 (445.0)	2.9 (73.5)	0.3 (6.5)	30 ° Long	4.1 (103.2)	1.4 (34.9)	PA66HIRHSUV, ST, ZN	200
151-01454*	RCB30LM8	100.0 (445.0)	2.9 (73.5)	0.3 (8.31)	30 ° Long	4.1 (103.2)	1.4 (34.9)	PA66HIRHSUV, ST, ZN	200
151-01455*	RCB30LM10	100.0 (445.0)	2.9 (73.5)	0.4 (10.29)	30 ° Long	4.1 (103.2)	1.4 (34.9)	PA66HIRHSUV, ST, ZN	200
151-01456*	RCB30LM12	100.0 (445.0)	2.9 (73.5)	0.5 (12.95)	30 ° Long	4.1 (103.2)	1.4 (34.9)	PA66HIRHSUV, ST, ZN	200
151-01649*	RCB30SM6	100.0 (445.0)	1.9 (48.8)	0.3 (6.5)	30 ° Short	3.1 (78.5)	1.4 (34.9)	PA66HIRHSUV, ST, ZN	280
151-01451*	RCB30SM8	100.0 (445.0)	1.9 (48.8)	0.3 (8.31)	30 ° Short	3.1 (78.5)	1.4 (34.9)	PA66HIRHSUV, ST, ZN	280

Dimensions are approximate and subject to technical changes. Use Part No. for ordering and Type for specification purposes.

*This product meets UL standards. Please see appendix for specific file numbers.



Please note! Not all products listed on this page may have this approval. Please check our website for latest approvals.

Bundling and Securing

Clamps

Ratchet P-Clamps

Size B - For bundle diameters from ½" to ¾" (12.7 mm to 19.5 mm)

PART NO.	TYPE	Min. Tensile Strength lbs. (N)	Mounting Hole Centers in. (mm)	Mounting Hole Dia. in. (mm)	Angle/Length	Length (L2) in. (mm)	Width (W) in. (mm)	Material	Pkg. Qty.
151-01452*	RCB30SM10	100.0 (445.0)	1.9 (48.8)	0.4 (10.29)	30 ° Short	3.1 (78.5)	1.4 (34.9)	PA66HIRHSUV, ST, ZN	280
151-01453*	RCB30SM12	100.0 (445.0)	1.9 (48.8)	0.5 (12.95)	30 ° Short	3.1 (78.5)	1.4 (34.9)	PA66HIRHSUV, ST, ZN	280
151-01652*	RCB90LM6	100.0 (445.0)	1.1 (26.7)	0.3 (6.5)	90 ° Long	3.8 (96.8)	1.4 (34.9)	PA66HIRHSUV, ST, ZN	200
151-01460*	RCB90LM8	100.0 (445.0)	1.1 (26.7)	0.3 (8.31)	90 ° Long	3.8 (96.8)	1.4 (34.9)	PA66HIRHSUV, ST, ZN	200
151-01461*	RCB90LM10	100.0 (445.0)	1.1 (26.7)	0.4 (10.29)	90 ° Long	3.8 (96.8)	1.4 (34.9)	PA66HIRHSUV, ST, ZN	200
151-01462*	RCB90LM12	100.0 (445.0)	1.1 (26.7)	0.5 (12.95)	90 ° Long	3.8 (96.8)	1.4 (34.9)	PA66HIRHSUV, ST, ZN	200
151-01651*	RCB90SM6	100.0 (445.0)	1.1 (26.7)	0.3 (6.5)	90 ° Short	2.7 (68.8)	1.4 (34.9)	PA66HIRHSUV, ST, ZN	280
151-01457*	RCB90SM8	100.0 (445.0)	1.1 (26.7)	0.3 (8.31)	90 ° Short	2.7 (68.8)	1.4 (34.9)	PA66HIRHSUV, ST, ZN	280
151-01458*	RCB90SM10	100.0 (445.0)	1.1 (26.7)	0.4 (10.29)	90 ° Short	2.7 (68.8)	1.4 (34.9)	PA66HIRHSUV, ST, ZN	280
151-01459*	RCB90SM12	100.0 (445.0)	1.1 (26.7)	0.5 (12.95)	90 ° Short	2.7 (68.8)	1.4 (34.9)	PA66HIRHSUV, ST, ZN	280
151-01647*	RCB180LM6	100.0 (445.0)	4.1 (103.8)	0.3 (6.5)	180 ° Long	5.3 (134.1)	1.4 (34.9)	PA66HIRHSUV, ST, ZN	200
151-01445*	RCB180LM8	100.0 (445.0)	4.1 (103.8)	0.3 (8.31)	180 ° Long	5.3 (134.1)	1.4 (34.9)	PA66HIRHSUV, ST, ZN	200
151-01446*	RCB180LM10	100.0 (445.0)	4.1 (103.8)	0.4 (10.29)	180 ° Long	5.3 (134.1)	1.4 (34.9)	PA66HIRHSUV, ST, ZN	200
151-01447*	RCB180LM12	100.0 (445.0)	4.1 (103.8)	0.5 (12.95)	180 ° Long	5.3 (134.1)	1.4 (34.9)	PA66HIRHSUV, ST, ZN	200
151-01646*	RCB180MM6	100.0 (445.0)	2.9 (74.8)	0.3 (6.5)	180 ° Medium	4.1 (105.1)	1.4 (34.9)	PA66HIRHSUV, ST, ZN	200
151-01442*	RCB180MM8	100.0 (445.0)	2.9 (74.8)	0.3 (8.31)	180 ° Medium	4.1 (105.1)	1.4 (34.9)	PA66HIRHSUV, ST, ZN	200
151-01443*	RCB180MM10	100.0 (445.0)	2.9 (74.8)	0.4 (10.29)	180 ° Medium	4.1 (105.1)	1.4 (34.9)	PA66HIRHSUV, ST, ZN	200
151-01444*	RCB180MM12	100.0 (445.0)	2.9 (74.8)	0.5 (12.95)	180 ° Medium	4.1 (105.1)	1.4 (34.9)	PA66HIRHSUV, ST, ZN	200
151-01645*	RCB180SM6	100.0 (445.0)	2.1 (52.8)	0.3 (6.5)	180 ° Short	3.3 (83.1)	1.4 (34.9)	PA66HIRHSUV, ST, ZN	280
151-01671*		100.0 (445.0)	2.1 (52.8)	0.3 (6.5)	180 ° Short	3.3 (83.1)	1.4 (34.9)	PA66HIRHSUV, ST, ZN	5
151-01440*	RCB180SM8	100.0 (445.0)	2.1 (52.8)	0.3 (8.31)	180 ° Short	3.3 (83.1)	1.4 (34.9)	PA66HIRHSUV, ST, ZN	280
151-01390*	RCB180SM10	100.0 (445.0)	2.1 (52.8)	0.4 (10.29)	180 ° Short	3.3 (83.1)	1.4 (34.9)	PA66HIRHSUV, ST, ZN	280
151-01441*	RCB180SM12	100.0 (445.0)	2.1 (52.8)	0.5 (12.95)	180 ° Short	3.3 (83.1)	1.4 (34.9)	PA66HIRHSUV, ST, ZN	280

Dimensions are approximate and subject to technical changes. Use Part No. for ordering and Type for specification purposes.

*This product meets UL standards. Please see appendix for specific file numbers. Please note! Not all products listed on this page may have this approval. Please check our website for latest approvals.



Ratchet P-Clamps

Size C - For bundle diameters from ¾" to 1 ⅜" (19.4 mm to 36.0 mm)

The Ratchet P-Clamp family offers versatility when managing wires, cables and hoses. The robust design and durable materials make it ideal for heavy duty applications, both indoors and out. The one-piece adjustable clamp can be closed by hand to the desired diameter. The release feature provides easy and nondestructive removal of cables simply by using a flat-head screwdriver. This nondestructive release allows the clamp to be reused without removing or replacing any bolts or screws. The Ratchet P-Clamp is offered in four sizes and multiple mounting configurations.

Features and Benefits

- One-piece ratchet closure design allows for easy installation during pre- or final assembly.
- Four sizes and multiple configurations handle a wide range of diameters and applications, reducing part inventory.
- Clamp interior is designed to guide and center bundle to reduce pinching.
- Easy release feature allows for quick adjustments and maintenance.
- Impact modified, heat and UV stabilized PA66 provides long-term durability, indoors and out.
- Steel mounting plate tolerates high torque mounting and is treated to resist chemicals and salt spray.

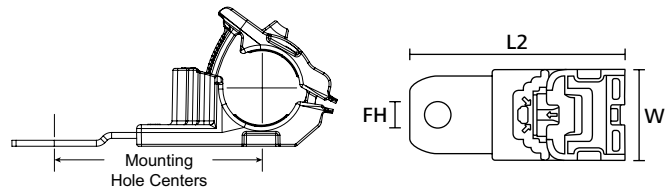

PART NO.	TYPE	Min. Tensile Strength lbs. (N)	Mounting Hole Centers in. (mm)	Mounting Hole Dia. in. (mm)	Angle/Length	Length (L2) in. (mm)	Width (W) in. (mm)	Material	Pkg. Qty.
151-01656*	RCC15SM6	100.0 (445.0)	2.5 (62.3)	0.3 (6.5)	15 ° Short	4.1 (103.5)	1.4 (34.9)	PA66HIRHSUV, ST, ZN	160
151-01483*	RCC15SM8	100.0 (445.0)	2.5 (62.3)	0.3 (8.31)	15 ° Short	4.1 (103.5)	1.4 (34.9)	PA66HIRHSUV, ST, ZN	160
151-01484*	RCC15SM10	100.0 (445.0)	2.5 (62.3)	0.4 (10.29)	15 ° Short	4.1 (103.5)	1.4 (34.9)	PA66HIRHSUV, ST, ZN	160
151-01485*	RCC15SM12	100.0 (445.0)	2.5 (62.3)	0.5 (12.95)	15 ° Short	4.1 (103.5)	1.4 (34.9)	PA66HIRHSUV, ST, ZN	160
151-01658*	RCC30LM6	100.0 (445.0)	3.0 (75.2)	0.3 (6.5)	30 ° Long	4.5 (114.9)	1.4 (34.9)	PA66HIRHSUV, ST, ZN	140
151-01489*	RCC30LM8	100.0 (445.0)	3.0 (75.2)	0.3 (8.31)	30 ° Long	4.5 (114.9)	1.4 (34.9)	PA66HIRHSUV, ST, ZN	140
151-01490*	RCC30LM10	100.0 (445.0)	3.0 (75.2)	0.4 (10.29)	30 ° Long	4.5 (114.9)	1.4 (34.9)	PA66HIRHSUV, ST, ZN	140
151-01491*	RCC30LM12	100.0 (445.0)	3.0 (75.2)	0.5 (12.95)	30 ° Long	4.5 (114.9)	1.4 (34.9)	PA66HIRHSUV, ST, ZN	140
151-01657*	RCC30SM6	100.0 (445.0)	2.0 (50.5)	0.3 (6.5)	30 ° Short	3.6 (90.2)	1.4 (34.9)	PA66HIRHSUV, ST, ZN	160
151-01486*	RCC30SM8	100.0 (445.0)	2.0 (50.5)	0.3 (8.31)	30 ° Short	3.6 (90.2)	1.4 (34.9)	PA66HIRHSUV, ST, ZN	160
151-01487*	RCC30SM10	100.0 (445.0)	2.0 (50.5)	0.4 (10.29)	30 ° Short	3.6 (90.2)	1.4 (34.9)	PA66HIRHSUV, ST, ZN	160

Dimensions are approximate and subject to technical changes. Use Part No. for ordering and Type for specification purposes.

*This product meets UL standards. Please see appendix for specific file numbers.



Please note! Not all products listed on this page may have this approval. Please check our website for latest approvals.

Bundling and Securing

Clamps

Ratchet P-Clamps

Size C - For bundle diameters from 3/4" to 1 3/8" (19.4 mm to 36.0 mm)

PART NO.	TYPE	Min. Tensile Strength lbs. (N)	Mounting Hole Centers in. (mm)	Mounting Hole Dia. in. (mm)	Angle/Length	Length (L2) in. (mm)	Width (W) in. (mm)	Material	Pkg. Qty.
151-01488*	RCC30SM12	100.0 (445.0)	2.0 (50.5)	0.5 (12.95)	30 ° Short	3.6 (90.2)	1.4 (34.9)	PA66HIRHSUV, ST, ZN	160
151-01660*	RCC90LM6	100.0 (445.0)	1.6 (39.9)	0.3 (6.5)	90 ° Long	5.1 (129.2)	1.4 (34.9)	PA66HIRHSUV, ST, ZN	140
151-01495*	RCC90LM8	100.0 (445.0)	1.6 (39.9)	0.3 (8.31)	90 ° Long	5.1 (129.2)	1.4 (34.9)	PA66HIRHSUV, ST, ZN	140
151-01496*	RCC90LM10	100.0 (445.0)	1.6 (39.9)	0.4 (10.29)	90 ° Long	5.1 (129.2)	1.4 (34.9)	PA66HIRHSUV, ST, ZN	140
151-01497*	RCC90LM12	100.0 (445.0)	1.6 (39.9)	0.5 (12.95)	90 ° Long	5.1 (129.2)	1.4 (34.9)	PA66HIRHSUV, ST, ZN	140
151-01659*	RCC90SM6	100.0 (445.0)	1.6 (39.9)	0.3 (6.5)	90 ° Short	4.0 (101.2)	1.4 (34.9)	PA66HIRHSUV, ST, ZN	160
151-01492*	RCC90SM8	100.0 (445.0)	1.6 (39.9)	0.3 (8.31)	90 ° Short	4.0 (101.2)	1.4 (34.9)	PA66HIRHSUV, ST, ZN	160
151-01493*	RCC90SM10	100.0 (445.0)	1.6 (39.9)	0.4 (10.29)	90 ° Short	4.0 (101.2)	1.4 (34.9)	PA66HIRHSUV, ST, ZN	160
151-01494*	RCC90SM12	100.0 (445.0)	1.6 (39.9)	0.5 (12.95)	90 ° Short	4.0 (101.2)	1.4 (34.9)	PA66HIRHSUV, ST, ZN	160
151-01655*	RCC180LM6	100.0 (445.0)	4.5 (113.3)	0.3 (6.5)	180 ° Long	6.1 (154.0)	1.4 (34.9)	PA66HIRHSUV, ST, ZN	140
151-01480*	RCC180LM8	100.0 (445.0)	4.5 (113.3)	0.3 (8.31)	180 ° Long	6.1 (154.0)	1.4 (34.9)	PA66HIRHSUV, ST, ZN	140
151-01481*	RCC180LM10	100.0 (445.0)	4.5 (113.3)	0.4 (10.29)	180 ° Long	6.1 (154.0)	1.4 (34.9)	PA66HIRHSUV, ST, ZN	140
151-01482*	RCC180LM12	100.0 (445.0)	4.5 (113.3)	0.5 (12.95)	180 ° Long	6.1 (154.0)	1.4 (34.9)	PA66HIRHSUV, ST, ZN	140
151-01654*	RCC180MM6	100.0 (445.0)	3.3 (84.3)	0.3 (6.5)	180 ° Medium	4.9 (125.0)	1.4 (34.9)	PA66HIRHSUV, ST, ZN	140
151-01477*	RCC180MM8	100.0 (445.0)	3.3 (84.3)	0.3 (8.31)	180 ° Medium	4.9 (125.0)	1.4 (34.9)	PA66HIRHSUV, ST, ZN	140
151-01478*	RCC180MM10	100.0 (445.0)	3.3 (84.3)	0.4 (10.29)	180 ° Medium	4.9 (125.0)	1.4 (34.9)	PA66HIRHSUV, ST, ZN	140
151-01479*	RCC180MM12	100.0 (445.0)	3.3 (84.3)	0.5 (12.95)	180 ° Medium	4.9 (125.0)	1.4 (34.9)	PA66HIRHSUV, ST, ZN	140
151-01653*	RCC180SM6	100.0 (445.0)	2.5 (62.3)	0.3 (6.5)	180 ° Short	4.1 (103.0)	1.4 (34.9)	PA66HIRHSUV, ST, ZN	160
151-01672*		100.0 (445.0)	2.5 (62.3)	0.3 (6.5)	180 ° Short	4.1 (103.0)	1.4 (34.9)	PA66HIRHSUV, ST, ZN	3
151-01474*	RCC180SM8	100.0 (445.0)	2.5 (62.3)	0.3 (8.31)	180 ° Short	4.1 (103.0)	1.4 (34.9)	PA66HIRHSUV, ST, ZN	160
151-01475*	RCC180SM10	100.0 (445.0)	2.5 (62.3)	0.4 (10.29)	180 ° Short	4.1 (103.0)	1.4 (34.9)	PA66HIRHSUV, ST, ZN	160
151-01476*	RCC180SM12	100.0 (445.0)	2.5 (62.3)	0.5 (12.95)	180 ° Short	4.1 (103.0)	1.4 (34.9)	PA66HIRHSUV, ST, ZN	160

Dimensions are approximate and subject to technical changes. Use Part No. for ordering and Type for specification purposes.

*This product meets UL standards. Please see appendix for specific file numbers.



Please note! Not all products listed on this page may have this approval. Please check our website for latest approvals.

Ratchet P-Clamps

Size D - For bundle diameters from 1 3/8" to 2" (36.0 mm to 51.0 mm)

The Ratchet P-Clamp family offers versatility when managing wires, cables and hoses. The robust design and durable materials make it ideal for heavy duty applications, both indoors and out. The one-piece adjustable clamp can be closed by hand to the desired diameter. The release feature provides easy and nondestructive removal of cables simply by using a flat-head screwdriver. This nondestructive release allows the clamp to be reused without removing or replacing any bolts or screws. The Ratchet P-Clamp is offered in four sizes and multiple mounting configurations.

Features and Benefits

- One-piece ratchet closure design allows for easy installation during pre- or final assembly.
- Four sizes and multiple configurations handle a wide range of diameters and applications, reducing part inventory.
- Clamp interior is designed to guide and center bundle to reduce pinching.
- Easy release feature allows for quick adjustments and maintenance.
- Impact modified, heat and UV stabilized PA66 provides long-term durability, indoors and out.
- Steel mounting plate tolerates high torque mounting and is treated to resist chemicals and salt spray.

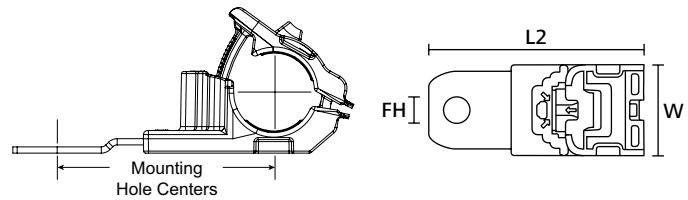

PART NO.	TYPE	Min. Tensile Strength lbs. (N)	Mounting Hole Centers in. (mm)	Mounting Hole Dia. in. (mm)	Angle/Length	Length (L2) in. (mm)	Width (W) in. (mm)	Material	Pkg. Qty.
151-01664*	RCD15SM6	100.0 (445.0)	2.7 (69.1)	0.3 (6.5)	15 ° Short	4.6 (115.9)	1.4 (34.9)	PA66HIRHSUV, ST, ZN	160
151-01509*	RCD15SM8	100.0 (445.0)	2.7 (69.1)	0.3 (8.31)	15 ° Short	4.6 (115.9)	1.4 (34.9)	PA66HIRHSUV, ST, ZN	160
151-01510*	RCD15SM10	100.0 (445.0)	2.7 (69.1)	0.4 (10.29)	15 ° Short	4.6 (115.9)	1.4 (34.9)	PA66HIRHSUV, ST, ZN	160
151-01511*	RCD15SM12	100.0 (445.0)	2.7 (69.1)	0.5 (12.95)	15 ° Short	4.6 (115.9)	1.4 (34.9)	PA66HIRHSUV, ST, ZN	160
151-01666*	RCD30LM6	100.0 (445.0)	3.2 (80.5)	0.3 (6.5)	30 ° Long	5.0 (127.0)	1.4 (34.9)	PA66HIRHSUV, ST, ZN	140
151-01515*	RCD30LM8	100.0 (445.0)	3.2 (80.5)	0.3 (8.31)	30 ° Long	5.0 (127.0)	1.4 (34.9)	PA66HIRHSUV, ST, ZN	140
151-01516*	RCD30LM10	100.0 (445.0)	3.2 (80.5)	0.4 (10.29)	30 ° Long	5.0 (127.0)	1.4 (34.9)	PA66HIRHSUV, ST, ZN	140
151-01517*	RCD30LM12	100.0 (445.0)	3.2 (80.5)	0.5 (12.95)	30 ° Long	5.0 (127.0)	1.4 (34.9)	PA66HIRHSUV, ST, ZN	140
151-01665*	RCD30SM6	100.0 (445.0)	2.2 (55.9)	0.3 (6.5)	30 ° Short	4.0 (102.4)	1.4 (34.9)	PA66HIRHSUV, ST, ZN	160
151-01512*	RCD30SM8	100.0 (445.0)	2.2 (55.9)	0.3 (8.31)	30 ° Short	4.0 (102.4)	1.4 (34.9)	PA66HIRHSUV, ST, ZN	160
151-01513*	RCD30SM10	100.0 (445.0)	2.2 (55.9)	0.4 (10.29)	30 ° Short	4.0 (102.4)	1.4 (34.9)	PA66HIRHSUV, ST, ZN	160

Dimensions are approximate and subject to technical changes. Use Part No. for ordering and Type for specification purposes.

*This product meets UL standards. Please see appendix for specific file numbers.



Please note! Not all products listed on this page may have this approval. Please check our website for latest approvals.

Bundling and Securing

Clamps

Ratchet P-Clamps

Size D - For bundle diameters from 1 3/8" to 2" (36.0 mm to 51.0 mm)

PART NO.	TYPE	Min. Tensile Strength lbs. (N)	Mounting Hole Centers in. (mm)	Mounting Hole Dia. in. (mm)	Angle/Length	Length (L2) in. (mm)	Width (W) in. (mm)	Material	Pkg. Qty.
151-01514*	RCD30SM12	100.0 (445.0)	2.2 (55.9)	0.5 (12.95)	30 ° Short	4.0 (102.4)	1.4 (34.9)	PA66HIRHSUV, ST, ZN	160
151-01628*	RCD90LM6	100.0 (445.0)	1.7 (42.4)	0.3 (6.5)	90 ° Long	4.6 (116.7)	1.4 (34.9)	PA66HIRHSUV, ST, ZN	140
151-01521*	RCD90LM8	100.0 (445.0)	1.7 (42.4)	0.3 (8.31)	90 ° Long	4.6 (116.7)	1.4 (34.9)	PA66HIRHSUV, ST, ZN	140
151-01522*	RCD90LM10	100.0 (445.0)	1.7 (42.4)	0.4 (10.29)	90 ° Long	4.6 (116.7)	1.4 (34.9)	PA66HIRHSUV, ST, ZN	140
151-01523*	RCD90LM12	100.0 (445.0)	1.7 (42.4)	0.5 (12.95)	90 ° Long	4.6 (116.7)	1.4 (34.9)	PA66HIRHSUV, ST, ZN	140
151-01667*	RCD90SM6	100.0 (445.0)	1.7 (42.4)	0.3 (6.5)	90 ° Short	3.5 (88.7)	1.4 (34.9)	PA66HIRHSUV, ST, ZN	160
151-01518*	RCD90SM8	100.0 (445.0)	1.7 (42.4)	0.3 (8.31)	90 ° Short	3.5 (88.7)	1.4 (34.9)	PA66HIRHSUV, ST, ZN	160
151-01519*	RCD90SM10	100.0 (445.0)	1.7 (42.4)	0.4 (10.29)	90 ° Short	3.5 (88.7)	1.4 (34.9)	PA66HIRHSUV, ST, ZN	160
151-01520*	RCD90SM12	100.0 (445.0)	1.7 (42.4)	0.5 (12.95)	90 ° Short	3.5 (88.7)	1.4 (34.9)	PA66HIRHSUV, ST, ZN	160
151-01663*	RCD180LM6	100.0 (445.0)	4.8 (121.0)	0.3 (6.5)	180 ° Long	6.6 (166.5)	1.4 (34.9)	PA66HIRHSUV, ST, ZN	140
151-01506*	RCD180LM8	100.0 (445.0)	4.8 (121.0)	0.3 (8.31)	180 ° Long	6.6 (166.5)	1.4 (34.9)	PA66HIRHSUV, ST, ZN	140
151-01507*	RCD180LM10	100.0 (445.0)	4.8 (121.0)	0.4 (10.29)	180 ° Long	6.6 (166.5)	1.4 (34.9)	PA66HIRHSUV, ST, ZN	140
151-01508*	RCD180LM12	100.0 (445.0)	4.8 (121.0)	0.5 (12.95)	180 ° Long	6.6 (166.5)	1.4 (34.9)	PA66HIRHSUV, ST, ZN	140
151-01662*	RCD180MM6	100.0 (445.0)	3.6 (92.0)	0.3 (6.5)	180 ° Medium	5.4 (137.5)	1.4 (34.9)	PA66HIRHSUV, ST, ZN	140
151-01503*	RCD180MM8	100.0 (445.0)	3.6 (92.0)	0.3 (8.31)	180 ° Medium	5.4 (137.5)	1.4 (34.9)	PA66HIRHSUV, ST, ZN	140
151-01504*	RCD180MM10	100.0 (445.0)	3.6 (92.0)	0.4 (10.29)	180 ° Medium	5.4 (137.5)	1.4 (34.9)	PA66HIRHSUV, ST, ZN	140
151-01505*	RCD180MM12	100.0 (445.0)	3.6 (92.0)	0.5 (12.95)	180 ° Medium	5.4 (137.5)	1.4 (34.9)	PA66HIRHSUV, ST, ZN	140
151-01661*	RCD180SM6	100.0 (445.0)	2.8 (70.0)	0.3 (6.5)	180 ° Short	4.6 (115.5)	1.4 (34.9)	PA66HIRHSUV, ST, ZN	160
151-01673*		100.0 (445.0)	2.8 (70.0)	0.3 (6.5)	180 ° Short	4.6 (115.5)	1.4 (34.9)	PA66HIRHSUV, ST, ZN	3
151-01499*	RCD180SM8	100.0 (445.0)	2.8 (70.0)	0.3 (8.31)	180 ° Short	4.6 (115.5)	1.4 (34.9)	PA66HIRHSUV, ST, ZN	160
151-01501*	RCD180SM10	100.0 (445.0)	2.8 (70.0)	0.4 (10.29)	180 ° Short	4.6 (115.5)	1.4 (34.9)	PA66HIRHSUV, ST, ZN	160
151-01502*	RCD180SM12	100.0 (445.0)	2.8 (70.0)	0.5 (12.95)	180 ° Short	4.6 (115.5)	1.4 (34.9)	PA66HIRHSUV, ST, ZN	160

Dimensions are approximate and subject to technical changes. Use Part No. for ordering and Type for specification purposes.

*This product meets UL standards. Please see appendix for specific file numbers.



Please note! Not all products listed on this page may have this approval. Please check our website for latest approvals.

Stainless Steel Ratchet P-Clamp

Size A - For bundle diameters from ¼" to ½" (6.2 mm to 13.7 mm)

The Ratchet P-Clamp family offers versatility when managing wires, cables and hoses. The robust design and durable materials make it ideal for heavy duty applications, both indoors and out. The one-piece adjustable clamp can be closed by hand to the desired diameter. The release feature provides easy and nondestructive removal of cables simply by using a flat-head screwdriver. This nondestructive release allows the clamp to be reused without removing or replacing any bolts or screws. The Ratchet P-Clamp is offered in four sizes and multiple mounting configurations.

Features and Benefits

- One-piece ratchet closure design allows for easy installation during pre- or final assembly.
- Four sizes and multiple configurations handle a wide range of diameters and applications, reducing part inventory.
- Clamp interior is designed to guide and center bundle to reduce pinching.
- Easy release feature allows for quick adjustments and maintenance.
- Impact modified, heat and UV stabilized PA66 provides long-term durability, indoors and out.
- Stainless steel mounting plate tolerates high torque mounting and resists galvanic corrosion with dissimilar metals and harsh chemicals.

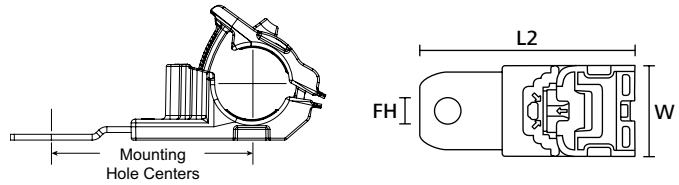

PART NO.	TYPE	Min. Tensile Strength lbs. (N)	Mounting Hole Centers in. (mm)	Mounting Hole Dia. in. (mm)	Angle/Length	Length (L2) in. (mm)	Width (W) in. (mm)	Material	Pkg. Qty.
151-01923*	RCA15SM6SS	100.0 (445.0)	2.2 (54.7)	0.3 (6.5)	15 ° Short	3.4 (86.9)	1.4 (34.9)	PA66HIRHSUV, SS304	300
151-01924*	RCA15SM8SS	100.0 (445.0)	2.2 (54.7)	0.3 (8.31)	15 ° Short	3.4 (86.9)	1.4 (34.9)	PA66HIRHSUV, SS304	300
151-01925*	RCA15SM10SS	100.0 (445.0)	2.2 (54.7)	0.4 (10.29)	15 ° Short	3.4 (86.9)	1.4 (34.9)	PA66HIRHSUV, SS304	300
151-01926*	RCA15SM12SS	100.0 (445.0)	2.2 (54.7)	0.5 (12.95)	15 ° Short	3.4 (86.9)	1.4 (34.9)	PA66HIRHSUV, SS304	300
151-01931*	RCA30LM6SS	100.0 (445.0)	2.9 (72.4)	0.3 (6.5)	30 ° Long	4.1 (103.2)	1.4 (34.9)	PA66HIRHSUV, SS304	200
151-01932*	RCA30LM8SS	100.0 (445.0)	2.9 (72.4)	0.3 (8.31)	30 ° Long	4.1 (103.2)	1.4 (34.9)	PA66HIRHSUV, SS304	200
151-01933*	RCA30LM10SS	100.0 (445.0)	2.9 (72.4)	0.4 (10.29)	30 ° Long	4.1 (103.2)	1.4 (34.9)	PA66HIRHSUV, SS304	200
151-01934*	RCA30LM12SS	100.0 (445.0)	2.9 (72.4)	0.5 (12.95)	30 ° Long	4.1 (103.2)	1.4 (34.9)	PA66HIRHSUV, SS304	200
151-01927*	RCA30SM6SS	100.0 (445.0)	1.9 (47.7)	0.3 (6.5)	30 ° Short	3.1 (78.5)	1.4 (34.9)	PA66HIRHSUV, SS304	300
151-01928*	RCA30SM8SS	100.0 (445.0)	1.9 (47.7)	0.3 (8.31)	30 ° Short	3.1 (78.5)	1.4 (34.9)	PA66HIRHSUV, SS304	300
151-01929*	RCA30SM10SS	100.0 (445.0)	1.9 (47.7)	0.4 (10.29)	30 ° Short	3.1 (78.5)	1.4 (34.9)	PA66HIRHSUV, SS304	300

Dimensions are approximate and subject to technical changes. Use Part No. for ordering and Type for specification purposes.

*This product meets UL standards. Please see appendix for specific file numbers.



Please note! Not all products listed on this page may have this approval. Please check our website for latest approvals.

Bundling and Securing

Clamps

Stainless Steel Ratchet P-Clamp

Size A - For bundle diameters from ¼" to ½" (6.2 mm to 13.7 mm)

PART NO.	TYPE	Min. Tensile Strength lbs. (N)	Mounting Hole Centers in. (mm)	Mounting Hole Dia. in. (mm)	Angle/Length	Length (L2) in. (mm)	Width (W) in. (mm)	Material	Pkg. Qty.
151-01930*	RCA30SM12SS	100.0 (445.0)	1.9 (47.7)	0.5 (12.95)	30 ° Short	3.1 (78.5)	1.4 (34.9)	PA66HIRHSUV, SS304	300
151-01939*	RCA90LM6SS	100.0 (445.0)	1.0 (24.9)	0.3 (6.5)	90 ° Long	3.8 (96.8)	1.4 (34.9)	PA66HIRHSUV, SS304	200
151-01940*	RCA90LM8SS	100.0 (445.0)	1.0 (24.9)	0.3 (8.31)	90 ° Long	3.8 (96.8)	1.4 (34.9)	PA66HIRHSUV, SS304	200
151-01941*	RCA90LM10SS	100.0 (445.0)	1.0 (24.9)	0.4 (10.29)	90 ° Long	3.8 (96.8)	1.4 (34.9)	PA66HIRHSUV, SS304	200
151-01942*	RCA90LM12SS	100.0 (445.0)	1.0 (24.9)	0.5 (12.95)	90 ° Long	3.8 (96.8)	1.4 (34.9)	PA66HIRHSUV, SS304	200
151-01935*	RCA90SM6SS	100.0 (445.0)	1.0 (24.9)	0.3 (6.5)	90 ° Short	2.7 (68.8)	1.4 (34.9)	PA66HIRHSUV, SS304	300
151-01936*	RCA90SM8SS	100.0 (445.0)	1.0 (24.9)	0.3 (8.31)	90 ° Short	2.7 (68.8)	1.4 (34.9)	PA66HIRHSUV, SS304	300
151-01937*	RCA90SM10SS	100.0 (445.0)	1.0 (24.9)	0.4 (10.29)	90 ° Short	2.7 (68.8)	1.4 (34.9)	PA66HIRHSUV, SS304	300
151-01938*	RCA90SM12SS	100.0 (445.0)	1.0 (24.9)	0.5 (12.95)	90 ° Short	2.7 (68.8)	1.4 (34.9)	PA66HIRHSUV, SS304	300
151-01919*	RCA180LM6SS	100.0 (445.0)	4.0 (101.5)	0.3 (6.5)	180 ° Long	5.3 (134.1)	1.4 (34.9)	PA66HIRHSUV, SS304	200
151-01920*	RCA180LM8SS	100.0 (445.0)	4.0 (101.5)	0.3 (8.31)	180 ° Long	5.3 (134.1)	1.4 (34.9)	PA66HIRHSUV, SS304	200
151-01921*	RCA180LM10SS	100.0 (445.0)	4.0 (101.5)	0.4 (10.29)	180 ° Long	5.3 (134.1)	1.4 (34.9)	PA66HIRHSUV, SS304	200
151-01922*	RCA180LM12SS	100.0 (445.0)	4.0 (101.5)	0.5 (12.95)	180 ° Long	5.3 (134.1)	1.4 (34.9)	PA66HIRHSUV, SS304	200
151-01915*	RCA180MM6SS	100.0 (445.0)	2.9 (72.5)	0.3 (6.5)	180 ° Medium	4.1 (105.1)	1.4 (34.9)	PA66HIRHSUV, SS304	200
151-01916*	RCA180MM8SS	100.0 (445.0)	2.9 (72.5)	0.3 (8.31)	180 ° Medium	4.1 (105.1)	1.4 (34.9)	PA66HIRHSUV, SS304	200
151-01917*	RCA180MM10SS	100.0 (445.0)	2.9 (72.5)	0.4 (10.29)	180 ° Medium	4.1 (105.1)	1.4 (34.9)	PA66HIRHSUV, SS304	200
151-01918*	RCA180MM12SS	100.0 (445.0)	2.9 (72.5)	0.5 (12.95)	180 ° Medium	4.1 (105.1)	1.4 (34.9)	PA66HIRHSUV, SS304	200
151-01911*	RCA180SM6SS	100.0 (445.0)	2.0 (50.5)	0.3 (6.5)	180 ° Short	3.3 (83.1)	1.4 (34.9)	PA66HIRHSUV, SS304	300
151-01912*	RCA180SM8SS	100.0 (445.0)	2.0 (50.5)	0.3 (8.31)	180 ° Short	3.3 (83.1)	1.4 (34.9)	PA66HIRHSUV, SS304	300
151-01913*	RCA180SM10SS	100.0 (445.0)	2.0 (50.5)	0.4 (10.29)	180 ° Short	3.3 (83.1)	1.4 (34.9)	PA66HIRHSUV, SS304	300
151-01914*	RCA180SM12SS	100.0 (445.0)	2.0 (50.5)	0.5 (12.95)	180 ° Short	3.3 (83.1)	1.4 (34.9)	PA66HIRHSUV, SS304	300

Dimensions are approximate and subject to technical changes. Use Part No. for ordering and Type for specification purposes.

*This product meets UL standards. Please see appendix for specific file numbers.



Please note! Not all products listed on this page may have this approval. Please check our website for latest approvals.

Stainless Steel Ratchet P-Clamp

Size B - For bundle diameters from 1/2" to 3/4" (12.7 mm to 19.5 mm)

The Ratchet P-Clamp family offers versatility when managing wires, cables and hoses. The robust design and durable materials make it ideal for heavy duty applications, both indoors and out. The one-piece adjustable clamp can be closed by hand to the desired diameter. The release feature provides easy and nondestructive removal of cables simply by using a flat-head screwdriver. This nondestructive release allows the clamp to be reused without removing or replacing any bolts or screws. The Ratchet P-Clamp is offered in four sizes and multiple mounting configurations.

Features and Benefits

- One-piece ratchet closure design allows for easy installation during pre- or final assembly.
- Four sizes and multiple configurations handle a wide range of diameters and applications, reducing part inventory.
- Clamp interior is designed to guide and center bundle to reduce pinching.
- Easy release feature allows for quick adjustments and maintenance.
- Impact modified, heat and UV stabilized PA66 provides long-term durability, indoors and out.
- Stainless steel mounting plate tolerates high torque mounting, resists galvanic corrosion with dissimilar metals, and harsh chemicals.

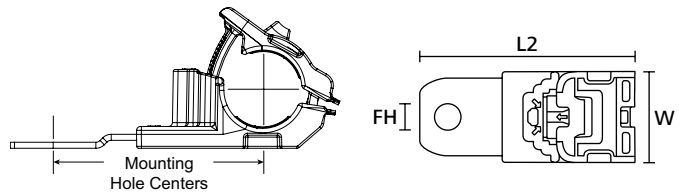

PART NO.	TYPE	Min. Tensile Strength lbs. (N)	Mounting Hole Centers in. (mm)	Mounting Hole Dia. in. (mm)	Angle/Length	Length (L2) in. (mm)	Width (W) in. (mm)	Material	Pkg. Qty.
151-01955*	RCB15SM6SS	100.0 (445.0)	2.2 (56.5)	0.3 (6.5)	15 ° Short	3.4 (86.9)	1.4 (34.9)	PA66HIRHSUV, SS304	280
151-01956*	RCB15SM8SS	100.0 (445.0)	2.2 (56.5)	0.3 (8.31)	15 ° Short	3.4 (86.9)	1.4 (34.9)	PA66HIRHSUV, SS304	280
151-01957*	RCB15SM10SS	100.0 (445.0)	2.2 (56.5)	0.4 (10.29)	15 ° Short	3.4 (86.9)	1.4 (34.9)	PA66HIRHSUV, SS304	280
151-01958*	RCB15SM12SS	100.0 (445.0)	2.2 (56.5)	0.5 (12.95)	15 ° Short	3.4 (86.9)	1.4 (34.9)	PA66HIRHSUV, SS304	280
151-01963*	RCB30LM6SS	100.0 (445.0)	2.9 (73.5)	0.3 (6.5)	30 ° Long	4.1 (103.2)	1.4 (34.9)	PA66HIRHSUV, SS304	200
151-01964*	RCB30LM8SS	100.0 (445.0)	2.9 (73.5)	0.3 (8.31)	30 ° Long	4.1 (103.2)	1.4 (34.9)	PA66HIRHSUV, SS304	200
151-01965*	RCB30LM10SS	100.0 (445.0)	2.9 (73.5)	0.4 (10.29)	30 ° Long	4.1 (103.2)	1.4 (34.9)	PA66HIRHSUV, SS304	200
151-01966*	RCB30LM12SS	100.0 (445.0)	2.9 (73.5)	0.5 (12.95)	30 ° Long	4.1 (103.2)	1.4 (34.9)	PA66HIRHSUV, SS304	200
151-01959*	RCB30SM6SS	100.0 (445.0)	1.9 (48.8)	0.3 (6.5)	30 ° Short	3.1 (78.5)	1.4 (34.9)	PA66HIRHSUV, SS304	280
151-01960*	RCB30SM8SS	100.0 (445.0)	1.9 (48.8)	0.3 (8.31)	30 ° Short	3.1 (78.5)	1.4 (34.9)	PA66HIRHSUV, SS304	280
151-01961*	RCB30SM10SS	100.0 (445.0)	1.9 (48.8)	0.4 (10.29)	30 ° Short	3.1 (78.5)	1.4 (34.9)	PA66HIRHSUV, SS304	280

Dimensions are approximate and subject to technical changes. Use Part No. for ordering and Type for specification purposes.
 *This product meets UL standards. Please see appendix for specific file numbers.



Please note! Not all products listed on this page may have this approval. Please check our website for latest approvals.

Bundling and Securing

Clamps

Stainless Steel Ratchet P-Clamp

Size B - For bundle diameters from ½" to ¾" (12.7 mm to 19.5 mm)

PART NO.	TYPE	Min. Tensile Strength lbs. (N)	Mounting Hole Centers in. (mm)	Mounting Hole Dia. in. (mm)	Angle/Length	Length (L2) in. (mm)	Width (W) in. (mm)	Material	Pkg. Qty.
151-01962*	RCB30SM12SS	100.0 (445.0)	1.9 (48.8)	0.5 (12.95)	30 ° Short	3.1 (78.5)	1.4 (34.9)	PA66HIRHSUV, SS304	280
151-01971*	RCB90LM6SS	100.0 (445.0)	1.1 (26.7)	0.3 (6.5)	90 ° Long	3.8 (96.8)	1.4 (34.9)	PA66HIRHSUV, SS304	200
151-01972*	RCB90LM8SS	100.0 (445.0)	1.1 (26.7)	0.3 (8.31)	90 ° Long	3.8 (96.8)	1.4 (34.9)	PA66HIRHSUV, SS304	200
151-01973*	RCB90LM10SS	100.0 (445.0)	1.1 (26.7)	0.4 (10.29)	90 ° Long	3.8 (96.8)	1.4 (34.9)	PA66HIRHSUV, SS304	200
151-01974*	RCB90LM12SS	100.0 (445.0)	1.1 (26.7)	0.5 (12.95)	90 ° Long	3.8 (96.8)	1.4 (34.9)	PA66HIRHSUV, SS304	200
151-01967*	RCB90SM6SS	100.0 (445.0)	1.1 (26.7)	0.3 (6.5)	90 ° Short	2.7 (68.8)	1.4 (34.9)	PA66HIRHSUV, SS304	280
151-01968*	RCB90SM8SS	100.0 (445.0)	1.1 (26.7)	0.3 (8.31)	90 ° Short	2.7 (68.8)	1.4 (34.9)	PA66HIRHSUV, SS304	280
151-01969*	RCB90SM10SS	100.0 (445.0)	1.1 (26.7)	0.4 (10.29)	90 ° Short	2.7 (68.8)	1.4 (34.9)	PA66HIRHSUV, SS304	280
151-01970*	RCB90SM12SS	100.0 (445.0)	1.1 (26.7)	0.5 (12.95)	90 ° Short	2.7 (68.8)	1.4 (34.9)	PA66HIRHSUV, SS304	280
151-01951*	RCB180LM6SS	100.0 (445.0)	4.1 (103.8)	0.3 (6.5)	180 ° Long	5.3 (134.1)	1.4 (34.9)	PA66HIRHSUV, SS304	200
151-01952*	RCB180LM8SS	100.0 (445.0)	4.1 (103.8)	0.3 (8.31)	180 ° Long	5.3 (134.1)	1.4 (34.9)	PA66HIRHSUV, SS304	200
151-01953*	RCB180LM10SS	100.0 (445.0)	4.1 (103.8)	0.4 (10.29)	180 ° Long	5.3 (134.1)	1.4 (34.9)	PA66HIRHSUV, SS304	200
151-01954*	RCB180LM12SS	100.0 (445.0)	4.1 (103.8)	0.5 (12.95)	180 ° Long	5.3 (134.1)	1.4 (34.9)	PA66HIRHSUV, SS304	200
151-01947*	RCB180MM6SS	100.0 (445.0)	2.9 (74.8)	0.3 (6.5)	180 ° Medium	4.1 (105.1)	1.4 (34.9)	PA66HIRHSUV, SS304	200
151-01948*	RCB180MM8SS	100.0 (445.0)	2.9 (74.8)	0.3 (8.31)	180 ° Medium	4.1 (105.1)	1.4 (34.9)	PA66HIRHSUV, SS304	200
151-01949*	RCB180MM10SS	100.0 (445.0)	2.9 (74.8)	0.4 (10.29)	180 ° Medium	4.1 (105.1)	1.4 (34.9)	PA66HIRHSUV, SS304	200
151-01950*	RCB180MM12SS	100.0 (445.0)	2.9 (74.8)	0.5 (12.95)	180 ° Medium	4.1 (105.1)	1.4 (34.9)	PA66HIRHSUV, SS304	200
151-01943*	RCB180SM6SS	100.0 (445.0)	2.1 (52.8)	0.3 (6.5)	180 ° Short	3.3 (83.1)	1.4 (34.9)	PA66HIRHSUV, SS304	280
151-01944*	RCB180SM8SS	100.0 (445.0)	2.1 (52.8)	0.3 (8.31)	180 ° Short	3.3 (83.1)	1.4 (34.9)	PA66HIRHSUV, SS304	280
151-01945*	RCB180SM10SS	100.0 (445.0)	2.1 (52.8)	0.4 (10.29)	180 ° Short	3.3 (83.1)	1.4 (34.9)	PA66HIRHSUV, SS304	280
151-01946*	RCB180SM12SS	100.0 (445.0)	2.1 (52.8)	0.5 (12.95)	180 ° Short	3.3 (83.1)	1.4 (34.9)	PA66HIRHSUV, SS304	280

Dimensions are approximate and subject to technical changes. Use Part No. for ordering and Type for specification purposes.

*This product meets UL standards. Please see appendix for specific file numbers.



Please note! Not all products listed on this page may have this approval. Please check our website for latest approvals.

Stainless Steel Ratchet P-Clamp

Size C - For bundle diameters from 3/4" to 1 3/8" (19.4 mm to 36.0 mm)

The Ratchet P-Clamp family offers versatility when managing wires, cables and hoses. The robust design and durable materials make it ideal for heavy duty applications, both indoors and out. The one-piece adjustable clamp can be closed by hand to the desired diameter. The release feature provides easy and nondestructive removal of cables simply by using a flat-head screwdriver. This nondestructive release allows the clamp to be reused without removing or replacing any bolts or screws. The Ratchet P-Clamp is offered in four sizes and multiple mounting configurations.

Features and Benefits

- One-piece ratchet closure design allows for easy installation during pre- or final assembly.
- Four sizes and multiple configurations handle a wide range of diameters and applications, reducing part inventory.
- Clamp interior is designed to guide and center bundle to reduce pinching.
- Easy release feature allows for quick adjustments and maintenance.
- Impact modified, heat and UV stabilized PA66 provides long-term durability, indoors and out.
- Stainless steel mounting plate tolerates high torque mounting, resists galvanic corrosion with dissimilar metals, and harsh chemicals.

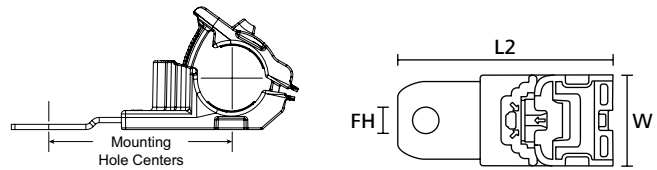

PART NO.	TYPE	Min. Tensile Strength lbs. (N)	Mounting Hole Centers in. (mm)	Mounting Hole Dia. in. (mm)	Angle/Length	Length (L2) in. (mm)	Width (W) in. (mm)	Material	Pkg. Qty.
151-01987*	RCC15SM6SS	100.0 (445.0)	2.5 (62.3)	0.3 (6.5)	15 ° Short	4.1 (103.5)	1.4 (34.9)	PA66HIRHSUV, SS304	160
151-01988*	RCC15SM8SS	100.0 (445.0)	2.5 (62.3)	0.3 (8.31)	15 ° Short	4.1 (103.5)	1.4 (34.9)	PA66HIRHSUV, SS304	160
151-01989*	RCC15SM10SS	100.0 (445.0)	2.5 (62.3)	0.4 (10.29)	15 ° Short	4.1 (103.5)	1.4 (34.9)	PA66HIRHSUV, SS304	160
151-01990*	RCC15SM12SS	100.0 (445.0)	2.5 (62.3)	0.5 (12.95)	15 ° Short	4.1 (103.5)	1.4 (34.9)	PA66HIRHSUV, SS304	160
151-01995*	RCC30LM6SS	100.0 (445.0)	3.0 (75.2)	0.3 (6.5)	30 ° Long	4.5 (114.9)	1.4 (34.9)	PA66HIRHSUV, SS304	140
151-01996*	RCC30LM8SS	100.0 (445.0)	3.0 (75.2)	0.3 (8.31)	30 ° Long	4.5 (114.9)	1.4 (34.9)	PA66HIRHSUV, SS304	140
151-01997*	RCC30LM10SS	100.0 (445.0)	3.0 (75.2)	0.4 (10.29)	30 ° Long	4.5 (114.9)	1.4 (34.9)	PA66HIRHSUV, SS304	140
151-01998*	RCC30LM12SS	100.0 (445.0)	3.0 (75.2)	0.5 (12.95)	30 ° Long	4.5 (114.9)	1.4 (34.9)	PA66HIRHSUV, SS304	140
151-01991*	RCC30SM6SS	100.0 (445.0)	2.0 (50.5)	0.3 (6.5)	30 ° Short	3.6 (90.2)	1.4 (34.9)	PA66HIRHSUV, SS304	160
151-01992*	RCC30SM8SS	100.0 (445.0)	2.0 (50.5)	0.3 (8.31)	30 ° Short	3.6 (90.2)	1.4 (34.9)	PA66HIRHSUV, SS304	160

Dimensions are approximate and subject to technical changes. Use Part No. for ordering and Type for specification purposes.

*This product meets UL standards. Please see appendix for specific file numbers.



Please note! Not all products listed on this page may have this approval. Please check our website for latest approvals.

Bundling and Securing

Clamps

Stainless Steel Ratchet P-Clamp

Size C - For bundle diameters from ¾" to 1⅜" (19.4 mm to 36.0 mm)

PART NO.	TYPE	Min. Tensile Strength lbs. (N)	Mounting Hole Centers in. (mm)	Mounting Hole Dia. in. (mm)	Angle/Length	Length (L2) in. (mm)	Width (W) in. (mm)	Material	Pkg. Qty.
151-01993*	RCC30SM10SS	100.0 (445.0)	2.0 (50.5)	0.4 (10.29)	30 ° Short	3.6 (90.2)	1.4 (34.9)	PA66HIRHSUV, SS304	160
151-01994*	RCC30SM12SS	100.0 (445.0)	2.0 (50.5)	0.5 (12.95)	30 ° Short	3.6 (90.2)	1.4 (34.9)	PA66HIRHSUV, SS304	160
151-02004*	RCC90LM6SS	100.0 (445.0)	1.6 (39.9)	0.3 (6.5)	90 ° Long	5.1 (129.2)	1.4 (34.9)	PA66HIRHSUV, SS304	140
151-02005*	RCC90LM8SS	100.0 (445.0)	1.6 (39.9)	0.3 (8.31)	90 ° Long	5.1 (129.2)	1.4 (34.9)	PA66HIRHSUV, SS304	140
151-02006*	RCC90LM10SS	100.0 (445.0)	1.6 (39.9)	0.4 (10.29)	90 ° Long	5.1 (129.2)	1.4 (34.9)	PA66HIRHSUV, SS304	140
151-02007*	RCC90LM12SS	100.0 (445.0)	1.6 (39.9)	0.5 (12.95)	90 ° Long	5.1 (129.2)	1.4 (34.9)	PA66HIRHSUV, SS304	140
151-01999*	RCC90SM6SS	100.0 (445.0)	1.6 (39.9)	0.3 (6.5)	90 ° Short	4.0 (101.2)	1.4 (34.9)	PA66HIRHSUV, SS304	160
151-02001*	RCC90SM8SS	100.0 (445.0)	1.6 (39.9)	0.3 (8.31)	90 ° Short	4.0 (101.2)	1.4 (34.9)	PA66HIRHSUV, SS304	160
151-02002*	RCC90SM10SS	100.0 (445.0)	1.6 (39.9)	0.4 (10.29)	90 ° Short	4.0 (101.2)	1.4 (34.9)	PA66HIRHSUV, SS304	160
151-02003*	RCC90SM12SS	100.0 (445.0)	1.6 (39.9)	0.5 (12.95)	90 ° Short	4.0 (101.2)	1.4 (34.9)	PA66HIRHSUV, SS304	160
151-01983*	RCC180LM6SS	100.0 (445.0)	4.5 (113.3)	0.3 (6.5)	180 ° Long	6.1 (154.0)	1.4 (34.9)	PA66HIRHSUV, SS304	140
151-01984*	RCC180LM8SS	100.0 (445.0)	4.5 (113.3)	0.3 (8.31)	180 ° Long	6.1 (154.0)	1.4 (34.9)	PA66HIRHSUV, SS304	140
151-01985*	RCC180LM10SS	100.0 (445.0)	4.5 (113.3)	0.4 (10.29)	180 ° Long	6.1 (154.0)	1.4 (34.9)	PA66HIRHSUV, SS304	140
151-01986*	RCC180LM12SS	100.0 (445.0)	4.5 (113.3)	0.5 (12.95)	180 ° Long	6.1 (154.0)	1.4 (34.9)	PA66HIRHSUV, SS304	140
151-01979*	RCC180MM6SS	100.0 (445.0)	3.3 (84.3)	0.3 (6.5)	180 ° Medium	4.9 (125.0)	1.4 (34.9)	PA66HIRHSUV, SS304	140
151-01980*	RCC180MM8SS	100.0 (445.0)	3.3 (84.3)	0.3 (8.31)	180 ° Medium	4.9 (125.0)	1.4 (34.9)	PA66HIRHSUV, SS304	140
151-01981*	RCC180MM10SS	100.0 (445.0)	3.3 (84.3)	0.4 (10.29)	180 ° Medium	4.9 (125.0)	1.4 (34.9)	PA66HIRHSUV, SS304	140
151-01982*	RCC180MM12SS	100.0 (445.0)	3.3 (84.3)	0.5 (12.95)	180 ° Medium	4.9 (125.0)	1.4 (34.9)	PA66HIRHSUV, SS304	140
151-01975*	RCC180SM6SS	100.0 (445.0)	2.5 (62.3)	0.3 (6.5)	180 ° Short	4.1 (103.0)	1.4 (34.9)	PA66HIRHSUV, SS304	160
151-01976*	RCC180SM8SS	100.0 (445.0)	2.5 (62.3)	0.3 (8.31)	180 ° Short	4.1 (103.0)	1.4 (34.9)	PA66HIRHSUV, SS304	160
151-01977*	RCC180SM10SS	100.0 (445.0)	2.5 (62.3)	0.4 (10.29)	180 ° Short	4.1 (103.0)	1.4 (34.9)	PA66HIRHSUV, SS304	160
151-01978*	RCC180SM12SS	100.0 (445.0)	2.5 (62.3)	0.5 (12.95)	180 ° Short	4.1 (103.0)	1.4 (34.9)	PA66HIRHSUV, SS304	160

Dimensions are approximate and subject to technical changes. Use Part No. for ordering and Type for specification purposes.

*This product meets UL standards. Please see appendix for specific file numbers.



Please note! Not all products listed on this page may have this approval. Please check our website for latest approvals.

Stainless Steel Ratchet P-Clamp

Size D - For bundle diameters from 1 3/8" to 2" (36.0 mm to 51.0 mm)

The Ratchet P-Clamp family offers versatility when managing wires, cables and hoses. The robust design and durable materials make it ideal for heavy duty applications, both indoors and out. The one-piece adjustable clamp can be closed by hand to the desired diameter. The release feature provides easy and nondestructive removal of cables simply by using a flat-head screwdriver. This nondestructive release allows the clamp to be reused without removing or replacing any bolts or screws. The Ratchet P-Clamp is offered in four sizes and multiple mounting configurations.

Features and Benefits

- One-piece ratchet closure design allows for easy installation during pre- or final assembly.
- Four sizes and multiple configurations handle a wide range of diameters and applications, reducing part inventory.
- Clamp interior is designed to guide and center bundle to reduce pinching.
- Easy release feature allows for quick adjustments and maintenance.
- Impact modified, heat and UV stabilized PA66 provides long-term durability, indoors and out.
- Stainless steel mounting plate tolerates high torque mounting, resists galvanic corrosion with dissimilar metals, and harsh chemicals.

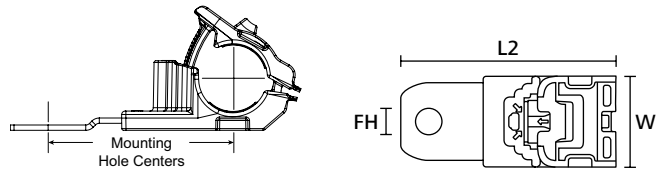

PART NO.	TYPE	Min. Tensile Strength lbs. (N)	Mounting Hole Centers in. (mm)	Mounting Hole Dia. in. (mm)	Angle/Length	Length (L2) in. (mm)	Width (W) in. (mm)	Material	Pkg. Qty.
151-02020*	RCD15SM6SS	100.0 (445.0)	2.7 (69.1)	0.3 (6.5)	15 ° Short	4.6 (115.9)	1.4 (34.9)	PA66HIRHSUV, SS304	160
151-02021*	RCD15SM8SS	100.0 (445.0)	2.7 (69.1)	0.3 (8.31)	15 ° Short	4.6 (115.9)	1.4 (34.9)	PA66HIRHSUV, SS304	160
151-02022*	RCD15SM10SS	100.0 (445.0)	2.7 (69.1)	0.4 (10.29)	15 ° Short	4.6 (115.9)	1.4 (34.9)	PA66HIRHSUV, SS304	160
151-02023*	RCD15SM12SS	100.0 (445.0)	2.7 (69.1)	0.5 (12.95)	15 ° Short	4.6 (115.9)	1.4 (34.9)	PA66HIRHSUV, SS304	160
151-02028*	RCD30LM6SS	100.0 (445.0)	3.2 (80.5)	0.3 (6.5)	30 ° Long	5.0 (127.0)	1.4 (34.9)	PA66HIRHSUV, SS304	140
151-02029*	RCD30LM8SS	100.0 (445.0)	3.2 (80.5)	0.3 (8.31)	30 ° Long	5.0 (127.0)	1.4 (34.9)	PA66HIRHSUV, SS304	140
151-02030*	RCD30LM10SS	100.0 (445.0)	3.2 (80.5)	0.4 (10.29)	30 ° Long	5.0 (127.0)	1.4 (34.9)	PA66HIRHSUV, SS304	140
151-02031*	RCD30LM12SS	100.0 (445.0)	3.2 (80.5)	0.5 (12.95)	30 ° Long	5.0 (127.0)	1.4 (34.9)	PA66HIRHSUV, SS304	140
151-02024*	RCD30SM6SS	100.0 (445.0)	2.2 (55.9)	0.3 (6.5)	30 ° Short	4.0 (102.4)	1.4 (34.9)	PA66HIRHSUV, SS304	160
151-02025*	RCD30SM8SS	100.0 (445.0)	2.2 (55.9)	0.3 (8.31)	30 ° Short	4.0 (102.4)	1.4 (34.9)	PA66HIRHSUV, SS304	160

Dimensions are approximate and subject to technical changes. Use Part No. for ordering and Type for specification purposes.

*This product meets UL standards. Please see appendix for specific file numbers.



Please note! Not all products listed on this page may have this approval. Please check our website for latest approvals.

Bundling and Securing

Clamps

Stainless Steel Ratchet P-Clamp

Size D - For bundle diameters from 1 3/8" to 2" (36.0 mm to 51.0 mm)

PART NO.	TYPE	Min. Tensile Strength lbs. (N)	Mounting Hole Centers in. (mm)	Mounting Hole Dia. in. (mm)	Angle/Length	Length (L2) in. (mm)	Width (W) in. (mm)	Material	Pkg. Qty.
151-02026*	RCD30SM10SS	100.0 (445.0)	2.2 (55.9)	0.4 (10.29)	30 ° Short	4.0 (102.4)	1.4 (34.9)	PA66HIRHSUV, SS304	160
151-02027*	RCD30SM12SS	100.0 (445.0)	2.2 (55.9)	0.5 (12.95)	30 ° Short	4.0 (102.4)	1.4 (34.9)	PA66HIRHSUV, SS304	160
151-02036*	RCD90LM6SS	100.0 (445.0)	1.7 (42.4)	0.3 (6.5)	90 ° Long	4.6 (116.7)	1.4 (34.9)	PA66HIRHSUV, SS304	140
151-02037*	RCD90LM8SS	100.0 (445.0)	1.7 (42.4)	0.3 (8.31)	90 ° Long	4.6 (116.7)	1.4 (34.9)	PA66HIRHSUV, SS304	140
151-02038*	RCD90LM10SS	100.0 (445.0)	1.7 (42.4)	0.4 (10.29)	90 ° Long	4.6 (116.7)	1.4 (34.9)	PA66HIRHSUV, SS304	140
151-02039*	RCD90LM12SS	100.0 (445.0)	1.7 (42.4)	0.5 (12.95)	90 ° Long	4.6 (116.7)	1.4 (34.9)	PA66HIRHSUV, SS304	140
151-02032*	RCD90SM6SS	100.0 (445.0)	1.7 (42.4)	0.3 (6.5)	90 ° Short	3.5 (88.7)	1.4 (34.9)	PA66HIRHSUV, SS304	160
151-02033*	RCD90SM8SS	100.0 (445.0)	1.7 (42.4)	0.3 (8.31)	90 ° Short	3.5 (88.7)	1.4 (34.9)	PA66HIRHSUV, SS304	160
151-02034*	RCD90SM10SS	100.0 (445.0)	1.7 (42.4)	0.4 (10.29)	90 ° Short	3.5 (88.7)	1.4 (34.9)	PA66HIRHSUV, SS304	160
151-02035*	RCD90SM12SS	100.0 (445.0)	1.7 (42.4)	0.5 (12.95)	90 ° Short	3.5 (88.7)	1.4 (34.9)	PA66HIRHSUV, SS304	160
151-02016*	RCD180LM6SS	100.0 (445.0)	4.8 (121.0)	0.3 (6.5)	180 ° Long	6.6 (166.5)	1.4 (34.9)	PA66HIRHSUV, SS304	140
151-02017*	RCD180LM8SS	100.0 (445.0)	4.8 (121.0)	0.3 (8.31)	180 ° Long	6.6 (166.5)	1.4 (34.9)	PA66HIRHSUV, SS304	140
151-02018*	RCD180LM10SS	100.0 (445.0)	4.8 (121.0)	0.4 (10.29)	180 ° Long	6.6 (166.5)	1.4 (34.9)	PA66HIRHSUV, SS304	140
151-02019*	RCD180LM12SS	100.0 (445.0)	4.8 (121.0)	0.5 (12.95)	180 ° Long	6.6 (166.5)	1.4 (34.9)	PA66HIRHSUV, SS304	140
151-02012*	RCD180MM6SS	100.0 (445.0)	3.6 (92.0)	0.3 (6.5)	180 ° Medium	5.4 (137.5)	1.4 (34.9)	PA66HIRHSUV, SS304	140
151-02013*	RCD180MM8SS	100.0 (445.0)	3.6 (92.0)	0.3 (8.31)	180 ° Medium	5.4 (137.5)	1.4 (34.9)	PA66HIRHSUV, SS304	140
151-02014*	RCD180MM10SS	100.0 (445.0)	3.6 (92.0)	0.4 (10.29)	180 ° Medium	5.4 (137.5)	1.4 (34.9)	PA66HIRHSUV, SS304	140
151-02015*	RCD180MM12SS	100.0 (445.0)	3.6 (92.0)	0.5 (12.95)	180 ° Medium	5.4 (137.5)	1.4 (34.9)	PA66HIRHSUV, SS304	140
151-02008*	RCD180SM6SS	100.0 (445.0)	2.8 (70.0)	0.3 (6.5)	180 ° Short	4.6 (115.5)	1.4 (34.9)	PA66HIRHSUV, SS304	160
151-02009*	RCD180SM8SS	100.0 (445.0)	2.8 (70.0)	0.3 (8.31)	180 ° Short	4.6 (115.5)	1.4 (34.9)	PA66HIRHSUV, SS304	160
151-02010*	RCD180SM10SS	100.0 (445.0)	2.8 (70.0)	0.4 (10.29)	180 ° Short	4.6 (115.5)	1.4 (34.9)	PA66HIRHSUV, SS304	160
151-02011*	RCD180SM12SS	100.0 (445.0)	2.8 (70.0)	0.5 (12.95)	180 ° Short	4.6 (115.5)	1.4 (34.9)	PA66HIRHSUV, SS304	160

Dimensions are approximate and subject to technical changes. Use Part No. for ordering and Type for specification purposes.

*This product meets UL standards. Please see appendix for specific file numbers.



Please note! Not all products listed on this page may have this approval. Please check our website for latest approvals.

Ratchet P-Clamps

Accessories

The Ratchet P-Clamp family offers optional accessories for different user needs. The Tension Tab provides a specified tension when clamping around the bundle when used with EVO® Series hand tools. Our Soft Inserts deliver an additional level of protection for sensitive bundles or high-vibration applications.

Features and Benefits

- For pre-determined clamp pressure, a tension tab is available for use with our EVO Series hand tools.
- Soft material inserts snap precisely into the body of the clamp to provide an enhanced level of protection for applications with movement, high vibration or soft cable bundles.



PART NO.	TYPE	Description	Material	Color	Pkg. Qty.
151-01530*	RCINSERTA	Ratchet P-Clamp Size A Soft Insert	TPE	Black	100
151-01531*	RCINSERTB	Ratchet P-Clamp Size B Soft Insert	TPE	Black	100
151-01532*	RCINSERTC	Ratchet P-Clamp Size C Soft Insert	TPE	Black	100
151-01533*	RCINSERTD	Ratchet P-Clamp Size D Soft Insert	TPE	Black	100
151-01529	RCTT	Ratchet P-Clamp Tension Tab	PA66HIRHSUV	Black	100

Dimensions are approximate and subject to technical changes. Use Part No. for ordering and Type for specification purposes.

Note: Using soft inserts will reduce clamp diameter range; please test in application to ensure the proper fit. *This product meets UL standards. Please see appendix for specific file numbers.

Bundling and Securing

Self-Affixing Clamps

Adhesive Cable Clamps

RB Series

The RB Adhesive cable clamps are designed with an easy snap-in feature allowing simple installation or removal of cables, pipes or hoses. The rubber based adhesive allows for a permanent bond to most surfaces.

Features and Benefits

- Simple snap-in design allows for quick and easy installation or removal of cables.
- Rubber based adhesive allows for a permanent bond to most surfaces.

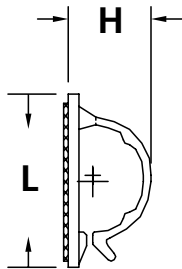

PART NO.	TYPE	Max. Bundle Diameter in. (mm)	Length (L) in. (mm)	Width (W) in. (mm)	Height (H) in. (mm)	Material	Color	Pkg. Qty.
151-14059	RB5	0.2 (5.0)	0.8 (19.0)	0.8 (19.0)	0.2 (6.0)	PA66	Natural	100
151-13601	RB8	0.3 (8.0)	1.0 (25.0)	1.0 (25.0)	0.5 (11.5)	PA66	Black	100
RB8L4		0.3 (8.0)	1.0 (25.0)	1.0 (25.0)	0.5 (11.5)	PA66	Natural	200
RB14L4	RB14	0.6 (14.0)	1.3 (33.2)	1.1 (27.4)	0.6 (16.0)	PA66	Natural	200

Dimensions are approximate and subject to technical changes. Use Part No. for ordering and Type for specification purposes.

Adhesive Cable Clamps

WAC Adhesive Cable Clamps

The WAC Adhesive cable clamps are designed with lead in angles allowing for easy insertion of wires and cables. The rubber based adhesive allows for a permanent bond to most surfaces. Available in two sizes.

Features and Benefits

- Lead-in angle design allows for quick and easy installation of wires and cables.
- Rubber based adhesive allows for a permanent bond to most surfaces.

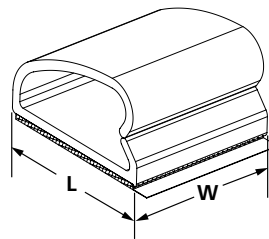
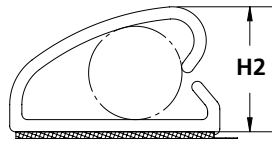
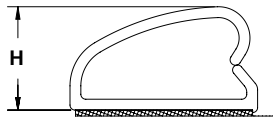

PART NO.	TYPE	Min. Bundle Diameter in. (mm)	Max. Bundle Diameter in. (mm)	Length (L) in. (mm)	Width (W) in. (mm)	Height (H) in. (mm)	Height (H2) in. (mm)	Material	Color	Pkg. Qty.
151-00667	WAC075	0.5 (12.7)	0.8 (19.1)	1.1 (28.7)	1.0 (25.4)	0.6 (15.8)	1.1 (26.7)	PVC	Gray	500
151-00669	WAC100	0.8 (19.1)	1.0 (25.4)	1.5 (38.1)	1.3 (31.8)	0.9 (21.6)	1.4 (34.3)	PVC	Gray	100
151-00668		0.8 (19.1)	1.0 (25.4)	1.5 (38.1)	1.3 (31.8)	0.9 (21.6)	1.4 (34.3)	PVC	Gray	500

Dimensions are approximate and subject to technical changes. Use Part No. for ordering and Type for specification purposes.

Bundling and Securing

Self-Affixing Clamps

Adhesive Cable Clamps

TSR Adhesive Clips

Manufactured from HellermannTyton's surface raceway, these adhesive cable clamps are designed with a co-extruded hinge offering unlimited and easy access to wire and cable. The clip can be open and closed repeatedly without deformation or signs of wear. The rubber based adhesive allows for a permanent bond to most surfaces. Available in three sizes.

Features and Benefits

- Co-extruded hinge offers unlimited access to wire and cables and can be open and closed repeatedly without signs of wear.
- Rubber based adhesive allows for a permanent bond to most surfaces.

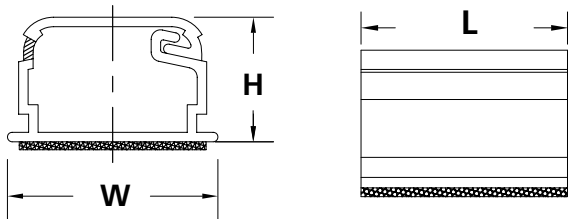

PART NO.	TYPE	Max. Bundle Diameter in. (mm)	Length (L) in. (mm)	Width (W) in. (mm)	Height (H) in. (mm)	Material	Color	Pkg. Qty.
SRCI0500C2	SRCI0500	0.5 (12.7)	0.8 (19.1)	0.8 (21.3)	0.5 (13.0)	PVC	Ivory	100
SRCI0750C2	SRCI0750	0.8 (19.0)	1.3 (31.8)	1.4 (34.5)	0.8 (19.6)	PVC	Ivory	100
SRCI1000K2	SRCI1000	1.0 (25.4)	1.8 (44.5)	1.9 (47.8)	1.0 (25.4)	PVC	Ivory	50

Dimensions are approximate and subject to technical changes. Use Part No. for ordering and Type for specification purposes.

Locking Clamps

Pipe and Hose Clips

The Locking Omega Clip creates a full and secure lock completely around a wire bundle ranging from 5-25 mm. The fixating fir tree on this clip allows for the clip to be secured into a panel by utilizing a round or oval hole.

Features and Benefits

- The 360 degree enclosure ensures the entire bundle is secure when being routed by this clip.
- Locking tab on this clip is small enough that it will not interfere with any other portion of the wire routing, but is significant enough to allow for manual disengagement if service is needed.
- Disc around the fir tree eliminates potential debris and water to enter the panel hole.

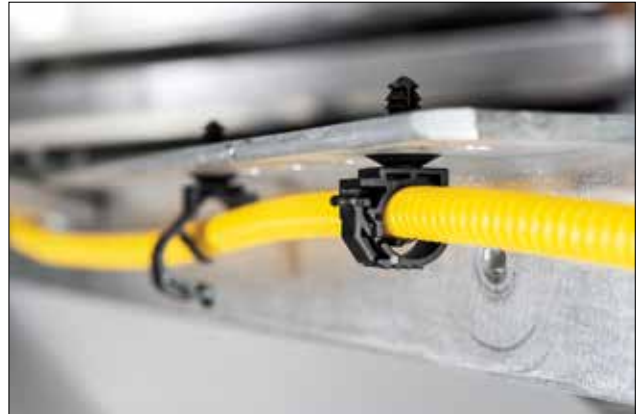

PART NO.	TYPE	Min. Bundle Diameter in. (mm)	Max. Bundle Diameter in. (mm)	Mounting Hole Dia. in. (mm)		Material	Color	Pkg. Qty.	Drawing
151-01306	LOC5-9FTOVAL	0.2 (5.0)	0.4 (9.0)	0.24 x 0.48; 0.26 x 0.49; 0.26 x 0.51; 0.28 x 0.47	(6.2 x 12.2), (6.5 x 12.5), (6.5 x 13.0), (7.0 x 12.0)	PA66HIRHSUV	Black	1000	
151-01017	LOC59FT6LG	0.2 (5.0)	0.4 (9.0)	0.25 HEX; 0.26	(6.35 hexagonal), (6.5 +/- 0.4)	PA66HIRHSUV	Black	1000	
151-01166	LOC1014FT6LG	0.4 (10.0)	0.6 (14.0)	0.25 HEX; 0.26	(6.35 hexagonal), (6.5 +/- 0.4)	PA66HIRHSUV	Black	1000	
151-02218	LOC1014FT9x12	0.4 (10.0)	0.6 (14.0)	0.35 x 0.47 0.35 x 0.55	(9.0 x 12.0), (9.0 x 14.0)	PA66HIRHSUV	Black	100	
151-02501		0.4 (10.0)	0.6 (14.0)	0.35 x 0.47 0.35 x 0.55	(9.0 x 12.0), (9.0 x 14.0)	PA66HIRHSUV	Black	500	
151-01023	LOC15-19FT6LG2	0.6 (15.0)	0.8 (19.0)	0.24 - 0.27	(6.1 - 6.9)	PA66HIRHS	Black	2000	

Dimensions are approximate and subject to technical changes. Use Part No. for ordering and Type for specification purposes.

Locking Clamps

Pipe and Hose Clips

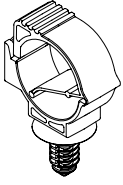
PART NO.	TYPE	Min. Bundle Diameter in. (mm)	Max. Bundle Diameter in. (mm)	Mounting Hole Dia. in. (mm)		Material	Color	Pkg. Qty.	Drawing
151-01022	LOC15-19FT6LG	0.6 (15.0)	0.8 (19.0)	0.25 HEX; 0.26	(6.35 hexagonal), (6.5 +/- 0.4)	PA66HIRHSUV	Black	1000	
151-01371	LOC20-25FT6.5LG	0.8 (20.0)	1.0 (25.0)	0.25 HEX; 0.26	(6.35 hexagonal), (6.5 +/- 0.4)	PA66HIRHSUV	Black	1000	

Dimensions are approximate and subject to technical changes. Use Part No. for ordering and Type for specification purposes.

The world is not flat.

Our world is filled with curved and moderately angled surfaces that would make ideal places to route and mount wire, cable and hoses. For that reason, there's FlexTack, a flexible cable tie mount that assists in routing bundles in more places – without the need to drill holes. Its high-strength acrylic adhesive delivers excellent performance for a wide range of indoor and outdoor applications. Imagine the possibilities.

MADE FOR REAL 

Learn more about FlexTack's capabilities and where to put it to work: www.hellermann.tyton.com/FlexTack

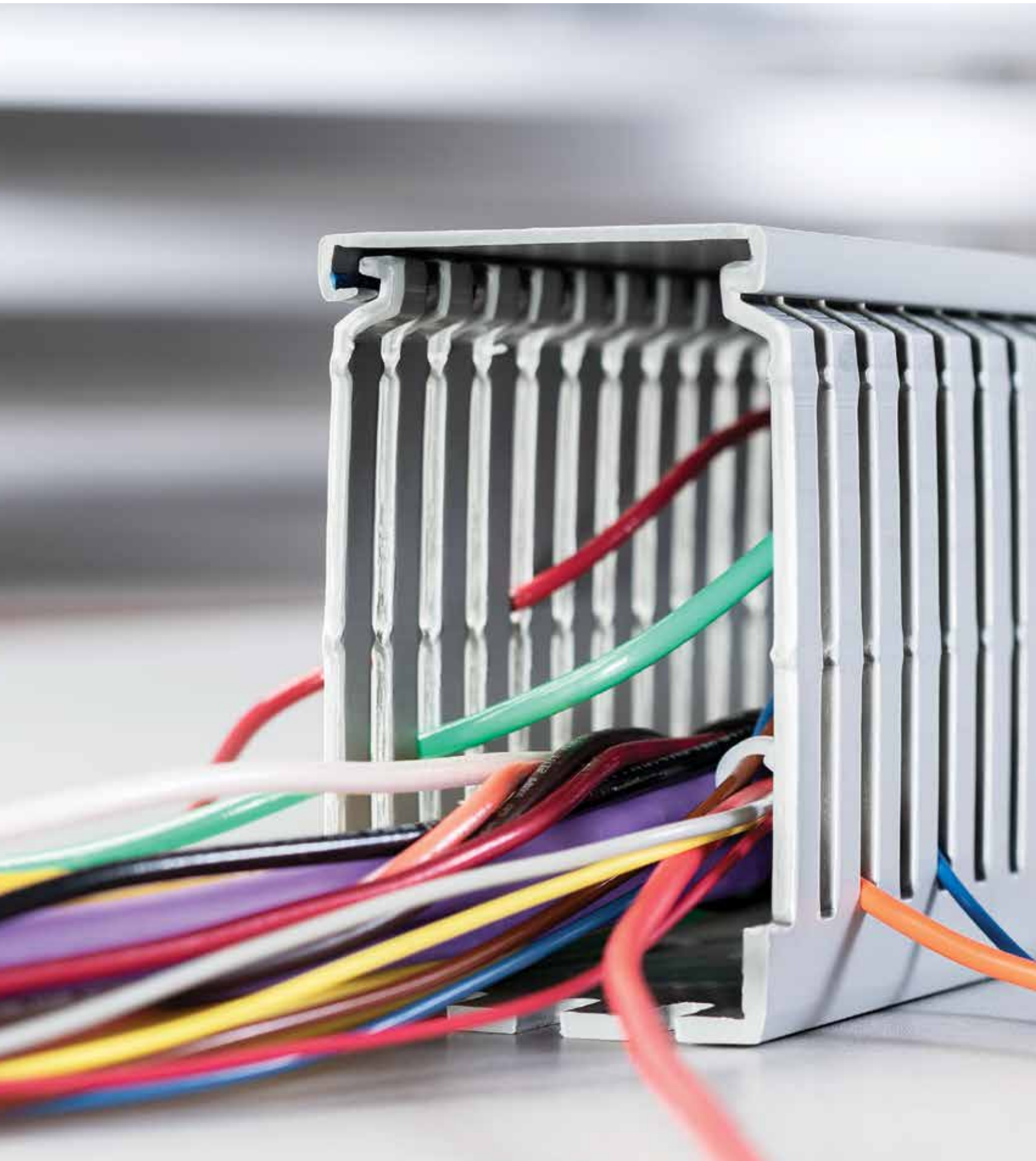

Inspired by customers

Customer feedback helps us evolve our products. Take our high-density electrical duct. We rounded off edges to make it safer to handle and improved our scoring process for cleaner break-offs. When we considered how much leftover product must be discarded, we acquired recyclable certification for our entire duct line. Great things happen when you just listen to customers.

Wiring Duct	230
Surface Raceway	285
Braided Sleeving	327
Helawrap Protective Tubing	348
Spiralwrap Sheathing	354
Convuluted Tubing	359
Grommet Edging	363
Heat Shrink Tubing	367

Routing, Protection and Insulation

Wiring Duct

Slotted Wall Duct

Slotted Wall Wiring Duct

Pro-Duct slotted wall wiring duct features break-away fingers which provide additional access for wire leads. Each section of the duct is provided with two score lines. The upper score line is used to break away fingers when a greater opening is required. The lower score line allows the sidewall to be smoothly cut for joints and Ts.

Features and Benefits

- Strong fingers prevent unwanted breaking.
- Fingers are easily deflected outward, allowing ready positioning of the wires within the slotted wall duct.
- Restricted opening design in the finger of the duct helps keep wires in place.
- Restricted opening prevents unintended removal of wires and permits any individual wire to be traced without disconnection.
- Supplied with mounting holes to streamline installation.
- Optional covers enhance protection and appearance.



MATERIAL	Polyvinylchloride (PVC)
Flammability	Self-Extinguishing
Operating Temperature	+122°F (+50°C)

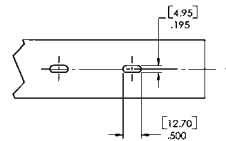
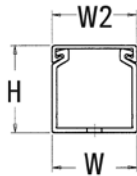
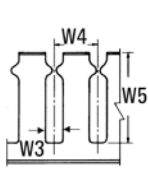

PART NO.	TYPE	Width (W) in. (mm)	Height (H) in. (mm)	Width (W2) in. (mm)	Width (W3) in. (mm)	Width (W4) in. (mm)	Width (W5) in. (mm)	Color	Pkg. Qty.
181-11009*	SL1x1	1.0 (25.4)	1.1 (26.9)	1.0 (25.4)	0.4 (10.2)	1.0 (25.4)	0.8 (19.1)	Black	120 ft
181-11011*		1.0 (25.4)	1.1 (26.9)	1.0 (25.4)	0.4 (10.2)	1.0 (25.4)	0.8 (19.1)	Gray	30 ft
181-11013*		1.0 (25.4)	1.1 (26.9)	1.0 (25.4)	0.4 (10.2)	1.0 (25.4)	0.8 (19.1)	Gray	120 ft
181-11014*		1.0 (25.4)	1.1 (26.9)	1.0 (25.4)	0.4 (10.2)	1.0 (25.4)	0.8 (19.1)	White	30 ft
181-11015*		1.0 (25.4)	1.1 (26.9)	1.0 (25.4)	0.4 (10.2)	1.0 (25.4)	0.8 (19.1)	White	120 ft

Dimensions are approximate and subject to technical changes. Use Part No. for ordering and Type for specification purposes.
For wire fill capacities and wiring duct material properties, see appendix. Sold in 6-ft. lengths. *This product meets UL standards. Please see appendix for specific file numbers.



Please note! Not all products listed on this page may have this approval. Please check our website for latest approvals.

Slotted Wall Duct

Slotted Wall Wiring Duct

PART NO.	TYPE	Width (W) in. (mm)	Height (H) in. (mm)	Width (W2) in. (mm)	Width (W3) in. (mm)	Width (W4) in. (mm)	Width (W5) in. (mm)	Color	Pkg. Qty.
181-05529*	SL1X1.5	1.0 (25.4)	1.6 (39.9)	1.0 (25.4)	0.4 (10.2)	1.0 (25.4)	1.2 (30.2)	Black	30 ft
181-00552*		1.0 (25.4)	1.6 (39.9)	1.0 (25.4)	0.4 (10.2)	1.0 (25.4)	1.2 (30.2)	Black	120 ft
181-11503*		1.0 (25.4)	1.6 (39.9)	1.0 (25.4)	0.4 (10.2)	1.0 (25.4)	1.2 (30.2)	Gray	30 ft
181-11505*		1.0 (25.4)	1.6 (39.9)	1.0 (25.4)	0.4 (10.2)	1.0 (25.4)	1.2 (30.2)	Gray	120 ft
181-11506*		1.0 (25.4)	1.6 (39.9)	1.0 (25.4)	0.4 (10.2)	1.0 (25.4)	1.2 (30.2)	White	30 ft
181-11507*		1.0 (25.4)	1.6 (39.9)	1.0 (25.4)	0.4 (10.2)	1.0 (25.4)	1.2 (30.2)	White	120 ft
181-05565*	SL1X2	1.0 (25.4)	2.1 (52.6)	1.0 (25.4)	0.4 (10.2)	1.0 (25.4)	1.6 (41.1)	Black	30 ft
181-00024*		1.0 (25.4)	2.1 (52.6)	1.0 (25.4)	0.4 (10.2)	1.0 (25.4)	1.6 (41.1)	Black	120 ft
181-12004*		1.0 (25.4)	2.1 (52.6)	1.0 (25.4)	0.4 (10.2)	1.0 (25.4)	1.6 (41.1)	Gray	30 ft
181-12005*		1.0 (25.4)	2.1 (52.6)	1.0 (25.4)	0.4 (10.2)	1.0 (25.4)	1.6 (41.1)	Gray	120 ft
181-12007*		1.0 (25.4)	2.1 (52.6)	1.0 (25.4)	0.4 (10.2)	1.0 (25.4)	1.6 (41.1)	White	30 ft
181-12008*		1.0 (25.4)	2.1 (52.6)	1.0 (25.4)	0.4 (10.2)	1.0 (25.4)	1.6 (41.1)	White	120 ft
181-00310*	SL1X3	1.0 (25.4)	3.1 (77.9)	1.0 (25.4)	0.4 (10.2)	1.0 (25.4)	2.6 (66.0)	Black	30 ft
181-13003*		1.0 (25.4)	3.1 (77.9)	1.0 (25.4)	0.4 (10.2)	1.0 (25.4)	2.6 (66.0)	Black	120 ft
181-13005*		1.0 (25.4)	3.1 (77.9)	1.0 (25.4)	0.4 (10.2)	1.0 (25.4)	2.6 (66.0)	Gray	30 ft
181-13006*		1.0 (25.4)	3.1 (77.9)	1.0 (25.4)	0.4 (10.2)	1.0 (25.4)	2.6 (66.0)	Gray	120 ft
181-13007*		1.0 (25.4)	3.1 (77.9)	1.0 (25.4)	0.4 (10.2)	1.0 (25.4)	2.6 (66.0)	White	30 ft
181-13008*		1.0 (25.4)	3.1 (77.9)	1.0 (25.4)	0.4 (10.2)	1.0 (25.4)	2.6 (66.0)	White	120 ft

Dimensions are approximate and subject to technical changes. Use Part No. for ordering and Type for specification purposes.

For wire fill capacities and wiring duct material properties, see appendix. Sold in 6-ft. lengths. *This product meets UL standards. Please see appendix for specific file numbers.



Please note! Not all products listed on this page may have this approval. Please check our website for latest approvals.

Routing, Protection and Insulation

Wiring Duct

Slotted Wall Duct

Slotted Wall Wiring Duct

PART NO.	TYPE	Width (W) in. (mm)	Height (H) in. (mm)	Width (W2) in. (mm)	Width (W3) in. (mm)	Width (W4) in. (mm)	Width (W5) in. (mm)	Color	Pkg. Qty.
181-05581*	SL1X4	1.0 (25.4)	4.1 (103.4)	1.0 (25.4)	0.4 (10.2)	1.0 (25.4)	3.6 (91.4)	Black	30 ft
181-14001*		1.0 (25.4)	4.1 (103.4)	1.0 (25.4)	0.4 (10.2)	1.0 (25.4)	3.6 (91.4)	Black	120 ft
181-14002*		1.0 (25.4)	4.1 (103.4)	1.0 (25.4)	0.4 (10.2)	1.0 (25.4)	3.6 (91.4)	Gray	30 ft
181-14003*		1.0 (25.4)	4.1 (103.4)	1.0 (25.4)	0.4 (10.2)	1.0 (25.4)	3.6 (91.4)	Gray	120 ft
181-14005*		1.0 (25.4)	4.1 (103.4)	1.0 (25.4)	0.4 (10.2)	1.0 (25.4)	3.6 (91.4)	White	30 ft
181-14006*		1.0 (25.4)	4.1 (103.4)	1.0 (25.4)	0.4 (10.2)	1.0 (25.4)	3.6 (91.4)	White	120 ft
181-05588*	SL1.5X1	1.5 (38.1)	1.1 (26.9)	1.5 (38.1)	0.4 (10.2)	1.0 (25.4)	0.8 (19.1)	Black	30 ft
181-00548*		1.5 (38.1)	1.1 (26.9)	1.5 (38.1)	0.4 (10.2)	1.0 (25.4)	0.8 (19.1)	Black	120 ft
181-15104*		1.5 (38.1)	1.1 (26.9)	1.5 (38.1)	0.4 (10.2)	1.0 (25.4)	0.8 (19.1)	Gray	30 ft
181-15105*		1.5 (38.1)	1.1 (26.9)	1.5 (38.1)	0.4 (10.2)	1.0 (25.4)	0.8 (19.1)	Gray	120 ft
181-15106*		1.5 (38.1)	1.1 (26.9)	1.5 (38.1)	0.4 (10.2)	1.0 (25.4)	0.8 (19.1)	White	30 ft
181-15107*		1.5 (38.1)	1.1 (26.9)	1.5 (38.1)	0.4 (10.2)	1.0 (25.4)	0.8 (19.1)	White	120 ft
181-15505*	SL1.5X1.5	1.5 (38.1)	1.6 (39.9)	1.5 (38.1)	0.4 (10.2)	1.0 (25.4)	1.2 (30.5)	Black	120 ft
181-15507*		1.5 (38.1)	1.6 (39.9)	1.5 (38.1)	0.4 (10.2)	1.0 (25.4)	1.2 (30.5)	Gray	30 ft
181-15509*		1.5 (38.1)	1.6 (39.9)	1.5 (38.1)	0.4 (10.2)	1.0 (25.4)	1.2 (30.5)	Gray	120 ft
181-15510*		1.5 (38.1)	1.6 (39.9)	1.5 (38.1)	0.4 (10.2)	1.0 (25.4)	1.2 (30.5)	White	30 ft
181-15511*		1.5 (38.1)	1.6 (39.9)	1.5 (38.1)	0.4 (10.2)	1.0 (25.4)	1.2 (30.5)	White	120 ft

Dimensions are approximate and subject to technical changes. Use Part No. for ordering and Type for specification purposes.
For wire fill capacities and wiring duct material properties, see appendix. Sold in 6-ft. lengths. *This product meets UL standards. Please see appendix for specific file numbers.



Please note! Not all products listed on this page may have this approval. Please check our website for latest approvals.

Slotted Wall Duct

Slotted Wall Wiring Duct

PART NO.	TYPE	Width (W) in. (mm)	Height (H) in. (mm)	Width (W2) in. (mm)	Width (W3) in. (mm)	Width (W4) in. (mm)	Width (W5) in. (mm)	Color	Pkg. Qty.
181-05551*	SL1.5X2	1.5 (38.1)	2.1 (52.6)	1.5 (38.1)	0.4 (10.2)	1.0 (25.4)	1.6 (40.6)	Black	30 ft
181-15203*		1.5 (38.1)	2.1 (52.6)	1.5 (38.1)	0.4 (10.2)	1.0 (25.4)	1.6 (40.6)	Black	120 ft
181-15206*		1.5 (38.1)	2.1 (52.6)	1.5 (38.1)	0.4 (10.2)	1.0 (25.4)	1.6 (40.6)	Gray	30 ft
181-15207*		1.5 (38.1)	2.1 (52.6)	1.5 (38.1)	0.4 (10.2)	1.0 (25.4)	1.6 (40.6)	Gray	120 ft
181-15208*		1.5 (38.1)	2.1 (52.6)	1.5 (38.1)	0.4 (10.2)	1.0 (25.4)	1.6 (40.6)	White	30 ft
181-15209*		1.5 (38.1)	2.1 (52.6)	1.5 (38.1)	0.4 (10.2)	1.0 (25.4)	1.6 (40.6)	White	120 ft
181-00550*	SL1.5X3	1.5 (38.1)	3.1 (77.9)	1.5 (38.1)	0.4 (10.2)	1.0 (25.4)	2.6 (66.0)	Black	120 ft
181-15302*		1.5 (38.1)	3.1 (77.9)	1.5 (38.1)	0.4 (10.2)	1.0 (25.4)	2.6 (66.0)	Gray	30 ft
181-15304*		1.5 (38.1)	3.1 (77.9)	1.5 (38.1)	0.4 (10.2)	1.0 (25.4)	2.6 (66.0)	Gray	120 ft
181-15305*		1.5 (38.1)	3.1 (77.9)	1.5 (38.1)	0.4 (10.2)	1.0 (25.4)	2.6 (66.0)	White	30 ft
181-15306*		1.5 (38.1)	3.1 (77.9)	1.5 (38.1)	0.4 (10.2)	1.0 (25.4)	2.6 (66.0)	White	120 ft
181-23079*	SL1.5X4	1.5 (38.1)	4.1 (103.4)	1.5 (38.1)	0.4 (10.2)	1.0 (25.4)	3.6 (91.4)	Black	30 ft
181-15400*		1.5 (38.1)	4.1 (103.4)	1.5 (38.1)	0.4 (10.2)	1.0 (25.4)	3.6 (91.4)	Black	120 ft
181-15403*		1.5 (38.1)	4.1 (103.4)	1.5 (38.1)	0.4 (10.2)	1.0 (25.4)	3.6 (91.4)	Gray	30 ft
181-15404*		1.5 (38.1)	4.1 (103.4)	1.5 (38.1)	0.4 (10.2)	1.0 (25.4)	3.6 (91.4)	Gray	120 ft
181-15405*		1.5 (38.1)	4.1 (103.4)	1.5 (38.1)	0.4 (10.2)	1.0 (25.4)	3.6 (91.4)	White	30 ft
181-15406*		1.5 (38.1)	4.1 (103.4)	1.5 (38.1)	0.4 (10.2)	1.0 (25.4)	3.6 (91.4)	White	120 ft

Dimensions are approximate and subject to technical changes. Use Part No. for ordering and Type for specification purposes.

For wire fill capacities and wiring duct material properties, see appendix. Sold in 6-ft. lengths. *This product meets UL standards. Please see appendix for specific file numbers.



Please note! Not all products listed on this page may have this approval. Please check our website for latest approvals.

Routing, Protection and Insulation

Wiring Duct

Slotted Wall Duct

Slotted Wall Wiring Duct

PART NO.	TYPE	Width (W) in. (mm)	Height (H) in. (mm)	Width (W2) in. (mm)	Width (W3) in. (mm)	Width (W4) in. (mm)	Width (W5) in. (mm)	Color	Pkg. Qty.
181-00554*	SL2X1	2.0 (50.8)	1.1 (26.9)	2.0 (50.8)	0.4 (10.2)	1.0 (25.4)	0.8 (19.1)	Black	120 ft
181-21004*		2.0 (50.8)	1.1 (26.9)	2.0 (50.8)	0.4 (10.2)	1.0 (25.4)	0.8 (19.1)	Gray	30 ft
181-21005*		2.0 (50.8)	1.1 (26.9)	2.0 (50.8)	0.4 (10.2)	1.0 (25.4)	0.8 (19.1)	Gray	120 ft
181-21006*		2.0 (50.8)	1.1 (26.9)	2.0 (50.8)	0.4 (10.2)	1.0 (25.4)	0.8 (19.1)	White	30 ft
181-21007*		2.0 (50.8)	1.1 (26.9)	2.0 (50.8)	0.4 (10.2)	1.0 (25.4)	0.8 (19.1)	White	120 ft
181-22019*	SL2X2	2.0 (50.8)	2.1 (52.6)	2.0 (50.8)	0.4 (10.2)	1.0 (25.4)	1.6 (40.6)	Black	30 ft
181-22020*		2.0 (50.8)	2.1 (52.6)	2.0 (50.8)	0.4 (10.2)	1.0 (25.4)	1.6 (40.6)	Black	120 ft
181-22022*		2.0 (50.8)	2.1 (52.6)	2.0 (50.8)	0.4 (10.2)	1.0 (25.4)	1.6 (40.6)	Gray	30 ft
181-22024*		2.0 (50.8)	2.1 (52.6)	2.0 (50.8)	0.4 (10.2)	1.0 (25.4)	1.6 (40.6)	Gray	120 ft
181-22027*		2.0 (50.8)	2.1 (52.6)	2.0 (50.8)	0.4 (10.2)	1.0 (25.4)	1.6 (40.6)	White	30 ft
181-22028*		2.0 (50.8)	2.1 (52.6)	2.0 (50.8)	0.4 (10.2)	1.0 (25.4)	1.6 (40.6)	White	120 ft
181-23013*	SL2X3	2.0 (50.8)	3.1 (77.9)	2.0 (50.8)	0.4 (10.2)	1.0 (25.4)	2.6 (66.0)	Black	30 ft
181-23003*		2.0 (50.8)	3.1 (77.9)	2.0 (50.8)	0.4 (10.2)	1.0 (25.4)	2.6 (66.0)	Black	120 ft
181-23005*		2.0 (50.8)	3.1 (77.9)	2.0 (50.8)	0.4 (10.2)	1.0 (25.4)	2.6 (66.0)	Gray	30 ft
181-23007*		2.0 (50.8)	3.1 (77.9)	2.0 (50.8)	0.4 (10.2)	1.0 (25.4)	2.6 (66.0)	Gray	120 ft
181-23008*		2.0 (50.8)	3.1 (77.9)	2.0 (50.8)	0.4 (10.2)	1.0 (25.4)	2.6 (66.0)	White	30 ft
181-23009*		2.0 (50.8)	3.1 (77.9)	2.0 (50.8)	0.4 (10.2)	1.0 (25.4)	2.6 (66.0)	White	120 ft
181-24005*	SL2X4	2.0 (50.8)	4.1 (103.4)	2.0 (50.8)	0.4 (10.2)	1.0 (25.4)	3.6 (91.4)	Black	30 ft
181-24003*		2.0 (50.8)	4.1 (103.4)	2.0 (50.8)	0.4 (10.2)	1.0 (25.4)	3.6 (91.4)	Black	120 ft
181-24007*		2.0 (50.8)	4.1 (103.4)	2.0 (50.8)	0.4 (10.2)	1.0 (25.4)	3.6 (91.4)	Gray	30 ft
181-24008*		2.0 (50.8)	4.1 (103.4)	2.0 (50.8)	0.4 (10.2)	1.0 (25.4)	3.6 (91.4)	Gray	120 ft
181-24010*		2.0 (50.8)	4.1 (103.4)	2.0 (50.8)	0.4 (10.2)	1.0 (25.4)	3.6 (91.4)	White	30 ft
181-24011*		2.0 (50.8)	4.1 (103.4)	2.0 (50.8)	0.4 (10.2)	1.0 (25.4)	3.6 (91.4)	White	120 ft

Dimensions are approximate and subject to technical changes. Use Part No. for ordering and Type for specification purposes.

For wire fill capacities and wiring duct material properties, see appendix. Sold in 6-ft. lengths. *This product meets UL standards. Please see appendix for specific file numbers.



Please note! Not all products listed on this page may have this approval. Please check our website for latest approvals.

Slotted Wall Duct

Slotted Wall Wiring Duct

PART NO.	TYPE	Width (W) in. (mm)	Height (H) in. (mm)	Width (W2) in. (mm)	Width (W3) in. (mm)	Width (W4) in. (mm)	Width (W5) in. (mm)	Color	Pkg. Qty.
181-23036*	SL2X5	2.0 (50.8)	5.1 (128.8)	2.0 (50.8)	0.4 (10.2)	1.0 (25.4)	4.6 (116.8)	Black	30 ft
181-00316*		2.0 (50.8)	5.1 (128.8)	2.0 (50.8)	0.4 (10.2)	1.0 (25.4)	4.6 (116.8)	Black	120 ft
181-00237*		2.0 (50.8)	5.1 (128.8)	2.0 (50.8)	0.4 (10.2)	1.0 (25.4)	4.6 (116.8)	Gray	30 ft
181-00236*		2.0 (50.8)	5.1 (128.8)	2.0 (50.8)	0.4 (10.2)	1.0 (25.4)	4.6 (116.8)	Gray	120 ft
181-00241*		2.0 (50.8)	5.1 (128.8)	2.0 (50.8)	0.4 (10.2)	1.0 (25.4)	4.6 (116.8)	White	30 ft
181-00240*		2.0 (50.8)	5.1 (128.8)	2.0 (50.8)	0.4 (10.2)	1.0 (25.4)	4.6 (116.8)	White	120 ft
181-23092*	SL2.5X3	2.5 (63.5)	3.1 (77.9)	2.5 (63.5)	0.4 (10.2)	1.0 (25.4)	2.6 (66.0)	Black	30 ft
181-00318*		2.5 (63.5)	3.1 (77.9)	2.5 (63.5)	0.4 (10.2)	1.0 (25.4)	2.6 (66.0)	Black	120 ft
181-00213*		2.5 (63.5)	3.1 (77.9)	2.5 (63.5)	0.4 (10.2)	1.0 (25.4)	2.6 (66.0)	Gray	30 ft
181-00212*		2.5 (63.5)	3.1 (77.9)	2.5 (63.5)	0.4 (10.2)	1.0 (25.4)	2.6 (66.0)	Gray	120 ft
181-00217*		2.5 (63.5)	3.1 (77.9)	2.5 (63.5)	0.4 (10.2)	1.0 (25.4)	2.6 (66.0)	White	30 ft
181-00216*		2.5 (63.5)	3.1 (77.9)	2.5 (63.5)	0.4 (10.2)	1.0 (25.4)	2.6 (66.0)	White	120 ft
181-05561*	SL3X1	3.0 (76.2)	1.1 (26.9)	3.0 (76.2)	0.4 (10.2)	1.0 (25.4)	0.8 (19.1)	Black	30 ft
181-00557*		3.0 (76.2)	1.1 (26.9)	3.0 (76.2)	0.4 (10.2)	1.0 (25.4)	0.8 (19.1)	Black	120 ft
181-31004*		3.0 (76.2)	1.1 (26.9)	3.0 (76.2)	0.4 (10.2)	1.0 (25.4)	0.8 (19.1)	Gray	30 ft
181-00558*		3.0 (76.2)	1.1 (26.9)	3.0 (76.2)	0.4 (10.2)	1.0 (25.4)	0.8 (19.1)	Gray	120 ft
181-31006*		3.0 (76.2)	1.1 (26.9)	3.0 (76.2)	0.4 (10.2)	1.0 (25.4)	0.8 (19.1)	White	30 ft
181-31007*		3.0 (76.2)	1.1 (26.9)	3.0 (76.2)	0.4 (10.2)	1.0 (25.4)	0.8 (19.1)	White	120 ft

Dimensions are approximate and subject to technical changes. Use Part No. for ordering and Type for specification purposes.

For wire fill capacities and wiring duct material properties, see appendix. Sold in 6-ft. lengths. *This product meets UL standards. Please see appendix for specific file numbers.



Please note! Not all products listed on this page may have this approval. Please check our website for latest approvals.

Routing, Protection and Insulation

Wiring Duct

Slotted Wall Duct

Slotted Wall Wiring Duct

PART NO.	TYPE	Width (W) in. (mm)	Height (H) in. (mm)	Width (W2) in. (mm)	Width (W3) in. (mm)	Width (W4) in. (mm)	Width (W5) in. (mm)	Color	Pkg. Qty.
181-32016*	SL3X2	3.0 (76.2)	2.1 (52.6)	3.0 (76.2)	0.4 (10.2)	1.0 (25.4)	1.6 (41.1)	Black	30 ft
181-32004*		3.0 (76.2)	2.1 (52.6)	3.0 (76.2)	0.4 (10.2)	1.0 (25.4)	1.6 (41.1)	Black	120 ft
181-32005*		3.0 (76.2)	2.1 (52.6)	3.0 (76.2)	0.4 (10.2)	1.0 (25.4)	1.6 (41.1)	Gray	30 ft
181-32006*		3.0 (76.2)	2.1 (52.6)	3.0 (76.2)	0.4 (10.2)	1.0 (25.4)	1.6 (41.1)	Gray	120 ft
181-32008*		3.0 (76.2)	2.1 (52.6)	3.0 (76.2)	0.4 (10.2)	1.0 (25.4)	1.6 (41.1)	White	30 ft
181-32009*		3.0 (76.2)	2.1 (52.6)	3.0 (76.2)	0.4 (10.2)	1.0 (25.4)	1.6 (41.1)	White	120 ft
181-33008*	SL3X3	3.0 (76.2)	3.1 (77.9)	3.0 (76.2)	0.4 (10.2)	1.0 (25.4)	2.6 (66.0)	Black	30 ft
181-33009*		3.0 (76.2)	3.1 (77.9)	3.0 (76.2)	0.4 (10.2)	1.0 (25.4)	2.6 (66.0)	Black	120 ft
181-33014*		3.0 (76.2)	3.1 (77.9)	3.0 (76.2)	0.4 (10.2)	1.0 (25.4)	2.6 (66.0)	Gray	30 ft
181-33016*		3.0 (76.2)	3.1 (77.9)	3.0 (76.2)	0.4 (10.2)	1.0 (25.4)	2.6 (66.0)	Gray	120 ft
181-33017*		3.0 (76.2)	3.1 (77.9)	3.0 (76.2)	0.4 (10.2)	1.0 (25.4)	2.6 (66.0)	White	30 ft
181-33018*		3.0 (76.2)	3.1 (77.9)	3.0 (76.2)	0.4 (10.2)	1.0 (25.4)	2.6 (66.0)	White	120 ft
181-34021*	SL3X4	3.0 (76.2)	4.1 (103.4)	3.0 (76.2)	0.4 (10.2)	1.0 (25.4)	3.6 (91.4)	Black	30 ft
181-34002*		3.0 (76.2)	4.1 (103.4)	3.0 (76.2)	0.4 (10.2)	1.0 (25.4)	3.6 (91.4)	Black	120 ft
181-34003*		3.0 (76.2)	4.1 (103.4)	3.0 (76.2)	0.4 (10.2)	1.0 (25.4)	3.6 (91.4)	Gray	30 ft
181-34004*		3.0 (76.2)	4.1 (103.4)	3.0 (76.2)	0.4 (10.2)	1.0 (25.4)	3.6 (91.4)	Gray	120 ft
181-34006*		3.0 (76.2)	4.1 (103.4)	3.0 (76.2)	0.4 (10.2)	1.0 (25.4)	3.6 (91.4)	White	30 ft
181-34007*		3.0 (76.2)	4.1 (103.4)	3.0 (76.2)	0.4 (10.2)	1.0 (25.4)	3.6 (91.4)	White	120 ft
181-35001*	SL3X5	3.0 (76.2)	5.1 (128.5)	3.0 (76.2)	0.4 (10.2)	1.0 (25.4)	4.6 (116.8)	Black	30 ft
181-35002*		3.0 (76.2)	5.1 (128.5)	3.0 (76.2)	0.4 (10.2)	1.0 (25.4)	4.6 (116.8)	Black	120 ft
181-35005*		3.0 (76.2)	5.1 (128.5)	3.0 (76.2)	0.4 (10.2)	1.0 (25.4)	4.6 (116.8)	Gray	120 ft
181-35006*		3.0 (76.2)	5.1 (128.5)	3.0 (76.2)	0.4 (10.2)	1.0 (25.4)	4.6 (116.8)	White	30 ft
181-00560*		3.0 (76.2)	5.1 (128.5)	3.0 (76.2)	0.4 (10.2)	1.0 (25.4)	4.6 (116.8)	White	120 ft

Dimensions are approximate and subject to technical changes. Use Part No. for ordering and Type for specification purposes.

For wire fill capacities and wiring duct material properties, see appendix. Sold in 6-ft. lengths. *This product meets UL standards. Please see appendix for specific file numbers.



Please note! Not all products listed on this page may have this approval. Please check our website for latest approvals.

Slotted Wall Duct

Slotted Wall Wiring Duct

PART NO.	TYPE	Width (W) in. (mm)	Height (H) in. (mm)	Width (W2) in. (mm)	Width (W3) in. (mm)	Width (W4) in. (mm)	Width (W5) in. (mm)	Color	Pkg. Qty.
181-42020*	SL4X2	4.0 (101.6)	2.1 (52.6)	4.0 (101.6)	0.4 (10.2)	1.0 (25.4)	1.6 (41.1)	Black	30 ft
181-42005*		4.0 (101.6)	2.1 (52.6)	4.0 (101.6)	0.4 (10.2)	1.0 (25.4)	1.6 (41.1)	Black	120 ft
181-42009*		4.0 (101.6)	2.1 (52.6)	4.0 (101.6)	0.4 (10.2)	1.0 (25.4)	1.6 (41.1)	Gray	30 ft
181-42008*		4.0 (101.6)	2.1 (52.6)	4.0 (101.6)	0.4 (10.2)	1.0 (25.4)	1.6 (41.1)	Gray	120 ft
181-42006*		4.0 (101.6)	2.1 (52.6)	4.0 (101.6)	0.4 (10.2)	1.0 (25.4)	1.6 (41.1)	White	30 ft
181-42010*		4.0 (101.6)	2.1 (52.6)	4.0 (101.6)	0.4 (10.2)	1.0 (25.4)	1.6 (41.1)	White	120 ft
181-23104*	SL4X3	4.0 (101.6)	3.1 (77.9)	4.0 (101.6)	0.4 (10.2)	1.0 (25.4)	2.6 (66.0)	Black	30 ft
181-00562*		4.0 (101.6)	3.1 (77.9)	4.0 (101.6)	0.4 (10.2)	1.0 (25.4)	2.6 (66.0)	Black	120 ft
181-43003*		4.0 (101.6)	3.1 (77.9)	4.0 (101.6)	0.4 (10.2)	1.0 (25.4)	2.6 (66.0)	Gray	30 ft
181-43004*		4.0 (101.6)	3.1 (77.9)	4.0 (101.6)	0.4 (10.2)	1.0 (25.4)	2.6 (66.0)	Gray	120 ft
181-43005*		4.0 (101.6)	3.1 (77.9)	4.0 (101.6)	0.4 (10.2)	1.0 (25.4)	2.6 (66.0)	White	30 ft
181-43006*		4.0 (101.6)	3.1 (77.9)	4.0 (101.6)	0.4 (10.2)	1.0 (25.4)	2.6 (66.0)	White	120 ft
181-44019*	SL4X4	4.0 (101.6)	4.1 (103.4)	4.0 (101.6)	0.4 (10.2)	1.0 (25.4)	3.6 (91.4)	Black	30 ft
181-44020*		4.0 (101.6)	4.1 (103.4)	4.0 (101.6)	0.4 (10.2)	1.0 (25.4)	3.6 (91.4)	Black	120 ft
181-44025*		4.0 (101.6)	4.1 (103.4)	4.0 (101.6)	0.4 (10.2)	1.0 (25.4)	3.6 (91.4)	Gray	30 ft
181-44027*		4.0 (101.6)	4.1 (103.4)	4.0 (101.6)	0.4 (10.2)	1.0 (25.4)	3.6 (91.4)	Gray	120 ft
181-44030*		4.0 (101.6)	4.1 (103.4)	4.0 (101.6)	0.4 (10.2)	1.0 (25.4)	3.6 (91.4)	White	30 ft
181-44031*		4.0 (101.6)	4.1 (103.4)	4.0 (101.6)	0.4 (10.2)	1.0 (25.4)	3.6 (91.4)	White	120 ft
181-45002*	SL4X5	4.0 (101.6)	5.1 (128.8)	4.0 (101.6)	0.4 (10.2)	1.0 (25.4)	4.6 (116.8)	Black	60 ft
181-45010*		4.0 (101.6)	5.1 (128.8)	4.0 (101.6)	0.4 (10.2)	1.0 (25.4)	4.6 (116.8)	Gray	60 ft
181-45011*		4.0 (101.6)	5.1 (128.8)	4.0 (101.6)	0.4 (10.2)	1.0 (25.4)	4.6 (116.8)	White	60 ft

Dimensions are approximate and subject to technical changes. Use Part No. for ordering and Type for specification purposes.

For wire fill capacities and wiring duct material properties, see appendix. Sold in 6-ft. lengths. *This product meets UL standards. Please see appendix for specific file numbers.



Please note! Not all products listed on this page may have this approval. Please check our website for latest approvals.

Routing, Protection and Insulation

Wiring Duct

Slotted Wall Duct

Slotted Wall Wiring Duct - Intrinsic Blue

Manufactured from the same PVC material as standard Pro-Duct colors, HellermannTyton also offers an intrinsic blue color option. The intrinsic blue color indicates that the wiring contained in the duct runs to intrinsically safe components in the control panel. Pro-Duct slotted wall wiring duct features break-away fingers which provide additional access for wire leads. Each section of the duct is provided with two score lines. The upper score line is used to break away fingers when a greater opening is required. The lower score line allows the sidewall to be smoothly cut for joints and T's.

Features and Benefits

- Strong fingers prevent unwanted breaking.
- Fingers are easily deflected outward, allowing ready positioning of the wires within the slotted wall duct.
- Restricted opening design in the finger of the duct helps keep wires in place.
- Restricted opening prevents unintended removal of wires and permits any individual wire to be traced without disconnection.
- Supplied with mounting holes to streamline installation.
- Optional covers enhance protection and appearance.

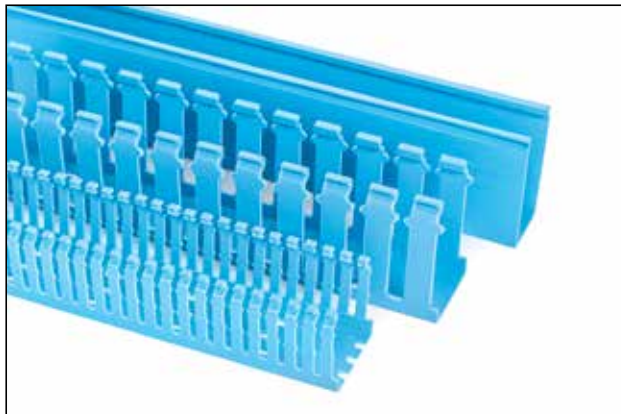

MATERIAL	Polyvinylchloride (PVC)
Flammability	Self-Extinguishing
Operating Temperature	+122°F (+50°C)

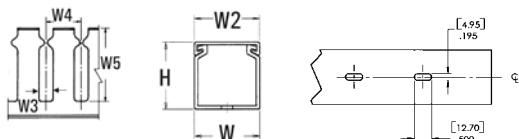

PART NO.	TYPE	Width (W) in. (mm)	Height (H) in. (mm)	Width (W2) in. (mm)	Width (W3) in. (mm)	Width (W4) in. (mm)	Width (W5) in. (mm)	Color	Pkg. Qty.
181-12003*	SL1X2	1.0 (25.4)	2.1 (52.6)	1.0 (25.4)	0.4 (10.2)	1.0 (25.4)	1.6 (41.1)	Intrinsic Blue	120 ft
181-13004*	SL1X3	1.0 (25.4)	3.1 (77.9)	1.0 (25.4)	0.4 (10.2)	1.0 (25.4)	2.6 (66.0)	Intrinsic Blue	120 ft
181-05580*	SL1X4	1.0 (25.4)	4.1 (103.4)	1.0 (25.4)	0.4 (10.2)	1.0 (25.4)	3.6 (91.4)	Intrinsic Blue	120 ft
181-00160*	SL1.5X1	1.5 (38.1)	1.1 (26.9)	1.5 (38.1)	0.4 (10.2)	1.0 (25.4)	0.8 (19.1)	Intrinsic Blue	120 ft
181-15103*		1.5 (38.1)	1.1 (26.9)	1.5 (38.1)	0.4 (10.2)	1.0 (25.4)	0.8 (19.1)	Intrinsic Blue	30 ft
181-15506*	SL1.5X1.5	1.5 (38.1)	1.6 (39.9)	1.5 (38.1)	0.4 (10.2)	1.0 (25.4)	1.2 (30.5)	Intrinsic Blue	120 ft
181-05550*	SL1.5X2	1.5 (38.1)	2.1 (52.6)	1.5 (38.1)	0.4 (10.2)	1.0 (25.4)	1.6 (40.6)	Intrinsic Blue	120 ft

Dimensions are approximate and subject to technical changes. Use Part No. for ordering and Type for specification purposes. For wire fill capacities and wiring duct material properties, see appendix. Sold in 6-ft. lengths. *This product meets UL standards. Please see appendix for specific file numbers.



Please note! Not all products listed on this page may have this approval. Please check our website for latest approvals.

PART NO.	TYPE	Width (W) in. (mm)	Height (H) in. (mm)	Width (W2) in. (mm)	Width (W3) in. (mm)	Width (W4) in. (mm)	Width (W5) in. (mm)	Color	Pkg. Qty.
181-00211*	SL1.5X3	1.5 (38.1)	3.1 (77.9)	1.5 (38.1)	0.4 (10.2)	1.0 (25.4)	2.6 (66.0)	Intrinsic Blue	120 ft
181-23078*	SL1.5X4	1.5 (38.1)	4.1 (103.4)	1.5 (38.1)	0.4 (10.2)	1.0 (25.4)	3.6 (91.4)	Intrinsic Blue	120 ft
181-23085*	SL2X1	2.0 (50.8)	1.1 (26.9)	2.0 (50.8)	0.4 (10.2)	1.0 (25.4)	0.8 (19.1)	Intrinsic Blue	120 ft
181-22021*	SL2X2	2.0 (50.8)	2.1 (52.6)	2.0 (50.8)	0.4 (10.2)	1.0 (25.4)	1.6 (40.6)	Intrinsic Blue	120 ft
181-23004*	SL2X3	2.0 (50.8)	3.1 (77.9)	2.0 (50.8)	0.4 (10.2)	1.0 (25.4)	2.6 (66.0)	Intrinsic Blue	120 ft
181-24006*	SL2X4	2.0 (50.8)	4.1 (103.4)	2.0 (50.8)	0.4 (10.2)	1.0 (25.4)	3.6 (91.4)	Intrinsic Blue	120 ft
181-23035*	SL2X5	2.0 (50.8)	5.1 (128.8)	2.0 (50.8)	0.4 (10.2)	1.0 (25.4)	4.6 (116.8)	Intrinsic Blue	120 ft
181-23091*	SL2.5X3	2.5 (63.5)	3.1 (77.9)	2.5 (63.5)	0.4 (10.2)	1.0 (25.4)	2.6 (66.0)	Intrinsic Blue	120 ft
181-31003*	SL3X1	3.0 (76.2)	1.1 (26.9)	3.0 (76.2)	0.4 (10.2)	1.0 (25.4)	0.8 (19.1)	Intrinsic Blue	120 ft
181-23044*	SL3X2	3.0 (76.2)	2.1 (52.6)	3.0 (76.2)	0.4 (10.2)	1.0 (25.4)	1.6 (41.1)	Intrinsic Blue	120 ft
181-33012*	SL3X3	3.0 (76.2)	3.1 (77.9)	3.0 (76.2)	0.4 (10.2)	1.0 (25.4)	2.6 (66.0)	Intrinsic Blue	120 ft
181-23052*	SL3X4	3.0 (76.2)	4.1 (103.4)	3.0 (76.2)	0.4 (10.2)	1.0 (25.4)	3.6 (91.4)	Intrinsic Blue	120 ft
181-23062*	SL3X5	3.0 (76.2)	5.1 (128.5)	3.0 (76.2)	0.4 (10.2)	1.0 (25.4)	4.6 (116.8)	Intrinsic Blue	120 ft
181-05596*	SL4X2	4.0 (101.6)	2.1 (52.6)	4.0 (101.6)	0.4 (10.2)	1.0 (25.4)	1.6 (41.1)	Intrinsic Blue	120 ft
181-00210*	SL4X3	4.0 (101.6)	3.1 (77.9)	4.0 (101.6)	0.4 (10.2)	1.0 (25.4)	2.6 (66.0)	Intrinsic Blue	120 ft
181-44024*	SL4X4	4.0 (101.6)	4.1 (103.4)	4.0 (101.6)	0.4 (10.2)	1.0 (25.4)	3.6 (91.4)	Intrinsic Blue	120 ft
181-00563*		4.0 (101.6)	4.1 (103.4)	4.0 (101.6)	0.4 (10.2)	1.0 (25.4)	3.6 (91.4)	Intrinsic Blue	30 ft
181-05604*	SL4X5	4.0 (101.6)	5.1 (128.8)	4.0 (101.6)	0.4 (10.2)	1.0 (25.4)	4.6 (116.8)	Intrinsic Blue	60 ft

Dimensions are approximate and subject to technical changes. Use Part No. for ordering and Type for specification purposes.
For wire fill capacities and wiring duct material properties, see appendix. Sold in 6-ft. lengths. *This product meets UL standards. Please see appendix for specific file numbers.



Please note! Not all products listed on this page may have this approval. Please check our website for latest approvals.

Routing, Protection and Insulation

Wiring Duct

Slotted Wall Duct

Slotted Wall Wiring Duct - Adhesive Back

HellermannTyton Slotted Wall Duct features breakaway fingers that provide additional access for wire leads. Each section of the duct is provided with two score lines. The upper score line is used to break away fingers when a wider opening is required. The lower score line allows the sidewall to be smoothly cut for joints and Ts. Pressure-sensitive, rubber-based adhesive backing aids in temporary positioning.

Features and Benefits

- Strong fingers prevent unintended breaking.
- Fingers are easily deflected outward, allowing easier positioning of the wires.
- Restricted opening prevents unintended removal of wires and permits any individual wire to be traced without disconnection.
- Non-permanent adhesive allows repositioning prior to final installation.
- Optional covers snap on and off easily, and their nonslip lining ensures they stay in place even under vibration.



MATERIAL	Polyvinylchloride (PVC)
Flammability	Self-Extinguishing
Operating Temperature	+122°F (+50°C)

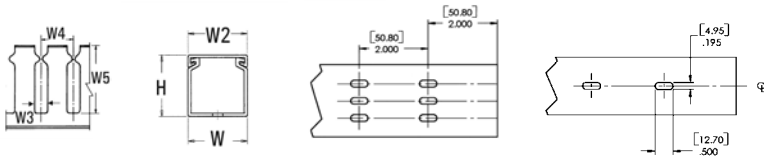

PART NO.	TYPE	Width (W) in. (mm)	Height (H) in. (mm)	Width (W2) in. (mm)	Width (W3) in. (mm)	Width (W4) in. (mm)	Width (W5) in. (mm)	Color	Pkg. Qty.
181-11016*	SLA1X1	1.0 (25.4)	1.1 (26.9)	1.0 (25.4)	0.4 (10.2)	1.0 (25.4)	0.8 (19.1)	Black	120 ft
181-11017*		1.0 (25.4)	1.1 (26.9)	1.0 (25.4)	0.4 (10.2)	1.0 (25.4)	0.8 (19.1)	Gray	30 ft
181-11019*		1.0 (25.4)	1.1 (26.9)	1.0 (25.4)	0.4 (10.2)	1.0 (25.4)	0.8 (19.1)	Gray	120 ft
181-11021*		1.0 (25.4)	1.1 (26.9)	1.0 (25.4)	0.4 (10.2)	1.0 (25.4)	0.8 (19.1)	White	120 ft
181-00564*	SLA1X1.5	1.0 (25.4)	1.6 (39.9)	1.0 (25.4)	0.4 (10.2)	1.0 (25.4)	1.2 (30.2)	Black	120 ft
181-11509*		1.0 (25.4)	1.6 (39.9)	1.0 (25.4)	0.4 (10.2)	1.0 (25.4)	1.2 (30.2)	Gray	120 ft
181-11510*		1.0 (25.4)	1.6 (39.9)	1.0 (25.4)	0.4 (10.2)	1.0 (25.4)	1.2 (30.2)	White	30 ft
181-11511*		1.0 (25.4)	1.6 (39.9)	1.0 (25.4)	0.4 (10.2)	1.0 (25.4)	1.2 (30.2)	White	120 ft

Dimensions are approximate and subject to technical changes. Use Part No. for ordering and Type for specification purposes. For wire fill capacities and wiring duct material properties, see appendix. Sold in 6-ft. lengths. Adhesive back duct orders are non-cancellable and non-returnable. *This product meets UL standards. Please see appendix for specific file numbers.



Please note! Not all products listed on this page may have this approval. Please check our website for latest approvals.

Slotted Wall Duct

Slotted Wall Wiring Duct - Adhesive Back

PART NO.	TYPE	Width (W) in. (mm)	Height (H) in. (mm)	Width (W2) in. (mm)	Width (W3) in. (mm)	Width (W4) in. (mm)	Width (W5) in. (mm)	Color	Pkg. Qty.
181-00565*	SLA1X2	1.0 (25.4)	2.1 (52.6)	1.0 (25.4)	0.4 (10.2)	1.0 (25.4)	1.6 (41.1)	Black	120 ft
181-12010*		1.0 (25.4)	2.1 (52.6)	1.0 (25.4)	0.4 (10.2)	1.0 (25.4)	1.6 (41.1)	Gray	30 ft
181-12011*		1.0 (25.4)	2.1 (52.6)	1.0 (25.4)	0.4 (10.2)	1.0 (25.4)	1.6 (41.1)	Gray	120 ft
181-12012*		1.0 (25.4)	2.1 (52.6)	1.0 (25.4)	0.4 (10.2)	1.0 (25.4)	1.6 (41.1)	White	30 ft
181-12013*		1.0 (25.4)	2.1 (52.6)	1.0 (25.4)	0.4 (10.2)	1.0 (25.4)	1.6 (41.1)	White	120 ft
181-00566*	SLA1X3	1.0 (25.4)	3.1 (77.9)	1.0 (25.4)	0.4 (10.2)	1.0 (25.4)	2.6 (66.0)	Black	120 ft
181-13009*		1.0 (25.4)	3.1 (77.9)	1.0 (25.4)	0.4 (10.2)	1.0 (25.4)	2.6 (66.0)	Gray	30 ft
181-13010*		1.0 (25.4)	3.1 (77.9)	1.0 (25.4)	0.4 (10.2)	1.0 (25.4)	2.6 (66.0)	Gray	120 ft
181-13011*		1.0 (25.4)	3.1 (77.9)	1.0 (25.4)	0.4 (10.2)	1.0 (25.4)	2.6 (66.0)	White	30 ft
181-13012*		1.0 (25.4)	3.1 (77.9)	1.0 (25.4)	0.4 (10.2)	1.0 (25.4)	2.6 (66.0)	White	120 ft
181-00567*	SLA1X4	1.0 (25.4)	4.1 (103.4)	1.0 (25.4)	0.4 (10.2)	1.0 (25.4)	3.6 (91.4)	Black	120 ft
181-00568*		1.0 (25.4)	4.1 (103.4)	1.0 (25.4)	0.4 (10.2)	1.0 (25.4)	3.6 (91.4)	Gray	120 ft
181-00569*		1.0 (25.4)	4.1 (103.4)	1.0 (25.4)	0.4 (10.2)	1.0 (25.4)	3.6 (91.4)	White	120 ft
181-00570*	SLA1.5X1	1.5 (38.1)	1.1 (26.9)	1.5 (38.1)	0.4 (10.2)	1.0 (25.4)	0.8 (19.1)	Black	120 ft
181-15108*		1.5 (38.1)	1.1 (26.9)	1.5 (38.1)	0.4 (10.2)	1.0 (25.4)	0.8 (19.1)	Gray	30 ft
181-00571*		1.5 (38.1)	1.1 (26.9)	1.5 (38.1)	0.4 (10.2)	1.0 (25.4)	0.8 (19.1)	Gray	120 ft
181-15109*		1.5 (38.1)	1.1 (26.9)	1.5 (38.1)	0.4 (10.2)	1.0 (25.4)	0.8 (19.1)	White	30 ft
181-00572*		1.5 (38.1)	1.1 (26.9)	1.5 (38.1)	0.4 (10.2)	1.0 (25.4)	0.8 (19.1)	White	120 ft

Dimensions are approximate and subject to technical changes. Use Part No. for ordering and Type for specification purposes.

For wire fill capacities and wiring duct material properties, see appendix. Sold in 6-ft. lengths. Adhesive back duct orders are non-cancellable and non-returnable. *This product meets UL standards. Please see appendix for specific file numbers.



Please note! Not all products listed on this page may have this approval. Please check our website for latest approvals.

Routing, Protection and Insulation

Wiring Duct

Slotted Wall Duct

Slotted Wall Wiring Duct - Adhesive Back

PART NO.	TYPE	Width (W) in. (mm)	Height (H) in. (mm)	Width (W2) in. (mm)	Width (W3) in. (mm)	Width (W4) in. (mm)	Width (W5) in. (mm)	Color	Pkg. Qty.
181-00027*	SLA1.5X1.5	1.5 (38.1)	1.6 (39.9)	1.5 (38.1)	0.4 (10.2)	1.0 (25.4)	1.2 (30.5)	Black	120 ft
181-15512*		1.5 (38.1)	1.6 (39.9)	1.5 (38.1)	0.4 (10.2)	1.0 (25.4)	1.2 (30.5)	Gray	30 ft
181-15513*		1.5 (38.1)	1.6 (39.9)	1.5 (38.1)	0.4 (10.2)	1.0 (25.4)	1.2 (30.5)	Gray	120 ft
181-15514*		1.5 (38.1)	1.6 (39.9)	1.5 (38.1)	0.4 (10.2)	1.0 (25.4)	1.2 (30.5)	White	30 ft
181-15515*		1.5 (38.1)	1.6 (39.9)	1.5 (38.1)	0.4 (10.2)	1.0 (25.4)	1.2 (30.5)	White	120 ft
181-00573*	SLA1.5X2	1.5 (38.1)	2.1 (52.6)	1.5 (38.1)	0.4 (10.2)	1.0 (25.4)	1.6 (40.6)	Black	120 ft
181-15210*		1.5 (38.1)	2.1 (52.6)	1.5 (38.1)	0.4 (10.2)	1.0 (25.4)	1.6 (40.6)	Gray	30 ft
181-15211*		1.5 (38.1)	2.1 (52.6)	1.5 (38.1)	0.4 (10.2)	1.0 (25.4)	1.6 (40.6)	Gray	120 ft
181-15212*		1.5 (38.1)	2.1 (52.6)	1.5 (38.1)	0.4 (10.2)	1.0 (25.4)	1.6 (40.6)	White	30 ft
181-15213*		1.5 (38.1)	2.1 (52.6)	1.5 (38.1)	0.4 (10.2)	1.0 (25.4)	1.6 (40.6)	White	120 ft
181-00575*	SLA1.5X3	1.5 (38.1)	3.1 (77.9)	1.5 (38.1)	0.4 (10.2)	1.0 (25.4)	2.6 (66.0)	Black	120 ft
181-15307*		1.5 (38.1)	3.1 (77.9)	1.5 (38.1)	0.4 (10.2)	1.0 (25.4)	2.6 (66.0)	Gray	120 ft
181-15308*		1.5 (38.1)	3.1 (77.9)	1.5 (38.1)	0.4 (10.2)	1.0 (25.4)	2.6 (66.0)	White	120 ft
181-00576*	SLA1.5X4	1.5 (38.1)	4.1 (103.4)	1.5 (38.1)	0.4 (10.2)	1.0 (25.4)	3.6 (91.4)	Black	120 ft
181-00577*		1.5 (38.1)	4.1 (103.4)	1.5 (38.1)	0.4 (10.2)	1.0 (25.4)	3.6 (91.4)	Gray	120 ft
181-00578*		1.5 (38.1)	4.1 (103.4)	1.5 (38.1)	0.4 (10.2)	1.0 (25.4)	3.6 (91.4)	White	120 ft
181-00579*	SLA2X1	2.0 (50.8)	1.1 (26.9)	2.0 (50.8)	0.4 (10.2)	1.0 (25.4)	0.8 (19.1)	Black	120 ft
181-21008*		2.0 (50.8)	1.1 (26.9)	2.0 (50.8)	0.4 (10.2)	1.0 (25.4)	0.8 (19.1)	Gray	30 ft
181-21009*		2.0 (50.8)	1.1 (26.9)	2.0 (50.8)	0.4 (10.2)	1.0 (25.4)	0.8 (19.1)	Gray	120 ft
181-21010*		2.0 (50.8)	1.1 (26.9)	2.0 (50.8)	0.4 (10.2)	1.0 (25.4)	0.8 (19.1)	White	30 ft
181-00580*		2.0 (50.8)	1.1 (26.9)	2.0 (50.8)	0.4 (10.2)	1.0 (25.4)	0.8 (19.1)	White	120 ft

Dimensions are approximate and subject to technical changes. Use Part No. for ordering and Type for specification purposes.

For wire fill capacities and wiring duct material properties, see appendix. Sold in 6-ft. lengths. Adhesive back duct orders are non-cancellable and non-returnable. *This product meets UL standards. Please see appendix for specific file numbers.



Please note! Not all products listed on this page may have this approval. Please check our website for latest approvals.

Slotted Wall Duct

Slotted Wall Wiring Duct - Adhesive Back

PART NO.	TYPE	Width (W) in. (mm)	Height (H) in. (mm)	Width (W2) in. (mm)	Width (W3) in. (mm)	Width (W4) in. (mm)	Width (W5) in. (mm)	Color	Pkg. Qty.
181-00681*	SLA2X2	2.0 (50.8)	2.1 (52.6)	2.0 (50.8)	0.4 (10.2)	1.0 (25.4)	1.6 (40.6)	Black	30 ft
181-22031*		2.0 (50.8)	2.1 (52.6)	2.0 (50.8)	0.4 (10.2)	1.0 (25.4)	1.6 (40.6)	Gray	30 ft
181-22032*		2.0 (50.8)	2.1 (52.6)	2.0 (50.8)	0.4 (10.2)	1.0 (25.4)	1.6 (40.6)	Gray	120 ft
181-22033*		2.0 (50.8)	2.1 (52.6)	2.0 (50.8)	0.4 (10.2)	1.0 (25.4)	1.6 (40.6)	White	30 ft
181-22034*		2.0 (50.8)	2.1 (52.6)	2.0 (50.8)	0.4 (10.2)	1.0 (25.4)	1.6 (40.6)	White	120 ft
181-00581*	SLA2X3	2.0 (50.8)	3.1 (77.9)	2.0 (50.8)	0.4 (10.2)	1.0 (25.4)	2.6 (66.0)	Black	120 ft
181-23010*		2.0 (50.8)	3.1 (77.9)	2.0 (50.8)	0.4 (10.2)	1.0 (25.4)	2.6 (66.0)	Gray	30 ft
181-00582*		2.0 (50.8)	3.1 (77.9)	2.0 (50.8)	0.4 (10.2)	1.0 (25.4)	2.6 (66.0)	Gray	120 ft
181-23011*		2.0 (50.8)	3.1 (77.9)	2.0 (50.8)	0.4 (10.2)	1.0 (25.4)	2.6 (66.0)	White	30 ft
181-23012*		2.0 (50.8)	3.1 (77.9)	2.0 (50.8)	0.4 (10.2)	1.0 (25.4)	2.6 (66.0)	White	120 ft
181-00583*	SLA2X4	2.0 (50.8)	4.1 (103.4)	2.0 (50.8)	0.4 (10.2)	1.0 (25.4)	3.6 (91.4)	Black	120 ft
181-24013*		2.0 (50.8)	4.1 (103.4)	2.0 (50.8)	0.4 (10.2)	1.0 (25.4)	3.6 (91.4)	Gray	120 ft
181-24014*		2.0 (50.8)	4.1 (103.4)	2.0 (50.8)	0.4 (10.2)	1.0 (25.4)	3.6 (91.4)	White	120 ft
181-00317*	SLA2X5	2.0 (50.8)	5.1 (128.8)	2.0 (50.8)	0.4 (10.2)	1.0 (25.4)	4.6 (116.8)	Black	120 ft
181-00239*		2.0 (50.8)	5.1 (128.8)	2.0 (50.8)	0.4 (10.2)	1.0 (25.4)	4.6 (116.8)	Gray	30 ft
181-00238*		2.0 (50.8)	5.1 (128.8)	2.0 (50.8)	0.4 (10.2)	1.0 (25.4)	4.6 (116.8)	Gray	120 ft
181-00243*		2.0 (50.8)	5.1 (128.8)	2.0 (50.8)	0.4 (10.2)	1.0 (25.4)	4.6 (116.8)	White	30 ft
181-00242*		2.0 (50.8)	5.1 (128.8)	2.0 (50.8)	0.4 (10.2)	1.0 (25.4)	4.6 (116.8)	White	120 ft

Dimensions are approximate and subject to technical changes. Use Part No. for ordering and Type for specification purposes.

For wire fill capacities and wiring duct material properties, see appendix. Sold in 6-ft. lengths. Adhesive back duct orders are non-cancellable and non-returnable. *This product meets UL standards. Please see appendix for specific file numbers.



Please note! Not all products listed on this page may have this approval. Please check our website for latest approvals.

Routing, Protection and Insulation

Wiring Duct

Slotted Wall Duct

Slotted Wall Wiring Duct - Adhesive Back

PART NO.	TYPE	Width (W) in. (mm)	Height (H) in. (mm)	Width (W2) in. (mm)	Width (W3) in. (mm)	Width (W4) in. (mm)	Width (W5) in. (mm)	Color	Pkg. Qty.
181-00319*	SLA2.5X3	2.5 (63.5)	3.1 (77.9)	2.5 (63.5)	0.4 (10.2)	1.0 (25.4)	2.6 (66.0)	Black	120 ft
181-00215*		2.5 (63.5)	3.1 (77.9)	2.5 (63.5)	0.4 (10.2)	1.0 (25.4)	2.6 (66.0)	Gray	30 ft
181-00214*		2.5 (63.5)	3.1 (77.9)	2.5 (63.5)	0.4 (10.2)	1.0 (25.4)	2.6 (66.0)	Gray	120 ft
181-00219*		2.5 (63.5)	3.1 (77.9)	2.5 (63.5)	0.4 (10.2)	1.0 (25.4)	2.6 (66.0)	White	30 ft
181-00218*		2.5 (63.5)	3.1 (77.9)	2.5 (63.5)	0.4 (10.2)	1.0 (25.4)	2.6 (66.0)	White	120 ft
181-00584*	SLA3X1	3.0 (76.2)	1.1 (26.9)	3.0 (76.2)	0.4 (10.2)	1.0 (25.4)	0.8 (19.1)	Black	120 ft
181-00585*		3.0 (76.2)	1.1 (26.9)	3.0 (76.2)	0.4 (10.2)	1.0 (25.4)	0.8 (19.1)	Gray	120 ft
181-00586*		3.0 (76.2)	1.1 (26.9)	3.0 (76.2)	0.4 (10.2)	1.0 (25.4)	0.8 (19.1)	White	120 ft
181-00026*	SLA3X2	3.0 (76.2)	2.1 (52.6)	3.0 (76.2)	0.4 (10.2)	1.0 (25.4)	1.6 (41.1)	Black	120 ft
181-32010*		3.0 (76.2)	2.1 (52.6)	3.0 (76.2)	0.4 (10.2)	1.0 (25.4)	1.6 (41.1)	Gray	30 ft
181-32012*		3.0 (76.2)	2.1 (52.6)	3.0 (76.2)	0.4 (10.2)	1.0 (25.4)	1.6 (41.1)	Gray	120 ft
181-32014*		3.0 (76.2)	2.1 (52.6)	3.0 (76.2)	0.4 (10.2)	1.0 (25.4)	1.6 (41.1)	White	30 ft
181-32015*		3.0 (76.2)	2.1 (52.6)	3.0 (76.2)	0.4 (10.2)	1.0 (25.4)	1.6 (41.1)	White	120 ft
181-33019*	SLA3X3	3.0 (76.2)	3.1 (77.9)	3.0 (76.2)	0.4 (10.2)	1.0 (25.4)	2.6 (66.0)	Black	30 ft
181-00159*		3.0 (76.2)	3.1 (77.9)	3.0 (76.2)	0.4 (10.2)	1.0 (25.4)	2.6 (66.0)	Black	120 ft
181-33020*		3.0 (76.2)	3.1 (77.9)	3.0 (76.2)	0.4 (10.2)	1.0 (25.4)	2.6 (66.0)	Gray	30 ft
181-33021*		3.0 (76.2)	3.1 (77.9)	3.0 (76.2)	0.4 (10.2)	1.0 (25.4)	2.6 (66.0)	Gray	120 ft
181-33023*		3.0 (76.2)	3.1 (77.9)	3.0 (76.2)	0.4 (10.2)	1.0 (25.4)	2.6 (66.0)	White	30 ft
181-33022*		3.0 (76.2)	3.1 (77.9)	3.0 (76.2)	0.4 (10.2)	1.0 (25.4)	2.6 (66.0)	White	120 ft

Dimensions are approximate and subject to technical changes. Use Part No. for ordering and Type for specification purposes.

For wire fill capacities and wiring duct material properties, see appendix. Sold in 6-ft. lengths. Adhesive back duct orders are non-cancellable and non-returnable. *This product meets UL standards. Please see appendix for specific file numbers.



Please note! Not all products listed on this page may have this approval. Please check our website for latest approvals.

Slotted Wall Duct

Slotted Wall Wiring Duct - Adhesive Back

PART NO.	TYPE	Width (W) in. (mm)	Height (H) in. (mm)	Width (W2) in. (mm)	Width (W3) in. (mm)	Width (W4) in. (mm)	Width (W5) in. (mm)	Color	Pkg. Qty.
181-00588*	SLA3X4	3.0 (76.2)	4.1 (103.4)	3.0 (76.2)	0.4 (10.2)	1.0 (25.4)	3.6 (91.4)	Black	120 ft
181-00589*		3.0 (76.2)	4.1 (103.4)	3.0 (76.2)	0.4 (10.2)	1.0 (25.4)	3.6 (91.4)	Gray	120 ft
181-34009*		3.0 (76.2)	4.1 (103.4)	3.0 (76.2)	0.4 (10.2)	1.0 (25.4)	3.6 (91.4)	White	30 ft
181-00590*		3.0 (76.2)	4.1 (103.4)	3.0 (76.2)	0.4 (10.2)	1.0 (25.4)	3.6 (91.4)	White	120 ft
181-00157*	SLA3X5	3.0 (76.2)	5.1 (128.5)	3.0 (76.2)	0.4 (10.2)	1.0 (25.4)	4.6 (116.8)	Black	120 ft
181-00156*		3.0 (76.2)	5.1 (128.5)	3.0 (76.2)	0.4 (10.2)	1.0 (25.4)	4.6 (116.8)	Gray	120 ft
181-00155*		3.0 (76.2)	5.1 (128.5)	3.0 (76.2)	0.4 (10.2)	1.0 (25.4)	4.6 (116.8)	White	120 ft
181-00591*	SLA4X2	4.0 (101.6)	2.1 (52.6)	4.0 (101.6)	0.4 (10.2)	1.0 (25.4)	1.6 (41.1)	Black	120 ft
181-42012*		4.0 (101.6)	2.1 (52.6)	4.0 (101.6)	0.4 (10.2)	1.0 (25.4)	1.6 (41.1)	Gray	30 ft
181-00592*		4.0 (101.6)	2.1 (52.6)	4.0 (101.6)	0.4 (10.2)	1.0 (25.4)	1.6 (41.1)	Gray	120 ft
181-42014*		4.0 (101.6)	2.1 (52.6)	4.0 (101.6)	0.4 (10.2)	1.0 (25.4)	1.6 (41.1)	White	120 ft
181-00593*	SLA4X3	4.0 (101.6)	3.1 (77.9)	4.0 (101.6)	0.4 (10.2)	1.0 (25.4)	2.6 (66.0)	Black	120 ft
181-43008*		4.0 (101.6)	3.1 (77.9)	4.0 (101.6)	0.4 (10.2)	1.0 (25.4)	2.6 (66.0)	Gray	120 ft
181-00594*		4.0 (101.6)	3.1 (77.9)	4.0 (101.6)	0.4 (10.2)	1.0 (25.4)	2.6 (66.0)	White	120 ft
181-00595*	SLA4X4	4.0 (101.6)	4.1 (103.4)	4.0 (101.6)	0.4 (10.2)	1.0 (25.4)	3.6 (91.4)	Black	120 ft
181-44033*		4.0 (101.6)	4.1 (103.4)	4.0 (101.6)	0.4 (10.2)	1.0 (25.4)	3.6 (91.4)	Gray	120 ft
181-00680*		4.0 (101.6)	4.1 (103.4)	4.0 (101.6)	0.4 (10.2)	1.0 (25.4)	3.6 (91.4)	White	30 ft
181-44035*		4.0 (101.6)	4.1 (103.4)	4.0 (101.6)	0.4 (10.2)	1.0 (25.4)	3.6 (91.4)	White	120 ft
181-45012*	SLA4X5	4.0 (101.6)	5.1 (128.8)	4.0 (101.6)	0.4 (10.2)	1.0 (25.4)	4.6 (116.8)	Black	60 ft
181-00596*		4.0 (101.6)	5.1 (128.8)	4.0 (101.6)	0.4 (10.2)	1.0 (25.4)	4.6 (116.8)	Gray	60 ft
181-45013*		4.0 (101.6)	5.1 (128.8)	4.0 (101.6)	0.4 (10.2)	1.0 (25.4)	4.6 (116.8)	White	60 ft

Dimensions are approximate and subject to technical changes. Use Part No. for ordering and Type for specification purposes.

For wire fill capacities and wiring duct material properties, see appendix. Sold in 6-ft. lengths. Adhesive back duct orders are non-cancellable and non-returnable. *This product meets UL standards. Please see appendix for specific file numbers.



Please note! Not all products listed on this page may have this approval. Please check our website for latest approvals.

Routing, Protection and Insulation

Wiring Duct

High Density Slotted Wall Duct

High Density Slotted Wall Wiring Duct

HellermannTyton Pro-Duct High-Density, Slotted-Wall Wiring Duct features narrow fingers equaling a 2 to 1 finger ratio compared to standard slotted wiring duct. With the narrow fingers, compact designs and components are more easily accommodated.

Features and Benefits

- Narrow fingers reduce fanning of the wires to the terminal blocks, presenting a neater appearance.
- Each finger is provided with a double restriction to hold wires in the bottom portion of the duct, allowing for easier installation.
- Mounting holes are uniform in size and are offered every 2 inches to accommodate compact designs and ease installation.
- Optional covers snap on and off easily, and are provided with a non-slip lining that insures the covers remain in place during vibration.



MATERIAL	Polyvinylchloride (PVC)
Flammability	Self-Extinguishing
Operating Temperature	+122°F (+50°C)

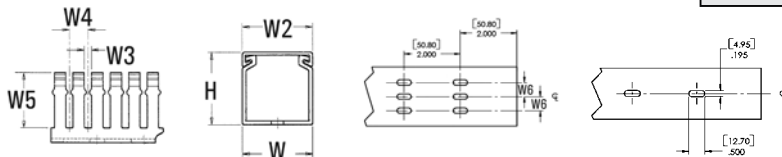

PART NO.	TYPE	Width (W) in. (mm)	Height (H) in. (mm)	Width (W2) in. (mm)	Width (W3) in. (mm)	Width (W4) in. (mm)	Width (W5) in. (mm)	Color	Pkg. Qty.
184-05525*	SLHD1X1	1.0 (25.4)	1.1 (26.9)	1.0 (25.4)	0.2 (4.1)	0.4 (10.2)	0.8 (19.1)	Black	30 ft
181-00597*		1.0 (25.4)	1.1 (26.9)	1.0 (25.4)	0.2 (4.1)	0.4 (10.2)	0.8 (19.1)	Black	120 ft
184-11000*		1.0 (25.4)	1.1 (26.9)	1.0 (25.4)	0.2 (4.1)	0.4 (10.2)	0.8 (19.1)	Gray	30 ft
184-11004*		1.0 (25.4)	1.1 (26.9)	1.0 (25.4)	0.2 (4.1)	0.4 (10.2)	0.8 (19.1)	Gray	120 ft
184-11005*		1.0 (25.4)	1.1 (26.9)	1.0 (25.4)	0.2 (4.1)	0.4 (10.2)	0.8 (19.1)	White	30 ft
184-11006*		1.0 (25.4)	1.1 (26.9)	1.0 (25.4)	0.2 (4.1)	0.4 (10.2)	0.8 (19.1)	White	120 ft
184-05534*	SLHD1X1.5	1.0 (25.4)	1.6 (39.9)	1.0 (25.4)	0.2 (4.1)	0.4 (10.2)	1.2 (30.2)	Black	30 ft
181-00598*		1.0 (25.4)	1.6 (39.9)	1.0 (25.4)	0.2 (4.1)	0.4 (10.2)	1.2 (30.2)	Black	120 ft
184-11007*		1.0 (25.4)	1.6 (39.9)	1.0 (25.4)	0.2 (4.1)	0.4 (10.2)	1.2 (30.2)	Gray	30 ft
184-11010*		1.0 (25.4)	1.6 (39.9)	1.0 (25.4)	0.2 (4.1)	0.4 (10.2)	1.2 (30.2)	Gray	120 ft
184-11011*		1.0 (25.4)	1.6 (39.9)	1.0 (25.4)	0.2 (4.1)	0.4 (10.2)	1.2 (30.2)	White	30 ft
184-11012*		1.0 (25.4)	1.6 (39.9)	1.0 (25.4)	0.2 (4.1)	0.4 (10.2)	1.2 (30.2)	White	120 ft

Dimensions are approximate and subject to technical changes. Use Part No. for ordering and Type for specification purposes.

For wire fill capacities and wiring duct material properties, see appendix. Sold in 6-ft. lengths. *This product meets UL standards. Please see appendix for specific file numbers.



Please note! Not all products listed on this page may have this approval. Please check our website for latest approvals.

High Density Slotted Wall Duct

High Density Slotted Wall Wiring Duct

PART NO.	TYPE	Width (W) in. (mm)	Height (H) in. (mm)	Width (W2) in. (mm)	Width (W3) in. (mm)	Width (W4) in. (mm)	Width (W5) in. (mm)	Color	Pkg. Qty.
184-05567*	SLHD1X2	1.0 (25.4)	2.1 (52.6)	1.0 (25.4)	0.2 (4.1)	0.4 (10.2)	1.6 (41.1)	Black	30 ft
181-00599*		1.0 (25.4)	2.1 (52.6)	1.0 (25.4)	0.2 (4.1)	0.4 (10.2)	1.6 (41.1)	Black	120 ft
184-12000*		1.0 (25.4)	2.1 (52.6)	1.0 (25.4)	0.2 (4.1)	0.4 (10.2)	1.6 (41.1)	Gray	30 ft
184-12005*		1.0 (25.4)	2.1 (52.6)	1.0 (25.4)	0.2 (4.1)	0.4 (10.2)	1.6 (41.1)	Gray	120 ft
184-12006*		1.0 (25.4)	2.1 (52.6)	1.0 (25.4)	0.2 (4.1)	0.4 (10.2)	1.6 (41.1)	White	30 ft
184-12007*		1.0 (25.4)	2.1 (52.6)	1.0 (25.4)	0.2 (4.1)	0.4 (10.2)	1.6 (41.1)	White	120 ft
184-12019*	SLHD1X3	1.0 (25.4)	3.1 (77.9)	1.0 (25.4)	0.2 (4.1)	0.4 (10.2)	2.6 (66.0)	Black	30 ft
181-00600*		1.0 (25.4)	3.1 (77.9)	1.0 (25.4)	0.2 (4.1)	0.4 (10.2)	2.6 (66.0)	Black	120 ft
184-13000*		1.0 (25.4)	3.1 (77.9)	1.0 (25.4)	0.2 (4.1)	0.4 (10.2)	2.6 (66.0)	Gray	30 ft
184-13005*		1.0 (25.4)	3.1 (77.9)	1.0 (25.4)	0.2 (4.1)	0.4 (10.2)	2.6 (66.0)	Gray	120 ft
184-13006*		1.0 (25.4)	3.1 (77.9)	1.0 (25.4)	0.2 (4.1)	0.4 (10.2)	2.6 (66.0)	White	30 ft
184-13007*		1.0 (25.4)	3.1 (77.9)	1.0 (25.4)	0.2 (4.1)	0.4 (10.2)	2.6 (66.0)	White	120 ft
184-05572*	SLHD1X4	1.0 (25.4)	4.1 (103.4)	1.0 (25.4)	0.2 (4.1)	0.4 (10.2)	3.6 (91.4)	Black	30 ft
181-00601*		1.0 (25.4)	4.1 (103.4)	1.0 (25.4)	0.2 (4.1)	0.4 (10.2)	3.6 (91.4)	Black	120 ft
184-14000*		1.0 (25.4)	4.1 (103.4)	1.0 (25.4)	0.2 (4.1)	0.4 (10.2)	3.6 (91.4)	Gray	30 ft
184-14002*		1.0 (25.4)	4.1 (103.4)	1.0 (25.4)	0.2 (4.1)	0.4 (10.2)	3.6 (91.4)	Gray	120 ft
184-14003*		1.0 (25.4)	4.1 (103.4)	1.0 (25.4)	0.2 (4.1)	0.4 (10.2)	3.6 (91.4)	White	30 ft
184-14004*		1.0 (25.4)	4.1 (103.4)	1.0 (25.4)	0.2 (4.1)	0.4 (10.2)	3.6 (91.4)	White	120 ft
181-05539*	SLHD1.5X1	1.5 (38.1)	1.1 (26.9)	1.5 (38.1)	0.2 (4.1)	0.4 (10.2)	0.8 (19.1)	Black	30 ft
181-00602*		1.5 (38.1)	1.1 (26.9)	1.5 (38.1)	0.2 (4.1)	0.4 (10.2)	0.8 (19.1)	Black	120 ft
181-00276*		1.5 (38.1)	1.1 (26.9)	1.5 (38.1)	0.2 (4.1)	0.4 (10.2)	0.8 (19.1)	Gray	30 ft
184-15101*		1.5 (38.1)	1.1 (26.9)	1.5 (38.1)	0.2 (4.1)	0.4 (10.2)	0.8 (19.1)	Gray	120 ft
181-00275*		1.5 (38.1)	1.1 (26.9)	1.5 (38.1)	0.2 (4.1)	0.4 (10.2)	0.8 (19.1)	White	30 ft
184-15102*		1.5 (38.1)	1.1 (26.9)	1.5 (38.1)	0.2 (4.1)	0.4 (10.2)	0.8 (19.1)	White	120 ft

Dimensions are approximate and subject to technical changes. Use Part No. for ordering and Type for specification purposes.

For wire fill capacities and wiring duct material properties, see appendix. Sold in 6-ft. lengths. *This product meets UL standards. Please see appendix for specific file numbers.



Please note! Not all products listed on this page may have this approval. Please check our website for latest approvals.

Routing, Protection and Insulation

Wiring Duct

High Density Slotted Wall Duct

High Density Slotted Wall Wiring Duct

PART NO.	TYPE	Width (W) in. (mm)	Height (H) in. (mm)	Width (W2) in. (mm)	Width (W3) in. (mm)	Width (W4) in. (mm)	Width (W5) in. (mm)	Color	Pkg. Qty.
184-05544*	SLHD1.5X1.5	1.5 (38.1)	1.6 (39.9)	1.5 (38.1)	0.2 (4.1)	0.4 (10.2)	1.2 (30.5)	Black	30 ft
181-00603*		1.5 (38.1)	1.6 (39.9)	1.5 (38.1)	0.2 (4.1)	0.4 (10.2)	1.2 (30.5)	Black	120 ft
184-15150*		1.5 (38.1)	1.6 (39.9)	1.5 (38.1)	0.2 (4.1)	0.4 (10.2)	1.2 (30.5)	Gray	30 ft
184-15152*		1.5 (38.1)	1.6 (39.9)	1.5 (38.1)	0.2 (4.1)	0.4 (10.2)	1.2 (30.5)	Gray	120 ft
184-15154*		1.5 (38.1)	1.6 (39.9)	1.5 (38.1)	0.2 (4.1)	0.4 (10.2)	1.2 (30.5)	White	30 ft
184-15155*		1.5 (38.1)	1.6 (39.9)	1.5 (38.1)	0.2 (4.1)	0.4 (10.2)	1.2 (30.5)	White	120 ft
184-15214*	SLHD1.5X2	1.5 (38.1)	2.1 (52.6)	1.5 (38.1)	0.2 (4.1)	0.4 (10.2)	1.6 (40.6)	Black	30 ft
181-00604*		1.5 (38.1)	2.1 (52.6)	1.5 (38.1)	0.2 (4.1)	0.4 (10.2)	1.6 (40.6)	Black	120 ft
184-15200*		1.5 (38.1)	2.1 (52.6)	1.5 (38.1)	0.2 (4.1)	0.4 (10.2)	1.6 (40.6)	Gray	30 ft
184-15202*		1.5 (38.1)	2.1 (52.6)	1.5 (38.1)	0.2 (4.1)	0.4 (10.2)	1.6 (40.6)	Gray	120 ft
184-15204*		1.5 (38.1)	2.1 (52.6)	1.5 (38.1)	0.2 (4.1)	0.4 (10.2)	1.6 (40.6)	White	30 ft
184-15206*		1.5 (38.1)	2.1 (52.6)	1.5 (38.1)	0.2 (4.1)	0.4 (10.2)	1.6 (40.6)	White	120 ft
184-22035*	SLHD1.5X3	1.5 (38.1)	3.1 (77.9)	1.5 (38.1)	0.2 (4.1)	0.4 (10.2)	2.6 (66.0)	Black	30 ft
181-00605*		1.5 (38.1)	3.1 (77.9)	1.5 (38.1)	0.2 (4.1)	0.4 (10.2)	2.6 (66.0)	Black	120 ft
184-15300*		1.5 (38.1)	3.1 (77.9)	1.5 (38.1)	0.2 (4.1)	0.4 (10.2)	2.6 (66.0)	Gray	30 ft
184-15302*		1.5 (38.1)	3.1 (77.9)	1.5 (38.1)	0.2 (4.1)	0.4 (10.2)	2.6 (66.0)	Gray	120 ft
184-15303*		1.5 (38.1)	3.1 (77.9)	1.5 (38.1)	0.2 (4.1)	0.4 (10.2)	2.6 (66.0)	White	30 ft
184-15304*		1.5 (38.1)	3.1 (77.9)	1.5 (38.1)	0.2 (4.1)	0.4 (10.2)	2.6 (66.0)	White	120 ft
184-22038*	SLHD1.5X4	1.5 (38.1)	4.1 (103.4)	1.5 (38.1)	0.2 (4.1)	0.4 (10.2)	3.6 (91.4)	Black	30 ft
181-00606*		1.5 (38.1)	4.1 (103.4)	1.5 (38.1)	0.2 (4.1)	0.4 (10.2)	3.6 (91.4)	Black	120 ft
184-15400*		1.5 (38.1)	4.1 (103.4)	1.5 (38.1)	0.2 (4.1)	0.4 (10.2)	3.6 (91.4)	Gray	30 ft
184-15401*		1.5 (38.1)	4.1 (103.4)	1.5 (38.1)	0.2 (4.1)	0.4 (10.2)	3.6 (91.4)	Gray	120 ft
184-15402*		1.5 (38.1)	4.1 (103.4)	1.5 (38.1)	0.2 (4.1)	0.4 (10.2)	3.6 (91.4)	White	30 ft
184-15403*		1.5 (38.1)	4.1 (103.4)	1.5 (38.1)	0.2 (4.1)	0.4 (10.2)	3.6 (91.4)	White	120 ft

Dimensions are approximate and subject to technical changes. Use Part No. for ordering and Type for specification purposes.
For wire fill capacities and wiring duct material properties, see appendix. Sold in 6-ft. lengths. *This product meets UL standards. Please see appendix for specific file numbers.



Please note! Not all products listed on this page may have this approval. Please check our website for latest approvals.

High Density Slotted Wall Duct

High Density Slotted Wall Wiring Duct

PART NO.	TYPE	Width (W) in. (mm)	Height (H) in. (mm)	Width (W2) in. (mm)	Width (W3) in. (mm)	Width (W4) in. (mm)	Width (W5) in. (mm)	Color	Pkg. Qty.
184-21006*	SLHD2X1	2.0 (50.8)	1.1 (26.9)	2.0 (50.8)	0.2 (4.1)	0.4 (10.2)	0.8 (19.1)	Black	30 ft
181-00607*		2.0 (50.8)	1.1 (26.9)	2.0 (50.8)	0.2 (4.1)	0.4 (10.2)	0.8 (19.1)	Black	120 ft
184-21000*		2.0 (50.8)	1.1 (26.9)	2.0 (50.8)	0.2 (4.1)	0.4 (10.2)	0.8 (19.1)	Gray	30 ft
184-21002*		2.0 (50.8)	1.1 (26.9)	2.0 (50.8)	0.2 (4.1)	0.4 (10.2)	0.8 (19.1)	Gray	120 ft
181-00284*		2.0 (50.8)	1.1 (26.9)	2.0 (50.8)	0.2 (4.1)	0.4 (10.2)	0.8 (19.1)	White	30 ft
184-21003*		2.0 (50.8)	1.1 (26.9)	2.0 (50.8)	0.2 (4.1)	0.4 (10.2)	0.8 (19.1)	White	120 ft
184-22006*	SLHD2X2	2.0 (50.8)	2.1 (52.6)	2.0 (50.8)	0.2 (4.1)	0.4 (10.2)	1.6 (40.6)	Black	30 ft
181-00608*		2.0 (50.8)	2.1 (52.6)	2.0 (50.8)	0.2 (4.1)	0.4 (10.2)	1.6 (40.6)	Black	120 ft
184-22000*		2.0 (50.8)	2.1 (52.6)	2.0 (50.8)	0.2 (4.1)	0.4 (10.2)	1.6 (40.6)	Gray	30 ft
184-22005*		2.0 (50.8)	2.1 (52.6)	2.0 (50.8)	0.2 (4.1)	0.4 (10.2)	1.6 (40.6)	Gray	120 ft
184-22007*		2.0 (50.8)	2.1 (52.6)	2.0 (50.8)	0.2 (4.1)	0.4 (10.2)	1.6 (40.6)	White	30 ft
184-22008*		2.0 (50.8)	2.1 (52.6)	2.0 (50.8)	0.2 (4.1)	0.4 (10.2)	1.6 (40.6)	White	120 ft
184-22025*	SLHD2X3	2.0 (50.8)	3.1 (77.9)	2.0 (50.8)	0.2 (4.1)	0.4 (10.2)	2.6 (66.0)	Black	30 ft
181-00609*		2.0 (50.8)	3.1 (77.9)	2.0 (50.8)	0.2 (4.1)	0.4 (10.2)	2.6 (66.0)	Black	120 ft
184-23000*		2.0 (50.8)	3.1 (77.9)	2.0 (50.8)	0.2 (4.1)	0.4 (10.2)	2.6 (66.0)	Gray	30 ft
184-23004*		2.0 (50.8)	3.1 (77.9)	2.0 (50.8)	0.2 (4.1)	0.4 (10.2)	2.6 (66.0)	Gray	120 ft
184-23005*		2.0 (50.8)	3.1 (77.9)	2.0 (50.8)	0.2 (4.1)	0.4 (10.2)	2.6 (66.0)	White	30 ft
184-23006*		2.0 (50.8)	3.1 (77.9)	2.0 (50.8)	0.2 (4.1)	0.4 (10.2)	2.6 (66.0)	White	120 ft
181-00610*	SLHD2X4	2.0 (50.8)	4.1 (103.4)	2.0 (50.8)	0.2 (4.1)	0.4 (10.2)	3.6 (91.4)	Black	120 ft
184-24000*		2.0 (50.8)	4.1 (103.4)	2.0 (50.8)	0.2 (4.1)	0.4 (10.2)	3.6 (91.4)	Gray	30 ft
184-24004*		2.0 (50.8)	4.1 (103.4)	2.0 (50.8)	0.2 (4.1)	0.4 (10.2)	3.6 (91.4)	Gray	120 ft
184-24006*		2.0 (50.8)	4.1 (103.4)	2.0 (50.8)	0.2 (4.1)	0.4 (10.2)	3.6 (91.4)	White	30 ft
184-24007*		2.0 (50.8)	4.1 (103.4)	2.0 (50.8)	0.2 (4.1)	0.4 (10.2)	3.6 (91.4)	White	120 ft

Dimensions are approximate and subject to technical changes. Use Part No. for ordering and Type for specification purposes.

For wire fill capacities and wiring duct material properties, see appendix. Sold in 6-ft. lengths. *This product meets UL standards. Please see appendix for specific file numbers.



Please note! Not all products listed on this page may have this approval. Please check our website for latest approvals.

Routing, Protection and Insulation

Wiring Duct

High Density Slotted Wall Duct

High Density Slotted Wall Wiring Duct

PART NO.	TYPE	Width (W) in. (mm)	Height (H) in. (mm)	Width (W2) in. (mm)	Width (W3) in. (mm)	Width (W4) in. (mm)	Width (W5) in. (mm)	Color	Pkg. Qty.
184-22029*	SLHD2X5	2.0 (50.8)	5.1 (128.8)	2.0 (50.8)	0.2 (4.1)	0.4 (10.2)	4.6 (116.8)	Black	30 ft
181-00320*		2.0 (50.8)	5.1 (128.8)	2.0 (50.8)	0.2 (4.1)	0.4 (10.2)	4.6 (116.8)	Black	120 ft
181-00253*		2.0 (50.8)	5.1 (128.8)	2.0 (50.8)	0.2 (4.1)	0.4 (10.2)	4.6 (116.8)	Gray	30 ft
181-00252*		2.0 (50.8)	5.1 (128.8)	2.0 (50.8)	0.2 (4.1)	0.4 (10.2)	4.6 (116.8)	Gray	120 ft
181-00257*		2.0 (50.8)	5.1 (128.8)	2.0 (50.8)	0.2 (4.1)	0.4 (10.2)	4.6 (116.8)	White	30 ft
181-00265*		2.0 (50.8)	5.1 (128.8)	2.0 (50.8)	0.2 (4.1)	0.4 (10.2)	4.6 (116.8)	White	120 ft
184-22051*	SLHD2.5X3	2.5 (63.5)	3.1 (77.9)	2.5 (63.5)	0.2 (4.1)	0.4 (10.2)	2.6 (66.0)	Black	30 ft
181-00322*		2.5 (63.5)	3.1 (77.9)	2.5 (63.5)	0.2 (4.1)	0.4 (10.2)	2.6 (66.0)	Black	120 ft
181-00229*		2.5 (63.5)	3.1 (77.9)	2.5 (63.5)	0.2 (4.1)	0.4 (10.2)	2.6 (66.0)	Gray	30 ft
181-00228*		2.5 (63.5)	3.1 (77.9)	2.5 (63.5)	0.2 (4.1)	0.4 (10.2)	2.6 (66.0)	Gray	120 ft
181-00233*		2.5 (63.5)	3.1 (77.9)	2.5 (63.5)	0.2 (4.1)	0.4 (10.2)	2.6 (66.0)	White	30 ft
181-00232*		2.5 (63.5)	3.1 (77.9)	2.5 (63.5)	0.2 (4.1)	0.4 (10.2)	2.6 (66.0)	White	120 ft
184-22061*	SLHD3X1	3.0 (76.2)	1.1 (26.9)	3.0 (76.2)	0.2 (4.1)	0.4 (10.2)	0.8 (19.1)	Black	30 ft
181-00611*		3.0 (76.2)	1.1 (26.9)	3.0 (76.2)	0.2 (4.1)	0.4 (10.2)	0.8 (19.1)	Black	120 ft
184-22060*		3.0 (76.2)	1.1 (26.9)	3.0 (76.2)	0.2 (4.1)	0.4 (10.2)	0.8 (19.1)	Gray	30 ft
181-00612*		3.0 (76.2)	1.1 (26.9)	3.0 (76.2)	0.2 (4.1)	0.4 (10.2)	0.8 (19.1)	Gray	120 ft
184-05566*		3.0 (76.2)	1.1 (26.9)	3.0 (76.2)	0.2 (4.1)	0.4 (10.2)	0.8 (19.1)	White	30 ft
181-00613*		3.0 (76.2)	1.1 (26.9)	3.0 (76.2)	0.2 (4.1)	0.4 (10.2)	0.8 (19.1)	White	120 ft
184-32002*	SLHD3X2	3.0 (76.2)	2.1 (52.6)	3.0 (76.2)	0.2 (4.1)	0.4 (10.2)	1.6 (41.1)	Black	30 ft
181-00614*		3.0 (76.2)	2.1 (52.6)	3.0 (76.2)	0.2 (4.1)	0.4 (10.2)	1.6 (41.1)	Black	120 ft
184-32000*		3.0 (76.2)	2.1 (52.6)	3.0 (76.2)	0.2 (4.1)	0.4 (10.2)	1.6 (41.1)	Gray	30 ft
184-32001*		3.0 (76.2)	2.1 (52.6)	3.0 (76.2)	0.2 (4.1)	0.4 (10.2)	1.6 (41.1)	Gray	120 ft
184-32003*		3.0 (76.2)	2.1 (52.6)	3.0 (76.2)	0.2 (4.1)	0.4 (10.2)	1.6 (41.1)	White	30 ft
184-32004*		3.0 (76.2)	2.1 (52.6)	3.0 (76.2)	0.2 (4.1)	0.4 (10.2)	1.6 (41.1)	White	120 ft

Dimensions are approximate and subject to technical changes. Use Part No. for ordering and Type for specification purposes.

For wire fill capacities and wiring duct material properties, see appendix. Sold in 6-ft. lengths. *This product meets UL standards. Please see appendix for specific file numbers.



Please note! Not all products listed on this page may have this approval. Please check our website for latest approvals.

High Density Slotted Wall Duct

High Density Slotted Wall Wiring Duct

PART NO.	TYPE	Width (W) in. (mm)	Height (H) in. (mm)	Width (W2) in. (mm)	Width (W3) in. (mm)	Width (W4) in. (mm)	Width (W5) in. (mm)	Color	Pkg. Qty.
184-33014*	SLHD3X3	3.0 (76.2)	3.1 (77.9)	3.0 (76.2)	0.2 (4.1)	0.4 (10.2)	2.6 (66.0)	Black	30 ft
181-00615*		3.0 (76.2)	3.1 (77.9)	3.0 (76.2)	0.2 (4.1)	0.4 (10.2)	2.6 (66.0)	Black	120 ft
184-33000*		3.0 (76.2)	3.1 (77.9)	3.0 (76.2)	0.2 (4.1)	0.4 (10.2)	2.6 (66.0)	Gray	30 ft
184-33002*		3.0 (76.2)	3.1 (77.9)	3.0 (76.2)	0.2 (4.1)	0.4 (10.2)	2.6 (66.0)	Gray	120 ft
184-33003*		3.0 (76.2)	3.1 (77.9)	3.0 (76.2)	0.2 (4.1)	0.4 (10.2)	2.6 (66.0)	White	30 ft
184-33004*		3.0 (76.2)	3.1 (77.9)	3.0 (76.2)	0.2 (4.1)	0.4 (10.2)	2.6 (66.0)	White	120 ft
184-22032*	SLHD3X4	3.0 (76.2)	4.1 (103.4)	3.0 (76.2)	0.2 (4.1)	0.4 (10.2)	3.6 (91.4)	Black	30 ft
181-00616*		3.0 (76.2)	4.1 (103.4)	3.0 (76.2)	0.2 (4.1)	0.4 (10.2)	3.6 (91.4)	Black	120 ft
184-34000*		3.0 (76.2)	4.1 (103.4)	3.0 (76.2)	0.2 (4.1)	0.4 (10.2)	3.6 (91.4)	Gray	30 ft
184-34003*		3.0 (76.2)	4.1 (103.4)	3.0 (76.2)	0.2 (4.1)	0.4 (10.2)	3.6 (91.4)	Gray	120 ft
184-34004*		3.0 (76.2)	4.1 (103.4)	3.0 (76.2)	0.2 (4.1)	0.4 (10.2)	3.6 (91.4)	White	30 ft
184-34005*		3.0 (76.2)	4.1 (103.4)	3.0 (76.2)	0.2 (4.1)	0.4 (10.2)	3.6 (91.4)	White	120 ft
184-05560*	SLHD3X5	3.0 (76.2)	5.1 (128.5)	3.0 (76.2)	0.2 (4.1)	0.4 (10.2)	4.6 (116.8)	Black	30 ft
181-00151*		3.0 (76.2)	5.1 (128.5)	3.0 (76.2)	0.2 (4.1)	0.4 (10.2)	4.6 (116.8)	Black	120 ft
184-05559*		3.0 (76.2)	5.1 (128.5)	3.0 (76.2)	0.2 (4.1)	0.4 (10.2)	4.6 (116.8)	Gray	30 ft
181-00150*		3.0 (76.2)	5.1 (128.5)	3.0 (76.2)	0.2 (4.1)	0.4 (10.2)	4.6 (116.8)	Gray	120 ft
184-05558*		3.0 (76.2)	5.1 (128.5)	3.0 (76.2)	0.2 (4.1)	0.4 (10.2)	4.6 (116.8)	White	30 ft
181-00149*		3.0 (76.2)	5.1 (128.5)	3.0 (76.2)	0.2 (4.1)	0.4 (10.2)	4.6 (116.8)	White	120 ft

Dimensions are approximate and subject to technical changes. Use Part No. for ordering and Type for specification purposes.
For wire fill capacities and wiring duct material properties, see appendix. Sold in 6-ft. lengths. *This product meets UL standards. Please see appendix for specific file numbers.



Please note! Not all products listed on this page may have this approval. Please check our website for latest approvals.

Routing, Protection and Insulation

Wiring Duct

High Density Slotted Wall Duct

High Density Slotted Wall Wiring Duct

PART NO.	TYPE	Width (W) in. (mm)	Height (H) in. (mm)	Width (W2) in. (mm)	Width (W3) in. (mm)	Width (W4) in. (mm)	Width (W5) in. (mm)	Color	Pkg. Qty.
184-42004*	SLHD4X2	4.0 (101.6)	2.1 (52.6)	4.0 (101.6)	0.2 (4.1)	0.4 (10.2)	1.6 (41.1)	Black	30 ft
181-00617*		4.0 (101.6)	2.1 (52.6)	4.0 (101.6)	0.2 (4.1)	0.4 (10.2)	1.6 (41.1)	Black	120 ft
184-42000*		4.0 (101.6)	2.1 (52.6)	4.0 (101.6)	0.2 (4.1)	0.4 (10.2)	1.6 (41.1)	Gray	30 ft
184-42001*		4.0 (101.6)	2.1 (52.6)	4.0 (101.6)	0.2 (4.1)	0.4 (10.2)	1.6 (41.1)	Gray	120 ft
184-42002*		4.0 (101.6)	2.1 (52.6)	4.0 (101.6)	0.2 (4.1)	0.4 (10.2)	1.6 (41.1)	White	30 ft
184-42003*		4.0 (101.6)	2.1 (52.6)	4.0 (101.6)	0.2 (4.1)	0.4 (10.2)	1.6 (41.1)	White	120 ft
184-22056*	SLHD4X3	4.0 (101.6)	3.1 (77.9)	4.0 (101.6)	0.2 (4.1)	0.4 (10.2)	2.6 (66.0)	Black	30 ft
181-00618*		4.0 (101.6)	3.1 (77.9)	4.0 (101.6)	0.2 (4.1)	0.4 (10.2)	2.6 (66.0)	Black	120 ft
184-43000*		4.0 (101.6)	3.1 (77.9)	4.0 (101.6)	0.2 (4.1)	0.4 (10.2)	2.6 (66.0)	Gray	30 ft
184-43001*		4.0 (101.6)	3.1 (77.9)	4.0 (101.6)	0.2 (4.1)	0.4 (10.2)	2.6 (66.0)	Gray	120 ft
184-43002*		4.0 (101.6)	3.1 (77.9)	4.0 (101.6)	0.2 (4.1)	0.4 (10.2)	2.6 (66.0)	White	30 ft
184-43003*		4.0 (101.6)	3.1 (77.9)	4.0 (101.6)	0.2 (4.1)	0.4 (10.2)	2.6 (66.0)	White	120 ft
184-05576*	SLHD4X4	4.0 (101.6)	4.1 (103.4)	4.0 (101.6)	0.2 (4.1)	0.4 (10.2)	3.6 (91.4)	Black	30 ft
181-00619*		4.0 (101.6)	4.1 (103.4)	4.0 (101.6)	0.2 (4.1)	0.4 (10.2)	3.6 (91.4)	Black	120 ft
184-44000*		4.0 (101.6)	4.1 (103.4)	4.0 (101.6)	0.2 (4.1)	0.4 (10.2)	3.6 (91.4)	Gray	30 ft
184-44002*		4.0 (101.6)	4.1 (103.4)	4.0 (101.6)	0.2 (4.1)	0.4 (10.2)	3.6 (91.4)	Gray	120 ft
184-44003*		4.0 (101.6)	4.1 (103.4)	4.0 (101.6)	0.2 (4.1)	0.4 (10.2)	3.6 (91.4)	White	30 ft
184-44004*		4.0 (101.6)	4.1 (103.4)	4.0 (101.6)	0.2 (4.1)	0.4 (10.2)	3.6 (91.4)	White	120 ft
181-00690*	SLHD4X5	4.0 (101.6)	5.1 (128.8)	4.0 (101.6)	0.2 (4.1)	0.4 (10.2)	4.6 (116.8)	Black	60 ft
181-00692*		4.0 (101.6)	5.1 (128.8)	4.0 (101.6)	0.2 (4.1)	0.4 (10.2)	4.6 (116.8)	Gray	60 ft
181-00691*		4.0 (101.6)	5.1 (128.8)	4.0 (101.6)	0.2 (4.1)	0.4 (10.2)	4.6 (116.8)	White	60 ft

Dimensions are approximate and subject to technical changes. Use Part No. for ordering and Type for specification purposes.

For wire fill capacities and wiring duct material properties, see appendix. Sold in 6-ft. lengths. *This product meets UL standards. Please see appendix for specific file numbers.



Please note! Not all products listed on this page may have this approval. Please check our website for latest approvals.

High Density Slotted Wall Duct

High Density Slotted Wall Wiring Duct - Intrinsic Blue

Manufactured from the same PVC material as standard Pro-Duct colors, HellermannTyton also offers an intrinsic blue color option. The intrinsic blue color indicates that the wiring contained in the duct runs to intrinsically safe components in the control panel. HellermannTyton Pro-Duct High-Density, Slotted-Wall Wiring Duct features narrow fingers equaling a 2 to 1 finger ratio compared to standard slotted wiring duct. With the narrow fingers, compact designs and components are more easily accommodated.

Features and Benefits

- Narrow fingers reduce fanning of the wires to the terminal blocks, presenting a neater appearance.
- Each finger is provided with a double restriction to hold wires in the bottom portion of the duct, allowing for easier installation.
- Mounting holes are uniform in size and are offered every 2 inches to accommodate compact designs and ease installation.
- Optional covers snap on and off easily, and are provided with a non-slip lining that insures the covers remain in place during vibration.

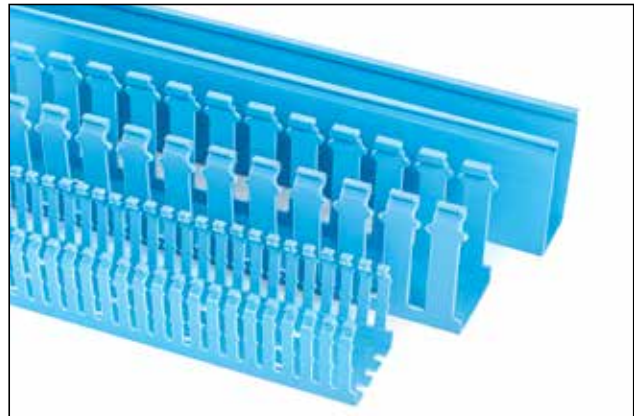

MATERIAL	Polyvinylchloride (PVC)
Flammability	Self-Extinguishing
Operating Temperature	+122°F (+50°C)

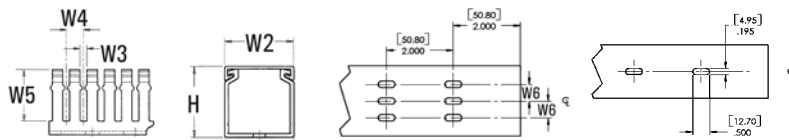

PART NO.	TYPE	Width (W) in. (mm)	Height (H) in. (mm)	Width (W2) in. (mm)	Width (W3) in. (mm)	Width (W4) in. (mm)	Width (W5) in. (mm)	Color	Pkg. Qty.
184-05524*	SLHD1X1	1.0 (25.4)	1.1 (26.9)	1.0 (25.4)	0.2 (4.1)	0.4 (10.2)	0.8 (19.1)	Intrinsic Blue	120 ft
181-05532*	SLHD1X1.5	1.0 (25.4)	1.6 (39.9)	1.0 (25.4)	0.2 (4.1)	0.4 (10.2)	1.2 (30.2)	Intrinsic Blue	120 ft
184-05570*	SLHD1X2	1.0 (25.4)	2.1 (52.6)	1.0 (25.4)	0.2 (4.1)	0.4 (10.2)	1.6 (41.1)	Intrinsic Blue	120 ft
184-05568*	SLHD1X3	1.0 (25.4)	3.1 (77.9)	1.0 (25.4)	0.2 (4.1)	0.4 (10.2)	2.6 (66.0)	Intrinsic Blue	120 ft
184-05571*	SLHD1X4	1.0 (25.4)	4.1 (103.4)	1.0 (25.4)	0.2 (4.1)	0.4 (10.2)	3.6 (91.4)	Intrinsic Blue	120 ft
184-05537*	SLHD1.5X1	1.5 (38.1)	1.1 (26.9)	1.5 (38.1)	0.2 (4.1)	0.4 (10.2)	0.8 (19.1)	Intrinsic Blue	120 ft
184-05543*	SLHD1.5X1.5	1.5 (38.1)	1.6 (39.9)	1.5 (38.1)	0.2 (4.1)	0.4 (10.2)	1.2 (30.5)	Intrinsic Blue	120 ft
184-05553*	SLHD1.5X2	1.5 (38.1)	2.1 (52.6)	1.5 (38.1)	0.2 (4.1)	0.4 (10.2)	1.6 (40.6)	Intrinsic Blue	120 ft

Dimensions are approximate and subject to technical changes. Use Part No. for ordering and Type for specification purposes.

For wire fill capacities and wiring duct material properties, see appendix. Sold in 6-ft. lengths. *This product meets UL standards. Please see appendix for specific file numbers.



Please note! Not all products listed on this page may have this approval. Please check our website for latest approvals.

Routing, Protection and Insulation

Wiring Duct

High Density Slotted Wall Duct

High Density Slotted Wall Wiring Duct - Intrinsic Blue

PART NO.	TYPE	Width (W) in. (mm)	Height (H) in. (mm)	Width (W2) in. (mm)	Width (W3) in. (mm)	Width (W4) in. (mm)	Width (W5) in. (mm)	Color	Pkg. Qty.
184-22034*	SLHD1.5X3	1.5 (38.6)	3.1 (77.9)	1.5 (38.1)	0.2 (4.1)	0.4 (10.2)	2.6 (66.0)	Intrinsic Blue	120 ft
184-22037*	SLHD1.5X4	1.5 (38.1)	4.1 (103.4)	1.5 (38.1)	0.2 (4.1)	0.4 (10.2)	3.6 (91.4)	Intrinsic Blue	120 ft
184-22040*	SLHD2X1	2.0 (50.8)	1.1 (26.9)	2.0 (50.8)	0.2 (4.1)	0.4 (10.2)	0.8 (19.1)	Intrinsic Blue	120 ft
184-22022*	SLHD2X2	2.0 (50.8)	2.1 (52.6)	2.0 (50.8)	0.2 (4.1)	0.4 (10.2)	1.6 (40.6)	Intrinsic Blue	120 ft
184-22024*	SLHD2X3	2.0 (50.8)	3.1 (77.9)	2.0 (50.8)	0.2 (4.1)	0.4 (10.2)	2.6 (66.0)	Intrinsic Blue	120 ft
184-22026*	SLHD2X4	2.0 (50.8)	4.1 (103.4)	2.0 (50.8)	0.2 (4.1)	0.4 (10.2)	3.6 (91.4)	Intrinsic Blue	120 ft
184-22028*	SLHD2X5	2.0 (50.8)	5.1 (128.8)	2.0 (50.8)	0.2 (4.1)	0.4 (10.2)	4.6 (116.8)	Intrinsic Blue	120 ft
184-22050*	SLHD2.5X3	2.5 (63.5)	3.1 (77.9)	2.5 (63.5)	0.2 (4.1)	0.4 (10.2)	2.6 (66.0)	Intrinsic Blue	120 ft
184-05565*	SLHD3X1	3.0 (76.2)	1.1 (26.9)	3.0 (76.2)	0.2 (4.1)	0.4 (10.2)	0.8 (19.1)	Intrinsic Blue	120 ft
184-22044*	SLHD3X2	3.0 (76.2)	2.1 (52.6)	3.0 (76.2)	0.2 (4.1)	0.4 (10.2)	1.6 (41.1)	Intrinsic Blue	120 ft
184-22053*	SLHD3X3	3.0 (76.2)	3.1 (77.9)	3.0 (76.2)	0.2 (4.1)	0.4 (10.2)	2.6 (66.0)	Intrinsic Blue	120 ft
181-00686*	SLHD3X4	3.0 (76.2)	4.1 (103.4)	3.0 (76.2)	0.2 (4.1)	0.4 (10.2)	3.6 (91.4)	Intrinsic Blue	120 ft
184-05557*	SLHD3X5	3.0 (76.2)	5.1 (128.5)	3.0 (76.2)	0.2 (4.1)	0.4 (10.2)	4.6 (116.8)	Intrinsic Blue	120 ft
184-05564*	SLHD4X2	4.0 (101.6)	2.1 (52.6)	4.0 (101.6)	0.2 (4.1)	0.4 (10.2)	1.6 (41.1)	Intrinsic Blue	120 ft
184-22055*	SLHD4X3	4.0 (101.6)	3.1 (77.9)	4.0 (101.6)	0.2 (4.1)	0.4 (10.2)	2.6 (66.0)	Intrinsic Blue	120 ft
184-05603*	SLHD4X4	4.0 (101.6)	4.1 (103.4)	4.0 (101.6)	0.2 (4.1)	0.4 (10.2)	3.6 (91.4)	Intrinsic Blue	120 ft

Dimensions are approximate and subject to technical changes. Use Part No. for ordering and Type for specification purposes.

For wire fill capacities and wiring duct material properties, see appendix. Sold in 6-ft. lengths. *This product meets UL standards. Please see appendix for specific file numbers.



Please note! Not all products listed on this page may have this approval. Please check our website for latest approvals.

High Density Slotted Wall Duct

High Density Slotted Wall Wiring Duct - Adhesive Back

HellermannTyton High Density Slotted Wall Duct features narrow breakaway fingers, designed at a 2-to-1 ratio compared to standard slotted duct, providing additional access for wire leads. Narrower fingers better accommodate compact designs and components. Pressure-sensitive, rubber-based adhesive backing aids in temporary positioning.

Features and Benefits

- Narrow fingers reduce fanning of wires to terminal blocks, providing a neater appearance.
- Each finger features a double restriction to hold wires in the bottom portion of the duct, simplifying installation.
- Mounting holes are uniform in size to those in slotted and solid wall duct but are provided every two inches to accommodate compact designs and provide ease of installation.
- Nonpermanent adhesive allows repositioning prior to final installation.



MATERIAL	Polyvinylchloride (PVC)
Flammability	Self-Extinguishing
Operating Temperature	+122°F (+50°C)

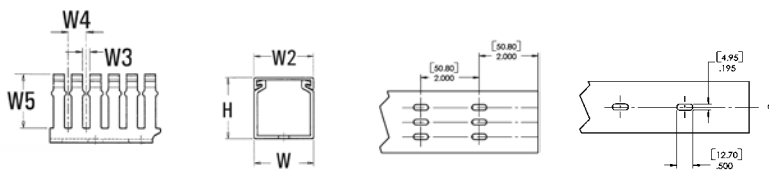

PART NO.	TYPE	Width (W) in. (mm)	Height (H) in. (mm)	Width (W2) in. (mm)	Width (W3) in. (mm)	Width (W4) in. (mm)	Width (W5) in. (mm)	Color	Pkg. Qty.
181-00637*	SLHDA1X1	1.0 (25.4)	1.1 (26.9)	1.0 (25.4)	0.2 (4.1)	0.4 (10.2)	0.8 (19.1)	Black	120 ft
184-11001*		1.0 (25.4)	1.1 (26.9)	1.0 (25.4)	0.2 (4.1)	0.4 (10.2)	0.8 (19.1)	Gray	30 ft
181-00621*		1.0 (25.4)	1.1 (26.9)	1.0 (25.4)	0.2 (4.1)	0.4 (10.2)	0.8 (19.1)	Gray	120 ft
184-11002*		1.0 (25.4)	1.1 (26.9)	1.0 (25.4)	0.2 (4.1)	0.4 (10.2)	0.8 (19.1)	White	30 ft
181-00622*		1.0 (25.4)	1.1 (26.9)	1.0 (25.4)	0.2 (4.1)	0.4 (10.2)	0.8 (19.1)	White	120 ft

Dimensions are approximate and subject to technical changes. Use Part No. for ordering and Type for specification purposes.

For wire fill capacities and wiring duct material properties, see appendix. Sold in 6-ft. lengths. Adhesive back duct orders are non-cancellable and non-returnable. *This product meets UL standards. Please see appendix for specific file numbers.



Please note! Not all products listed on this page may have this approval. Please check our website for latest approvals.

Routing, Protection and Insulation

Wiring Duct

High Density Slotted Wall Duct

High Density Slotted Wall Wiring Duct - Adhesive Back

PART NO.	TYPE	Width (W) in. (mm)	Height (H) in. (mm)	Width (W2) in. (mm)	Width (W3) in. (mm)	Width (W4) in. (mm)	Width (W5) in. (mm)	Color	Pkg. Qty.
181-00623*	SLHDA1X1.5	1.0 (25.4)	1.6 (39.9)	1.0 (25.4)	0.2 (4.1)	0.4 (10.2)	1.2 (30.2)	Black	120 ft
184-11008*		1.0 (25.4)	1.6 (39.9)	1.0 (25.4)	0.2 (4.1)	0.4 (10.2)	1.2 (30.2)	Gray	120 ft
184-11009*		1.0 (25.4)	1.6 (39.9)	1.0 (25.4)	0.2 (4.1)	0.4 (10.2)	1.2 (30.2)	White	120 ft
181-00624*	SLHDA1X2	1.0 (25.4)	2.1 (52.6)	1.0 (25.4)	0.2 (4.1)	0.4 (10.2)	1.6 (41.1)	Black	120 ft
184-12001*		1.0 (25.4)	2.1 (52.6)	1.0 (25.4)	0.2 (4.1)	0.4 (10.2)	1.6 (41.1)	Gray	30 ft
184-12002*		1.0 (25.4)	2.1 (52.6)	1.0 (25.4)	0.2 (4.1)	0.4 (10.2)	1.6 (41.1)	Gray	120 ft
184-12003*		1.0 (25.4)	2.1 (52.6)	1.0 (25.4)	0.2 (4.1)	0.4 (10.2)	1.6 (41.1)	White	30 ft
184-12004*		1.0 (25.4)	2.1 (52.6)	1.0 (25.4)	0.2 (4.1)	0.4 (10.2)	1.6 (41.1)	White	120 ft
181-00625*		1.0 (25.4)	3.1 (77.9)	1.0 (25.4)	0.2 (4.1)	0.4 (10.2)	2.6 (66.0)	Black	120 ft
184-13001*	SLHDA1X3	1.0 (25.4)	3.1 (77.9)	1.0 (25.4)	0.2 (4.1)	0.4 (10.2)	2.6 (66.0)	Gray	30 ft
181-00626*		1.0 (25.4)	3.1 (77.9)	1.0 (25.4)	0.2 (4.1)	0.4 (10.2)	2.6 (66.0)	Gray	120 ft
184-13002*		1.0 (25.4)	3.1 (77.9)	1.0 (25.4)	0.2 (4.1)	0.4 (10.2)	2.6 (66.0)	White	30 ft
184-13003*		1.0 (25.4)	3.1 (77.9)	1.0 (25.4)	0.2 (4.1)	0.4 (10.2)	2.6 (66.0)	White	120 ft
181-00627*		SLHDA1X4	1.0 (25.4)	4.1 (103.4)	1.0 (25.4)	0.2 (4.1)	0.4 (10.2)	3.6 (91.4)	Black
181-00628*	1.0 (25.4)		4.1 (103.4)	1.0 (25.4)	0.2 (4.1)	0.4 (10.2)	3.6 (91.4)	Gray	120 ft
181-00629*	1.0 (25.4)		4.1 (103.4)	1.0 (25.4)	0.2 (4.1)	0.4 (10.2)	3.6 (91.4)	White	120 ft
181-00630*	SLHDA1.5X1	1.5 (38.1)	1.1 (26.9)	1.5 (38.1)	0.2 (4.1)	0.4 (10.2)	0.8 (19.1)	Black	120 ft
181-00631*		1.5 (38.1)	1.1 (26.9)	1.5 (38.1)	0.2 (4.1)	0.4 (10.2)	0.8 (19.1)	Gray	120 ft
181-00632*		1.5 (38.1)	1.1 (26.9)	1.5 (38.1)	0.2 (4.1)	0.4 (10.2)	0.8 (19.1)	White	120 ft

Dimensions are approximate and subject to technical changes. Use Part No. for ordering and Type for specification purposes.

For wire fill capacities and wiring duct material properties, see appendix. Sold in 6-ft. lengths. Adhesive back duct orders are non-cancellable and non-returnable. *This product meets UL standards.

Please see appendix for specific file numbers.



Please note! Not all products listed on this page may have this approval. Please check our website for latest approvals.

High Density Slotted Wall Duct

High Density Slotted Wall Wiring Duct - Adhesive Back

PART NO.	TYPE	Width (W) in. (mm)	Height (H) in. (mm)	Width (W2) in. (mm)	Width (W3) in. (mm)	Width (W4) in. (mm)	Width (W5) in. (mm)	Color	Pkg. Qty.
181-00633*	SLHDA1.5X1.5	1.5 (38.1)	1.6 (39.9)	1.5 (38.1)	0.2 (4.1)	0.4 (10.2)	1.2 (30.5)	Black	120 ft
184-15151*		1.5 (38.1)	1.6 (39.9)	1.5 (38.1)	0.2 (4.1)	0.4 (10.2)	1.2 (30.5)	Gray	120 ft
184-15153*		1.5 (38.1)	1.6 (39.9)	1.5 (38.1)	0.2 (4.1)	0.4 (10.2)	1.2 (30.5)	White	120 ft
181-00634*	SLHDA1.5X2	1.5 (38.1)	2.1 (52.6)	1.5 (38.1)	0.2 (4.1)	0.4 (10.2)	1.6 (40.6)	Black	120 ft
184-15201*		1.5 (38.1)	2.1 (52.6)	1.5 (38.1)	0.2 (4.1)	0.4 (10.2)	1.6 (40.6)	Gray	120 ft
184-15205*		1.5 (38.1)	2.1 (52.6)	1.5 (38.1)	0.2 (4.1)	0.4 (10.2)	1.6 (40.6)	White	120 ft
181-00635*	SLHDA1.5X3	1.5 (38.1)	3.1 (77.9)	1.5 (38.1)	0.2 (4.1)	0.4 (10.2)	2.6 (66.0)	Black	120 ft
181-00636*		1.5 (38.1)	3.1 (77.9)	1.5 (38.1)	0.2 (4.1)	0.4 (10.2)	2.6 (66.0)	Gray	120 ft
184-15301*		1.5 (38.1)	3.1 (77.9)	1.5 (38.1)	0.2 (4.1)	0.4 (10.2)	2.6 (66.0)	White	120 ft
181-00620*	SLHDA1.5X4	1.5 (38.1)	4.1 (103.4)	1.5 (38.1)	0.2 (4.1)	0.4 (10.2)	3.6 (91.4)	Black	120 ft
181-00638*		1.5 (38.1)	4.1 (103.4)	1.5 (38.1)	0.2 (4.1)	0.4 (10.2)	3.6 (91.4)	Gray	120 ft
181-00639*		1.5 (38.1)	4.1 (103.4)	1.5 (38.1)	0.2 (4.1)	0.4 (10.2)	3.6 (91.4)	White	120 ft
181-00640*	SLHDA2X1	2.0 (50.8)	1.1 (26.9)	2.0 (50.8)	0.2 (4.1)	0.4 (10.2)	0.8 (19.1)	Black	120 ft
184-21001*		2.0 (50.8)	1.1 (26.9)	2.0 (50.8)	0.2 (4.1)	0.4 (10.2)	0.8 (19.1)	Gray	30 ft
181-00641*		2.0 (50.8)	1.1 (26.9)	2.0 (50.8)	0.2 (4.1)	0.4 (10.2)	0.8 (19.1)	Gray	120 ft
181-00676*		2.0 (50.8)	1.1 (26.9)	2.0 (50.8)	0.2 (4.1)	0.4 (10.2)	0.8 (19.1)	White	30 ft
181-00642*		2.0 (50.8)	1.1 (26.9)	2.0 (50.8)	0.2 (4.1)	0.4 (10.2)	0.8 (19.1)	White	120 ft
181-00643*		2.0 (50.8)	2.1 (52.6)	2.0 (50.8)	0.2 (4.1)	0.4 (10.2)	1.6 (40.6)	Black	120 ft
184-22001*	SLHDA2X2	2.0 (50.8)	2.1 (52.6)	2.0 (50.8)	0.2 (4.1)	0.4 (10.2)	1.6 (40.6)	Gray	30 ft
181-00644*		2.0 (50.8)	2.1 (52.6)	2.0 (50.8)	0.2 (4.1)	0.4 (10.2)	1.6 (40.6)	Gray	120 ft
184-22002*		2.0 (50.8)	2.1 (52.6)	2.0 (50.8)	0.2 (4.1)	0.4 (10.2)	1.6 (40.6)	White	30 ft
184-22003*		2.0 (50.8)	2.1 (52.6)	2.0 (50.8)	0.2 (4.1)	0.4 (10.2)	1.6 (40.6)	White	120 ft

Dimensions are approximate and subject to technical changes. Use Part No. for ordering and Type for specification purposes.

For wire fill capacities and wiring duct material properties, see appendix. Sold in 6-ft. lengths. Adhesive back duct orders are non-cancellable and non-returnable. *This product meets UL standards. Please see appendix for specific file numbers.



Please note! Not all products listed on this page may have this approval. Please check our website for latest approvals.

Routing, Protection and Insulation

Wiring Duct

High Density Slotted Wall Duct

High Density Slotted Wall Wiring Duct - Adhesive Back

PART NO.	TYPE	Width (W) in. (mm)	Height (H) in. (mm)	Width (W2) in. (mm)	Width (W3) in. (mm)	Width (W4) in. (mm)	Width (W5) in. (mm)	Color	Pkg. Qty.
181-00645*	SLHDA2X3	2.0 (50.8)	3.1 (77.9)	2.0 (50.8)	0.2 (4.1)	0.4 (10.2)	2.6 (66.0)	Black	120 ft
184-23001*		2.0 (50.8)	3.1 (77.9)	2.0 (50.8)	0.2 (4.1)	0.4 (10.2)	2.6 (66.0)	Gray	30 ft
181-00646*		2.0 (50.8)	3.1 (77.9)	2.0 (50.8)	0.2 (4.1)	0.4 (10.2)	2.6 (66.0)	Gray	120 ft
184-23002*		2.0 (50.8)	3.1 (77.9)	2.0 (50.8)	0.2 (4.1)	0.4 (10.2)	2.6 (66.0)	White	30 ft
184-23003*		2.0 (50.8)	3.1 (77.9)	2.0 (50.8)	0.2 (4.1)	0.4 (10.2)	2.6 (66.0)	White	120 ft
181-00647*	SLHDA2X4	2.0 (50.8)	4.1 (103.4)	2.0 (50.8)	0.2 (4.1)	0.4 (10.2)	3.6 (91.4)	Black	120 ft
184-24001*		2.0 (50.8)	4.1 (103.4)	2.0 (50.8)	0.2 (4.1)	0.4 (10.2)	3.6 (91.4)	Gray	30 ft
181-00648*		2.0 (50.8)	4.1 (103.4)	2.0 (50.8)	0.2 (4.1)	0.4 (10.2)	3.6 (91.4)	Gray	120 ft
184-24002*		2.0 (50.8)	4.1 (103.4)	2.0 (50.8)	0.2 (4.1)	0.4 (10.2)	3.6 (91.4)	White	30 ft
184-24003*		2.0 (50.8)	4.1 (103.4)	2.0 (50.8)	0.2 (4.1)	0.4 (10.2)	3.6 (91.4)	White	120 ft
181-00321*	SLHDA2X5	2.0 (50.8)	5.1 (128.8)	2.0 (50.8)	0.2 (4.1)	0.4 (10.2)	4.6 (116.8)	Black	120 ft
181-00254*		2.0 (50.8)	5.1 (128.8)	2.0 (50.8)	0.2 (4.1)	0.4 (10.2)	4.6 (116.8)	Gray	120 ft
181-00259*		2.0 (50.8)	5.1 (128.8)	2.0 (50.8)	0.2 (4.1)	0.4 (10.2)	4.6 (116.8)	White	120 ft
181-00323*	SLHDA2.5X3	2.5 (63.5)	3.1 (77.9)	2.5 (63.5)	0.2 (4.1)	0.4 (10.2)	2.6 (66.0)	Black	120 ft
181-00231*		2.5 (63.5)	3.1 (77.9)	2.5 (63.5)	0.2 (4.1)	0.4 (10.2)	2.6 (66.0)	Gray	30 ft
181-00230*		2.5 (63.5)	3.1 (77.9)	2.5 (63.5)	0.2 (4.1)	0.4 (10.2)	2.6 (66.0)	Gray	120 ft
181-00235*		2.5 (63.5)	3.1 (77.9)	2.5 (63.5)	0.2 (4.1)	0.4 (10.2)	2.6 (66.0)	White	30 ft
181-00234*		2.5 (63.5)	3.1 (77.9)	2.5 (63.5)	0.2 (4.1)	0.4 (10.2)	2.6 (66.0)	White	120 ft
181-00649*	SLHDA3X1	3.0 (76.2)	1.1 (26.9)	3.0 (76.2)	0.2 (4.1)	0.4 (10.2)	0.8 (19.1)	Black	120 ft
181-00651*		3.0 (76.2)	1.1 (26.9)	3.0 (76.2)	0.2 (4.1)	0.4 (10.2)	0.8 (19.1)	Gray	120 ft
181-00652*		3.0 (76.2)	1.1 (26.9)	3.0 (76.2)	0.2 (4.1)	0.4 (10.2)	0.8 (19.1)	White	120 ft

Dimensions are approximate and subject to technical changes. Use Part No. for ordering and Type for specification purposes.

For wire fill capacities and wiring duct material properties, see appendix. Sold in 6-ft. lengths. Adhesive back duct orders are non-cancellable and non-returnable. *This product meets UL standards. Please see appendix for specific file numbers.



Please note! Not all products listed on this page may have this approval. Please check our website for latest approvals.

High Density Slotted Wall Duct

High Density Slotted Wall Wiring Duct - Adhesive Back

PART NO.	TYPE	Width (W) in. (mm)	Height (H) in. (mm)	Width (W2) in. (mm)	Width (W3) in. (mm)	Width (W4) in. (mm)	Width (W5) in. (mm)	Color	Pkg. Qty.
181-00653*	SLHDA3X2	3.0 (76.2)	2.1 (52.6)	3.0 (76.2)	0.2 (4.1)	0.4 (10.2)	1.6 (41.1)	Black	120 ft
181-00654*		3.0 (76.2)	2.1 (52.6)	3.0 (76.2)	0.2 (4.1)	0.4 (10.2)	1.6 (41.1)	Gray	120 ft
181-00655*		3.0 (76.2)	2.1 (52.6)	3.0 (76.2)	0.2 (4.1)	0.4 (10.2)	1.6 (41.1)	White	120 ft
181-00656*	SLHDA3X3	3.0 (76.2)	3.1 (77.9)	3.0 (76.2)	0.2 (4.1)	0.4 (10.2)	2.6 (66.0)	Black	120 ft
181-00657*		3.0 (76.2)	3.1 (77.9)	3.0 (76.2)	0.2 (4.1)	0.4 (10.2)	2.6 (66.0)	Gray	120 ft
184-33001*		3.0 (76.2)	3.1 (77.9)	3.0 (76.2)	0.2 (4.1)	0.4 (10.2)	2.6 (66.0)	White	120 ft
181-00658*	SLHDA3X4	3.0 (76.2)	4.1 (103.4)	3.0 (76.2)	0.2 (4.1)	0.4 (10.2)	3.6 (91.4)	Black	120 ft
181-00659*		3.0 (76.2)	4.1 (103.4)	3.0 (76.2)	0.2 (4.1)	0.4 (10.2)	3.6 (91.4)	Gray	120 ft
184-34001*		3.0 (76.2)	4.1 (103.4)	3.0 (76.2)	0.2 (4.1)	0.4 (10.2)	3.6 (91.4)	White	120 ft
181-00660*	SLHDA3X5	3.0 (76.2)	5.1 (128.5)	3.0 (76.2)	0.2 (4.1)	0.4 (10.2)	4.6 (116.8)	Black	120 ft
181-00661*		3.0 (76.2)	5.1 (128.5)	3.0 (76.2)	0.2 (4.1)	0.4 (10.2)	4.6 (116.8)	Gray	120 ft
181-00662*		3.0 (76.2)	5.1 (128.5)	3.0 (76.2)	0.2 (4.1)	0.4 (10.2)	4.6 (116.8)	White	120 ft
181-00663*	SLHDA4X2	4.0 (101.6)	2.1 (52.6)	4.0 (101.6)	0.2 (4.1)	0.4 (10.2)	1.6 (41.1)	Black	120 ft
181-00664*		4.0 (101.6)	2.1 (52.6)	4.0 (101.6)	0.2 (4.1)	0.4 (10.2)	1.6 (41.1)	Gray	120 ft
181-00665*		4.0 (101.6)	2.1 (52.6)	4.0 (101.6)	0.2 (4.1)	0.4 (10.2)	1.6 (41.1)	White	120 ft
181-00154*	SLHDA4X3	4.0 (101.6)	3.1 (77.9)	4.0 (101.6)	0.2 (4.1)	0.4 (10.2)	2.6 (66.0)	Black	120 ft
181-00153*		4.0 (101.6)	3.1 (77.9)	4.0 (101.6)	0.2 (4.1)	0.4 (10.2)	2.6 (66.0)	Gray	120 ft
181-00152*		4.0 (101.6)	3.1 (77.9)	4.0 (101.6)	0.2 (4.1)	0.4 (10.2)	2.6 (66.0)	White	120 ft
181-00666*	SLHDA4X4	4.0 (101.6)	4.1 (103.4)	4.0 (101.6)	0.2 (4.1)	0.4 (10.2)	3.6 (91.4)	Black	120 ft
181-00667*		4.0 (101.6)	4.1 (103.4)	4.0 (101.6)	0.2 (4.1)	0.4 (10.2)	3.6 (91.4)	Gray	120 ft
184-44001*		4.0 (101.6)	4.1 (103.4)	4.0 (101.6)	0.2 (4.1)	0.4 (10.2)	3.6 (91.4)	White	120 ft
181-00668*	SLHDA4X5	4.0 (101.6)	5.1 (128.8)	4.0 (101.6)	0.2 (4.1)	0.4 (10.2)	4.6 (116.8)	Black	60 ft
181-00670*		4.0 (101.6)	5.1 (128.8)	4.0 (101.6)	0.2 (4.1)	0.4 (10.2)	4.6 (116.8)	Gray	60 ft
181-00669*		4.0 (101.6)	5.1 (128.8)	4.0 (101.6)	0.2 (4.1)	0.4 (10.2)	4.6 (116.8)	White	60 ft

Dimensions are approximate and subject to technical changes. Use Part No. for ordering and Type for specification purposes.

For wire fill capacities and wiring duct material properties, see appendix. Sold in 6-ft. lengths. Adhesive back duct orders are non-cancellable and non-returnable. *This product meets UL standards.

Please see appendix for specific file numbers.



Please note! Not all products listed on this page may have this approval. Please check our website for latest approvals.

Routing, Protection and Insulation

Wiring Duct

Solid Wall Duct

Solid Wall Wiring Duct

HellermannTyton's Pro-Duct, Solid Wall wiring duct efficiently routes and protects wire. Solid Wall wiring duct is designed for straight wire runs where break outs are not required. Pro-Duct, Solid Wall wiring duct is manufactured from high impact, rigid PVC, comes in standard colors of white, gray and black, and is available in 6-foot lengths.

Features and Benefits

- Solid wall construction provides excellent coverage to keep wires clean.
- Durable material protects wires from damage, with long-lasting performance.
- Available standard colors complement or contrast in light and dark environments.
- Optional covers snap on and off easily, and are provided with a non-slip lining that insures the covers remain in place during vibration.

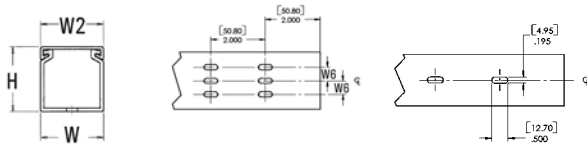

MATERIAL	Polyvinylchloride (PVC)
Flammability	Self-Extinguishing
Operating Temperature	+122°F (+50°C)



PART NO.	TYPE	Width (W) in. (mm)	Height (H) in. (mm)	Width (W2) in. (mm)	Color	Pkg. Qty.
181-05505*	SD.5X.5	0.5 (12.7)	0.6 (14.0)	0.8 (19.3)	Black	30 ft
181-05500*		0.5 (12.7)	0.6 (14.0)	0.8 (19.3)	Black	120 ft
181-00452*		0.5 (12.7)	0.6 (14.0)	0.8 (19.3)	Gray	30 ft
181-05501*		0.5 (12.7)	0.6 (14.0)	0.8 (19.3)	Gray	120 ft
181-05503*		0.5 (12.7)	0.6 (14.0)	0.8 (19.3)	White	30 ft
181-00453*		0.5 (12.7)	0.6 (14.0)	0.8 (19.3)	White	120 ft
181-05510*	SD.5X1	0.5 (12.7)	1.1 (26.7)	0.8 (19.3)	Black	30 ft
181-05100*		0.5 (12.7)	1.1 (26.7)	0.8 (19.3)	Gray	30 ft
181-05102*		0.5 (12.7)	1.1 (26.7)	0.8 (19.3)	White	30 ft

Dimensions are approximate and subject to technical changes. Use Part No. for ordering and Type for specification purposes. For wire fill capacities and wiring duct material properties, see appendix. Sold in 6-ft. lengths. *This product meets UL standards. Please see appendix for specific file numbers.



Please note! Not all products listed on this page may have this approval. Please check our website for latest approvals.

Solid Wall Duct

Solid Wall Wiring Duct

PART NO.	TYPE	Width (W) in. (mm)	Height (H) in. (mm)	Width (W2) in. (mm)	Color	Pkg. Qty.
181-05515*	SD.75X.75	0.8 (19.1)	0.8 (20.3)	1.0 (25.4)	Black	30 ft
181-75750*		0.8 (19.1)	0.8 (20.3)	1.0 (25.4)	Gray	30 ft
181-05514*		0.8 (19.1)	0.8 (20.3)	1.0 (25.4)	White	30 ft
181-00456*		0.8 (19.1)	0.8 (20.3)	1.0 (25.4)	White	120 ft
181-05519*	SD1X1	1.0 (25.4)	1.1 (26.9)	1.0 (25.4)	Black	30 ft
181-11000*		1.0 (25.4)	1.1 (26.9)	1.0 (25.4)	Black	120 ft
181-00170*		1.0 (25.4)	1.1 (26.9)	1.0 (25.4)	Gray	30 ft
181-11002*		1.0 (25.4)	1.1 (26.9)	1.0 (25.4)	Gray	120 ft
181-11004*		1.0 (25.4)	1.1 (26.9)	1.0 (25.4)	White	30 ft
181-11005*		1.0 (25.4)	1.1 (26.9)	1.0 (25.4)	White	120 ft
181-00457*	SD1X1.5	1.0 (25.4)	1.6 (39.9)	1.0 (25.4)	Black	120 ft
181-11501*		1.0 (25.4)	1.6 (39.9)	1.0 (25.4)	Gray	120 ft
181-11502*		1.0 (25.4)	1.6 (39.9)	1.0 (25.4)	White	120 ft
181-05571*	SD1X2	1.0 (25.4)	2.1 (52.6)	1.0 (25.4)	Black	30 ft
181-00458*		1.0 (25.4)	2.1 (52.6)	1.0 (25.4)	Black	120 ft
181-00172*		1.0 (25.4)	2.1 (52.6)	1.0 (25.4)	Gray	30 ft
181-12001*		1.0 (25.4)	2.1 (52.6)	1.0 (25.4)	Gray	120 ft
181-00187*		1.0 (25.4)	2.1 (52.6)	1.0 (25.4)	White	30 ft
181-12002*		1.0 (25.4)	2.1 (52.6)	1.0 (25.4)	White	120 ft

Dimensions are approximate and subject to technical changes. Use Part No. for ordering and Type for specification purposes. For wire fill capacities and wiring duct material properties, see appendix. Sold in 6-ft. lengths. *This product meets UL standards. Please see appendix for specific file numbers.



Please note! Not all products listed on this page may have this approval. Please check our website for latest approvals.

Routing, Protection and Insulation

Wiring Duct

Solid Wall Duct

Solid Wall Wiring Duct

PART NO.	TYPE	Width (W) in. (mm)	Height (H) in. (mm)	Width (W2) in. (mm)	Color	Pkg. Qty.
181-05568*	SD1X3	1.0 (25.4)	3.1 (77.9)	1.0 (25.4)	Black	30 ft
181-00459*		1.0 (25.4)	3.1 (77.9)	1.0 (25.4)	Black	120 ft
181-00174*		1.0 (25.4)	3.1 (77.9)	1.0 (25.4)	Gray	30 ft
181-00136*		1.0 (25.4)	3.1 (77.9)	1.0 (25.4)	Gray	120 ft
181-00189*		1.0 (25.4)	3.1 (77.9)	1.0 (25.4)	White	30 ft
181-13001*		1.0 (25.4)	3.1 (77.9)	1.0 (25.4)	White	120 ft
181-00460*	SD1X4	1.0 (25.4)	4.1 (103.4)	1.0 (25.4)	Black	120 ft
181-00461*		1.0 (25.4)	4.1 (103.4)	1.0 (25.4)	Gray	120 ft
181-14000*		1.0 (25.4)	4.1 (103.4)	1.0 (25.4)	White	120 ft
181-05585*	SD1.5X1	1.5 (38.1)	1.1 (26.9)	1.5 (38.1)	Black	30 ft
181-15100*		1.5 (38.1)	1.1 (26.9)	1.5 (38.1)	Black	120 ft
181-00325*		1.5 (38.1)	1.1 (26.9)	1.5 (38.1)	Gray	30 ft
181-15101*		1.5 (38.1)	1.1 (26.9)	1.5 (38.1)	Gray	120 ft
181-05584*		1.5 (38.1)	1.1 (26.9)	1.5 (38.1)	White	30 ft
181-15102*		1.5 (38.1)	1.1 (26.9)	1.5 (38.1)	White	120 ft
181-15517*	SD1.5X1.5	1.5 (38.1)	1.6 (39.9)	1.5 (38.1)	Black	30 ft
181-15500*		1.5 (38.1)	1.6 (39.9)	1.5 (38.1)	Black	120 ft
181-00176*		1.5 (38.1)	1.6 (39.9)	1.5 (38.1)	Gray	30 ft
181-15502*		1.5 (38.1)	1.6 (39.9)	1.5 (38.1)	Gray	120 ft
181-00193*		1.5 (38.1)	1.6 (39.9)	1.5 (38.1)	White	30 ft
181-15503*		1.5 (38.1)	1.6 (39.9)	1.5 (38.1)	White	120 ft

Dimensions are approximate and subject to technical changes. Use Part No. for ordering and Type for specification purposes. For wire fill capacities and wiring duct material properties, see appendix. Sold in 6-ft. lengths. *This product meets UL standards. Please see appendix for specific file numbers.



Please note! Not all products listed on this page may have this approval. Please check our website for latest approvals.

Solid Wall Duct

Solid Wall Wiring Duct

PART NO.	TYPE	Width (W) in. (mm)	Height (H) in. (mm)	Width (W2) in. (mm)	Color	Pkg. Qty.
181-05547*	SD1.5X2	1.5 (38.1)	2.1 (52.6)	1.5 (38.1)	Black	30 ft
181-00462*		1.5 (38.1)	2.1 (52.6)	1.5 (38.1)	Black	120 ft
181-15200*		1.5 (38.1)	2.1 (52.6)	1.5 (38.1)	Gray	30 ft
181-15201*		1.5 (38.1)	2.1 (52.6)	1.5 (38.1)	Gray	120 ft
181-00195*		1.5 (38.1)	2.1 (52.6)	1.5 (38.1)	White	30 ft
181-15202*		1.5 (38.1)	2.1 (52.6)	1.5 (38.1)	White	120 ft
181-23065*		SD1.5X3	1.5 (38.1)	3.1 (77.9)	1.5 (38.1)	Black
181-00463*	1.5 (38.1)		3.1 (77.9)	1.5 (38.1)	Black	120 ft
181-23064*	1.5 (38.1)		3.1 (77.9)	1.5 (38.1)	Gray	30 ft
181-15300*	1.5 (38.1)		3.1 (77.9)	1.5 (38.1)	Gray	120 ft
181-00464*	1.5 (38.1)		3.1 (77.9)	1.5 (38.1)	White	120 ft
181-23074*	SD1.5X4		1.5 (38.1)	4.1 (103.4)	1.5 (38.1)	Black
181-00465*		1.5 (38.1)	4.1 (103.4)	1.5 (38.1)	Black	120 ft
181-23073*		1.5 (38.1)	4.1 (103.4)	1.5 (38.1)	Gray	30 ft
181-00574*		1.5 (38.1)	4.1 (103.4)	1.5 (38.1)	Gray	120 ft
181-23072*		1.5 (38.1)	4.1 (103.4)	1.5 (38.1)	White	30 ft
181-00467*		1.5 (38.1)	4.1 (103.4)	1.5 (38.1)	White	120 ft

Dimensions are approximate and subject to technical changes. Use Part No. for ordering and Type for specification purposes.
For wire fill capacities and wiring duct material properties, see appendix. Sold in 6-ft. lengths. *This product meets UL standards. Please see appendix for specific file numbers.



Please note! Not all products listed on this page may have this approval. Please check our website for latest approvals.

Routing, Protection and Insulation

Wiring Duct

Solid Wall Duct

Solid Wall Wiring Duct

PART NO.	TYPE	Width (W) in. (mm)	Height (H) in. (mm)	Width (W2) in. (mm)	Color	Pkg. Qty.
181-23082*	SD2X1	2.0 (50.8)	1.1 (26.9)	2.0 (50.8)	Black	30 ft
181-21000*		2.0 (50.8)	1.1 (26.9)	2.0 (50.8)	Black	120 ft
181-00204*		2.0 (50.8)	1.1 (26.9)	2.0 (50.8)	Gray	30 ft
181-21001*		2.0 (50.8)	1.1 (26.9)	2.0 (50.8)	Gray	120 ft
181-21002*		2.0 (50.8)	1.1 (26.9)	2.0 (50.8)	White	30 ft
181-21003*		2.0 (50.8)	1.1 (26.9)	2.0 (50.8)	White	120 ft
181-23021*	SD2X2	2.0 (50.8)	2.1 (52.6)	2.0 (50.8)	Black	30 ft
181-22005*		2.0 (50.8)	2.1 (52.6)	2.0 (50.8)	Black	120 ft
181-22006*		2.0 (50.8)	2.1 (52.6)	2.0 (50.8)	Gray	30 ft
181-22008*		2.0 (50.8)	2.1 (52.6)	2.0 (50.8)	Gray	120 ft
181-22011*		2.0 (50.8)	2.1 (52.6)	2.0 (50.8)	White	30 ft
181-22013*		2.0 (50.8)	2.1 (52.6)	2.0 (50.8)	White	120 ft
181-00205*	SD2X3	2.0 (50.8)	3.1 (77.9)	2.0 (50.8)	Black	30 ft
181-00468*		2.0 (50.8)	3.1 (77.9)	2.0 (50.8)	Black	120 ft
181-23000*		2.0 (50.8)	3.1 (77.9)	2.0 (50.8)	Gray	30 ft
181-23001*		2.0 (50.8)	3.1 (77.9)	2.0 (50.8)	Gray	120 ft
181-00198*		2.0 (50.8)	3.1 (77.9)	2.0 (50.8)	White	30 ft
181-23002*		2.0 (50.8)	3.1 (77.9)	2.0 (50.8)	White	120 ft
181-00469*	SD2X4	2.0 (50.8)	4.1 (103.4)	2.0 (50.8)	Black	120 ft
181-24000*		2.0 (50.8)	4.1 (103.4)	2.0 (50.8)	Gray	120 ft
181-24001*		2.0 (50.8)	4.1 (103.4)	2.0 (50.8)	White	30 ft
181-24002*		2.0 (50.8)	4.1 (103.4)	2.0 (50.8)	White	120 ft

Dimensions are approximate and subject to technical changes. Use Part No. for ordering and Type for specification purposes. For wire fill capacities and wiring duct material properties, see appendix. Sold in 6-ft. lengths. *This product meets UL standards. Please see appendix for specific file numbers.



Please note! Not all products listed on this page may have this approval. Please check our website for latest approvals.

Solid Wall Duct

Solid Wall Wiring Duct

PART NO.	TYPE	Width (W) in. (mm)	Height (H) in. (mm)	Width (W2) in. (mm)	Color	Pkg. Qty.
181-23033*	SD2X5	2.0 (50.8)	5.1 (128.8)	2.0 (50.8)	Black	30 ft
181-00312*		2.0 (50.8)	5.1 (128.8)	2.0 (50.8)	Black	120 ft
181-00245*		2.0 (50.8)	5.1 (128.8)	2.0 (50.8)	Gray	30 ft
181-00244*		2.0 (50.8)	5.1 (128.8)	2.0 (50.8)	Gray	120 ft
181-00249*		2.0 (50.8)	5.1 (128.8)	2.0 (50.8)	White	30 ft
181-00248*		2.0 (50.8)	5.1 (128.8)	2.0 (50.8)	White	120 ft
181-23039*	SD2.5X3	2.5 (63.5)	3.1 (77.9)	2.5 (63.5)	Black	30 ft
181-00314*		2.5 (63.5)	3.1 (77.9)	2.5 (63.5)	Black	120 ft
181-00221*		2.5 (63.5)	3.1 (77.9)	2.5 (63.5)	Gray	30 ft
181-00220*		2.5 (63.5)	3.1 (77.9)	2.5 (63.5)	Gray	120 ft
181-00225*		2.5 (63.5)	3.1 (77.9)	2.5 (63.5)	White	30 ft
181-00224*		2.5 (63.5)	3.1 (77.9)	2.5 (63.5)	White	120 ft
181-00470*	SD3X1	3.0 (76.2)	1.1 (26.9)	3.0 (76.2)	Black	120 ft
181-31001*		3.0 (76.2)	1.1 (26.9)	3.0 (76.2)	Gray	120 ft
181-31002*		3.0 (76.2)	1.1 (26.9)	3.0 (76.2)	White	120 ft
181-00471*	SD3X2	3.0 (76.2)	2.1 (52.6)	3.0 (76.2)	Black	120 ft
181-00164*		3.0 (76.2)	2.1 (52.6)	3.0 (76.2)	Gray	30 ft
181-32002*		3.0 (76.2)	2.1 (52.6)	3.0 (76.2)	Gray	120 ft
181-00200*		3.0 (76.2)	2.1 (52.6)	3.0 (76.2)	White	30 ft
181-32003*		3.0 (76.2)	2.1 (52.6)	3.0 (76.2)	White	120 ft

Dimensions are approximate and subject to technical changes. Use Part No. for ordering and Type for specification purposes. For wire fill capacities and wiring duct material properties, see appendix. Sold in 6-ft. lengths. *This product meets UL standards. Please see appendix for specific file numbers.



Please note! Not all products listed on this page may have this approval. Please check our website for latest approvals.

Routing, Protection and Insulation

Wiring Duct

Solid Wall Duct

Solid Wall Wiring Duct

PART NO.	TYPE	Width (W) in. (mm)	Height (H) in. (mm)	Width (W2) in. (mm)	Color	Pkg. Qty.
181-33000*	SD3X3	3.0 (76.2)	3.1 (77.9)	3.0 (76.2)	Black	120 ft
181-33002*		3.0 (76.2)	3.1 (77.9)	3.0 (76.2)	Gray	30 ft
181-33004*		3.0 (76.2)	3.1 (77.9)	3.0 (76.2)	Gray	120 ft
181-33005*		3.0 (76.2)	3.1 (77.9)	3.0 (76.2)	White	30 ft
181-33006*		3.0 (76.2)	3.1 (77.9)	3.0 (76.2)	White	120 ft
181-23048*	SD3X4	3.0 (76.2)	4.1 (103.4)	3.0 (76.2)	Black	30 ft
181-00472*		3.0 (76.2)	4.1 (103.4)	3.0 (76.2)	Black	120 ft
181-34000*		3.0 (76.2)	4.1 (103.4)	3.0 (76.2)	Gray	120 ft
181-23046*		3.0 (76.2)	4.1 (103.4)	3.0 (76.2)	White	30 ft
181-34001*		3.0 (76.2)	4.1 (103.4)	3.0 (76.2)	White	120 ft
181-01400*	SD3X5	3.0 (76.2)	5.1 (128.5)	3.0 (76.2)	Black	30 ft
181-00473*		3.0 (76.2)	5.1 (128.5)	3.0 (76.2)	Black	120 ft
181-23058*		3.0 (76.2)	5.1 (128.5)	3.0 (76.2)	Gray	30 ft
181-00474*		3.0 (76.2)	5.1 (128.5)	3.0 (76.2)	Gray	120 ft
181-23057*		3.0 (76.2)	5.1 (128.5)	3.0 (76.2)	White	30 ft
181-00475*		3.0 (76.2)	5.1 (128.5)	3.0 (76.2)	White	120 ft
181-05594*	SD4X2	4.0 (101.6)	2.1 (52.6)	4.0 (101.6)	Black	30 ft
181-00476*		4.0 (101.6)	2.1 (52.6)	4.0 (101.6)	Black	120 ft
181-00185*		4.0 (101.6)	2.1 (52.6)	4.0 (101.6)	Gray	30 ft
181-42002*		4.0 (101.6)	2.1 (52.6)	4.0 (101.6)	Gray	120 ft
181-00203*		4.0 (101.6)	2.1 (52.6)	4.0 (101.6)	White	30 ft
181-42004*		4.0 (101.6)	2.1 (52.6)	4.0 (101.6)	White	120 ft

Dimensions are approximate and subject to technical changes. Use Part No. for ordering and Type for specification purposes. For wire fill capacities and wiring duct material properties, see appendix. Sold in 6-ft. lengths. *This product meets UL standards. Please see appendix for specific file numbers.



Please note! Not all products listed on this page may have this approval. Please check our website for latest approvals.

Solid Wall Duct

Solid Wall Wiring Duct

PART NO.	TYPE	Width (W) in. (mm)	Height (H) in. (mm)	Width (W2) in. (mm)	Color	Pkg. Qty.
181-00477*	SD4X3	4.0 (101.6)	3.1 (77.9)	4.0 (101.6)	Black	120 ft
181-43001*		4.0 (101.6)	3.1 (77.9)	4.0 (101.6)	Gray	120 ft
181-43002*		4.0 (101.6)	3.1 (77.9)	4.0 (101.6)	White	120 ft
181-00478*	SD4X4	4.0 (101.6)	4.1 (103.4)	4.0 (101.6)	Black	30 ft
181-44006*		4.0 (101.6)	4.1 (103.4)	4.0 (101.6)	Black	120 ft
181-44007*		4.0 (101.6)	4.1 (103.4)	4.0 (101.6)	Gray	30 ft
181-44009*		4.0 (101.6)	4.1 (103.4)	4.0 (101.6)	Gray	120 ft
181-44013*		4.0 (101.6)	4.1 (103.4)	4.0 (101.6)	White	30 ft
181-44015*		4.0 (101.6)	4.1 (103.4)	4.0 (101.6)	White	120 ft
181-00137*		SD4X5	4.0 (101.6)	5.1 (128.8)	4.0 (101.6)	Black
181-45000*	4.0 (101.6)		5.1 (128.8)	4.0 (101.6)	Gray	60 ft
181-45001*	4.0 (101.6)		5.1 (128.8)	4.0 (101.6)	White	60 ft
181-00479*	SD6X4	6.0 (152.4)	4.1 (103.4)	6.0 (152.4)	Black	60 ft
181-64000*		6.0 (152.4)	4.1 (103.4)	6.0 (152.4)	Gray	60 ft
181-00480*	SD8X4	8.0 (203.2)	4.1 (103.4)	8.0 (203.2)	Black	30 ft
181-84004*		8.0 (203.2)	4.1 (103.4)	8.0 (203.2)	Gray	30 ft
181-84007*		8.0 (203.2)	4.1 (103.4)	8.0 (203.2)	White	30 ft

Dimensions are approximate and subject to technical changes. Use Part No. for ordering and Type for specification purposes. For wire fill capacities and wiring duct material properties, see appendix. Sold in 6-ft. lengths. *This product meets UL standards. Please see appendix for specific file numbers.



Please note! Not all products listed on this page may have this approval. Please check our website for latest approvals.

Routing, Protection and Insulation

Wiring Duct

Solid Wall Wiring Duct

Solid Wall Wiring Duct - Intrinsic Blue

Manufactured from the same PVC material as standard Pro-Duct colors, HellermannTyton also offers an intrinsic blue color option. The intrinsic blue color indicates that the wiring contained in the duct runs to intrinsically safe components in the control panel. Solid Wall wiring duct is designed for straight wire runs where break outs are not required. Available in 6-foot lengths.

Features and Benefits

- Solid wall construction provides excellent coverage to keep wires clean.
- Durable material protects wires from damage, with long-lasting performance.
- A temporary film is applied to the covers to protect against scratches and is writable for identification during installation.
- Optional covers snap on and off easily, and are provided with a non-slip lining that insures the covers remain in place during vibration.

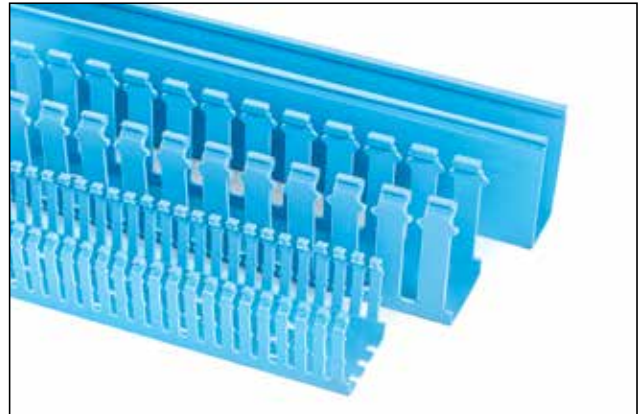

MATERIAL	Polyvinylchloride (PVC)
Flammability	Self-Extinguishing
Operating Temperature	+122°F (+50°C)

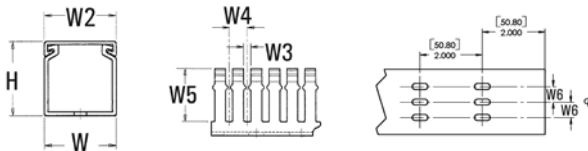

PART NO.	TYPE	Width (W) in. (mm)	Height (H) in. (mm)	Width (W2) in. (mm)	Color	Pkg. Qty.
181-05518*	SD1X1	1.0 (25.4)	1.1 (26.9)	1.0 (25.4)	Intrinsic Blue	120 ft
181-05527*	SD1X1.5	1.0 (25.4)	1.6 (39.9)	1.0 (25.4)	Intrinsic Blue	120 ft
181-05572*	SD1X2	1.0 (25.4)	2.1 (52.6)	1.0 (25.4)	Intrinsic Blue	120 ft
181-05567*	SD1X3	1.0 (25.4)	3.1 (77.9)	1.0 (25.4)	Intrinsic Blue	120 ft
181-05573*	SD1X4	1.0 (25.4)	4.1 (103.4)	1.0 (25.4)	Intrinsic Blue	120 ft
181-05583*	SD1.5X1	1.5 (38.1)	1.1 (26.9)	1.5 (38.1)	Intrinsic Blue	120 ft
181-05540*	SD1.5X1.5	1.5 (38.1)	1.6 (39.9)	1.5 (38.1)	Intrinsic Blue	120 ft
181-05546*	SD1.5X2	1.5 (38.1)	2.1 (52.6)	1.5 (38.1)	Intrinsic Blue	120 ft
181-23063*	SD1.5X3	1.5 (38.1)	3.1 (77.9)	1.5 (38.1)	Intrinsic Blue	120 ft

Dimensions are approximate and subject to technical changes. Use Part No. for ordering and Type for specification purposes. For wire fill capacities and wiring duct material properties, see appendix.



Please note! Not all products listed on this page may have this approval. Please check our website for latest approvals.

Solid Wall Wiring Duct

Solid Wall Wiring Duct - Intrinsic Blue

PART NO.	TYPE	Width (W) in. (mm)	Height (H) in. (mm)	Width (W2) in. (mm)	Color	Pkg. Qty.
181-23071*	SD1.5X4	1.5 (38.1)	4.1 (103.4)	1.5 (38.1)	Intrinsic Blue	120 ft
181-23081*	SD2X1	2.0 (50.8)	1.1 (26.9)	2.0 (50.8)	Intrinsic Blue	120 ft
181-23020*	SD2X2	2.0 (50.8)	2.1 (52.6)	2.0 (50.8)	Intrinsic Blue	120 ft
181-23022*	SD2X3	2.0 (50.8)	3.1 (77.9)	2.0 (50.8)	Intrinsic Blue	120 ft
181-23025*	SD2X4	2.0 (50.8)	4.1 (103.4)	2.0 (50.8)	Intrinsic Blue	120 ft
181-23032*	SD2X5	2.0 (50.8)	5.1 (128.8)	2.0 (50.8)	Intrinsic Blue	120 ft
181-23038*	SD2.5X3	2.5 (63.5)	3.1 (77.9)	2.5 (63.5)	Intrinsic Blue	120 ft
181-05555*	SD3X1	3.0 (76.2)	1.1 (26.9)	3.0 (76.2)	Intrinsic Blue	120 ft
181-23040*	SD3X2	3.0 (76.2)	2.1 (52.6)	3.0 (76.2)	Intrinsic Blue	120 ft
181-23094*	SD3X3	3.0 (76.2)	3.1 (77.9)	3.0 (76.2)	Intrinsic Blue	120 ft
181-23045*	SD3X4	3.0 (76.2)	4.1 (103.4)	3.0 (76.2)	Intrinsic Blue	120 ft
181-23056*	SD3X5	3.0 (76.2)	5.1 (128.5)	3.0 (76.2)	Intrinsic Blue	120 ft
181-05593*	SD4X2	4.0 (101.6)	2.1 (52.6)	4.0 (101.6)	Intrinsic Blue	120 ft
181-23097*	SD4X3	4.0 (101.6)	3.1 (77.9)	4.0 (101.6)	Intrinsic Blue	120 ft
181-05599*	SD4X4	4.0 (101.6)	4.1 (103.4)	4.0 (101.6)	Intrinsic Blue	120 ft
181-05603*	SD4X5	4.0 (101.6)	5.1 (128.8)	4.0 (101.6)	Intrinsic Blue	60 ft

Dimensions are approximate and subject to technical changes. Use Part No. for ordering and Type for specification purposes.
For wire fill capacities and wiring duct material properties, see appendix.



Please note! Not all products listed on this page may have this approval. Please check our website for latest approvals.

Routing, Protection and Insulation

Wiring Duct

Solid Wall Duct

Solid Wall Wiring Duct - Adhesive Back

HellermannTyton Solid Wall Duct efficiently routes and protects wire. It is designed for straight wire runs where break-outs are not required. Manufactured from high impact, rigid PVC, it comes in six-foot lengths. Pressure-sensitive, rubber-based adhesive backing aids in temporary positioning.

Features and Benefits

- Solid wall construction provides excellent coverage to keep wires clean.
- Durable material protects wires from damage, with long-lasting performance.
- Standard colors complement or contrast light and dark environments.
- Nonpermanent adhesive allows repositioning prior to final installation.
- Optional covers snap on and off easily, and their nonslip lining ensures they stay in place even under vibration.

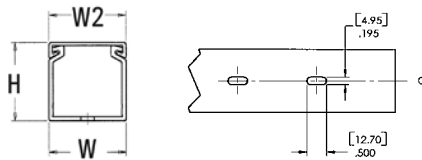

MATERIAL	Polyvinylchloride (PVC)
Flammability	Self-Extinguishing
Operating Temperature	+122°F (+50°C)



PART NO.	TYPE	Width (W) in. (mm)	Height (H) in. (mm)	Width (W2) in. (mm)	Color	Pkg. Qty.
181-75752*	SDA.75X.75	0.8 (19.1)	0.8 (20.3)	1.0 (25.4)	Gray	30 ft
181-00142*		0.8 (19.1)	0.8 (20.3)	1.0 (25.4)	White	120 ft
181-00492*	SDA1X1	1.0 (25.4)	1.1 (26.9)	1.0 (25.4)	Black	30 ft
181-11006*		1.0 (25.4)	1.1 (26.9)	1.0 (25.4)	Black	120 ft
181-00493*		1.0 (25.4)	1.1 (26.9)	1.0 (25.4)	Gray	120 ft
181-11008*		1.0 (25.4)	1.1 (26.9)	1.0 (25.4)	White	120 ft

Dimensions are approximate and subject to technical changes. Use Part No. for ordering and Type for specification purposes.

For wire fill capacities and wiring duct material properties, see appendix. Sold in 6-ft. lengths. Adhesive back duct orders are non-cancellable and non-returnable. *This product meets UL standards. Please see appendix for specific file numbers.



Please note! Not all products listed on this page may have this approval. Please check our website for latest approvals.

Solid Wall Duct

Solid Wall Wiring Duct - Adhesive Back

PART NO.	TYPE	Width (W) in. (mm)	Height (H) in. (mm)	Width (W2) in. (mm)	Color	Pkg. Qty.
181-00529*	SDA1X1.5	1.0 (25.4)	1.6 (39.9)	1.0 (25.4)	Black	120 ft
181-00490*		1.0 (25.4)	1.6 (39.9)	1.0 (25.4)	Gray	120 ft
181-00491*		1.0 (25.4)	1.6 (39.9)	1.0 (25.4)	White	120 ft
181-00530*	SDA1X2	1.0 (25.4)	2.1 (52.6)	1.0 (25.4)	Black	120 ft
181-00494*		1.0 (25.4)	2.1 (52.6)	1.0 (25.4)	Gray	120 ft
181-00495*		1.0 (25.4)	2.1 (52.6)	1.0 (25.4)	White	120 ft
181-00531*	SDA1X3	1.0 (25.4)	3.1 (77.9)	1.0 (25.4)	Black	120 ft
181-00671*		1.0 (25.4)	3.1 (77.9)	1.0 (25.4)	Gray	120 ft
181-00496*		1.0 (25.4)	3.1 (77.9)	1.0 (25.4)	White	120 ft
181-00532*	SDA1X4	1.0 (25.4)	4.1 (103.4)	1.0 (25.4)	Black	120 ft
181-00533*		1.0 (25.4)	4.1 (103.4)	1.0 (25.4)	Gray	120 ft
181-00497*		1.0 (25.4)	4.1 (103.4)	1.0 (25.4)	White	120 ft
181-00485*	SDA1.5X1	1.5 (38.1)	1.1 (26.9)	1.5 (38.1)	Black	120 ft
181-00175*		1.5 (38.1)	1.1 (26.9)	1.5 (38.1)	Gray	120 ft
181-00486*		1.5 (38.1)	1.1 (26.9)	1.5 (38.1)	White	120 ft
181-00482*	SDA1.5X1.5	1.5 (38.1)	1.6 (39.9)	1.5 (38.1)	Black	120 ft
181-00483*		1.5 (38.1)	1.6 (39.9)	1.5 (38.1)	Gray	120 ft
181-15504*		1.5 (38.1)	1.6 (39.9)	1.5 (38.1)	White	120 ft
181-00534*	SDA1.5X2	1.5 (38.1)	2.1 (52.6)	1.5 (38.1)	Black	120 ft
181-00487*		1.5 (38.1)	2.1 (52.6)	1.5 (38.1)	Gray	120 ft
181-00488*		1.5 (38.1)	2.1 (52.6)	1.5 (38.1)	White	120 ft

Dimensions are approximate and subject to technical changes. Use Part No. for ordering and Type for specification purposes.

For wire fill capacities and wiring duct material properties, see appendix. Sold in 6-ft. lengths. Adhesive back duct orders are non-cancellable and non-returnable. *This product meets UL standards. Please see appendix for specific file numbers.



Please note! Not all products listed on this page may have this approval. Please check our website for latest approvals.

Routing, Protection and Insulation

Wiring Duct

Solid Wall Duct

Solid Wall Wiring Duct - Adhesive Back

PART NO.	TYPE	Width (W) in. (mm)	Height (H) in. (mm)	Width (W2) in. (mm)	Color	Pkg. Qty.
181-00535*	SDA1.5X3	1.5 (38.1)	3.1 (77.9)	1.5 (38.1)	Black	120 ft
181-00489*		1.5 (38.1)	3.1 (77.9)	1.5 (38.1)	Gray	120 ft
181-00536*		1.5 (38.1)	3.1 (77.9)	1.5 (38.1)	White	120 ft
181-00537*	SDA1.5X4	1.5 (38.1)	4.1 (103.4)	1.5 (38.1)	Black	120 ft
181-00538*		1.5 (38.1)	4.1 (103.4)	1.5 (38.1)	Gray	120 ft
181-00539*		1.5 (38.1)	4.1 (103.4)	1.5 (38.1)	White	120 ft
181-00498*	SDA2X1	2.0 (50.8)	1.1 (26.9)	2.0 (50.8)	Black	120 ft
181-00499*		2.0 (50.8)	1.1 (26.9)	2.0 (50.8)	Gray	120 ft
181-00500*		2.0 (50.8)	1.1 (26.9)	2.0 (50.8)	White	120 ft
181-00501*	SDA2X2	2.0 (50.8)	2.1 (52.6)	2.0 (50.8)	Black	120 ft
181-22016*		2.0 (50.8)	2.1 (52.6)	2.0 (50.8)	Gray	120 ft
181-22017*		2.0 (50.8)	2.1 (52.6)	2.0 (50.8)	White	30 ft
181-22018*		2.0 (50.8)	2.1 (52.6)	2.0 (50.8)	White	120 ft
181-00540*	SDA2X3	2.0 (50.8)	3.1 (77.9)	2.0 (50.8)	Black	120 ft
181-00503*		2.0 (50.8)	3.1 (77.9)	2.0 (50.8)	Gray	120 ft
181-00504*		2.0 (50.8)	3.1 (77.9)	2.0 (50.8)	White	120 ft
181-00541*	SDA2X4	2.0 (50.8)	4.1 (103.4)	2.0 (50.8)	Black	120 ft
181-00505*		2.0 (50.8)	4.1 (103.4)	2.0 (50.8)	Gray	120 ft
181-00506*		2.0 (50.8)	4.1 (103.4)	2.0 (50.8)	White	120 ft

Dimensions are approximate and subject to technical changes. Use Part No. for ordering and Type for specification purposes.

For wire fill capacities and wiring duct material properties, see appendix. Sold in 6-ft. lengths. Adhesive back duct orders are non-cancellable and non-returnable. *This product meets UL standards. Please see appendix for specific file numbers.



Please note! Not all products listed on this page may have this approval. Please check our website for latest approvals.

Solid Wall Duct

Solid Wall Wiring Duct - Adhesive Back

PART NO.	TYPE	Width (W) in. (mm)	Height (H) in. (mm)	Width (W2) in. (mm)	Color	Pkg. Qty.
181-00313*	SDA2X5	2.0 (50.8)	5.1 (128.8)	2.0 (50.8)	Black	120 ft
181-00246*		2.0 (50.8)	5.1 (128.8)	2.0 (50.8)	Gray	120 ft
181-00250*		2.0 (50.8)	5.1 (128.8)	2.0 (50.8)	White	120 ft
181-00315*	SDA2.5X3	2.5 (63.5)	3.1 (77.9)	2.5 (63.5)	Black	120 ft
181-00223*		2.5 (63.5)	3.1 (77.9)	2.5 (63.5)	Gray	30 ft
181-00222*		2.5 (63.5)	3.1 (77.9)	2.5 (63.5)	Gray	120 ft
181-00227*		2.5 (63.5)	3.1 (77.9)	2.5 (63.5)	White	30 ft
181-00226*		2.5 (63.5)	3.1 (77.9)	2.5 (63.5)	White	120 ft
181-00672*		SDA3X1	3.0 (76.2)	1.1 (26.9)	3.0 (76.2)	Black
181-00507*	3.0 (76.2)		1.1 (26.9)	3.0 (76.2)	Gray	120 ft
181-00508*	3.0 (76.2)		1.1 (26.9)	3.0 (76.2)	White	120 ft
181-00542*	SDA3X2	3.0 (76.2)	2.1 (52.6)	3.0 (76.2)	Black	120 ft
181-00509*		3.0 (76.2)	2.1 (52.6)	3.0 (76.2)	Gray	120 ft
181-00510*		3.0 (76.2)	2.1 (52.6)	3.0 (76.2)	White	120 ft
181-00511*	SDA3X3	3.0 (76.2)	3.1 (77.9)	3.0 (76.2)	Black	120 ft
181-00512*		3.0 (76.2)	3.1 (77.9)	3.0 (76.2)	Gray	120 ft
181-00513*		3.0 (76.2)	3.1 (77.9)	3.0 (76.2)	White	120 ft
181-00147*	SDA3X4	3.0 (76.2)	4.1 (103.4)	3.0 (76.2)	Black	120 ft
181-00514*		3.0 (76.2)	4.1 (103.4)	3.0 (76.2)	Gray	120 ft
181-00515*		3.0 (76.2)	4.1 (103.4)	3.0 (76.2)	White	120 ft

Dimensions are approximate and subject to technical changes. Use Part No. for ordering and Type for specification purposes.

For wire fill capacities and wiring duct material properties, see appendix. Sold in 6-ft. lengths. Adhesive back duct orders are non-cancellable and non-returnable. *This product meets UL standards. Please see appendix for specific file numbers.



Please note! Not all products listed on this page may have this approval. Please check our website for latest approvals.

Routing, Protection and Insulation

Wiring Duct

Solid Wall Duct

Solid Wall Wiring Duct - Adhesive Back

PART NO.	TYPE	Width (W) in. (mm)	Height (H) in. (mm)	Width (W2) in. (mm)	Color	Pkg. Qty.
181-00543*	SDA3X5	3.0 (76.2)	5.1 (128.5)	3.0 (76.2)	Black	120 ft
181-00148*		3.0 (76.2)	5.1 (128.5)	3.0 (76.2)	Gray	120 ft
181-00544*		3.0 (76.2)	5.1 (128.5)	3.0 (76.2)	White	120 ft
181-00545*	SDA4X2	4.0 (101.6)	2.1 (52.6)	4.0 (101.6)	Black	120 ft
181-00516*		4.0 (101.6)	2.1 (52.6)	4.0 (101.6)	Gray	120 ft
181-00517*		4.0 (101.6)	2.1 (52.6)	4.0 (101.6)	White	120 ft
181-00546*	SDA4X3	4.0 (101.6)	3.1 (77.9)	4.0 (101.6)	Black	120 ft
181-00518*		4.0 (101.6)	3.1 (77.9)	4.0 (101.6)	Gray	120 ft
181-00519*		4.0 (101.6)	3.1 (77.9)	4.0 (101.6)	White	120 ft
181-00520*	SDA4X4	4.0 (101.6)	4.1 (103.4)	4.0 (101.6)	Black	120 ft
181-44018*		4.0 (101.6)	4.1 (103.4)	4.0 (101.6)	Gray	120 ft
181-00521*		4.0 (101.6)	4.1 (103.4)	4.0 (101.6)	White	120 ft
181-00547*	SDA4X5	4.0 (101.6)	5.1 (128.8)	4.0 (101.6)	Black	60 ft
181-00522*		4.0 (101.6)	5.1 (128.8)	4.0 (101.6)	Gray	60 ft
181-00523*		4.0 (101.6)	5.1 (128.8)	4.0 (101.6)	White	60 ft

Dimensions are approximate and subject to technical changes. Use Part No. for ordering and Type for specification purposes.
For wire fill capacities and wiring duct material properties, see appendix. Sold in 6-ft. lengths. Adhesive back duct orders are non-cancellable and non-returnable. *This product meets UL standards.
Please see appendix for specific file numbers.



Please note! Not all products listed on this page may have this approval. Please check our website for latest approvals.

Duct Covers

Wiring Duct Covers

HellermannTyton Pro-Duct wiring duct covers are sold separately and are interchangeable among the three styles of duct (solid, slotted and high density.) Manufactured from high impact, rigid PVC, Pro-Duct covers come in standard colors of white, gray and black. Wiring duct covers are available in 6-foot lengths.

Features and Benefits

- A temporary film is applied to the covers to protect against scratches and is writable for identification during installation.
- Cover is flush with the side of the duct for increased wire capacity and allows for tight, side-by-side duct placement.
- Covers are provided with a nonslip lining that ensures the covers remain in place during vibration, yet easily snap on and off.



MATERIAL	Polyvinylchloride (PVC)
Flammability	Self-Extinguishing
Operating Temperature	+122°F (+50°C)



PART NO.	TYPE	Width (W) in. (mm)	Color	Pkg. Qty.
181-90052*	TC.5	0.6 (16.3)	Black	30 ft
181-90050*		0.6 (16.3)	Black	120 ft
181-00442*		0.6 (16.3)	Gray	30 ft
181-90051*		0.6 (16.3)	Gray	120 ft
181-91517*		0.6 (16.3)	White	30 ft
181-00443*		0.6 (16.3)	White	120 ft
181-00445*	TC.75	0.9 (22.6)	Black	120 ft
181-00446*		0.9 (22.6)	Gray	30 ft
181-90750*		0.9 (22.6)	Gray	120 ft
181-00447*		0.9 (22.6)	White	30 ft
181-90751*		0.9 (22.6)	White	120 ft
181-00444*	TC1	1.0 (25.4)	Black	30 ft
181-91000*		1.0 (25.4)	Black	120 ft
181-91003*		1.0 (25.4)	Gray	30 ft
181-91004*		1.0 (25.4)	Gray	120 ft
181-91007*		1.0 (25.4)	White	30 ft
181-91008*		1.0 (25.4)	White	120 ft

Dimensions are approximate and subject to technical changes. Use Part No. for ordering and Type for specification purposes. Sold in 6-ft. lengths. *This product meets UL standards. Please see appendix for specific file numbers.



Please note! Not all products listed on this page may have this approval. Please check our website for latest approvals.

Routing, Protection and Insulation

Wiring Duct

Duct Covers

Wiring Duct Covers

PART NO.	TYPE	Width (W) in. (mm)	Color	Pkg. Qty.
181-91516*	TC1.5	1.5 (38.1)	Black	30 ft
181-91503*		1.5 (38.1)	Black	120 ft
181-91506*		1.5 (38.1)	Gray	30 ft
181-91507*		1.5 (38.1)	Gray	120 ft
181-91509*		1.5 (38.1)	White	30 ft
181-91510*		1.5 (38.1)	White	120 ft
181-92015*	TC2	2.0 (50.8)	Black	30 ft
181-92001*		2.0 (50.8)	Black	120 ft
181-92004*		2.0 (50.8)	Gray	30 ft
181-92005*		2.0 (50.8)	Gray	120 ft
181-92010*		2.0 (50.8)	White	30 ft
181-92011*		2.0 (50.8)	White	120 ft
181-00311*	TC2.5	2.5 (63.5)	Black	120 ft
181-00261*		2.5 (63.5)	Gray	30 ft
181-00260*		2.5 (63.5)	Gray	120 ft
181-00263*		2.5 (63.5)	White	30 ft
181-00262*		2.5 (63.5)	White	120 ft
181-93000*	TC3	3.0 (76.2)	Black	30 ft
181-93003*		3.0 (76.2)	Black	120 ft
181-93007*		3.0 (76.2)	Gray	30 ft
181-93008*		3.0 (76.2)	Gray	120 ft
181-93010*		3.0 (76.2)	White	30 ft
181-93011*		3.0 (76.2)	White	120 ft
181-94000*	TC4	4.0 (101.6)	Black	30 ft
181-94003*		4.0 (101.6)	Black	120 ft
181-94008*		4.0 (101.6)	Gray	30 ft
181-94009*		4.0 (101.6)	Gray	120 ft
181-94013*		4.0 (101.6)	White	30 ft
181-94014*		4.0 (101.6)	White	120 ft
181-00448*	TC6	6.0 (152.4)	Black	30 ft
181-96000*		6.0 (152.4)	Gray	30 ft
181-96002*		6.0 (152.4)	White	30 ft
181-00449*	TC8	8.0 (203.2)	Black	60 ft
181-00165*		8.0 (203.2)	Gray	30 ft
181-00450*		8.0 (203.2)	Gray	60 ft
181-00166*		8.0 (203.2)	White	30 ft
181-00451*		8.0 (203.2)	White	60 ft

Dimensions are approximate and subject to technical changes. Use Part No. for ordering and Type for specification purposes. Sold in 6-ft. lengths. *This product meets UL standards. Please see appendix for specific file numbers.



Please note! Not all products listed on this page may have this approval. Please check our website for latest approvals.

Duct Covers

Wiring Duct Covers - Intrinsic Blue

Manufactured from the same PVC material as standard Pro-Duct colors, HellermannTyton also offers an intrinsic blue color option. The intrinsic blue color indicates that the wiring contained in the duct runs to intrinsically safe components in the control panel. HellermannTyton Pro-Duct wiring duct covers are sold separately and are interchangeable among the three styles of duct (solid, slotted and high density.) Wiring duct covers are available in 6-foot lengths.

Features and Benefits

- A temporary film is applied to the covers to protect against scratches and is writable for identification during installation.
- Cover is flush with the side of the duct for increased wire capacity and allows for tight, side-by-side duct placement.
- Covers are provided with a nonslip lining that ensures the covers remain in place during vibration, yet easily snap on and off.



MATERIAL	Polyvinylchloride (PVC)
Flammability	Self-Extinguishing
Operating Temperature	+122°F (+50°C)



PART NO.	TYPE	Width (W) in. (mm)	Color	Pkg. Qty.
181-91002*	TC1	1.0 (25.4)	Blue	120 ft
181-91505*	TC1.5	1.5 (38.1)	Blue	120 ft
181-92002*	TC2	2.0 (50.8)	Blue	30 ft
181-92003*		2.0 (50.8)	Blue	120 ft
181-93005*	TC3	3.0 (76.2)	Blue	120 ft
181-94007*	TC4	4.0 (101.6)	Blue	120 ft

Dimensions are approximate and subject to technical changes. Use Part No. for ordering and Type for specification purposes. Sold in 6-ft. lengths. *This product meets UL standards. Please see appendix for specific file numbers.



Please note! Not all products listed on this page may have this approval. Please check our website for latest approvals.

Routing, Protection and Insulation

Wiring Duct

Duct Dividers

Wiring Duct Dividers

Solid-Wall Dividers can be securely mounted into all types of HellermannTyton wiring duct to separate high and low voltage, thus reducing interference. The dividers simply snap or slide into the specially designed mount, instantly creating multiple channels within a single duct size.

Features and Benefits

- Dividers have continuous score lines for smooth breakouts.
- Top of the dividers has a double-sided lip which reduces the likelihood of wires falling out during installation.

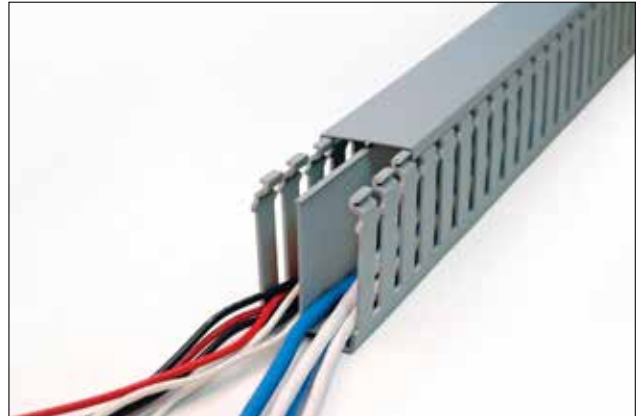

MATERIAL	Polyvinylchloride (PVC)
Flammability	Self-Extinguishing
Operating Temperature	+122°F (+50°C)



PART NO.	TYPE	Width (W) in. (mm)	Height (H) in. (mm)	Description	Color	Pkg. Qty.
181-00300	DV1	0.8 (19.1)	0.9 (22.9)	Wiring Duct Divider, 1" High	Gray	120 ft
181-00305		0.8 (19.1)	0.9 (22.9)	Wiring Duct Divider, 1" High	White	120 ft
181-00301	DV1.5	0.8 (19.1)	1.4 (35.6)	Wiring Duct Divider, 1.5" High	Gray	120 ft
181-00306		0.8 (19.1)	1.4 (35.6)	Wiring Duct Divider, 1.5" High	White	120 ft
181-00302	DV2	0.8 (19.1)	1.9 (47.0)	Wiring Duct Divider, 2" High	Gray	120 ft
181-00307		0.8 (19.1)	1.9 (47.0)	Wiring Duct Divider, 2" High	White	120 ft
181-00303	DV3	0.8 (19.6)	2.9 (72.4)	Wiring Duct Divider, 3" High	Gray	120 ft
181-00308		0.8 (19.6)	2.9 (72.4)	Wiring Duct Divider, 3" High	White	120 ft
181-00304	DV4	0.8 (19.6)	3.9 (97.8)	Wiring Duct Divider, 4" High	Gray	120 ft
181-00309		0.8 (19.6)	3.9 (97.8)	Wiring Duct Divider, 4" High	White	120 ft

Dimensions are approximate and subject to technical changes. Use Part No. for ordering and Type for specification purposes.
Sold in 6-ft. lengths.

Duct Dividers

Universal Wiring Duct Mount

The HellermannTyton universal wiring duct mount is a multi-purpose mount that secures duct dividers or secures wire bundles inside the duct with a cable tie. The mount can be installed with duct panel rivets or mechanical fasteners. The bottom of the mount has locator tabs that fit into the duct mounting holes, preventing the mount from spinning during installation.

Features and Benefits

- Tabs align the mount for easy divider installation.
- Top of the mount creates separation between wires and the fastener head which protects the wires from abrasion.
- When used as a duct divider mount, the divider snaps or slides over the mount resulting in a quick, secure installation.
- When used as a wire bundle mount, simply slide the cable tie through any of the four-way tie slots to secure the bundle and prevent the cables from falling outside the duct during installation and cover removal.

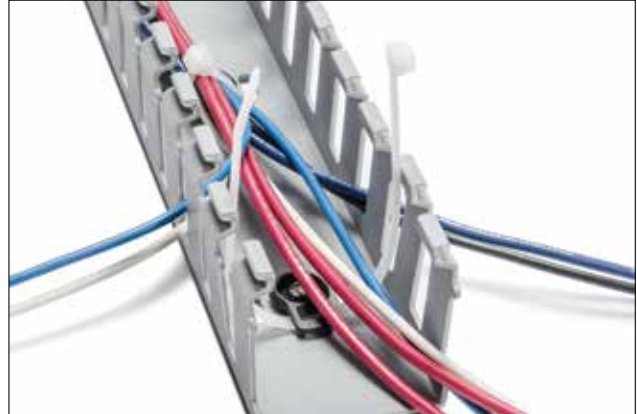

MATERIAL	Polyamide 6.6 V0 (PA66V0)
Flammability	UL 94 V0
Operating Temperature	-40°F to +230°F (-40°C to +110°C)



PART NO.	TYPE	Color	Pkg. Qty.
181-00684	DVM	Black	100

Dimensions are approximate and subject to technical changes. Use Part No. for ordering and Type for specification purposes.

Duct Tools and Accessories

Solid Wall Wire Retainers

Wire Retainers are inserted in the duct and snap into place. The retainer can be used on any smooth, straight run of duct and can work with vertical and overhead applications. Solid wall wire retainers are manufactured from black PVC.

Features and Benefits

- Effectively retains wires in duct when covers are removed.

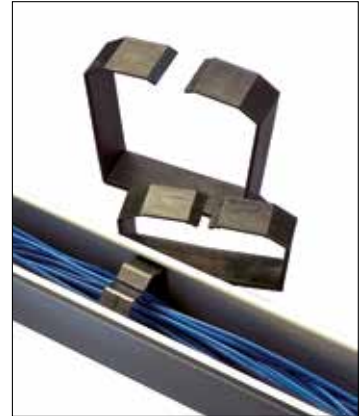

MATERIAL	Polyvinylchloride (PVC)
Flammability	UL 94 HB
Operating Temperature	+23°F to +185°F (-5°C to +85°C)



PART NO.	TYPE	Description	Color	Pkg. Qty.
SDWR4X40P2	SDWR4X40	Wire Retainer, Solid Style for 4" x 4" Duct	Black	10
SDWR2X20K2	SDWR2X20	Wire Retainer, Solid Style for 2" x 2" Duct	Black	50

Dimensions are approximate and subject to technical changes. Use Part No. for ordering and Type for specification purposes.

Duct Tools and Accessories

Slotted Wall Wire Retainers

Slotted wall wire retainers snap in from the outside of the duct, allowing for fast and easy installation and removal. Slotted wall wire retainers are manufactured from black nylon 6/6.

Features and Benefits

- Retainer spans approximately 90% over the duct opening for effective wire management.



MATERIAL	Polyamide 6 (PA6)
Flammability	UL 94 HB
Operating Temperature	+23°F to +185°F (-5°C to +85°C)



PART NO.	TYPE	Description	Color	Pkg. Qty.
SLWR40C2	SLWR40	Wire Retainer, Slotted Style for 4" Duct	Black	100
SLWR30C2	SLWR30	Wire Retainer, Slotted Style for 3" Duct	Black	100
SLWR20C2	SLWR20	Wire Retainer, Slotted Style for 2" Duct	Black	100

Dimensions are approximate and subject to technical changes. Use Part No. for ordering and Type for specification purposes.

Routing, Protection and Insulation

Wiring Duct

Duct Tools and Accessories

Bench Mounted Wiring Duct Cutting Tool

The HellermannTyton bench mounted wiring duct cutting tool is used to accurately measure and cut all HellermannTyton slotted and high density slotted wiring duct, solid dividers and covers.

Features and Benefits

- Hand lever is ergonomically designed to reduce user fatigue.
- Measuring guide incorporates both imperial and metric values which eliminates the need for secondary measurement devices.
- Long lasting, hardened blade produces burr-free edges and improves productivity by eliminating the need for filing the edges after cutting.
- Includes replacement blade and safety guide to ensure longevity, safety and proper use of the tool (replacements for both can also be purchased separately).



PART NO.	TYPE	Pkg. Qty.
904-00295	Wiring Duct Cutting Tool	1
904-00296	Wiring Duct Cutting Tool Replacement Blade	1
904-00297	Wiring Duct Safety Guide	1

Dimensions are approximate and subject to technical changes. Use Part No. for ordering and Type for specification purposes.

Duct Tools and Accessories

Duct Notching Tool

HellermannTyton's duct notching tool is designed for use with HellermannTyton's slotted wall and slotted high density Pro-Duct wiring duct. This hand held tool features plastic grips for easy handling and allows users to notch a duct sidewall section down to the very base for finger and sidewall removal.

Features and Benefits

- Plastic grips for easy tool handling.



PART NO.	TYPE	Description	Color	Pkg. Qty.
TDNT	TDNT	Wiring Duct Notching Tool	Red	1

Dimensions are approximate and subject to technical changes. Use Part No. for ordering and Type for specification purposes.

Duct Tools and Accessories

Panel Rivets and Tools

HellermannTyton panel rivets are one piece drive rivets that provide a fast, economic means of affixing wiring duct. The rivet is inserted into a 3/16" pre-punched hole and the pin is driven into the base, thereby expanding the rivet legs and locking the duct and sub-panel in place. The panel thickness (including the duct thickness) should be a maximum of 3/16". A panel rivet tool is also available for quick and easy installation of the drive rivets.

Features and Benefits

- Panel rivets are made with nylon material to hold duct securely to the panel without corroding, ensuring longevity.
- Panel rivets can be easily inserted with use of a specially designed, long shafted panel rivet tool.
- Ergonomic design of the tool ensures effortless use when inserting rivets into deep channels or locations difficult to access.



MATERIAL	Polyamide 6.6 (PA66)
Flammability	UL 94 HB
Operating Temperature	-40°F to +176°F (-40°C to +80°C)



PART NO.	TYPE	Description	Color	Pkg. Qty.
PR1M4	PR1	Panel Rivets	Natural	1000
PRT1	PRT1	Panel Rivet Tool	Yellow	1

Dimensions are approximate and subject to technical changes. Use Part No. for ordering and Type for specification purposes.

Duct Tools and Accessories

Corner Strips and Straight Connectors

HellermannTyton's Wiring Duct Connectors include corner strips and straight connectors. Corner strips are used for a rounded and smoother transition between sections of wiring duct meeting at a right angle whereas straight connectors join straight duct runs to cover and protect wires. Straight connectors are supplied in 6 foot lengths, can be used with all sizes of duct, and can be cut to fit duct sidewall heights.

Features and Benefits

- Easily cut to size for the appropriate duct size.
- Provides a smooth transition between sections of duct.



MATERIAL	Polyvinylchloride (PVC)
Flammability	Self-Extinguishing
Operating Temperature	+122°F (+50°C)



PART NO.	TYPE	Description	Color	Pkg. Qty.
181-00001	CSG	Wiring Duct Corner Strip Connector	Gray	120 ft
181-00002	CSW	Wiring Duct Corner Strip Connector	White	120 ft
181-00003	SCG	Wiring Duct Straight Connector	Gray	120 ft
181-00004	SCW	Wiring Duct Straight Connector	White	120 ft

Dimensions are approximate and subject to technical changes. Use Part No. for ordering and Type for specification purposes.

Low Voltage Raceway Channels

One Piece Surface Raceway

HellermannTyton surface raceway systems are the ideal solution for routing communication and power cables. No need to break into existing walls - raceway systems are designed to route cable along wall surfaces. Made of a PVC material, components are durable and affordable; and the one-piece construction and adhesive tape backing make positioning and mounting easy. HellermannTyton offers a low voltage TSR system and a power rated TSRP system that are available in three different diameters to accommodate different cable and wire bundle and conduit sizes. Both systems include a complete line of fittings and junction boxes that allow for clean and professional installations.



Features and Benefits

- Tamper resistant covers with hidden latch provide security while allowing quick entry for cable maintenance.
- PVC construction is lightweight, durable and more affordable than metallic raceway systems.
- Flexible hinge is designed to reduce stress cracking and discoloration from repeated opening and closing.
- Foam tape backing with rubber based adhesive conforms to any flat surface to assist with temporary positioning and mounting.
- Systems and fittings are available in white, office white and ivory to coordinate with a variety of décor.
- Fittings incorporate a minimum 1" bend radius to meet TIA/EIA 568-B and 569-A standards.

MATERIAL	Polyvinylchloride (PVC)
Flammability	UL 94 V0
Operating Temperature	+122°F (+50°C)

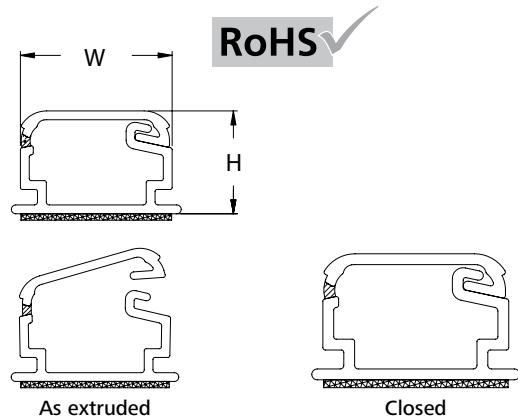

PART NO.	TYPE	Color	Description	Length (L) ft. (m)	Width (W) in. (mm)	Height (H) in. (mm)	Pkg. Qty.
TSR11-8A	TSR1-8A	Ivory	3/4" One Piece Surface Raceway	8.0 (2.4)	0.8 (19.1)	0.5 (12.7)	160 ft
TSR1FW-8A		Office White	3/4" One Piece Surface Raceway	8.0 (2.4)	0.8 (19.1)	0.5 (12.7)	160 ft
TSR1W-8A		White	3/4" One Piece Surface Raceway	8.0 (2.4)	0.8 (19.1)	0.5 (12.7)	160 ft
TSR11-6A	TSR1-6A	Ivory	3/4" One Piece Surface Raceway	6.0 (1.8)	0.8 (19.1)	0.5 (12.7)	120 ft
TSR1FW-6A		Office White	3/4" One Piece Surface Raceway	6.0 (1.8)	0.8 (19.1)	0.5 (12.7)	120 ft
TSR1W-6A		White	3/4" One Piece Surface Raceway	6.0 (1.8)	0.8 (19.1)	0.5 (12.7)	120 ft
TSR21-8A	TSR2-8A	Ivory	1-1/4" One Piece Surface Raceway	8.0 (2.4)	1.3 (31.8)	0.8 (19.1)	160 ft
TSR2FW-8A		Office White	1-1/4" One Piece Surface Raceway	8.0 (2.4)	1.3 (31.8)	0.8 (19.1)	160 ft
TSR2W-8A		White	1-1/4" One Piece Surface Raceway	8.0 (2.4)	1.3 (31.8)	0.8 (19.1)	160 ft

Dimensions are approximate and subject to technical changes. Use Part No. for ordering and Type for specification purposes. For wire fill capacities, see appendix.

Routing, Protection and Insulation

Surface Raceway

Low Voltage Raceway Channels

One Piece Surface Raceway

PART NO.	TYPE	Color	Description	Length (L) ft. (m)	Width (W) in. (mm)	Height (H) in. (mm)	Pkg. Qty.
TSR2I-6A	TSR2-6A	Ivory	1-1/4" One Piece Surface Raceway	6.0 (1.8)	1.3 (31.8)	0.8 (19.1)	120 ft
TSR2FW-6A		Office White	1-1/4" One Piece Surface Raceway	6.0 (1.8)	1.3 (31.8)	0.8 (19.1)	120 ft
TSR2W-6A		White	1-1/4" One Piece Surface Raceway	6.0 (1.8)	1.3 (31.8)	0.8 (19.1)	120 ft
TSR3I-8A	TSR3-8A	Ivory	1-3/4" One Piece Surface Raceway	8.0 (2.4)	1.8 (44.5)	1.0 (25.4)	160 ft
TSR3FW-8A		Office White	1-3/4" One Piece Surface Raceway	8.0 (2.4)	1.8 (44.5)	1.0 (25.4)	160 ft
TSR3W-8A		White	1-3/4" One Piece Surface Raceway	8.0 (2.4)	1.8 (44.5)	1.0 (25.4)	160 ft
TSR3I-6A	TSR3-6A	Ivory	1-3/4" One Piece Surface Raceway	6.0 (1.8)	1.8 (44.5)	1.0 (25.4)	120 ft
TSR3FW-6A		Office White	1-3/4" One Piece Surface Raceway	6.0 (1.8)	1.8 (44.5)	1.0 (25.4)	120 ft
TSR3W-6A		White	1-3/4" One Piece Surface Raceway	6.0 (1.8)	1.8 (44.5)	1.0 (25.4)	120 ft

Dimensions are approximate and subject to technical changes. Use Part No. for ordering and Type for specification purposes. For wire fill capacities, see appendix.

Low Voltage Raceway Fittings and Junction Boxes

Ceiling Drops

HellermannTyton surface raceway systems are the ideal solution for routing communication and power cables. No need to break into existing walls - raceway systems are designed to route cable along wall surfaces. Made of a PVC material, components are durable and affordable; and the one-piece construction and adhesive tape backing make positioning and mounting easy. HellermannTyton offers a low voltage TSR system and a power rated TSRP system that are available in three different diameters to accommodate different cable and wire bundle and conduit sizes. Both systems include a complete line of fittings and junction boxes that allow for clean and professional installations. TSR surface raceway systems can be used to route a variety of communication cable, including high speed UTP and fiber optic cable.

Features and Benefits

- Tamper resistant covers with hidden latch provide security while allowing quick entry for cable maintenance.
- PVC construction is lightweight, durable and more affordable than metallic raceway systems.
- Flexible hinge is designed to reduce stress cracking and discoloration from repeated opening and closing.
- Systems and fittings are available in white, office white and ivory to coordinate with a variety of décor.
- Fittings incorporate a minimum 1" bend radius to meet TIA/EIA 568-B and 569-A standards.



MATERIAL	Polyvinylchloride (PVC)
Flammability	UL 94 V0
Operating Temperature	+122°F (+50°C)

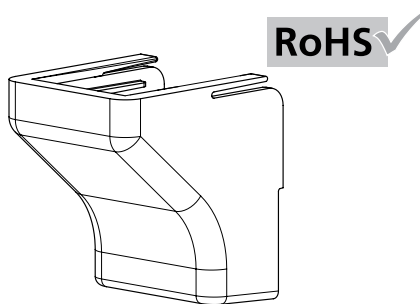

PART NO.	TYPE	Description	Color	Pkg. Qty.
TSR1I-50	TSR1-50	Ceiling Drop, 3/4"	Ivory	1
TSR1FW-50		Ceiling Drop, 3/4"	Office White	1
TSR1W-50		Ceiling Drop, 3/4"	White	1
TSR2I-50	TSR2-50	Ceiling Drop, 1-1/4"	Ivory	1
TSR2FW-50		Ceiling Drop, 1-1/4"	Office White	1
TSR2W-50		Ceiling Drop, 1-1/4"	White	1
TSR3I-50	TSR3-50	Ceiling Drop, 1-3/4"	Ivory	1
TSR3FW-50		Ceiling Drop, 1-3/4"	Office White	1
TSR3W-50		Ceiling Drop, 1-3/4"	White	1

Dimensions are approximate and subject to technical changes. Use Part No. for ordering and Type for specification purposes.

Routing, Protection and Insulation

Surface Raceway

Low Voltage Raceway Fittings and Junction Boxes

End Caps

HellermannTyton surface raceway systems are the ideal solution for routing communication and power cables. No need to break into existing walls - raceway systems are designed to route cable along wall surfaces. Made of a PVC material, components are durable and affordable; and the one-piece construction and adhesive tape backing make positioning and mounting easy. HellermannTyton offers a low voltage TSR system and a power rated TSRP system that are available in three different diameters to accommodate different cable and wire bundle and conduit sizes. Both systems include a complete line of fittings and junction boxes that allow for clean and professional installations. TSR surface raceway systems can be used to route a variety of communication cable, including high speed UTP and fiber optic cable.

Features and Benefits

- Tamper resistant covers with hidden latch provide security while allowing quick entry for cable maintenance.
- PVC construction is lightweight, durable and more affordable than metallic raceway systems.
- Flexible hinge is designed to reduce stress cracking and discoloration from repeated opening and closing.
- Systems and fittings are available in white, office white and ivory to coordinate with a variety of décor.
- Fittings incorporate a minimum 1" bend radius to meet TIA/EIA 568-B and 569-A standards.



MATERIAL	Polyvinylchloride (PVC)
Flammability	UL 94 V0
Operating Temperature	+122°F (+50°C)

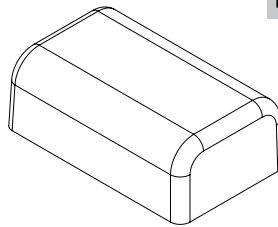

PART NO.	TYPE	Description	Color	Pkg. Qty.
TSR1I-36	TSR1-36	End Cap, 3/4"	Ivory	1
TSR1FW-36		End Cap, 3/4"	Office White	1
TSR1W-36		End Cap, 3/4"	White	1
TSR2I-36	TSR2-36	End Cap, 1-1/4"	Ivory	1
TSR2FW-36		End Cap, 1-1/4"	Office White	1
TSR2W-36		End Cap, 1-1/4"	White	1
TSR3I-36	TSR3-36	End Cap, 1-3/4"	Ivory	1
TSR3FW-36		End Cap, 1-3/4"	Office White	1
TSR3W-36		End Cap, 1-3/4"	White	1

Dimensions are approximate and subject to technical changes. Use Part No. for ordering and Type for specification purposes.

Low Voltage Raceway Fittings and Junction Boxes

Internal Corner Covers

HellermannTyton surface raceway systems are the ideal solution for routing communication and power cables. No need to break into existing walls - raceway systems are designed to route cable along wall surfaces. Made of a PVC material, components are durable and affordable; and the one-piece construction and adhesive tape backing make positioning and mounting easy. HellermannTyton offers a low voltage TSR system and a power rated TSRP system that are available in three different diameters to accommodate different cable and wire bundle and conduit sizes. Both systems include a complete line of fittings and junction boxes that allow for clean and professional installations. TSR surface raceway systems can be used to route a variety of communication cable, including high speed UTP and fiber optic cable.

Features and Benefits

- Tamper resistant covers with hidden latch provide security while allowing quick entry for cable maintenance.
- PVC construction is lightweight, durable and more affordable than metallic raceway systems.
- Flexible hinge is designed to reduce stress cracking and discoloration from repeated opening and closing.
- Systems and fittings are available in white, office white and ivory to coordinate with a variety of décor.
- Fittings incorporate a minimum 1" bend radius to meet TIA/EIA 568-B and 569-A standards.



MATERIAL	Polyvinylchloride (PVC)
Flammability	UL 94 V0
Operating Temperature	+122°F (+50°C)

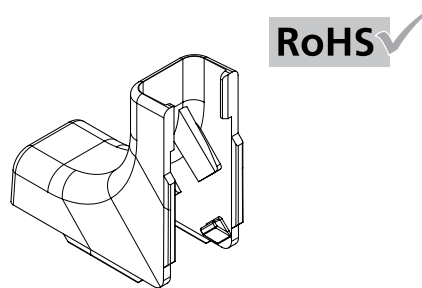

PART NO.	TYPE	Description	Color	Pkg. Qty.
TSR1I-33-1	TSR1-33-1	Internal Corner Cover, 3/4", 1" Bend Radius	Ivory	1
TSR1FW-33-1		Internal Corner Cover, 3/4", 1" Bend Radius	Office White	1
TSR1W-33-1		Internal Corner Cover, 3/4", 1" Bend Radius	White	1
TSR2I-33-1	TSR2-33-1	Internal Corner Cover, 1-1/4", 1" Bend Radius	Ivory	1
TSR2FW-33-1		Internal Corner Cover, 1-1/4", 1" Bend Radius	Office White	1
TSR2W-33-1		Internal Corner Cover, 1-1/4", 1" Bend Radius	White	1
TSR3I-33-1	TSR3-33-1	Internal Corner Cover, 1-3/4", 1" Bend Radius	Ivory	1
TSR3FW-33-1		Internal Corner Cover, 1-3/4", 1" Bend Radius	Office White	1
TSR3W-33-1		Internal Corner Cover, 1-3/4", 1" Bend Radius	White	1

Dimensions are approximate and subject to technical changes. Use Part No. for ordering and Type for specification purposes.

Routing, Protection and Insulation

Surface Raceway

Low Voltage Raceway Fittings and Junction Boxes

External Corner Covers

HellermannTyton surface raceway systems are the ideal solution for routing communication and power cables. No need to break into existing walls - raceway systems are designed to route cable along wall surfaces. Made of a PVC material, components are durable and affordable; and the one-piece construction and adhesive tape backing make positioning and mounting easy. HellermannTyton offers a low voltage TSR system and a power rated TSRP system that are available in three different diameters to accommodate different cable and wire bundle and conduit sizes. Both systems include a complete line of fittings and junction boxes that allow for clean and professional installations. TSR surface raceway systems can be used to route a variety of communication cable, including high speed UTP and fiber optic cable.

Features and Benefits

- Tamper resistant covers with hidden latch provide security while allowing quick entry for cable maintenance.
- PVC construction is lightweight, durable and more affordable than metallic raceway systems.
- Flexible hinge is designed to reduce stress cracking and discoloration from repeated opening and closing.
- Systems and fittings are available in white, office white and ivory to coordinate with a variety of décor.
- Fittings incorporate a minimum 1" bend radius to meet TIA/EIA 568-B and 569-A standards.



MATERIAL	Polyvinylchloride (PVC)
Flammability	UL 94 V0
Operating Temperature	+122°F (+50°C)

RoHS ✓

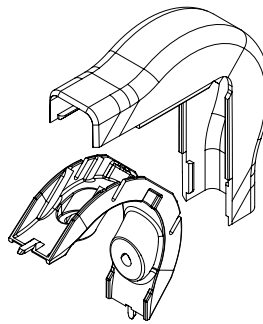

PART NO.	TYPE	Description	Color	Pkg. Qty.
TSR1I-29-1	TSR1-29-1	External Corner Cover, 3/4", 1" Bend Radius	Ivory	1
TSR1FW-29-1		External Corner Cover, 3/4", 1" Bend Radius	Office White	1
TSR1W-29-1		External Corner Cover, 3/4", 1" Bend Radius	White	1
TSR2I-29-1	TSR2-29-1	External Corner Cover, 1-1/4", 1" Bend Radius	Ivory	1
TSR2FW-29-1		External Corner Cover, 1-1/4", 1" Bend Radius	Office White	1
TSR2W-29-1		External Corner Cover, 1-1/4", 1" Bend Radius	White	1
TSR3I-29-1	TSR3-29-1	External Corner Cover, 1-3/4", 1" Bend Radius	Ivory	1
TSR3FW-29-1		External Corner Cover, 1-3/4", 1" Bend Radius	Office White	1
TSR3W-29-1		External Corner Cover, 1-3/4", 1" Bend Radius	White	1

Dimensions are approximate and subject to technical changes. Use Part No. for ordering and Type for specification purposes.

Low Voltage Raceway Fittings and Junction Boxes

Elbow Covers

HellermannTyton surface raceway systems are the ideal solution for routing communication and power cables. No need to break into existing walls - raceway systems are designed to route cable along wall surfaces. Made of a PVC material, components are durable and affordable; and the one-piece construction and adhesive tape backing make positioning and mounting easy. HellermannTyton offers a low voltage TSR system and a power rated TSRP system that are available in three different diameters to accommodate different cable and wire bundle and conduit sizes. Both systems include a complete line of fittings and junction boxes that allow for clean and professional installations. TSR surface raceway systems can be used to route a variety of communication cable, including high speed UTP and fiber optic cable.

Features and Benefits

- Tamper resistant covers with hidden latch provide security while allowing quick entry for cable maintenance.
- PVC construction is lightweight, durable and more affordable than metallic raceway systems.
- Flexible hinge is designed to reduce stress cracking and discoloration from repeated opening and closing.
- Systems and fittings are available in white, office white and ivory to coordinate with a variety of décor.
- Fittings incorporate a minimum 1" bend radius to meet TIA/EIA 568-B and 569-A standards.



MATERIAL	Polyvinylchloride (PVC)
Flammability	UL 94 V0
Operating Temperature	+122°F (+50°C)

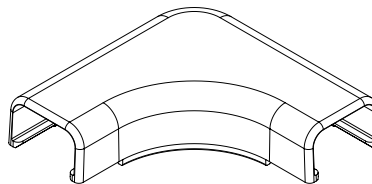

PART NO.	TYPE	Description	Color	Pkg. Qty.
TSR1I-25-1	TSR1-25-1	Elbow Cover, 3/4", 1" Bend Radius	Ivory	1
TSR1FW-25-1		Elbow Cover, 3/4", 1" Bend Radius	Office White	1
TSR1W-25-1		Elbow Cover, 3/4", 1" Bend Radius	White	1
TSR2I-25-1	TSR2-25-1	Elbow Cover, 1-1/4", 1" Bend Radius	Ivory	1
TSR2FW-25-1		Elbow Cover, 1-1/4", 1" Bend Radius	Office White	1
TSR2W-25-1		Elbow Cover, 1-1/4", 1" Bend Radius	White	1
TSR3I-25-1	TSR3-25-1	Elbow Cover, 1-3/4", 1" Bend Radius	Ivory	1
TSR3FW-25-1		Elbow Cover, 1-3/4", 1" Bend Radius	Office White	1
TSR3W-25-1		Elbow Cover, 1-3/4", 1" Bend Radius	White	1

Dimensions are approximate and subject to technical changes. Use Part No. for ordering and Type for specification purposes.

Routing, Protection and Insulation

Surface Raceway

Low Voltage Raceway Fittings and Junction Boxes

Tee Covers

HellermannTyton surface raceway systems are the ideal solution for routing communication and power cables. No need to break into existing walls - raceway systems are designed to route cable along wall surfaces. Made of a PVC material, components are durable and affordable; and the one-piece construction and adhesive tape backing make positioning and mounting easy. HellermannTyton offers a low voltage TSR system and a power rated TSRP system that are available in three different diameters to accommodate different cable and wire bundle and conduit sizes. Both systems include a complete line of fittings and junction boxes that allow for clean and professional installations. TSR surface raceway systems can be used to route a variety of communication cable, including high speed UTP and fiber optic cable.

Features and Benefits

- Tamper resistant covers with hidden latch provide security while allowing quick entry for cable maintenance.
- PVC construction is lightweight, durable and more affordable than metallic raceway systems.
- Flexible hinge is designed to reduce stress cracking and discoloration from repeated opening and closing.
- Systems and fittings are available in white, office white and ivory to coordinate with a variety of décor.
- Fittings incorporate a minimum 1" bend radius to meet TIA/EIA 568-B and 569-A standards.



MATERIAL	Polyvinylchloride (PVC)
Flammability	UL 94 V0
Operating Temperature	+122°F (+50°C)

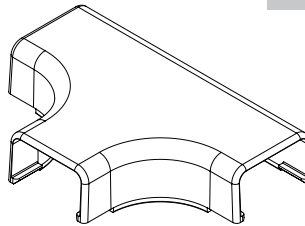

PART NO.	TYPE	Description	Color	Pkg. Qty.
TSR1I-21-1	TSR1-21-1	Tee Cover, 3/4", 1" Bend Radius	Ivory	1
TSR1FW-21-1		Tee Cover, 3/4", 1" Bend Radius	Office White	1
TSR1W-21-1		Tee Cover, 3/4", 1" Bend Radius	White	1
TSR2I-21-1	TSR2-21-1	Tee Cover, 1-1/4", 1" Bend Radius	Ivory	1
TSR2FW-21-1		Tee Cover, 1-1/4", 1" Bend Radius	Office White	1
TSR2W-21-1		Tee Cover, 1-1/4", 1" Bend Radius	White	1
TSR3I-21-1	TSR3-21-1	Tee Cover, 1-3/4", 1" Bend Radius	Ivory	1
TSR3FW-21-1		Tee Cover, 1-3/4", 1" Bend Radius	Office White	1
TSR3W-21-1		Tee Cover, 1-3/4", 1" Bend Radius	White	1

Dimensions are approximate and subject to technical changes. Use Part No. for ordering and Type for specification purposes.

Low Voltage Raceway Fittings and Junction Boxes

Splice Covers

HellermannTyton surface raceway systems are the ideal solution for routing communication and power cables. No need to break into existing walls - raceway systems are designed to route cable along wall surfaces. Made of a PVC material, components are durable and affordable; and the one-piece construction and adhesive tape backing make positioning and mounting easy. HellermannTyton offers a low voltage TSR system and a power rated TSRP system that are available in three different diameters to accommodate different cable and wire bundle and conduit sizes. Both systems include a complete line of fittings and junction boxes that allow for clean and professional installations. TSR surface raceway systems can be used to route a variety of communication cable, including high speed UTP and fiber optic cable.

Features and Benefits

- Tamper resistant covers with hidden latch provide security while allowing quick entry for cable maintenance.
- PVC construction is lightweight, durable and more affordable than metallic raceway systems.
- Flexible hinge is designed to reduce stress cracking and discoloration from repeated opening and closing.
- Systems and fittings are available in white, office white and ivory to coordinate with a variety of décor.
- Fittings incorporate a minimum 1" bend radius to meet TIA/EIA 568-B and 569-A standards.



MATERIAL	Polyvinylchloride (PVC)
Flammability	UL 94 V0
Operating Temperature	+122°F (+50°C)

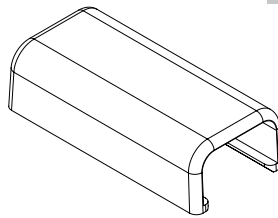

PART NO.	TYPE	Description	Color	Pkg. Qty.
TSR1I-14	TSR1-14	Splice Cover, 3/4"	Ivory	1
TSR1FW-14		Splice Cover, 3/4"	Office White	1
TSR1W-14		Splice Cover, 3/4"	White	1
TSR2I-14	TSR2-14	Splice Cover, 1-1/4"	Ivory	1
TSR2FW-14		Splice Cover, 1-1/4"	Office White	1
TSR2W-14		Splice Cover, 1-1/4"	White	1
TSR3I-14	TSR3-14	Splice Cover, 1-3/4"	Ivory	1
TSR3FW-14		Splice Cover, 1-3/4"	Office White	1
TSR3W-14		Splice Cover, 1-3/4"	White	1

Dimensions are approximate and subject to technical changes. Use Part No. for ordering and Type for specification purposes.

Routing, Protection and Insulation

Surface Raceway

Low Voltage Raceway Fittings and Junction Boxes

Reducers

HellermannTyton surface raceway systems are the ideal solution for routing communication and power cables. No need to break into existing walls - raceway systems are designed to route cable along wall surfaces. Made of a PVC material, components are durable and affordable; and the one-piece construction and adhesive tape backing make positioning and mounting easy. HellermannTyton offers a low voltage TSR system and a power rated TSRP system that are available in three different diameters to accommodate different cable and wire bundle and conduit sizes. Both systems include a complete line of fittings and junction boxes that allow for clean and professional installations. TSR surface raceway systems can be used to route a variety of communication cable, including high speed UTP and fiber optic cable.

Features and Benefits

- Tamper resistant covers with hidden latch provide security while allowing quick entry for cable maintenance.
- PVC construction is lightweight, durable and more affordable than metallic raceway systems.
- Flexible hinge is designed to reduce stress cracking and discoloration from repeated opening and closing.
- Systems and fittings are available in white, office white and ivory to coordinate with a variety of décor.
- Fittings incorporate a minimum 1" bend radius to meet TIA/EIA 568-B and 569-A standards.



MATERIAL	Polyvinylchloride (PVC)
Flammability	UL 94 V0
Operating Temperature	+122°F (+50°C)

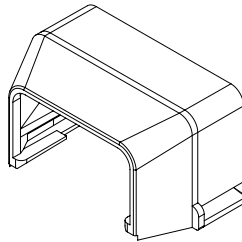

PART NO.	TYPE	Description	Color	Pkg. Qty.
TSR1I-12	TSR1-12	Reducer, 1-3/4" to 1-1/4" (TSR3 to TSR2)	Ivory	1
TSR1FW-12		Reducer, 1-3/4" to 1-1/4" (TSR3 to TSR2)	Office White	1
TSR1W-12		Reducer, 1-3/4" to 1-1/4" (TSR3 to TSR2)	White	1
TSR2I-12	TSR2-12	Reducer, 1-3/4" to 3/4" (TSR3 to TSR1)	Ivory	1
TSR2FW-12		Reducer, 1-3/4" to 3/4" (TSR3 to TSR1)	Office White	1
TSR2W-12		Reducer, 1-3/4" to 3/4" (TSR3 to TSR1)	White	1
TSR3I-12	TSR3-12	Reducer 1-1/4" to 3/4" (TSR2 to TSR1)	Ivory	1
TSR3FW-12		Reducer 1-1/4" to 3/4" (TSR2 to TSR1)	Office White	1
TSR3W-12		Reducer 1-1/4" to 3/4" (TSR2 to TSR1)	White	1

Dimensions are approximate and subject to technical changes. Use Part No. for ordering and Type for specification purposes.

Low Voltage Raceway Fittings and Junction Boxes

Single Gang Junction Boxes

Offered in dual or single gang format, HellermannTyton's Low Voltage Junction Boxes are versatile enough for any network cabling application. Available in varying depths, these boxes are all equipped with concentric knockouts on all four sides for every TSR size of raceway to eliminate routing and installation inconvenience. All junction boxes come with adhesive strips on the back of the base and #6 screws to secure the box to the base.

Features and Benefits

- Rubber based foam tape adhesive with high ultimate bond strength conforms to any surface.

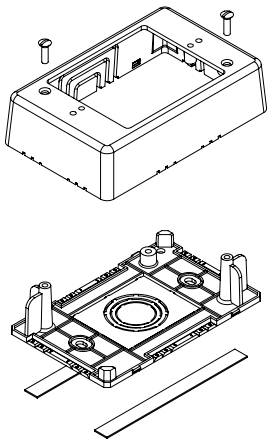

MATERIAL	Polyvinylchloride (PVC)
Flammability	UL 94 V0
Operating Temperature	+122°F (+50°C)



PART NO.	TYPE	Description	Width (W) in. (mm)	Height (H) in. (mm)	Length (L) ft. (m)	Color	Pkg. Qty.
TSRI-JB1	TSR-JB1	Single Gang Junction Box	3.0 (76.2)	1.3 (31.8)	4.8 (120.7)	Ivory	1
TSRFW-JB1		Single Gang Junction Box	3.0 (76.2)	1.3 (31.8)	4.8 (120.7)	Office White	1
TSRW-JB1		Single Gang Junction Box	3.0 (76.2)	1.3 (31.8)	4.8 (120.7)	White	1
TSRI-JB2	TSR-JB2	Single Gang Junction Box	3.0 (76.2)	2.0 (50.8)	4.8 (120.7)	Ivory	1
TSRFW-JB2		Single Gang Junction Box	3.0 (76.2)	2.0 (50.8)	4.8 (120.7)	Office White	1
TSRW-JB2		Single Gang Junction Box	3.0 (76.2)	2.0 (50.8)	4.8 (120.7)	White	1
TSRI-JB3	TSR-JB3	Single Gang Junction Box	3.2 (81.3)	2.8 (70.4)	5.0 (125.7)	Ivory	1
TSRFW-JB3		Single Gang Junction Box	3.2 (81.3)	2.8 (70.4)	5.0 (125.7)	Office White	1
TSRW-JB3		Single Gang Junction Box	3.2 (81.3)	2.8 (70.4)	5.0 (125.7)	White	1

Dimensions are approximate and subject to technical changes. Use Part No. for ordering and Type for specification purposes.
TSRX-JB2, TSRXJB3 and TSRX-JB2 are recommended for voice and data applications.

Routing, Protection and Insulation

Surface Raceway

Low Voltage Raceway Fittings and Junction Boxes

Dual Gang Junction Boxes

Offered in dual or single gang format, HellermannTyton's Low Voltage Junction Boxes are versatile enough for any network cabling application. Available in varying depths, these boxes are all equipped with concentric knockouts on all four sides for every TSR size of raceway to eliminate routing and installation inconvenience. All junction boxes come with adhesive strips on the back of the base and #6 screws to secure the box to the base.

Features and Benefits

- Rubber based foam tape adhesive with high ultimate bond strength conforms to any surface.

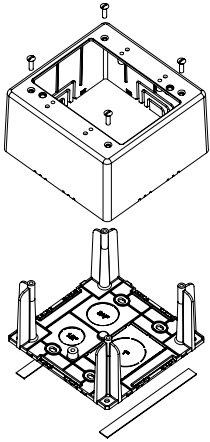

MATERIAL	Polyvinylchloride (PVC)
Flammability	UL 94 V0
Operating Temperature	+122°F (+50°C)



PART NO.	Type	Description	Width (W) in. (mm)	Height (H) in. (mm)	Length (L) in. (mm)	Color	Qty. per Pkg.
TSRI-JBD	TSR-JBD	Dual Gang Junction Box	4.9 (124.7)	1.5 (38.1)	4.8 (122.7)	Ivory	1
TSRFW-JBD	TSR-JBD	Dual Gang Junction Box	4.9 (124.7)	1.5 (38.1)	4.8 (122.7)	Office White	1
TSRW-JBD	TSR-JBD	Dual Gang Junction Box	4.9 (124.7)	1.5 (38.1)	4.8 (122.7)	White	1
TSRI-JBD2	TSR-JBD2	Dual Gang Junction Box	5.0 (127.5)	2.8 (70.4)	4.9 (125.5)	Ivory	1
TSRFW-JBD2	TSR-JBD2	Dual Gang Junction Box	5.0 (127.5)	2.8 (70.4)	4.9 (125.5)	Office White	1
TSRW-JBD2	TSR-JBD2	Dual Gang Junction Box	5.0 (127.5)	2.8 (70.4)	4.9 (125.5)	White	1

Dimensions are approximate and subject to technical changes. Use Part No. for ordering and Type for specification purposes.

Power Rated Raceway Channels

TSRP - Power Rated Surface Raceway

HellermannTyton's TSRP power surface raceway is a one piece, non-metallic, adhesive backed latching raceway designed to aesthetically organize and route either power or communications cables. Completely tamper resistant, the cover's self-locking, hidden positive latch permits quick reentry as well as providing a secure installation of power cables.

Features and Benefits

- Completely tamper resistant, the cover's self-locking, hidden positive latch permits quick re-entry as well as providing a secure installation of power cables.
- U.L. Listed for power up to 600 Volts, meeting UL5A and CSA 22.2 Number 62-93 Standards.
- Manufactured from UL 94V-0 rated PVC material.
- Fittings incorporate a minimum 1" bend radius per TIA/EIA 568-B and 569-A standards.
- Large base for greater adhesive surface.
- Rubber-based foam tape adhesive with high ultimate bond strength, which conforms to any surface.
- Flexible hinge allows the raceway to endure numerous openings without creating discoloration or stress cracking.
- Junction boxes can be used for electrical or data outlets.
- Designed to complement HellermannTyton's industry standard TSR low voltage raceway system.



MATERIAL	Polyvinylchloride (PVC)
Flammability	UL 94 V0
Operating Temperature	+122°F (+50°C)

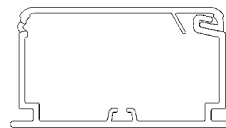

PART NO.	TYPE	Description	Width (W) in. (mm)	Height (H) in. (mm)	Length (L) in. (mm)	Color	Pkg. Qty.
TSRP1I-6A*	TSRP1-6A	3/4" One Piece Surface Raceway	0.75 (19.1)	0.5 (12.7)	6.0 ft (1.8)	Ivory	120 ft
TSRP1FW-6A*		3/4" One Piece Surface Raceway	0.75 (19.1)	0.5 (12.7)	6.0 ft (1.8)	Office White	120 ft
TSRP1W-6A*		3/4" One Piece Surface Raceway	0.75 (19.1)	0.5 (12.7)	6.0 ft (1.8)	White	120 ft
TSRP1I-8A*	TSRP1-8A	3/4" One Piece Surface Raceway	0.75 (19.1)	0.5 (12.7)	8.0 ft (2.4)	Ivory	160 ft
TSRP1FW-8A*		3/4" One Piece Surface Raceway	0.75 (19.1)	0.5 (12.7)	8.0 ft (2.4)	Office White	160 ft
TSRP1W-8A*		3/4" One Piece Surface Raceway	0.75 (19.1)	0.5 (12.7)	8.0 ft (2.4)	White	160 ft
TSRP2I-6A*	TSRP2-6A	1-1/4" One Piece Surface Raceway	1.25 (31.8)	0.8 (19.1)	6.0 ft (1.8)	Ivory	120 ft
TSRP2FW-6A*		1-1/4" One Piece Surface Raceway	1.25 (31.8)	0.8 (19.1)	6.0 ft (1.8)	Office White	120 ft
TSRP2W-6A*		1-1/4" One Piece Surface Raceway	1.25 (31.8)	0.8 (19.1)	6.0 ft (1.8)	White	120 ft
TSRP2I-8A*	TSRP2-8A	1-1/4" One Piece Surface Raceway	1.25 (31.8)	0.8 (19.1)	8.0 ft (2.4)	Ivory	160 ft
TSRP2FW-8A*		1-1/4" One Piece Surface Raceway	1.25 (31.8)	0.8 (19.1)	8.0 ft (2.4)	Office White	160 ft
TSRP2W-8A*		1-1/4" One Piece Surface Raceway	1.25 (31.8)	0.8 (19.1)	8.0 ft (2.4)	White	160 ft
TSRP3I-6A*	TSRP3-6A	1-3/4" One Piece Surface Raceway	1.75 (44.5)	1.0 (25.4)	6.0 ft (1.8)	Ivory	120 ft
TSRP3FW-6A*		1-3/4" One Piece Surface Raceway	1.75 (44.5)	1.0 (25.4)	6.0 ft (1.8)	Office White	120 ft
TSRP3W-6A*		1-3/4" One Piece Surface Raceway	1.75 (44.5)	1.0 (25.4)	6.0 ft (1.8)	White	120 ft
TSRP3I-8A*	TSRP3-8A	1-3/4" One Piece Surface Raceway	1.75 (44.5)	1.0 (25.4)	8.0 ft (2.4)	Ivory	160 ft
TSRP3FW-8A*		1-3/4" One Piece Surface Raceway	1.75 (44.5)	1.0 (25.4)	8.0 ft (2.4)	Office White	160 ft
TSRP3W-8A*		1-3/4" One Piece Surface Raceway	1.75 (44.5)	1.0 (25.4)	8.0 ft (2.4)	White	160 ft

Dimensions are approximate and subject to technical changes. Use Part No. for ordering and Type for specification purposes.

*This product meets UL standards. Please see appendix for specific file numbers. For wire fill capacities, see appendix.



Please note! Not all products listed on this page may have this approval. Please check our website for latest approvals.

Routing, Protection and Insulation

Surface Raceway

Power Rated Raceway Fittings and Junction Boxes

TSRP - Ceiling Drops

HellermannTyton surface raceway systems are the ideal solution for routing communication and power cables. No need to break into existing walls - raceway systems are designed to route cable along wall surfaces. Made of a PVC material, components are durable and affordable; and the one piece construction and adhesive tape backing make positioning and mounting easy. HellermannTyton offers a low voltage TSR system and a power rated TSRP system that are available in three different diameters to accommodate different cable and wire bundle and conduit sizes. Both systems include a complete line of fittings and junction boxes that allow for clean and professional installations. TSRP surface raceway systems are designed to aesthetically organize and route either power or communications cables.

Features and Benefits

- Tamper resistant covers with hidden latch provide security while allowing quick entry for cable maintenance.
- PVC construction is lightweight, durable and more affordable than metallic raceway systems.
- Flexible hinge designed to reduce stress cracking and discoloration from repeated opening and closing.
- Systems and fittings are available in white, office white and ivory to coordinate with a variety of décor.
- Fittings incorporate a minimum 1" bend radius to meet TIA/EIA 568-B and 569-A standards.
- TSRP power rated surface raceway systems have an enhanced "channel and lug" mating design that provides a tighter, more secure fit between raceway lengths and fittings, enabling the system to be UL Listed for power up to 600 volts and meet UL5A and CSA 22.2.



MATERIAL	Polyvinylchloride (PVC)
Flammability	UL 94 V0
Operating Temperature	+122°F (+50°C)

RoHS ✓

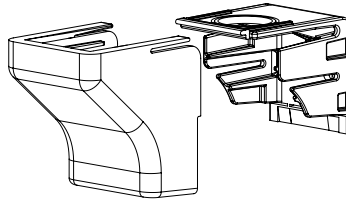

PART NO.	TYPE	Description	Color	Pkg. Qty.
TSRP1I-50*	TSRP1-50	Ceiling Drop, 3/4"	Ivory	1
TSRP1FW-50*		Ceiling Drop, 3/4"	Office White	1
TSRP1W-50*		Ceiling Drop, 3/4"	White	1
TSRP2I-50*	TSRP2-50	Ceiling Drop, 1-1/4"	Ivory	1
TSRP2FW-50*		Ceiling Drop, 1-1/4"	Office White	1
TSRP2W-50*		Ceiling Drop, 1-1/4"	White	1
TSRP3I-50*	TSRP3-50	Ceiling Drop, 1-3/4"	Ivory	1
TSRP3FW-50*		Ceiling Drop, 1-3/4"	Office White	1
TSRP3W-50*		Ceiling Drop, 1-3/4"	White	1

Dimensions are approximate and subject to technical changes. Use Part No. for ordering and Type for specification purposes.

*This product meets UL standards. Please see appendix for specific file numbers.



Please note! Not all products listed on this page may have this approval. Please check our website for latest approvals.

Power Rated Raceway Fittings and Junction Boxes

TSRP - Elbow Covers

HellermannTyton surface raceway systems are the ideal solution for routing communication and power cables. No need to break into existing walls - raceway systems are designed to route cable along wall surfaces. Made of a PVC material, components are durable and affordable; and the one piece construction and adhesive tape backing make positioning and mounting easy. HellermannTyton offers a low voltage TSR system and a power rated TSRP system that are available in three different diameters to accommodate different cable and wire bundle and conduit sizes. Both systems include a complete line of fittings and junction boxes that allow for clean and professional installations. TSRP surface raceway systems are designed to aesthetically organize and route either power or communications cables.

Features and Benefits

- Tamper resistant covers with hidden latch provide security while allowing quick entry for cable maintenance.
- PVC construction is lightweight, durable and more affordable than metallic raceway systems.
- Flexible hinge designed to reduce stress cracking and discoloration from repeated opening and closing.
- Systems and fittings are available in white, office white and ivory to coordinate with a variety of décor.
- Fittings incorporate a minimum 1" bend radius to meet TIA/EIA 568-B and 569-A standards.
- TSRP power rated surface raceway systems have an enhanced "channel and lug" mating design that provides a tighter, more secure fit between raceway lengths and fittings, enabling the system to be UL Listed for power up to 600 volts and meet UL5A and CSA 22.2.



MATERIAL	Polyvinylchloride (PVC)
Flammability	UL 94 V0
Operating Temperature	+122°F (+50°C)

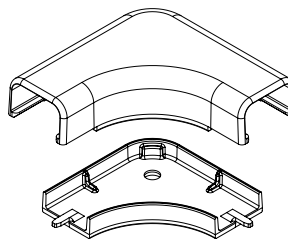

PART NO.	TYPE	Description	Color	Pkg. Qty.
TSRP1I-25-1*	TSRP1-25-1	Elbow Cover, 3/4"	Ivory	1
TSRP1FW-25-1*		Elbow Cover, 3/4"	Office White	1
TSRP1W-25-1*		Elbow Cover, 3/4"	White	1
TSRP2I-25-1*	TSRP2-25-1	Elbow Cover, 1-1/4"	Ivory	1
TSRP2FW-25-1*		Elbow Cover, 1-1/4"	Office White	1
TSRP2W-25-1*		Elbow Cover, 1-1/4"	White	1
TSRP3I-25-1*	TSRP3-25-1	Elbow Cover, 1-3/4"	Ivory	1
TSRP3FW-25-1*		Elbow Cover, 1-3/4"	Office White	1
TSRP3W-25-1*		Elbow Cover, 1-3/4"	White	1

Dimensions are approximate and subject to technical changes. Use Part No. for ordering and Type for specification purposes.

*This product meets UL standards. Please see appendix for specific file numbers.



Please note! Not all products listed on this page may have this approval. Please check our website for latest approvals.

Routing, Protection and Insulation

Surface Raceway

Power Rated Raceway Fittings and Junction Boxes

TSRP - End Caps

HellermannTyton surface raceway systems are the ideal solution for routing communication and power cables. No need to break into existing walls - raceway systems are designed to route cable along wall surfaces. Made of a PVC material, components are durable and affordable; and the one piece construction and adhesive tape backing make positioning and mounting easy. HellermannTyton offers a low voltage TSR system and a power rated TSRP system that are available in three different diameters to accommodate different cable and wire bundle and conduit sizes. Both systems include a complete line of fittings and junction boxes that allow for clean and professional installations. TSRP surface raceway systems are designed to aesthetically organize and route either power or communications cables.

Features and Benefits

- Tamper resistant covers with hidden latch provide security while allowing quick entry for cable maintenance.
- PVC construction is lightweight, durable and more affordable than metallic raceway systems.
- Flexible hinge designed to reduce stress cracking and discoloration from repeated opening and closing.
- Systems and fittings are available in white, office white and ivory to coordinate with a variety of décor.
- Fittings incorporate a minimum 1" bend radius to meet TIA/EIA 568-B and 569-A standards.
- TSRP power rated surface raceway systems have an enhanced "channel and lug" mating design that provides a tighter, more secure fit between raceway lengths and fittings, enabling the system to be UL Listed for power up to 600 volts and meet UL5A and CSA 22.2.



MATERIAL	Polyvinylchloride (PVC)
Flammability	UL 94 V0
Operating Temperature	+122°F (+50°C)

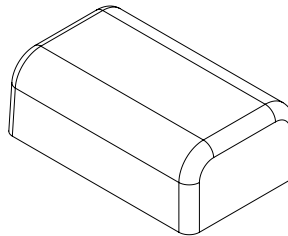

PART NO.	TYPE	Description	Color	Pkg. Qty.
TSRP1I-36*	TSRP1-36	End Cap, 3/4"	Ivory	1
TSRP1FW-36*		End Cap, 3/4"	Office White	1
TSRP1W-36*		End Cap, 3/4"	White	1
TSRP2I-36*	TSRP2-36	End Cap, 1-1/4"	Ivory	1
TSRP2FW-36*		End Cap, 1-1/4"	Office White	1
TSRP2W-36*		End Cap, 1-1/4"	White	1
TSRP3I-36*	TSRP3-36	End Cap, 1-3/4"	Ivory	1
TSRP3FW-36*		End Cap, 1-3/4"	Office White	1
TSRP3W-36*		End Cap, 1-3/4"	White	1

Dimensions are approximate and subject to technical changes. Use Part No. for ordering and Type for specification purposes.

*This product meets UL standards. Please see appendix for specific file numbers.



Please note! Not all products listed on this page may have this approval. Please check our website for latest approvals.

Power Rated Raceway Fittings and Junction Boxes

TSRP - Internal Corner Covers

HellermannTyton surface raceway systems are the ideal solution for routing communication and power cables. No need to break into existing walls - raceway systems are designed to route cable along wall surfaces. Made of a PVC material, components are durable and affordable; and the one piece construction and adhesive tape backing make positioning and mounting easy. HellermannTyton offers a low voltage TSR system and a power rated TSRP system that are available in three different diameters to accommodate different cable and wire bundle and conduit sizes. Both systems include a complete line of fittings and junction boxes that allow for clean and professional installations. TSRP surface raceway systems are designed to aesthetically organize and route either power or communications cables.

Features and Benefits

- Tamper resistant covers with hidden latch provide security while allowing quick entry for cable maintenance.
- PVC construction is lightweight, durable and more affordable than metallic raceway systems.
- Flexible hinge designed to reduce stress cracking and discoloration from repeated opening and closing.
- Systems and fittings are available in white, office white and ivory to coordinate with a variety of décor.
- Fittings incorporate a minimum 1" bend radius to meet TIA/EIA 568-B and 569-A standards.
- TSRP power rated surface raceway systems have an enhanced "channel and lug" mating design that provides a tighter, more secure fit between raceway lengths and fittings, enabling the system to be UL Listed for power up to 600 volts and meet UL5A and CSA 22.2.



MATERIAL	Polyvinylchloride (PVC)
Flammability	UL 94 V0
Operating Temperature	+122°F (+50°C)

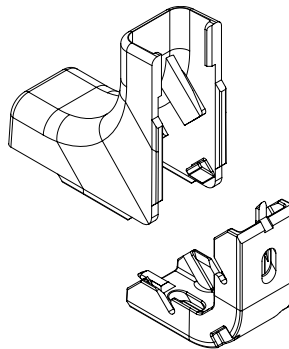

PART NO.	TYPE	Description	Color	Pkg. Qty.
TSRP1I-33-1*	TSRP1-33-1	Internal Corner Cover, 3/4"	Ivory	1
TSRP1FW-33-1*		Internal Corner Cover, 3/4"	Office White	1
TSRP1W-33-1*		Internal Corner Cover, 3/4"	White	1
TSRP2I-33-1*	TSRP2-33-1	Internal Corner Cover, 1-1/4"	Ivory	1
TSRP2FW-33-1*		Internal Corner Cover, 1-1/4"	Office White	1
TSRP2W-33-1*		Internal Corner Cover, 1-1/4"	White	1
TSRP3I-33-1*	TSRP3-33-1	Internal Corner Cover, 1-3/4"	Ivory	1
TSRP3FW-33-1*		Internal Corner Cover, 1-3/4"	Office White	1
TSRP3W-33-1*		Internal Corner Cover, 1-3/4"	White	1

Dimensions are approximate and subject to technical changes. Use Part No. for ordering and Type for specification purposes.
 *This product meets UL standards. Please see appendix for specific file numbers.



Please note! Not all products listed on this page may have this approval. Please check our website for latest approvals.

Routing, Protection and Insulation

Surface Raceway

Power Rated Raceway Fittings and Junction Boxes

TSRP - External Corners and Corner Covers

HellermannTyton surface raceway systems are the ideal solution for routing communication and power cables. No need to break into existing walls - raceway systems are designed to route cable along wall surfaces. Made of a PVC material, components are durable and affordable; and the one piece construction and adhesive tape backing make positioning and mounting easy. HellermannTyton offers a low voltage TSR system and a power rated TSRP system that are available in three different diameters to accommodate different cable and wire bundle and conduit sizes. Both systems include a complete line of fittings and junction boxes that allow for clean and professional installations. TSRP surface raceway systems are designed to aesthetically organize and route either power or communications cables.

Features and Benefits

- Tamper resistant covers with hidden latch provide security while allowing quick entry for cable maintenance.
- PVC construction is lightweight, durable and more affordable than metallic raceway systems.
- Flexible hinge designed to reduce stress cracking and discoloration from repeated opening and closing.
- Systems and fittings are available in white, office white and ivory to coordinate with a variety of décor.
- Fittings incorporate a minimum 1" bend radius to meet TIA/EIA 568-B and 569-A standards.
- TSRP power rated surface raceway systems have an enhanced "channel and lug" mating design that provides a tighter, more secure fit between raceway lengths and fittings, enabling the system to be UL Listed for power up to 600 volts and meet UL5A and CSA 22.2.



MATERIAL	Polyvinylchloride (PVC)
Flammability	UL 94 V0
Operating Temperature	+122°F (+50°C)

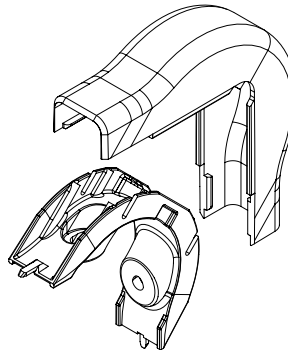

PART NO.	TYPE	Description	Color	Pkg. Qty.
TSRP1I-29-1*	TSRP1-29-1	External Corner, 3/4"	Ivory	1
TSRP1FW-29-1*		External Corner, 3/4"	Office White	1
TSRP1W-29-1*		External Corner, 3/4"	White	1
TSRP2I-29-1*	TSRP2-29-1	External Corner Cover, 1-1/4"	Ivory	1
TSRP2FW-29-1*		External Corner Cover, 1-1/4"	Office White	1
TSRP2W-29-1*		External Corner Cover, 1-1/4"	White	1
TSRP3I-29-1*	TSRP3-29-1	External Corner Cover, 1-3/4"	Ivory	1
TSRP3FW-29-1*		External Corner Cover, 1-3/4"	Office White	1
TSRP3W-29-1*		External Corner Cover, 1-3/4"	White	1

Dimensions are approximate and subject to technical changes. Use Part No. for ordering and Type for specification purposes.

*This product meets UL standards. Please see appendix for specific file numbers.



Please note! Not all products listed on this page may have this approval. Please check our website for latest approvals.

Power Rated Raceway Fittings and Junction Boxes

TSRP - Reducers

HellermannTyton surface raceway systems are the ideal solution for routing communication and power cables. No need to break into existing walls - raceway systems are designed to route cable along wall surfaces. Made of a PVC material, components are durable and affordable; and the one piece construction and adhesive tape backing make positioning and mounting easy. HellermannTyton offers a low voltage TSR system and a power rated TSRP system that are available in three different diameters to accommodate different cable and wire bundle and conduit sizes. Both systems include a complete line of fittings and junction boxes that allow for clean and professional installations. TSRP surface raceway systems are designed to aesthetically organize and route either power or communications cables.

Features and Benefits

- Tamper resistant covers with hidden latch provide security while allowing quick entry for cable maintenance.
- PVC construction is lightweight, durable and more affordable than metallic raceway systems.
- Flexible hinge designed to reduce stress cracking and discoloration from repeated opening and closing.
- Systems and fittings are available in white, office white and ivory to coordinate with a variety of décor.
- Fittings incorporate a minimum 1" bend radius to meet TIA/EIA 568-B and 569-A standards.
- TSRP power rated surface raceway systems have an enhanced "channel and lug" mating design that provides a tighter, more secure fit between raceway lengths and fittings, enabling the system to be UL Listed for power up to 600 volts and meet UL5A and CSA 22.2.



MATERIAL	Polyvinylchloride (PVC)
Flammability	UL 94 V0
Operating Temperature	+122°F (+50°C)

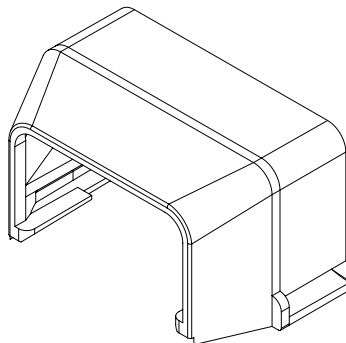

PART NO.	TYPE	Description	Color	Pkg. Qty.
TSRP1I-12*	TSRP1-12	Reducer, 1-3/4" to 1-1/4"	Ivory	1
TSRP1FW-12*		Reducer, 1-3/4" to 1-1/4"	Office White	1
TSRP1W-12*		Reducer, 1-3/4" to 1-1/4"	White	1
TSRP2I-12*	TSRP2-12	Reducer, 1-3/4" to 3/4"	Ivory	1
TSRP2FW-12*		Reducer, 1-3/4" to 3/4"	Office White	1
TSRP2W-12*		Reducer, 1-3/4" to 3/4"	White	1
TSRP3I-12*	TSRP3-12	Reducer 1-1/4" to 3/4"	Ivory	1
TSRP3FW-12*		Reducer 1-1/4" to 3/4"	Office White	1
TSRP3W-12*		Reducer 1-1/4" to 3/4"	White	1

Dimensions are approximate and subject to technical changes. Use Part No. for ordering and Type for specification purposes.
 *This product meets UL standards. Please see appendix for specific file numbers.



Please note! Not all products listed on this page may have this approval. Please check our website for latest approvals.

Routing, Protection and Insulation

Surface Raceway

Power Rated Raceway Fittings and Junction Boxes

TSRP - Splice Covers

HellermannTyton surface raceway systems are the ideal solution for routing communication and power cables. No need to break into existing walls - raceway systems are designed to route cable along wall surfaces. Made of a PVC material, components are durable and affordable; and the one piece construction and adhesive tape backing make positioning and mounting easy. HellermannTyton offers a low voltage TSR system and a power rated TSRP system that are available in three different diameters to accommodate different cable and wire bundle and conduit sizes. Both systems include a complete line of fittings and junction boxes that allow for clean and professional installations. TSRP surface raceway systems are designed to aesthetically organize and route either power or communications cables.

Features and Benefits

- Tamper resistant covers with hidden latch provide security while allowing quick entry for cable maintenance.
- PVC construction is lightweight, durable and more affordable than metallic raceway systems.
- Flexible hinge designed to reduce stress cracking and discoloration from repeated opening and closing.
- Systems and fittings are available in white, office white and ivory to coordinate with a variety of décor.
- Fittings incorporate a minimum 1" bend radius to meet TIA/EIA 568-B and 569-A standards.
- TSRP power rated surface raceway systems have an enhanced "channel and lug" mating design that provides a tighter, more secure fit between raceway lengths and fittings, enabling the system to be UL Listed for power up to 600 volts and meet UL5A and CSA 22.2.



MATERIAL	Polyvinylchloride (PVC)
Flammability	UL 94 V0
Operating Temperature	+122°F (+50°C)

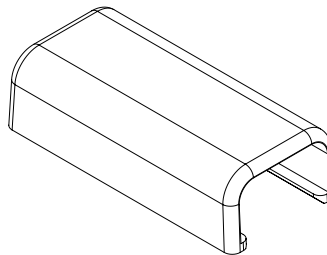

PART NO.	TYPE	Description	Color	Pkg. Qty.
TSRP1I-14*	TSRP1-14	Splice Cover, 3/4"	Ivory	1
TSRP1FW-14*		Splice Cover, 3/4"	Office White	1
TSRP1W-14*		Splice Cover, 3/4"	White	1
TSRP2I-14*	TSRP2-14	Splice Cover, 1-1/4"	Ivory	1
TSRP2FW-14*		Splice Cover, 1-1/4"	Office White	1
TSRP2W-14*		Splice Cover, 1-1/4"	White	1
TSRP3I-14*	TSRP3-14	Splice Cover, 1-3/4"	Ivory	1
TSRP3FW-14*		Splice Cover, 1-3/4"	Office White	1
TSRP3W-14*		Splice Cover, 1-3/4"	White	1

Dimensions are approximate and subject to technical changes. Use Part No. for ordering and Type for specification purposes.

*This product meets UL standards. Please see appendix for specific file numbers.



Please note! Not all products listed on this page may have this approval. Please check our website for latest approvals.

Power Rated Raceway Fittings and Junction Boxes

TSRP - Tee Covers

HellermannTyton surface raceway systems are the ideal solution for routing communication and power cables. No need to break into existing walls - raceway systems are designed to route cable along wall surfaces. Made of a PVC material, components are durable and affordable; and the one piece construction and adhesive tape backing make positioning and mounting easy. HellermannTyton offers a low voltage TSR system and a power rated TSRP system that are available in three different diameters to accommodate different cable and wire bundle and conduit sizes. Both systems include a complete line of fittings and junction boxes that allow for clean and professional installations. TSRP surface raceway systems are designed to aesthetically organize and route either power or communications cables.

Features and Benefits

- Tamper resistant covers with hidden latch provide security while allowing quick entry for cable maintenance.
- PVC construction is lightweight, durable and more affordable than metallic raceway systems.
- Flexible hinge designed to reduce stress cracking and discoloration from repeated opening and closing.
- Systems and fittings are available in white, office white and ivory to coordinate with a variety of décor.
- Fittings incorporate a minimum 1" bend radius to meet TIA/EIA 568-B and 569-A standards.
- TSRP power rated surface raceway systems have an enhanced "channel and lug" mating design that provides a tighter, more secure fit between raceway lengths and fittings, enabling the system to be UL Listed for power up to 600 volts and meet UL5A and CSA 22.2.



MATERIAL	Polyvinylchloride (PVC)
Flammability	UL 94 V0
Operating Temperature	+122°F (+50°C)

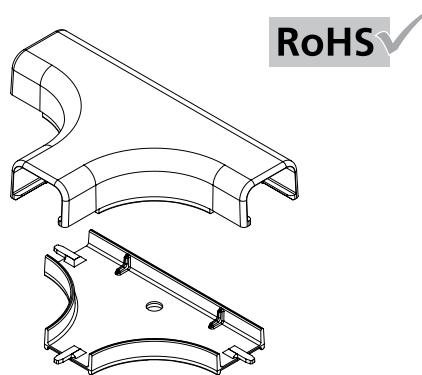

PART NO.	TYPE	Description	Color	Pkg. Qty.
TSRP1I-21-1*	TSRP1-21-1	Tee Cover, 3/4"	Ivory	1
TSRP1FW-21-1*		Tee Cover, 3/4"	Office White	1
TSRP1W-21-1*		Tee Cover, 3/4"	White	1
TSRP2I-21-1*	TSRP2-21-1	Tee Cover, 1-1/4"	Ivory	1
TSRP2FW-21-1*		Tee Cover, 1-1/4"	Office White	1
TSRP2W-21-1*		Tee Cover, 1-1/4"	White	1
TSRP3I-21-1*	TSRP3-21-1	Tee Cover, 1-3/4"	Ivory	1
TSRP3FW-21-1*		Tee Cover, 1-3/4"	Office White	1
TSRP3W-21-1*		Tee Cover, 1-3/4"	White	1

Dimensions are approximate and subject to technical changes. Use Part No. for ordering and Type for specification purposes.
 *This product meets UL standards. Please see appendix for specific file numbers.



Please note! Not all products listed on this page may have this approval. Please check our website for latest approvals.

Routing, Protection and Insulation

Surface Raceway

Power Rated Raceway Fittings and Junction Boxes

TSRP - Round Junction Boxes

Designed for mounting of low and line voltage fixtures such as hanging lights, smoke detectors, carbon monoxide detectors and security cameras, the TSRP round junction box complements HellermannTyton's full line of power rated TSRP and low voltage TSR raceway systems. The TSRP round junction box is constructed of a durable PVC material and is available in white, office white and ivory to coordinate with all HellermannTyton surface mount raceway systems.

Features and Benefits

- Pre-scored knockouts on the base and all four sides remove easily to accommodate 0.5", 0.75" or 1.0" diameter conduit and all HellermannTyton TSR/TSRP raceway sizes.
- Simple two piece design is easy to install and includes foam tape backing with rubber based adhesive to assist with temporary positioning and mounting.
- Accommodates a variety of alarm/detector and fixture makes and models.
- PVC construction is lightweight and durable.
- Covers are designed to overlap raceway mating points to hide uneven cuts.
- Fittings incorporate a minimum 1" bend radius per TIA/EIA 568-B and 569-A standards.
- UL 5A Listed to 600V and CSA Certified to 300V (not to exceed 10 lbs. per UL and 5 lbs. per CSA.)



MATERIAL	Polyvinylchloride (PVC)
Flammability	UL 94 V0
Operating Temperature	+122°F (+50°C)

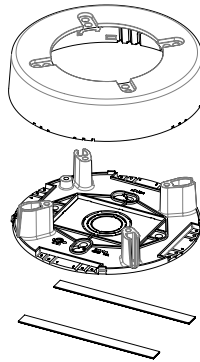

RoHS ✓

PART NO.	TYPE	Description	Color	Pkg. Qty.
TSRPI-RB*	TSRPI-RB	Round Junction Box, 1-1/4" Deep	Ivory	1
TSRPFW-RB*	TSRPFW-RB	Round Junction Box, 1-1/4" Deep	Office White	1
TSRPW-RB*	TSRPW-RB	Round Junction Box, 1-1/4" Deep	White	1

Dimensions are approximate and subject to technical changes. Use Part No. for ordering and Type for specification purposes.

*This product meets UL standards. Please see appendix for specific file numbers.



Please note! Not all products listed on this page may have this approval. Please check our website for latest approvals.

Power Rated Raceway Fittings and Junction Boxes

TSRP - Single Gang Junction Boxes

Offered in a dual or single gang format, HellermannTyton's power-rated junction boxes are versatile enough for any network cabling application. Available in varying depths, these boxes are all equipped with concentric knockouts on all four sides for every TSRP size of raceway, which eliminates routing and installation inconvenience. All five styles of junction boxes come with adhesive strips for the back of the base, and also #6 screws to secure the box to the base.

Features and Benefits

- TSRP rated boxes can be used for electrical or data outlets.
- Rubber based foam tape adhesive with high ultimate bond strength, which conforms to any surface.

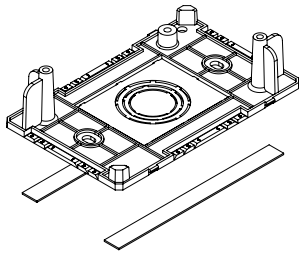
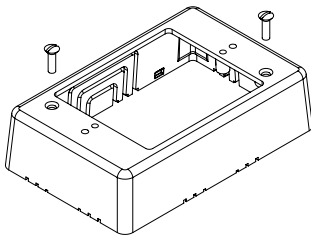

MATERIAL	Polyvinylchloride (PVC)
Flammability	UL 94 V0
Operating Temperature	+122°F (+50°C)



PART NO.	TYPE	Description	Width (W) in. (mm)	Height (H) in. (mm)	Length (L) in. (mm)	Color	Pkg. Qty.
TSRPI-JB1*	TSRP-JB1	Single Gang Junction Box	3.00 (76.2)	1.25 (31.8)	4.75 (120.7)	Ivory	1
TSRPFW-JB1*		Single Gang Junction Box	3.00 (76.2)	1.25 (31.8)	4.75 (120.7)	Office White	1
TSRPW-JB1*		Single Gang Junction Box	3.00 (76.2)	1.25 (31.8)	4.75 (120.7)	White	1
TSRPI-JB2*	TSRP-JB2	Single Gang Junction Box	3.00 (76.2)	2.00 (50.8)	4.75 (120.7)	Ivory	1
TSRPFW-JB2*		Single Gang Junction Box	3.00 (76.2)	2.00 (50.8)	4.75 (120.7)	Office White	1
TSRPW-JB2*		Single Gang Junction Box	3.00 (76.2)	2.00 (50.8)	4.75 (120.7)	White	1
TSRPI-JB3*	TSRP-JB3	Single Gang Junction Box	3.20 (81.3)	2.77 (70.4)	4.95 (125.7)	Ivory	1
TSRPFW-JB3*		Single Gang Junction Box	3.20 (81.3)	2.77 (70.4)	4.95 (125.7)	Office White	1
TSRPW-JB3*		Single Gang Junction Box	3.20 (81.3)	2.77 (70.4)	4.95 (125.7)	White	1

Dimensions are approximate and subject to technical changes. Use Part No. for ordering and Type for specification purposes.

*This product meets UL standards. Please see appendix for specific file numbers.



Please note! Not all products listed on this page may have this approval. Please check our website for latest approvals.

Routing, Protection and Insulation

Surface Raceway

Power Rated Raceway Fittings and Junction Boxes

TSRP - Dual Gang Junction Boxes

Offered in a dual or single gang format, HellermannTyton's power-rated junction boxes are versatile enough for any network cabling application. Available in varying depths, these boxes are all equipped with concentric knockouts on all four sides for every TSRP size of raceway to eliminate routing and installation inconvenience. All junction boxes come with adhesive strips on the back of the base and #6 screws to secure the box to the base.

Features and Benefits

- Junction boxes can be used for electrical or data outlets.
- Rubber-based foam tape adhesive with high ultimate bond strength, which conforms to any surface.

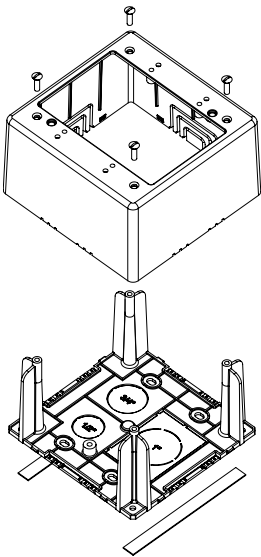

MATERIAL	Polyvinylchloride (PVC)
Flammability	UL 94 V0
Operating Temperature	+122°F (+50°C)



PART NO.	TYPE	Description	Width (W) in. (mm)	Height (H) in. (mm)	Length (L) in. (mm)	Color	Pkg. Qty.
TSRPI-JBD*	TSRP-JBD	Dual Gang Junction Box	4.91 (124.7)	1.50 (38.1)	4.83 (122.7)	Ivory	1
TSRPFW-JBD*		Dual Gang Junction Box	4.91 (124.7)	1.50 (38.1)	4.83 (122.7)	Office White	1
TSRPW-JBD*		Dual Gang Junction Box	4.91 (124.7)	1.50 (38.1)	4.83 (122.7)	White	1
TSRPI-JBD2*	TSRP-JBD2	Dual Gang Junction Box	5.02 (127.5)	2.77 (70.4)	4.94 (125.5)	Ivory	1
TSRPFW-JBD2*		Dual Gang Junction Box	5.02 (127.5)	2.77 (70.4)	4.94 (125.5)	Office White	1
TSRPW-JBD2*		Dual Gang Junction Box	5.02 (127.5)	2.77 (70.4)	4.94 (125.5)	White	1

Dimensions are approximate and subject to technical changes. Use Part No. for ordering and Type for specification purposes.
*This product meets UL standards. Please see appendix for specific file numbers.



Please note! Not all products listed on this page may have this approval. Please check our website for latest approvals.

Multi-Channel Raceway

Raceway Base and Covers

The InfoStream® multi-channel surface raceway system is designed to organize, protect and route multiple types of cable and wire along interior walls. Dividers snap inside raceway to create up to four channels to separate and route communication and power cables. Manufactured from lightweight PVC material, InfoStream multi-channel raceway components are UL5A listed and CSA 22.2 rated for up to 600 volts.

Features and Benefits

- Raceway and fittings are manufactured from a UL94 V0 rated material to insure compliance with codes.
- All fittings have been designed to maintain the required 1" minimum bend radius to meet TIA/EIA-568-B and 569-A standard.
- Raceway and fittings are UL Listed to 600 Volts to meet new UL5A and CSA 22.2 No. 62-93 standards.
- Patented hinged cover speeds installation time by allowing installer to partially mount cover prior to laying cables.
- Base is supplied with prepunched mounting slots every 8".
- Raceway base includes adhesive double sided tape for aid in mounting. Raceway must still be properly fastened to the wall per instructions.



MATERIAL	Polyvinylchloride (PVC)
Flammability	UL 94 V0
Operating Temperature	+122°F (+50°C)

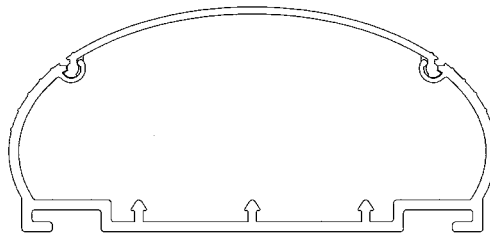

PART NO.	TYPE	Description	Color	Length (L) ft (m)	Carton Quantity
MCRI-B8*	MCR-B8	Base With Center Divider	Ivory	8.0 (2.4)	48 ft
MCRFW-B8*		Base With Center Divider	Office White	8.0 (2.4)	48 ft
MCRI-B10*	MCR-B10	Base With Center Divider	Ivory	10.0 (3.0)	60 ft
MCRFW-B10*		Base With Center Divider	Office White	10.0 (3.0)	60 ft
MCRI-BS8*	MCR-BS8	Base With Side Divider	Ivory	8.0 (2.4)	48 ft
MCRFW-BS8*		Base With Side Divider	Office White	8.0 (2.4)	48 ft
MCRI-BS10*	MCR-BS10	Base With Side Divider	Ivory	10.0 (3.0)	60 ft
MCRFW-BS10*		Base With Side Divider	Office White	10.0 (3.0)	60 ft
MCRI-C8*	MCR-C8	Cover	Ivory	8.0 (2.4)	48 ft
MCRFW-C8*		Cover	Office White	8.0 (2.4)	48 ft
MCRI-C10*	MCR-C10	Cover	Ivory	10.0 (3.0)	60 ft
MCRFW-C10*		Cover	Office White	10.0 (3.0)	60 ft

Dimensions are approximate and subject to technical changes. Use Part No. for ordering and Type for specification purposes.
 *This product meets UL standards. Please see appendix for specific file numbers. For wire fill capacities, see appendix.



Please note! Not all products listed on this page may have this approval. Please check our website for latest approvals.

Routing, Protection and Insulation

Surface Raceway

Multi-Channel Raceway

Raceway Base Splice

Base splice joins two sections of raceway base.

Features and Benefits

- Raceway and fittings are manufactured from a UL94 V0 rated material to insure compliance with codes.
- All fittings have been designed to maintain the required 1" minimum bend radius to meet TIA/EIA-568-B and 569-A standard.
- Raceway and fittings are UL Listed to 600 Volts to meet new UL5A and CSA 22.2 No. 62-93 standards.

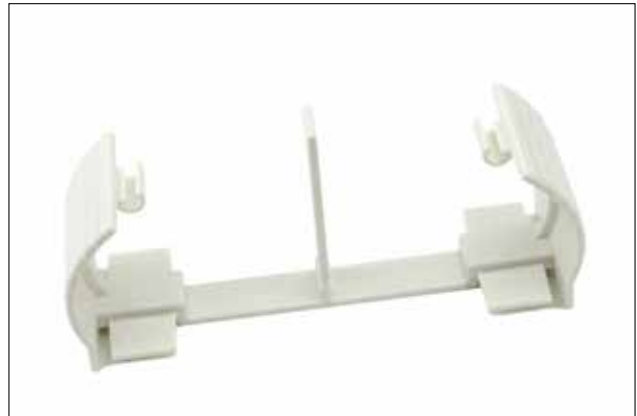

MATERIAL	Polyvinylchloride (PVC)
Flammability	UL 94 V0
Operating Temperature	+122°F (+50°C)

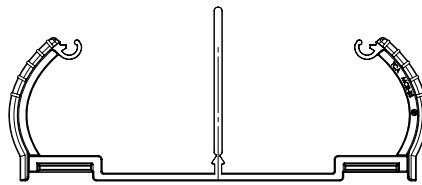
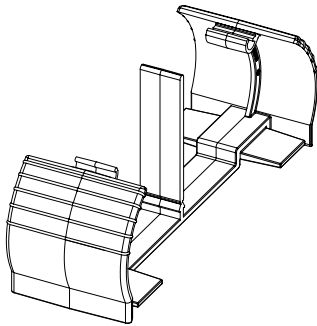

PART NO.	TYPE	Description	Color	Pkg. Qty.
MCRI-BS*	MCR-BS	Base Splice	Ivory	10
MCRFW-BS*		Base Splice	Office White	10

Dimensions are approximate and subject to technical changes. Use Part No. for ordering and Type for specification purposes.
 *This product meets UL standards. Please see appendix for specific file numbers.



Please note! Not all products listed on this page may have this approval. Please check our website for latest approvals.

Multi-Channel Raceway

Raceway Dividers

Dividers snap onto raceway base rails for proper power and data separation per UL/CSA.

Features and Benefits

- Raceway and fittings are manufactured from a UL94 V0 rated material to insure compliance with codes.
- All fittings have been designed to maintain the required 1" minimum bend radius to meet TIA/EIA-568-B and 569-A standard.
- Raceway and fittings are UL Listed to 600 Volts to meet new UL5A and CSA 22.2 No. 62-93 standards.

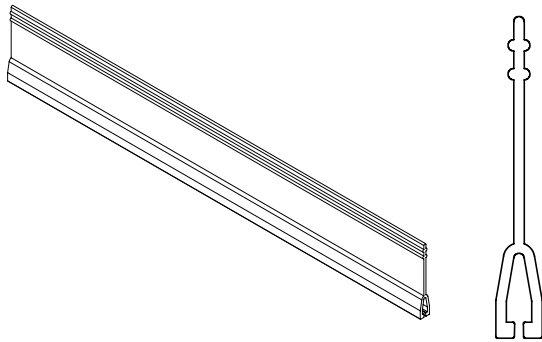

MATERIAL	Polyvinylchloride (PVC)
Flammability	UL 94 V0
Operating Temperature	+122°F (+50°C)



PART NO.	TYPE	Description	Length (L) ft (m)	Color	Pkg. Qty.
MCRI-CD8	MCR-CD8	Center Divider	8.0 (2.4)	Ivory	96 ft
MCRFW-CD8		Center Divider	8.0 (2.4)	Office White	96 ft
MCRI-CD10	MCR-CD10	Center Divider	10.0 (3.0)	Ivory	120 ft
MCRFW-CD10		Center Divider	10.0 (3.0)	Office White	120 ft
MCRW-SD8	MCR-SD8	Side Divider	8.0 (2.4)	White	48 ft
MCRW-SD10	MCR-SD10	Side Divider	10.0 (3.0)	White	60 ft

Dimensions are approximate and subject to technical changes. Use Part No. for ordering and Type for specification purposes.

Multi-Channel Raceway Fittings and Junction Boxes

External Elbow

External Elbow joins raceway at a 90 degree outside corner.

Features and Benefits

- Raceway and fittings are manufactured from a UL94 V0 rated material to insure compliance with codes.
- All fittings have been designed to maintain the required 1" minimum bend radius to meet TIA/EIA-568-B and 569-A standard.
- Raceway and fittings are UL Listed to 600 Volts to meet new UL5A and CSA 22.2 No. 62-93 standards.

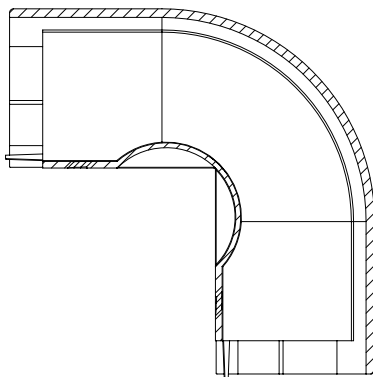

MATERIAL	Polyvinylchloride (PVC)
Flammability	UL 94 V0
Operating Temperature	+122°F (+50°C)



PART NO.	TYPE	Description	Color	Pkg. Qty.
MCRI-EE*	MCR-EE	External Elbow	Ivory	1
MCRFW-EE*		External Elbow	Office White	1

Dimensions are approximate and subject to technical changes. Use Part No. for ordering and Type for specification purposes.
 *This product meets UL standards. Please see appendix for specific file numbers.



Please note! Not all products listed on this page may have this approval. Please check our website for latest approvals.

Multi-Channel Raceway Fittings and Junction Boxes

Flat Elbow

Flat elbow joins raceway at a 90 degree flat angle.

Features and Benefits

- Raceway and fittings are manufactured from a UL94 V0 rated material to insure with codes.
- All fittings have been designed to maintain the required 1" minimum bend radius to meet TIA/EIA-568-B and 569-A standard.
- Raceway and fittings are UL Listed to 600 Volts to meet new UL5A and CSA 22.2 No. 62-93 standards.

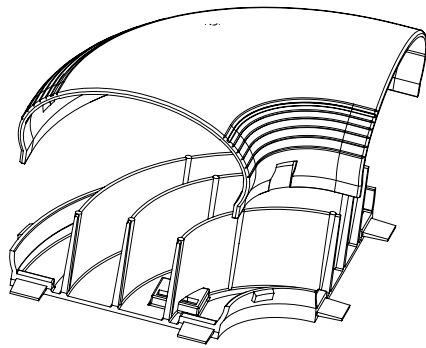

MATERIAL	Polyvinylchloride (PVC)
Flammability	UL 94 V0
Operating Temperature	+122°F (+50°C)



PART NO.	TYPE	Description	Color	Pkg. Qty.
MCR1-FE*	MCR-FE	Flat Elbow	Ivory	1
MCRFW-FE*		Flat Elbow	Office White	1

Dimensions are approximate and subject to technical changes. Use Part No. for ordering and Type for specification purposes.
 *This product meets UL standards. Please see appendix for specific file numbers.



Please note! Not all products listed on this page may have this approval. Please check our website for latest approvals.

Routing, Protection and Insulation

Surface Raceway

Multi-Channel Raceway Fittings and Junction Boxes

Internal Elbow

Internal elbow joins raceway at a 90 degree inside corner.

Features and Benefits

- Raceway and fittings are manufactured from a UL94 V0 rated material to insure compliance with codes.
- All fittings have been designed to maintain the required 1" minimum bend radius to meet TIA/EIA-568-B and 569-A standard.
- Raceway and fittings are UL Listed to 600 Volts to meet new UL5A and CSA 22.2 No. 62-93 standards.

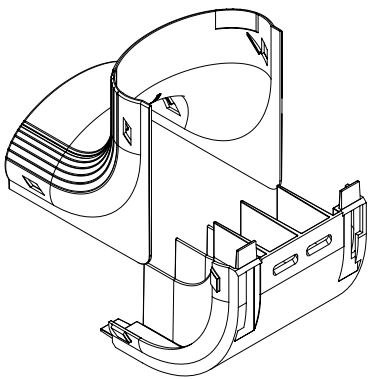

MATERIAL	Polyvinylchloride (PVC)
Flammability	UL 94 V0
Operating Temperature	+122°F (+50°C)



PART NO.	TYPE	Description	Color	Pkg. Qty.
MCRI-IE*	MCR-IE	Internal Elbow	Ivory	1
MCRFW-IE*		Internal Elbow	Office White	1

Dimensions are approximate and subject to technical changes. Use Part No. for ordering and Type for specification purposes.

*This product meets UL standards. Please see appendix for specific file numbers.



Please note! Not all products listed on this page may have this approval. Please check our website for latest approvals.

Multi-Channel Raceway Fittings and Junction Boxes

Cover Splice

Cover splice joins two sections of raceway cover.

Features and Benefits

- Raceway and fittings are manufactured from a UL94 V0 rated material to insure compliance with codes.
- All fittings have been designed to maintain the required 1" minimum bend radius to meet TIA/EIA-568-B and 569-A standard.
- Raceway and fittings are UL Listed to 600 Volts to meet new UL5A and CSA 22.2 No. 62-93 standards.

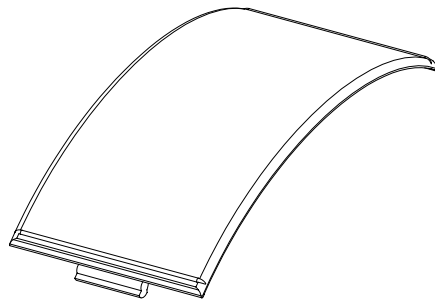

MATERIAL	Polyvinylchloride (PVC)
Flammability	UL 94 V0
Operating Temperature	+122°F (+50°C)



PART NO.	TYPE	Description	Color	Pkg. Qty.
MCRI-CS*	MCR-CS	Cover Splice	Ivory	10
MCRFW-CS*		Cover Splice	Office White	10

Dimensions are approximate and subject to technical changes. Use Part No. for ordering and Type for specification purposes.
 *This product meets UL standards. Please see appendix for specific file numbers.



Please note! Not all products listed on this page may have this approval. Please check our website for latest approvals.

Routing, Protection and Insulation

Surface Raceway

Multi-Channel Raceway Fittings and Junction Boxes

End Cap

End cap completes raceway or provides transition for 1/2", 3/4" and 1" conduit.

Features and Benefits

- Raceway and fittings are manufactured from a UL94 V0 rated material to insure compliance with codes.
- All fittings have been designed to maintain the required 1" minimum bend radius to meet TIA/EIA-568-B and 569-A standard.
- Raceway and fittings are UL Listed to 600 Volts to meet new UL5A and CSA 22.2 No. 62-93 standards.

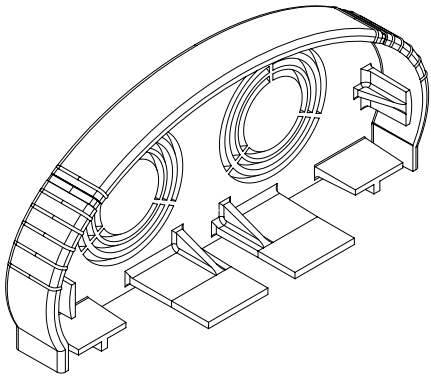

MATERIAL	Polyvinylchloride (PVC)
Flammability	UL 94 V0
Operating Temperature	+122°F (+50°C)



PART NO.	TYPE	Description	Color	Pkg. Qty.
MCRI-EC*	MCR-EC	End Cap	Ivory	1
MCRFW-EC*		End Cap	Office White	1

Dimensions are approximate and subject to technical changes. Use Part No. for ordering and Type for specification purposes.
 *This product meets UL standards. Please see appendix for specific file numbers.



Please note! Not all products listed on this page may have this approval. Please check our website for latest approvals.

Multi-Channel Raceway Fittings and Junction Boxes

Power Transition Fitting

Knockouts are provided for TSRP1, TSRP2 and TSRP3 surface raceway.

Features and Benefits

- Raceway and fittings are manufactured from a UL94 V0 rated material to insure compliance with codes.
- All fittings have been designed to maintain the required 1" minimum bend radius to meet TIA/EIA-568-B and 569-A standard.
- Raceway and fittings are UL Listed to 600 Volts to meet new UL5A and CSA 22.2 No. 62-93 standards.

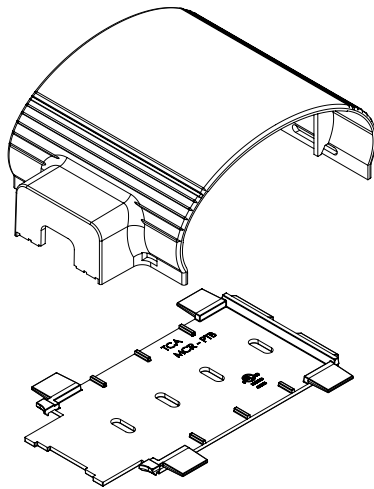

MATERIAL	Polyvinylchloride (PVC)
Flammability	UL 94 V0
Operating Temperature	+122°F (+50°C)



PART NO.	TYPE	Description	Color	Pkg. Qty.
MCRI-PTF*	MCR-PTF	Power Transition Fitting	Ivory	1
MCRFW-PTF*		Power Transition Fitting	Office White	1

Dimensions are approximate and subject to technical changes. Use Part No. for ordering and Type for specification purposes.

*This product meets UL standards. Please see appendix for specific file numbers.



Please note! Not all products listed on this page may have this approval. Please check our website for latest approvals.

Routing, Protection and Insulation

Surface Raceway

Multi-Channel Raceway Fittings and Junction Boxes

Offset Box

Option for communications devices in raceway and electrical outlets on side.

Features and Benefits

- Raceway and fittings are manufactured from a UL94 V0 rated material to insure compliance with codes.
- All fittings have been designed to maintain the required 1" minimum bend radius to meet TIA/EIA-568-B and 569-A standard.
- Raceway and fittings are UL Listed to 600 Volts to meet new UL5A and CSA 22.2 No. 62-93 standards.

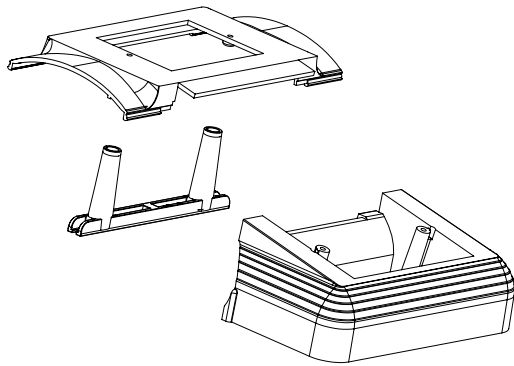

MATERIAL	Polyvinylchloride (PVC)
Flammability	UL 94 V0
Operating Temperature	+122°F (+50°C)



PART NO.	TYPE	Description	Color	Pkg. Qty.
MCRI-OB*	MCR-OB	Offset Box	Ivory	1
MCRFW-OB*		Offset Box	Office White	1

Dimensions are approximate and subject to technical changes. Use Part No. for ordering and Type for specification purposes.

*This product meets UL standards. Please see appendix for specific file numbers.



Please note! Not all products listed on this page may have this approval. Please check our website for latest approvals.

Multi-Channel Raceway Fittings and Junction Boxes

Raised Device Bracket

Raised device bracket is used to mount NEMA standard single gang device and faceplate. Raised bracket allows for additional wire fill space and additional device clearance. Use with side divider for 2-channel applications.

Features and Benefits

- Raceway and fittings are manufactured from a UL94 V0 rated material to insure compliance with codes.
- All fittings have been designed to maintain the required 1" minimum bend radius to meet TIA/EIA-568-B and 569-A standard.
- Raceway and fittings are UL Listed to 600 Volts to meet new UL5A and CSA 22.2 No. 62-93 standards.

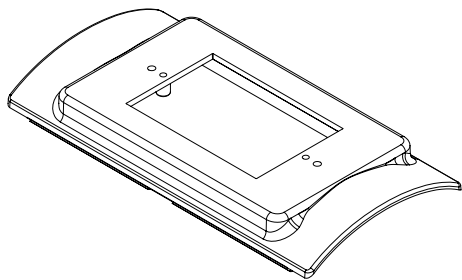

MATERIAL	Polyvinylchloride (PVC)
Flammability	UL 94 V0
Operating Temperature	+122°F (+50°C)



PART NO.	TYPE	Description	Color	Pkg. Qty.
MCR1-RDB*	MCR-RDB	Raised Device Bracket	Ivory	1
MCRFW-RDB*		Raised Device Bracket	Office White	1

Dimensions are approximate and subject to technical changes. Use Part No. for ordering and Type for specification purposes.
 *This product meets UL standards. Please see appendix for specific file numbers.



Please note! Not all products listed on this page may have this approval. Please check our website for latest approvals.

Routing, Protection and Insulation

Surface Raceway

Multi-Channel Raceway Fittings and Junction Boxes

Raised Electrical Box

Raised electrical box is used to mount NEMA standard single gang device and faceplate. Raised electrical box allows for additional low-voltage wire fill space. Use with side divider for 2-channel applications.

Features and Benefits

- Raceway and fittings are manufactured from a UL94 V0 rated material to insure compliance with codes.
- All fittings have been designed to maintain the required 1" minimum bend radius to meet TIA/EIA-568-B and 569-A standard.
- Raceway and fittings are UL Listed to 600 Volts to meet new UL5A and CSA 22.2 No. 62-93 standards.

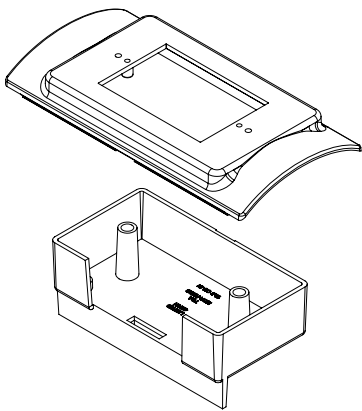

MATERIAL	Polyvinylchloride (PVC)
Flammability	UL 94 V0
Operating Temperature	+122°F (+50°C)



PART NO.	TYPE	Description	Color	Pkg. Qty.
MCRI-REB*	MCR-REB	Raised Electrical Box	Ivory	1
MCRFW-REB*		Raised Electrical Box	Office White	1

Dimensions are approximate and subject to technical changes. Use Part No. for ordering and Type for specification purposes.

*This product meets UL standards. Please see appendix for specific file numbers.



Please note! Not all products listed on this page may have this approval. Please check our website for latest approvals.

Multi-Channel Raceway Fittings and Junction Boxes

Entrance End Fitting

For use as a ceiling drop, conduit transition from end or base of raceway, or low voltage entrance from end or base of raceway. Includes dual 0.75", 1.0", 1.25", 1.75", 2.0" and 2.5" knockouts.

Features and Benefits

- Raceway and fittings are manufactured from a UL94 V0 rated material to insure compliance with codes.
- All fittings have been designed to maintain the required 1" minimum bend radius to meet TIA/EIA-568-B and 569-A standard.
- Raceway and fittings are UL Listed to 600 Volts to meet new UL5A and CSA 22.2 No. 62-93 standards.

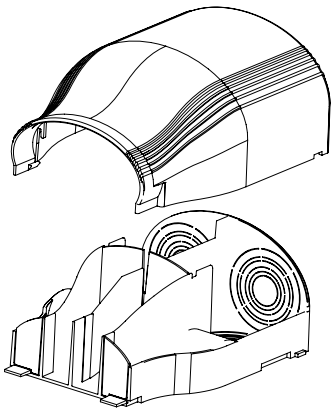

MATERIAL	Polyvinylchloride (PVC)
Flammability	UL 94 V0
Operating Temperature	+122°F (+50°C)



PART NO.	TYPE	Description	Color	Pkg. Qty.
MCRI-ENT*	MCR-ENT	Entrance End Fitting	Ivory	1
MCRFW-ENT*		Entrance End Fitting	Office White	1

Dimensions are approximate and subject to technical changes. Use Part No. for ordering and Type for specification purposes.

*This product meets UL standards. Please see appendix for specific file numbers.



Please note! Not all products listed on this page may have this approval. Please check our website for latest approvals.

Routing, Protection and Insulation

Surface Raceway

Multi-Channel Raceway Fittings and Junction Boxes

Offset Elbow

For small wall offsets between 2" - 7". Used in conjunction with a piece of raceway.

Features and Benefits

- Raceway and fittings are manufactured from a UL94 V0 rated material to insure compliance with codes.
- All fittings have been designed to maintain the required 1" minimum bend radius to meet TIA/EIA-568-B and 569-A standard.
- Raceway and fittings are UL Listed to 600 Volts to meet new UL5A and CSA 22.2 No. 62-93 standards.

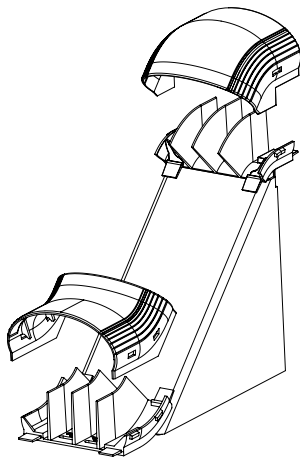

MATERIAL	Polyvinylchloride (PVC)
Flammability	UL 94 V0
Operating Temperature	+122°F (+50°C)



PART NO.	TYPE	Description	Color	Pkg. Qty.
MCRI-OE*	MCR-OE	Offset Elbow	Ivory	1
MCRFW-OE*		Offset Elbow	Office White	1

Dimensions are approximate and subject to technical changes. Use Part No. for ordering and Type for specification purposes.

*This product meets UL standards. Please see appendix for specific file numbers.



Please note! Not all products listed on this page may have this approval. Please check our website for latest approvals.

Multi-Channel Raceway Fittings and Junction Boxes

Offset Bridge

Offset bridge for bridging over conduit already installed on wall. Must be used with MCRFW-OE corner pieces.

Features and Benefits

- Raceway and fittings are manufactured from a UL94 V0 rated material to insure compliance with codes.
- All fittings have been designed to maintain the required 1" minimum bend radius to meet TIA/EIA-568-B and 569-A standard.
- Raceway and fittings are UL Listed to 600 Volts to meet new UL5A and CSA 22.2 No. 62-93 standards.



MATERIAL	Polyvinylchloride (PVC)
Flammability	UL 94 V0
Operating Temperature	+122°F (+50°C)



PART NO.	TYPE	Description	Color	Pkg. Qty.
MCRFW-OEB	MCR-OEB	Offset Bridge	Office White	1

Dimensions are approximate and subject to technical changes. Use Part No. for ordering and Type for specification purposes.

Routing, Protection and Insulation

Surface Raceway

Multi Channel Raceway Fittings and Junction Boxes

Tee Fittings

Tee fittings join three sections of raceway and includes a divider.

Features and Benefits

- Raceway and fittings are manufactured from a UL94 V0 rated material to insure compliance with codes.
- All fittings have been designed to maintain the required 1" minimum bend radius to meet TIA/EIA-568-B and 569-A standard.
- Raceway and fittings are UL Listed to 600 Volts to meet new UL5A and CSA 22.2 No. 62-93 standards.

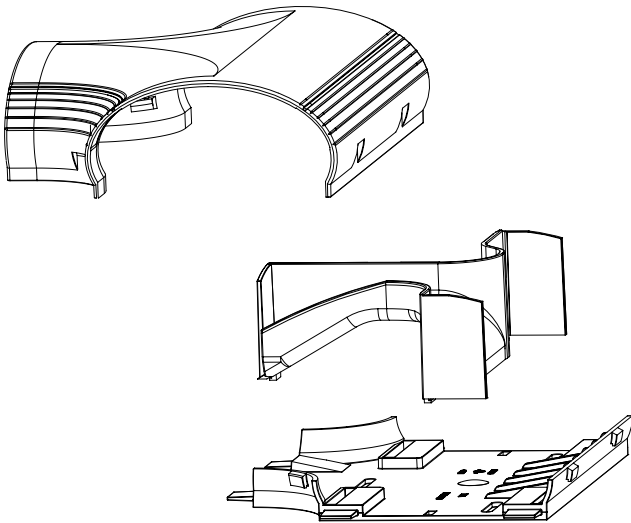

MATERIAL	Polyvinylchloride (PVC)
Flammability	UL 94 V0
Operating Temperature	+122°F (+50°C)

RoHS ✓

PART NO.	TYPE	Color	Pkg. Qty.
MCRI-TE*	MCR-TE	Ivory	1
MCRFW-TE*		Office White	1

Dimensions are approximate and subject to technical changes. Use Part No. for ordering and Type for specification purposes.

*This product meets UL standards. Please see appendix for specific file numbers.



Please note! Not all products listed on this page may have this approval. Please check our website for latest approvals.

Multi Channel Raceway Fittings and Junction Boxes

Tee Fitting Divider - Left Side

Divides power and communications cables on the opposite side.

Features and Benefits

- Raceway and fittings are manufactured from a UL94 V0 rated material to insure compliance with codes.
- All fittings have been designed to maintain the required 1" minimum bend radius to meet TIA/EIA-568-B and 569-A standard.
- Raceway and fittings are UL Listed to 600 Volts to meet new UL5A and CSA 22.2 No. 62-93 standards.

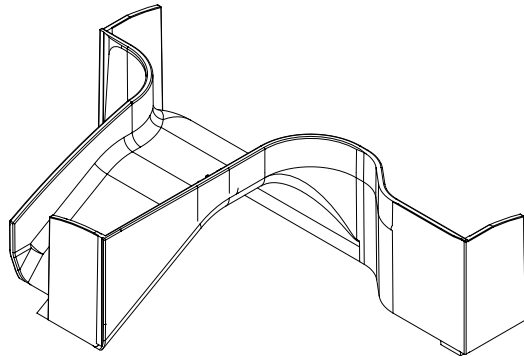

MATERIAL	Polyvinylchloride (PVC)
Flammability	UL 94 V0
Operating Temperature	+122°F (+50°C)



PART NO.	TYPE	Color	Pkg. Qty.
MCR-LTD*	MCR-LTD	Black	1

Dimensions are approximate and subject to technical changes. Use Part No. for ordering and Type for specification purposes.
 *This product meets UL standards. Please see appendix for specific file numbers.



Please note! Not all products listed on this page may have this approval. Please check our website for latest approvals.

Routing, Protection and Insulation

Surface Raceway

Multi-Channel Raceway Fittings and Junction Boxes

Wire Retainer

Wire retainer keeps wire and cable in place. Placement recommended every 18" to 24".

Features and Benefits

- Wire retainer simply snaps into place.

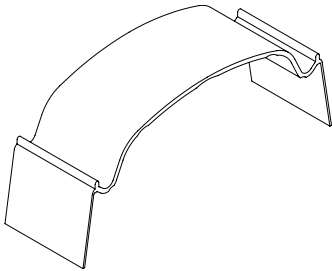

MATERIAL	Polyvinylchloride (PVC)
Flammability	UL 94 V0
Operating Temperature	+122°F (+50°C)



PART NO.	TYPE	Description	Color	Pkg. Qty.
MCRG-WR*	MCR-WR	Wire Retainer	Office White	10

Dimensions are approximate and subject to technical changes. Use Part No. for ordering and Type for specification purposes.
 *This product meets UL standards. Please see appendix for specific file numbers.

Multi-Channel Raceway Fittings and Junction Boxes

Tie Mount

Tie mount keeps wire and cable bundled. Accepts standard HellermannTyton cable ties T18 - T150. Placement recommended every 18" to 24".

Features and Benefits

- Integrated design of the raceway tie mount allows tie wrapped bundles to be safely secured.

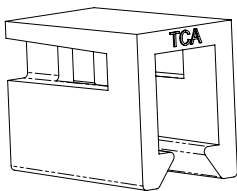

MATERIAL	Polyvinylchloride (PVC)
Flammability	UL 94 V0
Operating Temperature	+122°F (+50°C)



PART NO.	TYPE	Description	Color	Pkg. Qty.
MCRG-TM*	MCR-TM	Tie Mount	Office White	100

Dimensions are approximate and subject to technical changes. Use Part No. for ordering and Type for specification purposes.
 *This product meets UL standards. Please see appendix for specific file numbers.



Please note! Not all products listed on this page may have this approval. Please check our website for latest approvals.

Braided Sleeving - General Purpose

General Purpose Expandable Braided Sleeving

Designed to adjust and expand to irregular shapes, this general purpose sleeving is lightweight and offers a high tensile strength while still maintaining flexibility. This sleeving is an excellent choice for protecting wire and cable bundles from abrasion, chafing and heat degradation. Commonly used in electrical and industrial wire harnessing application where economy and durability are required for the protection of wires, cables, tubing, bundles and pneumatic hoses.

Features and Benefits

- Weave construction adjusts to twisting and flexing without creating wrinkles or bends.
- Expands up to 150% of flat diameter for easy installation.
- Offers excellent abrasion and cut-through resistance as well as inertness to most chemicals and fungus.



MATERIAL	Polyester (PET)
Operating Temperature	-94°F to +257°F (-70°C to +125°C)
Melting Point	+482 °F (+250 °C)
Abrasion Resistance	Medium
Flammability	UL 94 V0



PART NO.	TYPE	Nominal Dia. in. (mm)	Min. Bundle Diameter in. (mm)	Max. Bundle Diameter in. (mm)	Color	Reel Length ft (m)	Weight lbs. (kg)
170-03177*	BSP180	1/8 (3.2)	0.09 (2.4)	0.25 (6.4)	Black	225.0 (68.6)	0.5 (0.2)
170-03174*	BSP180B	1/8 (3.2)	0.09 (2.4)	0.25 (6.4)	Black	1000.0 (304.8)	1.8 (0.8)
170-03000*	BSP140	1/4 (6.4)	0.13 (3.2)	0.44 (11.1)	Black	200.0 (61.0)	0.5 (0.2)
170-03041*	BSP140B	1/4 (6.4)	0.13 (3.2)	0.44 (11.1)	Black	1000.0 (304.8)	2.6 (1.2)
170-03001*	BSP120	1/2 (12.7)	0.25 (6.4)	0.75 (19.1)	Black	100.0 (30.5)	0.8 (0.4)
170-03042*	BSP120B	1/2 (12.7)	0.25 (6.4)	0.75 (19.1)	Black	500.0 (152.4)	3.9 (1.8)
170-03002*	BSP340	3/4 (19.1)	0.50 (12.7)	1.25 (31.8)	Black	75.0 (22.9)	0.9 (0.4)
170-03043*	BSP340B	3/4 (19.1)	0.50 (12.7)	1.25 (31.8)	Black	250.0 (76.2)	3.0 (1.4)
170-03003*	BSP100	1 (25.4)	0.63 (15.9)	1.63 (41.3)	Black	65.0 (19.8)	0.9 (0.4)
170-03044*	BSP100B	1 (25.4)	0.63 (15.9)	1.63 (41.3)	Black	250.0 (76.2)	3.4 (1.5)
170-03004*	BSP1140	1-1/4 (31.8)	0.75 (19.1)	1.75 (44.5)	Black	50.0 (15.2)	0.8 (0.4)
170-03045*	BSP1140B	1-1/4 (31.8)	0.75 (19.1)	1.75 (44.5)	Black	250.0 (76.2)	4.0 (1.8)
170-03005*	BSP1120	1-1/2 (38.1)	1.00 (25.4)	2.13 (54.0)	Black	40.0 (12.2)	0.8 (0.4)
170-03178*	BSP200B	2 (50.8)	1.50 (38.1)	3.50 (88.9)	Black	200.0 (61.0)	6.6 (3.0)

Dimensions are approximate and subject to technical changes. Use Part No. for ordering and Type for specification purposes. Precut lengths available upon request. *This product meets UL standards. Please see appendix for specific file numbers.



Please note! Not all products listed on this page may have this approval. Please check our website for latest approvals.

Routing, Protection and Insulation

Braided Sleeving

Braided Sleeving - General Purpose

General Purpose Expandable Braided Sleeving - Orange

Orange PET braided sleeving is an extremely flexible, general purpose option for bundling and protecting wires and cables in abrasive type applications. Its color makes it ideal for systematic color coding of complex wiring installations. Commonly used to shield cable harnesses in battery powered vehicles, such as hybrid cars, golf carts and light trucks.

Features and Benefits

- Provides easy visual and safety identification of critical wiring components.
- Offers high tensile strength while maintaining extreme flexibility.
- Expands up to 150% of flat diameter for easy installation.
- Does not trap heat and humidity.
- Installs quickly and accommodates expansions and varying cable assembly shapes, reducing installation costs.



MATERIAL	Polyester (PET)
Operating Temperature	-94°F to +257°F (-70°C to +125°C)
Melting Point	+482 °F (+250 °C)
Abrasion Resistance	Medium
Flammability	UL 94 V0



PART NO.	TYPE	Nominal Dia. in. (mm)	Min. Bundle Diameter in. (mm)	Max. Bundle Diameter in. (mm)	Color	Reel Length ft (m)	Weight lbs. (kg)
170-03076*	BSP143B	1/4 (6.4)	0.13 (3.2)	0.44 (11.1)	Orange	1000.0 (304.8)	2.6 (1.2)
170-03077*	BSP123B	1/2 (12.7)	0.25 (6.4)	0.75 (19.1)	Orange	500.0 (152.4)	3.9 (1.8)
170-03078*	BSP343B	3/4 (19.1)	0.50 (12.7)	1.25 (31.8)	Orange	250.0 (76.2)	3.0 (1.4)
170-03079*	BSP103B	1 (25.4)	0.63 (15.9)	1.63 (41.3)	Orange	250.0 (76.2)	3.4 (1.5)
170-03080*	BSP1143B	1-1/4 (31.8)	0.75 (19.1)	1.75 (44.5)	Orange	250.0 (76.2)	4.0 (1.8)
170-03081*	BSP1123B	1-1/2 (38.1)	1.50 (38.1)	3.50 (88.9)	Orange	200.0 (61.0)	6.6 (3.0)

Dimensions are approximate and subject to technical changes. Use Part No. for ordering and Type for specification purposes. Precut lengths available upon request. *This product meets UL standards. Please see appendix for specific file numbers.



Please note! Not all products listed on this page may have this approval. Please check our website for latest approvals.

Braided Sleeving - General Purpose

Fray Resistant Expandable Braided Sleeving

A versatile and economical general purpose sleeving that resists fraying when cut with ordinary scissors. For use in automotive, industrial and computer applications where the wires, cables and hoses being covered endure frequent handling. It is suited for situations where access to a hot knife is either impractical or impossible.

Features and Benefits

- Cuts with scissors without fraying ends enables field installations without need for hot knife.
- Expands to 150% of easy installation and reduced assembly time requirements.
- Material construction offers excellent abrasion and cut-through protection as well as inertness to common chemicals and fungus.



MATERIAL	Polyester (PET)
Operating Temperature	-94°F to +257°F (-70°C to +125°C)
Melting Point	+482 °F (+250 °C)
Abrasion Resistance	Medium
Flammability	UL 94 V0



PART NO.	TYPE	Nominal Dia. in. (mm)	Min. Bundle Diameter in. (mm)	Max. Bundle Diameter in. (mm)	Color	Reel Length ft (m)	Weight lbs. (kg)
170-03123*	BSPSC180	1/8 (3.3)	0.13 (3.2)	0.25 (6.4)	Black	100.0 (30.5)	0.4 (0.2)
170-03035*	BSPSC140	1/4 (6.4)	0.16 (4.0)	0.44 (11.1)	Black	100.0 (30.5)	0.5 (0.2)
170-03012*	BSPSC120	1/2 (12.7)	0.25 (6.4)	0.75 (19.1)	Black	100.0 (30.5)	0.8 (0.4)
170-03013*	BSPSC340	3/4 (19.1)	0.63 (15.9)	1.00 (25.4)	Black	75.0 (22.9)	0.8 (0.4)
170-03014*	BSPSC100	1 (25.4)	0.75 (19.1)	1.19 (30.2)	Black	50.0 (15.2)	0.6 (0.3)
170-03015*	BSPSC1140	1-1/4 (31.8)	1.00 (25.4)	1.50 (38.1)	Black	50.0 (15.2)	0.8 (0.4)
170-03016*	BSPSC1120	1-1/2 (38.1)	1.25 (31.8)	2.00 (50.8)	Black	50.0 (15.2)	0.9 (0.4)

Dimensions are approximate and subject to technical changes. Use Part No. for ordering and Type for specification purposes.

*This product meets UL standards. Please see appendix for specific file numbers.



Please note! Not all products listed on this page may have this approval. Please check our website for latest approvals.

Routing, Protection and Insulation

Braided Sleeving

Braided Sleeving - General Purpose

Heavy-Duty Braided Sleeving

Sleeving made of a tightly woven nylon fabric, slides onto hoses, cables and components to protect them from abrasion and environmental elements, including UV damage. Also protects surrounding surfaces from damage.

Features and Benefits

- Tightly woven fabric bundles and protects cables and hoses from sunlight and abrasion damage; also deflects high pressure hose ruptures.
- Nylon material resists gasoline, salt and other chemicals.
- Cut to size easily with regular scissors.



MATERIAL	Polyamide 6 (PA6)
Operating Temperature	-49°F to +248°F (-45°C to +120°C)
Flammability	Non-Flammable



PART NO.	TYPE	Nominal Dia. in. (mm)	Min. Bundle Diameter in. (mm)	Max. Bundle Diameter in. (mm)	Color	Reel Length ft (m)
170-03203	BSHDWV	1 (25.4)	0.10 (2.54)	0.95 (24.1)	Black	50.0 (15.2)
170-03204		1-1/2 (38.1)	0.10 (2.54)	1.50 (38.1)	Black	50.0 (15.2)
170-03205		2 (50.8)	0.10 (2.54)	2.00 (50.8)	Black	50.0 (15.2)
170-03206		2-1/2 (63.5)	0.10 (2.54)	2.50 (63.5)	Black	50.0 (15.2)
170-03207		3 (76.2)	0.10 (2.54)	3.00 (76.2)	Black	25.0 (7.6)

Dimensions are approximate and subject to technical changes. Use Part No. for ordering and Type for specification purposes.

Braided Sleeving - Flame Retardant

Flame Retardant Expandable Braided Sleeving

A flame retardant polyester sleeving that is resistant to cuts and abrasion, and contains a combustion inhibitor allowing it to achieve a UL flame resistance rating of VW-1. Contains white tracer thread for easy identification. This braided sleeving is ideal for electronic and high tech applications because of its lightweight and durable qualities.

Features and Benefits

- Treated polyester material contains a combustion inhibitor for use in applications where flame retardancy is required.
- Braided design allows sleeving to expand by 150% to accommodate variations in wire bundle and eases installation.
- Contains white tracer thread for simple identification of flame retardancy.



MATERIAL	Polyester (PET)
Operating Temperature	-94°F to +257°F (-70°C to +125°C)
Melting Point	+482 °F (+250 °C)
Abrasion Resistance	Medium
Flammability	UL VW-1



PART NO.	TYPE	Nominal Dia. in. (mm)	Min. Bundle Diameter in. (mm)	Max. Bundle Diameter in. (mm)	Color	Reel Length ft (m)	Weight lbs. (kg)
170-03089*	BSPFR180B	1/8 (3.2)	0.09 (2.4)	0.25 (6.4)	Black	1,000.0 (304.8)	1.6 (0.7)
170-03071*	BSPFR188	1/8 (3.2)	0.09 (2.4)	0.25 (6.4)	Gray	225.0 (68.6)	0.4 (0.2)
170-03006*	BSPFR140	1/4 (6.4)	0.13 (3.2)	0.44 (11.1)	Black	200.0 (61.0)	0.5 (0.2)
170-03090*	BSPFR140B	1/4 (6.4)	0.13 (3.2)	0.44 (11.1)	Black	1,000.0 (304.8)	2.4 (1.1)
170-03072*	BSPFR148	1/4 (6.4)	0.13 (3.2)	0.44 (11.1)	Gray	200.0 (61.0)	0.5 (0.2)
170-03187*	BSPFR380	3/8 (9.5)	0.19 (4.8)	0.50 (12.7)	Black	500.0 (152.4)	2.9 (1.3)
170-03007*	BSPFR120	1/2 (12.7)	0.25 (6.4)	0.75 (19.1)	Black	100.0 (30.5)	0.7 (0.3)
170-03091*	BSPFR120B	1/2 (12.7)	0.25 (6.4)	0.75 (19.1)	Black	500.0 (152.4)	3.6 (1.6)
170-03073*	BSPFR128	1/2 (12.7)	0.25 (6.4)	0.75 (19.1)	Gray	100.0 (30.5)	0.7 (0.3)
170-03008*	BSPFR340	3/4 (19.1)	0.50 (12.7)	1.25 (31.8)	Black	75.0 (22.9)	0.7 (0.3)
170-03092*	BSPFR340B	3/4 (19.1)	0.50 (12.7)	1.25 (31.8)	Black	250.0 (76.2)	2.2 (1.0)
170-03074*	BSPFR348	3/4 (19.1)	0.50 (12.7)	1.25 (31.8)	Gray	75.0 (22.9)	0.7 (0.3)
170-03093*	BSPFR100B	1 (25.4)	0.63 (15.9)	1.63 (41.3)	Black	250.0 (76.2)	3.4 (1.5)
170-03010*	BSPFR1140	1-1/4 (31.8)	0.75 (19.1)	1.75 (44.5)	Black	50.0 (15.2)	0.8 (0.4)
170-03094*	BSPFR1140B	1-1/4 (31.8)	0.75 (19.1)	1.75 (44.5)	Black	250.0 (76.2)	4.0 (1.8)
170-03011*	BSPFR1120	1-1/2 (38.1)	1.00 (25.4)	2.13 (53.9)	Black	40.0 (12.2)	0.8 (0.4)
170-03095*	BSPFR1120B	1-1/2 (38.1)	1.00 (25.4)	2.13 (54.0)	Black	200.0 (61.0)	3.9 (1.8)
170-03066*	BSPFR1128	1-1/2 (38.1)	1.00 (25.4)	2.13 (53.9)	Gray	40.0 (12.2)	0.8 (0.4)

Dimensions are approximate and subject to technical changes. Use Part No. for ordering and Type for specification purposes.

*This product meets UL standards. Please see appendix for specific file numbers.



Please note! Not all products listed on this page may have this approval. Please check our website for latest approvals.

Braided Sleeving - Flame Retardant

Flame Retardant, Fray Resistant Expandable Braided Sleeving

This protective sleeving is self-extinguishing and can be cut with sharp scissors instead of a hot knife for fray-resistant ends. Readily used in the automotive, audiovisual, industrial, wire, cable and computer industries where flame retardancy is required to reduce the likelihood of ignition and/or reduce the rate of flame spread. It is suited for situations where access to a hot knife is either impractical or impossible.

Features and Benefits

- Provides fuller coverage and a medium-to-high abrasion resistance.
- Expands for ease of installation in either the shop or the field.
- Increased braid density coverage provides higher level of abrasion resistance without losing flexibility.
- Contains white tracer thread for simple identification of flame retardancy.
- Treated yarns extinguish quickly and reduces potential flame spread to surrounding components.
- Cuts with ordinary scissors without fraying ends.



MATERIAL	Polyester (PET)
Operating Temperature	-94°F to +257°F (-70°C to +125°C)
Melting Point	+482 °F (+250 °C)
Abrasion Resistance	Medium
Flammability	UL VW-1



PART NO.	TYPE	Nominal Dia. in. (mm)	Min. Bundle Diameter in. (mm)	Max. Bundle Diameter in. (mm)	Color	Reel Length ft (m)	Weight lbs. (kg)
170-03116*	BSSCFR180B	1/8 (3.3)	0.13 (3.2)	0.25 (6.4)	Black	1,000.0 (304.8)	4.0 (1.8)
170-03036*	BSSCFR140	1/4 (6.4)	0.16 (4.0)	0.44 (11.1)	Black	100.0 (30.5)	0.4 (0.2)
170-03117*	BSSCFR140B	1/4 (6.4)	0.16 (4.0)	0.44 (11.1)	Black	1,000.0 (304.8)	4.6 (2.1)
170-03017*	BSSCFR120	1/2 (12.7)	0.25 (6.4)	0.75 (19.1)	Black	100.0 (30.5)	0.8 (0.4)
170-03118*	BSSCFR120B	1/2 (12.7)	0.25 (6.4)	0.75 (19.1)	Black	500.0 (152.4)	4.1 (1.9)
170-03018*	BSSCFR340	3/4 (19.1)	0.63 (15.9)	1.00 (25.4)	Black	75.0 (22.9)	0.8 (0.4)
170-03119*	BSSCFR340B	3/4 (19.1)	0.63 (15.9)	1.00 (25.4)	Black	250.0 (76.2)	2.8 (1.3)
170-03019*	BSSCFR100	1 (25.4)	0.75 (19.1)	1.19 (30.2)	Black	50.0 (15.2)	0.6 (0.3)
170-03120*	BSSCFR100B	1 (25.4)	0.75 (19.1)	1.20 (30.5)	Black	250.0 (76.2)	3.1 (1.4)
170-03020*	BSSCFR1140	1-1/4 (31.8)	1.00 (25.4)	1.50 (38.1)	Black	50.0 (15.2)	0.8 (0.4)
170-03121*	BSSCFR1140B	1-1/4 (31.8)	1.00 (25.4)	1.50 (38.1)	Black	250.0 (76.2)	3.9 (1.8)
170-03021*	BSSCFR1120	1-1/2 (38.1)	1.25 (31.8)	2.00 (50.8)	Black	50.0 (15.2)	0.9 (0.4)
170-03122*	BSSCFR1120B	1-1/2 (38.1)	1.25 (31.8)	2.00 (50.8)	Black	250.0 (76.2)	4.6 (2.1)

Dimensions are approximate and subject to technical changes. Use Part No. for ordering and Type for specification purposes.

*This product meets UL standards. Please see appendix for specific file numbers.



Please note! Not all products listed on this page may have this approval. Please check our website for latest approvals.

Braided Sleeving - Flame Retardant

Hook and Loop Flame Retardant Expandable Braided Sleeving

Flame retardant expandable braided sleeving with hook and loop strip for wrapping around cable assemblies. Color matched hook and loop closure provides an easy on and off installation, as well as convenient access for harness break-outs and when maintenance is necessary. Material is self-extinguishing and complies with UL VW-1 standards.

Features and Benefits

- Flexible construction that conforms to irregular shapes and contours.
- Hook and loop feature wraps over cable bundle allowing future access to cables.
- Easy access saves assembly time and allows for easy splicing or insertion of additional wires.
- Meets military specifications (Mil-202 approved.)
- Cuts easily with a benchmount hot knife.
- Resists chemicals and cleaning solvents.



MATERIAL	Polyester (PET)
Operating Temperature	-94°F to +257°F (-70°C to +125°C)
Melting Point	+482 °F (+250 °C)
Abrasion Resistance	Medium
Flammability	UL VW-1



PART NO.	TYPE	Nominal Dia. in. (mm)	Wall Thickness (WT) in. (mm)	Color	Reel Length ft (m)	Weight lbs. (kg)
170-03153*	BSHKLPR120B	1/2 (12.7)	0.025 (0.635)	Black	100.0 (30.5)	1.3 (0.6)
170-03154*	BSHKLPR340B	3/4 (19.1)	0.025 (0.635)	Black	100.0 (30.5)	1.8 (0.8)
170-03155*	BSHKLPR1140B	1-1/4 (31.8)	0.025 (0.635)	Black	100.0 (30.5)	2.3 (1.0)
170-03156*	BSHKLPR200B	2 (50.8)	0.025 (0.635)	Black	100.0 (30.5)	3.2 (1.5)
170-03157*	BSHKLPR212B	2-1/2 (63.5)	0.025 (0.635)	Black	100.0 (30.5)	3.75 (1.7)

Dimensions are approximate and subject to technical changes. Use Part No. for ordering and Type for specification purposes.

*This product meets UL standards. Please see appendix for specific file numbers.



Please note! Not all products listed on this page may have this approval. Please check our website for latest approvals.

Routing, Protection and Insulation

Braided Sleeving

Braided Sleeving - Flame Retardant

Split Wrap Flame Retardant Expandable Braided Sleeving

Used when flame retardancy is a primary requirement, this protection option incorporates a lateral split which allows the tube to open up to accommodate a variety of bundling requirements. The semi-rigid braid configuration simply closes around the entire installation without the need for any additional fasteners. Split wrap flame retardant braided sleeving is self-extinguishing and complies with UL VW-1 standards where cables exit a wall and need to be managed for an uncluttered, clean appearance.

Features and Benefits

- Split wrap design installs quickly, saving assembly time and future accessibility without disassembly.
- Unique construction retains shape and rigidity throughout operating temperature range.
- Easy open design allows quick assembly, future access, and ability to apply protective sleeving post assembly or post installation situations.
- Self wrapping design eliminates the need for fasteners.
- Provides a greater flexibility than spiralwrap or convoluted tubing.



MATERIAL	Polyester (PET)
Operating Temperature	-94°F to +257°F (-70°C to +125°C)
Melting Point	+446 °F (+230 °C)
Abrasion Resistance	High
Flammability	UL VW-1



PART NO.	TYPE	Nominal Dia. in. (mm)	Max. Bundle Diameter in. (mm)	Color	Reel Length ft (m)	Weight lbs. (kg)
170-03140*	BSSWFR180B	1/8 (3.2)	0.13 (3.2)	Black	400.0 (121.9)	0.8 (0.4)
170-03141*	BSSWFR140B	1/4 (6.4)	0.25 (6.4)	Black	200.0 (61.0)	1.2 (0.5)
170-03142*	BSSWFR120B	1/2 (12.7)	0.50 (12.7)	Black	150.0 (45.7)	2.1 (1.0)
170-03143*	BSSWFR340B	3/4 (19.1)	0.75 (19.1)	Black	100.0 (30.5)	1.6 (0.7)
170-03144*	BSSWFR100B	1 (25.4)	1.00 (25.4)	Black	100.0 (30.5)	2.0 (0.9)
170-03145*	BSSWFR1140B	1-1/4 (31.8)	1.25 (31.8)	Black	75.0 (22.9)	1.8 (0.8)
170-03146*	BSSWFR1120B	1-1/2 (38.1)	1.50 (38.1)	Black	75.0 (22.9)	2.1 (1.0)
170-03147*	BSSWFR200B	2 (50.8)	2.00 (50.8)	Black	50.0 (15.2)	1.8 (0.8)

Dimensions are approximate and subject to technical changes. Use Part No. for ordering and Type for specification purposes.
 *This product meets UL standards. Please see appendix for specific file numbers.



Please note! Not all products listed on this page may have this approval. Please check our website for latest approvals.

Braided Sleeving - High Temperature

Extreme High Temperature Resin Saturated Fiberglass Braided Sleeving

An extremely high-temperature resistant sleeving designed to protect wires and cables subjected to continuous temperature variations, vibration, abrasion, and mechanical stress. Perfect for engine manifolds and exhaust systems or any application where fire and extreme temperatures create a hazard to workforce and equipment.

Features and Benefits

- An exceptionally tough sleeving material which provides thermal protection up to 1,200°F.
- Sturdy construction maintains its tight structure under extreme shaking, scraping, pressure and varying temperature conditions.
- Cuts easily with ordinary scissors for easy application.
- UL VW-1 flammability rating for use in conditions requiring a very high degree of flame resistance.



MATERIAL	Glass Fiber (GF)
Operating Temperature	-94°F to +1202°F (-70°C to +650°C)
Melting Point	+2048 °F (1120 °C)
Abrasion Resistance	Very high
Flammability	UL VW-1



PART NO.	TYPE	Nominal Dia. in. (mm)	Wall Thickness (WT) in. (mm)	Max. Bundle Diameter in. (mm)	Color	Reel Length ft (m)	Weight lbs. (kg)
170-03050*	BSHTFG140B	1/4 (6.4)	0.031 (0.79)	0.38 (9.5)	Black	200.0 (61.0)	4.0 (1.8)
170-03058*	BSHTFG140	1/4 (6.4)	0.031 (0.79)	0.38 (9.5)	Black	50.0 (15.2)	1.0 (0.5)
170-03051*	BSHTFG120B	1/2 (12.7)	0.046 (1.17)	0.75 (19.1)	Black	200.0 (61.0)	9.6 (4.4)
170-03059*	BSHTFG120	1/2 (12.7)	0.046 (1.67)	0.75 (19.1)	Black	50.0 (15.2)	2.4 (1.1)
170-03052*	BSHTFG340B	3/4 (19.1)	0.046 (1.17)	1.13 (28.6)	Black	200.0 (61.0)	12.8 (5.8)
170-03060*	BSHTFG340	3/4 (19.1)	0.046 (1.67)	1.13 (28.6)	Black	50.0 (15.2)	3.2 (1.5)
170-03053*	BSHTFG100B	1 (25.4)	0.057 (1.45)	1.63 (41.3)	Black	100.0 (30.5)	10.5 (4.8)
170-03061*	BSHTFG100	1 (25.4)	0.057 (1.45)	1.63 (41.3)	Black	25.0 (7.6)	2.6 (1.2)

Dimensions are approximate and subject to technical changes. Use Part No. for ordering and Type for specification purposes.

*This product meets UL standards. Please see appendix for specific file numbers.



Please note! Not all products listed on this page may have this approval. Please check our website for latest approvals.

Routing, Protection and Insulation

Braided Sleeving

Braided Sleeving - High Temperature

High Temperature Nomex® Expandable Braided Sleeving

A densely woven aramid fiber sleeving, this soft and flexible material is self extinguishing and can withstand temperatures reaching up to 662°F. Excellent for use in extremely harsh environments including those with exposure to direct flame, high temperatures, as well as Beta, Gamma and X-Ray radiation - in particular, military and aerospace wiring and harnessing applications.

Features and Benefits

- Self extinguishing material does not melt and is unaffected by most acids, and provides excellent thermal stability against direct flame.
- Provides excellent thermal stability.
- Meets FMVSS 302 specifications for use in automotive engineering.
- Material cuts with ordinary scissors which reduces assembly time.

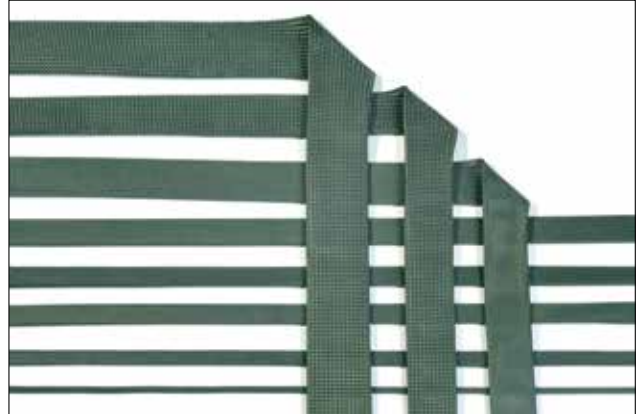

MATERIAL	Polyaramid Polymetaphenylene Isophthalamide
Operating Temperature	-320°F to +662°F (-196 °C to +350 °C)
Abrasion Resistance	Low
Flammability	UL VW-1



PART NO.	TYPE	Nominal Dia. in. (mm)	Min. Bundle Diameter in. (mm)	Max. Bundle Diameter in. (mm)	Color	Reel Length ft (m)	Weight lbs. (kg) (Weight lbs. (kg))
170-03158	BSNMX185B	1/8 (3.1)	0.1 (1.5)	0.3 (6.4)	Green	100.0 (30.5)	0.1 (0.1)
170-03159	BSNMX145B	1/4 (6.4)	0.1 (3.3)	0.3 (7.9)	Green	100.0 (30.5)	0.5 (0.2)
170-03160	BSNMX385B	3/8 (9.7)	0.3 (6.4)	0.5 (12.7)	Green	100.0 (30.5)	0.7 (0.3)
170-03161	BSNMX125B	1/2 (12.7)	0.3 (7.9)	0.6 (16.0)	Green	100.0 (30.5)	0.9 (0.4)
170-03162	BSNMX345B	3/4 (19.1)	0.6 (14.2)	1.0 (25.4)	Green	100.0 (30.5)	1.3 (0.6)
170-03163	BSNMX105B	1 (25.4)	0.8 (19.1)	1.1 (28.7)	Green	100.0 (30.5)	2.4 (1.1)
170-03164	BSNMX1145B	1-1/4 (31.8)	1.0 (25.4)	1.5 (38.1)	Green	100.0 (30.5)	3.5 (1.6)
170-03165	BSNMX1125B	1-1/2 (38.1)	1.3 (31.8)	1.8 (44.4)	Green	100.0 (30.5)	4.0 (1.8)
170-03166	BSNMX1345B	1-3/4 (44.4)	1.5 (38.1)	2.0 (50.8)	Green	100.0 (30.5)	4.8 (2.2)

Dimensions are approximate and subject to technical changes. Use Part No. for ordering and Type for specification purposes. Nomex® is a registered trademark of the DuPont Corporation.

Braided Sleeving - High Temperature

High Temperature Aluminum Laminated Fiberglass - Sleeves

High Temperature Aluminum Laminated Fiberglass Sleeving is a tubular shaped product that combines the protection of bonded aluminum and fiberglass into a single solution that is able to reflect radiant heat away from the sensitive contents inside the tube.

Features and Benefits

- A layer of aluminum provides protection from chemicals, scraping, cuts and abrasion.
- Additional layer also provides insulation barrier for vulnerable wires and cables within high temperature environments.
- Cuts with ordinary scissors for fast, easy application.



MATERIAL	Aluminum (AL), Glass Fiber (GF)
Operating Temperature	-76°F to +491°F (-60°C to +255°C)
Melting Point	+2048 °F (1120 °C)
Flammability	Non-Flammable



PART NO.	TYPE	Nominal Dia. in. (mm)	Wall Thickness (WT) in. (mm)	Max. Bundle Diameter in. (mm)	Color	Reel Length ft (m)	Weight lbs. (kg)
170-03175	BSHTTST38SR	3/8 (9.7)	0.025 (0.64)	0.44 (11.1)	Silver	100.0 (30.5)	2.3 (1.1)
170-03062	BSHTTST12SR	1/2 (12.7)	0.025 (0.64)	0.44 (11.1)	Silver	100.0 (30.5)	2.6 (1.2)
170-03054	BSHTTST12SRB	1/2 (12.7)	0.025 (0.64)	0.44 (11.1)	Silver	250.0 (76.2)	6.4 (2.9)
170-03063	BSHTTST34SR	3/4 (19.1)	0.025 (0.64)	0.69 (17.5)	Silver	100.0 (30.5)	3.5 (1.6)
170-03055	BSHTTST34SRB	3/4 (19.1)	0.025 (0.64)	0.69 (17.4)	Silver	250.0 (76.2)	8.6 (3.9)
170-03064	BSHTTST10SR	1 (25.4)	0.025 (0.64)	0.94 (23.8)	Silver	100.0 (30.5)	4.5 (2.0)
170-03056	BSHTTST10SRB	1 (25.4)	0.025 (0.64)	0.94 (23.8)	Silver	250.0 (76.2)	11.3 (5.1)
170-03065	BSHTTST134SR	1-3/4 (44.5)	0.025 (0.64)	1.69 (42.8)	Silver	50.0 (15.2)	3.7 (1.7)
170-03057	BSHTTST134SRB	1-3/4 (44.5)	0.025 (0.64)	1.69 (42.8)	Silver	100.0 (30.5)	7.4 (3.4)
170-03097	BSHTTST212SR	2-1/2 (63.5)	0.025 (0.64)	2.38 (60.3)	Silver	50.0 (15.2)	5.1 (2.3)

Dimensions are approximate and subject to technical changes. Use Part No. for ordering and Type for specification purposes.
Nominal diameter measures external diameter of sleeving.

Routing, Protection and Insulation

Braided Sleeving

Braided Sleeving - High Temperature

High Temperature Aluminum Laminated Fiberglass Wraps

Aluminum Laminated Fiberglass Wrap sleeving combines the protection of bonded aluminum and fiberglass into a robust solution that deflects radiant heat away from sensitive wires and cables. Wrap-around design allows for fast and easy installation and maintenance. Sold in 4-foot sticks.

Features and Benefits

- A layer of aluminum provides protection from chemicals, scraping, cuts and abrasion.
- Additional layer also provides insulation barrier for vulnerable wires and cables within high temperature environments.
- Cuts with ordinary scissors for fast, easy application.



MATERIAL	Glass fiber with aluminium foil (GF-AL)
Operating Temperature	-76°F to +491°F (-60°C to +255°C)
Melting Point	+2048 °F (1120 °C)
Flammability	Non-Flammable



PART NO.	TYPE	Nominal Dia. in. (mm)	Wall Thickness (WT) in. (mm)	Max. Bundle Diameter in. (mm)	Color	Pkg. Qty.
170-03190	BSHTTSW14SB	1/4 (6.35)	0.042 (1.06)	0.20 (5.1)	Silver	50
170-03191	BSHTTSW38SB	3/8 (9.4)	0.042 (1.06)	0.30 (7.62)	Silver	30
170-03192	BSHTTSW12SB	1/2 (12.70)	0.042 (1.06)	0.45 (11.4)	Silver	25
170-03199	BSHTTSW12LB	1/2 (12.70)	0.042 (1.06)	0.45 (11.4)	Silver	70
170-03193	BSHTTSW58SB	5/8 (16.00)	0.042 (1.06)	0.50 (12.7)	Silver	20
170-03194	BSHTTSW34SB	3/4 (19.05)	0.042 (1.06)	0.65 (16.5)	Silver	15
170-03200	BSHTTSW34LB	3/4 (19.05)	0.042 (1.06)	0.65 (16.5)	Silver	50
170-03201	BSHTTSW1LB	1 (25.40)	0.042 (1.06)	0.95 (24.1)	Silver	30
170-03195	BSHTTSW1SB	1 (25.40)	0.042 (1.06)	0.95 (24.1)	Silver	9
170-03196	BSHTTSW114SB	1-1/4 (31.75)	0.042 (1.06)	1.20 (30.5)	Silver	6
170-03202	BSHTTSW112LB	1-1/2 (38.1)	0.042 (1.06)	1.25 (31.8)	Silver	15
170-03197	BSHTTSW112SB	1-1/2 (38.1)	0.042 (1.06)	1.45 (36.8)	Silver	4
170-03198	BSHTTSW2SB	2 (50.8)	0.042 (1.06)	1.95 (49.5)	Silver	2

Dimensions are approximate and subject to technical changes. Use Part No. for ordering and Type for specification purposes.

Braided Sleeving - Wraps

Split Wrap Woven Braided Sleeving

A lateral split, semi-rigid and flame retardant braided sleeving configuration used when ease of installation and repeat access to wire bundle is required. The lateral split allows the sleeving to open and accommodate a variety of bundling requirements. The 25% edge overlap rolls back over connectors and splices without exposing the bundled wires. More flexible than spiral wraps or convoluted tubing, this product is a fast and easy option for adding protection in post-assembly or post-installation applications.

Features and Benefits

- Split wrap design needs no fasteners and installs quickly, saving assembly time and future accessibility without disassembly.
- Bends to a tight radius without distortion or splitting open.
- Unique construction retains shape and rigidity throughout unrolling.
- Easy open design allows quick access and ability to apply protective sleeving post assembly or post installation situations.



MATERIAL	Polyester (PET)
Operating Temperature	-94°F to +257°F (-70°C to +125°C)
Melting Point	+482 °F (+250 °C)
Abrasion Resistance	Medium
Flammability	UL 94 V0



PART NO.	TYPE	Nominal Dia. in. (mm)	Min. Bundle Diameter in. (mm)	Max. Bundle Diameter in. (mm)	Color	Reel Length ft (m)	Weight lbs. (kg)
170-03181*	BSSWV380B	3/8 (9.5)	0.10 (2.5)	0.38 (9.5)	Black	450.0 (137.2)	6.8 (3.1)
170-03182*	BSSWV120B	1/2 (12.7)	0.10 (2.5)	0.50 (12.7)	Black	300.0 (91.4)	5.4 (2.5)
170-03183*	BSSWV580B	5/8 (15.8)	0.10 (2.5)	0.63 (15.8)	Black	250.0 (76.2)	5.3 (2.4)
170-03184*	BSSWV340B	3/4 (19.1)	0.10 (2.5)	0.75 (19.1)	Black	150.0 (45.7)	3.6 (1.6)
170-03185*	BSSWV100B	1 (25.4)	0.10 (2.5)	1.00 (25.4)	Black	100.0 (30.5)	3.2 (1.5)
170-03186*	BSSWV1120B	1-1/2 (38.1)	0.10 (2.5)	1.50 (38.1)	Black	50.0 (15.2)	2.3 (1.0)

Dimensions are approximate and subject to technical changes. Use Part No. for ordering and Type for specification purposes. Additional sizes available upon request. *This product meets UL standards. Please see appendix for specific file numbers.



Please note! Not all products listed on this page may have this approval. Please check our website for latest approvals.

Routing, Protection and Insulation

Braided Sleeving

Braided Sleeving - Wraps

Split Wrap Braided Sleeving - Black

A bundling and protection option with a lateral split and a semi-rigid braid configuration that is the ideal solution for circumstances where ease of installation is the primary concern. The lateral split allows the sleeving to open up to adjust to the bundling requirement while the 25% edge overlap folds back over to protect the connector or splices. More flexible than spiral wraps or convoluted tubing, this product is a fast and easy option for adding protection in post-assembly or post-installation situations.

Features and Benefits

- Needs no fasteners (i.e., tape, hook and loop, etc.)
- Bends to a tight radius without distortion or splitting open.
- Allows future access without disassembly.
- Withstands cuts, abrasions and tension.

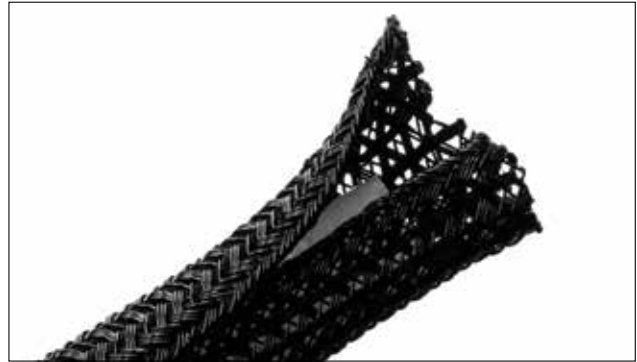

MATERIAL	Polyester (PET)
Operating Temperature	-94°F to +257°F (-70°C to +125°C)
Melting Point	+482 °F (+250 °C)
Abrasion Resistance	Medium
Flammability	UL 94 V0



PART NO.	TYPE	Nominal Dia. in. (mm)	Max. Bundle Diameter in. (mm)	Color	Reel Length ft (m)	Weight lbs. (kg)
170-03124*	BSPSW180B	1/8 (3.2)	0.13 (3.2)	Black	400.0 (121.9)	0.8 (0.4)
170-03132*	BSPSW180LB	1/8 (3.2)	0.13 (3.2)	Black	10,000.0 (3048.8)	20.0 (9.0)
170-03037*	BSPSW140	1/4 (6.4)	0.25 (6.4)	Black	100.0 (30.5)	0.6 (0.3)
170-03125*	BSPSW140B	1/4 (6.4)	0.25 (6.4)	Black	200.0 (61.0)	1.2 (0.5)
170-03133*	BSPSW140LB	1/4 (6.4)	0.25 (6.4)	Black	3,000.0 (914.4)	18.0 (8.2)
170-03213*	BSPSW380LB	3/8 (9.5)	0.38 (9.6)	Black	1,500.0 (457.2)	15.0 (6.8)
170-03024*	BSPSW120	1/2 (12.7)	0.50 (12.7)	Black	75.0 (22.9)	1.1 (0.5)
170-03126*	BSPSW120B	1/2 (12.7)	0.50 (12.7)	Black	150.0 (45.7)	2.1 (1.0)
170-03134*	BSPSW120LB	1/2 (12.7)	0.50 (12.7)	Black	1,200.0 (365.8)	12.0 (5.4)
170-03038*	BSPSW340	3/4 (19.1)	0.75 (19.1)	Black	50.0 (15.2)	0.8 (0.4)
170-03127*	BSPSW340B	3/4 (19.1)	0.75 (19.1)	Black	100.0 (30.5)	1.6 (0.7)
170-03135*	BSPSW340LB	3/4 (19.1)	0.75 (19.1)	Black	500.0 (152.4)	16.8 (7.6)
170-03025*	BSPSW100	1 (25.4)	1.00 (25.4)	Black	50.0 (15.2)	1.0 (0.5)
170-03128*	BSPSW100B	1 (25.4)	1.00 (25.4)	Black	100.0 (30.5)	2.0 (0.9)
170-03136*	BSPSW100LB	1 (25.4)	1.00 (25.4)	Black	400.0 (121.9)	8.0 (3.6)
170-03026*	BSPSW1140	1-1/4 (31.8)	1.25 (31.8)	Black	25.0 (7.6)	0.6 (0.3)
170-03129*	BSPSW1140B	1-1/4 (31.8)	1.25 (31.8)	Black	75.0 (22.9)	1.8 (0.8)
170-03137*	BSPSW1140LB	1-1/4 (31.8)	1.25 (31.8)	Black	250.0 (76.2)	6.0 (2.7)
170-03130*	BSPSW1120B	1-1/2 (38.1)	1.50 (38.1)	Black	75.0 (22.9)	2.1 (1.0)
170-03138*	BSPSW1120LB	1-1/2 (38.1)	1.50 (38.1)	Black	200.0 (61.0)	7.2 (3.3)
170-03131*	BSPSW200B	2 (50.8)	2.00 (50.8)	Black	50.0 (15.2)	1.8 (0.8)
170-03139*	BSPSW200LB	2 (50.8)	2.00 (50.8)	Black	150.0 (45.7)	5.4 (2.4)

Dimensions are approximate and subject to technical changes. Use Part No. for ordering and Type for specification purposes.

*This product meets UL standards. Please see appendix for specific file numbers.



Please note! Not all products listed on this page may have this approval. Please check our website for latest approvals.

Braided Sleeving - Wraps

Split Wrap Braided Sleeving - Orange

Used for safety identification, this bundling and protection option also offers a lateral split and a semi-rigid braid configuration that wraps around the bundle assembly without requiring any fasteners, such as hook and loop, cable ties or tape. Orange color provides identification in electrical powered vehicles.

Features and Benefits

- Split wrap design needs no fasteners and installs quickly, saving assembly time and future accessibility without disassembly.
- Bends to a tight radius without distortion or splitting open.
- Unique construction retains shape and rigidity throughout unrolling.
- Easy open design allows quick access and ability to apply protective sleeving post assembly or post installation situations.



MATERIAL	Polyester (PET)
Operating Temperature	-94°F to +257°F (-70°C to +125°C)
Melting Point	+482 °F (+250 °C)
Abrasion Resistance	Medium
Flammability	UL 94 V0



PART NO.	TYPE	Nominal Dia. in. (mm)	Min. Bundle Diameter in. (mm)	Max. Bundle Diameter in. (mm)	Color	Reel Length ft (m)	Weight lbs. (kg)
170-03082*	BSPSW143B	1/4 (6.4)	0.10 (2.5)	0.25 (6.4)	Orange	200.0 (61.0)	1.2 (0.5)
170-03083*	BSPSW123B	1/2 (12.7)	0.10 (2.5)	0.50 (12.7)	Orange	150.0 (45.7)	2.1 (1.0)
170-03084*	BSPSW343B	3/4 (19.1)	0.10 (2.5)	0.75 (19.1)	Orange	100.0 (30.5)	1.6 (0.7)
170-03085*	BSPSW103B	1 (25.4)	0.10 (2.5)	1.00 (25.4)	Orange	100.0 (30.5)	2.0 (0.9)
170-03086*	BSPSW1143B	1-1/4 (31.8)	0.10 (2.5)	1.25 (31.8)	Orange	75.0 (22.9)	1.8 (0.8)
170-03087*	BSPSW1123B	1-1/2 (38.1)	0.10 (2.5)	1.50 (38.1)	Orange	75.0 (22.9)	2.1 (1.0)
170-03088*	BSPSW203B	2 (50.8)	0.10 (2.5)	2.00 (50.8)	Orange	50.0 (15.2)	1.8 (0.8)

Dimensions are approximate and subject to technical changes. Use Part No. for ordering and Type for specification purposes.

*This product meets UL standards. Please see appendix for specific file numbers.



Please note! Not all products listed on this page may have this approval. Please check our website for latest approvals.

Braided Sleeving - Wraps

Hook and Loop Expandable Braided Sleeving

Designed for the quick and easy management of wires, this expandable sleeving has an internal hook and loop strap that is able to adhere to its outer PET braid, delivering flexibility that allows it to fit around odd-shaped connectors. Its color-matched hook and loop closure provides for an easy on and off installation, as well as instant and convenient access for harness break-outs and networks. The primary application for this sleeving is the wrapping and bunching of cables in a deployed situation or when frequent access to cables is necessary.

Features and Benefits

- Flexible construction that conforms to irregular shapes and contours.
- Hook and loop feature wraps over cable bundle allowing future access to cables.
- Easy access saves assembly time and allows for easy splicing or insertion of additional wires.
- PET yarn construction offers excellent protection against cuts and abrasions.



MATERIAL	Polyester (PET)
Operating Temperature	-94°F to +257°F (-70°C to +125°C)
Melting Point	+482 °F (+250 °C)
Abrasion Resistance	Medium
Flammability	UL 94 V0



PART NO.	TYPE	Nominal Dia. in. (mm)	Wall Thickness (WT) in. (mm)	Color	Reel Length ft (m)	Weight lbs. (kg)
170-03148*	BSHKLP120B	1/2 (12.7)	0.025 (0.635)	Black	100.0 (30.5)	1.3 (0.6)
170-03149*	BSHKLP340B	3/4 (19.1)	0.025 (0.635)	Black	100.0 (30.5)	1.8 (0.8)
170-03150*	BSHKLP1140B	1-1/4 (31.8)	0.025 (0.635)	Black	100.0 (30.5)	2.3 (1.0)
170-03151*	BSHKLP200B	2 (50.8)	0.025 (0.635)	Black	100.0 (30.5)	3.2 (1.5)
170-03152*	BSHKLP212B	2-1/2 (63.5)	0.025 (0.635)	Black	100.0 (30.5)	3.8 (1.7)

Dimensions are approximate and subject to technical changes. Use Part No. for ordering and Type for specification purposes.

*This product meets UL standards. Please see appendix for specific file numbers.



Please note! Not all products listed on this page may have this approval. Please check our website for latest approvals.

Braided Sleeving - Specialty

Polyamide 6.6 Expandable Braided Sleeving - Black

A pliable yet durable nylon sleeve that protects against cuts, abrasion and excessive wear caused by repetitive motion. Used on hoses, pipes, wiring harnesses and cables installed in cars, trucks, military vehicles, trains and industrial equipment. Protects delicate wiring in engine compartments and near exhaust systems or used to organize wires and breakouts in electrical harnesses.

Features and Benefits

- Resists fuels, salts and solvents, gasoline, and other common contaminants.
- Nylon monofilament construction weave offers a tight, 12 mil braid that provides full coverage but will not rot or retain moisture.
- Material performs well in wet applications and where abiding substrate has a smooth surface.
- Expands up to 150% of flat diameter for easy installation.



MATERIAL	Polyamide 6.6 (PA66)
Operating Temperature	-49°F to +302°F (-45°C to +150°C)
Melting Point	+491 °F (+255 °C)
Abrasion Resistance	High
Flammability	Non-Flammable



PART NO.	TYPE	Nominal Dia. in. (mm)	Min. Bundle Diameter in. (mm)	Max. Bundle Diameter in. (mm)	Color	Reel Length ft (m)	Weight lbs. (kg)
170-03209	BSPA66180	1/8 (3.2)	0.1 (2.5)	0.1 (3.1)	Black	225.0 (68.58)	0.6 (0.27)
170-03069	BSPA66140	1/4 (6.4)	0.1 (3.2)	0.4 (9.5)	Black	200.0 (61.0)	0.6 (0.27)
170-03070	BSPA66140B	1/4 (6.4)	0.1 (3.2)	0.4 (9.5)	Black	1000.0 (304.8)	3.1 (1.41)
170-03027	BSPA66120	1/2 (12.7)	0.4 (9.5)	0.8 (19.1)	Black	100.0 (30.4)	1.0 (0.47)
170-03046	BSPA66120B	1/2 (12.7)	0.4 (9.5)	0.8 (19.1)	Black	500.0 (152.4)	5.2 (2.34)
170-03210	BSPA66580	5/8 (15.9)	0.1 (2.5)	0.6 (15.2)	Black	100.0 (30.48)	1.1 (0.5)
170-03028	BSPA66340	3/4 (19.1)	0.5 (12.7)	1.3 (31.8)	Black	75.0 (22.9)	1.1 (0.5)
170-03047	BSPA66340B	3/4 (19.1)	0.5 (12.7)	1.3 (31.8)	Black	250.0 (76.2)	3.7 (1.67)
170-03029	BSPA66100	1 (25.4)	0.6 (15.9)	1.4 (35.0)	Black	50.0 (15.2)	0.8 (0.36)
170-03048	BSPA66100B	1 (25.4)	0.6 (15.9)	1.4 (35.0)	Black	250.0 (76.2)	4.0 (1.81)
170-03030	BSPA661140	1-1/4 (31.8)	0.8 (19.1)	1.5 (38.1)	Black	50.0 (15.2)	0.9 (0.40)
170-03049	BSPA661140B	1-1/4 (31.8)	0.8 (19.1)	1.5 (38.1)	Black	250.0 (76.2)	4.5 (2.04)

Dimensions are approximate and subject to technical changes. Use Part No. for ordering and Type for specification purposes. Precut lengths available upon request.

Routing, Protection and Insulation

Braided Sleeving

Braided Sleeving - Specialty

Polyamide 6.6 Helagaine Expandable Braided Sleeving - Gray

This lightweight protective sleeving is made from heat-stabilized monofilament strands that offer toughness and excellent resistance to abrasion. Despite its sturdy composition, Helagaine is expandable and durable and can easily be applied over irregular surfaces. Helagaine HEGPA66 is particularly suitable for vehicle manufacturing and transportation industry applications.

Features and Benefits

- Strand diameter is approximately 10% larger than that of polyester, allowing for greater expandability.
- Resists fuels, salts and solvents, gasoline, and other common contaminants.
- Performs well in wet applications and where abiding substrate has a smooth surface.



MATERIAL	Polyamide 6.6 (PA66)
Operating Temperature	-76°F to +302°F (-60°C to +150°C)
Melting Point	+491 °F (+255 °C)
Abrasion Resistance	High
Flammability	UL 94 V2



PART NO.	TYPE	Nominal Dia. in. (mm)	Min. Bundle Diameter in. (mm)	Max. Bundle Diameter in. (mm)	Color	Reel Length ft (m)	Weight lbs. (kg)
170-20400	HEGPA6604	5/32 (4.0)	0.1 (3.0)	0.2 (6.0)	Gray	656.0 (200.0)	1.1 (0.5)
170-20600	HEGPA6606	1/4 (6.0)	0.2 (4.0)	0.3 (8.0)	Gray	328.0 (100.0)	1.3 (0.59)
170-20800	HEGPA6608	5/16 (8.0)	0.2 (5.0)	0.4 (10.0)	Gray	328.0 (100.0)	1.1 (0.5)
170-21000	HEGPA6610	3/8 (10.0)	0.3 (7.0)	0.5 (12.0)	Gray	328.0 (100.0)	2.1 (0.95)
170-21200	HEGPA6612	1/2 (12.0)	0.3 (8.0)	0.6 (14.0)	Gray	328.0 (100.0)	2.4 (1.1)
170-22000	HEGPA6620	3/4 (20.0)	0.6 (15.0)	0.9 (23.0)	Gray	164.0 (50.0)	3.1 (1.4)
170-22500	HEGPA6625	1 (25.0)	0.7 (18.0)	1.1 (28.0)	Gray	164.0 (50.0)	3.9 (1.8)
170-23000	HEGPA6630	1-1/4 (30.0)	1.0 (25.0)	1.3 (32.0)	Gray	164.0 (50.0)	4.9 (2.25)
170-25000	HEGPA6650	2 (50.0)	1.6 (40.0)	2.2 (55.0)	Gray	164.0 (50.0)	10.4 (4.7)

Dimensions are approximate and subject to technical changes. Use Part No. for ordering and Type for specification purposes.

Braided Sleeving - Accessories

Merchandising Display Rack

Designed to save space and provide easy access when dispensing braided sleeving, this unit allows for the efficient handling and management of sleeving.

Features and Benefits

- Holds six standard sized spools for easy dispensing and cut to length counter sales.
- Compact design saves space and allows for efficient handling and management of sleeving.
- Constructed of durable ABS plastic.
- Includes mounting hardware.

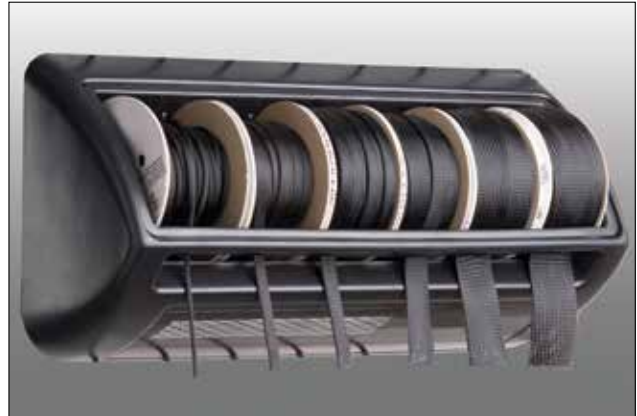

MATERIAL

Acrylonitrile Butadiene Styrene (ABS)

HF ✓

RoHS ✓

PART NO.	TYPE	Width (W) in. (mm)	Height (H) in. (mm)	Depth (D) in. (mm)	Color
170-03031	BSDISPLAY	23.5 (59.7)	6.0 (15.3)	10.0 (25.4)	Black

Dimensions are approximate and subject to technical changes. Use Part No. for ordering and Type for specification purposes.

Braided Sleeving - Accessories

Bench Mount Hot Knife

For best results during sleeving installation, most braided sleeving should be cut with a hot knife.

Features and Benefits

- Hot knife is designed and built durable to withstand production environments.
- 2.5" blades are replaceable.
- Heats to 1,112 °F in 30 seconds.
- 110 volt operation.



PART NO.	TYPE	Color
170-03039	BSBHK	White

Dimensions are approximate and subject to technical changes. Use Part No. for ordering and Type for specification purposes.

Portable Hot Knife

For best results during sleeving installation, most braided sleeving should be cut with a hot knife.

Features and Benefits

- Heats quickly.
- Trigger switch.
- 110 volt operation.
- Blades are replaceable.



PART NO.	TYPE	Color
170-03040	BSPHK	Black

Dimensions are approximate and subject to technical changes. Use Part No. for ordering and Type for specification purposes.

Braided Sleeving - Accessories

Split Wrap Installation Tools

HellermannTyton offers a wide variety of application tools to assist in the installation of wrap-around styles of braided sleeving.

Features and Benefits

- HellermannTyton braided sleeving installation tools are designed for use with split wrap style sleeveings.
- Tools are designed and built durable to withstand production environments.
- Tools can also be used on split-loom convoluted tubing products.



PART NO.	TYPE	Description	Color
170-03067	BSWTOOL14	1/4" Split Wrap Installation Tool	Orange
170-03032	BSWTOOL12	1/2" Split Wrap Installation Tool	Orange
170-03068	BSWTOOL34	3/4" Split Wrap Installation Tool	Orange
170-03033	BSWTOOL1	1" Split Wrap Installation Tool	Orange
170-03034	BSWTOOL114	1-1/4" Split Wrap Installation Tool	Orange

Dimensions are approximate and subject to technical changes. Use Part No. for ordering and Type for specification purposes.

Routing, Protection and Insulation

Helawrap Protective Tubing

Helawrap - General Purpose

HWPP Series - Polypropylene (PP)

The Helawrap Cable Management System is the flexible routing and protection solution for industrial, datacom and electrical applications. Helawrap easily wraps around cables with a "zipper-like" motion to protect against abrasion and mechanical stress caused by movement and bending. A handy application tool is included in every package for faster installations.

Features and Benefits

- Unique open design for easy branch-offs at any point along the harness
- Overwrap formation provides abrasion protection and accommodates multiple bundle configurations
- Flexible construction and design eliminates pinch points and minimizes bending fatigue, making it ideal for applications involving movement and vibration
- Split shape allows for future access without disassembly



MATERIAL	Polypropylene (PP)
Operating Temperature	-76°F to +230°F (-60°C to +110°C)
Melting Point	+284 °F (+140 °C)
Flammability	UL 94 HB

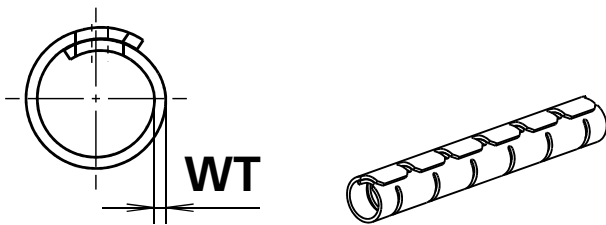

PART NO.	TYPE	Nominal Dia. in. (mm)	Min. Bundle Diameter in. (mm)	Max. Bundle Diameter in. (mm)	Color	Pkg. Qty. ft. (m)	Wall Thickness (WT) in. (mm)	Weight lbs. (kg)
161-64112	HWPP8	5/16 (8.0)	0.31 (7.87)	0.36 (9.14)	Black	100 (30.48)	0.030 (0.75)	1.61 lbs (0.73)
161-64213	HWPP16	5/8 (16.0)	0.51 (12.95)	0.63 (16.0)	Black	100 (30.48)	0.030 (0.80)	2.55 lbs (1.16)
161-64216		5/8 (16.0)	0.51 (12.95)	0.63 (16.0)	White	100 (30.48)	0.030 (0.80)	2.55 lbs (1.16)
161-64310	HWPP20	3/4 (20.0)	0.71 (18.03)	0.83 (21.08)	Black	100 (30.48)	0.037 (0.95)	2.56 lbs (1.18)
161-64311		3/4 (20.0)	0.71 (18.03)	0.83 (21.08)	White	100 (30.48)	0.037 (0.95)	2.56 lbs (1.18)
161-64414	HWPP25	1 (25.0)	0.91 (23.11)	1.06 (26.92)	Black	100 (30.48)	0.041 (1.05)	6.45 lbs (2.93)
161-64416		1 (25.0)	0.91 (23.11)	1.06 (26.92)	White	100 (30.48)	0.041 (1.05)	6.45 lbs (2.93)
161-64507	HWPP30	1-1/4 (30.0)	1.14 (29.0)	1.26 (32.0)	Black	100 (30.48)	0.050 (1.30)	9.58 lbs (4.39)

Dimensions are approximate and subject to technical changes. Use Part No. for ordering and Type for specification purposes.

Helawrap - General Purpose

HWPP Series Convenience Packs - Polypropylene (PP)

The Helawrap Cable Management System is the flexible routing and protection solution for industrial, datacom and electrical applications. Helawrap easily wraps around cables with a "zipper-like" motion to protect against abrasion and mechanical stress caused by movement and bending. A handy application tool is included in every package for faster installations.

Features and Benefits

- Unique open design for easy branch-offs at any point along the harness
- Overwrap formation provides abrasion protection and accommodates multiple bundle configurations
- Flexible construction and design eliminates pinch points and minimizes bending fatigue, making it ideal for applications involving movement and vibration
- Split shape allows for future access without disassembly



MATERIAL	Polypropylene (PP)
Operating Temperature	-76°F to +230°F (-60°C to +110°C)
Melting Point	+284 °F (+140 °C)
Flammability	UL 94 HB



PART NO.	TYPE	Nominal Dia. in. (mm)	Min. Bundle Diameter in. (mm)	Max. Bundle Diameter in. (mm)	Color	Pkg. Qty. ft. (m)	Wall Thickness (WT) in. (mm)	Weight lbs. (kg)
161-62000	HWPP16	5/8 (16.0)	0.51 (12.95)	0.63 (16.0)	Black	10 (3.05)	0.030 (0.75)	0.26 lbs (0.12)
161-64217		5/8 (16.0)	0.51 (12.95)	0.63 (16.0)	White	10 (3.05)	0.030 (0.75)	0.26 lbs (0.12)
161-62001	HWPP25	1 (25.0)	0.91 (23.11)	1.06 (26.92)	Black	10 (3.05)	0.041 (1.05)	0.65 lbs (0.29)
161-64417		1 (25.0)	0.91 (23.11)	1.06 (26.92)	White	10 (3.05)	0.041 (1.05)	0.65 lbs (0.29)

Dimensions are approximate and subject to technical changes. Use Part No. for ordering and Type for specification purposes.

Routing, Protection and Insulation

Helawrap Protective Tubing

Helawrap - Flame Retardant

HWPA6-V0 Series - Polyamide 6 V0 (PA6V0)

The Helawrap Cable Management System is the flexible routing and protection solution for industrial, datacom and electrical applications. Helawrap easily wraps around cables with a "zipper-like" motion to protect against abrasion and mechanical stress caused by movement and bending. A handy application tool is included in every package for faster installations.

Features and Benefits

- Designed for applications that demand high flame retardant materials
- Unique open design allows for easy branch-offs at any point along the harness
- Overwrap formation provides abrasion protection and accommodates multiple bundle configurations
- Flexible construction and design is well suited for applications that involve movement and vibration
- Easy-to-use installation tool makes assembly fast and easy



MATERIAL	Polyamide 6 V0 (PA6V0)
Operating Temperature	-40°F to +194°F (-40°C to +90°C)
Melting Point	+248 °F (+120 °C)
Flammability	UL 94 V0

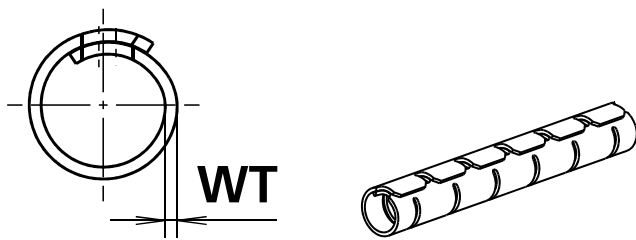

PART NO.	TYPE	Nominal Dia. in. (mm)	Min. Bundle Diameter in. (mm)	Max. Bundle Diameter in. (mm)	Color	Pkg. Qty. ft. (m)	Wall Thickness (WT) in. (mm)	Weight lbs. (kg)
161-63103*	HWPAV08	5/16 (8.0)	0.28 (7.0)	0.36 (9.0)	Black	100 (30.48)	0.030 (0.75)	2.66 lbs (1.21)
161-63203*	HWPAV016	5/8 (16.0)	0.51 (13.0)	0.63 (16.0)	Black	100 (30.48)	0.030 (0.80)	3.95 lbs (1.79)
161-63303*	HWPAV020	3/4 (20.0)	0.71 (18.0)	0.83 (21.0)	Black	100 (30.48)	0.037 (0.95)	5.73 lbs (2.6)
161-63403*	HWPAV025	1 (25.0)	0.91 (23.0)	1.06 (27.0)	Black	100 (30.48)	0.041 (1.05)	8.06 lbs (3.66)
161-63503*	HWPAV030	1-1/4 (31.75)	1.14 (29.0)	1.26 (32.0)	Black	100 (30.48)	0.050 (1.30)	9.83 lbs (4.46)

Dimensions are approximate and subject to technical changes. Use Part No. for ordering and Type for specification purposes.
 *This product meets UL standards. Please see appendix for specific file numbers.

EN 45545-2



Please note! Not all products listed on this page may have this approval. Please check our website for latest approvals.

Helawrap - Clips, Bases, and Tools

Application (Clips)

Helawrap accessory clips and mounting bases can be linked together to bundle, protect and secure any number of cables on industrial machines, as well as in the door area of an automation wiring cabinet where repeated movement occurs. Each clip size sits snugly around the corresponding Helawrap sleeving and holds it firmly in place. With an innovative coupling system, each clip is to be joined to a mounting plate or another clip of any size. Many clips can be linked together and each can turn freely. As a result, any number of differing cable sizes can be bundled together.

Features and Benefits

- An innovative coupling system allows for an unlimited number of bundling combinations.
- Clips can be easily released and reused.
- Clips swivel freely which reduces mechanical stress and eliminates pinch points.
- High Impact Polyamide 6.6 material provides firm fit even in rugged conditions.
- Consists of acrylate adhesive with base of polyurethane foam allowing it to adhere firmly and easily to nearly any surface.



MATERIAL	Polyamide 6.6, high impact modified, heat stabilized (PA66HIRHS)	Flexible Polyvinyl Chloride, cadmium free (PVC)
Operating Temperature	-40°F to +221°F (-40°C to +105°C)	-31°F to +122°F (-35°C to +50°C)
Melting Point	+284 °F (+140 °C)	
Flammability	UL 94 HB	UL 94 V2

HF ✓

RoHS ✓

RoHS ✓

PART NO.	TYPE	Nominal Dia. (D) in. (mm)	Description	Material	Color	Pkg. Qty.	Weight lbs. (kg)
161-64002	HWCLIP08	5/16 (8.0)	Accessory Clip	PA66HIRHS	Black	50	0.19 (0.09)
161-64004	HWCLIP16	5/8 (16.0)	Accessory Clip	PA66HIRHS	Black	50	0.3 (0.14)
161-64006	HWCLIP20	3/4 (20.0)	Accessory Clip	PA66HIRHS	Black	50	0.35 (0.16)
161-64008	HWCLIP25	1 (25.0)	Accessory Clip	PA66HIRHS	Black	50	0.42 (0.19)
161-64010	HWCLIP30	1-1/4 (30.0)	Accessory Clip	PA66HIRHS	Black	50	0.31 (0.23)
201-20010	R1	-	Protective Strap	PVC	Black	500	0.66 (0.3)

Dimensions are approximate and subject to technical changes. Use Part No. for ordering and Type for specification purposes.

Routing, Protection and Insulation

Helawrap Protective Tubing

Helawrap - Clips, Bases and Mounts

Helawrap Bases

With the highly adaptable base plate, cables can be protected alongside most existing structures and installations. The plate can be affixed with screws, with a cable tie threaded through or around the base of the plate, or with an adhesive to provide a long-lasting hold.

Features and Benefits

- Mounting bases can be fixed with screws, cable ties or adhesive.
- Can be used to mount any size HWClip.
- Consists of acrylate adhesive with base of polyurethane foam allowing it to adhere firmly and easily to nearly any surface.



MATERIAL	Polyamide 6.6, high impact modified, heat stabilized (PA66HIRHS)
Operating Temperature	-40°F to +221°F (-40°C to +105°C)
Melting Point	+284 °F (+140 °C)
Flammability	UL 94 HB



PART NO.	TYPE	Adhesive	Color	Pkg. Qty.	Weight lbs. (kg)
161-64014	HWBASE	-	Black	50	0.3 (0.14)
161-64013	HWBASEA	Acrylate with base of polyurethane foam	Black	50	0.4 (0.16)

Dimensions are approximate and subject to technical changes. Use Part No. for ordering and Type for specification purposes.

Helawrap - Clips, Bases, and Tools

Application Tool (HAT)

The Helawrap Applicator Tool enables the user to bundle cable rapidly and effortlessly. The applicator tool has been optimized to glide smoothly and securely through the cover and therefore allow easy insertion of cable into Helawrap. The unique design also allows individual cables to be separated from the applicator tool and branched off through the cover apertures. A tool is included with each Helawrap box. Additional tools can be purchased separately.

Features and Benefits

- Designed to glide smoothly through the Helawrap sleeve for easy insertion of cable bundles
- There is no need to disassemble wire harness when using the Helawrap Application Tool
- Tool is designed for post-installation applications, allowing for unplanned engineering changes to be corrected with ease



MATERIAL	Polyamide 6.6 (PA66)
-----------------	----------------------



PART NO.	TYPE	Nominal Dia. in. (mm)	Color	Pkg. Qty.	Weight lbs. (kg)
161-60001	HAT8	5/16 (8.0)	Blue	10	0.1 (0.035)
161-60002	HAT16	5/8 (16.0)	Blue	10	0.3 (0.122)
161-60003	HAT20	3/4 (20.0)	Blue	10	0.5 (0.204)
161-60004	HAT25	1 (25.0)	Blue	10	0.7 (0.321)
161-60005	HAT30	1-1/4 (30.0)	Blue	10	0.8 (0.348)

Dimensions are approximate and subject to technical changes. Use Part No. for ordering and Type for specification purposes.

Spiralwrap - General Purpose

Spiralwrap in Polyamide 6

HellermannTyton Spiralwrap provides an effective means for routing and securing wires around corners and bends, and helps keep wires out of pinch points within moving panel doors. Spiralwrap is installed using a gapped or butted installation which impacts harnesses flexibility, wire coverage and abrasion resistance. A gapped installation leaves space between the sheathing to accommodate breakouts and adds flexibility to the harness. A butted installation wraps tightly around the bundle to provide greater abrasion resistance and add rigidity. Natural PA6 nylon material is recommended for use within enclosed environments where possibility of fire exists. Black PA6 nylon material is suitable for outdoor applications and can be used in direct sunlight for extended periods of time.

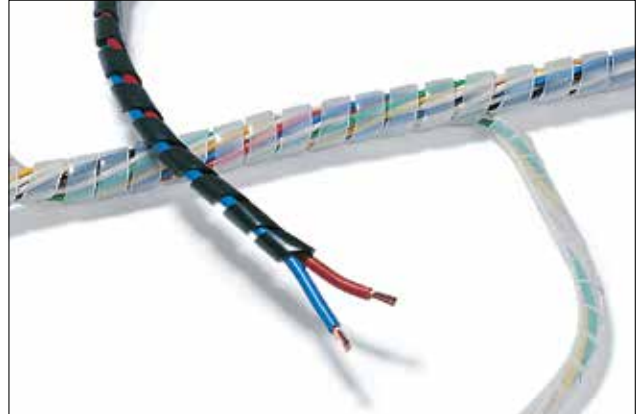

Features and Benefits

- Nylon PA6 is six times stronger than Polyethylene materials.
- Sheathing allows flexible routing and lead-out of cables.
- The inner edges are beveled preventing damage to cables.
- Sheathing is reusable and resistant to most chemicals.

MATERIAL	Polyamide 6 (PA6)
Flammability	Self-Extinguishing
Operating Temperature	-40°F to +250°F (-40°C to +121°C)

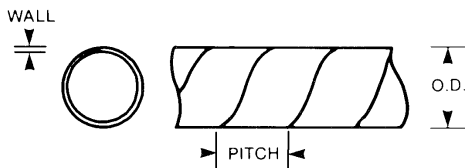

PART NO.	TYPE	Diameter (D) in. (mm)	Wall Thickness (WT) in. (mm)	Pitch in. (mm)	Min. Bundle Diameter in. (mm)	Max. Bundle Diameter in. (mm)	Color	Pkg. Qty.
1N0C*	1N	0.13 (3.18)	0.015 (0.38)	0.19 (4.75)	0.06 (1.60)	0.50 (12.70)	Black	100 ft
1N9C*		0.13 (3.18)	0.015 (0.38)	0.19 (4.75)	0.06 (1.60)	0.50 (12.70)	Natural	100 ft
2N0C*	2N	0.25 (6.35)	0.025 (0.64)	0.38 (9.53)	0.18 (4.75)	2.00 (50.80)	Black	100 ft
2N9C*		0.25 (6.35)	0.025 (0.64)	0.38 (9.53)	0.18 (4.75)	2.00 (50.80)	Natural	100 ft
2.5N0C*	2.5N	0.38 (9.53)	0.035 (0.89)	0.44 (11.13)	0.31 (7.92)	3.00 (76.20)	Black	100 ft
2.5N9C*		0.38 (9.53)	0.035 (0.89)	0.44 (11.13)	0.31 (7.92)	3.00 (76.20)	Natural	100 ft
3N0C*	3N	0.50 (12.70)	0.035 (0.89)	0.50 (12.70)	0.38 (9.52)	4.00 (102.00)	Black	100 ft
3N9C*		0.50 (12.70)	0.035 (0.89)	0.50 (12.70)	0.38 (9.52)	4.00 (102.00)	Natural	100 ft
4N0C*	4N	0.75 (19.05)	0.032 (0.81)	0.75 (19.05)	0.50 (12.70)	5.00 (127.00)	Black	100 ft
4N9C*		0.75 (19.05)	0.032 (0.81)	0.75 (19.05)	0.50 (12.70)	5.00 (127.00)	Natural	100 ft
5N0C*	5N	1.00 (25.40)	0.032 (0.81)	1.00 (25.40)	1.00 (25.40)	7.00 (178.00)	Black	100 ft
5N9C*		1.00 (25.40)	0.032 (0.81)	1.00 (25.40)	1.00 (25.40)	7.00 (178.00)	Natural	100 ft

Dimensions are approximate and subject to technical changes. Use Part No. for ordering and Type for specification purposes.

*This product meets UL standards. Please see appendix for specific file numbers.



Please note! Not all products listed on this page may have this approval. Please check our website for latest approvals.

Spiralwrap - General Purpose

Polyethylene Spiralwrap

HellermannTyton's Spiralwrap protective sheathing provides cable protection and flexible routing. Spiralwrap is wrapped around a group of cables to shield and organize. Polyethylene is ideal for general applications that are not affected by ordinary solvents. Ultraviolet resistant black polyethylene is for outdoor use. It has the same qualities as clear polyethylene, but also contains an ultraviolet absorber which permits it to be used in direct sunlight for long periods of time. Available in colors.

Features and Benefits

- Sheathing allows flexible routing and lead-out of cables.
- The inner edges are beveled preventing damage to cables.
- Sheathing is reusable and resistant to most chemicals.



MATERIAL	Polyethylene (PE)
Flammability	Flammable
Operating Temperature	-76°F to +190°F (-60°C to +88°C)

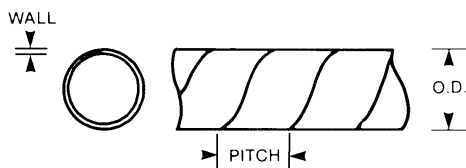

PART NO.	TYPE	Diameter (D) in. (mm)	Wall Thickness (WT) in. (mm)	Pitch in. (mm)	Min. Bundle Diameter in. (mm)	Max. Bundle Diameter in. (mm)	Color	Pkg. Qty.
1NFP0C*	1NFP	0.13 (3.18)	0.032 (0.81)	0.19 (4.75)	0.06 (1.60)	0.50 (12.70)	Black	100 ft
1NFP9C*		0.13 (3.18)	0.032 (0.81)	0.19 (4.75)	0.06 (1.60)	0.50 (12.70)	Natural	100 ft
2NFP0C*	2NFP	0.25 (6.35)	0.045 (1.14)	0.38 (9.53)	0.18 (4.75)	2.00 (50.80)	Black	100 ft
2NFP9C*		0.25 (6.35)	0.045 (1.14)	0.38 (9.53)	0.18 (4.75)	2.00 (50.80)	Natural	100 ft
2.5NFP0C*	2.5NFP	0.38 (9.53)	0.052 (1.32)	0.44 (11.13)	0.31 (7.92)	3.00 (76.20)	Black	100 ft
2.5NFP9C*		0.38 (9.53)	0.052 (1.32)	0.44 (11.13)	0.31 (7.92)	3.00 (76.20)	Natural	100 ft
3NFP0C*	3NFP	0.50 (12.70)	0.062 (1.57)	0.56 (14.30)	0.38 (9.52)	4.00 (102.00)	Black	100 ft
3NFP9C*		0.50 (12.70)	0.062 (1.57)	0.56 (14.30)	0.38 (9.52)	4.00 (102.00)	Natural	100 ft
4NFP0C*	4NFP	0.75 (19.05)	0.065 (1.65)	0.75 (19.05)	0.75 (19.10)	5.00 (127.00)	Black	100 ft
4NFP9C*		0.75 (19.05)	0.065 (1.65)	0.75 (19.05)	0.75 (19.10)	5.00 (127.00)	Natural	100 ft
5NFP0C*	5NFP	1.00 (25.40)	0.095 (2.41)	1.00 (25.40)	1.00 (25.40)	7.00 (178.00)	Black	100 ft
5NFP9C*		1.00 (25.40)	0.095 (2.41)	1.00 (25.40)	1.00 (25.40)	7.00 (178.00)	Natural	100 ft

Dimensions are approximate and subject to technical changes. Use Part No. for ordering and Type for specification purposes.

*This product meets UL standards. Please see appendix for specific file numbers.



Please note! Not all products listed on this page may have this approval. Please check our website for latest approvals.

Routing, Protection and Insulation

Spiralwrap

Spiralwrap - Special Materials

Flame Retardant Polyethylene Spiralwrap

HellermannTyton's Spiralwrap protective sheathing provides cable protection and flexible routing. Spiralwrap is wrapped around a group of cables to shield and organize. Suitable for applications requiring a self-extinguishing material. Lower cost than polyamide 6 or Teflon materials. Natural color is milky white.

Features and Benefits

- Sheathing allows flexible routing and lead-out of cables
- The inner edges are beveled preventing damage to cables
- Sheathing is reusable and resistant to most chemicals

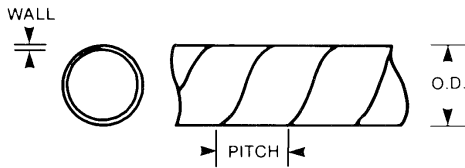

MATERIAL	Polyethylene, flame retardant (PE-FR)
Flammability	UL 94 V2
Operating Temperature	-4°F to +176°F (-20°C to +80°C)



PART NO.	TYPE	Diameter (D) in. (mm)	Wall Thickness (WT) in. (mm)	Pitch in. (mm)	Min. Bundle Diameter in. (mm)	Max. Bundle Diameter in. (mm)	Color	Pkg. Qty.
1FRP0C	1FRP	0.13 (3.18)	0.032 (0.81)	0.19 (4.75)	0.06 (1.6)	0.50 (12.7)	Black	100 ft
1FRP9C*		0.13 (3.18)	0.032 (0.81)	0.19 (4.75)	0.06 (1.6)	0.50 (12.7)	Natural	100 ft
2FRP0C*	2FRP	0.25 (6.35)	0.045 (1.14)	0.38 (9.53)	0.18 (4.75)	2.00 (50.8)	Black	100 ft
2FRP9C*		0.25 (6.35)	0.045 (1.14)	0.38 (9.53)	0.18 (4.75)	2.00 (50.8)	Natural	100 ft
2.5FRP0C	2.5FRP	0.38 (9.53)	0.052 (0.81)	0.44 (11.13)	0.31 (7.92)	3.00 (76.2)	Black	100 ft
2.5FRP9C*		0.38 (9.53)	0.052 (0.81)	0.44 (11.13)	0.31 (7.92)	3.00 (76.2)	Natural	100 ft
3FRP0C*	3FRP	0.50 (12.7)	0.062 (1.57)	0.56 (14.3)	0.37 (9.52)	4.00 (102.0)	Black	100 ft
3FRP9C*		0.50 (12.7)	0.062 (1.57)	0.56 (14.3)	0.37 (9.52)	4.00 (102.0)	Natural	100 ft
4FRP0C	4FRP	0.75 (19.05)	0.065 (1.65)	0.75 (19.05)	0.75 (19.05)	5.00 (127.0)	Black	100 ft
4FRP9C*		0.75 (19.05)	0.065 (1.65)	0.75 (19.05)	0.75 (19.05)	5.00 (127.0)	Natural	100 ft
161-05084	5FRP	1.00 (25.4)	0.095 (2.41)	1.00 (25.4)	1.00 (25.4)	7.00 (178.0)	Black	100 ft
5FRP9C*		1.00 (25.4)	0.095 (2.41)	1.00 (25.4)	1.00 (25.4)	7.00 (178.0)	Natural	100 ft

Dimensions are approximate and subject to technical changes. Use Part No. for ordering and Type for specification purposes.

*This product meets UL standards. Please see appendix for specific file numbers.



Please note! Not all products listed on this page may have this approval. Please check our website for latest approvals.

Spiralwrap - Special Materials

Spiralwrap in Polytetrafluoroethylene-Teflon

HellermannTyton's Spiralwrap protective sheathing provides cable protection and flexible routing. Spiralwrap is wrapped around a group of cables to shield and organize. Polytetrafluoroethylene-Teflon (PTFE) offers the widest operating temperature range of any material. It's chemically inert and nonflammable. Natural color is milky white. Available by special order in black and colors.

Features and Benefits

- Sheathing allows flexible routing and lead-out of cables
- The inner edges are beveled preventing damage to cables
- Sheathing is reusable and resistant to most chemicals
- Spiralwrap is U.L. Recognized



MATERIAL	Polytetrafluoroethylene -Teflon (PTFE)
Flammability	Non-Flammable
Operating Temperature	-449°F to +500°F (-267°C to +260°C)

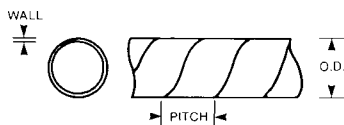

PART NO.	TYPE	Diameter (D) in. (mm)	Wall Thickness (WT) in. (mm)	Pitch in. (mm)	Min. Bundle Diameter in. (mm)	Max. Bundle Diameter in. (mm)	Color	Pkg. Qty.
1P9C*	1P	0.13 (3.18)	0.020 (0.51)	0.19 (4.75)	0.06 (1.6)	0.50 (12.7)	Natural	100 ft
2P9C*	2P	0.25 (6.35)	0.030 (0.76)	0.38 (9.53)	0.18 (4.75)	2.00 (50.8)	Natural	100 ft
2.5P9C*	2.5P	0.38 (9.53)	0.030 (0.76)	0.44 (11.13)	0.31 (7.92)	2.50 (63.5)	Natural	100 ft
3P9C*	3P	0.50 (12.7)	0.030 (0.76)	0.50 (12.7)	0.38 (9.52)	3.00 (76.2)	Natural	100 ft
4P9C*	4P	0.75 (19.05)	0.032 (0.81)	0.75 (19.05)	0.50 (12.7)	4.00 (102.0)	Natural	100 ft
5P9C*	5P	1.00 (25.4)	0.040 (1.02)	1.00 (25.4)	0.75 (19.1)	5.00 (127.0)	Natural	100 ft

Dimensions are approximate and subject to technical changes. Use Part No. for ordering and Type for specification purposes.

*This product meets UL standards. Please see appendix for specific file numbers.



Please note! Not all products listed on this page may have this approval. Please check our website for latest approvals.

No compromises when it comes to selecting flexible wire and cable protection.

Get bundle protection that always fits. For every unique application and the varying environmental conditions, there's HelaGuard.

Choose the conduit and fittings that provide the required levels of flexibility, impact resistance, ingress protection ... whatever the job calls for.

MADE FOR REAL[®]

For more information visit:
[www.hellermann.tyton.com/
HelaGuardConduitandFittings](http://www.hellermann.tyton.com/HelaGuardConduitandFittings)



Split Loom - General Purpose

Convolved Tubing in PA6

Convolved tubing provides an efficient method of routing and protecting wire harness assemblies, while reducing the chance of installation damage. It also can serve to protect valuable wiring circuits. HellermannTyton's convolved tubing offers excellent protection against automotive fluids, vibration wear, water, snow, ice, and the effects of heat or cold on cables and wires. Available in standard, bulk, and dispenser box packaging. Material is slit.

Features and Benefits

- Durable tubing provides protection of wire harness from friction, vibration, fraying and puncture.
- Tubing protects cables and wires against automotive fluids and vibration wear.
- Weather resistant material provides protection against water, snow, ice, and the effects of heat or cold.
- Nylon material is formulated to withstand high temperatures.
- Lateral slit allows fast and easy insertion of wires.



MATERIAL	Polyamide 6 (PA6)
Operating Temperature	-40°F to +300°F (-40°C to +149°C)
Flammability	UL 94 HB

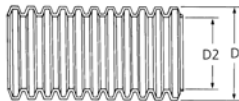

PART NO.	TYPE	Nominal Dia. in. (mm)	Diameter (D) in. (mm)	Diameter (D2) in. (mm)	Wall Thickness (WT) in. (mm)	Pkg. Qty. Feet
CTN140STD	CTN140	0.25 (6.4)	0.40 (10.1)	0.28 (7.0)	0.004 (0.10)	3200
CTN140		0.25 (6.4)	0.40 (10.1)	0.28 (7.0)	0.004 (0.10)	28000
CTN380STD	CTN380	0.38 (9.5)	0.53 (13.4)	0.38 (9.7)	0.005 (0.13)	1900
CTN380		0.38 (9.5)	0.53 (13.4)	0.38 (9.7)	0.005 (0.13)	15000
CTN120STD	CTN120	0.50 (12.7)	0.70 (17.8)	0.52 (13.1)	0.005 (0.13)	1100
CTN120		0.50 (12.7)	0.70 (17.8)	0.52 (13.1)	0.005 (0.13)	8500
169-60024	CTN580 UNSLIT	0.63 (15.9)	0.84 (21.3)	0.64 (16.2)	0.005 (0.13)	700
CTN580STD	CTN580	0.63 (15.9)	0.84 (21.3)	0.64 (16.2)	0.005 (0.13)	800
CTN340STD	CTN340	0.75 (19.1)	0.99 (25.1)	0.76 (19.3)	0.005 (0.13)	550
CTN340		0.75 (19.1)	0.99 (25.1)	0.76 (19.3)	0.005 (0.13)	4200
CTN10STD	CTN10	1.00 (25.4)	1.32 (33.5)	1.06 (26.9)	0.005 (0.15)	300
CTN10		1.00 (25.4)	1.32 (33.5)	1.06 (26.9)	0.005 (0.15)	2250
CTN1140STD	CTN1140	1.25 (31.8)	1.50 (38.1)	1.26 (31.9)	0.006 (0.15)	250
CTN1140		1.25 (31.8)	1.50 (38.1)	1.26 (31.9)	0.006 (0.15)	1800
CTN1120STD	CTN1120	1.50 (38.1)	1.95 (49.5)	1.65 (41.8)	0.006 (0.15)	150
CTN1120		1.50 (38.1)	1.95 (49.5)	1.65 (41.8)	0.006 (0.15)	1000
CTN20STD	CTN20	2.00 (50.8)	2.39 (60.7)	2.04 (51.8)	0.011 (0.28)	100

Dimensions are approximate and subject to technical changes. Use Part No. for ordering and Type for specification purposes. Material is slit unless noted in Type column.

Routing, Protection and Insulation

Convoluted Tubing

Split Loom - General Purpose

Convuluted Tubing in PA6 - Dispenser Boxes

Convoluted tubing provides an efficient method of routing and protecting wire harness assemblies, while reducing the chance of installation damage. It also can serve to protect valuable wiring circuits. HellermannTyton's convoluted tubing offers excellent protection against automotive fluids, vibration wear, water, snow, ice, and the effects of heat or cold on cables and wires. Available in standard, bulk, and dispenser box packaging. Material is slit.

Features and Benefits

- Durable tubing provides protection of wire harness from friction, vibration, fraying and puncture.
- Tubing protects cables and wires against automotive fluids and vibration wear.
- Weather resistant material provides protection against water, snow, ice, and the effects of heat or cold.
- Nylon material is formulated to withstand high temperatures.
- Lateral slit allows fast and easy insertion of wires.



MATERIAL	Polyamide 6 (PA6)
Operating Temperature	-40°F to +300°F (-40°C to +149°C)
Flammability	UL 94 HB

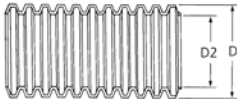

PART NO.	TYPE	Nominal Dia. in. (mm)	Diameter (D) in. (mm)	Diameter (D2) in. (mm)	Wall Thickness (WT) in. (mm)	Pkg. Qty. Feet
169-60022	CTN140	0.25 (6.4)	0.40 (10.1)	0.28 (7.0)	0.004 (0.10)	100
169-60018	CTN380	0.38 (9.5)	0.53 (13.4)	0.38 (9.7)	0.005 (0.13)	100
169-60019	CTN120	0.50 (12.7)	0.70 (17.8)	0.52 (13.1)	0.005 (0.13)	100
169-60020	CTN340	0.75 (19.1)	0.99 (25.1)	0.76 (19.3)	0.005 (0.13)	100
169-60021	CTN10	1.00 (25.4)	1.32 (33.5)	1.06 (26.9)	0.006 (0.15)	50

Dimensions are approximate and subject to technical changes. Use Part No. for ordering and Type for specification purposes. Material is slit unless noted in Type column.

Split Loom - General Purpose

Convolved Tubing in PE

Convolved tubing provides an efficient method of routing and protecting wire harness assemblies, while reducing the chance of installation damage. It also can serve to protect valuable wiring circuits. HellermannTyton's convolved tubing offers excellent protection against automotive fluids, vibration wear, water, snow, ice, and the effects of heat and cold on cables and wires. Available in standard and bulk packaging. Also available in colors.

Features and Benefits

- Split side is ideal for applications where braided tubing or spiral wrap may be difficult to install.
- Tubing provides full coverage where spiral wrap or other coverings may not be suitable.
- Tubing offers excellent protection against automotive fluids, vibration wear, water, snow, ice, and the effects of heat and cold on cables and wires.



MATERIAL	Polyethylene (PE)
Operating Temperature	-40°F to +199°F (-40°C to +93°C)
Flammability	UL 94 V2

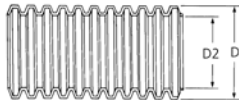

PART NO.	TYPE	Nominal Dia. in. (mm)	Diameter (D) in. (mm)	Diameter (D2) in. (mm)	Wall Thickness (WT) in. (mm)	Pkg. Qty. Feet
CTP140STD	CTP140	0.25 (6.4)	0.40 (10.1)	0.28 (7.0)	0.004 (0.10)	3200
CTP140		0.25 (6.4)	0.40 (10.1)	0.28 (7.0)	0.004 (0.10)	25000
CTP380STD	CTP380	0.38 (9.5)	0.53 (13.4)	0.38 (9.7)	0.005 (0.13)	1900
CTP380		0.38 (9.5)	0.53 (13.4)	0.38 (9.7)	0.005 (0.13)	15000
CTP120STD	CTP120	0.50 (12.7)	0.70 (17.8)	0.52 (13.1)	0.005 (0.13)	1100
CTP120		0.50 (12.7)	0.70 (17.8)	0.52 (13.1)	0.005 (0.13)	8500
CTP580STD	CTP580	0.63 (15.9)	0.84 (21.3)	0.64 (16.2)	0.005 (0.13)	800
CTP580		0.63 (15.9)	0.84 (21.3)	0.64 (16.2)	0.005 (0.13)	5500
CTP340STD	CTP340	0.75 (19.1)	0.99 (25.1)	0.76 (19.3)	0.005 (0.13)	550
CTP340		0.75 (19.1)	0.99 (25.1)	0.76 (19.3)	0.005 (0.13)	4200
CTP10STD	CTP10	1.00 (25.4)	1.32 (33.5)	1.06 (26.9)	0.005 (0.13)	300
CTP10		1.00 (25.4)	1.32 (33.5)	1.06 (26.9)	0.005 (0.13)	2250
CTP1140STD	CTP1140	1.25 (31.8)	1.50 (38.1)	1.26 (31.9)	0.006 (0.15)	250
CTP1140		1.25 (31.8)	1.50 (38.1)	1.26 (31.9)	0.006 (0.15)	1800
CTP1120STD	CTP1120	1.50 (38.1)	1.95 (49.5)	1.65 (41.8)	0.006 (0.15)	150
CTP1120		1.50 (38.1)	1.95 (49.5)	1.65 (41.8)	0.006 (0.15)	1000
CTP20STD	CTP20	2.00 (50.8)	2.39 (60.7)	2.04 (51.8)	0.011 (0.28)	100

Dimensions are approximate and subject to technical changes. Use Part No. for ordering and Type for specification purposes.

Standard tubing is slit. Unslit is available upon request, please contact HellermannTyton for precut length requirements. Colors are available dependent upon volume requirements.

Routing, Protection and Insulation

Convolved Tubing

Split Loom - General Purpose

Convolved Tubing in PEUV

HellermannTyton's Convolved Tubing, also known as Split Loom Tubing, provides an efficient method of routing and protecting wire harness assemblies, while reducing the chance of installation damage. With a split down the side where you can insert your wire harness, you can easily install Convolved Tubing without removal of the entire assembly. It can also serve to protect valuable hoses and cables. Convolved tubing offers excellent protection against vibration wear, water, snow, ice and the effects of heat, cold and sunlight on cables and wires. The PEUV material provides additional protection against UV radiation for long-term outdoor use.

Features and Benefits

- Split side is ideal for applications where braided tubing or spiral wrap may be difficult to install.
- Tubing provides full coverage where spiral wrap or other coverings may not be suitable.
- Convolved profile provides resistance to crushing, impact, and abrasion.



MATERIAL	Polyethylene, UV-resistant (PEUV)
Operating Temperature	-40°F to +199°F (-40°C to +93°C)
Flammability	UL 94 HB

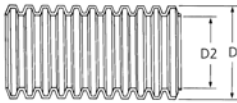

PART NO.	TYPE	Nominal Dia. in. (mm)	Diameter (D) in. (mm)	Diameter (D2) in. (mm)	Wall Thickness (WT) in. (mm)	Pkg. Qty. Feet
904-00358	CTPUV340	0.75 (19.1)	0.99 (25.1)	0.76 (19.3)	0.005 (0.13)	4200
904-00359	CTPUV10	1.00 (25.4)	1.32 (33.5)	1.06 (26.9)	0.006 (0.15)	2250
904-00357	CTPUV1120	1.50 (38.1)	1.65 (41.8)	1.65 (41.8)	0.006 (0.15)	1000
904-00921	CTPUV20	2.00 (50.8)	2.39 (60.7)	2.04 (51.8)	0.011 (0.28)	800

Dimensions are approximate and subject to technical changes. Use Part No. for ordering and Type for specification purposes.

Grommet Edging - General Purpose

Flexiform Edge Protection Grommet Strip - Polyamide 6 Grommet

HellermannTyton's Flexiform grommet is a unique, continuous wire protection product which fits easily in all shapes and sizes of holes without the aid of tools or adhesives. Since Flexiform can be cut to the right length with scissors, it eliminates waste, helping keep grommet stock to a minimum. HellermannTyton's Flexiform grommet can be used on any type of material including wood, steel, aluminum, plexiglass, and glass.

Features and Benefits

- Can be cut to length with scissors, eliminating waste and keeping stock to a minimum.

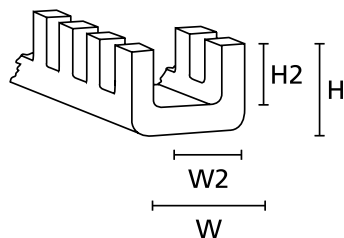

MATERIAL	Polyamide 6 (PA6)
Color	Natural
Operating Temperature	-76°F to +203°F (-60°C to +95°C)
Flammability	UL 94 HB



PART NO.	TYPE	Min. Panel Thickness in. (mm)	Max. Panel Thickness in. (mm)	Width (W) in. (mm)	Width (W2) in. (mm)	Height (H) in. (mm)	Height (H2) in. (mm)	Pkg. Qty.
FHA	G51NA	0.016 (0.40)	0.051 (1.30)	0.15 (3.9)	0.059 (1.5)	0.17 (4.3)	0.11 (2.7)	82 ft
FHB	G51NB	0.051 (1.30)	0.083 (2.10)	0.18 (4.6)	0.094 (2.4)	0.17 (4.3)	0.11 (2.7)	82 ft
FHC	G51NC	0.083 (2.10)	0.13 (3.30)	0.22 (5.7)	0.138 (3.5)	0.17 (4.3)	0.11 (2.7)	82 ft
FHD	G51ND	0.13 (3.30)	0.189 (4.80)	0.33 (8.4)	0.201 (5.1)	0.24 (6.2)	0.17 (4.3)	82 ft
FHE	G51NE	0.189 (4.80)	0.256 (6.50)	0.39 (9.9)	0.264 (6.7)	0.25 (6.4)	0.18 (4.5)	82 ft
FHF	G51NF	0.256 (6.50)	0.319 (8.10)	0.45 (11.4)	0.327 (8.3)	0.27 (6.8)	0.19 (4.8)	82 ft
FHG	G51NG	0.319 (8.10)	0.382 (9.70)	0.52 (13.2)	0.398 (10.1)	0.27 (6.8)	0.19 (4.8)	82 ft

Dimensions are approximate and subject to technical changes. Use Part No. for ordering and Type for specification purposes.



Please note! Not all products listed on this page may have this approval. Please check our website for latest approvals.

Routing, Protection and Insulation

Grommet Edging

Grommet Edging - General Purpose

Flexiform Edge Protection Grommet Strip - Polyethylene Grommet

HellermannTyton's Flexiform grommet is a unique, continuous wire protection product which fits easily in all shapes and sizes of holes without the aid of tools or adhesives. Since Flexiform can be cut to the right length with scissors, it eliminates waste, helping keep grommet stock to a minimum. HellermannTyton's Flexiform grommet can be used on any type of material including wood, steel, aluminum, plexiglass, and glass.

Features and Benefits

- Can be cut to length with scissors, eliminating waste and keeping stock to a minimum.

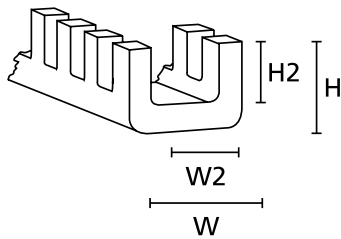

MATERIAL	Polyethylene (PE)
Color	Natural
Operating Temperature	-22°F to +176°F (-30°C to +80°C)
Flammability	UL 94 HB



PART NO.	TYPE	Min. Panel Thickness in. (mm)	Max. Panel Thickness in. (mm)	Width (W) in. (mm)	Width (W2) in. (mm)	Height (H) in. (mm)	Height (H2) in. (mm)	Pkg. Qty.
FPA	G51PA	0.016 (0.40)	0.051 (1.30)	0.15 (3.9)	0.059 (1.5)	0.17 (4.3)	0.11 (2.7)	82 ft
FPA	G51PAA	0.016 (0.40)	0.035 (0.90)	0.09 (2.3)	0.035 (0.9)	0.11 (2.7)	0.07 (1.8)	82 ft
FPB	G51PB	0.051 (1.30)	0.083 (2.10)	0.18 (4.6)	0.094 (2.4)	0.17 (4.3)	0.11 (2.7)	82 ft
FPC	G51PC	0.083 (2.10)	0.13 (3.30)	0.22 (5.7)	0.138 (3.5)	0.17 (4.3)	0.11 (2.7)	82 ft
FPD	G51PD	0.13 (3.30)	0.189 (4.80)	0.33 (8.4)	0.201 (5.1)	0.24 (6.2)	0.17 (4.3)	82 ft
FPE	G51PE	0.189 (4.80)	0.256 (6.50)	0.39 (9.9)	0.264 (6.7)	0.25 (6.4)	0.18 (4.5)	82 ft
FPF	G51PF	0.256 (6.50)	0.319 (8.10)	0.45 (11.4)	0.327 (8.3)	0.27 (6.8)	0.19 (4.8)	82 ft
FPG	G51PG	0.319 (8.10)	0.382 (9.70)	0.52 (13.2)	0.398 (10.1)	0.27 (6.8)	0.19 (4.8)	82 ft
FPH	G51PH	0.382 (9.70)	0.508 (12.90)	0.65 (16.4)	0.520 (13.2)	0.27 (6.8)	0.19 (4.8)	82 ft

Dimensions are approximate and subject to technical changes. Use Part No. for ordering and Type for specification purposes.

Grommet Edging - Special Materials

Flexiform Edge Protection Grommet Strip - PTFE Grommet

HellermannTyton's Flexiform grommet is a unique, continuous wire protection product which fits easily in all shapes and sizes of holes without the aid of tools or adhesives. Since Flexiform can be cut to the right length with scissors, it eliminates waste, helping keep grommet stock to a minimum. HellermannTyton's Flexiform grommet can be used on any type of material including wood, steel, aluminum, plexiglass, and glass.

Features and Benefits

- Can be cut to length with scissors, eliminating waste and keeping stock to a minimum.

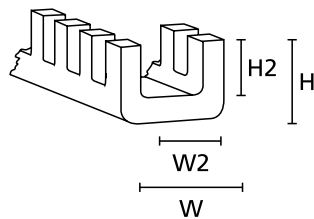

MATERIAL	Polytetrafluoroethylene -Teflon (PTFE)
Color	Natural
Operating Temperature	-76°F to +500°F (-60°C to +260°C)
Flammability	UL 94 V0



PART NO.	TYPE	Min. Panel Thickness in. (mm)	Max. Panel Thickness in. (mm)	Width (W) in. (mm)	Width (W2) in. (mm)	Height (H) in. (mm)	Height (H2) in. (mm)	Pkg. Qty.
FTA	G51TA	0.016 (0.40)	0.051 (1.30)	0.15 (3.9)	0.059 (1.5)	0.17 (4.3)	0.11 (2.7)	9.7 ft
FTB	G51TB	0.051 (1.30)	0.083 (2.10)	0.18 (4.6)	0.094 (2.4)	0.17 (4.3)	0.11 (2.7)	9.7 ft
251-30309	G51TC	0.083 (2.10)	0.13 (3.30)	0.22 (5.7)	0.138 (3.5)	0.17 (4.3)	0.11 (2.7)	9.7 ft
251-30409	G51TD	0.13 (3.30)	0.189 (4.80)	0.33 (8.4)	0.201 (5.1)	0.24 (6.2)	0.17 (4.3)	9.7 ft
251-30509	G51TE	0.189 (4.80)	0.256 (6.50)	0.39 (9.9)	0.264 (6.7)	0.25 (6.4)	0.18 (4.5)	9.7 ft
251-30609	G51TF	0.256 (6.50)	0.319 (8.10)	0.45 (11.4)	0.327 (8.3)	0.27 (6.8)	0.19 (4.8)	9.7 ft
251-30709	G51TG	0.319 (8.10)	0.382 (9.70)	0.52 (13.2)	0.398 (10.1)	0.27 (6.8)	0.19 (4.8)	9.7 ft
251-30809	G51TH	0.382 (9.70)	0.508 (12.90)	0.65 (16.4)	0.520 (13.2)	0.27 (6.8)	0.19 (4.8)	9.7 ft

Dimensions are approximate and subject to technical changes. Use Part No. for ordering and Type for specification purposes.



Please note! Not all products listed on this page may have this approval. Please check our website for latest approvals.

Routing, Protection and Insulation

Grommet Edging

Grommet Edging - Special Materials

Flexiform Edge Protection Grommet Strip - Polyvinylchloride Grommet

EdgeGuard is used to cover panel edging to protect cables, prevent chafing and provide an attractive finish. The EdgeGuard is manufactured from a flexible PVC compound ensuring ease of use.

Features and Benefits

- Fits in holes of all shapes and sizes without the aid of tools or adhesives, making installation easy.
- Easily cut to the right length with scissors, thus reducing stock and eliminating waste.
- Can be used on any type of material including wood, steel, aluminum, plexiglass and glass, ensuring flexibility of application.

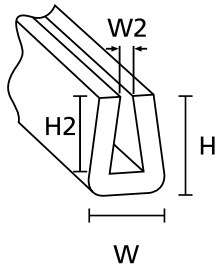

MATERIAL	Polyvinylchloride (PVC)
Color	Black
Operating Temperature	-85°F to +221°F (-65°C to +105°C)
Flammability	UL 94 HB



PART NO.	TYPE	Min. Panel Thickness in. (mm)	Max. Panel Thickness in. (mm)	Width (W) in. (mm)	Width (W2) in. (mm)	Width (W3) in. (mm)	Width (W4) in. (mm)	Height (H) in. (mm)	Height (H2) in. (mm)	Pkg. Qty.
SM1BK75MT	SM1	0.039 (1.00)	0.079 (2.00)	0.20 (5.0)	0.039 (1.0)	0.07 (1.8)	0.165 (4.2)	0.25 (6.3)	0.19 (4.9)	246.1 ft

Dimensions are approximate and subject to technical changes. Use Part No. for ordering and Type for specification purposes.

Non-Adhesive 3 to 1 Shrink Ratio

TFN31 Basic Kit Non-Adhesive Thin Wall

The TFN31 basic kit contains an assortment of black 3 to 1 tubing in a variety of diameter sizes and lengths. Heat shrink kits are a convenient solution for “on-the-job” projects. This 3 to 1 shrink ratio tubing features a flexible, thin wall to cover a wide range of components, sizes and shapes. The polyolefin material has a higher operating temperature range than general-use heat shrink tubing.

Features and Benefits

- The basic kit contains 220 pieces of black polyolefin heat shrink tubing in assorted diameter sizes and lengths.
- The 3 to 1 shrink ratio covers a wide range of components, sizes and shapes.
- Material is self-extinguishing, for use in applications in which non-flammable materials are required.
- Case included for easy storage and transport.

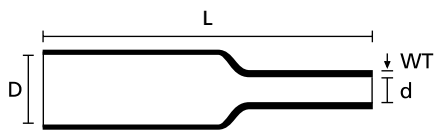

MATERIAL	Polyolefin, cross-linked (PO-X)
Shrink Ratio	3:1
Longitudinal Change After Shrinkage	+5 %/-10 % max.
Min. Shrink Temperature	+194 °F (+90 °C)
Operating Temperature	-67°F to +275°F (-55°C to +135°C)
Dielectric Strength	20 kV/mm according to ASTM D 2671
Flammability	Self-Extinguishing



PART NO.	TYPE	Comp.	Trade Size	Supplied Ø (D) in. (mm)	Recovered Ø (d) in. (mm)	Wall Thickness (WT) in. (mm)	Length (L) in. (mm)	Color	Number of Tubes
380-03001	ShrinkKit 321 Basic	1	1/16	0.06 (1.5)	0.02 (0.5)	0.018 (0.45)	1.38 (35.0)	Black	50
		2	1/4	0.24 (6.0)	0.08 (2.0)	0.028 (0.70)	1.38 (35.0)	Black	30
		3	1/8	0.12 (3.0)	0.04 (1.0)	0.022 (0.55)	1.38 (35.0)	Black	25
		4	1/4	0.24 (6.0)	0.08 (2.0)	0.028 (0.70)	1.38 (35.0)	Black	15
		5	1/4	0.24 (6.0)	0.08 (2.0)	0.028 (0.70)	1.38 (35.0)	Black	15
		6	1/8	0.12 (3.0)	0.04 (1.0)	0.022 (0.55)	1.38 (35.0)	Black	25
		7	1/16	0.06 (1.5)	0.02 (0.5)	0.018 (0.45)	1.38 (35.0)	Black	50
		8	1/2	0.47 (12.0)	0.16 (4.0)	0.028 (0.70)	3.15 (80.0)	Black	5
		9	3/4	0.71 (18.0)	0.24 (6.0)	0.031 (0.80)	3.15 (80.0)	Black	5

Dimensions are approximate and subject to technical changes. Use Part No. for ordering and Type for specification purposes.



Please note! Not all products listed on this page may have this approval. Please check our website for latest approvals.

Routing, Protection and Insulation

Heat Shrink Tubing

Non-Adhesive 3 to 1 Shrink Ratio

TFN31 Universal Kit Non-Adhesive Thin Wall

The TFN31 universal kit contains an assortment of 3 to 1 tubing in different diameter sizes, colors and lengths. Heat shrink kits are a convenient solution for “on-the-job” projects. This 3 to 1 shrink ratio tubing features a flexible, thin wall to cover a wide range of components, sizes and shapes. The polyolefin material has a higher operating temperature range than general-use heat shrink tubing.

Features and Benefits

- The universal kit contains 177 pieces of tubing in assorted colors, diameter sizes and lengths.
- The 3 to 1 shrink ratio covers a wide range of components, sizes and shapes.
- Material is self-extinguishing, for use in applications in which non-flammable materials are required.
- Case included for easy storage and transport.
- Each individual bag contains 10 pieces cut to 6" lengths.

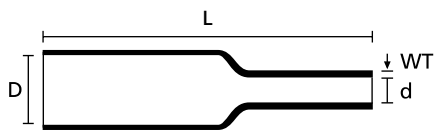

MATERIAL	Polyolefin, cross-linked (PO-X)
Shrink Ratio	3:1
Longitudinal Change After Shrinkage	+5 %/-10 % max.
Min. Shrink Temperature	+194 °F (+90 °C)
Operating Temperature	-67°F to +275°F (-55°C to +135°C)
Dielectric Strength	20 kV/mm according to ASTM D 2671
Flammability	Self-Extinguishing



PART NO.	TYPE	Comp.	Trade Size in.	Supplied Diameter (D) in. (mm)	Recovered Diameter (D) in. (mm)	Wall Thickness (WT) in. (mm)	Length (L) in. (mm)	Color	Number of Tubes
380-03005	321-KIT-ASST	1	1/2	0.47 (12.0)	0.16 (4.0)	0.028 (0.75)	1.38 (35.0)	Black	12
		2	1/2	0.47 (12.0)	0.16 (4.0)	0.028 (0.70)	3.15 (80.0)	Black	2
			1/2	0.47 (12.0)	0.16 (4.0)	0.028 (0.70)	3.15 (80.0)	Blue	2
			1/2	0.47 (12.0)	0.16 (4.0)	0.028 (0.70)	3.15 (80.0)	Red	2
			1/4	0.24 (6.0)	0.08 (2.0)	0.028 (0.70)	3.15 (80.0)	Blue	5
			1/4	0.24 (6.0)	0.08 (2.0)	0.028 (0.70)	3.15 (80.0)	Red	5
			1/4	0.24 (6.0)	0.08 (2.0)	0.028 (0.70)	3.15 (80.0)	White	5
			3	1/4	0.24 (6.0)	0.08 (2.0)	0.028 (0.70)	1.38 (35.0)	Blue
		1/4		0.24 (6.0)	0.08 (2.0)	0.028 (0.70)	1.38 (35.0)	Red	10
		1/4		0.24 (6.0)	0.08 (2.0)	0.028 (0.70)	1.38 (35.0)	White	10
		4	3/8	0.35 (9.0)	0.12 (3.0)	0.028 (0.70)	1.38 (35.0)	Green-Yellow	15
		5	3/8	0.35 (9.0)	0.12 (3.0)	0.028 (0.70)	1.38 (35.0)	Black	20
		6	1/8	0.12 (3.0)	0.04 (1.0)	0.022 (0.55)	1.38 (35.0)	Black	10
			1/8	0.12 (3.0)	0.04 (1.0)	0.022 (0.55)	1.38 (35.0)	Blue	10
			1/8	0.12 (3.0)	0.04 (1.0)	0.022 (0.55)	1.38 (35.0)	Red	10
			1/8	0.12 (3.0)	0.04 (1.0)	0.022 (0.55)	1.38 (35.0)	White	10
		7	1/4	0.24 (6.0)	0.08 (2.0)	0.028 (0.70)	1.38 (35.0)	Black	20
			1/4	0.24 (6.0)	0.08 (2.0)	0.028 (0.70)	1.38 (35.0)	Green-Yellow	10
		8	3/4	0.71 (18.0)	0.24 (6.0)	0.031 (0.80)	6.30 (160.0)	Black	3
			3/4	0.71 (18.0)	0.24 (6.0)	0.031 (0.80)	6.30 (160.0)	Green-Yellow	3
			3/4	0.71 (18.0)	0.24 (6.0)	0.031 (0.80)	6.30 (160.0)	White	3

Dimensions are approximate and subject to technical changes. Use Part No. for ordering and Type for specification purposes.

Non-Adhesive 3 to 1 Shrink Ratio

TFN31 HIS-3 Bags Non-Adhesive Thin Wall

TFN31 HIS-3 bags are packaged in smaller lengths, in a convenient bag for small projects and easy merchandising. TFN31 series tubing features a flexible, thin wall and highly flame retardant material with a higher operating temperature range than general-use heat shrink tubing. The 3 to 1 shrink ratio accommodates a variety of component shapes and sizes.

Features and Benefits

- Thin wall 3 to 1 shrink material is extremely flexible and accommodates a wide range of component shapes and diameters.
- Meets UL224 VW-1 specifications for flame retardancy, for use in high heat applications (excludes clear tubing).
- Polyolefin material provides excellent insulation and mechanical strength with good resistance to solvents, oils and fuels.
- Packaged in a printed plastic bag with hang hole for easy merchandising.

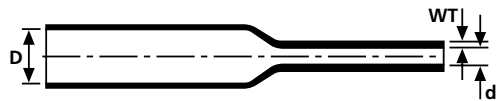

MATERIAL	Polyolefin, cross-linked (PO-X)
Shrink Ratio	3:1
Longitudinal Change After Shrinkage	-5 % max.
Min. Shrink Temperature	+212 °F (+100 °C)
Operating Temperature	-67°F to +275°F (-55°C to +135°C)
Dielectric Strength	20 kV/mm according to ASTM D 150
Flammability	UL 224 VW-1 (except clear)



PART NO.	TYPE	Trade Size	Supplied Ø (D) in. (mm)	Recovered Ø (d) in. (mm)	Wall Thickness (WT) in. (mm)	Color	Pkg. Qty.
308-30320*	HIS-3-BAG 3/1 BK	1/8	0.13 (3.2)	0.039 (1.0)	0.022 (0.55)	Black	10
308-30321*	HIS-3-BAG 3/1 CL	1/8	0.13 (3.2)	0.039 (1.0)	0.022 (0.55)	Clear	10
308-30420	HIS-3-BAG 4.5/1.5 BK	3/16	0.19 (4.8)	0.059 (1.5)	0.024 (0.60)	Black	10
308-30421	HIS-3-BAG 4.5/1.5 CL	3/16	0.19 (4.8)	0.059 (1.5)	0.024 (0.60)	Clear	10
308-30620*	HIS-3-BAG 6/2 BK	1/4	0.25 (6.4)	0.079 (2.0)	0.026 (0.65)	Black	10
308-30621*	HIS-3-BAG 6/2 CL	1/4	0.25 (6.4)	0.079 (2.0)	0.026 (0.65)	Clear	10
308-30920	HIS-3-BAG 9/3 BK	3/8	0.38 (9.5)	0.118 (3.0)	0.029 (0.75)	Black	10
308-30921	HIS-3-BAG 9/3 CL	3/8	0.38 (9.5)	0.118 (3.0)	0.029 (0.75)	Clear	10
308-31220*	HIS-3-BAG 12/4 BK	1/2	0.50 (12.7)	0.157 (4.0)	0.031 (0.80)	Black	10
308-31221*	HIS-3-BAG 12/4 CL	1/2	0.50 (12.7)	0.157 (4.0)	0.031 (0.80)	Clear	10

Dimensions are approximate and subject to technical changes. Use Part No. for ordering and Type for specification purposes.
 *This product meets UL standards. Please see appendix for specific file numbers.



Please note! Not all products listed on this page may have this approval. Please check our website for latest approvals.

Routing, Protection and Insulation

Heat Shrink Tubing

Non-Adhesive 3 to 1 Shrink Ratio

TFN31 Reels Non-Adhesive Thin Wall

TFN31 heat shrink tubing has a flexible, thin wall and a 3 to 1 shrink ratio to accommodate a variety of component shapes and diameters. Made of a highly flame retardant material, this tubing offers abrasion and insulation protection for wires and cables. The polyolefin material also offers good resistance to solvents, oils and fuels.

Features and Benefits

- Thin wall, flexible 3 to 1 shrink ratio material accommodates a wide range of component shapes and diameters.
- Meets UL224 VW-1 specifications, making it ideal for high heat applications.
- Polyolefin material provides excellent insulation and mechanical strength with good resistance to solvents, oils and fuels.
- For use in applications up to 600 volts.

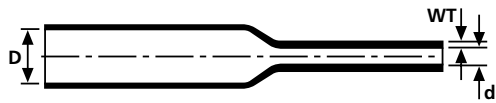

MATERIAL	Polyolefin, cross-linked (PO-X)
ShrinkRatio	3:1
Longitudinal Change After Shrinkage	+/-5 %
Min. Shrink Temperature	+212 °F (+100 °C)
Operating Temperature	-67°F to +275°F (-55°C to +135°C)
Dielectric Strength	>20 kV/mm
Flammability	UL 224 VW-1



PART NO.	TYPE	Trade Size	Supplied Ø (D) in. (mm)	Recovered Ø (d) in. (mm)	Wall Thickness (WT) in. (mm)	Color	Pkg. Qty.
333-41500*	TFN31 3/1	1/8	0.125 (3.2)	0.063 (1.0)	0.022 (0.6)	Black	1000 ft
333-41501*	TFN31 6/2	1/4	0.250 (6.4)	0.079 (2.0)	0.026 (0.7)	Black	1000 ft
333-41502*	TFN31 9/3	3/8	0.375 (9.5)	0.118 (3.0)	0.029 (0.8)	Black	500 ft
333-41503*	TFN31 12/4	1/2	0.500 (12.7)	0.157 (4.0)	0.031 (0.8)	Black	300 ft
333-41504*	TFN31 18/6	3/4	0.750 (19.1)	0.276 (6.0)	0.035 (0.9)	Black	200 ft
333-41505*	TFN31 24/8	1	1.000 (25.4)	0.315 (8.0)	0.047 (1.2)	Black	200 ft
333-41506*	TFN31 39/13	1-1/2	1.500 (39.0)	0.512 (13.0)	0.049 (1.3)	Black	100 ft

Dimensions are approximate and subject to technical changes. Use Part No. for ordering and Type for specification purposes.
 *This product meets UL standards. Please see appendix for specific file numbers.



Please note! Not all products listed on this page may have this approval. Please check our website for latest approvals.

Non-Adhesive 3 to 1 Shrink Ratio

TFN31 Sticks Non-Adhesive Thin Wall

TFN31 heat shrink tubing has a flexible, thin wall and a 3 to 1 shrink ratio to accommodate a variety of component shapes and diameters. Made of a highly flame retardant material, this tubing offers abrasion and insulation protection for wires and cables. The polyolefin material also offers good resistance to solvents, oils and fuels.

Features and Benefits

- Thin wall 3 to 1 shrink material is extremely flexible and accommodates a wide range of component shapes and diameters.
- Meets UL224 VW-1 specifications, making it ideal for high heat applications.
- Polyolefin material provides excellent insulation and mechanical strength with good resistance to solvents, oils and fuels.
- 4-foot sticks are individually tagged for retail.
- For use in applications up to 600 volts.



MATERIAL	Polyolefin, cross-linked (PO-X)
Shrink Ratio	3:1
Longitudinal Change After Shrinkage	+/-5 %
Min. Shrink Temperature	+212 °F (+100 °C)
Operating Temperature	-67°F to +275°F (-55°C to +135°C)
Dielectric Strength	>20 kV/mm
Flammability	UL 224 VW-1

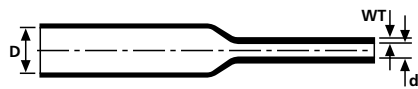

PART NO.	TYPE	Trade Size	Supplied Ø (D) in. (mm)	Recovered Ø (d) in. (mm)	Wall Thickness (WT) in. (mm)	Color	Pkg. Qty.
333-41507*	TFN31-ST-1.5/0.5	1/16	0.063 (1.5)	0.020 (0.5)	0.018 (0.5)	Black	20
333-41508*	TFN31-ST-3/1	1/8	0.125 (3.2)	0.063 (1.0)	0.022 (0.6)	Black	20
333-41509*	TFN31-ST-4.5/1.5	3/16	0.188 (4.8)	0.059 (1.5)	0.024 (0.6)	Black	20
333-41510*	TFN31-ST-6/2	1/4	0.250 (6.4)	0.079 (2.0)	0.026 (0.7)	Black	15
333-41511*	TFN31-ST-9/3	3/8	0.375 (9.5)	0.118 (3.0)	0.029 (0.8)	Black	15
333-41512*	TFN31-ST-12/4	1/2	0.500 (12.7)	0.157 (4.0)	0.031 (0.8)	Black	10
333-41513*	TFN31-ST-18/6	3/4	0.750 (19.1)	0.236 (6.0)	0.035 (0.9)	Black	5
333-41514*	TFN31-ST-24/8	1	1.000 (25.4)	0.315 (8.0)	0.047 (1.2)	Black	5

Dimensions are approximate and subject to technical changes. Use Part No. for ordering and Type for specification purposes.
*This product meets UL standards. Please see appendix for specific file numbers.



Please note! Not all products listed on this page may have this approval. Please check our website for latest approvals.

Routing, Protection and Insulation

Heat Shrink Tubing

Adhesive Lined Thin Wall

TAN33 Sticks Adhesive-Lined Thin Wall

TAN33 is a flexible, thin wall adhesive-lined heat shrink tubing with highly flame retardant properties. The 3 to 1 shrink ratio accommodates a wide range of component shapes and diameters. The adhesive lining begins to activate as the temperature reaches 176° F (80° C), to create a strong seal against moisture and humidity.

Features and Benefits

- Adhesive lining provides an excellent seal against moisture and humidity.
- Thin exterior wall is very flexible, while providing superior insulation of cables and components.
- 3 to 1 shrink ratio accommodates a wide range of component shapes and diameters.
- Meets UL224 VW-1 specifications, making it ideal for high heat applications (excludes clear tubing).
- Polyolefin material provides mechanical strength with good resistance to solvents, oils and fuels.
- 4-foot sticks are individually tagged and come in a retail box.
- For applications up to 600 volts.



MATERIAL	Polyolefin, cross-linked (PO-X)
Shrink Ratio	3:1
Longitudinal Change After Shrinkage	10 % max.
Min. Shrink Temperature	+230 °F (+110 °C)
Softening Point Adhesive	+176°F (+80°C)
Operating Temperature	-67°F to +257°F (-55°C to +125°C)
Flammability	UL 224 VW-1

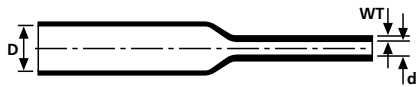

PART NO.	TYPE	Trade Size	Supplied Ø (D) in. (mm)	Recovered Ø (d) in. (mm)	Wall Thickness (WT) in. (mm)	Color	Pkg. Qty.
318-60150*	TAN33-ST-3/1 BK	1/8	0.11 (3.0)	0.039 (1.0)	0.039 (1.00)	Black	20
318-60151*	TAN33-ST-4.8/1.5 BK	3/16	0.19 (4.8)	0.059 (1.5)	0.039 (1.00)	Black	20
318-60152*	TAN33-ST-6/2 BK	1/4	0.24 (6.0)	0.079 (2.0)	0.039 (1.00)	Black	15
318-60153*	TAN33-ST-9/3 BK	3/8	0.35 (9.0)	0.112 (3.0)	0.056 (1.40)	Black	15
318-60154*	TAN33-ST-12/4 BK	1/2	0.47 (12.0)	0.158 (4.0)	0.063 (1.60)	Black	10
318-60155*	TAN33-ST-19/6 BK	3/4	0.75 (19.0)	0.236 (6.0)	0.085 (2.15)	Black	15
318-60156*	TAN33-ST-24/8 BK	1	0.95 (24.0)	0.315 (8.0)	0.094 (2.40)	Black	10
318-60158*	TAN33-ST-40/13 BK	1-1/2	1.58 (40.0)	0.512 (13.0)	0.094 (2.40)	Black	6

Dimensions are approximate and subject to technical changes. Use Part No. for ordering and Type for specification purposes.
 *This product meets UL standards. Please see appendix for specific file numbers.



Please note! Not all products listed on this page may have this approval. Please check our website for latest approvals.

Non-Adhesive 2 to 1 Shrink Ratio

TFN21 Reels Non-Adhesive Thin Wall

TFN21 is a highly flexible thin wall heat shrink tubing with a 2 to 1 shrink ratio and excellent flame retardant properties. In addition to providing insulation and abrasion protection for wires and cables, the polyolefin material also offers resistance to oils, solvents and chemicals.

Features and Benefits

- Thin, 2 to 1 shrink ratio tubing provides insulation and abrasion protection for wires and cables.
- Flammability rating of UL224 VW-1 for use in applications requiring the highest degree of flame protection (excludes clear tubing).
- Flexible-yet-durable material resists most common oils, chemicals and fluids.
- Offered in a variety of diameters and colors for identifying and marking wires and cables.
- Available in mini reels or bulk reels for small to large volume applications.
- For use in applications up to 600 volts.



MATERIAL	Polyolefin, cross-linked (PO-X)
Shrink Ratio	2:1
Longitudinal Change After Shrinkage	+/-5 %
Min. Shrink Temperature	+212 °F (+100 °C)
Operating Temperature	-67°F to +275°F (-55°C to +135°C)
Dielectric Strength	>20kV/mm according to ASTM D 150
Flammability	UL 224 VW-1 (except clear)

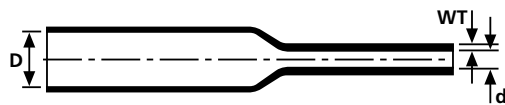

PART NO.	TYPE	Trade Size	Supplied Ø (D) in. (mm)	Recovered Ø (d) in. (mm)	Wall Thickness (WT) in. (mm)	Color	Pkg. Qty.
309-60197*	TFN21 1.2/0.6	3/64	0.047 (1.2)	0.024 (0.6)	0.016 (0.4)	Black	1000 ft
309-60108*	TFN21 1.6/0.8	1/16	0.063 (1.6)	0.032 (0.8)	0.016 (0.4)	Black	100 ft
309-60109*		1/16	0.063 (1.6)	0.032 (0.8)	0.016 (0.4)	Black	1000 ft
309-60281*		1/16	0.063 (1.6)	0.032 (0.8)	0.016 (0.4)	Blue	100 ft
309-60107*		1/16	0.063 (1.6)	0.032 (0.8)	0.016 (0.4)	Clear	100 ft
309-60284*		1/16	0.063 (1.6)	0.032 (0.8)	0.016 (0.4)	Green	100 ft
309-60280*		1/16	0.063 (1.6)	0.032 (0.8)	0.016 (0.4)	Red	100 ft
309-60282*		1/16	0.063 (1.6)	0.032 (0.8)	0.016 (0.4)	White	100 ft
309-60283*		1/16	0.063 (1.6)	0.032 (0.8)	0.016 (0.4)	Yellow	100 ft
309-65112*		TFN21 2.4/1.2	3/32	0.094 (2.4)	0.047 (1.2)	0.019 (0.5)	Black
309-60118*	3/32		0.094 (2.4)	0.047 (1.2)	0.019 (0.5)	Black	1000 ft
309-60286*	3/32		0.094 (2.4)	0.047 (1.2)	0.019 (0.5)	Blue	100 ft
309-65111*	3/32		0.094 (2.4)	0.047 (1.2)	0.019 (0.5)	Clear	100 ft
309-60289*	3/32		0.094 (2.4)	0.047 (1.2)	0.019 (0.5)	Green	100 ft
309-60285*	3/32		0.094 (2.4)	0.047 (1.2)	0.019 (0.5)	Red	100 ft
309-60287*	3/32		0.094 (2.4)	0.047 (1.2)	0.019 (0.5)	White	100 ft
309-60288*	3/32		0.094 (2.4)	0.047 (1.2)	0.019 (0.5)	Yellow	100 ft

Dimensions are approximate and subject to technical changes. Use Part No. for ordering and Type for specification purposes.

*This product meets UL standards. Please see appendix for specific file numbers.



Please note! Not all products listed on this page may have this approval. Please check our website for latest approvals.

Routing, Protection and Insulation

Heat Shrink Tubing

Non-Adhesive 2 to 1 Shrink Ratio

TFN21 Reels Non-Adhesive Thin Wall

PART NO.	TYPE	Trade Size	Supplied Ø (D) in. (mm)	Recovered Ø (d) in. (mm)	Wall Thickness (WT) in. (mm)	Color	Pkg. Qty.
309-60290*	TFN21 3.2/1.6	1/8	0.125 (3.2)	0.063 (1.6)	0.019 (0.5)	Black	100 ft
309-65123*		1/8	0.125 (3.2)	0.063 (1.6)	0.019 (0.5)	Black	1000 ft
309-65122*		1/8	0.125 (3.2)	0.063 (1.6)	0.019 (0.5)	Blue	100 ft
309-65120*		1/8	0.125 (3.2)	0.063 (1.6)	0.019 (0.5)	Clear	100 ft
309-60293*		1/8	0.125 (3.2)	0.063 (1.6)	0.019 (0.5)	Green	100 ft
309-65121*		1/8	0.125 (3.2)	0.063 (1.6)	0.019 (0.5)	Red	100 ft
309-60291*		1/8	0.125 (3.2)	0.063 (1.6)	0.019 (0.5)	White	100 ft
309-60292*		1/8	0.125 (3.2)	0.063 (1.6)	0.019 (0.5)	Yellow	100 ft
309-60294*	TFN21 4.8/2.4	3/16	0.188 (4.8)	0.094 (2.4)	0.019 (0.5)	Black	50 ft
309-65133*		3/16	0.188 (4.8)	0.094 (2.4)	0.019 (0.5)	Black	1000 ft
309-65132*		3/16	0.188 (4.8)	0.094 (2.4)	0.019 (0.5)	Blue	50 ft
309-65130*		3/16	0.188 (4.8)	0.094 (2.4)	0.019 (0.5)	Clear	50 ft
309-60297*		3/16	0.188 (4.8)	0.094 (2.4)	0.019 (0.5)	Green	50 ft
309-65131*		3/16	0.188 (4.8)	0.094 (2.4)	0.019 (0.5)	Red	50 ft
309-60295*		3/16	0.188 (4.8)	0.094 (2.4)	0.019 (0.5)	White	50 ft
309-60296*		3/16	0.188 (4.8)	0.094 (2.4)	0.019 (0.5)	Yellow	50 ft
309-60298*	TFN21 6.4/3.2	1/4	0.250 (6.4)	0.125 (3.2)	0.022 (0.6)	Black	50 ft
309-65143*		1/4	0.250 (6.4)	0.125 (3.2)	0.022 (0.6)	Black	1000 ft
309-65142*		1/4	0.250 (6.4)	0.125 (3.2)	0.022 (0.6)	Blue	50 ft
309-65140*		1/4	0.250 (6.4)	0.125 (3.2)	0.022 (0.6)	Clear	50 ft
309-60301*		1/4	0.250 (6.4)	0.125 (3.2)	0.022 (0.6)	Green	50 ft
309-65141*		1/4	0.250 (6.4)	0.125 (3.2)	0.022 (0.6)	Red	50 ft
309-60299*		1/4	0.250 (6.4)	0.125 (3.2)	0.022 (0.6)	White	50 ft
309-60300*		1/4	0.250 (6.4)	0.125 (3.2)	0.022 (0.6)	Yellow	50 ft
309-60302*	TFN21 9.5/4.8	3/8	0.375 (9.5)	0.188 (4.8)	0.024 (0.6)	Black	50 ft
309-65153*		3/8	0.375 (9.5)	0.188 (4.8)	0.024 (0.6)	Black	500 ft
309-65152*		3/8	0.375 (9.5)	0.188 (4.8)	0.024 (0.6)	Blue	50 ft
309-65150*		3/8	0.375 (9.5)	0.188 (4.8)	0.024 (0.6)	Clear	50 ft
309-60305*		3/8	0.375 (9.5)	0.188 (4.8)	0.024 (0.6)	Green	50 ft
309-65151*		3/8	0.375 (9.5)	0.188 (4.8)	0.024 (0.6)	Red	50 ft
309-60303*		3/8	0.375 (9.5)	0.188 (4.8)	0.024 (0.6)	White	50 ft
309-60304*		3/8	0.375 (9.5)	0.188 (4.8)	0.024 (0.6)	Yellow	50 ft
309-60306*	TFN21 12.7/6.4	1/2	0.500 (12.7)	0.250 (6.4)	0.024 (0.6)	Black	25 ft
309-65163*		1/2	0.500 (12.7)	0.250 (6.4)	0.024 (0.6)	Black	300 ft
309-65162*		1/2	0.500 (12.7)	0.250 (6.4)	0.024 (0.6)	Blue	25 ft
309-65160*		1/2	0.500 (12.7)	0.250 (6.4)	0.024 (0.6)	Clear	25 ft
309-60309*		1/2	0.500 (12.7)	0.250 (6.4)	0.024 (0.6)	Green	25 ft
309-65161*		1/2	0.500 (12.7)	0.250 (6.4)	0.024 (0.6)	Red	25 ft
309-60307*		1/2	0.500 (12.7)	0.250 (6.4)	0.024 (0.6)	White	25 ft
309-60308*		1/2	0.500 (12.7)	0.250 (6.4)	0.024 (0.6)	Yellow	25 ft

Dimensions are approximate and subject to technical changes. Use Part No. for ordering and Type for specification purposes.

*This product meets UL standards. Please see appendix for specific file numbers.



Please note! Not all products listed on this page may have this approval. Please check our website for latest approvals.

Non-Adhesive 2 to 1 Shrink Ratio

TFN21 Reels Non-Adhesive Thin Wall

PART NO.	TYPE	Trade Size	Supplied Ø (D) in. (mm)	Recovered Ø (d) in. (mm)	Wall Thickness (WT) in. (mm)	Color	Pkg. Qty.
309-60310*	TFN21 16.0/8.0	5/8	0.630 (16.0)	0.315 (8.0)	0.027 (0.7)	Black	25 ft
309-60311*	TFN21 19.1/9.5	3/4	0.750 (19.1)	0.375 (9.5)	0.027 (0.7)	Black	25 ft
309-65173*		3/4	0.750 (19.1)	0.375 (9.5)	0.027 (0.7)	Black	200 ft
309-65172*		3/4	0.750 (19.1)	0.375 (9.5)	0.027 (0.7)	Blue	25 ft
309-65170*		3/4	0.750 (19.1)	0.375 (9.5)	0.027 (0.7)	Clear	25 ft
309-60314*		3/4	0.750 (19.1)	0.375 (9.5)	0.027 (0.7)	Green	25 ft
309-65171*		3/4	0.750 (19.1)	0.375 (9.5)	0.027 (0.7)	Red	25 ft
309-60312*		3/4	0.750 (19.1)	0.375 (9.5)	0.027 (0.7)	White	25 ft
309-60313*		3/4	0.750 (19.1)	0.375 (9.5)	0.027 (0.7)	Yellow	25 ft
309-60315*		TFN21 25.4/12.7	1	1.000 (25.4)	0.500 (12.7)	0.034 (0.9)	Black
309-65183*	1		1.000 (25.4)	0.500 (12.7)	0.034 (0.9)	Black	200 ft
309-65182*	1		1.000 (25.4)	0.500 (12.7)	0.034 (0.9)	Blue	25 ft
309-65180*	1		1.000 (25.4)	0.500 (12.7)	0.034 (0.9)	Clear	25 ft
309-60318*	1		1.000 (25.4)	0.500 (12.7)	0.034 (0.9)	Green	25 ft
309-65181*	1		1.000 (25.4)	0.500 (12.7)	0.034 (0.9)	Red	25 ft
309-60316*	1		1.000 (25.4)	0.500 (12.7)	0.034 (0.9)	White	25 ft
309-60317*	1		1.000 (25.4)	0.500 (12.7)	0.034 (0.9)	Yellow	25 ft
309-60319*	TFN21 31.8/16.0		1-1/4	1.250 (31.8)	0.625 (16.0)	0.039 (1.0)	Black
309-60322*		1-1/4	1.250 (31.8)	0.625 (16.0)	0.039 (1.0)	Blue	100 ft
309-60320*		1-1/4	1.250 (31.8)	0.625 (16.0)	0.039 (1.0)	Clear	100 ft
309-60325*		1-1/4	1.250 (31.8)	0.625 (16.0)	0.039 (1.0)	Green	100 ft
309-60321*		1-1/4	1.250 (31.8)	0.625 (16.0)	0.039 (1.0)	Red	100 ft
309-60323*		1-1/4	1.250 (31.8)	0.625 (16.0)	0.039 (1.0)	White	100 ft
309-60324*		1-1/4	1.250 (31.8)	0.625 (16.0)	0.039 (1.0)	Yellow	100 ft
309-65192*	TFN21 38.1/19.1	1-1/2	1.500 (38.1)	0.752 (19.1)	0.039 (1.0)	Black	100 ft
309-60328*		1-1/2	1.500 (38.1)	0.752 (19.1)	0.039 (1.0)	Blue	100 ft
309-60326*		1-1/2	1.500 (38.1)	0.752 (19.1)	0.039 (1.0)	Clear	100 ft
309-60331*		1-1/2	1.500 (38.1)	0.752 (19.1)	0.039 (1.0)	Green	100 ft
309-60327*		1-1/2	1.500 (38.1)	0.752 (19.1)	0.039 (1.0)	Red	100 ft
309-60329*		1-1/2	1.500 (38.1)	0.752 (19.1)	0.039 (1.0)	White	100 ft
309-60330*		1-1/2	1.500 (38.1)	0.752 (19.1)	0.039 (1.0)	Yellow	100 ft
309-60332*	TFN21 50.8/25.4	2	2.000 (50.8)	1.000 (25.4)	0.043 (1.1)	Black	100 ft
309-60335*		2	2.000 (50.8)	1.000 (25.4)	0.043 (1.1)	Blue	100 ft
309-60333*		2	2.000 (50.8)	1.000 (25.4)	0.043 (1.1)	Clear	100 ft
309-60338*		2	2.000 (50.8)	1.000 (25.4)	0.043 (1.1)	Green	100 ft
309-60334*		2	2.000 (50.8)	1.000 (25.4)	0.043 (1.1)	Red	100 ft
309-60336*		2	2.000 (50.8)	1.000 (25.4)	0.043 (1.1)	White	100 ft
309-60337*		2	2.000 (50.8)	1.000 (25.4)	0.043 (1.1)	Yellow	100 ft
309-65227*	TFN21 76.2/38.1	3	3.000 (76.2)	1.500 (38.1)	0.047 (1.2)	Black	50 ft
309-65237*	TFN21 102.0/50.8	4	4.000 (102.0)	2.000 (50.8)	0.053 (1.4)	Black	50 ft

Dimensions are approximate and subject to technical changes. Use Part No. for ordering and Type for specification purposes.

*This product meets UL standards. Please see appendix for specific file numbers.



Please note! Not all products listed on this page may have this approval. Please check our website for latest approvals.

Routing, Protection and Insulation

Heat Shrink Tubing

Non-Adhesive 2 to 1 Shrink Ratio

TFN21 Sticks Non-Adhesive Thin Wall

TFN21 is a highly flexible thin wall heat shrink tubing with a 2 to 1 shrink ratio and excellent flame retardant properties. In addition to providing insulation and abrasion protection for wires and cables, the polyolefin material also offers resistance to oils, solvents and chemicals.

Features and Benefits

- Thin, 2 to 1 shrink ratio tubing provides insulation and abrasion protection for wires and cables.
- Flammability rating of UL224 VW-1 for use in applications requiring the highest degree of flame protection (excludes clear tubing).
- Flexible-yet-durable material resists most common oils, chemicals and fluids.
- 4-foot sticks are individually tagged for retail.
- For use in applications up to 600 volts.



MATERIAL	Polyolefin, cross-linked (PO-X)
Shrink Ratio	2:1
Longitudinal Change After Shrinkage	+/- 5 %
Min. Shrink Temperature	+212 °F (+100 °C)
Operating Temperature	-67°F to +275°F (-55°C to +135°C)
Dielectric Strength	>20kV/mm according to ASTM D 150
Flammability	UL 224 VW-1 (except clear)

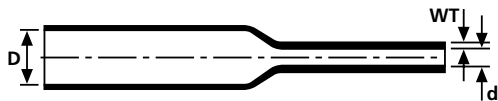

PART NO.	TYPE	Trade Size	Supplied Ø (D) in. (mm)	Recovered Ø (d) in. (mm)	Wall Thickness (WT) in. (mm)	Color	Pkg. Qty.
309-65101*	TFN21-ST 1.6/0.8	1/16	0.063 (1.6)	0.032 (0.8)	0.016 (0.4)	Black	20
309-65103*		1/16	0.063 (1.6)	0.032 (0.8)	0.016 (0.4)	Blue	20
309-65100*		1/16	0.063 (1.6)	0.032 (0.8)	0.016 (0.4)	Clear	20
309-65106*		1/16	0.063 (1.6)	0.032 (0.8)	0.016 (0.4)	Green	20
309-65102*		1/16	0.063 (1.6)	0.032 (0.8)	0.016 (0.4)	Red	20
309-65104*		1/16	0.063 (1.6)	0.032 (0.8)	0.016 (0.4)	White	20
309-65105*		1/16	0.063 (1.6)	0.032 (0.8)	0.016 (0.4)	Yellow	20
309-65110*	TFN21-ST 2.4/1.2	3/32	0.094 (2.4)	0.047 (1.2)	0.019 (0.5)	Black	20
309-65115*		3/32	0.094 (2.4)	0.047 (1.2)	0.019 (0.5)	Blue	20
309-65113*		3/32	0.094 (2.4)	0.047 (1.2)	0.019 (0.5)	Clear	20
309-65118*		3/32	0.094 (2.4)	0.047 (1.2)	0.019 (0.5)	Green	20
309-65114*		3/32	0.094 (2.4)	0.047 (1.2)	0.019 (0.5)	Red	20
309-65116*		3/32	0.094 (2.4)	0.047 (1.2)	0.019 (0.5)	White	20
309-65117*		3/32	0.094 (2.4)	0.047 (1.2)	0.019 (0.5)	Yellow	20

Dimensions are approximate and subject to technical changes. Use Part No. for ordering and Type for specification purposes.

*This product meets UL standards. Please see appendix for specific file numbers.



Please note! Not all products listed on this page may have this approval. Please check our website for latest approvals.

Non-Adhesive 2 to 1 Shrink Ratio

TFN21 Sticks Non-Adhesive Thin Wall

PART NO.	TYPE	Trade Size	Supplied Ø (D) in. (mm)	Recovered Ø (d) in. (mm)	Wall Thickness (WT) in. (mm)	Color	Pkg. Qty.
309-65124*	TFN21-ST 3.2/1.6	1/8	0.125 (3.2)	0.063 (1.6)	0.019 (0.5)	Black	20
309-65127*		1/8	0.125 (3.2)	0.063 (1.6)	0.019 (0.5)	Blue	20
309-65125*		1/8	0.125 (3.2)	0.063 (1.6)	0.019 (0.5)	Clear	20
309-65195*		1/8	0.125 (3.2)	0.063 (1.6)	0.019 (0.5)	Green	20
309-65126*		1/8	0.125 (3.2)	0.063 (1.6)	0.019 (0.5)	Red	20
309-65128*		1/8	0.125 (3.2)	0.063 (1.6)	0.019 (0.5)	White	20
309-65129*		1/8	0.125 (3.2)	0.063 (1.6)	0.019 (0.5)	Yellow	20
309-65134*	TFN21-ST 4.8/2.4	3/16	0.188 (4.8)	0.094 (2.4)	0.019 (0.5)	Black	20
309-65137*		3/16	0.188 (4.8)	0.094 (2.4)	0.019 (0.5)	Blue	20
309-65135*		3/16	0.188 (4.8)	0.094 (2.4)	0.019 (0.5)	Clear	20
309-65290*		3/16	0.188 (4.8)	0.094 (2.4)	0.019 (0.5)	Green	20
309-65136*		3/16	0.188 (4.8)	0.094 (2.4)	0.019 (0.5)	Red	20
309-65138*		3/16	0.188 (4.8)	0.094 (2.4)	0.019 (0.5)	White	20
309-65139*		3/16	0.188 (4.8)	0.094 (2.4)	0.019 (0.5)	Yellow	20
309-65144*	TFN21-ST 6.4/3.2	1/4	0.250 (6.4)	0.125 (3.2)	0.022 (0.6)	Black	15
309-65148*		1/4	0.250 (6.4)	0.125 (3.2)	0.022 (0.6)	Blue	15
309-65145*		1/4	0.250 (6.4)	0.125 (3.2)	0.022 (0.6)	Clear	15
309-65292*		1/4	0.250 (6.4)	0.125 (3.2)	0.022 (0.6)	Green	15
309-65166*		1/4	0.250 (6.4)	0.125 (3.2)	0.022 (0.6)	Green-Yellow	15
309-65147*		1/4	0.250 (6.4)	0.125 (3.2)	0.022 (0.6)	Red	15
309-65149*		1/4	0.250 (6.4)	0.125 (3.2)	0.022 (0.6)	White	15
309-65291*		1/4	0.250 (6.4)	0.125 (3.2)	0.022 (0.6)	Yellow	15
309-65154*	TFN21-ST 9.5/4.8	3/8	0.375 (9.5)	0.188 (4.8)	0.024 (0.6)	Black	15
309-65157*		3/8	0.375 (9.5)	0.188 (4.8)	0.024 (0.6)	Blue	15
309-65155*		3/8	0.375 (9.5)	0.188 (4.8)	0.024 (0.6)	Clear	15
309-65293*		3/8	0.375 (9.5)	0.188 (4.8)	0.024 (0.6)	Green	15
309-65156*		3/8	0.375 (9.5)	0.188 (4.8)	0.024 (0.6)	Red	15
309-65158*		3/8	0.375 (9.5)	0.188 (4.8)	0.024 (0.6)	White	15
309-65159*		3/8	0.375 (9.5)	0.188 (4.8)	0.024 (0.6)	Yellow	15
309-65164*		TFN21-ST 12.7/6.4	1/2	0.500 (12.7)	0.250 (6.4)	0.024 (0.6)	Black
309-65168*	1/2		0.500 (12.7)	0.250 (6.4)	0.024 (0.6)	Blue	10
309-65165*	1/2		0.500 (12.7)	0.250 (6.4)	0.024 (0.6)	Clear	10
309-65295*	1/2		0.500 (12.7)	0.250 (6.4)	0.024 (0.6)	Green	10
309-65146*	1/2		0.500 (12.7)	0.250 (6.4)	0.024 (0.6)	Green-Yellow	10
309-65167*	1/2		0.500 (12.7)	0.250 (6.4)	0.024 (0.6)	Red	10
309-65169*	1/2		0.500 (12.7)	0.250 (6.4)	0.024 (0.6)	White	10
309-65294*	1/2		0.500 (12.7)	0.250 (6.4)	0.024 (0.6)	Yellow	10

Dimensions are approximate and subject to technical changes. Use Part No. for ordering and Type for specification purposes.

*This product meets UL standards. Please see appendix for specific file numbers.



Please note! Not all products listed on this page may have this approval. Please check our website for latest approvals.

Routing, Protection and Insulation

Heat Shrink Tubing

Non-Adhesive 2 to 1 Shrink Ratio

TFN21 Sticks Non-Adhesive Thin Wall

PART NO.	TYPE	Trade Size	Supplied Ø (D) in. (mm)	Recovered Ø (d) in. (mm)	Wall Thickness (WT) in. (mm)	Color	Pkg. Qty.
309-65174*	TFN21-ST 19.1/9.5	3/4	0.750 (19.1)	0.375 (9.5)	0.027 (0.7)	Black	5
309-65177*		3/4	0.750 (19.1)	0.375 (9.5)	0.027 (0.7)	Blue	5
309-65175*		3/4	0.750 (19.1)	0.375 (9.5)	0.027 (0.7)	Clear	5
309-65296*		3/4	0.750 (19.1)	0.375 (9.5)	0.027 (0.7)	Green	5
309-65176*		3/4	0.750 (19.1)	0.375 (9.5)	0.027 (0.7)	Red	5
309-65178*		3/4	0.750 (19.1)	0.375 (9.5)	0.027 (0.7)	White	5
309-65179*		3/4	0.750 (19.1)	0.375 (9.5)	0.027 (0.7)	Yellow	5
309-65184*	TFN21-ST 25.4/12.7	1	0.750 (25.4)	0.500 (12.7)	0.027 (0.9)	Black	5
309-65298*		1	1.000 (25.4)	0.500 (12.7)	0.034 (0.9)	Blue	5
309-65280*		1	1.000 (25.4)	0.500 (12.7)	0.034 (0.9)	Clear	5
309-65301*		1	1.000 (25.4)	0.500 (12.7)	0.034 (0.9)	Green	5
309-65297*		1	1.000 (25.4)	0.500 (12.7)	0.034 (0.9)	Red	5
309-65299*		1	1.000 (25.4)	0.500 (12.7)	0.034 (0.9)	White	5
309-65300*		1	1.000 (25.4)	0.500 (12.7)	0.034 (0.9)	Yellow	5
309-65271*	TFN21-ST 31.8/16.0	1-1/4	1.250 (31.8)	0.625 (16.0)	0.039 (1.0)	Black	10
309-65273*		1-1/4	1.250 (31.8)	0.625 (16.0)	0.039 (1.0)	Blue	10
309-65270*		1-1/4	1.250 (31.8)	0.625 (16.0)	0.039 (1.0)	Clear	10
309-65276*		1-1/4	1.250 (31.8)	0.625 (16.0)	0.039 (1.0)	Green	10
309-65272*		1-1/4	1.250 (31.8)	0.625 (16.0)	0.039 (1.0)	Red	10
309-65274*		1-1/4	1.250 (31.8)	0.625 (16.0)	0.039 (1.0)	White	10
309-65275*		1-1/4	1.250 (31.8)	0.625 (16.0)	0.039 (1.0)	Yellow	10
309-65194*	TFN21-ST 38.1/19.1	1-1/2	1.500 (38.1)	0.750 (19.1)	0.039 (1.0)	Black	6
309-65303*		1-1/2	1.500 (38.1)	0.750 (19.1)	0.039 (1.0)	Blue	6
309-65193*		1-1/2	1.500 (38.1)	0.750 (19.1)	0.039 (1.0)	Clear	6
309-65306*		1-1/2	1.500 (38.1)	0.750 (19.1)	0.039 (1.0)	Green	6
309-65302*		1-1/2	1.500 (38.1)	0.750 (19.1)	0.039 (1.0)	Red	6
309-65304*		1-1/2	1.500 (38.1)	0.750 (19.1)	0.039 (1.0)	White	6
309-65305*		1-1/2	1.500 (38.1)	0.750 (19.1)	0.039 (1.0)	Yellow	6
309-65211*	TFN21-ST 50.8/25.4	2	2.000 (50.8)	1.000 (25.4)	0.043 (1.1)	Black	6
309-65213*		2	2.000 (50.8)	1.000 (25.4)	0.043 (1.1)	Blue	6
309-65210*		2	2.000 (50.8)	1.000 (25.4)	0.043 (1.1)	Clear	6
309-65216*		2	2.000 (50.8)	1.000 (25.4)	0.043 (1.1)	Green	6
309-65212*		2	2.000 (50.8)	1.000 (25.4)	0.043 (1.1)	Red	6
309-65214*		2	2.000 (50.8)	1.000 (25.4)	0.043 (1.1)	White	6
309-65215*		2	2.000 (50.8)	1.000 (25.4)	0.043 (1.1)	Yellow	6

Dimensions are approximate and subject to technical changes. Use Part No. for ordering and Type for specification purposes.

*This product meets UL standards. Please see appendix for specific file numbers.



Please note! Not all products listed on this page may have this approval. Please check our website for latest approvals.

Non-Adhesive 2 to 1 Shrink Ratio

TFN21 Sticks Non-Adhesive Thin Wall

PART NO.	TYPE	Trade Size	Supplied Ø (D) in. (mm)	Recovered Ø (d) in. (mm)	Wall Thickness (WT) in. (mm)	Color	Pkg. Qty.
309-65221*	TFN21-ST 76.2/38.1	3	3.000 (76.2)	1.500 (38.1)	0.047 (1.2)	Black	3
309-65223*		3	3.000 (76.2)	1.500 (38.1)	0.047 (1.2)	Blue	3
309-65220*		3	3.000 (76.2)	1.500 (38.1)	0.047 (1.2)	Clear	3
309-65226*		3	3.000 (76.2)	1.500 (38.1)	0.047 (1.2)	Green	3
309-65222*		3	3.000 (76.2)	1.500 (38.1)	0.047 (1.2)	Red	3
309-65224*		3	3.000 (76.2)	1.500 (38.1)	0.047 (1.2)	White	3
309-65225*		3	3.000 (76.2)	1.500 (38.1)	0.047 (1.2)	Yellow	3
309-65231*	TFN21-ST 102/50.8	4	4.000 (102.0)	2.000 (50.8)	0.053 (1.4)	Black	2
309-65233*		4	4.000 (102.0)	2.000 (50.8)	0.053 (1.4)	Blue	2
309-65230*		4	4.000 (102.0)	2.000 (50.8)	0.053 (1.4)	Clear	2
309-65236*		4	4.000 (102.0)	2.000 (50.8)	0.053 (1.4)	Green	2
309-65232*		4	4.000 (102.0)	2.000 (50.8)	0.053 (1.4)	Red	2
309-65234*		4	4.000 (102.0)	2.000 (50.8)	0.053 (1.4)	White	2
309-65235*		4	4.000 (102.0)	2.000 (50.8)	0.053 (1.4)	Yellow	2

Dimensions are approximate and subject to technical changes. Use Part No. for ordering and Type for specification purposes.

*This product meets UL standards. Please see appendix for specific file numbers.



Please note! Not all products listed on this page may have this approval. Please check our website for latest approvals.

Routing, Protection and Insulation

Heat Shrink Tubing

Non-Adhesive 2 to 1 Shrink Ratio

TCN20 Reels Non-Adhesive Thin Wall

TCN20 is a general-purpose, thin-wall tubing used to protect electrical and mechanical wiring. In addition to having a 2 to 1 shrink ratio, the polyolefin material is self extinguishing and resistant against common fluids and solvents. The low shrink temperature and mechanical strength make this tubing ideal for use in the automotive and electronics industries.

Features and Benefits

- Thin wall heat shrink tubing with a 2 to 1 shrink ratio to fit a variety of component shapes and diameters.
- Provides abrasion and insulation protection while also resisting fluids and solvents.
- Meets UL224 VW-1 specifications for flame retardancy.
- Low +212 °F (+100 °C) shrink temperature is well suited for electronic and harness making applications.
- For use in applications up to 600 volts.

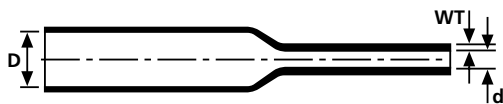

MATERIAL	Polyolefin, cross-linked (PO-X)
Shrink Ratio	2:1
Longitudinal Change After Shrinkage	+/-5 %
Min. Shrink Temperature	+212 °F (+100 °C)
Operating Temperature	-67°F to +257°F (-55°C to +125°C)
Dielectric Strength	20 kV/mm according to IEC 243
Flammability	UL 224 VW-1



PART NO.	TYPE	Trade Size	Supplied Ø (D) in. (mm)	Recovered Ø (d) in. (mm)	Wall Thickness (WT) in. (mm)	Color	Pkg. Qty.
300-73601*	TCN20-1.6/0.8	1/16	0.062 (1.6)	0.032 (0.8)	0.013 (0.4)	Black	1000 ft
300-73602*	TCN20-2.4/1.2	3/32	0.094 (2.4)	0.047 (1.2)	0.017 (0.5)	Black	1000 ft
300-73603*	TCN20-3.2/1.6	1/8	0.120 (3.2)	0.062 (1.6)	0.017 (0.5)	Black	1000 ft
300-73604*	TCN20-4.8/2.4	3/16	0.189 (4.8)	0.094 (2.4)	0.019 (0.5)	Black	1000 ft
300-73606*	TCN20-9.5/4.8	3/8	0.370 (9.5)	0.189 (4.8)	0.021 (0.6)	Black	500 ft
300-73607*	TCN20-12.7/6.4	1/2	0.500 (12.7)	0.250 (6.4)	0.025 (0.7)	Black	500 ft
300-73608*	TCN20-19.1/9.5	3/4	0.750 (19.1)	0.370 (9.5)	0.031 (0.8)	Black	200 ft
300-73609*	TCN20-25.4/12.7	1	1.000 (25.4)	0.500 (12.7)	0.035 (0.9)	Black	200 ft
300-73610*	TCN20-38.1/19.1	1-1/2	1.500 (38.1)	0.750 (19.1)	0.040 (1.0)	Black	100 ft
300-73611*	TCN20-50.8/25.4	2	2.000 (50.8)	1.000 (25.4)	0.045 (1.2)	Black	100 ft

Dimensions are approximate and subject to technical changes. Use Part No. for ordering and Type for specification purposes.

*This product meets UL standards. Please see appendix for specific file numbers.



Please note! Not all products listed on this page may have this approval. Please check our website for latest approvals.

Adhesive Lined Medium Wall

MA47 Sticks Adhesive Lined Medium Wall

MA47 is a medium wall heat shrink tubing with an adhesive lining for use in applications up to 1000 volts. The thermoplastic adhesive liner provides excellent moisture sealing and insulation protection of cable joints and terminations. Made of a polyolefin outer material, this tubing has a shrink ratio up to 4 to 1. The adhesive lining begins to activate as the temperature approaches 185° F (85° C). Individually labeled 4-foot sticks come packaged in a retail display box.

Features and Benefits

- Medium wall tubing resists solvents, acids and alkaline solutions while providing good mechanical strength.
- Features robust insulation characteristics designed for low voltage power applications, up to 1000 volts.
- Adhesive lining provides excellent insulation against moisture and humidity.
- Individually tagged 4-foot sticks come in a retail box.



MATERIAL	Polyolefin, cross-linked (PO-X)
Shrink Ratio	up to 4:1
Longitudinal Change After Shrinkage	-10 % max.
Min. Shrink Temperature	+248 °F (+120 °C)
Operating Temperature	-67°F to +230°F (-55°C to +110°C)
Dielectric Strength	>20 kV/mm
Flammability	Not Flame Retardant

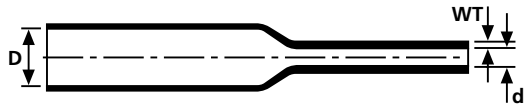

PART NO.	TYPE	Trade Size	Supplied Ø (D) in. (mm)	Recovered Ø (d) in. (mm)	Wall Thickness (WT) in. (mm)	Color	Pkg. Qty.
323-50010	TREDUX MA47-48ST-12/3	1/2	0.47 (12.0)	0.12 (3.0)	0.08 (2.0)	Black	6
323-50011	TREDUX MA47-48ST-19/6	3/4	0.75 (19.0)	0.24 (6.0)	0.09 (2.5)	Black	10
323-50012	TREDUX MA47-48ST-30/8	1-1/4	1.18 (30.0)	0.31 (8.0)	0.09 (2.5)	Black	6
323-50013	TREDUX MA47-48ST-40/12	1-1/2	1.57 (40.0)	0.47 (12.0)	0.09 (2.5)	Black	4
323-50014	TREDUX MA47-48ST-50/16	2	1.97 (50.0)	0.62 (16.0)	0.10 (2.7)	Black	2
323-50015	TREDUX MA47-48ST-63/19	2-1/2	2.48 (63.0)	0.75 (19.0)	0.11 (2.8)	Black	2
323-50016	TREDUX MA47-48ST-75/22	3	2.95 (75.0)	0.86 (22.0)	0.12 (3.0)	Black	2
323-50017	TREDUX MA47-48ST-95/30	3-3/4	3.74 (95.0)	1.18 (30.0)	0.12 (3.0)	Black	1

Dimensions are approximate and subject to technical changes. Use Part No. for ordering and Type for specification purposes.

Routing, Protection and Insulation

Heat Shrink Tubing

Adhesive Lined Thick Wall

HA47 Sticks Adhesive-Lined Thick Wall

HA47 is a thick-wall adhesive lined heat shrink tubing for use in applications up to 1000 volts. The adhesive lining provides excellent moisture sealing and weather protection, making it suitable for above and below ground applications. Made of a polyolefin outer material, this tubing has a shrink ratio up to 3.5 to 1. The adhesive lining begins to activate as the temperature approaches 185° F (85° C).

Features and Benefits

- Thick, semi-flexible exterior wall is well-suited for applications up to 1000 volts, above or below ground.
- Adhesive lining provides excellent insulation against moisture and humidity.
- Individually tagged 4-foot sticks come in a retail box.

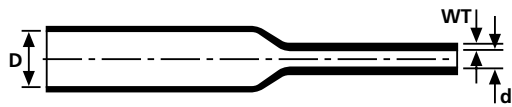

MATERIAL	Polyolefin, cross-linked (PO-X)
Shrink Ratio	up to 3.5:1
Longitudinal Change After Shrinkage	-10 % max.
Min. Shrink Temperature	+248 °F (+120 °C)
Operating Temperature	-67°F to +230°F (-55°C to +110°C)
Softening Point Adhesive	+185°F (+85°C)
Dielectric Strength	>20 kV/mm
Flammability	Not Flame Retardant



PART NO.	TYPE	Trade Size	Supplied Ø (D) in. (mm)	Recovered Ø (d) in. (mm)	Wall Thickness (WT) in. (mm)	Color	Pkg. Qty.
321-50010	TREDUX HA47-48ST-13/4	1/2	0.51 (13.0)	0.16 (4.0)	0.09 (2.4)	Black	6
321-50011	TREDUX HA47-48ST-19/6	3/4	0.75 (19.0)	0.24 (6.0)	0.11 (2.7)	Black	10
321-50012	TREDUX HA47-48ST-33/8	1-1/4	1.30 (33.0)	0.32 (8.0)	0.13 (3.2)	Black	5
321-50013	TREDUX HA47-48ST-45/12	1-3/4	1.77 (45.0)	0.47 (12.0)	0.16 (4.1)	Black	4
321-50014	TREDUX HA47-48ST-51/16	2	2.01 (51.0)	0.63 (16.0)	0.16 (4.1)	Black	2
321-50015	TREDUX HA47-48ST-68/22	2-3/4	2.67 (68.0)	0.87 (22.0)	0.16 (4.1)	Black	1
321-50016	TREDUX HA47-48ST-85/25	3-1/4	3.35 (85.0)	0.98 (25.0)	0.17 (4.3)	Black	1

Dimensions are approximate and subject to technical changes. Use Part No. for ordering and Type for specification purposes.

Worldwide expertise, tailor-made solutions.

Heat shrinkable molded shapes combine quick, easy installation with high electric strength, mechanical toughness and superior chemical and environmental resistance.

Strain-relieving boots, transitions and connector backshell covers, as well as other specialized shapes, protect applications ranging from insulation and protection of individual components to fabrication of complete interconnected cable harness assemblies.

MADE FOR REAL 

See the rugged options available to protect your connections from moisture, weather and more:
www.hellermann.tyton.com/MoldedShapes





TagPrintPRO 4.0

Label Creation Software

For use with HellermannTyton labeling systems

- Create fully code-compliant labels with ease.
- Print automation allows one-step printing of multi-label groups.
- Pre-loaded with popular safety and solar label designs.
- See saved label designs before opening them.
- Advanced options allow users to dial-in ultimate printing control.
- Boost efficiency and reduce operator errors.

Next Gen Identification

HellermannTyton delivers the full spectrum in industrial-grade identification products. We have the product breadth and, just as important, the expertise, to cover any application and workflow. Durable labels and signs perform indoors or out. Advanced label creation software saves time and reduces mistakes. Dependable thermal printers provide fast, professional results. And, a comprehensive service and protection package supports it all.

Thermal Transfer Printer Labels	386
Laser Printer Labels	407
Ink Jet Printer Labels	414
Dot Matrix Printer Labels.....	418
Heat Shrink Labels	422
Foam Nameplate Labels	426
Hand Writable Labels and Tags	429
Printable Plastic Tags.....	438
Preprinted Wire Labels	439
Solar Identification	444
Paint Masks	470
Safety Labels.....	472
Thermal Transfer Printers	478
Labeling Software	485

Labels for Thermal Transfer Printers

Thermal Transfer Self-Laminating Labels

HellermannTyton thermal transfer self-laminating labels are a conformable vinyl film with a white printable surface followed by a clear tail that laminates the printed text when applied to a wire or cable. The labels are UL recognized for indoor and outdoor use with an aggressive acrylic adhesive that allows the label to bond to large and small diameter wires.

Features and Benefits

- HellermannTyton Self-Laminating Labels come on rolls on a standard 3" core for easy loading into a printer or caddy.
- Labels are conformable so that they can bend around small gauge wires and tight bends without coming loose over time.
- Labels are UL recognized for indoor and outdoor use to expand application options.
- HellermannTyton thermal transfer labels work in any thermal transfer printer so that the user always has options to get labels printed without being locked into a single vendor.



MATERIAL	Type 100B
Adhesive	Acrylic
Operating Temperature	-40°F to +194°F (-40°C to +90°C)

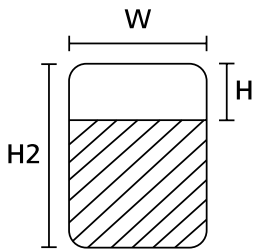

PART NO.	TYPE	Label Width (W) in. (mm)	Printable Area Height (H) in. (mm)	Label Height (H2) in. (mm)	Vertical Repeat in. (mm)	Horizontal Repeat in. (mm)	Liner Width in. (mm)	Labels per Row	Color	Qty. per Roll
TAG26T6-100B*	TAG26T6	0.50 (12.7)	0.38 (9.5)	0.75 (19.1)	1.00 (25.4)	0.50 (12.7)	3.35 (85.1)	6	White	10000
TAG2T5-100B*	TAG2T5	0.50 (12.7)	0.50 (12.7)	1.43 (36.3)	1.62 (41.3)	0.66 (16.8)	3.35 (85.1)	5	White	10000
TAG51T3-100B*	TAG51T3	1.00 (25.4)	0.35 (8.9)	0.75 (19.1)	0.94 (23.7)	1.07 (27.2)	3.35 (85.1)	3	White	10000
TAG22T2-100B*	TAG22T2	1.00 (25.4)	0.50 (12.7)	1.43 (36.3)	1.62 (41.3)	1.07 (27.2)	2.25 (57.1)	2	White	5000
TAG22T3-100B*	TAG22T3	1.00 (25.4)	0.50 (12.7)	1.43 (36.3)	1.62 (41.3)	1.07 (27.2)	3.35 (85.1)	3	White	5000
TAG9T3-100B*	TAG9T3	1.00 (25.4)	1.00 (25.4)	2.25 (57.2)	2.50 (63.5)	1.07 (27.2)	3.35 (85.1)	3	White	5000

Dimensions are approximate and subject to technical changes. Use Part No. for ordering and Type for specification purposes.

*This product meets UL standards. Please see appendix for specific file numbers.



Please note! Not all products listed on this page may have this approval. Please check our website for latest approvals.

Labels for Thermal Transfer Printers

Thermal Transfer Self-Laminating Labels

PART NO.	TYPE	Label Width (W) in. (mm)	Printable Area Height (H) in. (mm)	Label Height (H2) in. (mm)	Vertical Repeat in. (mm)	Horizontal Repeat in. (mm)	Liner Width in. (mm)	Labels per Row	Color	Qty. per Roll
TAG3T3-100B*	TAG3T3	1.00 (25.4)	1.00 (25.4)	3.75 (95.3)	4.00 (101.6)	1.00 (25.4)	3.35 (85.1)	3	White	3000
TAG38T4-100B*	TAG38T4	1.00 (25.4)	1.50 (38.1)	7.35 (186.7)	7.75 (196.8)	1.00 (25.4)	4.10 (104.1)	4	White	1000
TAG53T2-100B*	TAG53T2	1.50 (38.1)	0.70 (17.8)	1.43 (36.5)	1.62 (41.3)	1.50 (38.1)	3.35 (89.1)	2	White	2500
TAG1T1-100B*	TAG1T1	1.90 (48.3)	0.75 (19.1)	3.12 (79.2)	3.42 (86.8)	2.00 (50.8)	3.88 (98.4)	1	White	2500
TAG24T1-100B*	TAG24T1	2.00 (50.8)	0.50 (12.7)	1.43 (36.3)	1.68 (42.6)	2.00 (50.8)	2.20 (55.9)	1	White	1000
TAG10T2-100B*	TAG10T2	2.00 (50.8)	0.75 (19.1)	2.25 (57.2)	2.50 (63.5)	2.00 (50.8)	3.88 (98.4)	2	White	2500
TAG6T1-100B*	TAG6T1	2.00 (50.8)	1.50 (38.1)	3.75 (95.3)	4.00 (101.6)	2.00 (50.8)	2.20 (55.9)	1	White	1000
TAG7T1-100B*	TAG7T1	2.00 (50.8)	1.50 (38.1)	7.34 (186.4)	7.75 (196.8)	2.00 (50.8)	4.10 (104.1)	2	White	1000

Dimensions are approximate and subject to technical changes. Use Part No. for ordering and Type for specification purposes.

*This product meets UL standards. Please see appendix for specific file numbers.



Please note! Not all products listed on this page may have this approval. Please check our website for latest approvals.

Labels for Thermal Transfer Printers

Thermal Transfer Labels - Nylon Cloth

These labels are manufactured from a robust fabric that allows for conformable identification to most curved and flat surfaces. The material can also be used as a cable flag to identify cables that require more information.

Features and Benefits

- Cloth is conformable to adhere to a wide variety of curved and compound surfaces.
- The adhesive sticks to itself and can be used for flag wrap applications.

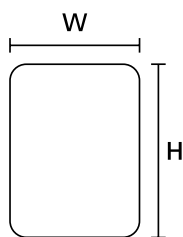

MATERIAL	Type 250, Nylon Cloth, white (WH)
Adhesive	Acrylic
Operating Temperature	-40°F to +248°F (-40°C to +120°C)



PART NO.	TYPE	Label Width (W) in. (mm)	Label Height (H) in. (mm)	Vertical Repeat in. (mm)	Horizontal Repeat in. (mm)	Liner Width in. (mm)	Labels per Row	Color	Qty. per Roll
TAG21T6-250	TAG21T6	0.50 (12.7)	0.75 (19.1)	0.88 (22.2)	0.50 (12.7)	3.25 (82.6)	6	White	10000
TAG11T4-250	TAG11T4	0.65 (16.5)	0.20 (5.1)	0.50 (12.7)	0.65 (16.5)	2.60 (66.0)	4	White	5000
TAG28T4-250	TAG28T4	0.80 (20.3)	1.43 (36.3)	1.62 (41.1)	0.80 (20.3)	3.45 (87.6)	4	White	5000
TAG15T3-250	TAG15T3	1.00 (25.4)	0.50 (12.7)	0.60 (15.2)	1.00 (25.4)	3.35 (85.1)	3	White	10000
TAG35T2-250	TAG35T2	2.00 (50.8)	0.38 (9.5)	0.50 (12.7)	2.00 (50.8)	4.10 (104.1)	2	White	10000

Dimensions are approximate and subject to technical changes. Use Part No. for ordering and Type for specification purposes.

Labels for Thermal Transfer Printers

Thermal Transfer Labels - 336 Polyester

HellermannTyton white polyester labels are ideal for marking small electrical and electronic components, such as EPROMS', Integrated circuits, as well as the circuit board itself. Printed labels can withstand the soldering process and survive flux removal when the board is washed. HellermannTyton's 336 material is designed for use on flat surfaces and can also be used to identify connectors, buttons and just about anything requiring permanent, durable, high temperature and UV resistant marking.

Features and Benefits

- White polyester is glossy, allowing for the highest resolution and print contrast.
- The acrylic-based adhesive bonds to a wide variety of substrates and can withstand high temperatures long term.

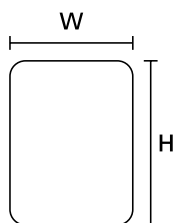

MATERIAL	Type 336, Polyester
Adhesive	Acrylic
Operating Temperature	-40°F to +302°F (-40°C to +150°C)



PART NO.	TYPE	Label Width (W) in. (mm)	Label Height (H) in. (mm)	Vertical Repeat in. (mm)	Horizontal Repeat in. (mm)	Liner Width in. (mm)	Labels per Row	Color	Qty. per Roll
TAG96T1-336	TAG96T1	1.90 (48.2)	0.25 (6.4)	0.38 (9.4)	1.90 (48.2)	2.00 (50.8)	1	White	5000
TAG69T1-336*	TAG69T1	2.00 (50.8)	0.28 (7.0)	0.50 (12.7)	2.00 (50.8)	2.13 (54.0)	1	White	10000
TAG68T1-336*	TAG68T1	3.80 (96.5)	0.28 (7.0)	0.50 (12.7)	3.80 (96.5)	4.00 (101.6)	1	White	10000

Dimensions are approximate and subject to technical changes. Use Part No. for ordering and Type for specification purposes.

*This product meets UL standards. Please see appendix for specific file numbers.



Please note! Not all products listed on this page may have this approval. Please check our website for latest approvals.

Identification

Labels

Labels for Thermal Transfer Printers

Thermal Transfer Labels - 795 Polyester

HellermannTyton's metallized polyester labels include a layer of metallic particles that give the appearance of being made of metal. Applications include asset tracking and product rating plates. The high operating temperature makes them suitable for use on electronic equipment. Great for replacing expensive metal stampings, engravings and even silk screened rating plates, the printed labels offer high quality imaging for text and graphics and can be permanently placed on a wide variety of flat surfaces.

Features and Benefits

- Metallized polyester has a matte finish, allowing for the highest resolution and print contrast.
- The acrylic-based adhesive bonds to a wide variety of substrates and can withstand high temperatures long term.

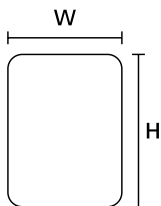

MATERIAL	Type 795, Polyester (PET)
Adhesive	Acrylic
Operating Temperature	-40°F to +300°F (-40°C to +149°C)



PART NO.	TYPE	Label Width (W) in. (mm)	Label Height (H) in. (mm)	Vertical Repeat in. (mm)	Horizontal Repeat in. (mm)	Liner Width in. (mm)	Labels per Row	Color	Qty. per Roll
TAG15T3-795*	TAG15T3	1.00 (25.4)	0.50 (12.7)	0.60 (15.2)	1.07 (27.2)	3.35 (85.1)	3	Silver	10000
TAG27T1-795*	TAG27T1	1.50 (38.1)	0.75 (19.1)	0.88 (22.2)	1.50 (38.1)	2.20 (55.9)	1	Silver	3000
TAG75T1-795*	TAG75T1	2.00 (50.8)	0.63 (15.9)	0.75 (19.1)	2.00 (50.8)	2.12 (53.8)	1	Silver	2000
TAG73T1-795*	TAG73T1	2.00 (50.8)	1.00 (25.4)	1.12 (28.4)	2.00 (50.8)	2.20 (55.8)	1	Silver	3000
TAG76T1-795*	TAG76T1	2.50 (63.5)	2.00 (50.8)	2.12 (53.8)	2.50 (63.5)	2.62 (66.5)	1	Silver	1000
TAG72T1-795*	TAG72T1	2.75 (69.9)	1.25 (31.0)	1.38 (34.9)	2.75 (69.9)	2.95 (75.0)	1	Silver	3000
TAG78T1-795*	TAG78T1	3.00 (76.2)	4.00 (101.6)	4.12 (104.7)	3.00 (76.2)	3.12 (79.2)	1	Silver	500
TAG80T1-795*	TAG80T1	3.00 (76.2)	5.00 (127.0)	5.12 (130.5)	3.00 (76.2)	3.13 (79.4)	1	Silver	500
TAG79T1-795*	TAG79T1	4.00 (101.6)	2.00 (50.8)	2.12 (54.0)	4.00 (101.6)	4.25 (107.9)	1	Silver	500

Dimensions are approximate and subject to technical changes. Use Part No. for ordering and Type for specification purposes.

*This product meets UL standards. Please see appendix for specific file numbers.



Please note! Not all products listed on this page may have this approval. Please check our website for latest approvals.

Labels for Thermal Transfer Printers

Thermal Transfer Labels - 822 Polyester

HellermannTyton white polyester labels are ideal for marking small electrical and electronic components, such as EPROMS', Integrated circuits, as well as the circuit board itself. Printed labels can withstand the soldering process and survive flux removal when the board is washed. HellermannTyton's 822 material is designed for use on flat surfaces and can also be used to identify connectors, buttons and just about anything requiring permanent, durable, high temperature and UV resistant marking.

Features and Benefits

- White polyester is glossy, allowing for the highest resolution and print contrast.
- The acrylic-based adhesive bonds to a wide variety of substrates and can withstand high temperatures long term.

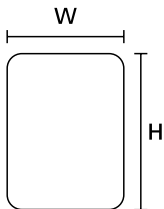

MATERIAL	Type 822, Polyester (PET)
Adhesive	Acrylic
Operating Temperature	-40°F to +302°F (-40°C to +150°C)



PART NO.	TYPE	Label Width (W) in. (mm)	Label Height (H) in. (mm)	Vertical Repeat in. (mm)	Horizontal Repeat in. (mm)	Liner Width in. (mm)	Labels per Row	Color	Qty. per Roll
TAG70T12-822*	TAG70T12	0.25 (6.4)	0.25 (6.4)	0.50 (12.7)	0.25 (6.4)	3.20 (81.2)	12	White	10000
TAG81T8-822*	TAG81T8	0.32 (8.3)	0.20 (5.1)	0.32 (8.3)	0.32 (8.3)	2.60 (66.0)	8	White	5000
TAG71T5-822*	TAG71T5	0.50 (12.7)	0.43 (12.7)	0.66 (16.8)	0.50 (12.7)	3.35 (85.1)	5	White	10000
TAGPP1T6-82210M*	TAGPP1T6	0.63 (15.9)	0.33 (7.9)	0.75 (19.1)	0.63 (15.9)	3.80 (96.5)	6	White	10000
TAGPP1T6-822*		0.63 (15.9)	0.33 (7.9)	0.75 (19.1)	0.63 (15.9)	3.80 (96.5)	6	White	1000
TAG11T4-822*	TAG11T4	0.65 (16.5)	0.20 (5.1)	0.50 (12.7)	0.65 (16.5)	2.60 (66.0)	4	White	5000
TAGPP3T4-822*	TAGPP3T4	0.69 (17.5)	0.25 (6.4)	0.38 (9.5)	0.69 (17.5)	2.90 (73.7)	4	White	1000
TAG13T4-822*	TAG13T4	0.75 (19.1)	0.25 (6.4)	0.35 (8.9)	0.75 (19.1)	3.35 (85.1)	4	White	10000
TAG16T3-822*	TAG16T3	0.90 (22.9)	0.25 (6.4)	0.35 (8.9)	0.90 (22.9)	3.35 (85.1)	3	White	10000

Dimensions are approximate and subject to technical changes. Use Part No. for ordering and Type for specification purposes.

*This product meets UL standards. Please see appendix for specific file numbers.



Please note! Not all products listed on this page may have this approval. Please check our website for latest approvals.

Labels for Thermal Transfer Printers

Thermal Transfer Labels - 822 Polyester

PART NO.	TYPE	Label Width (W) in. (mm)	Label Height (H) in. (mm)	Vertical Repeat in. (mm)	Horizontal Repeat in. (mm)	Liner Width in. (mm)	Labels per Row	Color	Qty. per Roll
TAG15T3-822*	TAG15T3	1.00 (25.4)	0.50 (12.7)	0.60 (15.2)	1.07 (27.2)	3.35 (85.1)	3	White	10000
TAG84T3-822*	TAG84T3	1.25 (31.8)	0.38 (31.8)	0.50 (12.7)	1.25 (31.8)	4.00 (101.6)	3	White	10000
TAG82T2-822*	TAG82T2	1.50 (38.1)	0.25 (6.4)	0.30 (7.6)	1.50 (38.1)	3.20 (81.3)	2	White	10000
TAG17T2-822*	TAG17T2	1.50 (38.1)	0.25 (6.4)	0.35 (8.9)	1.50 (38.1)	3.35 (85.1)	2	White	10000
TAG27T1-822*	TAG27T1	1.50 (38.1)	0.75 (19.1)	0.88 (22.2)	1.50 (38.1)	2.20 (55.9)	1	White	3000
TAG75T1-822*	TAG75T1	2.00 (50.8)	0.63 (15.9)	0.75 (19.1)	2.00 (50.8)	2.12 (53.8)	1	White	2000
TAG73T1-822*	TAG73T1	2.00 (50.8)	1.00 (25.4)	1.13 (28.6)	2.00 (50.8)	2.20 (55.8)	1	White	3000
TAG72T1-822*	TAG72T1	2.75 (69.8)	1.25 (31.0)	1.38 (34.9)	2.75 (69.9)	2.95 (75.0)	1	White	3000
TAG83T1-822*	TAG83T1	4.00 (101.6)	0.31 (7.9)	0.44 (11.1)	4.00 (101.6)	4.10 (104.1)	1	White	5000

Dimensions are approximate and subject to technical changes. Use Part No. for ordering and Type for specification purposes.

*This product meets UL standards. Please see appendix for specific file numbers.



Please note! Not all products listed on this page may have this approval. Please check our website for latest approvals.

Labels for Thermal Transfer Printers

Thermal Transfer Labels - 822C Polyester

HellermannTyton transparent/clear polyester labels are ideal for marking products where the visibility of the label needs to be minimized, such as consumer products, where the color of the housing needs to remain as clean looking as possible. The clear material allows the surface color to blend in with the printed text. These labels can also be used as an over-laminate to provide further protection for printed text in extreme environments.

Features and Benefits

- Clear polyester is glossy, allowing for the highest resolution and print contrast.
- The acrylic-based adhesive bonds to a wide variety of substrates and can withstand high temperatures long term.



MATERIAL	Type 822C, Clear Polyester (CL)
Adhesive	Acrylic
Operating Temperature	-40°F to +302°F (-40°C to +150°C)

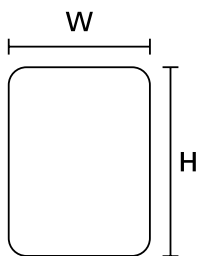

PART NO.	TYPE	Label Width (W) in. (mm)	Label Height (H) in. (mm)	Vertical Repeat in. (mm)	Horizontal Repeat in. (mm)	Liner Width in. (mm)	Labels per Row	Color	Qty. per Roll
TAGPP1T6-822C*	TAGPP1T6	0.63 (15.9)	0.33 (7.9)	0.75 (19.1)	0.63 (15.9)	3.80 (96.5)	6	Clear	1000
TAGPP1T6-822C10M*		0.63 (15.9)	0.33 (7.9)	0.75 (19.1)	0.63 (15.9)	3.80 (96.5)	6	Clear	10000
TAG11T4-822C*	TAG11T4	0.65 (16.5)	0.20 (5.1)	0.50 (12.7)	0.65 (16.5)	2.60 (66.0)	4	Clear	5000
TAG15T3-822C10M*	TAG15T3	1.00 (25.4)	0.50 (12.7)	0.60 (15.2)	1.00 (25.4)	3.35 (85.1)	3	Clear	10000
TAG27T1-822C	TAG27T1	1.50 (38.1)	0.75 (19.1)	0.88 (22.2)	1.50 (38.1)	2.20 (55.9)	1	Clear	3000

Dimensions are approximate and subject to technical changes. Use Part No. for ordering and Type for specification purposes.

*This product meets UL standards. Please see appendix for specific file numbers.



Please note! Not all products listed on this page may have this approval. Please check our website for latest approvals.

Labels for Thermal Transfer Printers

Thermal Transfer Labels - 840W Polyester

For the ultimate in chemical and solvent resistance and long term outdoor durability, the 840 white polyester offers the most aggressive performance features of any other polyester label material. With an initial outdoor life of 7 years, the labels have been tested far beyond the published limits and the acrylic adhesive bonds well to powder coat painted surfaces as well as baked enamel and slightly textured substrates.

Features and Benefits

- White polyester is glossy, allowing for the highest resolution and print contrast.
- The acrylic-based adhesive bonds to a wide variety of substrates and can withstand high temperatures long term.
- The printable surface is highly resistant to chemicals and solvents and can withstand long-term UV exposure.



MATERIAL	Type 840W, Polyester (PET), White (WH)
Adhesive	High Bond Acrylic
Operating Temperature	-40°F to +300°F (-40°C to +149°C)

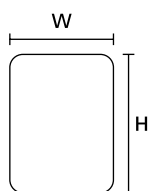

PART NO.	TYPE	Label Width (W) in. (mm)	Label Height (H) in. (mm)	Vertical Repeat in. (mm)	Horizontal Repeat in. (mm)	Liner Width in. (mm)	Labels per Row	Color	Qty. per Roll
596-73833*	PCP2X1	2.00 (50.8)	1.00 (25.4)	1.13 (28.6)	2.00 (50.8)	2.20 (122.9)	1	White	3000
596-73834*	PCP3X1	3.00 (76.2)	1.00 (25.4)	1.13 (28.6)	3.00 (76.2)	3.20 (81.3)	1	White	3000
596-73835*	PCP4X3	4.00 (101.6)	3.00 (76.2)	3.13 (79.4)	4.00 (101.6)	4.20 (106.7)	1	White	1000

Dimensions are approximate and subject to technical changes. Use Part No. for ordering and Type for specification purposes.

*This product meets UL standards. Please see appendix for specific file numbers.



Please note! Not all products listed on this page may have this approval. Please check our website for latest approvals.

Labels for Thermal Transfer Printers

Thermal Transfer Labels - Paper

These labels serve as general purpose identification for use on clear plastic bags. The aggressive adhesive is designed to adhere to all types of polyethylene bags, ensuring the printed information remains on the bag long term. Best for indoor use, inventory and packaging, as well as office and shipping identification.

Features and Benefits

- Paper utilizes a rubber-based adhesive for immediate tack to any surface.
- Good for temporary identification of bags and boxes and best for indoor use.

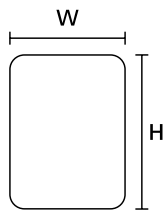

MATERIAL	Type 101, paper, white (WH)
Adhesive	Acrylic
Operating Temperature	-65°F to +200°F (-54°C to +93°C)



PART NO.	TYPE	Label Width (W) in. (mm)	Label Height (H) in. (mm)	Vertical Repeat in. (mm)	Horizontal Repeat in. (mm)	Liner Width in. (mm)	Labels per Row	Color	Qty. per Roll
TAG77T1-101	TAG77T1	3.00 (76.2)	0.94 (76.2)	1.00 (25.4)	3.00 (76.2)	3.12 (79.2)	1	White	2000

Dimensions are approximate and subject to technical changes. Use Part No. for ordering and Type for specification purposes.

Labels for Thermal Transfer Printers

Thermal Transfer Labels - Polyethylene

HellermannTyton's polyethylene labels are smooth and conformable to most surfaces. The material's ability to withstand areas where oil and moisture are present is an important feature. Bonds well to low surface energy plastics such as polypropylene and nylon. A low cost alternative to cloth style labels.

Features and Benefits

- Polyethylene is conformable to adhere to a wide variety of curved and compound surfaces.
- The adhesive sticks to itself and can be used for flag wrap applications.
- The smooth, printable surface allows for high-quality imaging for text and graphics.

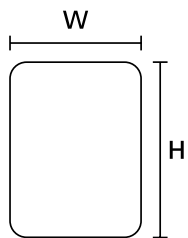

MATERIAL	Polyethylene (PE)
Adhesive	Acrylic
Operating Temperature	-40°F to +176°F (-40°C to +80°C)



PART NO.	TYPE	Label Width (W) in. (mm)	Label Height (H) in. (mm)	Vertical Repeat in. (mm)	Horizontal Repeat in. (mm)	Liner Width in. (mm)	Labels per Row	Color	Qty. per Roll
596-21251	TAG21T6	0.50 (12.7)	0.75 (19.1)	0.88 (22.2)	0.50 (12.7)	3.25 (82.6)	6	White	10000
596-28251	TAG28T4	0.80 (20.3)	1.43 (36.3)	1.62 (41.1)	0.80 (20.3)	3.45 (87.6)	4	White	5000

Dimensions are approximate and subject to technical changes. Use Part No. for ordering and Type for specification purposes.

Labels for Thermal Transfer Printers

Thermal Transfer Labels - Polyolefin

HellermannTyton white polyolefin labels are ideal for marking small electrical and electronic components, such as EPROMS', Integrated circuits, as well as the circuit board itself. Printed labels can withstand the soldering process and survive flux removal when the board is washed. HellermannTyton's polyolefin material is designed for use on flat surfaces and can also be used to identify connectors, buttons and just about anything requiring permanent, durable, high temperature and UV resistant marking.

Features and Benefits

- White polyester is glossy, allowing for the highest resolution and print contrast.
- The acrylic-based adhesive bonds to a wide variety of substrates and can withstand high temperatures long term.



MATERIAL	Polyolefin (PO)
Adhesive	Acrylic
Operating Temperature	-40°F to +140°F (-40°C to +60°C)

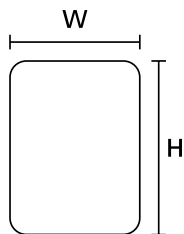

PART NO.	TYPE	Label Width (W) in. (mm)	Label Height (H) in. (mm)	Vertical Repeat in. (mm)	Horizontal Repeat in. (mm)	Liner Width in. (mm)	Labels per Row	Color	Qty. per Roll
TAG13T4-DTH	TAG13T4	0.75 (19.1)	0.25 (6.4)	0.35 (8.9)	0.75 (19.1)	3.35 (85.1)	4	White	10000
TAG16T3-DTH	TAG16T3	0.90 (22.9)	0.25 (6.4)	0.35 (8.9)	0.90 (22.9)	3.35 (85.1)	3	White	10000
TAG15T3-DTH	TAG15T3	1.00 (25.4)	0.50 (12.7)	0.60 (15.2)	1.10 (27.9)	3.35 (85.1)	3	White	10000
TAG27T2-DTH	TAG27T2	1.50 (38.1)	0.75 (19.1)	0.88 (22.2)	1.50 (38.1)	2.20 (55.8)	2	White	10000
TAG73T1-DTH*	TAG73T1	2.00 (50.8)	1.00 (25.4)	1.13 (28.6)	2.00 (50.8)	2.20 (55.8)	1	White	3000
TAG33T1-DTH	TAG33T1	3.00 (76.2)	2.00 (50.8)	2.13 (54.0)	3.00 (76.2)	3.10 (78.7)	1	White	1000

Dimensions are approximate and subject to technical changes. Use Part No. for ordering and Type for specification purposes.

*This product meets UL standards. Please see appendix for specific file numbers.



Please note! Not all products listed on this page may have this approval. Please check our website for latest approvals.

Labels for Thermal Transfer Printers

Continuous Vinyl Labels

Continuous Vinyl Labels are made with UV-stable materials for long outdoor life. The labels are extruded in the actual color and not colored using surface inks for long-term fade resistance. Vinyl labels are provided in continuous rolls so that the markers can be printed and cut to any length using HellermannTyton thermal transfer printing systems. Good for all surface types except powder coat painted or low surface energy substrates such as polypropylene. Test on these surfaces before approving.

Features and Benefits

- Pre-printed header striped continuous vinyl rolls come in different header colors, providing a variety of printing options.
- The headers can be printed with various ARC FLASH, WARNING And CAUTION headlines to meet OSHA safety standards for identifying electrical panels and equipment.
- Signs can be designed in Tagprint Pro labeling software and printed with any HellermannTyton thermal transfer printing system with optional cutter attached.



MATERIAL	Vinyl
Adhesive	Acrylic
Operating Temperature	-40°F to +180°F (-40°C to +82°C)



PART NO.	TYPE	Label Width (W) in. (mm)	Roll Length (L) ft. (m)	Color
558-00307*	HT1BK250	1.0 (25.4)	250.0 (76.2)	Black
558-00339	HT1BU250	1.0 (25.4)	250.0 (76.2)	Blue
558-00340	HT1GN250	1.0 (25.4)	250.0 (76.2)	Green
558-00336	HT1OE250	1.0 (25.4)	250.0 (76.2)	Orange
558-00308*	HT1RD250	1.0 (25.4)	250.0 (76.2)	Red
558-00309*	HT1WH250	1.0 (25.4)	250.0 (76.2)	White
558-00310*	HT1YE250	1.0 (25.4)	250.0 (76.2)	Yellow
558-00311*	HT2BK250	2.0 (50.8)	250.0 (76.2)	Black
558-00341	HT2BU250	2.0 (50.8)	250.0 (76.2)	Blue
558-00342	HT2GN250	2.0 (50.8)	250.0 (76.2)	Green
558-00337	HT2OE250	2.0 (50.8)	250.0 (76.2)	Orange

Dimensions are approximate and subject to technical changes. Use Part No. for ordering and Type for specification purposes.

*This product meets UL standards. Please see appendix for specific file numbers.



Please note! Not all products listed on this page may have this approval. Please check our website for latest approvals.

Labels for Thermal Transfer Printers

Continuous Vinyl Labels

PART NO.	TYPE	Label Width (W) in. (mm)	Roll Length (L) ft. (m)	Color
558-00312*	HT2RD250	2.0 (50.8)	250.0 (76.2)	Red
558-00372	HT2RDRF250	2.0 (50.8)	250.0 (76.2)	Red Reflective
558-00313*	HT2WH250	2.0 (50.8)	250.0 (76.2)	White
558-00314*	HT2YE250	2.0 (50.8)	250.0 (76.2)	Yellow
558-00373*	HT3RDRF250	3.0 (76.2)	100.0 (30.5)	Red Reflective
558-00374*	HT3BK250	3.0 (76.2)	250.0 (76.2)	Black
558-00343	HT3BU250	3.0 (76.2)	250.0 (76.2)	Blue
558-00344	HT3GN250	3.0 (76.2)	250.0 (76.2)	Green
558-00338	HT3OE250	3.0 (76.2)	250.0 (76.2)	Orange
558-00006*	HT3RD250	3.0 (76.2)	250.0 (76.2)	Red
558-00345*	HT3WH250	3.0 (76.2)	250.0 (76.2)	White
558-00346*	HT3YE250	3.0 (76.2)	250.0 (76.2)	Yellow
558-00351	HT4GN250	4.0 (101.6)	250.0 (76.2)	Green
558-00370*	HT4RD250	4.0 (101.6)	250.0 (76.2)	Red
558-00350*	HT4WH250	4.0 (101.6)	250.0 (76.2)	White
558-00411	HT4OE250	4.0 (101.6)	250.0 (76.2)	Orange
558-00377	HT1RDRF250	1.0 (25.4)	250.0 (76.2)	Red Reflective
558-00407	HT4RDF100	4.0 (101.6)	100.0 (30.5)	Red Reflective
558-00358	HT4YE250	4.0 (101.6)	250.0 (76.2)	Yellow

Dimensions are approximate and subject to technical changes. Use Part No. for ordering and Type for specification purposes.
 *This product meets UL standards. Please see appendix for specific file numbers.



Please note! Not all products listed on this page may have this approval. Please check our website for latest approvals.

Labels for Thermal Transfer Printers

Banded Colored Continuous Rolls - 840/926 Polyester

Banded colored continuous rolls come with a stripe (band) for easy printing of warning labels. Available in different widths, these labels are designed for use with TagPrint® Pro software and HellermannTyton thermal transfer printers and can be customized, produced on demand and cut to any length.

Features and Benefits

- Continuous Colored Signal Panel labels come with yellow or orange stripes for easy printing of caution and warning labels.
- Continuous labels allow for designing and cutting labels to any length.
- Various widths are available so that a wide variety of sign sizes can be customized and produced on demand.



MATERIAL	Type 840/926, Polyester (PET), UV stable, clear Polyester laminate
Adhesive	Acrylic
Operating Temperature	-40°F to +302°F (-40°C to +150°C)



PART NO.	TYPE	Label Width (W) in. (mm)	Roll Length (L) ft. (m)	Color
558-00380*	HT2OE50250UV	2.0 (50.8)	250.0 (76.2)	Orange
558-00381*	HT3OE75250UV	3.0 (76.2)	250.0 (76.2)	Orange
558-00382	HT4OE10250UV	4.0 (101.6)	250.0 (76.2)	Orange

Dimensions are approximate and subject to technical changes. Use Part No. for ordering and Type for specification purposes.

*This product meets UL standards. Please see appendix for specific file numbers.



Please note! Not all products listed on this page may have this approval. Please check our website for latest approvals.

Labels for Thermal Transfer Printers

High Bond Colored Continuous Rolls

These reflective rolls offer a high bond adhesive that is sustainable for low surface energy substrates such as the low density plastics on the front of an inverter or powder coat paint surfaces. The adhesive is designed to adhere to textured surfaces without peeling or falling off.

Features and Benefits

- Continuous Colored Signal Panel labels come with yellow or orange stripes for easy printing of caution and warning labels.
- Continuous labels allow for designing and cutting labels to any length.
- Various widths are available so that a wide variety of sign sizes can be customized and produced on demand.



MATERIAL	Type 840/926, Polyester (PET), UV stable, clear Polyester laminate
Adhesive	Acrylic
Operating Temperature	-40°F to +302°F (-40°C to +150°C)



PART NO.	TYPE	Label Width (W) in. (mm)	Roll Length (L) ft. (m)	Color
558-00501	HT1RDHB250	1.0 (25.4)	250.0 (76.2)	Red
558-00502	HT2RDHB250	2.0 (50.8)	250.0 (76.2)	Red
558-00503*	HT3RDHB250	3.0 (76.2)	100.0 (30.5)	Red

Dimensions are approximate and subject to technical changes. Use Part No. for ordering and Type for specification purposes.

*This product meets UL standards. Please see appendix for specific file numbers.



Please note! Not all products listed on this page may have this approval. Please check our website for latest approvals.

Labels for Thermal Transfer Printers

Banded Colored Continuous Rolls - 336/926 Polyester

The Pre-printed colored header vinyl rolls can be used to design signs that conform to Occupational Safety and Hazard Association (OSHA) and American National Standards Institute (ANSI) requirements for Warning and Caution Signs and markers. All can be designed, printed and cut to length in Tagprint Pro and any HellermannTyton thermal transfer printing system.

Features and Benefits

- Continuous Colored Signal Panel labels come with yellow or orange stripes for easy printing of caution and warning labels.
- Continuous labels allow for designing and cutting labels to any length.
- Various widths are available so that a wide variety of sign sizes can be customized and produced on demand.



MATERIAL	Type 336/926, Polyester (PET), UV stable, clear Polyester laminate
Adhesive	Acrylic
Operating Temperature	-40°F to +302°F (-40°C to +150°C)



PART NO.	TYPE	Label Width (W) in. (mm)	Roll Length (L) ft. (m)	Color
558-00327*	HT2OE50250	2.0 (50.8)	250.0 (76.2)	Orange
558-00328*	HT2YE50250	2.0 (50.8)	250.0 (76.2)	Yellow
558-00330	HT3OE75250	3.0 (76.2)	250.0 (76.2)	Orange
558-00331	HT3YE75250	3.0 (76.2)	250.0 (76.2)	Yellow
558-00333	HT4OE10250	4.0 (101.6)	250.0 (76.2)	Orange
558-00334	HT4YE10250	4.0 (101.6)	250.0 (76.2)	Yellow

Dimensions are approximate and subject to technical changes. Use Part No. for ordering and Type for specification purposes.

*This product meets UL standards. Please see appendix for specific file numbers.



Please note! Not all products listed on this page may have this approval. Please check our website for latest approvals.

Labels for Thermal Transfer Printers

Pre-Printed Header Labels

The most common signal word signs are DANGER, WARNING, CAUTION, NOTICE and SAFETY as defined by ANSI Z535.4. Each preprinted signal word label comes with the colored signal panel, signal word, and safety alert symbol (if required.) Using TagPrint Pro 4.0 software, the balance of information can easily be designed and printed using presaved templates in the labeling software and any HellermannTyton thermal transfer printer. This solution allows almost unlimited capabilities to create practically any conceivable sign on demand with no minimums.

Features and Benefits

- Pre-Printed Signal Word Labels are made with UV-stable inks and materials for durability and weather resistance.
- Polyester is resistant to chemicals and solvents and will remain legible in dirty environments.
- High abrasion and scuff resistance for high performance labeling.
- Meets NEC & IFC standards for printed text, character height, color and outdoor UV stability to pass inspections.



MATERIAL	Polyester (PET)
Adhesive	Acrylic
Operating Temperature	-40°F to +302°F (-40°C to +150°C)



PART NO.	TYPE	Description	Label Width (W) in. (mm)	Label Height (H) in. (mm)	Vertical Repeat in. (mm)	Horizontal Repeat in. (mm)	Liner Width in. (mm)	Labels per Row	Color	Qty. per Roll
596-00378*	WV275X135	WARNING Header, Orange with Blank Yellow Triangle	1.35 (34.3)	2.75 (69.9)	2.88 (73.0)	1.35 (34.3)	1.40 (35.6)	1	Orange	250
596-00386*	WS275X135	WARNING Header, White with Orange	1.35 (34.3)	2.75 (69.9)	2.88 (73.0)	1.35 (34.3)	1.40 (35.6)	1	Orange	250
596-00387*	DS275X135	DANGER Header, White with Red	1.35 (34.3)	2.75 (69.9)	2.88 (73.0)	1.35 (34.3)	1.40 (35.6)	1	Red	250
596-00379*	DV275X135	WARNING Header, Red with Blank Yellow Triangle	1.35 (34.3)	2.75 (69.9)	2.88 (73.0)	1.35 (34.3)	1.40 (355.6)	1	Red	250
596-00376*	WV55X275	WARNING Header, White with Orange	2.75 (69.8)	5.50 (139.7)	5.63 (142.9)	2.75 (69.9)	2.80 (71.1)	1	Orange	250
596-00377*	DV55X275	DANGER Header, White with Red	2.75 (69.9)	5.50 (139.7)	5.63 (142.9)	2.75 (69.9)	2.80 (71.1)	1	Red	250
596-00388*	WS55X275	WARNING Header, White with Orange	2.75 (69.9)	5.50 (139.7)	5.63 (142.9)	2.75 (69.9)	2.80 (71.1)	1	Orange	250
596-00389*	DS55X275	DANGER Header, White with Red	2.75 (69.9)	5.50 (139.7)	5.63 (142.9)	2.75 (69.9)	2.80 (71.1)	1	Red	250
596-00372*	3X2SAFETY	SAFETY Header, White with Green	3.00 (76.2)	2.00 (50.4)	2.13 (155.6)	4.00 (101.6)	3.20 (81.2)	1	Green	250

Dimensions are approximate and subject to technical changes. Use Part No. for ordering and Type for specification purposes.
*This product meets UL standards. Please see appendix for specific file numbers.



Please note! Not all products listed on this page may have this approval. Please check our website for latest approvals.

Labels for Thermal Transfer Printers

Pre-Printed Header Labels

PART NO.	TYPE	Description	Label Width (W) in. (mm)	Label Height (H) in. (mm)	Vertical Repeat in. (mm)	Horizontal Repeat in. (mm)	Liner Width in. (mm)	Labels per Row	Color	Qty. per Roll
596-00424*	3X2DANGER	DANGER Header, White with Red	3.00 (76.2)	2.00 (50.8)	2.13 (79.4)	3.00 (76.2)	3.20 (81.2)	1	Red	250
596-00426*	3X2NOTICE	NOTICE Header, White with Blue	3.00 (76.2)	2.00 (50.8)	2.13 (79.4)	3.00 (76.2)	3.20 (81.2)	1	Blue	250
596-00622*	3X2WARNING	WARNING Header, White with Orange	3.00 (76.2)	2.00 (50.8)	2.13 (79.4)	3.00 (76.2)	3.20 (81.2)	1	Orange	250
596-00425*	3X2CAUTION	Yellow CAUTION header	3.00 (76.2)	2.00 (50.8)	2.13 (79.4)	3.00 (76.2)	3.20 (81.2)	1	Yellow	250
596-00204*	4X6NOTICE	NOTICE Header, White with Blue	6.00 (152.4)	4.00 (101.6)	6.13 (155.6)	4.00 (101.6)	4.20 (106.6)	1	Blue	250
596-00621*	4X6WARNING	WARNING Header, White with Orange	6.00 (152.4)	4.00 (101.6)	6.13 (155.6)	4.00 (101.6)	4.20 (106.6)	1	Orange	250
596-00427*	4X6CAUTION	CAUTION Header, White with Yellow	6.00 (152.4)	6.00 (152.4)	2.13 (79.4)	4.00 (101.6)	4.20 (106.6)	1	Yellow	250
596-00371*	4X6SAFETY	SAFETY Header, White with Green	6.00 (152.4)	6.00 (152.4)	6.13 (104.8)	4.00 (101.6)	4.20 (106.6)	1	Green	250
596-00203*	4X6DANGER	DANGER Header, White with Red	6.00 (152.4)	6.00 (152.4)	6.13 (155.6)	4.00 (101.6)	4.20 (106.6)	1	Red	250

Dimensions are approximate and subject to technical changes. Use Part No. for ordering and Type for specification purposes.

*This product meets UL standards. Please see appendix for specific file numbers.



Please note! Not all products listed on this page may have this approval. Please check our website for latest approvals.

Labels for Thermal Transfer Printers

Terminal Block Labels

Terminal Block labels can be printed to match the terminal spacing of most terminal blocks using TagPrint Pro 4.0 labeling software.

Features and Benefits

- Thermal transfer labels are made with high-performance materials for long-term industrial applications.
- Labels can be printed in any standard thermal transfer printer giving the user options for printing and eliminating the need to be dedicated to one printer model.
- The labels are available in a wide variety of sizes so that finding a label for a particular application is easy.

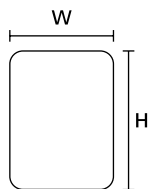
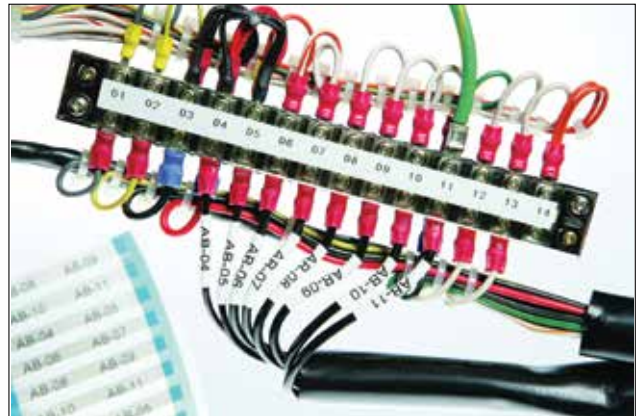

MATERIAL	Polyethylene (PE)
Adhesive	Rubber
Operating Temperature	-40°F to +176°F (-40°C to +80°C)



PART NO.	TYPE	Label Width (W) in. (mm)	Roll Length (L) ft. (m)	Color
596-00380	TBL375	0.38 (9.5)	100.00 (30.5)	White
596-00381	TBL500	0.50 (12.7)	100.00 (30.5)	White

Dimensions are approximate and subject to technical changes. Use Part No. for ordering and Type for specification purposes.

Labels for Thermal Transfer Printers

Phase Labels

Phase labels are microperforated between each label so that it can be applied as one strip to the panel or broken into individual labels.

Features and Benefits

- Thermal transfer labels are made with high-performance materials for long-term industrial applications.
- Labels can be printed in any standard thermal transfer printer giving the user options for printing and eliminating the need to be dedicated to one printer model.
- The labels are available in a wide variety of sizes so that finding a label for a particular application is easy.

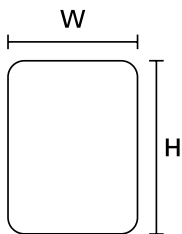

MATERIAL	Polyester (PET)
Adhesive	Acrylic
Operating Temperature	-40°F to +300°F (-40°C to +149°C)

RoHS ✓

PART NO.	TYPE	Label Width (W) in. (mm)	Label Height (H) in. (mm)	Vertical Repeat in. (mm)	Horizontal Repeat in. (mm)	Liner Width in. (mm)	Labels per Row	Color	Qty. per Roll
596-00383*	PLB3P	1.00 (25.4)	0.50 (12.7)	0.63 (15.9)	1.00 (25.4)	3.35 (85.1)	3	Black	2500
596-00382*	PLW3P	1.00 (25.4)	0.50 (12.7)	0.63 (15.9)	1.00 (25.4)	3.35 (85.1)	3	White	2500

Dimensions are approximate and subject to technical changes. Use Part No. for ordering and Type for specification purposes.
*This product meets UL standards. Please see appendix for specific file numbers.



Please note! Not all products listed on this page may have this approval. Please check our website for latest approvals.

Labels for Laser Printers

Laser Tag Labels - 788 Polyester

HellermannTyton white polyester labels are ideal for marking small electrical and electronic components, such as EPROMS', Integrated circuits, as well as the circuit board itself. Printed labels can withstand the soldering process and survive flux removal when the board is washed. HellermannTyton's 788 material is designed for use on flat surfaces and can also be used to identify connectors, buttons and just about anything requiring permanent, general purpose marking.

Features and Benefits

- White polyester has a smooth surface, allowing for the highest resolution and print contrast.
- The acrylic-based adhesive bonds to a wide variety of substrates and resists abrasion.
- LaserTags are sheet fed for easy loading and fast printing.



MATERIAL	Type 788, Polyester (PET)
Operating Temperature	-40°F to +199°F (-40°C to +93°C)
Adhesive	Acrylic

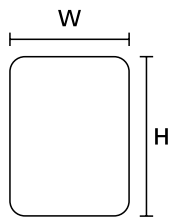

PART NO.	TYPE	Label Width (W) in. (mm)	Label Height (H) in. (mm)	Labels per Row	Labels per Column	Labels per Sheet	Color	Qty. per Pkg.
TAGPP1-788	TAGPP1L	0.63 (15.9)	0.37 (9.4)	12	30	360	White	1000
TAG62L-788	TAG62L	1.50 (38.1)	0.38 (9.5)	5	25	125	White	1000
TAG61L-788	TAG61L	2.62 (66.7)	1.00 (25.4)	3	10	30	White	7500
TAG60L-788	TAG60L	2.83 (71.9)	1.50 (38.1)	3	7	21	White	5250
TAG59L-788	TAG59L	4.00 (101.6)	1.50 (38.1)	2	7	14	White	3500
TAG55L-788	TAG55L	4.25 (107.9)	5.50 (139.7)	2	2	4	White	1000
TAG54L-788	TAG54L	8.50 (215.9)	5.50 (139.7)	1	2	2	White	500
TAG53L-788	TAG53L	8.50 (215.9)	10.81 (274.6)	1	1	1	White	250

Dimensions are approximate and subject to technical changes. Use Part No. for ordering and Type for specification purposes.

Identification

Labels

Labels for Laser Printers

Laser Tag Labels - 788C Polyester

HellermannTyton transparent/clear polyester labels are ideal for marking products where the visibility of the label needs to be minimized, such as consumer products, where the color of the housing needs to remain as clean looking as possible. The clear material allows the surface color to blend in with the printed text. These labels can also be used as an over-laminate to provide further protection for printed text in extreme environments.

Features and Benefits

- Clear polyester has a smooth surface, allowing for the highest resolution and print contrast.
- The acrylic-based adhesive bonds to a wide variety of substrates and resists abrasion.
- LaserTags are sheet fed for easy loading and fast printing.
- LaserTags are made of high-temperature materials to withstand the high heat of laser printing.



MATERIAL	Type 788C, Polyester, clear (CL)
Operating Temperature	-40°F to +199°F (-40°C to +93°C)
Adhesive	Acrylic

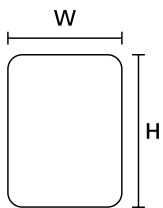

PART NO.	TYPE	Label Width (W) in. (mm)	Label Height (H) in. (mm)	Labels per Row	Labels per Column	Labels per Sheet	Color	Qty. per Pkg.
TAGPP1-788C	TAGPP1	0.63 (15.9)	0.33 (8.5)	12	30	360	Clear	1000
TAGPP2-788C	TAGPP2	0.66 (16.7)	0.33 (8.4)	12	30	360	Clear	1000

Dimensions are approximate and subject to technical changes. Use Part No. for ordering and Type for specification purposes.

Labels for Laser Printers

Laser Tag Labels - 789 Polyester

HellermannTyton white polyester labels are ideal for marking small electrical and electronic components, such as EPROMS', Integrated circuits, as well as the circuit board itself. Printed labels can withstand the soldering process and survive flux removal when the board is washed. HellermannTyton's 789 material is designed for use on flat surfaces and can also be used to identify connectors, buttons and just about anything requiring permanent, durable, high temperature and UV resistant marking.

Features and Benefits

- Laser printable white polyester has a smooth surface, allowing for the highest resolution and print contrast.
- The acrylic-based adhesive bonds to a wide variety of substrates and can withstand high temperatures long term.
- Lasertags are not affected by the high heat required in a laser printer.



MATERIAL	Type 789, Polyester (PET)
Operating Temperature	-40°F to +300°F (-40°C to +149°C)
Adhesive	Acrylic

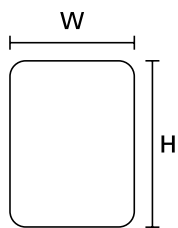

PART NO.	TYPE	Label Width (W) in. (mm)	Label Height (H) in. (mm)	Labels per Row	Labels per Column	Labels per Sheet	Color	Qty. per Pkg.
TAG11L-789	TAG11L	0.65 (16.5)	0.20 (5.1)	10	48	480	White	5000
TAG13L-789	TAG13L	0.75 (19.1)	0.25 (6.4)	8	39	312	White	5000
TAG14L-789	TAG14L	1.00 (25.4)	0.38 (9.5)	7	25	175	White	5000
TAG15L-789	TAG15L	1.00 (25.4)	0.50 (12.7)	7	19	133	White	5000
TAG96L-789	TAG96L	1.88 (47.6)	0.25 (6.4)	4	36	144	White	1000
TAG69L-789	TAG69L	2.00 (50.8)	0.28 (7.0)	4	35	140	White	5000
TAG67L-789	TAG67L	2.87 (73.0)	2.87 (73.0)	2	25	50	White	1000
TAG66L-789	TAG66L	3.59 (91.4)	0.38 (9.5)	2	25	50	White	1000
TAG68L-789	TAG68L	3.80 (96.5)	0.28 (7.0)	2	35	70	White	2500
TAG45L-789	TAG45L	4.00 (101.6)	0.80 (20.3)	2	12	24	White	5000

Dimensions are approximate and subject to technical changes. Use Part No. for ordering and Type for specification purposes.

We just rewrote the book on label creation workflow.

Introducing true print automation. Reduce or eliminate label errors and time-consuming print tasks. Print a group of labels with a single job number or swipe of a barcode reader – to one or multiple printers simultaneously. No costly add-ons or custom programming. Enjoy effortless label design and print simplicity in one, powerful solution: TagPrint® Pro 4.0.

MADE FOR REAL 

Learn how to save time and virtually eliminate costly operator errors: www.hellermann.tyton.com/NextGenIdentification

Labels for Laser Printers

Termination Hardware Labeling

HellermannTyton's line of termination hardware labels features non-adhesive paper labels used to mark 110 wiring blocks. Color coded to meet ANSI/TIA/EIA-606 specifications, they come on pin-fed sheets to be used on dot matrix printers. The pin-fed margins can be removed for use in laser printers.

Features and Benefits

- Cardstock paper can be printed using a wide variety of printing methods, including laser, ink jet and dot matrix printers, which means more options for creating and mounting termination identification on 110 blocks.

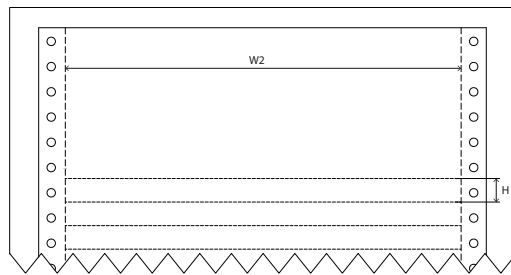
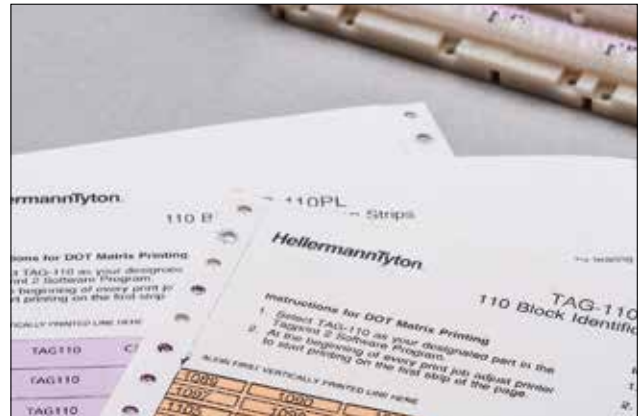

MATERIAL	Paper (PAP)
Operating Temperature	-67°F to +428°F (-55°C to +220°C)
Adhesive	Acrylic



PART NO.	TYPE	Label Width (W) in. (mm)	Label Height (H) in. (mm)	Labels per Row	Labels per Column	Labels per Sheet	Color	Qty. per Pkg.
TAG110BL	TAG110	7.90 (200.7)	0.48 (12.1)	1	15	15	Blue	1000
TAG110BR		7.90 (200.7)	0.48 (12.1)	1	15	15	Brown	1000
TAG110GY		7.90 (200.7)	0.48 (12.1)	1	15	15	Gray	1000
TAG110GR		7.90 (200.7)	0.48 (12.1)	1	15	15	Green	1000
TAG110OR		7.90 (200.7)	0.48 (12.1)	1	15	15	Orange	1000
TAG110RD		7.90 (200.7)	0.48 (12.1)	1	15	15	Red	1000
TAG110PL		7.90 (200.7)	0.48 (12.1)	1	15	15	Violet	1000
TAG110WT		7.90 (200.7)	0.48 (12.1)	1	15	15	White	1000
TAG110YL		7.90 (200.7)	0.48 (12.1)	1	15	15	Yellow	1000

Dimensions are approximate and subject to technical changes. Use Part No. for ordering and Type for specification purposes.

Identification

Labels

Labels for Laser Printers

Self-Laminating Laser Tags

HellermannTyton's self-laminating labels are used for marking wires and cable. The clear tail overlaps and protects the printed information from abrasion, chemicals and solvents and resists UV exposure. When printed using HellermannTyton's thermal transfer printers, clear marking and high high-contrast imaging against the wire make this the perfect choice for durable identification.

Features and Benefits

- Laser printable self-laminating polyester has a smooth surface, allowing for the highest resolution and print contrast.
- The material is 1.0 mil thick, allowing it to conform around wires and cable.
- The acrylic-based adhesive bonds to a wide variety of substrates and can withstand high temperatures long term.
- Lasertags are not affected by the high heat required in a laser printer.



MATERIAL	Type 105, Polyester (PET), white (WH)
Operating Temperature	-40°F to +300°F (-40°C to +149°C)
Adhesive	Acrylic

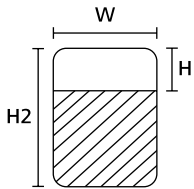

PART NO.	TYPE	Label Width (W) in. (mm)	Printable Area Height (H) in. (mm)	Label Height (H2) in. (mm)	Vertical Repeat in. (mm)	Horizontal Repeat in. (mm)	Liner Width in. (mm)	Labels per Row	Color	Qty. per Roll
TAG26L-105	TAG26L	0.50 (12.7)	0.38 (9.5)	.75 (19.1)	0.75 (19.0)	1.90 (48.2)	8.50 (215.0)	16	White	5000
TAG2L-105	TAG2L	0.50 (12.7)	0.50 (12.7)	1.43 (36.5)	1.43 (36.4)	0.50 (12.7)	8.50 (215.0)	16	White	5000
TAG5L-105	TAG5L	0.80 (20.3)	0.50 (12.7)	1.43 (36.5)	1.43 (36.4)	0.90 (22.9)	8.50 (215.0)	8	White	5000
TAG65L-105	TAG65L	0.81 (20.7)	0.81 (20.7)	2.13 (54.1)	2.13 (53.9)	0.81 (20.6)	8.50 (215.0)	9	White	1000
TAG51L-105	TAG51L	1.00 (25.4)	0.35 (8.9)	.75 (19.1)	0.75 (19.0)	1.00 (20.3)	8.50 (215.0)	8	White	5000
TAG49L-105	TAG49L	1.00 (25.4)	0.35 (8.9)	1.0 (25.4)	1.00 (25.4)	1.00 (25.4)	8.50 (215.0)	8	White	2500
TAG63L-105	TAG63L	1.00 (25.4)	0.50 (12.7)	1.33 (33.7)	1.33 (33.7)	1.00 (25.4)	8.50 (215.0)	8	White	2500

Dimensions are approximate and subject to technical changes. Use Part No. for ordering and Type for specification purposes.

Labels for Laser Printers

Self-Laminating Laser Tags

PART NO.	TYPE	Label Width (W) in. (mm)	Printable Area Height (H) in. (mm)	Label Height (H2) in. (mm)	Vertical Repeat in. (mm)	Horizontal Repeat in. (mm)	Liner Width in. (mm)	Labels per Row	Color	Qty. per Roll
TAG9L-105	TAG9L	1.00 (25.4)	1.00 (25.4)	2.25 (57.2)	2.25 (57.1)	1.10 (27.9)	8.50 (215.0)	7	White	1000
TAG50L-105	TAG50L	1.00 (25.4)	1.00 (25.4)	3.16 (80.3)	3.16 (80.4)	1.00 (25.4)	8.50 (215.0)	8	White	1000
TAG64L-105	TAG64L	1.17 (29.7)	0.83 (21.1)	3.33 (84.6)	3.33 (84.6)	1.17 (29.7)	8.50 (215.0)	6	White	1000
TAG1L-105	TAG1L	1.90 (48.2)	0.75 (19.1)	3.25 (82.6)	3.35 (85.1)	2.00 (50.8)	8.50 (215.0)	4	White	1000
TAG52L-105	TAG52L	2.00 (50.8)	0.47 (11.9)	1.33 (33.8)	1.33 (33.7)	2.00 (50.8)	8.50 (215.0)	3	White	1000
TAG10L-105	TAG10L	2.00 (50.8)	0.75 (19.1)	2.25 (57.2)	2.25 (57.2)	2.00 (50.8)	8.50 (215.0)	4	White	1000

Dimensions are approximate and subject to technical changes. Use Part No. for ordering and Type for specification purposes.

Labels for Ink Jet Printers

Ink Jet Labels - Cardstock Material

HellermannTyton offers a series of technologically advanced labels for use on standard ink jet printers. The labels come on 8.5 x 11" sheets and are printable using HellermannTyton's TagPrint Pro software. A wide range of materials and sizes is available for wire and component marking. Even colors can be printed when used on a color ink jet printer. Ink jet labels are available in polyester or paper.

Features and Benefits

- Cardstock paper can be printed using a wide variety of printing methods, including laser, ink jet and dot matrix printers, which means more options for creating and mounting wall outlets and phones.

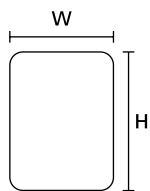

MATERIAL	Paper (PAP)
Operating Temperature	-40°F to +302°F (-40°C to +150°C)
Adhesive	Acrylic



PART NO.	TYPE	Label Width (W) in. (mm)	Label Height (H) in. (mm)	Labels per Row	Labels per Column	Labels per Sheet	Color	Qty. per Pkg.
TAGPHONE	TAGPHONE	1.75 (44.5)	0.38 (9.5)	4	21	84	White	1000

Dimensions are approximate and subject to technical changes. Use Part No. for ordering and Type for specification purposes.

Labels for Ink Jet Printers

Ink Jet Labels - 108 Material

These labels are made of general purpose paper for short term identification.

Features and Benefits

- Paper is a low-cost choice for indoor applications where exposure to chemicals, solvents and UV light are not an issue.
- When used with pigment-based inks, HellermannTyton ink jet labels offer superior non-smear marks.



MATERIAL	Type 108, Ink Jet White paper (WH)
Operating Temperature	-40°F to +199°F (-40°C to +93°C)
Adhesive	Acrylic



PART NO.	TYPE	Label Width (W) in. (mm)	Label Height (H) in. (mm)	Labels per Row	Labels per Column	Labels per Sheet	Color	Qty. per Pkg.
TAGPP1J-108	TAGPP1J	0.63 (15.9)	0.31 (7.9)	12	30	360	White	1000
TAG59J-108	TAG59J	4.00 (101.6)	1.50 (31.6)	2	7	14	White	3500

Dimensions are approximate and subject to technical changes. Use Part No. for ordering and Type for specification purposes.

Labels for Ink Jet Printers

Ink Jet Labels - 450 Material

HellermannTyton white polyester labels are ideal for marking small electrical and electronic components, such as EPROMS', Integrated circuits, as well as the circuit board itself. Printed labels can withstand the soldering process and survive flux removal when the board is washed. HellermannTyton's 450 material is designed for use on flat surfaces and can also be used to identify connectors, buttons and just about anything requiring permanent, durable, high temperature marking.

Features and Benefits

- Ink jet printable polyester has a smooth surface, allowing for the highest resolution and print contrast.
- The acrylic-based adhesive bonds to a wide variety of substrates and resists abrasion.
- When used with black pigment-based inks, the material can withstand chemicals and solvents.



MATERIAL	Type 450, Polyethylene Terephthalate (PET)
Operating Temperature	-40°F to +302°F (-40°C to +150°C)
Adhesive	Acrylic

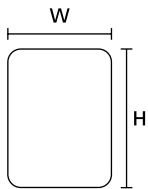

PART NO.	TYPE	Label Width (W) in. (mm)	Label Height (H) in. (mm)	Labels per Row	Labels per Column	Labels per Sheet	Color	Qty. per Pkg.
TAG11J-450	TAG11J	0.20 (5.1)	0.65 (16.1)	21	12	252	White	5000
TAG13J-450	TAG13J	0.25 (6.4)	0.75 (19.1)	26	12	312	White	5000
TAG14J-450	TAG14J	0.38 (9.5)	1.00 (25.4)	16	9	144	White	2500
TAG19J-450	TAG19J	0.38 (9.5)	2.00 (50.8)	15	4	60	Black	1200
TAG21J-450	TAG21J	0.50 (12.7)	0.75 (19.1)	13	12	156	White	5000
TAG15J-450	TAG15J	0.50 (12.7)	1.00 (25.4)	13	9	117	Black	5000
TAG28J-450	TAG28J	0.80 (20.3)	1.43 (36.5)	8	6	48	White	1000

Dimensions are approximate and subject to technical changes. Use Part No. for ordering and Type for specification purposes.

Ink Jet Printer Labels

Ink Jet Self-Laminating Labels

HellermannTyton's ink jet self-laminating labels are smear resistant, allowing them to be handled immediately. The labels are made of a heat resistant 1mm polyester film with a strong acrylic based adhesive. The printable area is a special ink-receptive film that absorbs the ink as it is printed on an ink jet printer.

Features and Benefits

- HellermannTyton Ink Jet labels are sheet fed for easy loading and fast printing.
- Ink Jet labels are made with high temperature materials and adhesives so that they will not be affected by the high heat of laser printing.
- Ink Jet labels are printable using toner for long term UV exposure.
- Ink Jet labels come in a variety of label sizes and types to fit most applications.

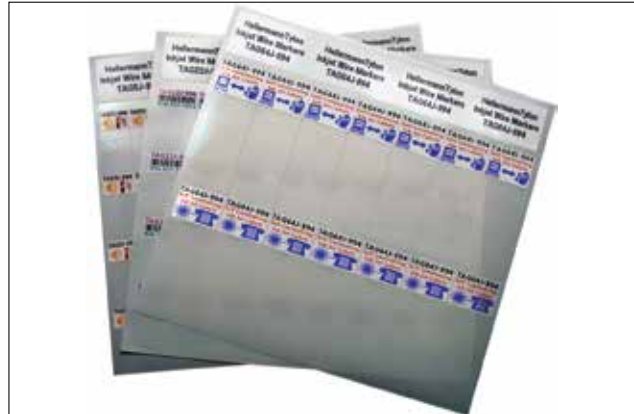

MATERIAL	Type 994, Polyethylene Terephthalate (PET)
Operating Temperature	-40°F to +302°F (-40°C to +150°C)
Adhesive	Acrylic

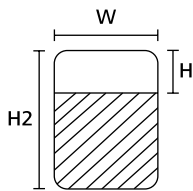

PART NO.	TYPE	Label Width (W) in. (mm)	Printable Area Height (H) in. (mm)	Label Height (H2) in. (mm)	Vertical Repeat in. (mm)	Horizontal Repeat in. (mm)	Liner Width in. (mm)	Labels per Row	Color	Qty. per Roll
TAG26J-994	TAG26J	0.50 (12.7)	0.35 (8.9)	0.75 (19.1)	0.75 (19.0)	0.50 (12.7)	8.50 (215.9)	16	White	2500
TAG5J-994	TAG5J	0.80 (20.3)	0.50 (12.7)	1.43 (36.3)	1.43 (36.3)	0.80 (20.3)	8.50 (215.0)	10	White	1000
TAG51J-994	TAG51J	1.00 (25.4)	0.35 (8.9)	0.75 (19.1)	0.75 (19.0)	1.00 (25.4)	8.50 (215.0)	8	White	1000
TAG22J-994	TAG22J	1.00 (25.4)	0.50 (12.7)	1.43 (36.3)	1.43 (36.3)	1.00 (25.4)	8.50 (215.0)	8	White	1000
TAG9J-994	TAG9J	1.00 (25.4)	0.75 (19.1)	2.25 (57.2)	2.25 (57.2)	1.00 (25.4)	8.50 (215.0)	8	White	1000
TAG64J-994	TAG64J	1.16 (29.6)	0.86 (21.8)	3.25 (82.6)	3.25 (82.6)	1.16 (29.6)	8.50 (215.0)	7	White	1000

Dimensions are approximate and subject to technical changes. Use Part No. for ordering and Type for specification purposes.

Labels for Dot Matrix Printers

Dot Matrix Labels - Polyester

HellermannTyton white polyester labels are ideal for marking small electrical and electronic components, such as EPROMS', Integrated circuits, as well as the circuit board itself. Printed labels can withstand the soldering process and survive flux removal when the board is washed. HellermannTyton's 400 material is designed for use on flat surfaces and can also be used to identify connectors, buttons and just about anything requiring permanent, durable, high temperature and UV resistant marking.

Features and Benefits

- Tabtag dot matrix labels are specifically made for use in dot matrix printers for fast and easy printing.
- Labels come with a pin-feed margin to ensure they can easily be loaded into any dot matrix printing system.
- White dot matrix polyester has a matte finish, allowing for the highest resolution and print contrast using impact printers.
- The acrylic-based adhesive bonds to a wide variety of substrates and can withstand high temperatures long term.



MATERIAL	Type 400, Polyester, white (WH)
Adhesive	Acrylic
Operating Temperature	-40°F to +302°F (-40°C to +150°C)

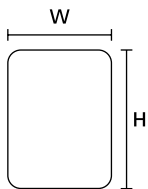

PART NO.	TYPE	Label Width (W) in. (mm)	Label Height (H) in. (mm)	Labels per Row	Labels per Column	Color	Qty. per Pkg.
TAG27-400*	TAG27	0.75 (19.1)	1.50 (38.1)	4	4	White	5000
TAG16-400*	TAG16	0.90 (22.8)	0.25 (6.4)	8	8	White	5000
TAG14-400	TAG14	1.00 (25.4)	0.38 (9.5)	7	7	White	5000
TAG15-400*	TAG15	1.00 (25.4)	0.50 (12.7)	7	7	White	5000
TAG44-400*	TAG44	1.88 (47.5)	1.88 (47.5)	1	1	White	5000

Dimensions are approximate and subject to technical changes. Use Part No. for ordering and Type for specification purposes.

*This product meets UL standards. Please see appendix for specific file numbers.



Please note! Not all products listed on this page may have this approval. Please check our website for latest approvals.

Labels for Dot Matrix Printers

Dot Matrix Labels - Metallized Polyester

HellermannTyton's metallized polyester labels include a layer of metallic particles that give the appearance of being made of metal. Applications include asset tracking and product rating plates. The high operating temperature makes them suitable for use on electronic equipment. Great for replacing expensive metal stampings, engravings and even silk screened rating plates and can be placed on a wide variety of surfaces.

Features and Benefits

- Metallized dot matrix polyester has a matte finish, allowing for the highest resolution and print contrast using impact printers.
- The acrylic-based adhesive bonds to a wide variety of substrates and can withstand high temperatures long term.
- Tabtag dot matrix labels are specifically made for use in dot matrix printers for fast and easy printing.
- Labels come with a pin-feed margin to ensure they can easily be loaded into any dot matrix printing system.



MATERIAL	Type 600, Polyester, silver-matt (SR)
Adhesive	Acrylic
Operating Temperature	-40°F to +302°F (-40°C to +150°C)

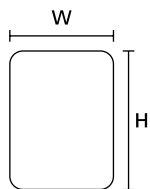

PART NO.	TYPE	Label Width (W) in. (mm)	Label Height (H) in. (mm)	Labels per Row	Labels per Column	Color	Qty. per Pkg.
TAG27-600*	TAG27	0.75 (19.1)	1.50 (38.1)	4	4	White	5000
TAG15-600*	TAG15	1.00 (25.4)	0.50 (12.7)	7	7	White	5000

Dimensions are approximate and subject to technical changes. Use Part No. for ordering and Type for specification purposes.
 *This product meets UL standards. Please see appendix for specific file numbers.



Please note! Not all products listed on this page may have this approval. Please check our website for latest approvals.

Labels for Dot Matrix Printers

Self Laminating Dot Matrix Labels

HellermannTyton's self-laminating labels are used for marking wires and cable. The clear tail overlaps and protects the printed information from abrasion, chemicals and solvents and resists UV exposure. When printed using any standard dot matrix printer, clear marking and high high-contrast imaging against the wire make this the perfect choice for durable identification.

Features and Benefits

- Dot matrix printable self-laminating vinyl has a smooth surface, allowing for the highest resolution and print contrast using an impact printer.
- The material is a conformable vinyl, allowing it to wrap and stay around wires and cable.
- The acrylic-based adhesive bonds to a wide variety of substrates and will remain in place long term.
- Tabtag dot matrix labels are specifically made for use in dot matrix printers for fast and easy printing.
- Labels come with a pin-feed margin to ensure that they can easily be loaded into any dot matrix printing system.



MATERIAL	Type 100, Vinyl (PVC), white (WH), self laminating
Adhesive	Acrylic
Operating Temperature	-51°F to +200°F (-46°C to +93°C)

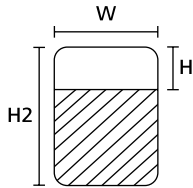

PART NO.	TYPE	Label Width (W) in. (mm)	Printable Area Height (H) in. (mm)	Label Height (H2) in. (mm)	Vertical Repeat in. (mm)	Horizontal Repeat in. (mm)	Liner Width in. (mm)	Labels per Row	Color	Qty. per Roll
TAG26-100*	TAG26	0.50 (12.7)	0.38 (9.5)	0.75 (19.0)	1.00 (25.4)	0.50 (15.2)	9.30 (238.8)	14	White	5000
TAG2-100*	TAG2	0.50 (12.7)	0.50 (12.7)	1.44 (36.6)	1.50 (38.1)	0.50 (12.7)	8.90 (228.6)	16	White	5000
TAG25-100*	TAG25	0.75 (19.1)	0.50 (12.7)	1.75 (42.7)	2.00 (50.8)	0.85 (21.6)	8.90 (228.6)	9	White	5000
TAG5-100*	TAG5	0.80 (20.3)	0.50 (12.7)	1.44 (36.6)	1.50 (38.1)	0.90 (22.8)	6.30 (160.0)	6	White	5000
TAG22-100*	TAG22	1.00 (25.4)	0.50 (12.7)	1.44 (36.6)	1.50 (38.1)	1.00 (25.4)	8.90 (228.6)	8	White	5000
TAG9-100*	TAG9	1.00 (25.4)	0.75 (19.0)	2.25 (57.2)	2.50 (63.5)	1.00 (25.4)	8.90 (228.6)	8	White	5000
TAG3-100*	TAG3	1.00 (25.4)	1.00 (25.4)	3.75 (95.3)	4.00 (101.6)	1.00 (25.4)	8.90 (228.6)	8	White	2500

Dimensions are approximate and subject to technical changes. Use Part No. for ordering and Type for specification purposes.

*This product meets UL standards. Please see appendix for specific file numbers.



Please note! Not all products listed on this page may have this approval. Please check our website for latest approvals.

Labels for Dot Matrix Printers

Self Laminating Dot Matrix Labels

PART NO.	TYPE	Label Width (W) in. (mm)	Printable Area Height (H) in. (mm)	Label Height (H2) in. (mm)	Vertical Repeat in. (mm)	Horizontal Repeat in. (mm)	Liner Width in. (mm)	Labels per Row	Color	Qty. per Roll
TAG23-100*	TAG23	1.00 (25.4)	1.00 (38.1)	7.43 (188.7)	7.50 (190.5)	1.00 (25.4)	9.50 (241.3)	8	White	2500
TAG1-100*	TAG1	1.90 (48.0)	0.75 (19.1)	3.19 (81.0)	3.50 (88.9)	2.00 (50.8)	9.50 (241.3)	4	White	2500
TAG24-100*	TAG24	2.00 (50.8)	0.50 (12.7)	1.44 (36.6)	1.50 (38.1)	0.90 (22.9)	8.90 (228.6)	4	White	5000
TAG10-100*	TAG10	2.00 (50.8)	0.75 (19.0)	2.25 (57.2)	2.50 (63.5)	2.00 (50.8)	8.90 (228.6)	4	White	2500
TAG6-100*	TAG6	2.00 (50.8)	1.50 (38.1)	3.75 (95.3)	4.00 (101.6)	2.00 (50.8)	8.90 (228.6)	4	White	2500

Dimensions are approximate and subject to technical changes. Use Part No. for ordering and Type for specification purposes.

*This product meets UL standards. Please see appendix for specific file numbers.



Please note! Not all products listed on this page may have this approval. Please check our website for latest approvals.

Heat Shrinkable Labels

ShrinkTrak Heat Shrinkable Markers

HellermannTyton's ShrinkTrak™ heat shrinkable markers make it easy to mark wire, cable and other components. The military approved heat shrink tubing is flattened and assembled in a ladder style carrier system for easy printing using a thermal transfer printer. The ladder system creates a kit of markers that can be sorted, removed and applied in any order thus saving time, labor and speeding production.

Features and Benefits

Versatile

- Flexible, flame retardant, heat shrinkable polyolefin tubing meets all military specification.
- 3:1 shrink ratio enables a wide range of wire sizes to be covered.
- Standard colors - yellow, white and black.
- Larger pack options result in less box changes.

High Performance Design

- Center slit and multiple slit versions reduce or eliminate hand cutting.
- Non-slip printable liner allows additional marker data to be printed on the reverse side for records and placement instructions.
- Use HellermannTyton's Durattach ribbon system for the highest print performance on the market.

Reduce Printer Jams

- Custom box opening allows markers to dispense directly into HellermannTyton thermal transfer printers.
- Dispense markers faster and easier with waxed core dispenser.

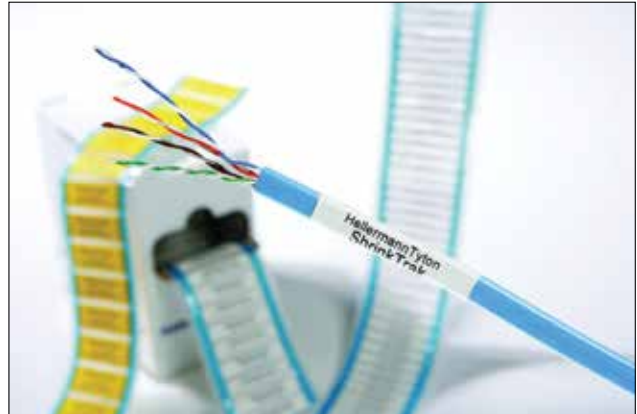

MATERIAL	Polyolefin, cross-linked (PO-X)
Thickness (T)	.003 "
Min. Shrink Temperature	+194 °F (+90 °C)
Operating Temperature	-67°F to +275°F (-55°C to +135°C)
Flammability	UL 224 VW-1
Flexibility	Flexible
Abrasion Resistance	Medium
Solvent Resistance	Good



PART NO.	TYPE	Outside Diameter Max. in. (mm)	Label Width (W) in. (mm)	Label Height (H) in. (mm)	Center Slit	Color	Quantity per Box
553-50063	HST3-1WH-3S	0.13 (3.2)	0.48 (12.1)	0.24 (5.7)	Triple	White	1000
553-50088		0.13 (3.2)	0.48 (12.1)	0.24 (5.7)	Triple	White	4000
553-50211		0.13 (3.2)	0.48 (12.1)	0.60 (15.2)	-	White	4000
553-50181	HST3-1BK-3S	0.13 (3.2)	0.48 (12.1)	1.90 (48.3)	-	Black	1000
553-50075	HST3-1WH-2S	0.13 (3.2)	0.63 (16.0)	0.24 (5.7)	Double	White	3000
553-50070		0.13 (3.2)	0.63 (16.0)	0.24 (5.7)	Double	White	750
553-50077	HST3-1YE-2S	0.13 (3.2)	0.63 (16.0)	0.24 (5.7)	Double	Yellow	3000
553-50071		0.13 (3.2)	0.63 (16.0)	0.24 (5.7)	Double	Yellow	750
553-50180	HST3-1BK-2S	0.13 (3.2)	0.63 (16.1)	0.60 (15.2)	-	Black	750

Dimensions are approximate and subject to technical changes. Use Part No. for ordering and Type for specification purposes.

Meets printer performance requirements of SAE-AS81531 using the ribbons listed above in any thermal transfer printer. Contact HellermannTyton for custom color options.



Please note! Not all products listed on this page may have this approval. Please check our website for latest approvals.

Heat Shrinkable Labels

ShrinkTrak Heat Shrinkable Markers

PART NO.	TYPE	Outside Diameter Max. in. (mm)	Label Width (W) in. (mm)	Label Height (H) in. (mm)	Center Slit	Color	Quantity per Box
553-50074	HST3-1WH-S	0.13 (3.2)	0.95 (24.1)	0.24 (5.7)	Single	White	2000
553-50004		0.13 (3.2)	0.95 (24.1)	0.24 (5.7)	Single	White	500
553-50067		0.13 (3.2)	0.95 (24.1)	0.24 (5.7)	Single	White	5000
553-50076	HST3-1YE-S	0.13 (3.2)	0.95 (24.1)	0.24 (5.7)	Single	Yellow	2000
553-50007		0.13 (3.2)	0.95 (24.1)	0.24 (5.7)	Single	Yellow	500
553-50179	HST3-1BK-S	0.13 (3.2)	0.95 (24.1)	0.42 (10.7)	-	Black	500
553-50001	HST3-1BK	0.13 (3.2)	1.90 (48.3)	0.24 (5.7)	-	Black	250
553-50003	HST3-1WH	0.13 (3.2)	1.90 (48.3)	0.24 (5.7)	-	White	1000
553-50002		0.13 (3.2)	1.90 (48.3)	0.24 (5.7)	-	White	250
553-50078		0.13 (3.2)	1.90 (48.3)	0.24 (5.7)	-	White	2500
553-50006	HST3-1YE	0.13 (3.2)	1.90 (48.3)	0.24 (5.7)	-	Yellow	1000
553-50005		0.13 (3.2)	1.90 (48.3)	0.24 (5.7)	-	Yellow	250
553-50239	HST4.8-1YE-3S	0.19 (4.7)	0.48 (12.1)	0.31 (7.9)	-	Yellow	1000
553-50064	HST4.8-1.6WH-3S	0.19 (4.7)	0.48 (12.1)	0.31 (7.9)	Triple	White	1000
553-50081		0.19 (4.7)	0.48 (12.1)	0.31 (7.9)	Triple	White	4000
553-50184	HST4.8-1.6BK-3S	0.19 (4.7)	0.48 (12.1)	0.60 (15.2)	-	Black	1000
553-50068	HST4.8-1.6WH-2S	0.19 (4.7)	0.63 (16.0)	0.31 (7.9)	Double	White	750
553-50072		0.19 (4.7)	0.63 (16.1)	0.31 (7.9)	Double	White	3000
553-50073	HST4.8-1.6YE-2S	0.19 (4.7)	0.63 (16.1)	0.31 (7.9)	Double	Yellow	3000
553-50069		0.19 (4.7)	0.63 (16.1)	0.31 (7.9)	Double	Yellow	750
553-50176	HST4.8-1.6WH-S	0.19 (4.7)	0.95 (24.1)	0.31 (7.9)	Single	White	10000
553-50080		0.19 (4.7)	0.95 (24.1)	0.31 (7.9)	Single	White	2000
553-50011		0.19 (4.7)	0.95 (24.1)	0.31 (7.9)	Single	White	500
553-50014	HST4.8-1.6YE-S	0.19 (4.7)	0.95 (24.1)	0.31 (7.9)	Single	Yellow	500
553-50203	HST4.8-1.6WHAP	0.19 (4.7)	1.90 (48.3)	0.31 (7.9)	-	White	1000
553-50008	HST4.8-1.6BK	0.19 (4.7)	1.90 (48.3)	0.31 (7.9)	-	Black	250
553-50010	HST4.8-1.6WH	0.19 (4.7)	1.90 (48.3)	0.31 (7.9)	-	White	1000
553-50009		0.19 (4.7)	1.90 (48.3)	0.31 (7.9)	-	White	250
553-50177		0.19 (4.7)	1.90 (48.3)	0.31 (7.9)	-	White	3000
553-50079		0.19 (4.7)	1.90 (48.3)	0.31 (7.9)	-	White	5000
553-50012	HST4.8-1.6YE	0.19 (4.7)	1.90 (48.3)	0.31 (7.9)	-	Yellow	250
553-50090	HST4.8-1.6WH	0.19 (4.7)	1.90 (48.3)	0.42 (10.7)	-	White	2500
553-50195		0.19 (4.7)	1.90 (48.3)	0.60 (15.2)	-	White	6400
553-50213	HST4.8-1.6WH-S	0.19 (4.7)	1.90 (48.3)	1.20 (30.5)	-	White	10000
553-50178	HST6-2BK-3S	0.25 (6.4)	0.48 (12.1)	0.42 (10.7)	-	Black	1000

Dimensions are approximate and subject to technical changes. Use Part No. for ordering and Type for specification purposes.

Meets printer performance requirements of SAE-AS81531 using the ribbons listed above in any thermal transfer printer. Contact HellermannTyton for custom color options.



Please note! Not all products listed on this page may have this approval. Please check our website for latest approvals.

Heat Shrinkable Labels

ShrinkTrak Heat Shrinkable Markers

PART NO.	TYPE	Outside Diameter Max. in. (mm)	Label Width (W) in. (mm)	Label Height (H) in. (mm)	Center Slit	Color	Quantity per Box
553-50210	HST6-2YE-3S	0.25 (6.4)	0.48 (12.1)	0.42 (10.7)	-	Yellow	4000
553-50089	HST6-2WH-3S	0.25 (6.4)	0.48 (12.1)	0.42 (10.7)	Triple	White	4000
553-50212		0.25 (6.4)	0.48 (12.1)	0.77 (19.6)	-	White	4000
553-50242	HST6-2WH-S	0.25 (6.4)	0.63 (16.0)	0.42 (10.7)	Single	White	10000
553-50065	HST6-2WH-3S	0.25 (6.4)	0.63 (16.0)	0.77 (19.6)	Triple	White	1000
553-50186	HST6-2BK-2S	0.25 (6.4)	0.63 (16.1)	0.31 (7.9)	-	Black	750
553-50082	HST6-2WH-2S	0.25 (6.4)	0.63 (16.1)	0.42 (10.7)	Double	White	750
553-50083	HST6-2YE-2S	0.25 (6.4)	0.63 (16.1)	0.42 (10.7)	Double	Yellow	750
553-50084	HST6-2WH-S	0.25 (6.4)	0.95 (24.1)	0.42 (10.7)	Single	White	2000
553-50019		0.25 (6.4)	0.95 (24.1)	0.42 (10.7)	Single	White	500
553-50085	HST6-2YE-S	0.25 (6.4)	0.95 (24.1)	0.42 (10.7)	Single	Yellow	2000
553-50022		0.25 (6.4)	0.95 (24.1)	0.42 (10.7)	Single	Yellow	500
553-50015	HST6-2BK	0.25 (6.4)	1.90 (48.3)	0.42 (10.7)	-	Black	250
553-50017	HST6-2WH	0.25 (6.4)	1.90 (48.3)	0.42 (10.7)	-	White	1000
553-50204	HST6-2WHAP	0.25 (6.4)	1.90 (48.3)	0.42 (10.7)	-	White	1000
553-50016	HST6-2WH	0.25 (6.4)	1.90 (48.3)	0.42 (10.7)	-	White	250
553-50018		0.25 (6.4)	1.90 (48.3)	0.42 (10.7)	-	White	5000
553-50021	HTS6-2YE	0.25 (6.4)	1.90 (48.3)	0.42 (10.7)	-	Yellow	1000
553-50020	HST6-2YE	0.25 (6.4)	1.90 (48.3)	0.42 (10.7)	-	Yellow	250
553-50196	HST6-2WH	0.25 (6.4)	1.90 (48.3)	0.60 (15.2)	-	White	5300
553-50189	HST9-3BK-3S	0.38 (9.5)	0.48 (12.1)	0.24 (6.0)	-	Black	1000
553-50066	HST9-3WH-3S	0.38 (9.5)	0.48 (12.1)	0.60 (15.2)	Triple	White	1000
553-50251	HST9-3WH-2S	0.38 (9.5)	0.63 (16.1)	0.60 (15.2)	-	White	750
553-50025	HST9-3WH-S	0.38 (9.5)	0.95 (24.1)	0.60 (15.2)	Single	White	500
553-50027	HST9-3YE-S	0.38 (9.5)	0.95 (24.1)	0.60 (15.2)	Single	Yellow	500
553-50023	HST9-3BK	0.38 (9.5)	1.90 (48.3)	0.60 (15.2)	-	Black	250
553-50192	HST9-3WH	0.38 (9.5)	1.90 (48.3)	0.60 (15.2)	-	White	1000
553-50024		0.38 (9.5)	1.90 (48.3)	0.60 (15.2)	-	White	250
553-50026	HST9-3YE	0.38 (9.5)	1.90 (48.3)	0.60 (15.2)	-	Yellow	250
553-50236	HST9-3WH	0.38 (9.5)	1.90 (48.3)	0.60 (15.2)	-	White	2500
553-50205	HST9-3WHAP	0.38 (9.5)	1.90 (48.3)	0.60 (15.2)	-	White	250
553-50086	HST12-4WH-3S	0.50 (12.7)	0.48 (12.1)	0.77 (19.6)	Triple	White	1000
553-50087	HST12-4YE-3S	0.50 (12.7)	0.48 (12.1)	0.77 (19.6)	Triple	Yellow	1000

Dimensions are approximate and subject to technical changes. Use Part No. for ordering and Type for specification purposes.

Meets printer performance requirements of SAE-AS81531 using the ribbons listed above in any thermal transfer printer. Contact HellermannTyton for custom color options.



Please note! Not all products listed on this page may have this approval. Please check our website for latest approvals.

Heat Shrinkable Labels

ShrinkTrak Heat Shrinkable Markers

PART NO.	TYPE	Outside Diameter Max. in. (mm)	Label Width (W) in. (mm)	Label Height (H) in. (mm)	Center Slit	Color	Quantity per Box
553-50250	HST12-4WH-S	0.50 (12.7)	0.63 (16.1)	0.77 (19.6)	-	White	750
553-50232		0.50 (12.7)	0.95 (24.1)	0.77 (19.6)	Single	White	2000
553-50030		0.50 (12.7)	0.95 (24.1)	0.77 (19.6)	Single	White	500
553-50032	HST12-4YE-S	0.50 (12.7)	0.95 (24.1)	0.77 (19.6)	Single	Yellow	500
553-50193	HST12-4WH	0.50 (12.7)	1.90 (48.3)	0.42 (10.7)	-	White	1000
553-50028	HST12-4BK	0.50 (12.7)	1.90 (48.3)	0.77 (19.6)	-	Black	250
553-50231	HST12-4WH	0.50 (12.7)	1.90 (48.3)	0.77 (19.6)	-	White	1000
553-50029		0.50 (12.7)	1.90 (48.3)	0.77 (19.6)	-	White	250
553-50206	HST12-4WHAP	0.50 (12.7)	1.90 (48.3)	0.77 (19.6)	-	White	250
553-50031	HST12-4YE	0.50 (12.7)	1.90 (48.3)	0.77 (19.6)	-	Yellow	250
553-50222	HST18-6BK-S	0.75 (19.1)	0.95 (24.1)	0.24 (6.0)	-	Black	500
553-50241	HST18-6YE-S	0.75 (19.1)	0.95 (24.1)	1.20 (30.5)	-	Yellow	2000
553-50234	HST18-6WH-S	0.75 (19.1)	0.95 (24.1)	1.20 (30.5)	Single	White	2000
553-50035		0.75 (19.1)	0.95 (24.1)	1.20 (30.5)	Single	White	500
553-50037	HST18-6YE-S	0.75 (19.1)	0.95 (24.1)	1.20 (30.5)	Single	Yellow	500
553-50199	HST18-6WH	0.75 (19.1)	1.90 (48.3)	0.60 (15.2)	-	White	2200
553-50033	HST18-6BK	0.75 (19.1)	1.90 (48.3)	1.20 (30.5)	-	Black	250
553-50233	HST18-6WH	0.75 (19.1)	1.90 (48.3)	1.20 (30.5)	-	White	1000
553-50034		0.75 (19.1)	1.90 (48.3)	1.20 (30.5)	-	White	250
553-50036	HST18-6YE	0.75 (19.1)	1.90 (48.3)	1.20 (30.5)	-	Yellow	250
553-50240		0.75 (19.1)	1.90 (48.3)	1.20 (30.5)	-	Yellow	1000
553-50223	HST24-8BK-S	1.00 (25.4)	0.95 (24.1)	0.31 (7.9)	-	Black	500
553-50040	HST24-8WH-S	1.00 (25.4)	0.95 (24.1)	1.69 (42.9)	Single	White	500
553-50042	HST24-8YE-S	1.00 (25.4)	0.95 (24.1)	1.69 (42.9)	Single	Yellow	500
553-50038	HST24-8BK	1.00 (25.4)	1.90 (48.3)	1.69 (42.9)	-	Black	250
553-50039	HST24-8WH	1.00 (25.4)	1.90 (48.3)	1.69 (42.9)	-	White	250
553-50041	HST24-8YE	1.00 (25.4)	1.90 (48.3)	1.69 (42.9)	-	Yellow	250
553-50237	HST24-8WH	1.00 (25.4)	1.90 (48.3)	1.69 (42.9)	-	White	1000
553-50226	HFST39-13WH-S	1.50 (38.1)	0.95 (24.1)	2.26 (57.4)	Single	White	300
553-50227	HFST39-13YE-S	1.50 (38.1)	0.95 (24.1)	2.26 (57.4)	Single	Yellow	300
553-50209	HST39-13WH	1.50 (38.1)	1.90 (48.3)	2.26 (57.4)	-	White	150
553-50225	HFST39-13YE	1.50 (38.1)	1.90 (48.3)	2.26 (57.4)	-	Yellow	150

Dimensions are approximate and subject to technical changes. Use Part No. for ordering and Type for specification purposes.

Meets printer performance requirements of SAE-AS81531 using the ribbons listed above in any thermal transfer printer. Contact HellermannTyton for custom color options.



Please note! Not all products listed on this page may have this approval. Please check our website for latest approvals.

Identification

Labels

Foam Nameplate Labels

Rectangular Foam Nameplates

Foam Nameplate labels are designed to replace plastic and metal engraved phenolic plates commonly found on electrical control panels. The labels provide the look and feel of a plastic engraved or metal plate, but at a fraction of the cost. Labels can be printed using HellermannTyton TagPrint Pro labeling software and can include printed logos, bar codes and text of almost any size and type.

Features and Benefits

- Foam Nameplate labels are less costly than plastic or metal engraved plates, saving material costs.
- Foam Nameplate labels conform to textured and other low energy surfaces ensuring the labels stay in place for the life of the product.
- Labels are UV and chemical resistant for long life in an industrial environment.
- Foam nameplate labels are printable using a thermal transfer printer for complete control and on-demand creation of labels.



MATERIAL	Polyester (PET)
Adhesive	Acrylate with base of acrylic foam
Operating Temperature	-40°F to +176°F (-40°C to +80°C)

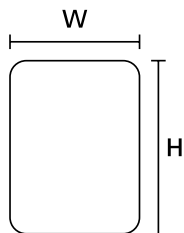

PART NO.	TYPE	Label Width (W) in. (mm)	Label Height (H) in. (mm)	Color	Qty. per Roll
596-00503	NPL27X13BK	1.06 (27.0)	0.49 (11.4)	Black	500
596-00500	NPL27X13WH	1.06 (27.0)	0.49 (11.4)	White	500
596-00504	NPL51X25WH	2.00 (50.8)	1.00 (25.4)	White	500
596-00507	NPL51X25BK	2.00 (50.8)	1.00 (50.8)	Black	500
596-00417	NPLH76X101WH	3.00 (76.2)	4.00 (101.6)	White	150

Dimensions are approximate and subject to technical changes. Use Part No. for ordering and Type for specification purposes.

Foam Nameplate Labels

Foam Button Nameplates

Foam Nameplate labels are designed to replace plastic and metal engraved phenolic plates commonly found on electrical control panels. The labels provide the look and feel of a plastic engraved or metal plate, but at a fraction of the cost. Labels can be printed using HellermannTyton Tagprint Pro labeling software and can include printed logos, barcodes and text of almost any size and type.

Features and Benefits

- Foam Nameplate labels are less costly than plastic or metal engraved plates, saving material costs.
- Foam Nameplate labels conform to textured and other low energy surfaces ensuring the labels stay in place for the life of the product.
- Labels are UV and chemical resistant for long life in an industrial environment.
- Foam Nameplate labels are printable using a thermal transfer printer for complete control and on-demand creation of labels.



MATERIAL	Polyester (PET)
Adhesive	Acrylate with base of acrylic foam
Operating Temperature	-40°F to +176°F (-40°C to +80°C)

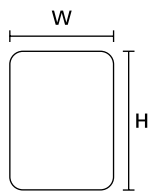

PART NO.	TYPE	Label Width (W) in. (mm)	Label Height (H) in. (mm)	Mounting Hole Dia. in. (mm)	Color	Qty. per Roll
596-00916	NPLH31X48BK22.5	1.20 (30.5)	1.90 (30.5)	0.88 (22.4)	Black	250
596-00915	NPLH31X48WH22.5	1.20 (30.5)	1.90 (30.5)	0.88 (22.4)	White	250
596-00407	NPLH31X38BK22.5	1.20 (30.5)	1.50 (38.1)	0.88 (22.4)	Black	250
596-00404	NPLH31X38WH22.5	1.20 (30.5)	1.50 (38.1)	0.88 (22.4)	White	250
596-00413	NPLH31X31BK22.5	1.25 (31.7)	1.25 (31.7)	0.88 (22.4)	Black	250
596-00412	NPLH31X31WH22.5	1.25 (31.7)	1.25 (31.7)	0.88 (22.4)	White	250
596-00415	NPLH44X44BK30.5	1.75 (44.4)	1.75 (44.4)	1.20 (30.5)	Black	250
596-00414	NPLH44X44WH30.5	1.75 (44.4)	1.75 (44.4)	1.20 (30.5)	White	250

Dimensions are approximate and subject to technical changes. Use Part No. for ordering and Type for specification purposes.

Foam Nameplate Labels

Emergency Stop Labels

Foam Nameplate labels are designed to replace plastic and metal engraved phenolic plates commonly found on electrical control panels. The labels provide the look and feel of a plastic engraved or metal plate, but at a fraction of the cost. Labels can be printed using HellermannTyton TagPrint® Pro labeling software and can include printed logos, barcodes and text of almost any size and type.

Features and Benefits

- Foam Nameplate labels are less costly than plastic or metal engraved plates, saving material costs.
- Foam Nameplate labels conform to textured and other low energy surfaces ensuring the labels stay in place for the life of the product.
- Labels are UV and chemical resistant for long life in an industrial environment.



MATERIAL	Polyester (PET)
Adhesive	Acrylate with base of acrylic foam
Operating Temperature	-40°F to +176°F (-40°C to +80°C)

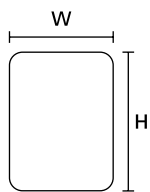

PART NO.	TYPE	Label Width (W) in. (mm)	Label Height (H) in. (mm)	Mounting Hole Dia. in. (mm)	Color	Qty. per Roll
596-00202	NPL60X60YE	2.38 (60.3)	2.38 (60.3)	1.20 (30.5)	Yellow	100

Dimensions are approximate and subject to technical changes. Use Part No. for ordering and Type for specification purposes.

Hand Writable Labels and Tags

Warning Signs

HellermannTyton's Hand Writable Markers are made from a flexible vinyl film and used to mark wire and cable. The self-laminating labels have a clear tail which seals the legend under clear vinyl, maintaining the quality of the labels.

Features and Benefits

- Clear laminating plastic flap permanently protects the writing and data marked on the tag.
- Mounting holes for easy mounting using standard cable ties.
- Markers can be mounted in any direction, either vertically, horizontally, as a wrap-around identification plate or as a flag for the best visual position on the cable assembly.



MATERIAL	Polyvinylchloride (PVC)
Operating Temperature	-40°F to +257°F (-40°C to +125°C)



PART NO.	TYPE	Description	Label Width (W) in. (mm)	Label Height (H) in. (mm)	Color	Qty. per Pkg.
CT0753X2	CT0753	Write-on tag with blank lines - nonadhesive	3.00 (76.2)	0.75 (11.1)	Orange	25
CTA0753X2	CTA0753	Write-on tag with blank lines - adhesive	3.00 (76.2)	1.00 (25.4)	Orange	25
CT2012X2	CT2012	Write-on tag for telephone cable - nonadhesive	3.50 (88.9)	1.50 (38.1)	Yellow	25
CT2003X2	CT2003	Write-on tag for fiber optic cable - nonadhesive	3.50 (88.9)	2.00 (6.4)	Orange	25
CT1503X2	CT1503	Write-on tag with blank lines - nonadhesive	4.00 (101.6)	1.50 (38.1)	Orange	25
CTA1503X2	CTA1503	Write-on tag with blank lines - adhesive	4.00 (101.6)	2.20 (55.9)	Orange	25

Dimensions are approximate and subject to technical changes. Use Part No. for ordering and Type for specification purposes.

Identification

Labels

Hand Writable Labels and Tags

Ground Wire Tags

HellermannTyton ground wire tags are fabricated using .035" thick polyethylene. Vinyl is rated for outdoor use, 5-7 years. Vinyl treated with titanium dioxide ultraviolet inhibitors.

Features and Benefits

- Mounting hole for easy attachment using standard cable ties.



MATERIAL	Polyethylene (PE)
Operating Temperature	-150°F to +149°F (-101°C to +65°C)

RoHS ✓

PART NO.	TYPE	Label Width (W) in. (mm)	Label Height (H) in. (mm)	Color	Qty. per Pkg.
GWC003X2	GW	3.00 (76.2)	1.50 (38.1)	Orange	25
GWT003X2		3.00 (76.2)	1.50 (38.1)	Orange	25

Dimensions are approximate and subject to technical changes. Use Part No. for ordering and Type for specification purposes.

Hand Writable Labels and Tags

Cable Markers - Polyethylene

HellermannTyton's cable markers are made from .05" thick polyethylene and can be marked using a permanent felt tip marker.

Features and Benefits

- Manufactured from 0.2" thick polyethylene for long term durability.
- Mounting holes for easy mounting using standard cable ties.
- Markers can be mounted in any direction, either vertically, horizontally, as a wrap-around identification plate or as a flag for the best visual position on the cable assembly.



MATERIAL	Polyethylene (PE)
Operating Temperature	-150°F to +149°F (-101°C to +65°C)



PART NO.	TYPE	Label Width (W) in. (mm)	Label Height (H) in. (mm)	Color	Qty. per Pkg.
FOM-75	FOM	1.50 (38.1)	0.75 (19.1)	Orange	25
FOM-150		2.25 (57.2)	1.50 (38.1)	Orange	25
FOM-175		3.50 (88.9)	1.75 (44.5)	Orange	25

Dimensions are approximate and subject to technical changes. Use Part No. for ordering and Type for specification purposes.

Hand Writable Labels and Tags

Fiber Optic Cable Tape

Designed to be used on the Lightguide Fiber Optic Protection System to identify the routing of fiber optic cable. It is a 1" wide range vinyl with black lettering that states, "FIBER OPTIC CABLE." The legend is repeated every six inches.

Features and Benefits

- Markers are pre-coiled so that they can be snapped into place over the cable without the use of adhesives.
- Non-adhesive design means that the markers can be installed at any temperature or over dirty or oily surfaces.
- Pre-printed text is protected by a thick layer of clear acrylic which provides UV protection and abrasion resistance.

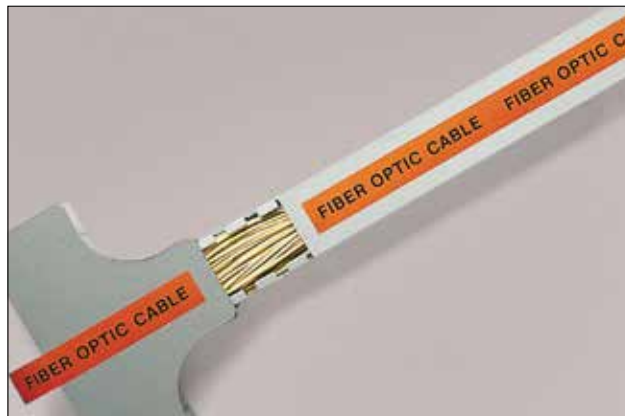

MATERIAL	Vinyl
Operating Temperature	-18°F to +200°F (-29°C to +93°C)



PART NO.	TYPE	Label Width (W) in. (mm)	Roll Length (L) ft. (m)	Color
TFOT-1	TFOT1	1.0 (25.4)	54.0 (16.5)	Orange

Dimensions are approximate and subject to technical changes. Use Part No. for ordering and Type for specification purposes.

Hand Writable Labels and Tags

Identification Marker Plates

Identification Marker Plates can be mounted in any direction, either vertically or horizontally as flags, tags, or wraparound identification plates. They can be hot stamped or marked with HellermannTyton marking pens (T82-S), thermal transfer labels, or laser labels. The markers are manufactured from nylon and are white in color.

Features and Benefits

- Identification Marker Plates can be marked with a permanent pen, printed labels or hot stamped for a wide variety of labeling options.
- Any size bundle diameter can be marked because it is only dependent upon the length of the cable tie selected, provided the cable tie width does not exceed 0.29".
- The marker plates are stamped from nylon, making them a durable and long term method of identification.
- The mounting holes are positioned to allow the marker to be mounted as a flag, tag or wrapped around the cable or bundle for a wide variety of installed positions.



MATERIAL	Polyamide 6.6 (PA66)
Flammability	UL 94 V2
Operating Temperature	-40°F to +185°F (-40°C to +85°C)



PART NO.	TYPE	Label Width (W) in. (mm)	Label Height (H) in. (mm)	Width (W2) in. (mm)	Color	Qty. per Pkg.
IMP1.510C2	IMP1.5	1.50 (19.1)	0.75 (19.1)	1.03 (26.2)	White	100
IMP1.7510C2	IMP1.75	1.75 (44.5)	0.75 (19.1)	1.28 (32.5)	White	100
IMP210C2	IMP2	2.00 (19.3)	0.75 (19.1)	1.53 (38.9)	White	100
IMP2.510C2	IMP2.5	2.50 (19.3)	0.75 (19.1)	2.03 (51.6)	White	100
IMP2.5W1.7510C2		2.50 (44.7)	1.75 (44.5)	2.03 (51.6)	White	100
IMP2.510M4		2.50 (63.5)	0.75 (19.1)	2.03 (51.6)	White	1000
IMP2.5W1.7510H4		2.50 (63.5)	1.75 (44.5)	2.03 (51.6)	White	500
IMP3.510C2	IMP3.5	3.50 (19.3)	0.75 (19.1)	3.03 (51.6)	White	100

Dimensions are approximate and subject to technical changes. Use Part No. for ordering and Type for specification purposes.

Hand Writable Labels and Tags

Q-Tags

Q-tags are used to identify a cable or a cable bundle and is secured with a Q-tie. The Q-tag's flag design allows the user to quickly read or scan the printed information. The tags can be marked by hand with a marker pen (T82 series) or with a printed adhesive label. HellermannTyton offers a complete printing solution for Q-tags: printers, labels, ribbons, and market leading label design software, TagPrint Pro. Using Q-ties and Q-tags gives users the confidence that cables and cable bundles are safely secured and the text is highly visible.

Features and Benefits

- Opening on the tag allows the Q Tie to be easily inserted, providing a secure identification solution



MATERIAL	Polyamide 6.6 (PA66)
Flammability	UL 94 V2
Operating Temperature	-40°F to +185°F (-40°C to +85°C)

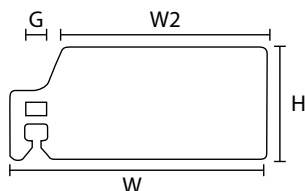

PART NO.	TYPE	Label Width (W) in. (mm)	Label Height (H) in. (mm)	Writable Area Width (W2) in. (mm)	Cable Tie Width Max. (G) in. (mm)	Color	Qty. per Pkg.
151-10952	QT7040S	3.46 (88.0)	1.65 (42.0)	1.57 (40.00)	0.14 (3.60)	White	50
151-10950	QT7016R	3.94 (100.0)	0.71 (18.0)	0.63 (16.00)	0.20 (4.70)	White	50
151-10951	QT7040R	3.94 (100.0)	1.65 (42.0)	1.57 (40.00)	0.20 (4.70)	White	50
151-10953	QT10065R	5.31 (135.0)	2.64 (67.1)	2.58 (65.00)	0.20 (4.70)	White	25

Dimensions are approximate and subject to technical changes. Use Part No. for ordering and Type for specification purposes.

Hand Writable Labels and Tags

Rite-On® Self-Laminating Labels and Dispenser

Rite-On Markers are made from a flexible vinyl film and used to mark wire and cable. The self-laminating labels have a clear tail which seals the legend under clear vinyl, maintaining the quality of the labels. The Rite-On markers are packaged in a reusable dispenser made from high impact plastic which is resistant to oils and grease.

Features and Benefits

- Compact to easily fit in pants or shirt pockets.
- Dispenser can be reloaded over and over, making it cost effective to use.
- Dispenser edge allows easy removal of label liner.
- Dispenser protects labels from dirt and moisture before use, extending the life and quality of the labels.



MATERIAL	Type 100, Vinyl (PVC), white (WH), self laminating
Operating Temperature	-51°F to +200°F (-46°C to +93°C)

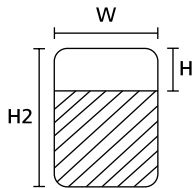

PART NO.	TYPE	Label Width (W) in. (mm)	Writable Area Height (H) in. (mm)	Label Height (H2) in. (mm)	Wire Size (AWG)	Min. Wire Size (in ²)	Qty. per Roll
RO514*	RO514	0.75 (19.1)	0.38 (9.5)	1.25 (31.8)	14 to 8	0.053	200
RO512*	RO512	0.75 (19.1)	0.50 (12.7)	1.876 (47.6)	8 to 4	0.263	150
RO175WP*	RO175WP	0.75 (19.1)	0.75 (19.1)	3.0 (76.2)	4 to 4/0	0.330	90
RO175*	RO175	0.75 (19.1)	0.75 (19.1)	3.0 (76.2)	4 to 4/0	0.330	90

Dimensions are approximate and subject to technical changes. Use Part No. for ordering and Type for specification purposes.

*This product meets UL standards. Please see appendix for specific file numbers.



Please note! Not all products listed on this page may have this approval. Please check our website for latest approvals.

Hand Writable Labels and Tags

Rite-On® Marker Refill Rolls

HellermannTyton's Rite-On markers are made from a flexible vinyl film and are used to mark wire and cable. The self-laminating labels have a clear tail which seals the legend under clear vinyl, maintaining the quality of the labels. The Rite-On markers are packaged in a reusable dispenser made from high-impact plastic which is resistant to oils and grease.

Features and Benefits

- Easily and conveniently fits in a pants or shirt pocket.
- Once loaded, unit allows minimal label exposure to dust and moisture.
- Can be used with standard ball point pens or HellermannTyton nylon marking pens.
- Excess liner is easily cut-off by tearing it over the edge guide at the front of the unit.
- The dispenser can be reloaded over and over again, making it a cost-effective and efficient method of labeling.



MATERIAL	Type 100, Vinyl (PVC), white (WH), self laminating
Operating Temperature	-40°F to +176°F (-40°C to +80°C)

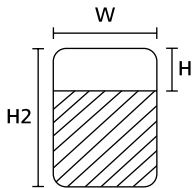

PART NO.	TYPE	Label Width (W) in. (mm)	Writable Area Height (H) in. (mm)	Label Height (H2) in. (mm)	Wire Size (AWG)	Min. Wire Size (in ²)	Qty. per Roll
514REF*	514REF	0.75 (19.1)	0.38 (9.5)	1.25 (31.8)	14 to 8	.053	200
512REF*	RO512REF	0.75 (19.1)	0.50 (12.7)	1.875 (47.6)	8 to 4	.263	150
175REF*	175REF	0.75 (19.1)	0.75 (19.1)	3.0 (76.2)	-	.330	90

Dimensions are approximate and subject to technical changes. Use Part No. for ordering and Type for specification purposes.

*This product meets UL standards. Please see appendix for specific file numbers.



Please note! Not all products listed on this page may have this approval. Please check our website for latest approvals.

Hand Writable Labels and Tags

Marking Pens

HellermannTyton's marker pens are ideally suited for manual inscription onto RiteOn, Helasign, Arrowtags, IMP Plates, and identification ties. The ink of these pens dries very quickly and is extremely UV resistant. Pens are available in packs of two in black.

Features and Benefits

- Marker pens are ideally suited for manual inscription onto RiteOn, Helasign, Arrowtags, IMP Plates, and identification ties.
- The ink of these pens dries very quickly and is extremely UV resistant.
- Pens are available in packs of two in black.



PART NO.	TYPE	Description	Color	Qty. per Pkg.
596-06321	Paint Pen	Paint pen	Black	1
T82S	T82S-BK	Felt tip pen	Black	2

Dimensions are approximate and subject to technical changes. Use Part No. for ordering and Type for specification purposes.

Printable Plastic Tags

TipTag Cable Markers

HellermannTyton's TipTags are halogen free, tear resistant, and lightweight cross laminated polyolefin that is ideal for use where weight is a critical factor. Each side is a different color. One side is yellow and the other side is white so that a high contrast black on yellow or black on white mark can be printed.

Features and Benefits

- Halogen free for low-smoke and low-fire hazard applications.
- White front and yellow back for versatility.
- Superior strength and tear resistance for long lasting identification.
- Pre-cut slots to secure the TipTags using HellermannTyton cable ties.

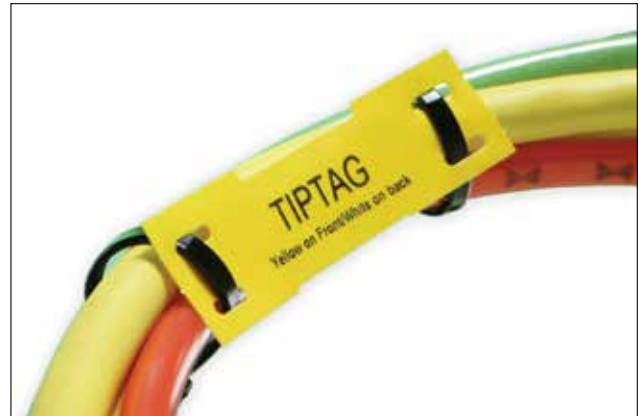

MATERIAL	Polyolefin (PO)
Operating Temperature	-58°F to +221°F (-50°C to +105°C)

HF ✓

RoHS ✓

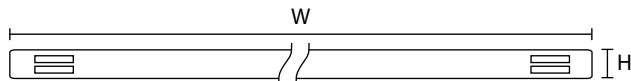

PART NO.	TYPE	Label Width (W) in. (mm)	Label Height (H) in. (mm)	Printable Area Width in. (mm)	Printable Area Height in. (mm)	Qty. per Roll
556-26006	TIPTAGVA10X65YEWH	2.59 (65.0)	0.50 (12.7)	2.58 (65.0)	0.40 (10.0)	500
556-26008	TIPTAGVA15X65YEWH	2.59 (65.0)	0.68 (17.4)	2.58 (65.0)	0.59 (15.0)	500
556-26007	TIPTAGVA10X90YEWH	3.54 (90.0)	0.50 (12.7)	3.54 (90.0)	0.40 (10.0)	500
556-26009	TIPTAGVA15X90YEWH	3.54 (90.0)	0.68 (17.4)	3.54 (90.0)	0.59 (15.0)	500

Dimensions are approximate and subject to technical changes. Use Part No. for ordering and Type for specification purposes.



Please note! Not all products listed on this page may have this approval. Please check our website for latest approvals.

Pre-Printed Wire Labels

Fiber Optic Cable Markers

HellermannTyton's coiled markers are made from heavy duty vinyl and come pre-printed with a standard warning.

Features and Benefits

- Markers are pre-coiled so that they can be snapped into place over the cable without the use of adhesives.
- Non-adhesive design means that the markers can be installed at any temperature or over dirty or oily surfaces.
- Pre-printed text is protected by a thick layer of clear acrylic which provides UV protection and abrasion resistance.



MATERIAL	Vinyl
Operating Temperature	-18°F to +200°F (-29°C to +93°C)



PART NO.	TYPE	Label Width (W) in. (mm)	Label Height (H) in. (mm)	Min. Cable Diameter in. (mm)	Max. Cable Diameter in. (mm)	Color	Qty. per Pack
CMFO4	CMF	4.00 (101.6)	3.00 (76.2)	0.49 (12.5)	1.00 (25.4)	White	25
CMFO72		7.25 (184.0)	5.00 (127.0)	0.49 (12.5)	1.00 (25.4)	Orange	25

Dimensions are approximate and subject to technical changes. Use Part No. for ordering and Type for specification purposes.

Identification

Labels

Pre-Printed Wire Labels

Handi-Pak Marker Booklets

Handi-Pak Marker Booklets are convenient pocket sized books that contain pages of black, pre-printed legends on a white background. The legends are printed on a plastic coated cloth label that remains flexible for use in identifying wires and cables. A strong adhesive assures long lasting identification on small wires, cables or anything requiring permanent or temporary identification.

Features and Benefits

- Handi-Paks booklets fit in a pocket for easy transport and access.
- A single marker can be removed at the top of each label so that the terminal block can be marked and the remaining label can be used to mark the associated wire connected to the terminal.
- Markers are kitted on each page so that any marker can be removed without affecting the other markers on the page.
- Markers have a micro-perforation in the middle of each marker so that they can be broken into two pieces for use on small gauge wires, eliminating waste and reducing costs.



MATERIAL	Vinyl Cloth (TYHC)
Adhesive	Rubber
Operating Temperature	-40°F to +248°F (-40°C to +120°C)



PART NO.	TYPE	Description	Booklet Qty.
TCWM1	TCWM1	45 Markers Each of 0-9	1
TCWM2	TCWM2	10 Markers Each of A-Z, 1-15, +, -, /	1
TCWM3	TCWM3	10 Markers Each of 1-45	1
TCWM4	TCWM4	150 Markers Each of 1, 2, 3	1
TCWM5	TCWM5	150 Markers Each of A, B, C	1
TCWM6	TCWM6	150 Markers Each of T1, T2, T3	1
TCWM7	TCWM7	150 Markers Each of L1, L2, L3	1
TCWM8	TCWM8	6 Markers Each of 1-15; 4 Markers Each of 16-90; and 2 Markers Each of A - Z, +, -, /	1
TCWM9	TCWM9	45 Markers Each of 1, 2, 3, A, B, C; 30 Markers Each of L1, L2, L3; and 30 Markers Each of T1, T2, and T3	1
TCWM10	TCWM10	45 Markers Each of 10 NEMA Colors	1
TCWM11	TCWM11	15 Markers Each of 1-30	1
TCWM12	TCWM12	15 Markers each of A-Z; 21 Markers each of Blank; 8 Markers each of +; 7 Markers each of -	1
TCWM13	TCWM13	45 Markers Each of +, -, AC, DC; 33 Markers Each of POS, NEG, and GND; 27 Markers Each of NEUT; 21 Markers Each of SPARE and BLANK	1
TCWM14	TCWM14	45 Markers Each of 0-9; 15 Markers Each of L1-L3; 15 Markers Each of T1-T3	1
TCWM15	TCWM15	10 Markers Each of 46-90	1
TCWM16	TCWM16	10 Markers Each of 1-33, A, B, C, +, -, T1-T3, L1-L3	1

Dimensions are approximate and subject to technical changes. Use Part No. for ordering and Type for specification purposes.

Pre-Printed Wire Labels

Handi-Card Wire and Cable Markers

HellermannTyton Handi-Cards are easy release pre-printed cloth markers, on a plastic card, with a strong adhesive for a long lasting bond on wire and cable. The markers are available in Solid format where each marker on the card contains the same legend and Sequence format where each marker on the card contains a different number or letter which is usually printed in sequence from lowest to highest in sort order.

Features and Benefits

- Handi-Cards have a split backing so that a portion of the liner can be removed to expose the markers for easy dispensing.
- Handi-Cards are kitted on the card so that specific markers can be removed without affecting the other markers on the card.
- Markers are pre-printed so no additional post printing is required, saving time and money.
- Label material is a conformable cloth that ensures markers stay on wires and cables for the life of the application.



MATERIAL	Vinyl Cloth (TYHC)
Adhesive	Rubber
Operating Temperature	-40°F to +248°F (-40°C to +120°C)



PART NO.	TYPE	Description	Labels per Card	Cards per Box
TYHC1-33	TYHC	0.25" x 1.5", Sequence #1-33, 33 Per Card	33	25
TYHC34-66	TYHC34-66	0.25" x 1.5", Sequence #34-66, 33 Per Card	33	25
TYHC67-99	TYHC67-99	0.25" x 1.5", Sequence #67-99, 33 Per Card	33	25
TYHCA-Z	TYHCA-Z	0.25" x 1.5", Sequence Letter A-Z, 36/Card	36	25
TYHC0	TYHC0	0.25" x 1.5", Solid #0, 36 Per Card	36	25
TYHC1	TYHC1	0.25" x 1.5", Solid #1, 36 Per Card	36	25
TYHC2	TYHC2	0.25" x 1.5", Solid #2, 36 Per Card	36	25
TYHC3	TYHC3	0.25" x 1.5", Solid #3, 36 Per Card	36	25
TYHC4	TYHC4	0.25" x 1.5", Solid #4, 36 Per Card	36	25
TYHC5	TYHC5	0.25" x 1.5", Solid #5, 36 Per Card	36	25
TYHC6	TYHC6	0.25" x 1.5", Solid #6, 36 Per Card	36	25
TYHC7	TYHC7	0.25" x 1.5", Solid #7, 36 Per Card	36	25
TYHC8	TYHC8	0.25" x 1.5", Solid #8, 36 Per Card	36	25
TYHC9	TYHC9	0.25" x 1.5", Solid #9, 36 Per Card	36	25
TYHC10	TYHC10	0.25" x 1.5", Solid #10, 36 Per Card	36	25
TYHC11	TYHC11	0.25" x 1.5", Solid #11, 36 Per Card	36	25
TYHC12	TYHC12	0.25" x 1.5", Solid #12, 36 Per Card	36	25

Dimensions are approximate and subject to technical changes. Use Part No. for ordering and Type for specification purposes.

Pre-Printed Wire Labels

Handi-Card Wire and Cable Markers

PART NO.	TYPE	Description	Labels per Card	Cards per Box
TYHC13	TYHC13	0.25" x 1.5", Solid #13, 36 Per Card	36	25
TYHC14	TYHC14	0.25" x 1.5", Solid #14, 36 Per Card	36	25
TYHC15	TYHC15	0.25" x 1.5", Solid #15, 36 Per Card	36	25
TYHC16	TYHC16	0.25" x 1.5", Solid #16, 36 Per Card	36	25
TYHC17	TYHC17	0.25" x 1.5", Solid #17, 36 Per Card	36	25
TYHC18	TYHC18	0.25" x 1.5", Solid #18, 36 Per Card	36	25
TYHC19	TYHC19	0.25" x 1.5", Solid #19, 36 Per Card	36	25
TYHC20	TYHC20	0.25" x 1.5", Solid #20, 36 Per Card	36	25
TYHC21	TYHC21	0.25" x 1.5", Solid #21, 36 Per Card	36	25
TYHC22	TYHC22	0.25" x 1.5", Solid #22, 36 Per Card	36	25
TYHC23	TYHC23	0.25" x 1.5", Solid #23, 36 Per Card	36	25
TYHC24	TYHC24	0.25" x 1.5", Solid #24, 36 Per Card	36	25
TYHC25	TYHC25	0.25" x 1.5", Solid #25, 36 Per Card	36	25
TYHC26	TYHC26	0.25" x 1.5", Solid #26, 36 Per Card	36	25
TYHC27	TYHC27	0.25" x 1.5", Solid #27, 36 Per Card	36	25
TYHC28	TYHC28	0.25" x 1.5", Solid #28, 36 Per Card	36	25
TYHC29	TYHC29	0.25" x 1.5", Solid #29, 36 Per Card	36	25
TYHC30	TYHC30	0.25" x 1.5", Solid #30, 36 Per Card	36	25
TYHC31	TYHC31	0.25" x 1.5", Solid #31, 36 Per Card	36	25
TYHC32	TYHC32	0.25" x 1.5", Solid #32, 36 Per Card	36	25
TYHC33	TYHC33	0.25" x 1.5", Solid #33, 36 Per Card	36	25
TYHC34	TYHC34	0.25" x 1.5", Solid #34, 36 Per Card	36	25
TYHC35	TYHC35	0.25" x 1.5", Solid #35, 36 Per Card	36	25
TYHC36	TYHC36	0.25" x 1.5", Solid #36, 36 Per Card	36	25
TYHC37	TYHC37	0.25" x 1.5", Solid #37, 36 Per Card	36	25
TYHC38	TYHC38	0.25" x 1.5", Solid #38, 36 Per Card	36	25
TYHC39	TYHC39	0.25" x 1.5", Solid #39, 36 Per Card	36	25
TYHC40	TYHC40	0.25" x 1.5", Solid #40, 36 Per Card	36	25
TYHC41	TYHC41	0.25" x 1.5", Solid #41, 36 Per Card	36	25
TYHC42	TYHC42	0.25" x 1.5", Solid #42, 36 Per Card	36	25
TYHC43	TYHC43	0.25" x 1.5", Solid #43, 36 Per Card	36	25
TYHC44	TYHC44	0.25" x 1.5", Solid #44, 36 Per Card	36	25
TYHC45	TYHC45	0.25" x 1.5", Solid #45, 36 Per Card	36	25
TYHC46	TYHC46	0.25" x 1.5", Solid #46, 36 Per Card	36	25
TYHC47	TYHC47	0.25" x 1.5", Solid #47, 36 Per Card	36	25
TYHC48	TYHC48	0.25" x 1.5", Solid #48, 36 Per Card,	36	25
TYHC49	TYHC49	0.25" x 1.5", Solid #49, 36 Per Card	36	25
TYHC50	TYHC50	0.25" x 1.5", Solid #50, 36 Per Card	36	25

Dimensions are approximate and subject to technical changes. Use Part No. for ordering and Type for specification purposes.

Pre-Printed Wire Labels

Handi-Card Wire and Cable Markers

PART NO.	TYPE	Description	Labels per Card	Cards per Box
TYHC51	TYHC51	0.25" x 1.5", Solid #51, 36 Per Card	36	25
TYHC52	TYHC52	0.25" x 1.5", Solid #52, 36 Per Card	36	25
TYHC53	TYHC53	0.25" x 1.5", Solid #53, 36 Per Card	36	25
TYHC54	TYHC54	0.25" x 1.5", Solid #53, 36 Per Card	36	25
TYHC55	TYHC55	0.25" x 1.5", Solid #55, 36 Per Card	36	25
TYHC81	TYHC	0.25" x 1.5", Solid #81, 36 Per Card	36	25
TYHC100	TYHC100	0.25" x 1.5", Solid #100, 36 Per Card	36	25
TYHCA	TYHCA	0.25" x 1.5", Solid Letter A, 36 Per Card	36	25
TYHCB	TYHCB	0.25" x 1.5", Solid Letter B, 36 Per Card	36	25
TYHCC	TYHCC	0.25" x 1.5", Solid Letter C, 36 Per Card	36	25
TYHCD	TYHCD	0.25" x 1.5", Solid Letter D, 36 Per Card	36	25
TYHCF	TYHCF	0.25" x 1.5", Solid Letter F, 36 Per Card	36	25
TYHCL	TYHCL	0.25" x 1.5", Solid Letter L, 36 Per Card	36	25
TYHCN	TYHCN	0.25" x 1.5", Solid Letter N, 36 Per Card	36	25
TYHCP	TYHCP	0.25" x 1.5", Solid Letter P, 36 Per Card	36	25
TYHCS	TYHCS	0.25" x 1.5", Solid Letter S, 36 Per Card	36	25

Dimensions are approximate and subject to technical changes. Use Part No. for ordering and Type for specification purposes.

Identification

Labels

Solar Identification

Metal Solar Placards - Hand Writable

Variable data placards are used to mark areas specific to the individual installation, like voltage data. Made of the same durable material as pre-printed metal solar placards, hand-writable placards are designed to meet industry codes. Hand-writable placards feature a silver variable data area that can be marked using an industrial paint pen.

Features and Benefits

- Placards made with UV stable inks and materials tested to last up to 25 years, even in direct sun exposure.
- Aggressive adhesive ensures strong bond, even on powder coated surfaces.
- Meets or exceeds NEC & IFC standards for printed text, character height, color and outdoor UV stability.
- Optional Paint Shields provide additional protection for pre-printed and variable data placards.



MATERIAL	Anodized Aluminum (AA)
Adhesive	Ultra High Bond Permanent Acrylic Adhesive
Operating Temperature	-40°F to +203°F (-40°C to +95°C)



PART NO.	TYPE	NEC Code	Label Width (W) in. (mm)	Label Height (H) in. (mm)	Color	Qty. per Pkg.	Drawing
596-00840	AC2011M5	2014, 2017	4.00 (101.6)	2.00 (50.8)	Black	5	
596-00841	ACDISCTM5	2014, 2017	3.75 (92.3)	1.00 (25.4)	Black	5	
596-00839	DC2011M5	2014	4.00 (101.6)	2.00 (50.8)	Black	5	
596-00918	DC2017M5	2017	3.75 (95.3)	1.75 (44.5)	Black	5	
596-00842	DCDISCTM5	2014, 2017	3.75 (95.3)	1.00 (25.4)	Black	5	
596-00864	DCRATINGM5	2011, 2014	4.00 (101.6)	2.00 (50.8)	Black	5	
596-00919	PVACDIS17M5	2017	3.75 (95.3)	1.00 (25.4)	Black	5	
596-00838	PVACDISM5	2014	3.75 (95.3)	1.00 (25.4)	Black	5	

Dimensions are approximate and subject to technical changes. Use Part No. for ordering and Type for specification purposes.

"Check-HT" is the mark of quality that represents a program of excellence in design and development over any other manufacturer in the industry.

Solar Identification

Metal Solar Placards - Engravable

Variable data placards are used to mark areas specific to the individual installation, like voltage data. Made of the same durable material as pre-printed metal solar placards, engravable placards are designed to meet industry codes. Engravable placards have a black area that can be engraved using standard engraving equipment.

Features and Benefits

- Placards made with UV stable inks and materials tested to last up to 25 years, even in direct sun exposure.
- Aggressive adhesive ensures strong bond, even on powder coated surfaces.
- Meets or exceeds NEC & IFC standards for printed text, character height, color and outdoor UV stability.
- Optional Paint Shields provide additional protection for pre-printed and variable data placards.



MATERIAL	Anodized Aluminum (AA)
Adhesive	Ultra High Bond Permanent Acrylic Adhesive
Operating Temperature	-40°F to +203°F (-40°C to +95°C)



PART NO.	TYPE	NEC Code	Label Width (W) in. (mm)	Label Height (H) in. (mm)	Color	Qty. per Pkg.	Drawing
596-00862	AC2011M5ENG	2014, 2017	4.00 (101.6)	2.00 (50.8)	Black	5	
596-00866	BLANK2X125	Blank Plate For Engraving	2.00 (50.8)	1.25 (31.8)	Black	5	
596-00867	BLANK4X75	Blank Plate For Engraving	4.00 (101.6)	0.75 (19.1)	Black	5	
596-00868	BLANK375X2	Blank Plate For Engraving	3.75 (95.3)	2.00 (50.8)	Black	5	
596-00863	DC2011M5ENG	2011, 2014	4.00 (101.6)	2.00 (50.8)	Black	5	
596-00922	DC2017M5ENG	2017	3.75 (95.3)	1.75 (44.5)	Black	5	
596-00858	DCDISCTM5ENG	2014, 2017	3.75 (92.3)	1.00 (25.4)	Black	5	
596-00865	DCRATINGM5ENG	2008, 2011, 2014	4.00 (101.6)	2.00 (50.8)	Black	5	
596-00923	PVACDIS17M5ENG	2017	3.75 (95.3)	1.00 (25.4)	Black	5	
596-00859	PVACDISM5ENG	2014	3.75 (95.3)	1.00 (25.4)	Black	5	

Dimensions are approximate and subject to technical changes. Use Part No. for ordering and Type for specification purposes. "Check-HT" is the mark of quality that represents a program of excellence in design and development over any other manufacturer in the industry.

Solar Identification

Preprinted Header Labels - Polyester

These labels come with preprinted color headers so only one color of ribbon is needed to complete the message panel. Labels can be used with TagPrint® Pro label software and HellermannTyton thermal transfer printers to reduce labor, eliminate minimum orders and allow the user to create labels on demand.

Features and Benefits

- Preprinted Solar Labels are made with UV-stable inks and materials for durability, weather resistance and long-term outdoor use.
- Polyester is resistant to chemicals and solvents and will remain legible in dirty environments.
- High abrasion and scuff resistance for high performance labeling.
- Meets NEC & IFC standards for printed text, character height, color and outdoor UV stability to pass inspections.



MATERIAL	Polyester (PET)
Adhesive	Acrylic
Operating Temperature	-40°F to +302°F (-40°C to +150°C)



PART NO.	TYPE	Description	Label Width (W) in. (mm)	Label Height (H) in. (mm)	Color	Qty. per Pkg.	Drawing
596-00425*	3X2CAUTION	Yellow CAUTION header	3.00 (76.2)	2.00 (50.8)	Yellow	250	
596-00635*	3X2CAUTIONUV	Yellow CAUTION header	3.00 (76.2)	2.00 (50.8)	Yellow	250	
596-00648*	3X2DANGERUV	Red DANGER header	3.00 (76.2)	2.00 (50.8)	Red	250	
596-00634*	3X2WARNINGUV	Orange WARNING header	3.00 (76.2)	2.00 (50.8)	Orange	250	
596-00636*	4X6CAUTIONUV	Yellow CAUTION header	6.00 (152.4)	4.00 (101.6)	Yellow	250	
596-00646*	4X6DANGERUV	Red DANGER header	6.00 (152.4)	4.00 (101.6)	Red	250	
596-00633*	4X6WARNINGUV	Orange WARNING header	6.00 (152.4)	4.00 (101.6)	Orange	250	

Dimensions are approximate and subject to technical changes. Use Part No. for ordering and Type for specification purposes.



*This product meets UL standards. Please see appendix for specific file numbers. "Check-HT" is the mark of quality that represents a program of excellence in design and development over any other manufacturer in the industry.



Please note! Not all products listed on this page may have this approval. Please check our website for latest approvals.

Solar Identification

Preprinted Header Labels - Polyester

PART NO.	TYPE	Description	Label Width (W) in. (mm)	Label Height (H) in. (mm)	Color	Qty. per Pkg.	Drawing
596-00800*	HL2X2YE	Yellow HAZARD header	2.00 (50.8)	2.00 (50.8)	Yellow	50	
596-00801*	HL3X3YE	Yellow HAZARD header	3.00 (76.2)	3.00 (76.2)	Yellow	50	

Dimensions are approximate and subject to technical changes. Use Part No. for ordering and Type for specification purposes.

*This product meets UL standards. Please see appendix for specific file numbers. "Check-HT" is the mark of quality that represents a program of excellence in design and development over any other manufacturer in the industry.



Please note! Not all products listed on this page may have this approval. Please check our website for latest approvals.

Identification

Labels

Solar Identification

Preprinted Metal Solar Placards

Variable data placards are used to mark areas specific to the individual installation, like voltage data. Made of the same durable material as pre-printed metal solar placards, HellermannTyton offers two styles of variable placards: hand-writable and engravable. Both hand-writable placards feature a silver variable data area that can be marked using an industrial paint pen. Engravable placards have a black area that can be engraved using standard engraving equipment.

Features and Benefits

- Placards made with UV stable inks and materials tested to last up to 25 years, even in direct sun exposure.
- Aggressive adhesive ensures strong bond, even on powder coated surfaces.
- Meets or exceeds NEC & IFC standards for printed text, character height, color and outdoor UV stability.
- Optional Paint Shields provide additional protection for pre-printed and variable data placards.



MATERIAL	Anodized Aluminum (AA)
Adhesive	Ultra High Bond Permanent Acrylic Adhesive
Operating Temperature	-40°F to +203°F (-40°C to +95°C)







PART NO.	TYPE	Label Width (W) in. (mm)	Label Height (H) in. (mm)	Color	Qty. per Pkg.	Drawing
596-00837	120VOLT5	3.75 (95.3)	2.00 (50.8)	Orange	5	
596-00835	BIPOLARPVM5	3.75 (95.3)	2.00 (50.8)	Orange	5	
596-00834	CBACKFEDM5	4.13 (104.6)	0.75 (19.1)	Yellow	5	
596-00917	IOCOD17M5	2.00 (50.8)	1.25 (31.8)	Orange	5	
596-00836	IOCODM5	2.00 (50.8)	1.25 (31.8)	Orange	5	
596-00861	MPVACDISM5	5.50 (139.7)	1.75 (44.4)	Red	5	
596-00860	MPVSDM5	5.50 (139.7)	1.75 (44.4)	Red	5	
596-00831	WDCCUM5	3.75 (95.3)	2.00 (50.8)	Orange	5	
596-00924	WDGC17M5	3.75 (95.3)	2.00 (50.8)	Orange	5	
596-00833	WDPSLBLM5	4.13 (104.6)	0.75 (19.1)	Orange	5	

Dimensions are approximate and subject to technical changes. Use Part No. for ordering and Type for specification purposes.

"Check-HT" is the mark of quality that represents a program of excellence in design and development over any other manufacturer in the industry.

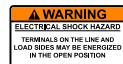
Solar Identification

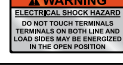
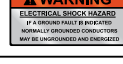
Preprinted Metal Solar Placards

PART NO.	TYPE	Label Width (W) in. (mm)	Label Height (H) in. (mm)	Color	Qty. per Pkg.	Drawing
596-00921	WESHLBL17M5	3.75 (95.3)	2.00 (50.8)	Orange	5	
596-00920	WESHLBLDC17M5	3.75 (95.3)	2.50 (63.5)	Orange	5	
596-00829	WESHLBLDCM5	3.75 (95.3)	2.50 (63.5)	Orange	5	
596-00828	WESHLBLM5	3.75 (95.3)	2.00 (50.8)	Orange	5	
596-00830	WGCMEM5	3.75 (95.3)	2.00 (50.8)	Orange	5	
596-00832	WTOPVLBLM5	3.75 (95.3)	2.00 (50.8)	Orange	5	

Dimensions are approximate and subject to technical changes. Use Part No. for ordering and Type for specification purposes.

"Check-HT" is the mark of quality that represents a program of excellence in design and development over any other manufacturer in the industry.

Identification

Labels

Solar Identification

Preprinted Solar Labels - Vinyl

Many times common solar label designs are specified even though they might not be required by code. HellermannTyton offers a selection of some of the most commonly requested labels for use on solar installations.

Features and Benefits

- Made with UV stable inks and materials for durability and weather resistance.
- The labels are supplied with aggressive adhesive to ensure long life.
- Solar Installation labels meet NEC & IFC standards for printed text, character height, color and outdoor UV stability to pass inspections.



MATERIAL	Vinyl
Adhesive	Acrylic
Operating Temperature	-40°F to +174°F (-40°C to +79°C)



PART NO.	TYPE	Label Width (W) in. (mm)	Label Height (H) in. (mm)	Color	Qty. per Pkg.	Drawing
596-00756*	ACCB	4.00 (101.6)	1.00 (25.4)	Red	50	AC COMBINER BOX
596-00740*	DCCB	4.00 (101.6)	1.00 (25.4)	Red	50	DC COMBINER BOX
596-00757*	DCD	4.00 (101.6)	1.00 (25.4)	Red	50	DC DISCONNECT
596-00738*	DCJB	4.00 (101.6)	1.00 (25.4)	Red	50	DC JUNCTION BOX
596-00739*	DNALP	5.00 (127.0)	1.25 (31.7)	Red	50	CAUTION: DO NOT INSTALL ADDITIONAL LOADS IN THIS PANEL
596-00748*	ECCMPV	4.00 (101.6)	2.00 (50.8)	Red	50	ENCLOSURE CONTAINS CONDUCTORS FROM MULTIPLE PV SOURCES
596-00750*	IOC	4.00 (101.6)	1.00 (25.4)	Yellow	50	CAUTION INVERTER INPUT CIRCUIT
596-00737*	PSKWH	4.00 (101.6)	1.00 (25.4)	Red	50	PHOTOVOLTAGE SYSTEM KWH METER
596-00735*	SMPV	4.00 (101.6)	2.00 (50.8)	Orange	50	WARNING THIS SERVICE METER IS ALSO SERVED BY A PHOTOVOLTAGE SYSTEM
596-00751*	SSB	2.00 (50.8)	1.00 (25.4)	Red	50	SOLAR SYSTEM BREAKER

Dimensions are approximate and subject to technical changes. Use Part No. for ordering and Type for specification purposes.

*This product meets UL standards. Please see appendix for specific file numbers.



Please note! Not all products listed on this page may have this approval. Please check our website for latest approvals.

Solar Identification

Preprinted Solar Labels - 443/552 Vinyl

HellermannTyton pre-printed Solar Installation Labels are designed to meet the requirements of the National Electrical Code and the International Fire Code as well as being acceptable to the Authority Having Jurisdiction (AHJ). Labels are made with durable UV-stable materials and adhesives that are designed to stick to both baked enamel and powder coat surfaces. Where applicable, labels are made using reflective materials for first responder safety. Some pre-printed labels are printable using a thermal transfer printer when variable voltage or series data must be printed and displayed.

Features and Benefits

- Pre-Printed Vinyl Solar Labels are made with UV-stable inks and materials for durability and weather resistance.
- Supplied with an aggressive adhesive to ensure long life.
- Meets NEC & IFC standards for printed text, character height, color and outdoor UV stability to pass inspections.
- Pre-printed labels offer significant time and cost savings over high priced plastic engraved phenolic placards and lead time purchased markers.



MATERIAL	Type 443/552, UV Stable Flexible White Vinyl with Acrylic Laminate
Adhesive	Acrylic
Operating Temperature	-40°F to +174°F (-40°C to +79°C)



PART NO.	TYPE	NEC Code	Label Width (W) in. (mm)	Label Height (H) in. (mm)	Color	Qty. per Pkg.	Drawing
596-00591*	120VOLT	2014, 2017	3.75 (95.3)	2.00 (50.8)	Orange	50	
596-00824*	120VOLTS	2014 (Spanish)	3.75 (95.3)	2.00 (50.8)	Orange	50	
596-00590*	BIPOLARPV	2014	3.75 (95.3)	2.00 (50.8)	Orange	50	
596-00236*	CBACKFED	2011	4.13 (104.6)	0.75 (19.1)	Red	50	
596-00587*		2014, 2017	4.13 (104.6)	0.75 (19.1)	Yellow	50	
596-00808*	CBACKFEDS	2014 (Spanish)	3.75 (95.3)	2.00 (50.8)	Orange	50	
596-00827*		2014 (Spanish)	4.13 (104.6)	0.75 (19.1)	Yellow	50	
596-00986*	ESSDCD	2017	5.50 (139.7)	1.75 (44.5)	Red	50	
596-00589*	IOCOD	2014	4.13 (104.6)	0.75 (19.1)	Orange	50	

Dimensions are approximate and subject to technical changes. Use Part No. for ordering and Type for specification purposes.

*This product meets UL standards. Please see appendix for specific file numbers. "Check-HT" is the mark of quality that represents a program of excellence in design and development over any other manufacturer in the industry.

















Please note! Not all products listed on this page may have this approval. Please check our website for latest approvals.

Identification

Labels

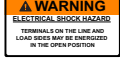
Solar Identification

Preprinted Solar Labels - 443/552 Vinyl

PART NO.	TYPE	NEC Code	Label Width (W) in. (mm)	Label Height (H) in. (mm)	Color	Qty. per Pkg.	Drawing
596-00846*	IOCOD14	2014	2.00 (50.8)	1.25 (31.8)	Orange	50	
596-00880*	IOCOD17	2017	4.13 (104.4)	0.75 (19.1)	Orange	50	
596-00883*	IOCOD17ST	2017	2.00 (50.8)	1.25 (31.8)	Orange	50	
596-00826*	IOCODS	2014 (Spanish)	4.13 (104.6)	0.75 (19.1)	Orange	50	
596-00258*	WDCCU	2011	4.13 (104.6)	2.00 (50.8)	Red	50	
596-00588*		2014	4.13 (104.6)	2.00 (50.8)	Orange	50	
596-09323*	WDGC17	2017	3.75 (95.2)	2.00 (50.8)	Orange	50	
596-00231*	WDPSLBL	2011	4.13 (104.6)	0.75 (19.1)	Red	50	
596-00495*		2014, 2017	4.13 (104.6)	0.75 (19.1)	Orange	50	
596-00233*	WESHLBL	2011	3.75 (95.3)	2.00 (50.8)	Red	50	
596-00497*		2014	3.75 (95.3)	2.00 (50.8)	Orange	50	
596-00878*	WESHLBL17	2017	3.75 (95.2)	2.00 (50.8)	Orange	50	
596-00232*	WESHLBLDC	2011	3.75 (95.3)	2.50 (63.5)	Red	50	
596-00496*		2014	3.75 (95.3)	2.50 (63.5)	Orange	50	
596-00879*	WESHLBLDC17	2017	3.75 (95.2)	2.50 (63.5)	Orange	50	

Dimensions are approximate and subject to technical changes. Use Part No. for ordering and Type for specification purposes.





*This product meets UL standards. Please see appendix for specific file numbers. "Check-HT" is the mark of quality that represents a program of excellence in design and development over any other manufacturer in the industry.



Please note! Not all products listed on this page may have this approval. Please check our website for latest approvals.

Solar Identification

Preprinted Solar Labels - 443/552 Vinyl

PART NO.	TYPE	NEC Code	Label Width (W) in. (mm)	Label Height (H) in. (mm)	Color	Qty. per Pkg.	Drawing
596-00802*	WESHLBLDCS	2014 (Spanish)	3.75 (95.3)	2.50 (63.5)	Orange	50	
596-00234*	WGCME	2011	4.13 (104.6)	2.00 (50.8)	Red	50	
596-00498*		2014	4.13 (104.6)	2.00 (50.8)	Orange	50	
596-00235*	WTOPVLBL	2011	4.13 (104.6)	2.00 (50.8)	Red	50	
596-00499*		2014, 2017	4.13 (104.6)	2.00 (50.8)	Orange	50	

Dimensions are approximate and subject to technical changes. Use Part No. for ordering and Type for specification purposes.

*This product meets UL standards. Please see appendix for specific file numbers. "Check-HT" is the mark of quality that represents a program of excellence in design and development over any other manufacturer in the industry.

Solar Identification

Clear Laminate for Solar Labels

HellermannTyton printable Solar Installation labels are designed to meet the requirements of the 2014 and 2017 National Electrical Code (NEC) and the International Fire Code (IFC) as well as being acceptable to the Authority Having Jurisdiction (AHJ). Labels are made with durable UV stable materials and adhesives that are designed to stick to both baked enamel and powder coat surfaces. Where applicable, labels are made using reflective materials for first responder safety. Some pre-printed labels are printable using a thermal transfer printer when variable voltage or series data must be printed and displayed.

Features and Benefits

- Made with UV stable inks and materials for durability and weather resistance.
- The labels are supplied with aggressive adhesive to ensure long life.
- Solar Installation labels meet NEC & IFC standards for printed text, character height, color and outdoor UV stability to pass inspections.



MATERIAL	Type 443/552, UV Stable Flexible White Vinyl with Acrylic Laminate
Adhesive	Acrylic
Operating Temperature	-40°F to +174°F (-40°C to +79°C)



PART NO.	TYPE	Description	Label Width (W) in. (mm)	Label Height (H) in. (mm)	Color	Qty. per Pkg.	Drawing
596-00242*	LAM1	Clear laminate, UV stable	4.20 (106.6)	2.25 (57.1)	Clear	50	
596-00670*	LAM110	Clear laminate, UV stable	4.20 (106.1)	2.25 (57.1)	Clear	10	

Dimensions are approximate and subject to technical changes. Use Part No. for ordering and Type for specification purposes.

*This product meets UL standards. Please see appendix for specific file numbers. "Check-HT" is the mark of quality that represents a program of excellence in design and development over any other manufacturer in the industry.



Please note! Not all products listed on this page may have this approval. Please check our website for latest approvals.

Solar Identification

Printable Solar Labels

Designed with cross-laminated UV stable materials, these variable print solar installation labels are designed to accept printing from any standard thermal transfer printer using a resin-based ink ribbon for the best durability. Print your voltage information directly on the label and then laminate with an optional clear acrylic laminate material for added protection. These labels can be used to print disconnecting means and breaker series directly on the labels for a more professional result and a smoother inspection process.

Features and Benefits

- Made with UV-stable inks and materials for durability and weather resistance.
- Polyester is resistant to chemicals and solvents and will remain legible in dirty environments.
- High abrasion and scuff resistance for high-performance labeling.
- Meets NEC & IFC standards for printed text, character height, color and outdoor UV stability to pass inspections.



MATERIAL	Type 840/926, Polyester (PET), UV stable, clear Polyester laminate
Adhesive	Acrylic
Operating Temperature	-40°F to +302°F (-40°C to +150°C)



PART NO.	TYPE	NEC Code	Label Width (W) in. (mm)	Label Height (H) in. (mm)	Color	Qty. per Pkg.	Drawing
596-00252*	AC2011	2014, 2017	4.00 (101.6)	2.00 (50.8)	Red	50	
596-00816*	AC2011S	(Spanish)	4.00 (101.6)	2.00 (50.8)	Red	50	
596-00813*	ACDISCS	(Spanish)	3.75 (92.3)	1.00 (25.4)	Red	50	
596-00237*	ACDISCT	2014, 2017	3.75 (92.3)	1.00 (25.4)	Red	50	
596-00240*	ACRATING	2014, 2017	4.00 (101.6)	2.00 (50.8)	Red	50	
596-00253*	DC2011	2014	4.00 (101.6)	2.00 (50.8)	Red	50	
596-00817*	DC2011S	(Spanish)	4.00 (101.6)	2.00 (50.8)	Red	50	
596-00891*	DC2017	2017	3.75 (95.3)	2.12 (53.8)	Red	50	

Dimensions are approximate and subject to technical changes. Use Part No. for ordering and Type for specification purposes.

*This product meets UL standards. Please see appendix for specific file numbers. "Check-HT" is the mark of quality that represents a program of excellence in design and development over any other manufacturer in the industry.



Please note! Not all products listed on this page may have this approval. Please check our website for latest approvals.

Solar Identification

Printable Solar Labels

PART NO.	TYPE	NEC Code	Label Width (W) in. (mm)	Label Height (H) in. (mm)	Color	Qty. per Pkg.	Drawing
596-00814*	DCDISCS	(Spanish)	3.75 (92.3)	1.00 (25.4)	Red	50	
596-00238*	DCDISCT	2014, 2017	3.75 (92.3)	1.00 (25.4)	Red	50	
596-00241*	DCRATING	2014	3.75 (92.3)	2.00 (50.8)	Red	50	
596-00987*	MBSDIS	2017	3.75 (95.3)	2.12 (53.8)	Red	50	
596-00239*	PVACDIS	2014	3.75 (95.3)	1.00 (25.4)	Red	50	
596-00892*	PVACDIS17	2017	3.75 (95.3)	1.00 (25.4)	Red	50	
596-00818*	PVACDISS	(Spanish)	3.75 (92.3)	1.00 (25.4)	Red	50	

Dimensions are approximate and subject to technical changes. Use Part No. for ordering and Type for specification purposes.

*This product meets UL standards. Please see appendix for specific file numbers. "Check-HT" is the mark of quality that represents a program of excellence in design and development over any other manufacturer in the industry.



Please note! Not all products listed on this page may have this approval. Please check our website for latest approvals.

Solar Identification

NEC 2017 and 2014 Reflective Rooftop Labels

Designed to meet NEC 2017 and 2014 Section 690.4(F) as interpreted by the International Association of Electrical Inspectors (IAEI), this aluminum and vinyl label is designed for use on almost any type of roof shingle. Mount via a pre-cut aluminum plate with aluminum clips (both supplied with label) to standard tar shingles, or bend, shape and fasten with construction adhesive or grommet screws on composite or wooden roofing. Label text is reflective to meet IFC requirements.

Features and Benefits

- Preprinted Solar Labels are made using high performance UV stable materials and adhesives for long outdoor life.
- Designed to meet NEC and IFC standards for PV installation labeling, the pre-printed Solar labels come printed with the most common legends required by the AHJ (Authority Having Jurisdiction) used on large utility and scaled projects to ensure code compliance during inspection.
- Labels are UV stable and made with special high bond adhesives to stick to both powder coat painted surfaces and baked enamel surfaces found on most disconnect switches and breaker boxes.
- The printed inks meet the fire safety standards of the IFC (International Fire Code) and also meet the requirements of UL969 for high reflectivity and durability.



MATERIAL	Type 242/552, UV Stable Reflective Vinyl w/Acrylic Laminate
Adhesive	Acrylic
Operating Temperature	-40°F to +174°F (-40°C to +79°C)



PART NO.	TYPE	Label Width (W) in. (mm)	Label Height (H) in. (mm)	Color	Qty. per Pkg.
596-00257*	PVPSRTM	6.75 (171.4)	2.75 (69.9)	Red Reflective (RDRF)	1

Dimensions are approximate and subject to technical changes. Use Part No. for ordering and Type for specification purposes.
 *This product meets UL standards. Please see appendix for specific file numbers.



Please note! Not all products listed on this page may have this approval. Please check our website for latest approvals.

Solar Identification

NEC 2017 and 2014 Reflective Solar Circuit Markers

These photovoltaic caution and power source markers are preprinted, non-adhesive, coiled markers that can be opened and snapped over cables for long-term, reflective, permanent identification. Made of a UV stable vinyl, the coiled markers come 25 per bag and will fit on all standard PV cables or electrical metallic tubing (EMT) conduits.

Features and Benefits

- Pre-Printed Solar Labels are made using high performance UV stable materials and adhesives for long outdoor life.
- Designed to meet NEC and IFC standards for PV installation labeling, the pre-printed Solar labels come printed with the most common legends required by the AHJ (Authority Having Jurisdiction) used on large utility and scaled projects to ensure code compliance during inspection.
- Labels are UV stable and made with special high bond adhesives to stick to both powder coat painted surfaces and baked enamel surfaces found on most disconnect switches and breaker boxes.
- The printed inks meet the fire safety standards of the IFC (International Fire Code) and also meet the requirements of UL969 for high reflectivity and durability.



MATERIAL	Vinyl
Operating Temperature	-18°F to +200°F (-29°C to +93°C)



PART NO.	TYPE	Label Width (W) in. (mm)	Label Height (H) in. (mm)	Color	Qty. per Pkg.	Drawing
596-00249	CSCSNAP4R	4.00 (101.6)	3.00 (76.2)	Red Reflective	25	
596-00251	CSCSNAP72R	7.25 (184.2)	5.00 (127.0)	Red Reflective	25	
596-00207	PVPSSNAP4	4.00 (101.6)	3.00 (76.2)	Red Reflective	25	
596-00208	PVPSSNAP72	7.25 (184.2)	5.00 (127.0)	Red Reflective	25	

Dimensions are approximate and subject to technical changes. Use Part No. for ordering and Type for specification purposes.

Solar Identification

Reflective Solar Labels

HellermannTyton Pre-Printed Solar Installation Labels are designed to meet the requirements of the National Electrical Code (NEC) and the International Fire Code (IFC) as well as being acceptable to the Authority Having Jurisdiction (AHJ). Labels are made with durable UV-stable materials and adhesives that are designed to stick to both baked enamel and powder coat surfaces. Where applicable, labels are made using reflective materials for first responder safety. Some pre-printed labels are printable using a thermal transfer printer when variable voltage or series data must be printed and displayed.

Features and Benefits

- Made with UV-stable inks and materials for durability and weather resistance.
- Reflective properties to meet applicable NEC code requirements for reflective identification.
- Supplied with an aggressive adhesive to ensure long life.
- Meets NEC & IFC standards for printed text, character height, color and outdoor UV stability to pass inspections.



MATERIAL	Type 242/552, UV Stable Reflective Vinyl w/Acrylic Laminate
Adhesive	Acrylic
Operating Temperature	-40°F to +174°F (-40°C to +79°C)



PART NO.	TYPE	Label Width (W) in. (mm)	Label Height (H) in. (mm)	Color	Qty. per Pkg.	Drawing
596-00615*	CSCIRLBL	6.50 (165.1)	1.00 (25.4)	Yellow	50	CAUTION: SOLAR CIRCUIT
596-00613*	CSESC	6.50 (165.1)	1.00 (25.4)	Yellow	50	CAUTION: SOLAR ELECTRICAL SYSTEM CONNECTED
596-00245*		6.50 (165.1)	1.00 (25.4)	Red	50	CAUTION: SOLAR ELECTRICAL SYSTEM CONNECTED
596-00821*	CSESCS	6.50 (165.1)	1.00 (25.4)	Yellow	50	PRECAUTION: SOLAR ELECTRICAL SYSTEM CONNECTED
596-00244*	DNDCTL	6.50 (165.1)	1.00 (25.4)	Red	50	DO NOT DISCONNECT UNDER LOAD
596-00255*	MPVACDIS	5.50 (139.7)	1.75 (44.4)	Red	50	MAIN PHOTOVOLTAIC SYSTEM AC DISCONNECT
596-00243*	MPVSD	5.50 (139.7)	1.75 (44.4)	Red	50	MAIN PHOTOVOLTAIC SYSTEM DISCONNECT
596-00474*	PSEWRS	5.50 (139.7)	1.75 (44.5)	Red	50	PHOTOVOLTAIC SYSTEM EQUIPPED WITH RAPID SHUTDOWN
596-00887*	PSEWRS17	6.50 (165.1)	1.00 (25.4)	Red	50	RAPID SHUTDOWN SWITCH FOR SOLAR PV SYSTEM
596-00823*	PSEWRSS	5.50 (139.7)	1.75 (44.5)	Red	50	SISTEMA FOTVOLTAICO EQUIPPADO CON INTERRUPTOR RAPIDO
596-00206*	PVPSR	6.50 (165.1)	1.00 (25.4)	Red	50	WARNING: PHOTOVOLTAIC POWER SOURCE
596-00896*	PVPSR500	6.50 (165.1)	1.00 (25.4)	Red	500	WARNING: PHOTOVOLTAIC POWER SOURCE

Dimensions are approximate and subject to technical changes. Use Part No. for ordering and Type for specification purposes.

*This product meets UL standards. Please see appendix for specific file numbers. "Check-HT" is the mark of quality that represents a program of excellence in design and development over any other manufacturer in the industry.



Please note! Not all products listed on this page may have this approval. Please check our website for latest approvals.

Identification

Labels

Solar Identification

Reflective Solar Labels

PART NO.	TYPE	Label Width (W) in. (mm)	Label Height (H) in. (mm)	Color	Qty. per Pkg.	Drawing
596-00886*	RSDRD17	6.00 (152.4)	4.00 (101.6)	Red	50	
596-00885*	RSDYL17	6.00 (152.4)	4.00 (101.6)	Yellow	50	
596-00246*	SOLARD	6.50 (165.1)	1.00 (25.4)	Red	50	
596-00810*	SOLARDS	6.50 (165.1)	1.00 (25.4)	Red	50	

Dimensions are approximate and subject to technical changes. Use Part No. for ordering and Type for specification purposes.

*This product meets UL standards. Please see appendix for specific file numbers. "Check-HT" is the mark of quality that represents a program of excellence in design and development over any other manufacturer in the industry.

Solar Identification

NEC Solar Label Convenience Packs - Reflective 242/552 Vinyl

HellermannTyton makes it easier than ever for solar installers to meet PV labeling codes. Solar Label Convenience Packs allow installers to quickly and economically purchase high quality preprinted NEC 2014 and 2017 code-compliant solar installation labels.

Packaged in 10-count quantities to meet the needs of smaller scale solar installations and independent contractors, Solar Label Convenience Packs are available in HellermannTyton's most popular preprinted NEC 2014 and 2017 code-compliant solar label formats.

Each Solar Label Convenience Pack contains 10 solar installation labels. Choose from a variety of regular and reflective preprinted labels. For enhanced durability, clear laminate overlay labels are also available in a convenience pack.

Features and Benefits

- Made with UV-stable inks and materials for durability and weather resistance.
- Reflective properties to meet applicable NEC code requirements for reflective identification.
- Supplied with an aggressive adhesive to ensure long life.
- Meets NEC & IFC standards for printed text, character height, color and outdoor UV stability to pass inspections.



MATERIAL	Type 242/552, UV Stable Reflective Vinyl w/Acrylic Laminate
Adhesive	Acrylic
Operating Temperature	-40°F to +174°F (-40°C to +79°C)



PART NO.	TYPE	NEC Code	Label Width (W) in. (mm)	Label Height (H) in. (mm)	Color	Qty. per Pkg.	Drawing
596-00673*	CSCIRLBL10	2014	6.50 (165.1)	1.00 (25.4)	Yellow	10	CAUTION: SOLAR CIRCUIT
596-00672*	CSESC10	2014	6.50 (165.1)	1.00 (25.4)	Yellow	10	CAUTION: SOLAR ELECTRIC SYSTEM CONNECTED
596-00671*	DND CUL10	2014, 2017	6.50 (165.1)	1.00 (25.4)	Red	10	DO NOT DISCONNECT UNDER LOAD
596-00676*	MPVACDIS10	2014, 2017	5.50 (139.7)	1.75 (44.4)	Red	10	MAIN PHOTOVOLTAIC SYSTEM AC DISCONNECT
596-00675*	MPVSD10	2014, 2017	5.50 (139.7)	1.75 (44.4)	Red	10	MAIN PHOTOVOLTAIC SYSTEM DISCONNECT
596-00677*	PSEWRS10	2014	5.50 (139.7)	1.75 (44.5)	Red	10	PHOTOVOLTAIC SYSTEM EQUIPPED WITH RAPID SHUTDOWN
596-00890*	PSEWRS1710	2017	6.50 (165.1)	1.00 (25.4)	Red	10	RAPID SHUTDOWN SWITCH FOR SOLAR PV SYSTEM
596-00678*	PVPSR10	2014, 2017	6.50 (165.1)	1.00 (25.4)	Red	10	WARNING: PHOTOVOLTAIC POWER SOURCE
596-00889*	RSDRD1710	2017	6.00 (152.4)	4.00 (101.6)	Red	10	SOLAR PV SYSTEM EQUIPPED WITH RAPID SHUTDOWN Rapid Shutdown Switch to Turn Off System Conductors Before the Work. Consult the NEC for the latest code requirements. (UL 1741-2014)
596-00888*	RSDYL1710	2017	6.00 (152.4)	4.00 (101.6)	Yellow	10	SOLAR PV SYSTEM EQUIPPED WITH RAPID SHUTDOWN Rapid Shutdown Switch to Turn Off System Conductors Before the Work. (UL 1741-2014)
596-00674*	SOLARD10	2014	6.50 (165.1)	1.00 (25.4)	Red	10	SOLAR DISCONNECT

Dimensions are approximate and subject to technical changes. Use Part No. for ordering and Type for specification purposes.

*This product meets UL standards. Please see appendix for specific file numbers. "Check-HT" is the mark of quality that represents a program of excellence in design and development over any other manufacturer in the industry.



Please note! Not all products listed on this page may have this approval. Please check our website for latest approvals.

Identification

Labels

Solar Identification

NEC Solar Label Convenience Packs - 443/552 Vinyl

HellermannTyton makes it easier than ever for solar installers to meet PV labeling codes. Solar Label Convenience Packs allow installers to quickly and economically purchase high quality preprinted NEC 2014 and 2017 code-compliant solar installation labels.

Packaged in 10-count quantities to meet the needs of smaller scale solar installations and independent contractors, Solar Label Convenience Packs are available in HellermannTyton's most popular preprinted NEC 2014 and 2017 code-compliant solar label formats.

Each Solar Label Convenience Pack contains 10 solar installation labels. Choose from a variety of regular and reflective preprinted labels. For enhanced durability, clear laminate overlay labels are also available in a convenience pack.

Features and Benefits

- Made with UV-stable inks and materials for durability and weather resistance.
- Reflective properties to meet applicable NEC code requirements for reflective identification.
- Supplied with an aggressive adhesive to ensure long life.
- Meets NEC & IFC standards for printed text, character height, color and outdoor UV stability to pass inspections.



MATERIAL	Type 443/552, UV Stable Flexible White Vinyl with Acrylic Laminate
Adhesive	Acrylic
Operating Temperature	-40°F to +174°F (-40°C to +79°C)



PART NO.	TYPE	NEC Code	Label Width (W) in. (mm)	Label Height (H) in. (mm)	Color	Qty. per Pkg.	Drawing
596-00669*	120VOLT10	2014, 2017	3.75 (92.3)	2.00 (50.8)	Orange	10	
596-00758*	ACCB10	2017	4.00 (101.6)	1.00 (25.4)	Red	10	
596-00667*	BIPOLARPV10	2014	3.75 (92.3)	2.00 (50.8)	Orange	10	
596-00666*	CBACKFED10	2014, 2017	4.12 (104.6)	0.75 (19.1)	Yellow	10	
596-00746*	DCCB10	2017	4.00 (101.6)	1.00 (25.4)	Red	10	
596-00759*	DCD10	2017	4.00 (101.6)	1.00 (25.4)	Red	10	
596-00744*	DCJB10	2017	4.00 (101.6)	1.00 (25.4)	Red	10	
596-00749*	ECCMPV10	2017	4.00 (101.6)	2.00 (50.8)	Red	10	
596-00753*	IOC10	2017	4.00 (101.6)	1.00 (25.4)	Yellow	10	

Dimensions are approximate and subject to technical changes. Use Part No. for ordering and Type for specification purposes.

*This product meets UL standards. Please see appendix for specific file numbers. "Check-HT" is the mark of quality that represents a program of excellence in design and development over any other manufacturer in the industry.



Please note! Not all products listed on this page may have this approval. Please check our website for latest approvals.

Solar Identification

NEC Solar Label Convenience Packs - 443/552 Vinyl

PART NO.	TYPE	NEC Code	Label Width (W) in. (mm)	Label Height (H) in. (mm)	Color	Qty. per Pkg.	Drawing
596-00668*	IOCOD10	2014	4.12 (104.7)	0.75 (19.1)	Orange	10	
596-00884*	IOCOD17ST10	2017	2.00 (50.8)	1.25 (31.8)	Orange	10	
596-00895*	IOCOD1710	2017	4.13 (104.6)	0.75 (19.1)	Orange	10	
596-00670*	LAM110	Clear laminate, UV stable	4.20 (106.1)	2.25 (57.1)	Clear	10	
596-00743*	PSKWH10	2017	4.00 (101.6)	1.00 (25.4)	Red	10	
596-00747*	SMPV10	-	4.00 (101.6)	2.00 (50.8)	Orange	10	
596-00662*	WDCCU10	2014	4.12 (104.6)	2.00 (50.8)	Orange	10	
596-09324*	WDGC1710	2017	3.75 (95.3)	2.00 (50.8)	Orange	10	
596-00665*	WDPSLBL10	2014, 2017	4.12 (104.7)	0.75 (19.1)	Orange	10	
596-00660*	WESHLBL10	2014	3.75 (92.3)	2.00 (50.8)	Orange	10	
596-00893*	WESHLBL1710	2017	3.75 (92.3)	2.00 (50.8)	Orange	10	
596-00661*	WESHLBLDC10	2014	3.75 (92.3)	2.50 (63.5)	Orange	10	
596-00894*	WESHLBLDC1710	2017	3.75 (92.3)	2.50 (63.5)	Orange	10	
596-00663*	WGCME10	2014	4.12 (104.7)	2.00 (50.8)	Orange	10	
596-00664*	WTOPVLBL10	2014, 2017	4.12 (104.6)	2.00 (50.8)	Orange	10	

Dimensions are approximate and subject to technical changes. Use Part No. for ordering and Type for specification purposes.

*This product meets UL standards. Please see appendix for specific file numbers. "Check-HT" is the mark of quality that represents a program of excellence in design and development over any other manufacturer in the industry.



Please note! Not all products listed on this page may have this approval. Please check our website for latest approvals.

Identification

Labels

Solar Identification

NEC Solar Label Convenience Packs - 840/926 Polyester

HellermannTyton makes it easier than ever for solar installers to meet PV labeling codes. Solar Label Convenience Packs allow installers to quickly and economically purchase high quality preprinted NEC 2014 and 2017 code-compliant solar installation labels.

Packaged in 10-count quantities to meet the needs of smaller scale solar installations and independent contractors, Solar Label Convenience Packs are available in HellermannTyton's most popular preprinted NEC 2014 and 2017 code-compliant solar label formats.

Each Solar Label Convenience Pack contains 10 installation labels. Choose from a variety of regular and reflective preprinted labels. For enhanced durability, clear laminate overlay labels are also available in a convenience pack.

Features and Benefits

- Made with UV-stable inks and materials for durability and weather resistance.
- Polyester is resistant to chemicals and solvents and will remain legible in dirty environments.
- High abrasion and scuff resistance for high-performance labeling.
- Meets NEC & IFC standards for printed text, character height, color and outdoor UV stability to pass inspections.



MATERIAL	Type 840/926, Polyester (PET), UV stable, clear Polyester laminate
Adhesive	Acrylic
Operating Temperature	-40°F to +302°F (-40°C to +150°C)



PART NO.	TYPE	NEC Code	Label Width (W) in. (mm)	Label Height (H) in. (mm)	Color	Qty. per Pkg.	Drawing
596-00855*	AC201110	2014, 2017	4.00 (101.6)	2.00 (50.8)	Red	10	
596-00853*	ACDISCT10	2014, 2017	3.75 (92.3)	1.00 (25.4)	Red	10	
596-00904*	AF5X35D	2017	5.00 (127.0)	3.75 (95.3)	Red	10	
596-00905*	AF5X35W	2017	5.00 (127.0)	3.75 (95.3)	Orange	10	
596-00850*	DC201110	2014	4.00 (101.6)	2.00 (50.8)	Red	10	
596-00881*	DC201710	2017	3.75 (95.3)	2.12 (53.8)	Red	10	
596-00854*	DCDISCT10	2014, 2017	3.75 (92.3)	1.00 (25.4)	Red	10	

Dimensions are approximate and subject to technical changes. Use Part No. for ordering and Type for specification purposes.



*This product meets UL standards. Please see appendix for specific file numbers. "Check-HT" is the mark of quality that represents a program of excellence in design and development over any other manufacturer in the industry.



Please note! Not all products listed on this page may have this approval. Please check our website for latest approvals.

Solar Identification

NEC Solar Label Convenience Packs - 840/926 Polyester

PART NO.	TYPE	NEC Code	Label Width (W) in. (mm)	Label Height (H) in. (mm)	Color	Qty. per Pkg.	Drawing
596-00851*	DCRATING10	2014	3.75 (92.3)	2.00 (50.8)	Red	10	
596-00852*	PVACDIS10	2014	3.75 (95.3)	1.00 (25.4)	Red	10	
596-00882*	PVACDIS1710	2017	3.75 (95.3)	1.00 (25.4)	Red	10	

Dimensions are approximate and subject to technical changes. Use Part No. for ordering and Type for specification purposes.

*This product meets UL standards. Please see appendix for specific file numbers. "Check-HT" is the mark of quality that represents a program of excellence in design and development over any other manufacturer in the industry.

Identification

Labels

Solar Identification

TT130SMC-Compatible Printable Solar Labels

Designed in a one-across landscape format to fit into the compact TT130SMC thermal transfer printer, these labels allow for code-compliant marking of variable information including disconnecting means, breaker series and voltage data. Made with cross-laminated UV stable materials, labels are ideal for use in solar installation applications. Use with the TT130SMC or any HellermannTyton thermal transfer printer.

Features and Benefits

- Made with UV-stable inks and materials for durability and weather resistance.
- Reflective properties to meet applicable NEC code requirements for reflective identification.
- Supplied with an aggressive adhesive to ensure long life.
- Meets NEC & IFC standards for printed text, character height, color and outdoor UV stability to pass inspections.



MATERIAL	Type 840/926, Polyester (PET), UV stable, clear Polyester laminate
Adhesive	Acrylic
Operating Temperature	-40°F to +302°F (-40°C to +150°C)



PART NO.	TYPE	Label Width (W) in. (mm)	Label Height (H) in. (mm)	Color	Qty. per Pkg.	Drawing
596-00655*	AC2011-1	2.00 (50.8)	4.00 (101.6)	Red	50	
596-00650*	ACDISC-1	1.00 (25.4)	3.75 (95.3)	Red	50	
596-00653*	DC2011-1	2.00 (50.8)	4.00 (101.6)	Red	50	
596-00651*	DCDISC-1	1.00 (25.4)	3.75 (95.3)	Red	50	
596-00654*	DCRATING-1	2.00 (50.8)	3.75 (95.3)	Red	50	
596-00652*	PVACDIS-1	1.00 (25.4)	3.75 (95.3)	Red	50	

Dimensions are approximate and subject to technical changes. Use Part No. for ordering and Type for specification purposes.

*This product meets UL standards. Please see appendix for specific file numbers. "Check-HT" is the mark of quality that represents a program of excellence in design and development over any other manufacturer in the industry.



Please note! Not all products listed on this page may have this approval. Please check our website for latest approvals.

Solar Identification

Paint Shields

HellermannTyton offers Paint Shield laminates that can be applied over Metal Solar Placards as a barrier against unintentional painting or graffiti. Paint Shields can also be used to provide additional protection for hand-written markings using a paint pen. HellermannTyton offers several sizes of Paint Shields designed to match all sizes of Metal Solar Placards. If a Paint Shield (covering placard) has been painted over, simply remove the shield to reveal original marking. Replace shield as needed.

Features and Benefits

- Made with UV stable inks and materials for durability and weather resistance.
- Supplied with aggressive adhesive to ensure long life.
- Meets NEC & IFC standards for printed text, character height, color and outdoor UV stability to pass inspections.
- Pre-printed labels offer significant time and cost savings over high priced engraved and lead time purchased markers.



MATERIAL	Type 240, 2.0 Mil Polyester (PET), Clear (CL)
Adhesive	1.0 Mil Aggressive Removable
Operating Temperature	-20°F to +302°F (-29°C to +150°C)



PART NO.	TYPE	Label Width (W) in. (mm)	Label Height (H) in. (mm)	Color	Qty. per Pkg.
596-00792	PAINTSHIELD1	3.60 (91.4)	2.38 (60.4)	Clear	10
596-00793	PAINTSHIELD2	3.50 (88.9)	1.75 (44.5)	Clear	10
596-00794	PAINTSHIELD3	4.00 (101.6)	1.80 (45.7)	Clear	10
596-00795	PAINTSHIELD4	5.38 (136.4)	1.63 (41.1)	Clear	10
596-00796	PAINTSHIELD5	3.60 (91.4)	0.90 (22.9)	Clear	10
596-00797	PAINTSHIELD6	3.90 (99.1)	0.70 (17.8)	Clear	10

Dimensions are approximate and subject to technical changes. Use Part No. for ordering and Type for specification purposes.

Metal Embossing Printer Systems

M-BOSS Compact Embossing Printer

M-BOSS Compact is a quiet, easy to use metal plate embossing printer with a small production footprint. It is simple to install and operate, needing just a standard electrical supply and a PC. Marker plates are attached to pipes and cables using 4.6mm width MBT cable ties and a MK9SST hand tool.

Features and Benefits

- Built in storage tray for safe storage of all printing components.
- Functions with TagPrint® Pro labeling software for easy label design.
- Tested to over 1.5 million strikes without maintenance for reliable embossing.
- Fast embossing speed for high volume marker production.



PART NO.	TYPE	Description	Width (W) in. (mm)	Height (H) in. (mm)	Color	Qty. per Pkg.
544-20000	M-BOSS Compact	M-BOSS Compact Embossing Printer	18.89 (480.0)	13.89 (353.0)	Blue	1
544-21000	M-BOSS Compact Organiser	M-BOSS Compact Embossing Printer with Organizer	18.89 (480.0)	13.89 (353.0)	Blue	1

Dimensions are approximate and subject to technical changes. Use Part No. for ordering and Type for specification purposes.



Please note! Not all products listed on this page may have this approval. Please check our website for latest approvals.

Metal Embossing Printer Systems

M-BOSS Compact Markers

M-BOSS Compact Markers are used in all areas where severe mechanical or chemical conditions occur, such as offshore industry, solar industry, marine engineering, petrochemical industry, mining, underground or on radio and cellular masts where mark permanence is critical.

Features and Benefits

- Raised marking ensure text visibility even when covered in dust, debris, grease and oil.
- Stainless steel grade SS316 is suited for use in harsh environments.
- Marker plates are designed for use with stainless steel cable ties with a 0.81" (4.6mm) strap width.



MATERIAL	Stainless Steel (SS316)
Operating Temperature	-112°F to +1000°F (-80°C to +538°C)

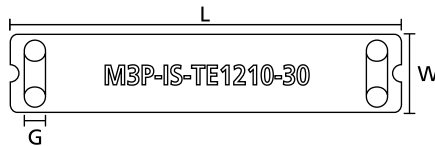
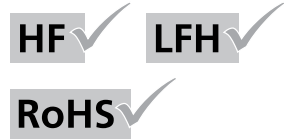

PART NO.	TYPE	Description	Label Width (W) in. (mm)	Label Height (H) in. (mm)	Cable Tie Width Max. in. (mm)	Qty. per Pkg.
544-80101	MBML10X45	M-BOSS Marker	1.8 (10.0)	0.4	0.2 (4.6)	1000
544-80201	MBML20X45	M-BOSS Marker	1.8 (20.0)	0.8	0.2 (4.6)	1000
544-80102	MBML10X90	M-BOSS Marker	3.5 (10.0)	0.4	0.2 (4.6)	500
544-80202	MBML20X90	M-BOSS Marker	3.5 (20.0)	0.8	0.2 (4.6)	500

Dimensions are approximate and subject to technical changes. Use Part No. for ordering and Type for specification purposes.

Identification

Labels

Paint Mask Labels

Paint Masks - Vinyl

HellermannTyton thermal transfer self-laminating Paint Mask Labels are conformable with a white printable surface followed by a clear tail that laminates the printed text when applied to a wire or cable. The labels utilize an aggressive acrylic adhesive that allows the label to bond to large and small diameter wires.

Features and Benefits

- Paint Mask Labels provide permanent paint protection but can still be removed at any time when required.
- Paint Mask Labels withstand chemicals and heat to survive the painting process.



MATERIAL	Vinyl
Adhesive	Acrylic
Operating Temperature	-40°F to +194°F (-40°C to +90°C)
Min. Application Temp.	+50°F (+10 °C)



PART NO.	TYPE	Label Width (W) in. (mm)	Height of Printable Area (H) in. (mm)	Label Height (H2) in. (mm)	Min. Bundle Diameter in. (mm)	Max. Bundle Diameter in. (mm)	Liner Width in. (mm)	Qty. per Roll
596-96253*	PW.25W1	1.00 (25.4)	0.75 (19.1)	4.75 (120.6)	0.13 (3.2)	0.38 (9.5)	2.00 (50.8)	1000
596-96262*	PW2.75W1	1.00 (25.4)	1.50 (38.1)	4.37 (110.9)	0.63 (15.8)	0.88 (22.2)	2.38 (60.4)	500
596-96260*	PW.50W1	1.00 (25.4)	1.50 (38.1)	7.43 (188.7)	0.38 (9.5)	0.63 (15.8)	3.00 (76.2)	500
596-96257*	PW2.75W2	2.00 (50.8)	1.50 (38.1)	4.37 (110.9)	0.63 (15.8)	0.88 (22.2)	4.20 (106.6)	500
596-96254*	PW.50W2	2.00 (50.8)	1.50 (38.1)	7.43 (188.7)	0.38 (9.5)	0.63 (15.8)	3.00 (76.2)	500

Dimensions are approximate and subject to technical changes. Use Part No. for ordering and Type for specification purposes.
*This product meets UL standards. Please see appendix for specific file numbers.



Please note! Not all products listed on this page may have this approval. Please check our website for latest approvals.

Paint Mask Labels

Paint Masks - Polyester Film

HellermannTyton thermal transfer self-laminating Paint Mask Labels are conformable with a white printable surface followed by a clear tail that laminates the printed text when applied to a wire or cable. The labels utilize an aggressive acrylic adhesive that allows the label to bond to large and small diameter wires.

Features and Benefits

- Paint Mask Labels provide permanent paint protection but can still be removed at any time when required.
- Paint Mask Labels withstand chemicals and heat to survive the painting process.



MATERIAL	Polyester Film
Adhesive	Acrylic
Operating Temperature	-40°F to +300°F (-40°C to +149°C)
Min. Application Temp.	+50°F (+10 °C)



PART NO.	TYPE	Label Width (W) in. (mm)	Height of Printable Area (H) in. (mm)	Label Height (H2) in. (mm)	Min. Bundle Diameter in. (mm)	Max. Bundle Diameter in. (mm)	Liner Width in. (mm)	Qty. per Roll
596-96255	PW.25W1P	1.00 (25.4)	0.75 (19.1)	4.75 (120.6)	0.13 (3.2)	0.38 (9.5)	2.00 (50.8)	1000
596-96263	PW2.75W1P	1.00 (25.4)	1.50 (38.1)	4.37 (110.9)	0.63 (15.8)	0.88 (22.2)	2.38 (60.4)	500
596-96261	PW.50W1P	1.00 (25.4)	1.50 (38.1)	7.43 (188.7)	0.38 (9.5)	0.63 (15.8)	3.00 (76.2)	500
596-96258	PW2.75W2P	2.00 (50.8)	1.50 (38.1)	4.37 (110.9)	0.63 (15.8)	0.88 (22.2)	4.20 (106.6)	500
596-96256	PW.50W2P	2.00 (50.8)	1.50 (38.1)	7.43 (188.7)	0.38 (9.5)	0.63 (15.8)	3.00 (76.2)	500

Dimensions are approximate and subject to technical changes. Use Part No. for ordering and Type for specification purposes.



Please note! Not all products listed on this page may have this approval. Please check our website for latest approvals.

Identification

Labels

Safety Labels

Pre-Printed Voltage Markers

HellermannTyton Pre-Printed Voltage Markers are made of durable vinyl and are available with the most commonly used warnings and alerts. The self-adhesive markers allow users to clearly identify electrical lines, voltages and hazards. The durable adhesive backing is resistant to UV exposure as well as chemicals and solvents. Use voltage markers on conduit, pipe, circuit boxes or electrical panels.

Features and Benefits

- HellermannTyton Voltage Markers are available in three sizes to best suit application requirements.
- Glare-free surface for easy identification from any angle.
- Resists moisture for long-lasting durability.
- Markers are flexible to wrap securely around various size wires, pipes and conduit.
- Includes part number on label to assist with reorders.



MATERIAL	Vinyl
Adhesive	Acrylic
Operating Temperature	-40°F to +176°F (-40°C to +80°C)



PART NO.	TYPE	Description	Label Width (W) in. (mm)	Label Height (H) in. (mm)	Cards per Pkg.	Drawing
596-00946	VM110A	Voltage Marker, 110 Volts, 1/card, 50 cards/pkg	8.50 (215.2)	2.25 (57.2)	50	
596-00947	VM110C	Voltage Marker, 110 Volts, 17/card, 50 cards/pkg	2.25 (57.2)	0.50 (12.7)	50	
596-00928	VM120/208A	Voltage Marker, 120/208 Volts, 1/card, 50 cards/pkg	8.50 (215.2)	2.25 (57.2)	50	
596-00929	VM120/208B	Voltage Marker, 120/208 Volts, 4/card, 50 cards/pkg	4.25 (108.0)	1.13 (28.6)	50	
596-00930	VM120/208C	Voltage Marker, 120/208 Volts, 17/card, 50 cards/pkg	2.25 (57.2)	0.50 (12.7)	50	
596-00958	VM120/240B	Voltage Marker, 120/240 Volts, 4/card, 50 cards/pkg	4.25 (108.0)	1.13 (28.6)	50	
596-00925	VM120A	Voltage Marker, 120 Volts, 1/card, 50 cards/pkg	8.50 (215.2)	2.25 (57.2)	50	
596-00926	VM120B	Voltage Marker, 120 Volts, 4/card, 50 cards/pkg	4.25 (108.0)	1.13 (28.6)	50	
596-00927	VM120C	Voltage Marker, 120 Volts, 17/card, 50 cards/pkg	2.25 (57.2)	0.50 (12.7)	50	
596-00931	VM208A	Voltage Marker, 208 Volts, 1/card, 50 cards/pkg	8.50 (215.2)	2.25 (57.2)	50	
596-00932	VM208B	Voltage Marker, 208 Volts, 4/card, 50 cards/pkg	4.25 (108.0)	1.13 (28.6)	50	
596-00933	VM208C	Voltage Marker, 208 Volts, 17/card, 50 cards/pkg	2.25 (57.2)	0.50 (12.7)	50	
596-00957	VM220B	Voltage Marker, 220 Volts, 4/card, 50 cards/pkg	4.25 (108.0)	1.13 (28.6)	50	
596-00955	VM230C	Voltage Marker, 230 Volts, 17/card, 50 cards/pkg	2.25 (57.2)	0.50 (12.7)	50	
596-00934	VM240A	Voltage Marker, 240 Volts, 1/card, 50 cards/pkg	8.50 (215.2)	2.25 (57.2)	50	

Dimensions are approximate and subject to technical changes. Use Part No. for ordering and Type for specification purposes.

Safety Labels

Pre-Printed Voltage Markers

PART NO.	TYPE	Description	Label Width (W) in. (mm)	Label Height (H) in. (mm)	Cards per Pkg.	Drawing
596-00935	VM240B	Voltage Marker, 240 Volts, 4/card, 50 cards/pkg)	4.25 (108.0)	1.13 (28.6)	50	
596-00936	VM240C	Voltage Marker, 240 Volts, 17/card, 50 cards/pkg)	2.25 (57.2)	0.50 (12.7)	50	
596-00938	VM277/480A	Voltage Marker, 277/480 Volts, 1/card, 50 cards/pkg)	8.50 (215.2)	2.25 (57.2)	50	
596-00939	VM277/480B	Voltage Marker, 277/480 Volts, 4/card, 50 cards/pkg)	4.25 (108.0)	1.13 (28.6)	50	
596-00940	VM277/480C	Voltage Marker, 277/480 Volts, 17/card, 50 cards/pkg)	2.25 (57.2)	0.50 (12.7)	50	
596-00937	VM277C	Voltage Marker, 277 Volts, 17/card, 50 cards/pkg)	2.25 (57.2)	0.50 (12.7)	50	
596-00948	VM440A	Voltage Marker, 440 Volts, 1/card, 50 cards/pkg)	8.50 (215.2)	2.25 (57.2)	50	
596-00949	VM440C	Voltage Marker, 440 Volts, 17/card, 50 cards/pkg)	2.25 (57.2)	0.50 (12.7)	50	
596-00950	VM460A	Voltage Marker, 460 Volts, 1/card, 50 cards/pkg)	8.50 (215.2)	2.25 (57.2)	50	
596-00951	VM460C	Voltage Marker, 460 Volts, 17/card, 50 cards/pkg)	2.25 (57.2)	0.50 (12.7)	50	
596-00941	VM480A	Voltage Marker, 480 Volts, 1/card, 50 cards/pkg)	8.50 (215.2)	2.25 (57.2)	50	
596-00942	VM480B	Voltage Marker, 480 Volts, 4/card, 50 cards/pkg)	4.25 (108.0)	1.13 (28.6)	50	
596-00943	VM480C	Voltage Marker, 480 Volts, 17/card, 50 cards/pkg)	2.25 (57.2)	0.50 (12.7)	50	
596-00952	VM600A	Voltage Marker, 600 Volts, 1/card, 50 cards/pkg)	8.50 (215.2)	2.25 (57.2)	50	
596-00953	VM600C	Voltage Marker, 600 Volts, 17/card, 50 cards/pkg)	2.25 (57.2)	0.50 (12.7)	50	
596-00954	VM4160A	Voltage Marker, 4160 Volts, 1/card, 50 cards/pkg)	8.50 (215.2)	2.25 (57.2)	50	
596-00956	VMHIGHVOLTAGEA	Voltage Marker, HIGH VOLTAGE, 1/card, 50 cards/pkg)	8.50 (215.2)	2.25 (57.2)	50	
596-00944	VMSINGLEPHASEB	Voltage Marker, Single Phase, 4/card, 50 cards/pkg)	4.25 (108.0)	1.13 (28.6)	50	
596-00945	VMTHREEPHASEB	Voltage Marker, Three Phase, 4/card, 50 cards/pkg)	4.25 (108.0)	1.13 (28.6)	50	

Dimensions are approximate and subject to technical changes. Use Part No. for ordering and Type for specification purposes.

Identification

Labels

Safety Labels

Pre-Printed Safety Signs

HellermannTyton Pre-Printed Safety Signs are made of durable vinyl and are supplied with the most commonly used warnings and alerts. The acrylic adhesive backing is resistant to UV exposure as well as chemicals and solvents.

Features and Benefits

- HellermannTyton Signs are designed to meet the needs of most common applications, making sign selection easy and effective.
- Signs are code and ANSI compliant to meet all municipal requirements.
- Includes bar code and part number on sign to assist with reorders.



MATERIAL	Vinyl
Adhesive	Acrylic
Operating Temperature	-90°F to +186°F (-67°C to +75°C)



PART NO.	TYPE	Label Width (W) in. (mm)	Label Height (H) in. (mm)	Color	Qty. per Pkg.	
597-00080	NS710APO	10.00 (254.0)	7.00 (177.8)	Blue	25	
597-00081	NS710SGRITA	10.00 (254.0)	7.00 (177.8)	Blue	25	
597-00085	FS710FAS	10.00 (254.0)	7.00 (177.8)	Green	25	
597-00123	EE710AWS	10.00 (254.0)	7.00 (177.8)	Red	25	
597-00074	DS710CSEBPO	10.00 (254.0)	7.00 (177.8)	Red	25	
597-00072	DS710DHV	10.00 (254.0)	7.00 (177.8)	Red	25	
597-00068	DS710NSM	10.00 (254.0)	7.00 (177.8)	Red	25	

Dimensions are approximate and subject to technical changes. Use Part No. for ordering and Type for specification purposes.

Safety Labels

Pre-Printed Safety Signs

PART NO.	TYPE	Label Width (W) in. (mm)	Label Height (H) in. (mm)	Color	Qty. per Pkg.	
597-00077	DS710TMSASA	10.00 (254.0)	7.00 (177.8)	Red	25	
597-00082	ES710EXIT	10.00 (254.0)	7.00 (177.8)	Red	25	
597-00083	FS710FE	10.00 (254.0)	7.00 (177.8)	Red	25	
597-00086	NS710NAES	10.00 (254.0)	7.00 (177.8)	Red	25	
597-00121	CS710AFEP	10.00 (254.0)	7.00 (177.8)	Yellow	25	
597-00078	CS710CWYS	10.00 (254.0)	7.00 (177.8)	Yellow	25	
597-00079	CS710DNOWG	10.00 (254.0)	7.00 (177.8)	Yellow	25	
597-00100	NS1014SGRITA	14.00 (355.6)	10.00 (254.0)	Blue	25	
597-00101	NS1014APO	14.00 (355.6)	10.00 (254.0)	Blue	25	
597-00124	EE1014AWS	14.00 (355.6)	10.00 (254.0)	Red	25	
597-00094	DS1014CSEBPO	14.00 (355.6)	10.00 (254.0)	Red	25	
597-00092	DS1014DHV	14.00 (355.6)	10.00 (254.0)	Red	25	
597-00088	DS1014NSM	14.00 (355.6)	10.00 (254.0)	Red	25	





Dimensions are approximate and subject to technical changes. Use Part No. for ordering and Type for specification purposes.

Identification

Labels

Safety Labels

Pre-Printed Safety Signs

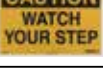
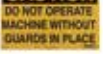
PART NO.	TYPE	Label Width (W) in. (mm)	Label Height (H) in. (mm)	Color	Qty. per Pkg.	
597-00097	DS1014TMSASA	14.00 (355.6)	10.00 (254.0)	Red	25	
597-00102	ES1014EXIT	14.00 (355.6)	10.00 (254.0)	Red	25	
597-00103	FS1014FE	14.00 (355.6)	10.00 (254.0)	Red	25	
597-00106	NS1014NAES	14.00 (355.6)	10.00 (254.0)	Red	25	
597-00122	CS1014AFEP	14.00 (355.6)	10.00 (254.0)	Yellow	25	
597-00098	CS1014CWYS	14.00 (355.6)	10.00 (254.0)	Yellow	25	
597-00099	CS1014DNOWG	14.00 (355.6)	10.00 (254.0)	Yellow	25	

Dimensions are approximate and subject to technical changes. Use Part No. for ordering and Type for specification purposes.

CAUTION: Stick with reliable safety labels to keep areas safe.

Our voltage markers and safety signs are made to last, maintaining high visibility for years. They cover all the most common requirements. What more could you want? We think there's plenty. For medium to large general contractors, they are bulk boxed for easy dispensing – ideal for use in service trucks. Voltage markers and signs are sold individually (single cards or signs) at competitive price points and include product numbers to make reorders easy.

MADE FOR REAL

120 VOLTS
596-00925 8.5" x 2.25"

597-00077
10.0" x 7.0"

Hellermann

Hell

See the full variety of quality, code-compliant markers and signs:
www.hellermann.tyton.com/SafetyLabels

Thermal Transfer Printers

TT130SMC Thermal Transfer Printer

Designed for low-volume printing, HellermannTyton's TT130SMC thermal transfer printer is made of durable materials for long life in a variety of applications and environments. The compact, portable design makes it ideal for transporting to work sites. HellermannTyton thermal transfer printers work flawlessly with HellermannTyton TagPrint® Pro label printing software to create customized labels. An integrated cutter cuts continuous label media and an optional caddy holds larger label stock reels to allow higher capacity printing.

Features and Benefits

- Compact, lightweight design saves space and is easy to transport.
- Integrated cutter cuts continuous media to any length.
- Designed to work with TagPrint® Pro label design software for ultimate label printing capabilities.



PART NO.	TYPE	Description	Pkg. Qty.
556-00250*	TT130SMC	Printer TT130SMC with Cutter	1
556-00257*	2TT130SMCKIT	Two-Printer Kit with Cutter	1
556-00253	TT130SMCCASE	Printer Case	1
556-00254*	TT130SMCKIT	Printer Kit	1
556-00255*	TT130SMCCORD	Replacement Power Cord	1
556-00252*	TT130PWRSPLY	Replacement Power Supply TT130SMC	1
556-00251*	TT130RPHEAD	Replacement Print Head TT130SMC	1

Dimensions are approximate and subject to technical changes. Use Part No. for ordering and Type for specification purposes.

*This product meets UL standards. Please see appendix for specific file numbers.



Please note! Not all products listed on this page may have this approval. Please check our website for latest approvals.

Thermal Transfer Printers

TT130SMC Ribbon

Thermal Transfer Ribbons are designed for use in HellermannTyton thermal transfer printers. Available on 1/2" cores, the ribbons are coated side out and available in different lengths. All ribbons are available in a variety of colors and are matched to the HellermannTyton label stock to give the best chemical and abrasion resistance.

Features and Benefits

- Ribbons are resin based for the best print durability.
- Ribbons are available to fit all HellermannTyton printers for easy resupply.
- Ribbons are available in colors for maximizing design printing capabilities.
- Ribbons meet UL recognition and Military standard where applicable to meet specific industry label requirements.

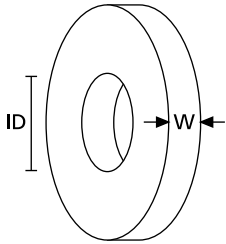

PART NO.	TYPE	Description	Pkg. Qty.
TT822OUTSM-2	TT822OUTSM-2	Black Ribbon, 2.24" x 242', 1/2" Core	1
556-00205	TTWHITEOUTSM-2	White Ribbon, 2.24" x 154', 1/2" Core	1

Dimensions are approximate and subject to technical changes. Use Part No. for ordering and Type for specification purposes.

Thermal Transfer Printers

TT230 Series Printers

HellermannTyton's TT230 series thermal transfer printers are designed for low to medium volume printing of thermal transfer labels and ShrinkTrak. The TT230 series delivers optimal performance not found in other small desktop printers. These lightweight printers offer high speed, precision, and flexible printing with the ability to print on most HellermannTyton labels and ShrinkTrak. Used in conjunction with TagPrint Pro 4.0, the TT230 series will offer error-free printing and seamless operation.

Features and Benefits

- LCD user interface for easier setup, diagnostics and adjustments.
- 300 dpi print head for high-resolution printing.
- Label holder included for convenient loading of any size media.
- Small footprint for easy transport to jobsites or around the shop.
- Ethernet ready for wireless network connectivity.
- Print speeds up to 4 in (76.2 mm) per second for fast label production.
- 2 MB flash/8 MB DRAM for accepting large label files that require a lot of data.



PART NO.	TYPE	Description	Pkg. Qty.
556-00230*	TT230SM	TT230SM Printer	1
556-00240*	TT230SMC	TT230SMC Printer	1
556-00239*	TT230SM KIT	TT230SM Printer Kit	1
556-00256*	TT230SMC KIT	TT230SM Printer Kit with Cutter	1
556-00231	CASE230SM	TT230SM Carrying Case, 15.25" x 12.13" x 10"	1
556-00238	CASE LG TT230SM	TT230SM Carrying Case, 25.52" x 19.5" x 13.08"	1
556-00234*	RPR TT230SM	Replacement Platen Roller TT230SM	1
556-00233*	RPS TT230SM	Replacement Power Supply TT230SM	1
556-00232*	PRH TT230SM	Replacement Print Head TT230SM	1
556-00235	LABEL HOLDER	Label Holder TT130SMC/TT230 Series	1

Dimensions are approximate and subject to technical changes. Use Part No. for ordering and Type for specification purposes.

*This product meets UL standards. Please see appendix for specific file numbers.



Please note! Not all products listed on this page may have this approval. Please check our website for latest approvals.

Thermal Transfer Printers

TT230 Series Ribbon

HellermannTyton thermal transfer ribbons are designed for use in HellermannTyton thermal transfer printers. Available on 1/2" cores, the ribbons are coated side out and available in two different lengths. All ribbons are available in a variety of colors and are matched to the HellermannTyton label stock to give the best chemical and abrasion resistance.

Features and Benefits

- Ribbons are resin based for the best print durability.
- Ribbons are available to fit all HellermannTyton printers for easy resupply.
- Ribbons are available in colors for maximizing design printing capabilities.
- Ribbons meet UL recognition and Military standard where applicable to meet specific industry label requirements.

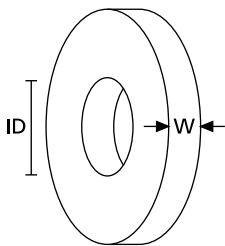

PART NO.	TYPE	Description	Pkg. Qty.
TT822OUTSM	TT822OUTSM	Black Ribbon, 4.33" x 242', 1/2" Core, Hard Resin Polyester Film	1
TT100OUTSM	TT100OUTSM	Black Ribbon, 4.33" x 242', 1/2" Core, Soft Resin Polyester Film	1
TTDTHOUTSM	TTDTHOUTSM	Black Ribbon, 4.33" x 295', 1/2" Core, Durattach Resin	1
TTHSTOUTSM	TTHSTOUTSM	Black Ribbon, 4.33" x 298', 1/2" Core, ShrinkTrak Polyester Film	1
TT822OUTSM6	TT822OUTSM6	Blue Ribbon, 4.33" x 242', 1/2" Core, Polyester Film	1
TT822OUTSM5	TT822OUTSM5	Green Ribbon, 4.33" x 242', 1/2" Core, Polyester Film	1
TT822OUTSM3	TT822OUTSM3	Orange Ribbon, 4.33" x 242', 1/2" Core, Polyester Film	1
TT822OUTSM2	TT822OUTSM2	Red Ribbon, 4.33" x 242', 1/2" Core, Polyester Film	1
TT822OUTSM8	TT822OUTSM8	Silver Ribbon, 4.33" x 242', 1/2" Core, Polyester Film	1
TT822OUTSM7	TT822OUTSM7	Violet Ribbon, 4.33" x 242', 1/2" Core, Polyester Film	1
556-00258	TTWHITEOUTSM2	White Ribbon, 4.33" x 229', 1/2" Core, 822 Resin	1
556-00190	TTWHITEOUTSM	White Ribbon, 4.33" x 229', 1/2" Core, Polyester Film	1
TT822OUTSM4	TT822OUTSM4	Yellow Ribbon, 4.33" x 242', 1/2" Core, Polyester Film	1

Dimensions are approximate and subject to technical changes. Use Part No. for ordering and Type for specification purposes.

Thermal Transfer Printers

TTM430/TTM460 Printers

HellermannTyton's TTM430/TTM460 thermal transfer printers are designed for medium to high volume users of thermal transfer labels and ShrinkTrak. The user-friendly design features a streamlined menu for simple navigation, while the built in caddy allows even the largest label rolls to fit inside the printer. The optional cutter can cut through the thickest material. The TTM430/TTM460 printers are designed to handle all sizes of HellermannTyton's ShrinkTrak markers, and the TTM430/TTM460 can print on even the smallest labels.

Features and Benefits

- Available with 300 dpi and 600 dpi print heads for high resolution printing.
- Ethernet ready for easy network connectivity.
- Floating print head to automatically adjust to varying media thickness such as printable heat shrink tubing.
- Optional cutter faceplate for automatic cutting and kitting of printed labels.



PART NO.	TYPE	Description	Pkg. Qty.
556-00430*	TTM430	TTM430 Printer, 300 dpi	1
556-00443*	TTM430-SC	TTM430SC printer with cutter, 300 dpi	1
556-00460	TTM460	TTM460 Printer, 600 dpi	1
556-03065	Printhead TTM430	Replacement Print Head, TTM430	1
556-03068	TTM430SPH300	Replacement Print Head TTM430S	1
556-00461	TTM460 Printhead	Replacement Print Head, TTM460	1
556-03069	TTM430SPH600	Replacement Print Head TTM460S	1
556-00433	430RLH	Label Caddy, TTM430/TTM460	1
556-00431	430CFP	Label Cutter, TTM430/TTM460	1
556-00432*	430WLAN	WLAN Card, TTM430	1
556-00434	430RRH	Ribbon Holder, TTM430/TTM460	1

Dimensions are approximate and subject to technical changes. Use Part No. for ordering and Type for specification purposes.

*This product meets UL standards. Please see appendix for specific file numbers.



Please note! Not all products listed on this page may have this approval. Please check our website for latest approvals.

Thermal Transfer Printers

TTM430/TTM460 Ribbon

HellermannTyton thermal transfer ribbons are designed for use in HellermannTyton thermal transfer printers. Available on 1" cores, the ribbons are coated side out. All ribbons are available in a variety of colors and are matched to the HellermannTyton label stock to give the best chemical and abrasion resistance.

Features and Benefits

- Ribbons are resin based for the best print durability.
- Ribbons are available to fit all HellermannTyton printers for easy resupply.
- Ribbons are available in colors for maximizing design printing capabilities.
- Ribbons meet UL recognition and Military standard where applicable to meet specific industry label requirements.

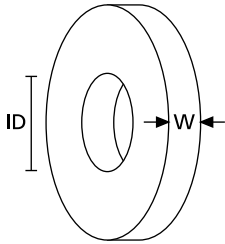

PART NO.	TYPE	Description	Pkg. Qty.
TTDTHOUT	TTDTHOUT	Black Ribbon, 4.0" x 984', 1" Core, DTH Resin	1
TTHSTOUT	TTHSTOUT	Black Ribbon, 4.0" x 984', 1" Core, Polyester Film	1
TT900OUT	TT900OUT	Black Ribbon, 4.0" x 985', 1" Core, Polyester Film	1
TT822OUT*	TT822OUT	Black Ribbon, 4.33" x 984', 1" Core, Polyester Film	1
TT822OUT6	TT822OUT6	Blue Ribbon, 4.33" x 984', 1" Core, Polyester Film	1
TT822OUT5	TT822OUT5	Green Ribbon, 4.33" x 984', 1" Core, Polyester Film	1
TT822OUT3	TT822OUT3	Orange Ribbon, 4.33" x 984', 1" Core, Polyester Film	1
TT822OUT7	TT822OUT7	Purple Ribbon, 4.33" x 984', 1" Core, Polyester Film	1
TT822OUT2	TT822OUT2	Red Ribbon, 4.33" x 984', 1" Core, Polyester Film	1
TT822OUT8	TT822OUT8	Silver Ribbon, 4.33" x 984', 1" Core, Polyester Film	1
556-00259	TTWHITEOUT2	White Ribbon, 4.33" x 984', 1" Core, 822 Resin	1
556-00189	TTWHITEOUT	White Ribbon, 4.33" x 984', 1" Core, Polyester Film	1
TT822OUT4	TT822OUT4	Yellow Ribbon, 4.33" x 984', 1" Core, Polyester Film	1

Dimensions are approximate and subject to technical changes. Use Part No. for ordering and Type for specification purposes.

*This product meets UL standards. Please see appendix for specific file numbers.



Please note! Not all products listed on this page may have this approval. Please check our website for latest approvals.

Thermal Transfer Printers

TT4030 Thermal Transfer Printer

HellermannTyton's premium printer TT4030 is specifically designed for medium and heavy duty industrial application. The 300 dpi print head fulfills all standard requirements for printing bar codes, warning signs, logos and written information. Optional premium quality accessories such as a perforator and cutter are designed to work seamlessly with the printer and will suit the most demanding needs.

Printing high definition graphics such as 2d barcodes, standard bar codes, numbers and text on adhesive labels, thermo plastics such as heat shrink and cable markers (Tiptags) is easily done.

A color LCD touchscreen with modern user interface helps intuitive operation.

Creation of professional looking industrial identification is simplified by the use of HellermannTyton's label creation software TagPrint Pro 4.0.

Whether in stand-alone mode, as a PC application or in a network - the robust TT4030 printer can meet every requirement.

Features and Benefits

- High volume single sided printing.
- Premium-quality printer is designed for medium- to heavy-duty industrial applications.
- Ultra-fast print speeds up to 11.8 in (300 mm) per second.
- 300 dpi print head cleanly renders best-in-class high-definition graphics and text on labels, thermo plastics such as heat shrink and TipTags.
- Standard adjustments are made with the on-board tool, minimizing operator downtime.
- Optional premium quality accessories such as a perforator and cutter extend the printer's productivity.



Print Head Type	300 dpi, flat type
Print Speed	up to 11.8" (300 mm)/sec.
Max. Print Width	4 "
Printer Interfaces	RS232 C, USB 2.0, Ethernet 10/100 Base T
Supported Barcodes	Standard, 2D
Printer Memory	256 MB RAM



PART NO.	TYPE	Description	Pkg. Qty.
556-04037	TT4030	TT4030 Printer, 300 dpi	1
556-04050	S4030 Cutter	Cutter, TT4030	1
556-04005	Printer Roller TT4030/TT4000+	Platen Roller, TT4030	1
556-04041	TT4030 Printhead	Print Head, 300 dpi, TT4030	1

Dimensions are approximate and subject to technical changes. Use Part No. for ordering and Type for specification purposes.



Please note! Not all products listed on this page may have this approval. Please check our website for latest approvals.

Labeling Software

TagPrint Pro 4.0 Label Printing Software

TagPrint Pro 4.0 provides revolutionary label design simplicity and ease of use. With industry-leading print automation built in, users can create a label or an entire group of labels once and save under a single job number, along with additional data such as which printer to print to. Then, simply scan a bar code or enter the job number to open the group and print in one step. This significantly reduces production time and operator-related errors. TagPrint Pro is pre-loaded with popular, code-compliant safety and solar label designs to simplify common tasks.

Features and Benefits

- TagPrint Pro 4.0 runs on Windows 7, 8.1 and 10, allowing full compatibility and error-free operation with the most widely used systems.
- Print automation allows one-step printing of label jobs – even multi-label groups – to one or more printers simultaneously.
- Visual preview allows users to see label designs before opening them.
- Single-user and network-user versions accommodate the needs of any size operation.
- Select saved labels visually or by part number.
- Convert existing XMT files to the TagPrint data table.
- Allows devmode printing to the TT4030 thermal transfer printer, for the ultimate in printer control.
- Includes pre-saved designs for all common ANSI/OSHA compliant safety labels and pre-made solar installation labels.



PART NO.	TYPE	Description	Pkg. Qty.
556-00035	TAGPRINT3	TagPrint Pro 4.0, Single User License	1
556-00036	TAGPRINT3LIC	TagPrint Pro 4.0, 3 License Network Program	1
556-00037	TAGPRINT5LIC	TagPrint Pro 4.0, 5 License Network Program	1
556-00038	TAGPRINT10LIC	TagPrint Pro 4.0, 10 License Network Program	1
556-00039	TAGPRINT25LIC	TagPrint Pro 4.0, 25 License Network Program	1
556-00052	TAGPRINT50LIC	TagPrint Pro 4.0, 50 License Network Program	1
556-00042	TAGPRINT3UPGRD	TagPrint Pro 4.0, Upgrade, TagPrint 2.0 Serial # Required	1
556-00043	TAGPRINT3UPGRD3S	TagPrint Pro 4.0, Upgrade, 1 User to 3 User	1
556-00044	TAGPRINT3UPGRD5S	TagPrint Pro 4.0, Upgrade, 3 User to 5 User	1
556-00045	TAGPRINT3UPGRD10S	TagPrint Pro 4.0, Upgrade, 5 User to 10 User	1
556-00046	TAGPRINT3UPGRD25S	TagPrint Pro 4.0, Upgrade, 10 User to 25 User	1

Dimensions are approximate and subject to technical changes. Use Part No. for ordering and Type for specification purposes.

Inspired by automation

Highly automated production requires processes you can count on, which is why our developers have systematically enhanced our automated bundling techniques. The current model is the Autotool 2000 CPK. It offers high reproducibility of binding results, individual control and complete documentation. Bulk quantities – such as in cable confectioning, the automotive industry and the packaging sector – can be processed more quickly and reliably as a result.



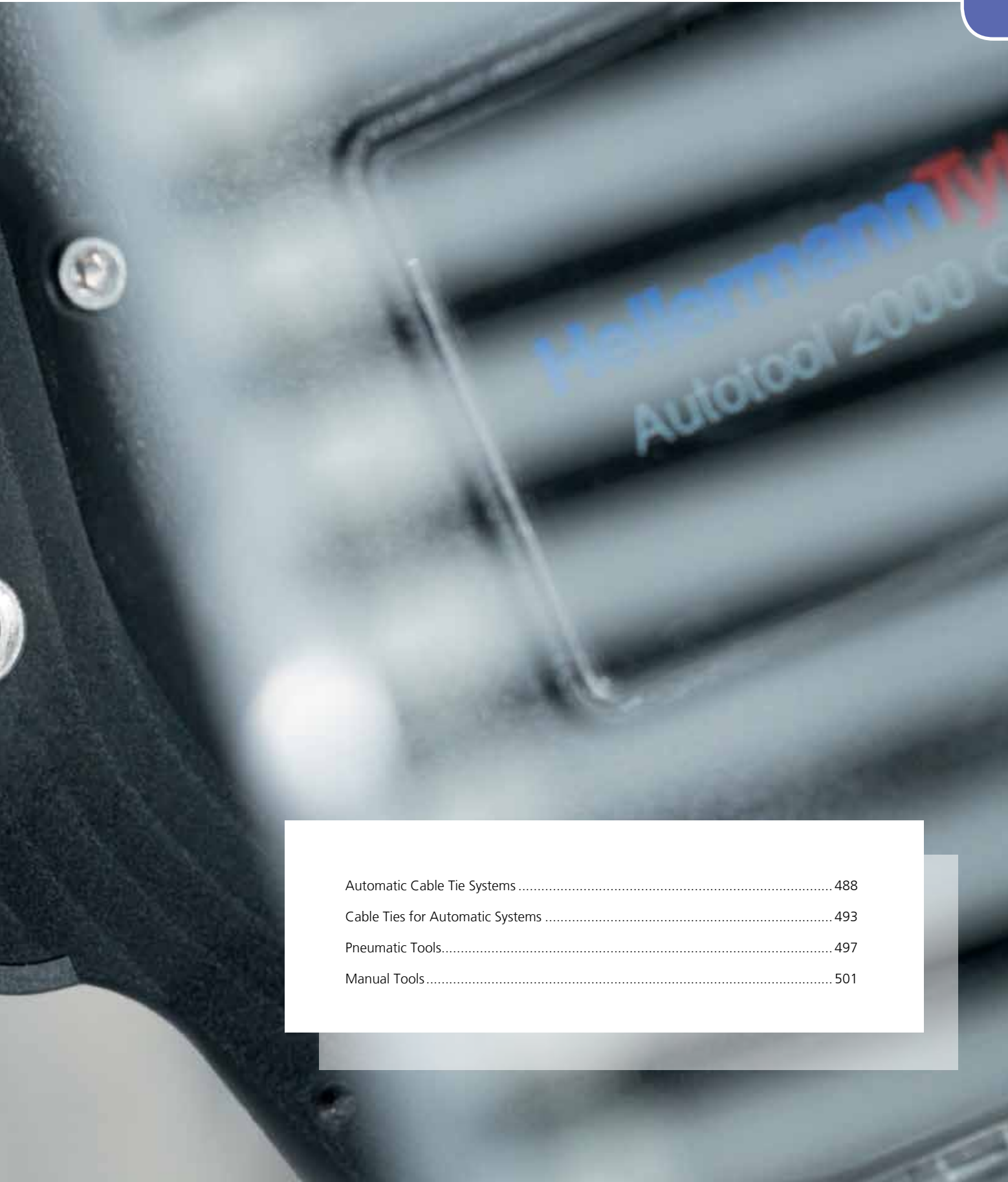

Automatic Cable Tie Systems	488
Cable Ties for Automatic Systems	493
Pneumatic Tools.....	497
Manual Tools.....	501

Application Tools

Automatic Cable Tie Systems

Automatic Cable Tie Systems

AT2060 Tool

HellermannTyton's AT2060 system includes tool, power supply, power cord, tool cord, and maintenance and operation manual. This system can be used in handheld, bench mount, and overhead assembly configurations. The versatile overhead assembly option provides the ultimate integration into the customer's manufacturing area. HellermannTyton's autotool AT2060 is powered by a standard 110 AC 27V electrical outlet that the power supply converts to a low DC voltage for the tool.

Features and Benefits

- **Fast:** Cable ties are installed quickly with one easy trigger depression, increasing productivity while decreasing labor costs.
- **Reliable:** HellermannTyton's automatic cable tie systems have been tested to perform extremely consistently, without interruption to workflow.
- **Ergonomic:** The ergonomic design of the automatic cable tie tool systems feature a comfortable grip, low weight, and easy trigger depression to reduce installer effort and strain while installing cable ties.
- **Providing Valuable Operator Feedback:** Equipped with a self diagnostic LCD information screen, the automatic cable tie system easily guides the user through the cycles of cable tie installations.
- **Flexible Manufacturing Versatility:** HellermannTyton's cable tie tool systems support principles of flexible manufacturing requirements and environments.
- **Uniform Fastening Quality:** HellermannTyton's automatic cable tie systems feature adjustable tension control to deliver consistent levels of cable tie fastening.
- **Range:** The AT2060 installs 30lb ties for bundles up to 1-1/4" .

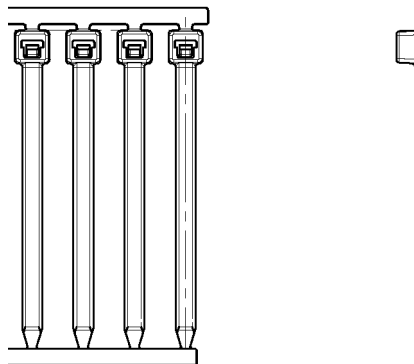

PART NO.	TYPE	Description	Cable Tie Series	Pkg. Qty.
AT2060	AT2060	AT2060 Tool. Includes AT2060 tool, power supply, power cord, tool cord, and maintenance and operation manual.	T30RA30, T30RA3000	1
AT2BMNT	AT2BMNT	AT2060 Bench Mount Kit	-	1
AT2OVHD	AT2OVHD	AT2060 Overhead Suspension Kit	-	1

Dimensions are approximate and subject to technical changes. Use Part No. for ordering and Type for specification purposes. For cable ties, please see page 496.

Automatic Cable Tie Systems

Auto Tool System 3080

HellermannTyton's ATS3080 automatically installs cable ties for bundles up to 3.14" in diameter with one trigger depression. This innovative system utilizes strap and closures (ordered separately) to achieve a waste free system. The ATS3080 uses only the required strap length for the diameter. The strap is outside serrated so that it will not damage sensitive wires and cable bundles. This well-balanced tool has ergonomic benefits that include low weight and a comfortable hand grip which reduce operator strain and injury while installing cable ties. The ATS3080 possesses an LED panel which makes it easier to maintain and operate the tool. The ATS3080 has three jaw diameters available; 1.18" (30mm), 1.96" (50mm), 3.14" (80mm). After the jaws are easily interchanged, further tool adjustment between the three jaw diameters is unnecessary.



Features and Benefits

- **Fast:** Cable ties are installed quickly with one easy trigger depression, increasing productivity while decreasing labor costs.
- **Reliable:** HellermannTyton's automatic cable tie systems have been tested to perform extremely consistently, without interruption to workflow.
- **Ergonomic:** The ergonomic design of the automatic cable tie tool systems feature a comfortable grip, low weight, and easy trigger depression to reduce installer effort and strain while installing cable ties.
- **Providing Valuable Operator Feedback:** Equipped with a self diagnostic LCD information screen, the automatic cable tie system easily guides the user through the cycles of cable tie installations.
- **Flexible Manufacturing Versatility:** HellermannTyton's cable tie tool systems support principles of flexible manufacturing requirements and environments.
- **Uniform Fastening Quality:** HellermannTyton's automatic cable tie systems feature adjustable tension control to deliver consistent levels of cable tie fastening.
- **Range:** The ATS300 installs 50lb ties on bundles up to 3.14".

PART NO.	TYPE	Description	Cable Tie Series	Pkg. Qty.
ATS10200000	Autotool System 3080	ATS3080 Tool. Includes power cord, tool cord, and maintenance and operation manual.	ATS3080 Strap, ATS3080 Closure	1
ATS10200040	Bench mount kit movable 3080	Bench Mount Kit for ATS3080. Integrated pneumatic system that coordinates tool and reels. Foot pedal application, other actuation options available.	-	1
ATS10200050	Overhead suspension 3080	Overhead Suspender ATS3080	-	1

Dimensions are approximate and subject to technical changes. Use Part No. for ordering and Type for specification purposes. For cable ties, please see page 497.

Automatic Cable Tie Systems

Auto Tool System QS101

HellermannTyton's Quick Tool is an automatic bench mount system suited for high volume cable tie applications. This air powered tool accommodates a reel of 5000 ties and, like HellermannTyton's other automated systems, can be integrated into further automation as well as fully incorporated into conveyor or assembly line applications. Custom colors for Quick Tool ties are also available.

Features and Benefits

- The system is a one piece, bench top unit which increases efficiency through quick and reliable fastening.
- It can be installed where a 110V AC electrical outlet and pneumatic air source are available.
- Provides consistent fastening tension.
- Controls fastening tension.

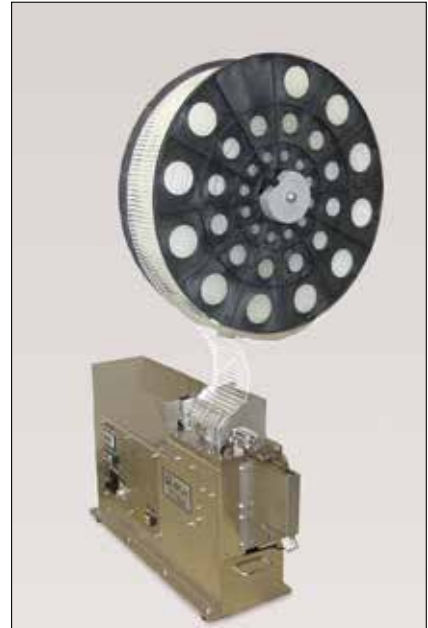

PART NO.	TYPE	Description	Cable Tie Series	Pkg. Qty.
QS101	QS101	QS101 Tool. Includes power cord, maintenance and operation manual, and foot pedal.	AZ100, QTTIE	1

*Dimensions are approximate and subject to technical changes. Use Part No. for ordering and Type for specification purposes.
For cable ties, please see page 498.*

Automatic Cable Tie Systems

AT2000 CPK Tool

The AT2000 CPK automatic cable tying system adapts to any industrial workflow. It excels in high-volume automatic bundling applications – especially where precision and repeatability are critical. The tool is electronically operated. Cycle rate is adjustable between 0.8 and 1.4 seconds, depending on what's best for the application. With a pull of the trigger, the tool applies an 18 lb. cable tie around a wire or tube bundle and is instantly ready to apply the next. Cable ties are available on 50-piece bandoliers and 5,000-piece reels. The AT2000 CPK uses two discreet drive motors. One motor delivers the tie, the other controls tension. Tension consistency is monitored in the software – especially useful when verification is required. Configurable blade enables the AT2000 CPK to cut cable ties flush or with a tail, depending on application requirements. An onboard TFT display shows production data, fault diagnostics and device control in 19 languages. Accessories are available to enhance the tool's efficiency in various workflows from hand operated to fully automated.



Features and Benefits

- Independent tensioning drive provides unequalled tensioning control and repeatability.
- Software makes it easy to manage bundling tension and speed, track performance, troubleshoot issues and log data.
- Versatile enough to be used by hand, on a benchtop, suspended overhead or in fully automated environments - to perform wherever you need it.
- Powerpack collects production data on USB memory stick to analyze on a PC later.

PART NO.	TYPE	Description	Cable Tie Series	Pkg. Qty.
106-00000	Autotool 2000 CPK	AT2000 CPK Tool	T18RA50, T18RA5000	1
106-00100	Power pack CPK	AT2000 CPK Power Pack	T18RA50, T18RA5000	1
106-00110	Power pack CPK with control box	AT2000 CPK Power Pack with Control Box	T18RA50, T18RA5000	1

Dimensions are approximate and subject to technical changes. Use Part No. for ordering and Type for specification purposes. For cable ties, please see page 499.

Automatic Cable Tie Systems

AT2000 CPK Accessories

AT2000 CPK accessories enable adapting the tool to the process. The Bench Mount Kit allows bringing the work to the tool, maximizing productivity and precision. The Overhead Suspension CPK features a new counterbalanced hanger that makes it very comfortable to operate in both stationary and mobile applications, even during extended use.

Features and Benefits

- Bench Mount Kit CPK facilitates converting the AT2000 CPK to a stationary position and increase bundling precision
- Power Pack CPK with Control Box provides integration with automated processes, speeding production and reducing personnel requirements
- HH20 screw mount wire retainer is used as a spacer for optimal bundling support
- New counterbalanced overhead hanger system improves ergonomics, reducing fatigue-related injuries



PART NO.	TYPE	Description	Pkg. Qty.
106-00050	Overhead suspension CPK	AT2000 CPK Overhead Suspension	-
106-00040	Bench mount kit CPK	AT2000 CPK Bench Mount Kit	1
106-00071	SP CPK hanger cpl.	AT2000 CPK Hanger	1
HH-20	HH20	Screw Mount Wire Retainer	25

Dimensions are approximate and subject to technical changes. Use Part No. for ordering and Type for specification purposes.

Cable Ties for Automatic Systems

AT2000 Series Cable Ties

HellermannTyton's AT2000 is designed to use 18 lb. cable ties and will fasten bundles up to 3/4" diameter. Engineered specifically for automatic cable tie assembly, these ties are offered in varying material compositions and colors, so manufacturers can select the ties that meet the application requirements and industry best practices.

Features and Benefits

- Cable ties can be easily recycled to meet environmental management objectives.
- HellermannTyton 18 lb. cable ties are available in natural, black, and other colors (upon request) to support color coded wire management schemes.
- Bandoliers of 50 or reels of 5000 cable ties are available, enabling maximum user efficiency in hand-held, bench-mount, or automated processes.



PART NO.	TYPE	Min. Tensile Strength lbs. (N)	Length (L) in. (mm)	Max. Bundle Diameter in. (mm)	Width (W) in. (mm)	Material	Color	Pkg. Qty.
T18RA50VO*	T18RA50	18.0 (80.0)	4.0 (4.8)	0.75 (20.0)	0.1 (2.5)	PA66V0	White	500
120-05015	T18RA5000	18.0 (80.0)	4.0 (4.8)	0.79 (20.0)	0.1 (2.5)	PA46	Natural	5000
T18RA50*	T18RA50	18.0 (80.0)	4.0 (4.8)	0.79 (20.0)	0.1 (2.5)	PA66	Natural	500
T18RA5000*	T18RA5000	18.0 (80.0)	4.0 (4.8)	0.79 (20.0)	0.1 (2.5)	PA66	Natural	5000
T18RA50HSW*	T18RA50	18.0 (80.0)	4.0 (4.8)	0.79 (20.0)	0.1 (2.5)	PA66HS	Black	500
T18RA5000HSW*	T18RA5000	18.0 (80.0)	4.0 (4.8)	0.79 (20.0)	0.1 (2.5)	PA66HS	Black	5000

Dimensions are approximate and subject to technical changes. Use Part No. for ordering and Type for specification purposes.

*This product meets UL standards. Please see appendix for specific file numbers.



Please note! Not all products listed on this page may have this approval. Please check our website for latest approvals.

Cable Ties for Automatic Systems

AT2060 Series Cable Ties

HellermannTyton's AT2060 automatically installs cable ties for bundles up to 1-1/4". The many ergonomic benefits include easy trigger depression and low weight that reduces operator effort and strain. Operation and maintenance of the tool are enhanced by the self-diagnostic LED panel located on the AT2060.

Features and Benefits

- The AT2060 cable tie system is designed for automatic installation on bundles up to 1.25" and a minimum tensile strength of 30 lbs.
- Available in reels of 3,000 each or bandoliers of 30 each.



PART NO.	TYPE	Min. Tensile Strength lbs. (N)	Length (L) in. (mm)	Max. Bundle Diameter in. (mm)	Width (W) in. (mm)	Material	Color	Pkg. Qty.
T30RA30*	T30RA	30.0 (133.4)	6.0 (152.4)	1.25 (31.8)	0.14 (3.6)	PA66	Natural	600
T30RA30OHS*		30.0 (133.4)	6.0 (152.4)	1.25 (31.8)	0.14 (3.6)	PA66HS	Black	600
T30RA3000*		30.0 (135.0)	6.0 (152.4)	1.25 (31.8)	0.14 (3.6)	PA66	Natural	3000
T30RA3000OHS*		30.0 (135.0)	6.0 (152.4)	1.25 (31.8)	0.14 (3.6)	PA66HS	Black	3000

Dimensions are approximate and subject to technical changes. Use Part No. for ordering and Type for specification purposes.

**This product meets UL standards. Please see appendix for specific file numbers.*



Please note! Not all products listed on this page may have this approval. Please check our website for latest approvals.

Cable Ties for Automatic Systems

ATS3080 Series Cable Ties

HellermannTyton's ATS3080 automatically installs cable ties for bundles up to 3.14" in diameter with one trigger depression. This innovative system utilizes strap and closures (ordered separately) to achieve a waste free system. The ATS3080 uses only the required strap length required for the diameter. The strap is outside serrated so that it will not damage sensitive wire and cable bundles. This well balanced tool has ergonomic benefits that include low weight and a comfortable hand grip that reduces operator strain and injury while installing cable ties. The ATS3080 possesses a LED panel that provides critical operational feedback that makes it easier to maintain and operate the tool. The ATS3080 has three jaw diameter available: 1.18" (30 mm,) 1.96" (50 mm,) and 3.14" (80 mm.) The jaws are easily interchanged and further tool adjustment between the three jaw diameters is unnecessary.



Features and Benefits

- The ATS3080 cable tie is designed for optimized material utilization by using an innovative two-piece system consisting of individual strap and closures.
- Waste-free cable tie system eliminates down time due to cleaning and opening waster containers.
- Bundle diameter is mechanically detected and allows a flush cut off of the strap.
- Available in reels of 1,640 feet of strap and 5,000 closures.

PART NO.	TYPE	Min. Tensile Strength lbs. (N)	Description	Max. Bundle Diameter in. (mm)	Width (W) in. (mm)	Material	Color
ATS10266210	Closures Black ATS3080	50.0 (225)	ATS3080 Closures, 0.4" Long, 5000/reel	3.14 (80.0)	0.31 (8.0)	PA66HSUV	Black
ATS10266110	Strap Black ATS3080	50.0 (225)	ATS3080 Strap, 1640 ft Long, 1 reel	3.14 (80.0)	0.18 (4.5)	PA66HIRHSUV	Black

Dimensions are approximate and subject to technical changes. Use Part No. for ordering and Type for specification purposes.

Cable Ties for Automatic Systems

QS101 Series Cable Ties

HellermannTyton's Quick Tool is an automatic bench mount system suited for high volume cable tie applications. This air powered tool accommodates a reel of 5000 ties and, like HellermannTyton's other automated systems, can be integrated into further automation as well as fully incorporated into conveyor or assembly line applications. Custom colors for Quick Tool ties are also available.

Features and Benefits

- Ties are available in two styles: standard and heat stabilized.
- Custom colors for Quick Tool ties are also available. Contact HellermannTyton for more information.



PART NO.	TYPE	Min. Tensile Strength lbs. (N)	Length (L) in. (mm)	Max. Bundle Diameter in. (mm)	Width (W) in. (mm)	Material	Color	Pkg. Qty.
QTTIE9*	AZ100	18.0 (80.0)	3.94 (100.0)	0.63 (16.0)	0.1 (2.5)	PA66	Natural	5000
QTTIE0HS*		18.0 (80.0)	3.94 (100.0)	0.63 (16.0)	0.1 (2.5)	PA66HSW	Black	5000

Dimensions are approximate and subject to technical changes. Use Part No. for ordering and Type for specification purposes.

**This product meets UL standards. Please see appendix for specific file numbers.*



Please note! Not all products listed on this page may have this approval. Please check our website for latest approvals.

Pneumatic Tools

MK7P Tool

The Mark 7 Pneumatic (MK7P) is built to perform in demanding production and manufacturing environments. Heavy duty precision parts ensure repeatability in the tensioning process. The MK7P fits comfortably in the operator's hand, reducing hand, arm and wrist fatigue. Due to its ergonomic features, HellermannTyton's MK7P makes it easier for the installer to consistently apply cable ties, while maintaining correct tension and flush cut-off. Safety is enhanced, as the MK7P can eliminate sharp edges of a cut-off cable tie.

Features and Benefits

- Enhanced technology for better application of cable ties.
- Improved compressed air supply for faster tensioning piston movement.
- Shorter processing time and greater volume of connecting tie application.
- Genuine potential for rationalization.
- Ergonomic design, molded handle to prevent slippage, reduce operator fatigue.
- Lightweight but very tough housing made of glass fiber-reinforced plastic.
- Meets high industry standards.
- Tensioning and cutting off cable ties flush with head by pressing one button.
- Smooth cut edge to prevent injuries.
- Automatic ejection of cut-off cable tie end.
- Three-level preset control to set tool tension.
- Optional safety cap to prevent tension setting from being changed by accident (important when bundling sensitive materials and maintaining process reliability.)
- Non-slip, comfortable grip, soft touch trigger, and one-touch tensioning/cut off.
- Very lightweight and easy to use on all cable ties 2.5–4.8 mm wide.
- All separately sold accessories are compatible with the MK7P series tool.



PART NO.	TYPE	Description	Cable Tie Series	Pkg. Qty.
MK7P	MK7P	Mark 7 Pneumatic Tool	T18 thru T50 Series CTT20 thru CTT60	1

Dimensions are approximate and subject to technical changes. Use Part No. for ordering and Type for specification purposes.

Pneumatic Tools

MK9P Tools

HellermannTyton MK9P tensioning tools achieve unique levels of repeatability and accuracy while maintaining a high application speed. One further advantage is its low-maintenance handling.

MK9P pneumatic bundling tools set a new benchmark for the rational application of ties in the industrial production process. Improved compressed air supply moves the tensioning piston faster than in comparable tools. Processing time is shortened and the volume of connecting ties applied is increased. Great attention was paid to ergonomic design in the development of this tool. The cut-off end of the tie is ejected automatically. Production breaks normally required to the cut-off ties are thus eliminated.

The MK9P series is ideally designed to apply heavy-duty ties (T50-T250) as well as clamp and button head ties. The MK9P series incorporates the next level of ergonomic improvement with its low weight, comfortable grip and easy trigger depression.



Features and Benefits

- Unique levels of repeatability and accuracy.
- High application speed and low maintenance.
- Improved compressed air supply for faster tensioning piston movement.
- Shorter processing time and greater volume of connecting tie application.
- Ergonomic design.
- Automatic ejection of cut-off cable tie end.
- Low weight, comfortable grip and easy trigger depression.

PART NO.	TYPE	Description	Cable Tie Series	Pkg. Qty.
MK9P	MK9P	Handle Air Supply Connection	T50 thru T250 Series CTT20 thru CTT175 Series EI-TY Series Button Head Series	1
MK9PUA		Top Air Supply Connection	T50 thru T250 Series CTT20 thru CTT175 Series EI-TY Series Button Head Series	1

Dimensions are approximate and subject to technical changes. Use Part No. for ordering and Type for specification purposes.

Pneumatic Tools

MK9PSST Tool

The MK9 Pneumatic Stainless Steel Tool (MK9PSST) is constructed with heavy-duty parts to ensure optimum performance in demanding environments. It is ideally designed to apply stainless steel MBT-Series (Metall Ball Tie Series) up to 16.0 mm width.

The MK9PSST incorporates the next level of ergonomic improvement with its low weight, comfortable grip and easy trigger depression. Very durable, the pneumatic MK9PSST features adjustable, easy to read tension settings. The tool operates on air pressure between 3 and 6 bar.

Features and Benefits

- Unique levels of repeatability and accuracy.
- High application speed and low maintenance.
- Improved compressed air supply for faster tensioning piston movement.
- Shorter processing time and greater volume of connecting tie application.
- Ergonomic design.
- Automatic ejection of cut-off cable tie end.
- Ideally designed to apply stainless steel MBT-Series up to 16.0 mm width.



PART NO.	TYPE	Description	Cable Tie Series	Pkg. Qty.
110-95300	MK9PSST	MK9PSST Pneumatic Tool	MBT-Series up to 16 mm width	1

Dimensions are approximate and subject to technical changes. Use Part No. for ordering and Type for specification purposes.

Application Tools

Cable Tie Application Tools

Pneumatic Tools

Accessories for MK7 and MK9 Tools

HellermannTyton offers a portable kit that incorporates carbon dioxide (CO₂) as the primary air source. This unique feature will allow for greater flexibility, mobility and the elimination of an air line to the tool.

Features and Benefits

- HellermannTyton's Mark 7 and Mark 9 power assisted (MK7P & MK9P) tools utilize pneumatic power to tension and cut-off HellermannTyton cable ties.
- The MK7P and MK9P tools feature an ergonomic design while offering time/labor savings and ease of use benefits derived from pneumatic power.
- These tools feature a non-slip, comfortable grip, soft touch trigger, and one touch tensioning/cut-off capability.
- HellermannTyton's pneumatic cable tie tools are lightweight, high performance, and suited for extended use.



PART NO.	TYPE	Description	Pkg. Qty.
MK7P-446	MK7P-446	MK7P 10" Whip Hose	1
MKPCOHOSE	MKPCOHOSE	MK7P and MK9P Regulator and Hose for HPA tanks.	1
110-11329	MK7P-NP-STD	MK7P Nosepiece	1
110-11330	MK7P-NP-2MM	MK7P 1 mm extended tail nosepiece	1
110-11331	MK7P-NP-3MM	MK7P 2 mm extended tail nosepiece	1
110-11332	MK7P-NP-4MM	MK7P 3 mm extended tail nosepiece	1
MK7P-342	SP MK7P replacement blade	MK7P Replacement Blade	1
MK9P-109	SP MK9P replacement blade	MK9P Replacement Blade	1

Dimensions are approximate and subject to technical changes. Use Part No. for ordering and Type for specification purposes.

Manual Tools

EVO® 7 Tool

HellermannTyton's EVO 7 mechanical hand tool is ergonomically designed to reduce the risks of repetitive stress injuries to operators while simultaneously increasing productivity. The EVO 7 Tension/Lock/Cut Technology delivers performance, safety and comfort for operators. Available in a standard grip span (EVO 7) or short grip span (EVO 7SP) for smaller hands. Additional accessories are available.

Features and Benefits

- Advanced TLC technology provides operational reliability and durability resulting in fewer repairs and an extended lifespan.
- Lightweight tool with the most technologically advanced ergonomic design for reducing work-related risks such as fatigue and injury that effect productivity.
- Tension dial offers 33 precise, easy-to-read settings (with ¼" increments) that reduce subjectivity or the need for fine tuning.
- Tension lock-in mechanism prevents operator from changing tension setting during critical applications.



PART NO.	TYPE	Description	Cable Tie Series	Pkg. Qty.
110-70084	EVO7SP	EVO 7SP Mechanical Hand Tool, short hand span 80	T18, T30, T40, T50, T80, IT18, IT50	1
110-70083	EVO7	EVO 7 Mechanical Hand Tool, standard hand span 90	T18, T30, T40, T50, T80, IT18, IT50	1
110-70131	EVO7 nosepiece 1mm	EVO 7 and EVO 7SP Nosepiece, 1 - 3	-	1
110-70132	EVO7 nosepiece 2mm	EVO 7 and EVO 7SP Nosepiece, 2	-	1
110-70133	EVO7 nosepiece 3mm	EVO 7 and EVO 7SP Nosepiece, 3	-	1
110-70106	BLADEKIT	EVO 7 and EVO 7SP blade replacement kit, (1) blade, (1) nosepiece screw	-	1
110-70089	CALTOOL	EVO 7 Calibration tool	-	1
110-70091	T8SD	EVO 7 T8 star driver	-	1

Dimensions are approximate and subject to technical changes. Use Part No. for ordering and Type for specification purposes.



Please note! Not all products listed on this page may have this approval. Please check our website for latest approvals.

Manual Tools

EVO® 9 Tool

The EVO 9 has redefined the cable tie application tool, by combining durability, precision and control with unparalleled comfort. Manufactured with high-performance materials and components, the EVO 9 has been proven to outperform and outlast other professional manual tools on the market. Its innovative, ergonomic design minimizes the stress on hands and wrists and “kickback” that occur with traditional tools, reducing the risk of repetitive-motion injuries. The HT model offers high tension while the SP model features a smaller grip.

Features and Benefits

- Tensions and provides clean, flush cuts for 50lb. to 250lb. cable ties, including wide strap ties.
- Impact-resistant housing and durable components for extended service life.
- Easy-to-adjust tension knob offers 33 different settings for precise, repeatable applications.
- Advanced ergonomic design minimizes necessary hand force and “kickback” to reduce repetitive-motion injuries.
- All separately sold accessories are compatible with the EVO 9 series tools.



PART NO.	TYPE	Description	Cable Tie Series	Pkg. Qty.
110-80000	EVO9	EVO 9 Mechanical Hand Tool, Standard Hand Span	T50, T80, T120, T150, T250, T255, WS	1
110-80004	EVO9HT	EVO 9HT High Tension Mechanical Hand Tool	T120, T150, T250, T255, WS	1
110-80001	EVO9SP	EVO 9 Mechanical Hand Tool, Short Hand Span	T50, T80, T120, T150, T250, T255, WS, LK2, LK3, LK5, GL, ECO Series Ties	1
110-80037	Replacement Blade	EVO 9 Replacement Blade	-	1
110-80018	EVO9	EVO 9 Replacement Nosepiece, Flush Cut	-	1
110-80064		EVO 9 2mm Nosepiece, Extended Tail	-	1
110-80065		EVO 9 3mm Nosepiece, Extended Tail	-	1
110-80066		EVO 9 4mm Nosepiece, Extended Tail	-	1
110-80067		EVO 9 5mm Nosepiece, Extended Tail	-	1

Dimensions are approximate and subject to technical changes. Use Part No. for ordering and Type for specification purposes.

Manual Tools

MK7HT Tool

The MK7HT is particularly suitable for applications requiring cable ties to be very tightly applied, due to its increased pulling force.

Features and Benefits

- Light glass fiber reinforced housing.
- Ergonomic design.
- Consistent tensioning and flush cutting.
- Infinitely adjustable tension force combined with three-step quick adjustment.



PART NO.	TYPE	Description	Cable Tie Series	Pkg. Qty.
MK7HT	MK7HT	Mark 7 High Tension Tool	T30 - T50 Series, CTT20 - CTT60 Series	1

Dimensions are approximate and subject to technical changes. Use Part No. for ordering and Type for specification purposes.

MK9RC Tool

Ranging from the high performance EVO 7 and EVO 9 series tools to pocket-sized twist tools, HellermannTyton offers a range of mechanical tools which can be used with any HellermannTyton cable tie. When using these tools, the cable tie is hand applied and then manually tensioned and cut-off, without the use of an extraneous power source.

Features and Benefits

- Ergonomic tool for use anywhere.
- Extremely low maintenance.
- Adjustable preset tension device.
- Tensions and automatically cuts HellermannTyton cable ties up to 4.8 mm wide.
- Very light weight and ergonomic for easier handling.
- Housing made of resilient and lightweight glass fibre-reinforced polyester.
- MIL approved.



PART NO.	TYPE	Description	Cable Tie Series	Pkg. Qty.
110-09980	MK9RC	Adjustable tensioning and cut-off tool	T18-T250 Series CTT20-CTT175 Series EL-TY Series Wide Strap Series	1

Dimensions are approximate and subject to technical changes. Use Part No. for ordering and Type for specification purposes.

Manual Tools

MK9SST Tool

With its lightweight, ergonomic design, the MK9SST is an ideal tool for applying the MBT-series stainless steel cable ties. Although it is used for applying stainless steel ties, the MK9SST enables work to be carried out without operator fatigue and is easy on joints. For easier handling the tensioning is fully adjustable by means of a quick two-level control with an additional fine setting. This avoids damage and constrictions to the bundled materials. The cable ties are cut off automatically flush with the head when the preset tensioning level has been reached.

Features and Benefits

- Glass fiber reinforced housing.
- Ergonomic design.
- Consistent tensioning and automatic cutting of metal ties MBT-Series.
- Infinitely adjustable tension force combined with two-step quick adjustment.



PART NO.	TYPE	Description	Cable Tie Series	Pkg. Qty.
MK9SST	MK9SST	Mark 9 Stainless Steel Tie Tensioning and Cut-Off Tool	All MBT Series for both 304 and 316 materials	1
110-95273	SP MK9SST replacement blade	MK9SST G2 Blade	-	1
110-95291	Front Nosepiece	MK9SST Front Nosepiece	-	1

Dimensions are approximate and subject to technical changes. Use Part No. for ordering and Type for specification purposes.

Kabelrap Tool

The KR6/8 tool crimps the glass-fibre-reinforced locking pin of the KR seal and leads to plastic deformation of the tie ends. This produces a very proof permanent connection.

Features and Benefits

- KR6/8 tool tensions, cuts, and presses the locking pin through the head to lock it in place.
- Designed specifically for the Kabelrap ties to assure a permanent installation.



PART NO.	TYPE	Description	Cable Tie Series	Pkg. Qty.
121-00680	KR6/8	KR6/8 Tool	KR6 and KR8 series	1

Dimensions are approximate and subject to technical changes. Use Part No. for ordering and Type for specification purposes.

Manual Tools

Tyton Twyster-Twist Tool

The TytonTwyster (TWT1) is a lightweight and economical twist tool that offers speed and efficiency. It can be used on HellermannTyton T18 thru T50 series.

Features and Benefits

- Inexpensive alternative to heavy duty tool allowing user to save money.
- Use with HellermannTyton ties up to 0.19" wide for a variety of available options.
- Lightweight design reduces operator fatigue.
- Simply twist to cut for reduced effort.



PART NO.	TYPE	Description	Pkg. Qty.
TWT1	TWT	Twist Tool for standard cable ties.	1

Dimensions are approximate and subject to technical changes. Use Part No. for ordering and Type for specification purposes.

Mechanical Tool Accessories

Features and Benefits

- A portable pull force gauge that measures tensile force and displays digital reading on the LCD screen.
- NiCD battery and built-in memory backup for on-site calibration of tools.
- Can be used with all HellermannTyton mechanical hand tools.



PART NO.	TYPE	Description	Pkg. Qty.
110-99000	UC200	UC200 Tension Gauge	1

Dimensions are approximate and subject to technical changes. Use Part No. for ordering and Type for specification purposes.



Inspired by productivity

Meet a better solution to a 90-year-old technology. HelaCon Plus Mini beats the old, twist-on wire connector. It instantly connects two or more wires from 12-22 AWG with a simple push and holds them more reliably thanks to a double-spring retention system. Its ultra-small footprint fits better in tight electrical enclosures, too.



Wire Connectors.....	508
General Purpose Electrical Tape.....	510
Special Purpose Electrical Tape.....	511

Connectors - For Solid and Stranded Wires

HelaCon Plus Mini

HelaCon Plus Mini Wire Connectors replace traditional twist-on wire connectors. They provide faster, easier and more reliable connection and distribution of cable and conductors in electrical installation applications. Mini connectors have a compact footprint and can be applied tool-free using convenient, push-in simplicity. Internal spring technology is approved for solid and stranded wires.

Features and Benefits

- Spring technology for safe, secure and reliable connections.
- Smaller footprint fits in tight spaces.
- Low insertion force makes installation of solid or stranded copper wire fast and easy.
- Color coded for easy identification of size.
- Each port accepts multiple wire diameters for flexible applications.
- Accepts 12–22 AWG solid wire and 14–22 AWG stranded wire.



Material Housing	Polycarbonate (PC)
Material Plated Brass	Brass Tinned
Material Spring Plate	Stainless Steel (SS)
Max Current	24 A
Voltage Rating (cULus)	600 V
Voltage Rating (VDE)	450 V
Wire Range (cULus)	12 AWG to 22 AWG Solid Copper Wires / 14 AWG to 22 AWG Tin-Dipped Copper Stranded Wire
Wire Range (VDE) in mm²	0.5 to 2.5 mm ² solid wires / 1.0 to 2.5 mm ² stranded wires
Stripping Length (Imperial)	0.43 "
Stripping Length (Metric)	11.0 mm
Flammability	UL 94 V0
Operating Temperature	-22°F to +185°F (-30°C to +85°C)

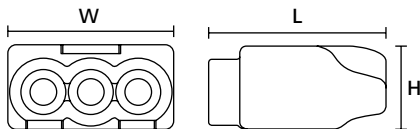

PART NO.	TYPE	Color	Number of Conductors	Width (W) in. (mm)	Height (H) in. (mm)	Depth (D) in. (mm)	Pkg. Qty.
148-90036*	HCPM-2	Clear, Yellow	2	0.4 (10.8)	0.3 (7.7)	0.7 (16.5)	150
148-90048*		Clear, Yellow	2	0.4 (10.8)	0.3 (7.7)	0.7 (16.5)	500
148-90037*	HCPM-3	Clear, Orange	3	0.6 (15.1)	0.3 (7.7)	0.7 (16.5)	100
148-90049*		Clear, Orange	3	0.6 (15.1)	0.3 (7.7)	0.7 (16.5)	400

Dimensions are approximate and subject to technical changes. Use Part No. for ordering and Type for specification purposes.

*This product meets UL standards. Please see appendix for specific file numbers.



Please note! Not all products listed on this page may have this approval. Please check our website for latest approvals.

Connectors - For Solid and Stranded Wires

HelacOn Plus Mini

PART NO.	TYPE	Color	Number of Conductors	Width (W) in. (mm)	Height (H) in. (mm)	Depth (D) in. (mm)	Pkg. Qty.
148-90038*	HCPM-4	Clear	4	0.8 (19.4)	0.3 (7.7)	0.7 (16.5)	100
148-90050*		Clear	4	0.8 (19.4)	0.3 (7.7)	0.7 (16.5)	300
148-90039*	HCPM-5	Clear, Blue	5	0.9 (23.7)	0.3 (7.7)	0.7 (16.5)	75
148-90051*		Clear, Blue	5	0.9 (23.7)	0.3 (7.7)	0.7 (16.5)	300
148-90040*	HCPM-6	Clear, Violet	6	1.1 (28.0)	0.3 (7.7)	0.7 (16.5)	50
148-90052*		Clear, Violet	6	1.1 (28.0)	0.3 (7.7)	0.7 (16.5)	250
148-90041*	HCPM-8	Clear, Black	8	1.4 (36.6)	0.3 (7.7)	0.7 (16.5)	50
148-90053*		Clear, Black	8	1.4 (36.6)	0.3 (7.7)	0.7 (16.5)	200

Dimensions are approximate and subject to technical changes. Use Part No. for ordering and Type for specification purposes.

*This product meets UL standards. Please see appendix for specific file numbers.



Please note! Not all products listed on this page may have this approval. Please check our website for latest approvals.

Electrical Tape

PVC Tape

PVC electrical tape provides fast and easy color coding, cable splicing, terminating, and wire insulating. These conformable high quality tapes have exceptional surface and adhesive characteristics. Tape is applied by overlapping each layer 50% and using tension. After the tape is adhered, the memory of the tape returns, tightening the seal and making the taped area even more waterproof.

Features and Benefits

- PVC Tape is ideal for general purpose electrical applications.
- Economical way to splice, terminate and insulate wire and cables.
- Meets Mil-Std. MIL-1-7798-A.



MATERIAL	Flexible Polyvinyl Chloride (PVC)
Adhesion	16 oz./inch
Tensile Strength	15.4 lbs
Operating Temperature	+20°F to 176°F (-7°C to +80°C)

PART NO.	TYPE	Width (W) in. (mm)	Roll Length ft. (m)	Thickness (T)	Material	Color	Pkg. Qty.
ET330*	ET33	0.75 (19.05)	33.0 (10.0)	7.0 mil	PVC	Black	10
ET660*	ET66	0.75 (19.05)	66.0 (20.1)	7.0 mil	PVC	Black	10
ETST666*	ETST66	0.75 (19.05)	66.0 (20.1)	7.0 mil	PVC	Blue	10
ETST668*		0.75 (19.05)	66.0 (20.1)	7.0 mil	PVC	Gray	10
ETST665*		0.75 (19.05)	66.0 (20.1)	7.0 mil	PVC	Green	10
ETST663*		0.75 (19.05)	66.0 (20.1)	7.0 mil	PVC	Orange	10
ETST662*		0.75 (19.05)	66.0 (20.1)	7.0 mil	PVC	Red	10
ETST6610*		0.75 (19.05)	66.0 (20.1)	7.0 mil	PVC	White	10
ETST664*		0.75 (19.05)	66.0 (20.1)	7.0 mil	PVC	Yellow	10

Dimensions in mm, inches in brackets. Subject to technical changes.

*This product meets UL standards. Please see appendix for specific file numbers.



Please note! Not all products listed on this page may have this approval. Please check our website for latest approvals.

Special Purpose Electrical Tape

Weather Resistant PVC

Heavy duty vinyl tapes are ideal for outdoor applications. Tape provides fast, easy and economical cable splicing, terminating, wire insulating, and more. These conformable high quality tapes have exceptional surface and adhesive characteristics. Tape is applied by overlapping each layer 50% and using tension. After the tape is adhered, the memory of the tape returns, tightening the seal and making the taped area even more waterproof.

Features and Benefits

- Heavy duty PVC tape is ideal for cold weather installations and is "weather resistant" for outdoor applications.
- Meets Mil-Std. MIL-1-24391-A.



MATERIAL	Flexible Polyvinyl Chloride (PVC)
Adhesion	17 oz./inch
Tensile Strength	20.0 lbs
Operating Temperature	0 °F to +194 °F (-17.8 °C to +90 °C)

PART NO.	TYPE	Width (W) in. (mm)	Roll Length ft. (m)	Thickness (T)	Material	Color	Pkg. Qty.
ETCW660*	ETCW66	0.75 (19.05)	66.0 (20.1)	8.0 mil	PVC	Black	10

Dimensions in mm, inches in brackets. Subject to technical changes.

*This product meets UL standards. Please see appendix for specific file numbers.













Please note! Not all products listed on this page may have this approval. Please check our website for latest approvals.



Standards/Standards Organizations	514
Wire Fill Specifications.....	516
Wiring Duct Material Properties and Capacities	518
US Military Standards/Specifications	519
Product Standards and Specifications	525
Part Number Index.....	564
Type Index	587













Standards/Standards Organizations/Authorities

ABS	American Bureau of Shipping	USA	
ASN	AeroSpatiale Normalisation	France	
ASTM	ASTM International	USA	
BS	British Standard	Great Britain	
DAN	Deutsche Airbus Norm	Europe	
DEF STAN	Defence Standard	Great Britain	
FCC	Federal Communications Commission	USA	
LEA	Liste des Equivalences Approuvés	France	
MIL	Military Specification	USA	
MS	Military Standard	USA	
NASM	National Aerospace Standard, Metric	USA	
NF F	Norme Française Ferroviaire	France	
SAE	Society of Automotive Engineers	USA	
STD	Standard for Dassault	France	
UNI CEI	Ente Nazionale Italiano di Unificazione Comitato Elettrotecnico Italiano	Italy	
VG	Verteidigungsgerätenorm der Bundeswehr	Germany	

References

NSA	Norm Sud Aviation	France	
-----	-------------------	--------	---

Testing Institute/Certifying Company

BV	Bureau Veritas	France	
CSA	Canadian Standards Association	Canada	
DEMKO	Danske Elektriske Materialekontrol	Denmark	
DNV	Det Norske Veritas	Norway	
DNV GL	Det Norske Veritas + Germanischer Lloyd	Norway	
IMQ	Certificazione di prodotti	Italy	
FIMKO	Suomalainen testaus ja sertifiointiyriyitys	Finland	
KEMA KEUR	KEMA Quality B.V.	Netherlands	
LR	Lloyd's Register	Great Britain	
NEMKO	Norges Elektriske Materiellkontroll	Norway	
SEMKO	Sveriges Elektriska Materielkontroll	Sweden	
UL	Underwriters Laboratories	USA	
UL	Underwriters Laboratories	USA	
VDE	Verband der Elektrotechnik, Elektronik, Informationstechnik	Germany	

Certification mark

CE	Conformité Européenne	Europe	
CEBEC	Comitée for electrotechnical Belgium European Community	Belgium	
ENEC	European Norms Electrical Certification	Europe	
GS	Geprüfte Sicherheit	Europe	
JAR/FAR	Joint Aviation Regulations / Federal Aviation Regulations	Europe, USA	
JN	Particular Specification developed for Eurofighter Program		
UL Recognized	Underwriters Laboratories	USA	
cULus	Underwriters Laboratories	USA	
VDE	Verband der Elektrotechnik, Elektronik, Informationstechnik	Germany	

Wire Fill Chart – TSRP 600v Rated Raceway System

WIRE TYPE	WIRE SIZE	O.D. of Wire	Power Rated - TSRP					
			TSRP 1 A = 0.220 in ²		TSRP 2 A = 0.651 in ²		TSRP3 A = 1.361 in ²	
			Spec	Max	Spec	Max	Spec	Max
Twisted Pair 24 AWG Unshielded	2 Pr.	0.140	5	8	16	25	35	53
	3 Pr.	0.150	4	7	14	22	30	46
	4 Pr. Cat 5e	0.217	2	3	7	10	14	22
	4 Pr. Cat 6	0.240	1	2	5	8	12	18
	25 Pr.	0.410	0	0	1	2	4	6
	4 Pr. Cat 6a	0.354	0	1	2	3	5	8
Coax	RG58/U	0.193	2	4	8	13	18	27
	RG59/U or RG62/U	0.242	1	2	4	6	9	14
	RG6/U	0.270	1	2	4	6	9	14
Fiber Optic FA Jacket OFNP	2 Strand	0.175	3	5	10	16	22	33
	4 Strand	0.185	3	4	9	14	20	30
	6 Strand	0.210	2	3	7	11	15	23
Electrical Wire	14 AWG THHN	0.105	-	8	-	11	-	11
	12 AWG THHN	0.122	-	6	-	9	-	9
	10 AWG THHN	0.153	-	4	-	6	-	5

Wire Fill Chart – TSR Low Voltage Raceway System

WIRE TYPE	WIRE SIZE	O.D. of Wire	Low Voltage - TSR					
			TSR1 A = 0.220 in ²		TSR2 A = 0.675 in ²		TSR3 A = 1.384 in ²	
			Spec	Max	Spec	Max	Spec	Max
Twisted Pair 24 AWG Unshielded	2 Pr.	0.140	5	8	17	26	35	53
	3 Pr.	0.150	4	7	15	22	31	46
	4 Pr. Cat 5e	0.217	2	3	7	10	14	22
	4 Pr. Cat 6	0.240	1	2	5	8	12	18
	25 Pr.	0.410	0	0	2	3	4	6
	4 Pr. Cat 6a	0.354	0	1	2	4	5	8
Coax	RG58/U	0.193	3	4	9	13	18	28
	RG59/U or RG62/U	0.242	1	2	5	8	12	18
	RG6/U	0.270	1	2	4	7	9	14
Fiber Optic FA Jacket OFNP	2 Strand	0.175	3	5	11	16	23	34
	4 Strand	0.185	3	4	10	15	20	30
	6 Strand	0.210	2	3	7	11	15	23

Wire Fill Chart – Multi-Channel Raceway System

LOW VOLTAGE	RACEWAY		Channel 1		Channel 2		Channel 3		Channel 4		Channel 5		Channel 6	
	AREA OF RACEWAY		6.40in ²		1.220in ²		4.260in ²		5.880in ²		0.800in ²		2.450in ²	
WIRE TYPE	WIRE SIZE	O.D. of Wire	Spec	Max	Spec	Max	Spec	Max	Spec	Max	Spec	Max	Spec	Max
Twisted Pair 24 AWG Unshielded	2 Pr.	0.140	166	249	31	47	110	166	152	229	20	31	63	95
	3 Pr.	0.150	144	217	27	41	96	144	133	199	18	27	55	83
	4 Pr. Cat 5e	0.217	69	103	13	19	46	69	63	95	8	12	26	39
	4 Pr. Cat 6	0.240	56	84	10	16	37	56	51	77	7	10	21	32
	4 Pr. Cat 6a	0.354	26	39	4	7	17	25	23	35	3	4	9	14
	25 Pr.	0.410	19	29	3	5	12	19	17	26	2	3	7	11
Coax	RG58/U	0.193	87	131	16	25	58	87	80	120	10	16	33	50
	RG59/U or RG62/U	0.242	55	83	10	15	37	55	51	76	6	10	21	31
	RG6/U	0.270	44	67	8	12	29	44	41	61	5	8	17	25
Fiber Optic FA Jacket OFNP	2 Strand	0.175	106	159	20	30	70	106	97	146	13	19	40	61
	4 Strand	0.185	95	142	18	27	63	95	87	131	11	17	36	54
	6 Strand	0.210	73	110	14	21	49	73	67	101	9	13	28	42
Fiber Optic 62.5/125/900 PVC Jacket OFNR	2 Strand	0.175	106	159	20	30	70	106	97	146	13	19	40	61
	4 Strand	0.185	95	142	18	27	63	95	87	131	11	17	36	54
	6 Strand	0.210	73	110	14	21	49	73	67	101	9	13	28	42
	8 Strand	0.230	61	92	11	17	41	61	56	84	7	11	23	35
	10 Strand	0.250	52	78	9	14	34	52	47	71	6	9	19	29
Electrical Wire	14 AWG THHN	0.105		17		10		-		-		9		-
	12 AWG THHN	0.122		14		7		-		-		7		-
	10 AWG THHN	0.153		10		5		-		-		5		-

Formula used to calculate communications wire fill capacity - Numbers of wires = duct / $\{1/4 \times 3.14 \times (\text{wire o.d.})^2\} \times 0.4$ or 0.6. Per ANSI/TIA/EIA-569-A-:

SPEC = 40% fill which is recommended for planning perimeter pathways

MAX (for data) = 60% fill which is allowed to accommodate unplanned additions after initial installation

MAX (for power) = Maximum number determined by UL temperature testing

Note: It is recommended to bundle electrical cables in raceway

The adhesive strip may serve only as a positioning aid during installation. The raceway shall be secured by mechanical fastening.

Appendix

Product Approvals and Specifications

Material Properties and Capacity Chart

Wiring Duct Material Properties

Physical Properties	Material	ASTM Method	Test Units	Test Results
Specific Gravity (Gray)	PVC	D-792		1.4
Durometer Hardness	PVC	D-2240	Shore Hardness	77D
Flexural Strength	PVC	D-790	psi	9,900
Modulus of Elasticity (Tension)	PVC	D-638	psi	351,000
Continuous Operating Temperature	PVC	UL746B	°F (°C)	122 (50)
Heat Deflection Temperature (264 psi)	PVC	D-648	°F (°C)	161 (72)
Tensile Strength (+73°F)	PVC	D-638	psi	6,500
Izod Impact Strength (+73°F)	PVC	D-256	ft. lbs./in. notch	15
Flame Resistance	PVC	D-635	-	Self-Extinguishing
UL Standard 94	PVC	-	.029 and .062	94V-O

Wiring Capacity

Duct Size (W"xH")	Duct Area (Sq. In.)	ELECTRICAL						DATA			
		10 AWG	12 AWG	14 AWG	14 AWG	16 AWG	18 AWG	22 AWG	CAT 5E	CAT 6	CAT 6A
		WIRE O.D.									
		0.176	0.158	0.165	0.139	0.125	0.113	0.065	0.217	0.240	0.354
0.5x0.5	0.18	4	5	4	6	7	9	27	2	2	1
0.5x1	0.38	8	10	9	13	15	19	57	5	4	2
0.75x0.75	0.28	6	7	7	9	11	14	42	4	3	1
1x1	0.735	15	19	17	24	30	37	111	10	8	4
1x1.5	1.135	23	29	27	37	46	57	171	15	1	6
1x2	1.515	31	39	35	50	62	76	228	20	17	8
1x3	2.22	46	57	52	73	90	111	335	30	25	11
1x4	2.936	60	75	69	97	120	146	443	40	32	15
1.5x1	1.205	25	31	28	40	49	60	182	16	13	6
1.5x1.5	1.85	38	47	43	61	75	92	279	25	20	9
1.5x2	2.475	51	63	58	82	101	123	373	33	27	13
1.5x3	3.669	75	94	86	121	150	183	553	50	41	19
1.5x4	4.881	100	125	114	161	199	243	736	66	54	25
2x1	1.678	35	43	39	55	68	84	253	23	19	9
2x2	3.438	71	88	80	113	140	171	518	47	38	17
2x3	5.122	105	131	120	169	209	255	772	69	57	26
2x4	6.829	140	174	160	225	278	341	1030	92	76	35
2x5	8.488	175	217	199	280	346	423	1280	115	94	43
2.5x3	6.564	135	167	154	216	268	327	990	89	73	33
3x1	2.57	53	66	60	85	105	128	388	35	28	13
3x2	5.36	110	137	125	177	219	268	809	73	59	27
3x3	8.03	165	205	188	265	327	400	1210	109	89	41
3x4	10.72	221	274	251	354	437	535	1617	145	119	55
3x5	13.38	275	341	313	441	546	668	2017	181	148	68
4x2	7.288	150	186	171	240	297	364	1099	99	81	37
4x3	10.932	225	279	256	360	446	545	1648	148	121	56
4x4	14.62	301	373	342	482	596	729	2204	198	162	74
4x5	18.27	375	466	427	602	745	911	2754	247	202	93
6x4	22.4	461	572	524	739	913	1117	3377	303	248	114
8x4	30.16	620	770	706	994	1230	1505	4548	408	334	153

Bundling and Securing US Military Standards

Part No.	US MILSPEC
IT18R	
IT18R2C2	MS3368-5-2E, SAE-AS33681
IT18R2L4	
IT18R3C2	MS3368-5-3E, SAE-AS33681
IT18R3L4	
IT18R4L4	MS3368-5-4E, SAE-AS33681
IT18R6C2	MS3368-5-6E, SAE-AS33681
IT18R6L4	
IT18R8C2	MS3368-5-8E, SAE-AS33681
IT18R9C2	MS3368-5-9E, SAE-AS33681
IT18R9L4	
IT50L	
IT50L0M4	MS3368-2-0A, SAE-AS33681
IT50L3M4	MS3368-2-3A, SAE-AS33681
IT50L4M4	MS3368-2-4A, SAE-AS33681
IT50L6M4	MS3368-2-6A, SAE-AS33681
IT50L9C2	MS3368-2-9A, SAE-AS81531
IT50R	
IT50R2C2	MS3368-1-2A, SAE-AS33681
IT50R3M4	MS3368-1-3A, SAE-AS33681
IT50R4C2	MS3368-1-4A, SAE-AS33681
IT50R9C2	MS3368-1-9A, SAE-AS81531
IT50R9M4	MS3368-1-9A, SAE-AS33681
IT50RD	
IT50RD4K2	MS3368-3-4C, SAE-AS33681
IT50RD9K2	MS3368-3-9C, SAE-AS81531
IT50RT	
IT50RT4K2	MS3368-4-4D, SAE-AS33681
IT50RT9K2	MS3368-4-9D, SAE-AS81531
T120L	
T120L0H5K2	MS3367-1-10
T120L0K2	
T120L0UVK2	SAE-AS33671, MS3367-6-0
T120L9K2	MS3367-6-9, SAE-AS33671
T120R	
T120R0H4	MS3367-1-10
T120R0H5H4	
T120R0H5K2	
T120R0K2	
T120R0UVC2	MS3367-3-0, SAE-AS33671
T120R0UVH4	
T120R9H4	MS3367-3-9, SAE-AS33671
T120R9K2	

Part No.	US MILSPEC
T150L	
T150L0X2	MS3367-1-10
T150L9X2	
T18R	
T18R0HSC2	MS3367-1-10
T18R0H5M4	
T18R0UVC2	MS3367-4-0, SAE-AS81531
T18R0UVM4	MS3367-4-0, SAE-AS33671
T18R10M4	MS3367-1-10
T18R1M4	MS3367-4-1, SAE-AS33671
T18R2M4	MS3367-4-2, SAE-AS33671
T18R3M4	MS3367-4-3, SAE-AS33671
T18R4M4	MS3367-4-4, SAE-AS33671
T18R5M4	MS3367-4-5, SAE-AS33671
T18R6M4	MS3367-4-6, SAE-AS33671
T18R7M4	MS3367-4-7, SAE-AS33671
T18R8M4	MS3367-4-8, SAE-AS33671
T18R9C2	MS3367-4-9
T18R9M4	
T30R	
T30R0HSC2	MS3367-1-10
T30R0H5M4	
T30R0UVC2	MS3367-5-0, SAE-AS81531
T30R0UVM4	MS3367-5-0, SAE-AS81531, SAE-AS33671
T30R10C2	MS3367-1-10
T30R10M4	
T30R1C2	MS3367-5-1, SAE-AS33671
T30R1M4	
T30R2C2	MS3367-5-2, SAE-AS33671
T30R2M4	
T30R3C2	MS3367-5-3, SAE-AS33671
T30R3M4	
T30R4C2	MS3367-5-4, SAE-AS33671
T30R4M4	MS3367-5-5, SAE-AS33671
T30R5C2	
T30R5M4	MS3367-5-6, SAE-AS33671
T30R6C2	
T30R6M4	MS3367-5-7, SAE-AS33671
T30R7C2	
T30R7M4	MS3367-5-8, SAE-AS33671
T30R8C2	
T30R8M4	MS3367-5-9, SAE-AS81531
T30R9C2	
T30R9M4	

Bundling and Securing US Military Standards

Part No.	US MILSPEC
T50I	
T50I0C2	MS3367-1-10
T50I0HSC2	
T50I0HSM4	
T50I0M4	
T50I0UVC2	MS3367-5-0, SAE-AS33671
T50I0UVM4	
T50I9C2	SAE-AS81531, MS3367-7-9
T50I9M4	MS3367-5-9, SAE-AS81531
T50L	
T50L0UVC2	MS3367-5-0, SAE-AS33671
T50L0UVM4	
T50L1C2	MS3367-2-1, SAE-AS33671
T50L2C2	MS3367-2-2, SAE-AS33671
T50L2M4	
T50L3C2	MS3367-2-3, SAE-AS33671
T50L3M4	
T50L4C2	MS3367-2-4, SAE-AS33671
T50L4M4	
T50L5C2	MS3367-2-5, SAE-AS33671
T50L5M4	
T50L6C2	MS3367-2-6, SAE-AS33671
T50L6M4	
T50L8C2	MS3367-2-8, SAE-AS33671
T50L8M4	
T50L9C2	MS3367-5-9, SAE-AS81531
T50L9M4	MS3367-2-9, SAE-AS33671
T50R	
T50R0C2	MS3367-1-10
T50R0HSC2	
T50R0HSM4	
T50R0UVC2	MS3367-1-0, SAE-AS33671
T50R0UVM4	MS3367-5-0, SAE-AS33671
T50R10C2	MS3367-1-10
T50R10M4	
T50R1C2	MS3367-1-1, SAE-AS33671
T50R1M4	
T50R2C2	MS3367-1-2, SAE-AS33671
T50R2M4	
T50R3C2	MS3367-1-3, SAE-AS33671
T50R3M4	
T50R4C2	MS3367-1-4, SAE-AS33671
T50R4M4	
T50R5C2	MS3367-1-5, SAE-AS33671
T50R5M4	

Part No.	US MILSPEC
T50R6C2	MS3367-1-6, SAE-AS33671
T50R6M4	
T50R7C2	MS3367-1-7, SAE-AS33671
T50R7M4	
T50R8C2	MS3367-1-8, SAE-AS33671
T50R8M4	
T50R9C2	MS3367-5-9, SAE-AS81531
T50R9M4	MS3367-1-9, SAE-AS81531

Routing, Protection and Insulation US Military Standards

Part No.	US MILSPEC
BSHKLPFR120B	
170-03153	MIL-STD-202
BSHKLPFR340B	
170-03154	MIL-STD-202
BSHKLPFR1140B	
170-03155	MIL-STD-202
BSHKLPFR200B	
170-03156	MIL-STD-202
BSHKLPFR212B	
170-03157	MIL-STD-202
G51TC	
251-30309	MS21266-3T
G51TD	
251-30409	MS21266-4T
G51TE	
251-30509	MS21266-5T
G51TF	
251-30609	MS21266-6T
G51TG	
251-30709	MS21266-7T
G51TH	
251-30809	MS21266-8T
G51NA	
FHA	MS21266-1N
G51NB	
FHB	MS21266-2N
G51NC	
FHC	MS21266-3N
G51ND	
FHD	MS21266-4N
G51NE	
FHE	MS21266-5N

Routing, Protection and Insulation US Military Standards

Part No.	US MILSPEC
G51NF	
FHF	MS21266-6N
G51NG	
FHG	MS21266-7N
G51TA	
FTA	MS21266-1T
G51TB	
FTB	MS21266-2T

Identification US Military Standards

Part No.	US MILSPEC
HST3-1BK	
553-50001	SAE-AMS-DTL-23053/5 Class 1 and 3, MIL-STD-202G Method 215K, SAE-AS81531
HST3-1WH	
553-50002	SAE-AMS-DTL-23053/5 Class 1 and 3, MIL-STD-202G Method 215K, SAE-AS81531
553-50003	
HST3-1WH-S	
553-50004	SAE-AMS-DTL-23053/5 Class 1 and 3, MIL-STD-202G Method 215K, SAE-AS81531
HST3-1YE	
553-50005	SAE-AMS-DTL-23053/5 Class 1 and 3, MIL-STD-202G Method 215K, SAE-AS81531
553-50006	
HST3-1YE-S	
553-50007	SAE-AMS-DTL-23053/5 Class 1 and 3, MIL-STD-202G Method 215K, SAE-AS81531
HST4.8-1.6BK	
553-50008	SAE-AMS-DTL-23053/5 Class 1 and 3, MIL-STD-202G Method 215K, SAE-AS81531
HST4.8-1.6WH	
553-50009	SAE-AMS-DTL-23053/5 Class 1 and 3, MIL-STD-202G Method 215K, SAE-AS81531
553-50010	
HST4.8-1.6WH-S	
553-50011	SAE-AMS-DTL-23053/5 Class 1 and 3, MIL-STD-202G Method 215K, SAE-AS81531
HST4.8-1.6YE	
553-50012	SAE-AMS-DTL-23053/5 Class 1 and 3, MIL-STD-202G Method 215K, SAE-AS81531
HST4.8-1.6YE-S	
553-50014	SAE-AMS-DTL-23053/5 Class 1 and 3, MIL-STD-202G Method 215K, SAE-AS81531
HST6-2BK	
553-50015	SAE-AMS-DTL-23053/5 Class 1 and 3, MIL-STD-202G Method 215K, SAE-AS81531

Identification US Military Standards

Part No.	US MILSPEC
HST6-2WH	
553-50016	SAE-AMS-DTL-23053/5 Class 1 and 3, MIL-STD-202G Method 215K, SAE-AS81531
553-50017	
553-50018	
HST6-2WH-S	
553-50019	SAE-AMS-DTL-23053/5 Class 1 and 3, MIL-STD-202G Method 215K, SAE-AS81531
HST6-2YE	
553-50020	SAE-AMS-DTL-23053/5 Class 1 and 3, MIL-STD-202G Method 215K, SAE-AS81531
HTS6-2YE	
553-50021	SAE-AMS-DTL-23053/5 Class 1 and 3, MIL-STD-202G Method 215K, SAE-AS81531
HST6-2YE-S	
553-50022	SAE-AMS-DTL-23053/5 Class 1 and 3, MIL-STD-202G Method 215K, SAE-AS81531
HST9-3BK	
553-50023	SAE-AMS-DTL-23053/5 Class 1 and 3, MIL-STD-202G Method 215K, SAE-AS81531
HST9-3WH	
553-50024	SAE-AMS-DTL-23053/5 Class 1 and 3, MIL-STD-202G Method 215K, SAE-AS81531
HST9-3WH-S	
553-50025	SAE-AMS-DTL-23053/5 Class 1 and 3, MIL-STD-202G Method 215K, SAE-AS81531
HST9-3YE	
553-50026	SAE-AMS-DTL-23053/5 Class 1 and 3, MIL-STD-202G Method 215K, SAE-AS81531
HST9-3YE-S	
553-50027	SAE-AMS-DTL-23053/5 Class 1 and 3, MIL-STD-202G Method 215K, SAE-AS81531
HST12-4BK	
553-50028	SAE-AMS-DTL-23053/5 Class 1 and 3, MIL-STD-202G Method 215K, SAE-AS81531
HST12-4WH	
553-50029	SAE-AMS-DTL-23053/5 Class 1 and 3, MIL-STD-202G Method 215K, SAE-AS81531
HST12-4WH-S	
553-50030	SAE-AMS-DTL-23053/5 Class 1 and 3, MIL-STD-202G Method 215K, SAE-AS81531
HST12-4YE	
553-50031	SAE-AMS-DTL-23053/5 Class 1 and 3, MIL-STD-202G Method 215K, SAE-AS81531
HST12-4YE-S	
553-50032	SAE-AMS-DTL-23053/5 Class 1 and 3, MIL-STD-202G Method 215K, SAE-AS81531
HST18-6BK	
553-50033	SAE-AMS-DTL-23053/5 Class 1 and 3, MIL-STD-202G Method 215K, SAE-AS81531

Identification US Military Standards

Part No.	US MILSPEC
HST18-6WH	
553-50034	SAE-AMS-DTL-23053/5 Class 1 and 3, MIL-STD-202G Method 215K, SAE-AS81531
HST18-6WH-S	
553-50035	SAE-AMS-DTL-23053/5 Class 1 and 3, MIL-STD-202G Method 215K, SAE-AS81531
HST18-6YE	
553-50036	SAE-AMS-DTL-23053/5 Class 1 and 3, MIL-STD-202G Method 215K, SAE-AS81531
HST18-6YE-S	
553-50037	SAE-AMS-DTL-23053/5 Class 1 and 3, MIL-STD-202G Method 215K, SAE-AS81531
HST24-8BK	
553-50038	SAE-AMS-DTL-23053/5 Class 1 and 3, MIL-STD-202G Method 215K, SAE-AS81531
HST24-8WH	
553-50039	SAE-AMS-DTL-23053/5 Class 1 and 3, MIL-STD-202G Method 215K, SAE-AS81531
HST24-8WH-S	
553-50040	SAE-AMS-DTL-23053/5 Class 1 and 3, MIL-STD-202G Method 215K, SAE-AS81531
HST24-8YE	
553-50041	SAE-AMS-DTL-23053/5 Class 1 and 3, MIL-STD-202G Method 215K, SAE-AS81531
HST24-8YE-S	
553-50042	SAE-AMS-DTL-23053/5 Class 1 and 3, MIL-STD-202G Method 215K, SAE-AS81531
HST3-1WH-3S	
553-50063	SAE-AMS-DTL-23053/5 Class 1 and 3, MIL-STD-202G Method 215K, SAE-AS81531
HST4.8-1.6WH-3S	
553-50064	SAE-AMS-DTL-23053/5 Class 1 and 3, MIL-STD-202G Method 215K, SAE-AS81531
HST6-2WH-3S	
553-50065	SAE-AMS-DTL-23053/5 Class 1 and 3, MIL-STD-202G Method 215K, SAE-AS81531
HST9-3WH-3S	
553-50066	SAE-AMS-DTL-23053/5 Class 1 and 3, MIL-STD-202G Method 215K, SAE-AS81531
HST3-1WH-S	
553-50067	SAE-AMS-DTL-23053/5 Class 1 and 3, MIL-STD-202G Method 215K, SAE-AS81531
HST4.8-1.6WH-2S	
553-50068	SAE-AMS-DTL-23053/5 Class 1 and 3, MIL-STD-202G Method 215K, SAE-AS81531
HST4.8-1.6YE-2S	
553-50069	SAE-AMS-DTL-23053/5 Class 1 and 3, MIL-STD-202G Method 215K, SAE-AS81531

Part No.	US MILSPEC
HST3-1WH-2S	
553-50070	SAE-AMS-DTL-23053/5 Class 1 and 3, MIL-STD-202G Method 215K, SAE-AS81531
HST3-1YE-2S	
553-50071	SAE-AMS-DTL-23053/5 Class 1 and 3, MIL-STD-202G Method 215K, SAE-AS81531
HST4.8-1.6WH-2S	
553-50072	SAE-AMS-DTL-23053/5 Class 1 and 3, MIL-STD-202G Method 215K, SAE-AS81531
HST4.8-1.6YE-2S	
553-50073	SAE-AMS-DTL-23053/5 Class 1 and 3, MIL-STD-202G Method 215K, SAE-AS81531
HST3-1WH-S	
553-50074	SAE-AMS-DTL-23053/5 Class 1 and 3, MIL-STD-202G Method 215K, SAE-AS81531
HST3-1WH-2S	
553-50075	SAE-AMS-DTL-23053/5 Class 1 and 3, MIL-STD-202G Method 215K, SAE-AS81531
HST3-1YE-S	
553-50076	SAE-AMS-DTL-23053/5 Class 1 and 3, MIL-STD-202G Method 215K, SAE-AS81531
HST3-1YE-2S	
553-50077	SAE-AMS-DTL-23053/5 Class 1 and 3, MIL-STD-202G Method 215K, SAE-AS81531
HST3-1WH	
553-50078	SAE-AMS-DTL-23053/5 Class 1 and 3, MIL-STD-202G Method 215K, SAE-AS81531
HST4.8-1.6WH	
553-50079	SAE-AMS-DTL-23053/5 Class 1 and 3, MIL-STD-202G Method 215K, SAE-AS81531
HST4.8-1.6WH-S	
553-50080	SAE-AMS-DTL-23053/5 Class 1 and 3, MIL-STD-202G Method 215K, SAE-AS81531
HST4.8-1.6WH-3S	
553-50081	SAE-AMS-DTL-23053/5 Class 1 and 3, MIL-STD-202G Method 215K, SAE-AS81531
HST6-2WH-2S	
553-50082	SAE-AMS-DTL-23053/5 Class 1 and 3, MIL-STD-202G Method 215K, SAE-AS81531
HST6-2YE-2S	
553-50083	SAE-AMS-DTL-23053/5 Class 1 and 3, MIL-STD-202G Method 215K, SAE-AS81531
HST6-2WH-S	
553-50084	SAE-AMS-DTL-23053/5 Class 1 and 3, MIL-STD-202G Method 215K, SAE-AS81531
HST6-2YE-S	
553-50085	SAE-AMS-DTL-23053/5 Class 1 and 3, MIL-STD-202G Method 215K, SAE-AS81531

Identification US Military Standards

Part No.	US MILSPEC
HST12-4WH-3S	
553-50086	SAE-AMS-DTL-23053/5 Class 1 and 3, MIL-STD-202G Method 215K, SAE-AS81531
HST12-4YE-3S	
553-50087	SAE-AMS-DTL-23053/5 Class 1 and 3, MIL-STD-202G Method 215K, SAE-AS81531
HST3-1WH-3S	
553-50088	SAE-AMS-DTL-23053/5 Class 1 and 3, MIL-STD-202G Method 215K, SAE-AS81531
HST6-2WH-3S	
553-50089	SAE-AMS-DTL-23053/5 Class 1 and 3, MIL-STD-202G Method 215K, SAE-AS81531
HST4.8-1.6WH	
553-50090	SAE-AMS-DTL-23053/5 Class 1 and 3, MIL-STD-202G Method 215K, SAE-AS81531
HST4.8-1.6WH-S	
553-50176	SAE-AMS-DTL-23053/5 Class 1 and 3, MIL-STD-202G Method 215K, SAE-AS81531
HST4.8-1.6WH	
553-50177	SAE-AMS-DTL-23053/5 Class 1 and 3, MIL-STD-202G Method 215K, SAE-AS81531
HST6-2BK-3S	
553-50178	SAE-AMS-DTL-23053/5 Class 1 and 3, MIL-STD-202G Method 215K, SAE-AS81531
HST3-1BK-S	
553-50179	SAE-AMS-DTL-23053/5 Class 1 and 3, MIL-STD-202G Method 215K, SAE-AS81531
HST3-1BK-2S	
553-50180	SAE-AMS-DTL-23053/5 Class 1 and 3, MIL-STD-202G Method 215K, SAE-AS81531
HST3-1BK-3S	
553-50181	SAE-AMS-DTL-23053/5 Class 1 and 3, MIL-STD-202G Method 215K, SAE-AS81531
HST4.8-1.6BK-3S	
553-50184	SAE-AMS-DTL-23053/5 Class 1 and 3, MIL-STD-202G Method 215K, SAE-AS81531
HST6-2BK-2S	
553-50186	SAE-AMS-DTL-23053/5 Class 1 and 3, MIL-STD-202G Method 215K, SAE-AS81531
HST9-3BK-3S	
553-50189	SAE-AMS-DTL-23053/5 Class 1 and 3, MIL-STD-202G Method 215K, SAE-AS81531
HST9-3WH	
553-50192	SAE-AMS-DTL-23053/5 Class 1 and 3, MIL-STD-202G Method 215K, SAE-AS81531
HST12-4WH	
553-50193	SAE-AMS-DTL-23053/5 Class 1 and 3, MIL-STD-202G Method 215K, SAE-AS81531

Part No.	US MILSPEC
HST4.8-1.6WH	
553-50195	SAE-AMS-DTL-23053/5 Class 1 and 3, MIL-STD-202G Method 215K, SAE-AS81531
HST6-2WH	
553-50196	SAE-AMS-DTL-23053/5 Class 1 and 3, MIL-STD-202G Method 215K, SAE-AS81531
HST18-6WH	
553-50199	SAE-AMS-DTL-23053/5 Class 1 and 3, MIL-STD-202G Method 215K, SAE-AS81531
HST4.8-1.6WHAP	
553-50203	SAE-AMS-DTL-23053/5 Class 1 and 3, MIL-STD-202G Method 215K, SAE-AS81531
HST6-2WHAP	
553-50204	SAE-AMS-DTL-23053/5 Class 1 and 3, MIL-STD-202G Method 215K, SAE-AS81531
HST12-4WHAP	
553-50206	SAE-AMS-DTL-23053/5 Class 1 and 3, MIL-STD-202G Method 215K, SAE-AS81531
HST39-13WH	
553-50209	SAE-AMS-DTL-23053/5 Class 1 and 3, MIL-STD-202G Method 215K, SAE-AS81531
HST6-2YE-3S	
553-50210	SAE-AMS-DTL-23053/5 Class 1 and 3, MIL-STD-202G Method 215K, SAE-AS81531
HST3-1WH-3S	
553-50211	SAE-AMS-DTL-23053/5 Class 1 and 3, MIL-STD-202G Method 215K, SAE-AS81531
HST6-2WH-3S	
553-50212	SAE-AMS-DTL-23053/5 Class 1 and 3, MIL-STD-202G Method 215K, SAE-AS81531
HST4.8-1.6WH-S	
553-50213	SAE-AMS-DTL-23053/5 Class 1 and 3, MIL-STD-202G Method 215K, SAE-AS81531
HST18-6BK-S	
553-50222	SAE-AMS-DTL-23053/5 Class 1 and 3, MIL-STD-202G Method 215K, SAE-AS81531
HST24-8BK-S	
553-50223	SAE-AMS-DTL-23053/5 Class 1 and 3, MIL-STD-202G Method 215K, SAE-AS81531
HFST39-13YE	
553-50225	SAE-AMS-DTL-23053/5 Class 1 and 3, MIL-STD-202G Method 215K, SAE-AS81531
HFST39-13WH-S	
553-50226	SAE-AMS-DTL-23053/5 Class 1 and 3, MIL-STD-202G Method 215K, SAE-AS81531
HFST39-13YE-S	
553-50227	SAE-AMS-DTL-23053/5 Class 1 and 3, MIL-STD-202G Method 215K, SAE-AS81531

Identification US Military Standards

Part No.	US MILSPEC
HST12-4WH	
553-50231	SAE-AMS-DTL-23053/5 Class 1 and 3, MIL-STD-202G Method 215K, SAE-AS81531
HST12-4WH-S	
553-50232	SAE-AMS-DTL-23053/5 Class 1 and 3, MIL-STD-202G Method 215K, SAE-AS81531
HST18-6WH	
553-50233	SAE-AMS-DTL-23053/5 Class 1 and 3, MIL-STD-202G Method 215K, SAE-AS81531
HST18-6WH-S	
553-50234	SAE-AMS-DTL-23053/5 Class 1 and 3, MIL-STD-202G Method 215K, SAE-AS81531
HST9-3WH	
553-50236	SAE-AMS-DTL-23053/5 Class 1 and 3, MIL-STD-202G Method 215K, SAE-AS81531
HST24-8WH	
553-50237	SAE-AMS-DTL-23053/5 Class 1 and 3, MIL-STD-202G Method 215K, SAE-AS81531
HST4.8-1YE-3S	
553-50239	SAE-AMS-DTL-23053/5 Class 1 and 3, MIL-STD-202G Method 215K, SAE-AS81531
HST18-6YE	
553-50240	SAE-AMS-DTL-23053/5 Class 1 and 3, MIL-STD-202G Method 215K, SAE-AS81531
HST18-6YE-S	
553-50241	SAE-AMS-DTL-23053/5 Class 1 and 3, MIL-STD-202G Method 215K, SAE-AS81531
HST6-2WH-S	
553-50242	SAE-AMS-DTL-23053/5 Class 1 and 3, MIL-STD-202G Method 215K, SAE-AS81531
HST12-4WH-S	
553-50250	SAE-AMS-DTL-23053/5 Class 1 and 3, MIL-STD-202G Method 215K, SAE-AS81531
HST9-3WH-2S	
553-50251	SAE-AMS-DTL-23053/5 Class 1 and 3, MIL-STD-202G Method 215K, SAE-AS81531
TIPTAGVA10X65YEW	
556-26006	MIL-STD-202G Method 215K, SAE-AS81531
TIPTAGVA10X90YEW	
556-26007	MIL-STD-202G Method 215K, SAE-AS81531
TIPTAGVA15X65YEW	
556-26008	MIL-STD-202G Method 215K, SAE-AS81531
TIPTAGVA15X90YEW	
556-26009	MIL-STD-202G Method 215K, SAE-AS81531
PW.25W1P	
596-96255	MIL-STD-202, MIL-STD-810G
PW.50W2P	
596-96256	MIL-STD-202, MIL-STD-810G

Part No.	US MILSPEC
PW.75W2P	
596-96258	MIL-STD-202, MIL-STD-810G
PW.50W1P	
596-96261	MIL-STD-202, MIL-STD-810G
PW.75W1P	
596-96263	MIL-STD-202, MIL-STD-810G

Application Tools US Military Standards

Part No.	US MILSPEC
EVO7	
110-70083	MS90387-1, SAE-AS90387
T18RA50	
T18RA50	MS3367-4-9, SAE-AS33671
T18RA5000	
T18RA5000	MS3367-4-9, SAE-AS33671
T30RA	
T30RA30	MS3367-5-9, SAE-AS33671
T30RA3000	

Electrical insulation US Military Standards

Part No.	US MILSPEC
ET33	
ET330	MIL-1-7798-A
ET66	
ET660	MIL-1-7798-A
ETCW66	
ETCW660	MIL-1-24391-A
ETST66	
ETST6610	MIL-1-7798-A
ETST662	
ETST663	
ETST664	
ETST665	
ETST666	
ETST668	

Standards for HellermannTyton Bundling and Securing

Material	Color (short)	Specifications	File#	Material	Color (short)	Specifications	File#				
CTAM1				CTQM5							
PA66	BK	UL	E64139	PA66	BK	ANSI/UL 1565, ANSI/UL 62275, ANSI/UL 746B	E65344				
	WH	ANSI/UL 1565, ANSI/UL 62275, ANSI/UL 746B									
CTAM2				CTT20R							
PA66	BK	UL	E64139	PA66	BK	UL	E64139				
	WH	ANSI/UL 1565, ANSI/UL 62275, ANSI/UL 746B									
		UL									
PA66	BK	UL	E64139	PA66HS	BK	ANSI/UL 1565, ANSI/UL 62275, ANSI/UL 746B					
	WH	UL-ZODZ2.E64139									
CTAP1				CTT60R							
PA66	BK	UL	E64139	PA66	BK	ANSI/UL 1565, ANSI/UL 62275, ANSI/UL 746B	E64139				
	WH	UL									
CTAP2				GT.50X11							
PA66	WH	UL-ZODZ2.E64139	E64139	PA66, PE	BK		E64139				
CTM0					PA66HIRHSUV			NA	UL		
PA66	BK	ANSI/UL 1565, ANSI/UL 62275, ANSI/UL 746B	E64139		PA66HS			BK	ANSI/UL 1565, ANSI/UL 62275, ANSI/UL 746B		
		UL-ZODZ2.E64139									
	NA	UL 62275									
	WH	ANSI/UL 1565, ANSI/UL 62275, ANSI/UL 746B									
UL-ZODZ2.E64139											
CTM1				GT.50X12							
PA66	BK	ANSI/UL 1565, ANSI/UL 62275, ANSI/UL 746B	E64139	PA6, PP	MN		E64139				
		UL 62275									
	WH	ANSI/UL 1565, ANSI/UL 62275, ANSI/UL 746B									
UL 62275											
CTM2				GT.50X6							
PA66	BK	ANSI/UL 1565, ANSI/UL 62275, ANSI/UL 746B	E64139	PA66, PE	BK		E64139				
		UL 62275									
	WH	ANSI/UL 1565, ANSI/UL 62275, ANSI/UL 746B									
		UL 62275									
CTM3								GT.50X8			
PA66	BK	ANSI/UL 1565, ANSI/UL 62275, ANSI/UL 746B	E64139					PA6, PP	MN		E64139
		UL 62275									
	WH	ANSI/UL 1565, ANSI/UL 62275, ANSI/UL 746B									
		UL 62275									
CTM4											
PA66	BK	ANSI/UL 1565, ANSI/UL 62275, ANSI/UL 746B	E64139	PA66, PE	BK		E64139				
		UL 62275									
	WH	ANSI/UL 1565, ANSI/UL 62275, ANSI/UL 746B									
		UL 62275									

Appendix

Product Approvals and Specifications

Standards for HellermannTyton Bundling and Securing

Material	Color (short)	Specifications	File#	Material	Color (short)	Specifications	File#	
GT.75X15				IT50R				
PA66, PE	BK		E64139	PA66	BK	UL	E64139	
	BU				ANSI/UL 1565, ANSI/UL 62275, ANSI/UL 746B, CAGE Code 53421			
	GN					CAGE Code 53421, UL-ZODZ2.E64139		
	OG							
	RD							
YE	UL							
GT.75X180				IT50RD				
PA66, PE	BK		E64139	PA66	BK	UL	E64139	
	BU				ANSI/UL 1565, ANSI/UL 62275, ANSI/UL 746B, CAGE Code 53421			
	GN					CAGE Code 53421, UL-ZODZ2.E64139		
	OG							
	RD							
	WH			UL				
YE								
GT.75X180W				IT50RT				
PA66, PE	BK		E64139	PA66	BK	UL	E64139	
H6P					ANSI/UL 1565, ANSI/UL 62275, ANSI/UL 746B, CAGE Code 53421			
PA66	NA	NF EN 45545-2				YE		CAGE Code 53421, UL-ZODZ2.E64139
IT18FL				KR6/35				
PA66	BK	UL	E64139	PA66UV	BK	IEC 62275:2006		
	BU							
	NA	ANSI/UL 62275, CAN/CSA-C22.2 no. 62275		KR8/21				
	OG	UL		PA66	NA	IEC 62275:2006, NF EN 45545-2		
	RD			PA66UV	BK	IEC 62275:2006		
	WH			KR8/33				
	YE				PA66UV	BK	IEC 62275:2006	
IT18R				MB1				
PA66	BK	UL	E64139	PA66	BK	UL		
	BU	CAGE Code 53421, UL-ZODZ2.E64139			NA			WH
	GY			UL	MB2.5			
	NA				CAGE Code 53421, UL-ZODZ2.E64139	PA66	BK	E64139
	OG			WH				
	RD			MB3				
	WH	UL		PA66	BK	UL	E64139	
YE	CAGE Code 53421, UL-ZODZ2.E64139	WH						
IT50L				MB4				
PA66	BK	CAGE Code 53421, UL-ZODZ2.E64139	E64139	PA66	BK	UL	E64139	
	BU				WH			
	NA	ANSI/UL 1565, ANSI/UL 62275, ANSI/UL 746B, CAGE Code 53421		MB4SH				
	OG	CAGE Code 53421, UL-ZODZ2.E64139		PA66	WH	UL	E64139	
	YE				MB5			
PA66	BK	UL	E64139	PA66	BK	UL	E64139	
	WH	ANSI/UL 1565, ANSI/UL 62275, ANSI/UL 746B						
					UL			

Standards for HellermannTyton Bundling and Securing

Material	Color (short)	Specifications	File#	Material	Color (short)	Specifications	File#
MBT14H				PBM			
SS316	ML	IEC 60092, IEC 62275:2006		PA66	BK	UL	E64139
MBT14S					NA		
SS316	ML	IEC 62275:2006			WH		
MBT14XH				PT220			
SS316	ML	IEC 60092, IEC 62275:2006		PEEK	BGE	DIN EN 62275:2016-01, EN 62275:2009	
MBT20H				PT2A			
SS316	ML	IEC 60092, IEC 62275:2006		PEEK	BGE	DIN EN 62275:2010-07, EN 62275:2009	
MBT20S				Q120I			
SS316	ML	IEC 60092, IEC 62275:2006		PA66	BK	ANSI/UL 1565, ANSI/UL 62275, ANSI/UL 746B	E65344
MBT20XH					NA		
SS316	ML	IEC 60092		PA66HS	BK		
MBT27H					NA		
SS316	ML	IEC 60092, IEC 62275:2006		Q120M			
MBT27S				PA66	BK	ANSI/UL 1565, ANSI/UL 62275, ANSI/UL 746B	E65344
SS316	ML	IEC 60092, IEC 62275:2006			NA		
MBT27XH				PA66HS	BK		
SS316	ML	IEC 60092			NA		
MBT33H				Q120R			
SS316	ML	IEC 60092, IEC 62275:2006		PA66	BK	ANSI/UL 1565, ANSI/UL 62275, ANSI/UL 746B	E65344
MBT33S					NA		
SS316	ML	IEC 60092, IEC 62275:2006		PA66HS	BK		
MBT33XH					NA		
SS316	ML	IEC 60092		Q18I			
MBT55				PA66	BK	ANSI/UL 1565, ANSI/UL 62275, ANSI/UL 746B	E65344
SS316	ML	IEC 60092, IEC 62275:2006			NA		
MBT8H				PA66HS	BK		
SS316	ML	IEC 62275:2006			NA		
MBT8S				Q18L			
SS316	ML	IEC 60092, IEC 62275:2006		PA66	BK	ANSI/UL 1565, ANSI/UL 62275, ANSI/UL 746B	E65344
MP3M3					NA		
PA66	NA	NF EN 45545-2		PA66HS	BK		
MP4M3					NA		
PA66	NA	ANSI/UL 1565, ANSI/UL 62275, ANSI/UL 746B	E64963	Q18R			
MSC2				PA66	BK	ANSI/UL 1565, ANSI/UL 62275, ANSI/UL 746B	E65344
SS304	ML		E64139		NA		
MSC2LP				PA66HS	BK		
SS304	ML		E64139		NA		
MSC90				Q30L			
SS304	ML		E64139	PA66	BK	ANSI/UL 1565, ANSI/UL 62275, ANSI/UL 746B	E65344
MSMP6/10					NA		
PA66	NA		E64139	PA66HS	BK		
MSMP6/6					NA		
PA66	NA	ANSI/UL 1565, ANSI/UL 62275, ANSI/UL 746B	E64139				

Appendix

Product Approvals and Specifications

Standards for HellermannTyton Bundling and Securing

Material	Color (short)	Specifications	File#	Material	Color (short)	Specifications	File#		
Q30R				RCA180LM12					
PA66	BK	ANSI/UL 1565, ANSI/UL 62275, ANSI/UL 746B	E65344	PA66HIRHSUV, ST, ZN	BK		E64139		
	NA			RCA180LM12SS					
PA66HS	BK			PA66HIRHSUV, SS304	BK		E64139		
	NA			RCA180LM6					
Q50I				RCA180LM6SS					
PA66	BK	ANSI/UL 1565, ANSI/UL 62275, ANSI/UL 746B	E65344	PA66HIRHSUV, ST, ZN	BK		E64139		
	NA			RCA180LM6SS					
PA66HS	BK			PA66HIRHSUV, SS304	BK		E64139		
	NA			RCA180LM8					
Q50L				RCA180LM8SS					
PA66	BK	ANSI/UL 1565, ANSI/UL 62275, ANSI/UL 746B	E65344	PA66HIRHSUV, ST, ZN	BK		E64139		
	NA			RCA180MM10					
PA66HS	BK			PA66HIRHSUV, SS304	BK		E64139		
	NA			RCA180MM10SS					
Q50R				RCA180MM12					
PA66	BK	ANSI/UL 1565, ANSI/UL 62275, ANSI/UL 746B	E65344	PA66HIRHSUV, ST, ZN	BK		E64139		
	NA			RCA180MM12SS					
PA66HS	BK			PA66HIRHSUV, SS304	BK		E64139		
	NA			RCA180MM6					
QM20				RCA180MM6SS					
PA66	BK	ANSI/UL 1565, ANSI/UL 62275, ANSI/UL 746B	E65344	PA66HIRHSUV, ST, ZN	BK		E64139		
	NA			RCA180MM8					
RCA15SM10				RCA180MM8SS					
PA66HIRHSUV, ST, ZN	BK				E64139	PA66HIRHSUV, SS304	BK		E64139
RCA15SM10SS				RCA180SM10					
PA66HIRHSUV, SS304	BK		E64139	PA66HIRHSUV, ST, ZN	BK		E64139		
RCA15SM12				RCA180SM10SS					
PA66HIRHSUV, ST, ZN	BK		E64139	PA66HIRHSUV, SS304	BK		E64139		
RCA15SM12SS				RCA180SM12					
PA66HIRHSUV, SS304	BK		E64139	PA66HIRHSUV, ST, ZN	BK		E64139		
RCA15SM6				RCA180SM12SS					
PA66HIRHSUV, ST, ZN	BK		E64139	PA66HIRHSUV, SS304	BK		E64139		
RCA15SM6SS				RCA180SM6					
PA66HIRHSUV, SS304	BK		E64139	PA66HIRHSUV, ST, ZN	BK		E64139		
RCA15SM8				RCA180SM6SS					
PA66HIRHSUV, ST, ZN	BK		E64139	PA66HIRHSUV, SS304	BK		E64139		
RCA15SM8SS				RCA180SM10					
PA66HIRHSUV, SS304	BK		E64139	PA66HIRHSUV, ST, ZN	BK		E64139		
RCA180LM10				RCA180SM12					
PA66HIRHSUV, ST, ZN	BK		E64139	PA66HIRHSUV, ST, ZN	BK		E64139		
RCA180LM10SS				RCA180SM12SS					
PA66HIRHSUV, SS304	BK		E64139	PA66HIRHSUV, SS304	BK		E64139		
				RCA180SM6					
				PA66HIRHSUV, ST, ZN					
				BK					
				E64139					
				RCA180SM6SS					
				PA66HIRHSUV, SS304					
				BK					
				E64139					

Standards for HellermannTyton Bundling and Securing

Material	Color (short)	Specifications	File#	Material	Color (short)	Specifications	File#
RCA180SM8				RCA90LM12			
PA66HIRHSUV, ST, ZN	BK		E64139	PA66HIRHSUV, ST, ZN	BK		E64139
RCA180SM8SS				RCA90LM12SS			
PA66HIRHSUV, SS304	BK		E64139	PA66HIRHSUV, SS304	BK		E64139
RCA30LM10				RCA90LM6			
PA66HIRHSUV, ST, ZN	BK		E64139	PA66HIRHSUV, ST, ZN	BK		E64139
RCA30LM10SS				RCA90LM6SS			
PA66HIRHSUV, SS304	BK		E64139	PA66HIRHSUV, SS304	BK		E64139
RCA30LM12				RCA90LM8			
PA66HIRHSUV, ST, ZN	BK		E64139	PA66HIRHSUV, ST, ZN	BK		E64139
RCA30LM12SS				RCA90LM8SS			
PA66HIRHSUV, SS304	BK		E64139	PA66HIRHSUV, SS304	BK		E64139
RCA30LM6				RCA90SM10			
PA66HIRHSUV, ST, ZN	BK		E64139	PA66HIRHSUV, ST, ZN	BK		E64139
RCA30LM6SS				RCA90SM10SS			
PA66HIRHSUV, SS304	BK		E64139	PA66HIRHSUV, SS304	BK		E64139
RCA30LM8				RCA90SM12			
PA66HIRHSUV, ST, ZN	BK		E64139	PA66HIRHSUV, ST, ZN	BK		E64139
RCA30LM8SS				RCA90SM12SS			
PA66HIRHSUV, SS304	BK		E64139	PA66HIRHSUV, SS304	BK		E64139
RCA30SM10				RCA90SM6			
PA66HIRHSUV, ST, ZN	BK		E64139	PA66HIRHSUV, ST, ZN	BK		E64139
RCA30SM10SS				RCA90SM6SS			
PA66HIRHSUV, SS304	BK		E64139	PA66HIRHSUV, SS304	BK		E64139
RCA30SM12				RCA90SM8			
PA66HIRHSUV, ST, ZN	BK		E64139	PA66HIRHSUV, ST, ZN	BK		E64139
RCA30SM12SS				RCA90SM8SS			
PA66HIRHSUV, SS304	BK		E64139	PA66HIRHSUV, SS304	BK		E64139
RCA30SM6				RCB15SM10			
PA66HIRHSUV, ST, ZN	BK		E64139	PA66HIRHSUV, ST, ZN	BK		E64139
RCA30SM6SS				RCB15SM10SS			
PA66HIRHSUV, SS304	BK		E64139	PA66HIRHSUV, SS304	BK		E64139
RCA30SM8				RCB15SM12			
PA66HIRHSUV, ST, ZN	BK		E64139	PA66HIRHSUV, ST, ZN	BK		E64139
RCA30SM8SS				RCB15SM12SS			
PA66HIRHSUV, SS304	BK		E64139	PA66HIRHSUV, SS304	BK		E64139
RCA90LM10				RCB15SM6			
PA66HIRHSUV, ST, ZN	BK		E64139	PA66HIRHSUV, ST, ZN	BK		E64139
RCA90LM10SS				RCB15SM6SS			
PA66HIRHSUV, SS304	BK		E64139	PA66HIRHSUV, SS304	BK		E64139

Appendix

Product Approvals and Specifications

Standards for HellermannTyton Bundling and Securing

Material	Color (short)	Specifications	File#	Material	Color (short)	Specifications	File#
RCB155M8				RCB180SM12			
PA66HIRHSUV, ST, ZN	BK		E64139	PA66HIRHSUV, ST, ZN	BK		E64139
RCB155M8SS				RCB180SM12SS			
PA66HIRHSUV, SS304	BK		E64139	PA66HIRHSUV, SS304	BK		E64139
RCB180LM10				RCB180SM6			
PA66HIRHSUV, ST, ZN	BK		E64139	PA66HIRHSUV, ST, ZN	BK		E64139
RCB180LM10SS				RCB180SM6SS			
PA66HIRHSUV, SS304	BK		E64139	PA66HIRHSUV, SS304	BK		E64139
RCB180LM12				RCB180SM8			
PA66HIRHSUV, ST, ZN	BK		E64139	PA66HIRHSUV, ST, ZN	BK		E64139
RCB180LM12SS				RCB180SM8SS			
PA66HIRHSUV, SS304	BK		E64139	PA66HIRHSUV, SS304	BK		E64139
RCB180LM6				RCB30LM10			
PA66HIRHSUV, ST, ZN	BK		E64139	PA66HIRHSUV, ST, ZN	BK		E64139
RCB180LM6SS				RCB30LM10SS			
PA66HIRHSUV, SS304	BK		E64139	PA66HIRHSUV, SS304	BK		E64139
RCB180LM8				RCB30LM12			
PA66HIRHSUV, ST, ZN	BK		E64139	PA66HIRHSUV, ST, ZN	BK		E64139
RCB180LM8SS				RCB30LM12SS			
PA66HIRHSUV, SS304	BK		E64139	PA66HIRHSUV, SS304	BK		E64139
RCB180MM10				RCB30LM6			
PA66HIRHSUV, ST, ZN	BK		E64139	PA66HIRHSUV, ST, ZN	BK		E64139
RCB180MM10SS				RCB30LM6SS			
PA66HIRHSUV, SS304	BK		E64139	PA66HIRHSUV, SS304	BK		E64139
RCB180MM12				RCB30LM8			
PA66HIRHSUV, ST, ZN	BK		E64139	PA66HIRHSUV, ST, ZN	BK		E64139
RCB180MM12SS				RCB30LM8SS			
PA66HIRHSUV, SS304	BK		E64139	PA66HIRHSUV, SS304	BK		E64139
RCB180MM6				RCB30SM10			
PA66HIRHSUV, ST, ZN	BK		E64139	PA66HIRHSUV, ST, ZN	BK		E64139
RCB180MM6SS				RCB30SM10SS			
PA66HIRHSUV, SS304	BK		E64139	PA66HIRHSUV, SS304	BK		E64139
RCB180MM8				RCB30SM12			
PA66HIRHSUV, ST, ZN	BK		E64139	PA66HIRHSUV, ST, ZN	BK		E64139
RCB180MM8SS				RCB30SM12SS			
PA66HIRHSUV, SS304	BK		E64139	PA66HIRHSUV, SS304	BK		E64139
RCB180SM10				RCB30SM6			
PA66HIRHSUV, ST, ZN	BK		E64139	PA66HIRHSUV, ST, ZN	BK		E64139
RCB180SM10SS				RCB30SM6SS			
PA66HIRHSUV, SS304	BK		E64139	PA66HIRHSUV, SS304	BK		E64139

Standards for HellermannTyton Bundling and Securing

Material	Color (short)	Specifications	File#	Material	Color (short)	Specifications	File#
RCB30SM8				RCC15SM12			
PA66HIRHSUV, ST, ZN	BK		E64139	PA66HIRHSUV, ST, ZN	BK		E64139
RCB30SM8SS				RCC15SM12SS			
PA66HIRHSUV, SS304	BK		E64139	PA66HIRHSUV, SS304	BK		E64139
RCB90LM10				RCC15SM6			
PA66HIRHSUV, ST, ZN	BK		E64139	PA66HIRHSUV, ST, ZN	BK		E64139
RCB90LM10SS				RCC15SM6SS			
PA66HIRHSUV, SS304	BK		E64139	PA66HIRHSUV, SS304	BK		E64139
RCB90LM12				RCC15SM8			
PA66HIRHSUV, ST, ZN	BK		E64139	PA66HIRHSUV, ST, ZN	BK		E64139
RCB90LM12SS				RCC15SM8SS			
PA66HIRHSUV, SS304	BK		E64139	PA66HIRHSUV, SS304	BK		E64139
RCB90LM6				RCC180LM10			
PA66HIRHSUV, ST, ZN	BK		E64139	PA66HIRHSUV, ST, ZN	BK		E64139
RCB90LM6SS				RCC180LM10SS			
PA66HIRHSUV, SS304	BK		E64139	PA66HIRHSUV, SS304	BK		E64139
RCB90LM8				RCC180LM12			
PA66HIRHSUV, ST, ZN	BK		E64139	PA66HIRHSUV, ST, ZN	BK		E64139
RCB90LM8SS				RCC180LM12SS			
PA66HIRHSUV, SS304	BK		E64139	PA66HIRHSUV, SS304	BK		E64139
RCB90SM10				RCC180LM6			
PA66HIRHSUV, ST, ZN	BK		E64139	PA66HIRHSUV, ST, ZN	BK		E64139
RCB90SM10SS				RCC180LM6SS			
PA66HIRHSUV, SS304	BK		E64139	PA66HIRHSUV, SS304	BK		E64139
RCB90SM12				RCC180LM8			
PA66HIRHSUV, ST, ZN	BK		E64139	PA66HIRHSUV, ST, ZN	BK		E64139
RCB90SM12SS				RCC180LM8SS			
PA66HIRHSUV, SS304	BK		E64139	PA66HIRHSUV, SS304	BK		E64139
RCB90SM6				RCC180MM10			
PA66HIRHSUV, ST, ZN	BK		E64139	PA66HIRHSUV, ST, ZN	BK		E64139
RCB90SM6SS				RCC180MM10SS			
PA66HIRHSUV, SS304	BK		E64139	PA66HIRHSUV, SS304	BK		E64139
RCB90SM8				RCC180MM12			
PA66HIRHSUV, ST, ZN	BK		E64139	PA66HIRHSUV, ST, ZN	BK		E64139
RCB90SM8SS				RCC180MM12SS			
PA66HIRHSUV, SS304	BK		E64139	PA66HIRHSUV, SS304	BK		E64139
RCC15SM10				RCC180MM6			
PA66HIRHSUV, ST, ZN	BK		E64139	PA66HIRHSUV, ST, ZN	BK		E64139
RCC15SM10SS				RCC180MM6SS			
PA66HIRHSUV, SS304	BK		E64139	PA66HIRHSUV, SS304	BK		E64139

Appendix

Product Approvals and Specifications

Standards for HellermannTyton Bundling and Securing

Material	Specifications	File#
1FRP		
PE-FR		E147924
1N		
PA6		E147924
1NFP		
PE		E147924
1P		
PTFE		E147924
2.5FRP		
PE-FR		E147924
2.5N		
PA6		E147924
2.5NFP		
PE		E147924
2.5P		
PTFE		E147924
2FRP		
PE-FR		E147924
2N		
PA6		E147924
2NFP		
PE		E147924
2P		
PTFE		E147924
3FRP		
PE-FR		E147924
3N		
PA6		E147924
3NFP		
PE		E147924
3P		
PTFE		E147924
4FRP		
PE-FR		E147924
4N		
PA6		E147924
4NFP		
PE		E147924
4P		
PTFE		E147924
5FRP		
PE-FR		E147924
5N		
PA6		E147924
5NFP		
PE		E147924
5P		
PTFE		E147924
BSHKLP1140B		
PET		E147924

Material	Specifications	File#
BSHKLP120B		
PET		E147924
BSHKLP200B		
PET		E147924
BSHKLP212B		
PET		E147924
BSHKLP340B		
PET		E147924
BSHKLPR1140B		
PET	MIL-STD 202, UL	E147924
BSHKLPR120B		
PET	MIL-STD 202, UL	E147924
BSHKLPR200B		
PET	MIL-STD 202, UL	E147924
BSHKLPR212B		
PET	MIL-STD 202, UL	E147924
BSHKLPR340B		
PET	MIL-STD 202, UL	E147924
BSHTFG100		
GF		E147924
BSHTFG100B		
GF		E147924
BSHTFG120		
GF		E147924
BSHTFG120B		
GF		E147924
BSHTFG140		
GF		E147924
BSHTFG140B		
GF		E147924
BSHTFG340		
GF		E147924
BSHTFG340B		
GF		E147924
BSP100		
PET		E147924
BSP100B		
PET		E147924
BSP103B		
PET		E147924
BSP1120		
PET		E147924
BSP1123B		
PET		E147924
BSP1140		
PET		E147924
BSP1140B		
PET		E147924
BSP1143B		
PET		E147924

Standards for HellermannTyton Bundling and Securing

Material	Color (short)	Specifications	File#	Material	Color (short)	Specifications	File#
RCC180MM8				RCC305M12			
PA66HIRHSUV, ST, ZN	BK		E64139	PA66HIRHSUV, ST, ZN	BK		E64139
RCC180MM8SS				RCC305M12SS			
PA66HIRHSUV, SS304	BK		E64139	PA66HIRHSUV, SS304	BK		E64139
RCC1805M10				RCC305M6			
PA66HIRHSUV, ST, ZN	BK		E64139	PA66HIRHSUV, ST, ZN	BK		E64139
RCC1805M10SS				RCC305M6SS			
PA66HIRHSUV, SS304	BK		E64139	PA66HIRHSUV, SS304	BK		E64139
RCC1805M12				RCC305M8			
PA66HIRHSUV, ST, ZN	BK		E64139	PA66HIRHSUV, ST, ZN	BK		E64139
RCC1805M12SS				RCC305M8SS			
PA66HIRHSUV, SS304	BK		E64139	PA66HIRHSUV, SS304	BK		E64139
RCC1805M6				RCC90LM10			
PA66HIRHSUV, ST, ZN	BK		E64139	PA66HIRHSUV, ST, ZN	BK		E64139
RCC1805M6SS				RCC90LM10SS			
PA66HIRHSUV, SS304	BK		E64139	PA66HIRHSUV, SS304	BK		E64139
RCC1805M8				RCC90LM12			
PA66HIRHSUV, ST, ZN	BK		E64139	PA66HIRHSUV, ST, ZN	BK		E64139
RCC1805M8SS				RCC90LM12SS			
PA66HIRHSUV, SS304	BK		E64139	PA66HIRHSUV, SS304	BK		E64139
RCC30LM10				RCC90LM6			
PA66HIRHSUV, ST, ZN	BK		E64139	PA66HIRHSUV, ST, ZN	BK		E64139
RCC30LM10SS				RCC90LM6SS			
PA66HIRHSUV, SS304	BK		E64139	PA66HIRHSUV, SS304	BK		E64139
RCC30LM12				RCC90LM8			
PA66HIRHSUV, ST, ZN	BK		E64139	PA66HIRHSUV, ST, ZN	BK		E64139
RCC30LM12SS				RCC90LM8SS			
PA66HIRHSUV, SS304	BK		E64139	PA66HIRHSUV, SS304	BK		E64139
RCC30LM6				RCC905M10			
PA66HIRHSUV, ST, ZN	BK		E64139	PA66HIRHSUV, ST, ZN	BK		E64139
RCC30LM6SS				RCC905M10SS			
PA66HIRHSUV, SS304	BK		E64139	PA66HIRHSUV, SS304	BK		E64139
RCC30LM8				RCC905M12			
PA66HIRHSUV, ST, ZN	BK		E64139	PA66HIRHSUV, ST, ZN	BK		E64139
RCC30LM8SS				RCC905M12SS			
PA66HIRHSUV, SS304	BK		E64139	PA66HIRHSUV, SS304	BK		E64139
RCC305M10				RCC905M6			
PA66HIRHSUV, ST, ZN	BK		E64139	PA66HIRHSUV, ST, ZN	BK		E64139
RCC305M10SS				RCC905M6SS			
PA66HIRHSUV, SS304	BK		E64139	PA66HIRHSUV, SS304	BK		E64139

Appendix

Product Approvals and Specifications

Standards for HellermannTyton Bundling and Securing

Material	Color (short)	Specifications	File#	Material	Color (short)	Specifications	File#
RCC90SM8				RCD180MM12			
PA66HIRHSUV, ST, ZN	BK		E64139	PA66HIRHSUV, ST, ZN	BK		E64139
RCC90SM8SS				RCD180MM12SS			
PA66HIRHSUV, SS304	BK		E64139	PA66HIRHSUV, SS304	BK		E64139
RCD15SM10				RCD180MM6			
PA66HIRHSUV, ST, ZN	BK		E64139	PA66HIRHSUV, ST, ZN	BK		E64139
RCD15SM10SS				RCD180MM6SS			
PA66HIRHSUV, SS304	BK		E64139	PA66HIRHSUV, SS304	BK		E64139
RCD15SM12				RCD180MM8			
PA66HIRHSUV, ST, ZN	BK		E64139	PA66HIRHSUV, ST, ZN	BK		E64139
RCD15SM12SS				RCD180MM8SS			
PA66HIRHSUV, SS304	BK		E64139	PA66HIRHSUV, SS304	BK		E64139
RCD15SM6				RCD180SM10			
PA66HIRHSUV, ST, ZN	BK		E64139	PA66HIRHSUV, ST, ZN	BK		E64139
RCD15SM6SS				RCD180SM10SS			
PA66HIRHSUV, SS304	BK		E64139	PA66HIRHSUV, SS304	BK		E64139
RCD15SM8				RCD180SM12			
PA66HIRHSUV, ST, ZN	BK		E64139	PA66HIRHSUV, ST, ZN	BK		E64139
RCD15SM8SS				RCD180SM12SS			
PA66HIRHSUV, SS304	BK		E64139	PA66HIRHSUV, SS304	BK		E64139
RCD180LM10				RCD180SM6			
PA66HIRHSUV, ST, ZN	BK		E64139	PA66HIRHSUV, ST, ZN	BK		E64139
RCD180LM10SS				RCD180SM6SS			
PA66HIRHSUV, SS304	BK		E64139	PA66HIRHSUV, SS304	BK		E64139
RCD180LM12				RCD180SM8			
PA66HIRHSUV, ST, ZN	BK		E64139	PA66HIRHSUV, ST, ZN	BK		E64139
RCD180LM12SS				RCD180SM8SS			
PA66HIRHSUV, SS304	BK		E64139	PA66HIRHSUV, SS304	BK		E64139
RCD180LM6				RCD30LM10			
PA66HIRHSUV, ST, ZN	BK		E64139	PA66HIRHSUV, ST, ZN	BK		E64139
RCD180LM6SS				RCD30LM10SS			
PA66HIRHSUV, SS304	BK		E64139	PA66HIRHSUV, SS304	BK		E64139
RCD180LM8				RCD30LM12			
PA66HIRHSUV, ST, ZN	BK		E64139	PA66HIRHSUV, ST, ZN	BK		E64139
RCD180LM8SS				RCD30LM12SS			
PA66HIRHSUV, SS304	BK		E64139	PA66HIRHSUV, SS304	BK		E64139
RCD180MM10				RCD30LM6			
PA66HIRHSUV, ST, ZN	BK		E64139	PA66HIRHSUV, ST, ZN	BK		E64139
RCD180MM10SS				RCD30LM6SS			
PA66HIRHSUV, SS304	BK		E64139	PA66HIRHSUV, SS304	BK		E64139

Appendix

Product Approvals and Specifications

Standards for HellermannTyton Bundling and Securing

Material	Color (short)	Specifications	File#
RT250XL			
PA66	BK	ANSI/UL 1565, ANSI/UL 62275, ANSI/UL 746B	E64139
	NA		
PA66UV	BK	UL	
RT255R			
PA66HIRHSUV	BK	UL-ZODZ2.E64139	E64139
RT255S			
PA66HIRHSUV	BK	UL-ZODZ2.E64139	E64139
RT40R			
PA66	BK	UL-ZODZ2.E64139	E64139
	NA		
RT50LL			
PA66	BK	UL-ZODZ2.E64139	E64139
	NA		
RT50S			
PA66	BK	UL-ZODZ2.E64139	E64139
	NA		
T120I			
PA66	BK	ANSI/UL 1565, ANSI/UL 62275, ANSI/UL 746B	E64139
	NA		
PA66HIRHSUV	BK	UL-ZODZ2.E64139	E64139
PA66HS			
PA66UV			
T120L			
PA66	BK	UL-ZODZ2.E64139	E64139
	NA	CAGE Code 53421, UL-ZODZ.E64139	
PA66HS	BK	UL-ZODZ2.E64139, VG U48/04103	E64139
PA66UV		CAGE Code 53421, CAN/CSA-C22.2 no. 62275, VG 95387 Part 4 Edition: 2008-12	
T120MR			
PA66	BK	ANSI/UL 62275	E64139
	NA	ANSI/UL 1565, ANSI/UL 62275, ANSI/UL 746B	
T120R			
E/TFE	BU	ANSI/UL 1565, ANSI/UL 62275, ANSI/UL 746B	E193818
PA66	BK	UL-ZODZ2.E64139	E64139
	NA	BACS38K, CAGE Code 53421, UL-ZODZ.E64139	
		CAGE Code 53421, UL-ZODZ.E64139	
T120R(U)			
PA66	BK	UL-ZODZ2.E64139	E64139
	NA		
PA66UV	BK	UL-ZODZ2.E64139	
T120RDH			
PA66	BK	UL-ZODZ2.E64139	E64139
T120S			
PA66	BK	UL-ZODZ2.E64139	E64139
	NA	ANSI/UL 1565, ANSI/UL 62275, ANSI/UL 746B, CAN/CSA-C22.2 no. 18.5, CAN/CSA-C22.2 no. 62275	
		UL-ZODZ2.E64139	
PA66HIRHSUV	BK	UL-ZODZ2.E64139	E64139
PA66HS			
PA66UV			E64139
T150L			
PA66	BK	ANSI/UL 1565, ANSI/UL 62275, ANSI/UL 746B	E64139
	NA		
PA66UV	BK		
T150LL			
PA66	BK	UL-ZODZ2.E64139	E64139
	NA		
PA66UV	BK		
T150M			
PA66	BK	ANSI/UL 1565, ANSI/UL 62275, ANSI/UL 746B	E64139
	NA		
PA66HS	BK		
PA66UV			
T150R(U)			
PA66	BK	UL-ZODZ2.E64139	E64139
	NA		
PA66UV	BK	UL-ZODZ2.E64139	
T150XL			
PA66	BK	ANSI/UL 1565, ANSI/UL 62275, ANSI/UL 746B	E64139
	NA		
PA66HS	BK		
PA66UV			
T150XLL			
PA66	BK	ANSI/UL 1565, ANSI/UL 62275, ANSI/UL 746B	E64139
	NA		
PA66UV	BK		

Standards for HellermannTyton Bundling and Securing

Material	Color (short)	Specifications	File#
T18I			
PA66	BK	UL-ZODZ2.E64139	E64139
	NA	IEC 62275:2006	
PA66HS	BK	UL-ZODZ2.E64139	
PA66V0	NA		
T18L			
PA66	BK	UL-ZODZ2.E64139	E64139
	NA		
PA66HS	BK		
PA66V0	NA		
T18MR			
PA66	BK	UL	E64139
	NA		
PA66HS	BK		
T18R			
E/TFE	BU	ANSI/UL 1565, ANSI/UL 62275, IEC 62275:2006	E64962
PA66	BK	CAGE Code 53421, UL-ZODZ.E64139	E64139
	BN		
	BU	CAGE Code 53421	E85319
		ANSI/UL 1565, ANSI/UL 62275, ANSI/UL 746B	
	GN	CAGE Code 53421, UL-ZODZ.E64139	E64139
		ANSI/UL 1565, ANSI/UL 62275, ANSI/UL 746B, IEC 62275:2006	
	GY	CAGE Code 53421, UL-ZODZ.E64139	E64139
		UL-ZODZ2.E85319	
	NA		E64139
	OG	CAGE Code 53421, UL-ZODZ.E64139	
	PE		
	RD	ANSI/UL 1565, ANSI/UL 62275, ANSI/UL 746B, IEC 62275:2006	E85319
WH	UL-ZODZ2.E64139	E64139	
YE	CAGE Code 53421, UL-ZODZ.E64139		
		ANSI/UL 1565, ANSI/UL 62275, ANSI/UL 746B, IEC 62275:2006	E85319
T18R			
PA66HS	BK	UL-ZODZ2.E64139	E64139
PA66UV		CAGE Code 53421, VG 95387 Part 4 Edition: 2008-12	
		CAGE Code 53421, UL-ZODZ2.E64139, VG 95387 Part 4 Edition: 2008-12	
PA66V0		ANSI/UL 62275, CAN/CSA-C22.2 no. 62275	
	NA	UL-ZODZ2.E64139	
T18RWPM			
PA66	NA	UL	E64139
		UL-ZODZ2.E64139	
PA66HS	BK	UL	
T18S			
PA66	BK	IEC 62275:2006	E64139
	NA		
PA66HS	BK	ANSI/UL 1565, ANSI/UL 62275, ANSI/UL 746B	
		IEC 62275:2006, UL-ZODZ2.E64139, VG U48/04103	
T250I			
PA66	NA	ANSI/UL 1565, ANSI/UL 62275, ANSI/UL 746B	E64139
T250L			
PA66	BK	ANSI/UL 1565, ANSI/UL 62275, ANSI/UL 746B	E64139
	NA		
T250M			
PA66	BK	ANSI/UL 1565, ANSI/UL 62275, ANSI/UL 746B	E64139
	NA		
PA66HIRHSUV	BK	UL-ZODZ2.E64139	
PA66UV			
T250R			
PA66	BK	UL-ZODZ2.E64139	E64139
	NA	ANSI/UL 1565, ANSI/UL 62275, ANSI/UL 746B	
PA66HIRHSUV	BK	ANSI/UL 1565, ANSI/UL 62275, ANSI/UL 746B	
T250S			
PA66	BK	UL-ZODZ2.E64139	E64139
	NA		
T250XL			
PA66	BK	ANSI/UL 1565, ANSI/UL 62275, ANSI/UL 746B	E64139
	NA		
PA66HIRHSUV	BK		
T255M			
PA66HIRHSUV	BK	UL-ZODZ2.E64139	E64139
T255R			
PA66HIRHSUV	BK	UL-ZODZ2.E64139	E64139
T255S			
PA66HIRHSUV	BK		E64139

Appendix

Product Approvals and Specifications

Standards for HellermannTyton Bundling and Securing

Material	Color (short)	Specifications	File#	
T30L				
PA66	BK	UL-ZODZ2.E64139	E64139	
	NA			
PA66UV	BK			
T30LL				
PA66	BK	2011/65/EU article 4, 2014/35/EU, UL-ZODZ2.E64139	E64139	
	NA			
PA66HS	BK	UL-ZODZ2.E64139		
T30MR				
PA66	BK	ANSI/UL 1565, ANSI/UL 62275, ANSI/UL 746B	E64139	
		UL-ZODZ2.E64139		
	NA	ANSI/UL 1565, ANSI/UL 62275, ANSI/UL 746B		
		UL		
PA66HS	BK			
T30R				
E/TFE	BU	ANSI/UL 1565, ANSI/UL 62275	E64962	
PA66	BK	CAGE Code 53421, UL-ZODZ.E64139	E64139	
	BN			
	BU			
	GN			
	GY			
	NA	CAGE Code 53421, IEC 62275:2006, VG 95387 Part 4 Edition: 2008-12		
	OG	CAGE Code 53421, UL-ZODZ.E64139		
	PE			
	RD			
	WH	UL-ZODZ2.E64139		
YE	CAGE Code 53421, UL-ZODZ.E64139			
PA66HIRHSUV	BK	UL-ZODZ2.E64139	E64139	
PA66HS				
PA66UV				
PA66V0				
PA66V0				
T30RSF(U)				
PA66	NA	ANSI/UL 1565, ANSI/UL 62275, ANSI/UL 746B, CAN/CSA-C22.2 no. 18.5, CAN/CSA-C22.2 no. 62275	E64139	
PA66HS	BK	UL-ZODZ2.E64139		
T30XL				
PA66	BK	2011/65/EU article 4, 2014/35/EU, UL-ZODZ2.E64139	E64139	
	NA			
T40I				
PA66	BK	2011/65/EU article 4, 2014/35/EU, UL-ZODZ2.E64139	E64139	
	NA			
T40L				
PA66	BK	UL-ZODZ2.E64139	E64139	
	NA			
PA66HS	BK			
T40R(U)				
PA66	BK	UL-ZODZ2.E64139	E64139	
	NA			
PA66HS	BK			
T50I				
PA66	BK	UL-ZODZ2.E64139	E64139	
	NA	BACS38K, CAGE Code 53421, VG 95387 Part 4 Edition: 2008-12		
		CAGE Code 53421, VG 95387 Part 4 Edition: 2008-12		
PA66HIRHSUV				
PA66HS		UL-ZODZ2.E64139, VG U48/04103		
PA66UV	BK	BACS38K, CAGE Code 53421, UL-ZODZ2.E64139, VG 95387 Part 4 Edition: 2008-12		
		CAGE Code 53421, UL-ZODZ2.E64139, VG 95387 Part 4 Edition: 2008-12		
PA66V0	NA	UL-ZODZ2.E64139		
T50IDH				
PA66	BK	UL-ZODZ2.E64139		E64139
	NA			
PA66HS	BK	ANSI/UL 1565, ANSI/UL 62275, ANSI/UL 746B		
PA66UV				

Standards for HellermannTyton Bundling and Securing

Material	Color (short)	Specifications	File#	Material	Color (short)	Specifications	File#			
T50L				T50R						
E/TFE	BU	ANSI/UL 1565, ANSI/UL 62275	E64962	PA66	BK	CAGE Code 53421, UL-ZODZ.E64139	E64139			
PA66	BK	UL-ZODZ2.E64139	E64139		BN					
	BN	CAGE Code 53421, UL-ZODZ.E64139			BU					
	BU				GN					
	GN				GY					
	GY				NA	BACS38K, CAGE Code 53421, VG 95387 Part 4 Edition: 2008-12				
	OG	CAGE Code 53421, UL-ZODZ.E64139			E64139					
	RD									
WH	UL-ZODZ2.E64139	WH	UL-ZODZ2.E64139							
YE	CAGE Code 53421, UL-ZODZ.E64139	YE	CAGE Code 53421, UL-ZODZ.E64139							
PA66HIRHSUV	BK	UL-ZODZ2.E64139, VG 95387 Part 4 Edition: 2008-12	E64139		PA66HIRHSUV	BK	UL-ZODZ2.E64139	E64139		
PA66HS					PA66HS		UL-ZODZ2.E64139			
PA66UV					BACS38K, CAGE Code 53421, UL-ZODZ2.E64139, VG 95387 Part 4 Edition: 2008-12	CAGE Code 53421, UL-ZODZ2.E64139, VG 95387 Part 4 Edition: 2008-12	E64139	PA66UV	BK	BACS38K, CAGE Code 53421, UL-ZODZ2.E64139
				PA66V0				NA		UL-ZODZ2.E64139
T50LDH				T50RDH						
PA66	BK	UL-ZODZ2.E64139	E64139	PA66	BK	UL	E64139			
	NA	ANSI/UL 1565, ANSI/UL 62275, ANSI/UL 746B		PA66HS	NA					
PA66HS	BK	UL-ZODZ2.E64139		PA66UV	BK	UL				
T50ML				T50ROS						
PA66	BK	UL	E64139	PA66HS	BK	DIN EN 45545-2				
	NA	ANSI/UL 1565, ANSI/UL 62275, ANSI/UL 746B		E64139	T50RSF(U)					
		UL-ZODZ2.E64139			PA66	NA	UL-ZODZ2.E64139	E64139		
PA66HS	BK		PA66HS	BK						
T50MR				T50S						
PA66	BK	UL-ZODZ2.E64139	E64139	PA66	BK	2011/65/EU article 4, 2014/35/EU, UL-ZODZ2.E64139	E64139			
	NA				NA					
T50R				T50SDH						
E/TFE	BU	ANSI/UL 1565, ANSI/UL 62275	E64962	PA66	BK	E64139	E64139			
				PA66	NA					
T50SSF				TM1SF						
PA66	NA	E64139	E64139	PA66	BK	DIN EN 45545-2	E64139			
PA66HS	BK									
	NA				NA					
	WH				WH					

Appendix

Product Approvals and Specifications

Standards for HellermannTyton Routing Protection Insulation

Material	Specifications	File#
BSP120		
PET		E147924
BSP120B		
PET		E147924
BSP123B		
PET		E147924
BSP140		
PET		E147924
BSP140B		
PET		E147924
BSP143B		
PET		E147924
BSP180		
PET		E147924
BSP180B		
PET		E147924
BSP200B		
PET		E147924
BSP340		
PET		E147924
BSP340B		
PET		E147924
BSP343B		
PET		E147924
BSPFR100B		
PET	UL 94 VW-1	E147924
BSPFR1120		
PET	UL 94 VW-1	E147924
BSPFR1120B		
PET	UL 94 VW-1	E147924
BSPFR1128		
PET	UL 94 VW-1	E147924
BSPFR1140		
PET	UL 94 VW-1	E147924
BSPFR1140B		
PET	UL 94 VW-1	E147924
BSPFR120		
PET	UL 94 VW-1	E147924
BSPFR120B		
PET	UL 94 VW-1	E147924
BSPFR128		
PET	UL 94 VW-1	E147924
BSPFR140		
PET	UL 94 VW-1	E147924
BSPFR140B		
PET	UL 94 VW-1	E147924
BSPFR148		
PET	UL 94 VW-1	E147924
BSPFR180B		
PET	UL 94 VW-1	E147924

Material	Specifications	File#
BSPFR188		
PET	UL 94 VW-1	E147924
BSPFR340		
PET	UL 94 VW-1	E147924
BSPFR340B		
PET	UL 94 VW-1	E147924
BSPFR348		
PET	UL 94 VW-1	E147924
BSPFR380		
PET	UL 94 VW-1	E147924
BSPSC100		
PET		E147924
BSPSC1120		
PET		E147924
BSPSC1140		
PET		E147924
BSPSC120		
PET		E147924
BSPSC140		
PET		E147924
BSPSC180		
PET		E147924
BSPSC340		
PET		E147924
BSPSW100		
PET		E147924
BSPSW100B		
PET		E147924
BSPSW100LB		
PET		E147924
BSPSW103B		
PET		E147924
BSPSW1120B		
PET		E147924
BSPSW1120LB		
PET		E147924
BSPSW1123B		
PET		E147924
BSPSW1140		
PET		E147924
BSPSW1140B		
PET		E147924
BSPSW1140LB		
PET		E147924
BSPSW1143B		
PET		E147924
BSPSW120		
PET		E147924
BSPSW120B		
PET		E147924

Standards for HellermannTyton Routing Protection Insulation

Material	Specifications	File#
BSPSW120LB		
PET		E147924
BSPSW123B		
PET		E147924
BSPSW140		
PET		E147924
BSPSW140B		
PET		E147924
BSPSW140LB		
PET		E147924
BSPSW143B		
PET		E147924
BSPSW180B		
PET		E147924
BSPSW180LB		
PET		E147924
BSPSW200B		
PET		E147924
BSPSW200LB		
PET		E147924
BSPSW203B		
PET		E147924
BSPSW340		
PET		E147924
BSPSW340B		
PET		E147924
BSPSW340LB		
PET		E147924
BSPSW343B		
PET		E147924
BSPSW380LB		
PET		E147924
BSSCFR100		
PET		E147924
BSSCFR100B		
PET		E147924
BSSCFR1120		
PET		E147924
BSSCFR1120B		
PET		E147924
BSSCFR1140		
PET		E147924
BSSCFR1140B		
PET		E147924
BSSCFR120		
PET		E147924
BSSCFR120B		
PET		E147924
BSSCFR140		
PET		E147924

Material	Specifications	File#
BSSCFR140B		
PET		E147924
BSSCFR180B		
PET		E147924
BSSCFR340		
PET		E147924
BSSCFR340B		
PET		E147924
BSSWFR100B		
PET		E147924
BSSWFR1120B		
PET		E147924
BSSWFR1140B		
PET		E147924
BSSWFR120B		
PET		E147924
BSSWFR140B		
PET		E147924
BSSWFR180B		
PET		E147924
BSSWFR200B		
PET		E147924
BSSWFR340B		
PET		E147924
BSSWV100B		
PET		E147924
BSSWV1120B		
PET		E147924
BSSWV120B		
PET		E147924
BSSWV340B		
PET		E147924
BSSWV380B		
PET		E147924
BSSWV580B		
PET		E147924
DV1		
PVC	EN 50085-1:2005 + A1:2013, EN 50085-2-3_1A, UL	
DV1.5		
PVC	EN 50085-1:2005 + A1:2013, EN 50085-2-3_1A, UL	
DV2		
PVC	EN 50085-1:2005 + A1:2013, EN 50085-2-3_1A, UL	
DV3		
PVC	EN 50085-1:2005 + A1:2013, EN 50085-2-3_1A, UL	
DV4		
PVC	EN 50085-1:2005 + A1:2013, EN 50085-2-3_1A, UL	

Appendix

Product Approvals and Specifications

Standards for HellermannTyton Routing Protection Insulation

Material	Specifications	File#
G51NA		
PA6	NASM21266	
G51NB		
PA6	NASM21266	
G51NC		
PA6	NASM21266	
G51ND		
PA6	NASM21266	
G51NE		
PA6	NASM21266	
G51NF		
PA6	NASM21266	
G51NG		
PA6	NASM21266	
HEGPA6604		
PA66	EN 45545-2:2013	
HEGPA6606		
PA66	EN 45545-2:2013	
HEGPA6608		
PA66	EN 45545-2:2013	
HEGPA6610		
PA66	EN 45545-2:2013	
HEGPA6612		
PA66	EN 45545-2:2013	
HEGPA6620		
PA66	EN 45545-2:2013	
HEGPA6625		
PA66	EN 45545-2:2013	
HEGPA6630		
PA66	EN 45545-2:2013	
HEGPA6650		
PA66	EN 45545-2:2013	
HG038-45-0500		
PA66		E229161
HG038-90-0500		
PA66		E229161
HG038-HG038		
PA66		E229161
HG038-R050		
PA66		E229161
HG038-S-0380		
PA66		E229161
HG038-S-0500		
PA66		E229161
HG038-S-M16		
PA66		E229161
HG038-T		
PA66		E229161
HG050-45-0500		
PA66		E229161

Material	Specifications	File#
HG050-90-0500		
PA66		E229161
HG050-HG050		
PA66		E229161
HG050-R075		
PA66		E229161
HG050-S-0500		
PA66		E229161
HG050-T		
PA66		E229161
HG075-45-0750		
PA66		E229161
HG075-90-0750		
PA66		E229161
HG075-HG075		
PA66		E229161
HG075-R100		
PA66		E229161
HG075-S-0750		
PA66		E229161
HG075-T		
PA66		E229161
HG100-45-1000		
PA66		E229161
HG100-90-1000		
PA66		E229161
HG100-HG100		
PA66		E229161
HG100-S-1000		
PA66		E229161
HG100-T		
PA66		E229161
HG125-45-1500		
PA66		E229161
HG125-90-1250		
PA66		E229161
HG125-90-1500		
PA66		E229161
HG125-HG125		
PA66		E229161
HG125-S-1250		
PA66		E229161
HG125-S-1500		
PA66		E229161
HG125-T		
PA66		E229161
HG150-45-1500		
PA66		E229161

Standards for HellermannTyton Routing Protection Insulation

Material	Specifications	File#
HG150-90-1500		
PA66		E229161
HG150-HG150		
PA66		E229161
HG150-S-1500		
PA66		E229161
HG150-S-2000		
PA66		E229161
HG200-90-2000		
PA66		E229161
HG200-S-2000		
PA66		E229161
HG-FR0380		
PA6FR		E229161
HG-FR0500		
PA6FR		E229161
HG-FR0750		
PA6FR		E229161
HG-FR1000		
PA6FR		E229161
HG-FR1250		
PA6FR		E229161
HG-FR1500		
PA6FR		E229161
HG-HI0310		
PA12		E229161
HG-HI0380		
PA12		E229161
HG-HI0500		
PA12		E229161
HG-HI0750		
PA12		E229161
HG-HI1000		
PA12		E229161
HG-HI1250		
PA12		E229161
HG-HI1500		
PA12		E229161
HG-HI2000		
PA12		E229161
HG-HISL0380		
PA12		E229161
HGL038-90-0500		
PA66		E247502
HGL038-S-0380		
PA66		E229161
HGL038-T		
PA66		E247502
HGL050-45-0500		
PA66		E247502

Material	Specifications	File#
HGL050-90-0500		
PA66		E247502
HGL050-S-0500		
PA66		E246572
HGL050-T		
PA66		E247502
HGL075-45-0750		
PA66		E247502
HGL075-90-0750		
PA66		E247502
HGL075-S-0750		
PA66		E246572
HGL075-T		
PA66		E247502
HGL075-Y050		
PA66		E247502
HGL100-45-1000		
PA66		E247502
HGL100-90-1000		
PA66		E247502
HGL100-S-1000		
PA66		E246572
HGL100-T		
PA66		E247502
HGL125-90-1250		
PA66		E247502
HGL125-S-1250		
PA66		E246572
HGL125-T		
PA66		E247502
HGL150-45-1500		
PA66		E247502
HGL150-90-1500		
PA66		E247502
HGL150-S-1500		
PA66		E246572
HGL200-S-2000		
PA66		E246572
HG-LW0250		
PA6		E229161
HG-LW0380		
PA6		E229161
HG-LW0500		
PA6		E229161
HG-LW0750		
PA6		E229161
HG-LW1000		
PA6		E229161
HG-LW1250		
PA6		E229161

Appendix

Product Approvals and Specifications

Standards for HellermannTyton Routing Protection Insulation

Material	Specifications	File#
HG-LW1500		
PA6		E229161
HG-LW2000		
PA6		E229161
HG-SW0250		
PA6		E229161
HG-SW0258		
PA6		E229161
HG-SW0310		
PA6		E229161
HG-SW0318		
PA6		E229161
HG-SW0380		
PA6		E229161
HG-SW0388		
PA6		E229161
HG-SW0500		
PA6		E246572
		E229161
HG-SW0508		
PA6		E229161
HG-SW0750		
PA6		E246572
		E229161
HG-SW0758		
PA6		E229161
HG-SW1000		
PA6		E246572
HG-SW1008		
PA6		E246572
HG-SW1250		
PA6		E246572
HG-SW1258		
PA6		E246572
HG-SW1500		
PA6		E246572
HG-SW1508		
PA6		E246572
HG-SW2000		
PA6		E246572
HGU038-45-0500		
PA66		E247502
HGU038-90-0500		
PA66		E247502
HGU038-S-0500		
PA66		E247502
HGU050-45-0500		
PA66		E247502
HGU050-90-0500		
PA66		E247502

Material	Specifications	File#
HGU050-S-0500		
PA66		E247502
HGU075-45-0750		
PA66		E247502
HGU075-90-0750		
PA66		E247502
HGU075-S-0750		
PA66		E247502
HGU100-45-1000		
PA66		E247502
HGU100-90-1000		
PA66		E247502
HGU100-S-1000		
PA66		E247502
HGU125-45-1250		
PA66		E247502
HGU125-90-1250		
PA66		E247502
HGU125-90-1500		
PA66		E247502
HGU125-S-1250		
PA66		E247502
HGU125-S-1500		
PA66		E247502
HGU150-45-1500		
PA66		E247502
HGU150-90-1500		
PA66		E247502
HGU150-90-2000		
PA66		E247502
HGU150-S-1500		
PA66		E247502
HGU150-S-2000		
PA66		E247502
HGU16-45-M20B		
PA66		E247502
HGU16-90-M16B		
PA66		E247502
HGU16-90-M20B		
PA66		E247502
HGU16-S-M16B		
PA66		E247502
HGU16-S-M20B		
PA66		E247502
HGU21-45-M20B		
PA66		E247502
HGU21-90-M20B		
PA66		E247502
HGU21-S-M20B		
PA66		E247502

Standards for HellermannTyton Routing Protection Insulation

Material	Specifications	File#
HGU28-45-M25B		
PA66		E247502
HGU28-90-M25B		
PA66		E247502
HGU28-S-M25B		
PA66		E247502
HGU34-45-M32B		
PA66		E247502
HGU34-90-M32B		
PA66		E247502
HGU34-S-M32B		
PA66		E247502
HGU34-S-M40B		
PA66		E247502
HGU42-90-M40B		
PA66		E247502
HGU42-90-M50B		
PA66		E247502
HGU42-S-M40B		
PA66		E247502
HGU42-S-M50B		
PA66		E247502
HIS-3-BAG 12/4 BK		
PO-X	ANSI/UL 224, SAE - AMS - DTL-23053/5 Class 1 and 3, SAE - AMS - DTL-23053/5 Class 2	E143529
HIS-3-BAG 12/4 CL		
PO-X	ANSI/UL 224, SAE - AMS - DTL-23053/5 Class 1 and 3, SAE - AMS - DTL-23053/5 Class 2	
HIS-3-BAG 3/1 BK		
PO-X	ANSI/UL 224, SAE - AMS - DTL-23053/5 Class 1 and 3, SAE - AMS - DTL-23053/5 Class 2	E143529
HIS-3-BAG 3/1 CL		
PO-X	ANSI/UL 224, SAE - AMS - DTL-23053/5 Class 1 and 3, SAE - AMS - DTL-23053/5 Class 2	
HIS-3-BAG 4.5/1.5 BK		
PO-X	ANSI/UL 224, SAE - AMS - DTL-23053/5 Class 1 and 3, SAE - AMS - DTL-23053/5 Class 2	E143529
HIS-3-BAG 4.5/1.5 CL		
PO-X	ANSI/UL 224, SAE - AMS - DTL-23053/5 Class 1 and 3, SAE - AMS - DTL-23053/5 Class 2	
HIS-3-BAG 6/2 BK		
PO-X	ANSI/UL 224, SAE - AMS - DTL-23053/5 Class 1 and 3, SAE - AMS - DTL-23053/5 Class 2	E143529
HIS-3-BAG 6/2 CL		
PO-X	ANSI/UL 224, SAE - AMS - DTL-23053/5 Class 1 and 3, SAE - AMS - DTL-23053/5 Class 2	

Material	Specifications	File#
HIS-3-BAG 9/3 BK		
PO-X	ANSI/UL 224, SAE - AMS - DTL-23053/5 Class 1 and 3, SAE - AMS - DTL-23053/5 Class 2	E143529
HIS-3-BAG 9/3 CL		
PO-X	ANSI/UL 224, SAE - AMS - DTL-23053/5 Class 1 and 3, SAE - AMS - DTL-23053/5 Class 2	
HWPV016		
PA6V0	EN 45545-2:2013, UL 1441	E341700
HWPV020		
PA6V0	EN 45545-2:2013, UL 1441	E341700
HWPV025		
PA6V0	EN 45545-2:2013, UL 1441	E341700
HWPV030		
PA6V0	EN 45545-2:2013, UL 1441	E341700
HWPV08		
PA6V0	EN 45545-2:2013, UL 1441	E341700
HWPP16		
PP	ECE R 118-03 Abschnitt 6, 2017-06	
HWPP20		
PP	ECE R 118-03 Abschnitt 6, 2017-06	
HWPP25		
PP	ECE R 118-03 Abschnitt 6, 2017-06	
HWPP30		
PP	ECE R 118-03 Abschnitt 6, 2017-06	
HWPP8		
PP	ECE R 118-03 Abschnitt 6, 2017-06	
MCR-B10		
PVC		E192902
MCR-B8		
PVC		E192902
MCR-BS		
PVC		E192902
MCR-BS10		
PVC		E192902
MCR-BS8		
PVC		E192902
MCR-C10		
PVC		E192902
MCR-C8		
PVC		E192902
MCR-CS		
PVC		E211305
MCR-EC		
PVC		E211305

Standards for HellermannTyton Routing Protection Insulation

Material	Specifications	File#
MCR-EE		
PVC		E211305
MCR-ENT		
PVC		E211305
MCR-FE		
PVC		E211305
MCR-IE		
PVC		E211305
MCR-LTD		
PVC		E211305
MCR-OB		
PVC		E211305
MCR-OE		
PVC		E211305
MCR-PTF		
PVC		E211305
MCR-RDB		
PVC		E211305
MCR-REB		
PVC		E211305
MCR-TE		
PVC		E211305
MCR-TM		
PVC		E211305
MCR-WR		
PVC		E211305
PSR0380		
PVC		E229161
PSR038-45-0500		
PA66		E229161
PSR038-90-0500		
PA66		E229161
PSR038-S-0380		
PA66		E229161
PSR0500		
PVC		E229161
PSR050-45-0500		
PA66		E229161
PSR050-90-0500		
PA66		E229161
PSR050-S-0500		
PA66		E229161
PSR0750		
PVC		E229161
PSR075-45-0750		
PA66		E229161
PSR075-90-0750		
PA66		E229161
PSR075-S-0750		
PA66		E229161

Material	Specifications	File#
PSR1000		
PVC		E229161
PSR100-45-1000		
PA66		E229161
PSR100-90-1000		
PA66		E229161
PSR100-S-1000		
PA66		E229161
PSR1250		
PVC		E229161
PSR125-90-1250		
PA66		E229161
PSR125-S-1250		
PA66		E229161
PSR1500		
PVC		E229161
PSR150-S-1500		
PA66		E229161
PSR2000		
PVC		E229161
SD.5X.5		
PVC	CSA, EN 50085-1:2005 + A1:2013, EN 50085-2-3_1A, UL	E64139
SD.5X1		
PVC	CSA, EN 50085-1:2005 + A1:2013, EN 50085-2-3_1A, UL	E64139
SD.75X.75		
PVC	CSA, EN 50085-1:2005 + A1:2013, EN 50085-2-3_1A, UL	E64139
SD1.5X1		
PVC	CSA, EN 50085-1:2005 + A1:2013, EN 50085-2-3_1A, UL	E64139
SD1.5X1.5		
PVC	CSA, EN 50085-1:2005 + A1:2013, EN 50085-2-3_1A, UL	E64139
SD1.5X2		
PVC	CSA, EN 50085-1:2005 + A1:2013, EN 50085-2-3_1A, UL	E64139
SD1.5X3		
PVC	CSA, EN 50085-1:2005 + A1:2013, EN 50085-2-3_1A, UL	E64139
SD1.5X4		
PVC	CSA, EN 50085-1:2005 + A1:2013, EN 50085-2-3_1A, UL	E64139
SD1X1		
PVC	CSA, EN 50085-1:2005 + A1:2013, EN 50085-2-3_1A, UL	E64139
SD1X1.5		
PVC	CSA, EN 50085-1:2005 + A1:2013, EN 50085-2-3_1A, UL	E64139
SD1X2		
PVC	CSA, EN 50085-1:2005 + A1:2013, EN 50085-2-3_1A, UL	E64139

Standards for HellermannTyton Routing Protection Insulation

Material	Specifications	File#
SD1X3		
PVC	CSA, EN 50085-1:2005 + A1:2013, EN 50085-2-3_1A, UL	E64139
SD1X4		
PVC	CSA, EN 50085-1:2005 + A1:2013, EN 50085-2-3_1A, UL	E64139
SD2.5X3		
PVC	CSA, EN 50085-1:2005 + A1:2013, EN 50085-2-3_1A, UL	E64139
SD2X1		
PVC	CSA, EN 50085-1:2005 + A1:2013, EN 50085-2-3_1A, UL	E64139
SD2X2		
PVC	CSA, EN 50085-1:2005 + A1:2013, EN 50085-2-3_1A, UL	E64139
SD2X3		
PVC	CSA, EN 50085-1:2005 + A1:2013, EN 50085-2-3_1A, UL	E64139
SD2X4		
PVC	CSA, EN 50085-1:2005 + A1:2013, EN 50085-2-3_1A, UL	E64139
SD2X5		
PVC	CSA, EN 50085-1:2005 + A1:2013, EN 50085-2-3_1A, UL	E64139
SD3X1		
PVC	CSA, EN 50085-1:2005 + A1:2013, EN 50085-2-3_1A, UL	E64139
SD3X2		
PVC	CSA, EN 50085-1:2005 + A1:2013, EN 50085-2-3_1A, UL	E64139
SD3X3		
PVC	CSA, EN 50085-1:2005 + A1:2013, EN 50085-2-3_1A, UL	E64139
SD3X4		
PVC	CSA, EN 50085-1:2005 + A1:2013, EN 50085-2-3_1A, UL	E64139
SD3X5		
PVC	CSA, EN 50085-1:2005 + A1:2013, EN 50085-2-3_1A, UL	E64139
SD4X2		
PVC	CSA, EN 50085-1:2005 + A1:2013, EN 50085-2-3_1A, UL	E64139
SD4X3		
PVC	CSA, EN 50085-1:2005 + A1:2013, EN 50085-2-3_1A, UL	E64139
SD4X4		
PVC	CSA, EN 50085-1:2005 + A1:2013, EN 50085-2-3_1A, UL	E64139
SD4X5		
PVC	CSA, EN 50085-1:2005 + A1:2013, EN 50085-2-3_1A, UL	E64139
SD6X4		
PVC	CSA, EN 50085-1:2005 + A1:2013, EN 50085-2-3_1A, UL	E64139

Material	Specifications	File#
SD8X4		
PVC	CSA, EN 50085-1:2005 + A1:2013, EN 50085-2-3_1A, UL	E64139
SDA.75X.75		
PVC	CSA, EN 50085-1:2005 + A1:2013, EN 50085-2-3_1A, UL	E64139
SDA1.5X1		
PVC	CSA, EN 50085-1:2005 + A1:2013, EN 50085-2-3_1A, UL	E64139
SDA1.5X1.5		
PVC	CSA, EN 50085-1:2005 + A1:2013, EN 50085-2-3_1A, UL	E64139
SDA1.5X2		
PVC	CSA, EN 50085-1:2005 + A1:2013, EN 50085-2-3_1A, UL	E64139
SDA1.5X3		
PVC	CSA, EN 50085-1:2005 + A1:2013, EN 50085-2-3_1A, UL	E64139
SDA1.5X4		
PVC	CSA, EN 50085-1:2005 + A1:2013, EN 50085-2-3_1A, UL	E64139
SDA1X1		
PVC	CSA, EN 50085-1:2005 + A1:2013, EN 50085-2-3_1A, UL	E64139
SDA1X1.5		
PVC	CSA, EN 50085-1:2005 + A1:2013, EN 50085-2-3_1A, UL	E64139
SDA1X2		
PVC	CSA, EN 50085-1:2005 + A1:2013, EN 50085-2-3_1A, UL	E64139
SDA1X3		
PVC	CSA, EN 50085-1:2005 + A1:2013, EN 50085-2-3_1A, UL	E64139
SDA1X4		
PVC	CSA, EN 50085-1:2005 + A1:2013, EN 50085-2-3_1A, UL	E64139
SDA2.5X3		
PVC	CSA, EN 50085-1:2005 + A1:2013, EN 50085-2-3_1A, UL	E64139
SDA2X1		
PVC	CSA, EN 50085-1:2005 + A1:2013, EN 50085-2-3_1A, UL	E64139
SDA2X2		
PVC	CSA, EN 50085-1:2005 + A1:2013, EN 50085-2-3_1A, UL	E64139
SDA2X3		
PVC	CSA, EN 50085-1:2005 + A1:2013, EN 50085-2-3_1A, UL	E64139
SDA2X4		
PVC	CSA, EN 50085-1:2005 + A1:2013, EN 50085-2-3_1A, UL	E64139
SDA2X5		
PVC	CSA, EN 50085-1:2005 + A1:2013, EN 50085-2-3_1A, UL	E64139
SDA3X1		
PVC	CSA, EN 50085-1:2005 + A1:2013, EN 50085-2-3_1A, UL	E64139

Standards for HellermannTyton Routing Protection Insulation

Material	Specifications	File#
SDA3X2		
PVC	CSA, EN 50085-1:2005 + A1:2013, EN 50085-2-3_1A, UL	E64139
SDA3X3		
PVC	CSA, EN 50085-1:2005 + A1:2013, EN 50085-2-3_1A, UL	E64139
SDA3X4		
PVC	CSA, EN 50085-1:2005 + A1:2013, EN 50085-2-3_1A, UL	E64139
SDA3X5		
PVC	CSA, EN 50085-1:2005 + A1:2013, EN 50085-2-3_1A, UL	E64139
SDA4X2		
PVC	CSA, EN 50085-1:2005 + A1:2013, EN 50085-2-3_1A, UL	E64139
SDA4X3		
PVC	CSA, EN 50085-1:2005 + A1:2013, EN 50085-2-3_1A, UL	E64139
SDA4X4		
PVC	CSA, EN 50085-1:2005 + A1:2013, EN 50085-2-3_1A, UL	E64139
SDA4X5		
PVC	CSA, EN 50085-1:2005 + A1:2013, EN 50085-2-3_1A, UL	E64139
ShrinkKit 321 Basic		
PO-X	SAE - AMS - DTL-23053/5 Class 1	
ShrinkKit 321 Universal Basic		
PO-X	SAE - AMS - DTL-23053/5 Class 1	
SL1.5X1		
PVC	CSA, EN 50085-1:2005 + A1:2013, EN 50085-2-3_1A, UL	E64139
SL1.5X1.5		
PVC	CSA, EN 50085-1:2005 + A1:2013, EN 50085-2-3_1A, UL	E64139
SL1.5X2		
PVC	CSA, EN 50085-1:2005 + A1:2013, EN 50085-2-3_1A, UL	E64139
SL1.5X3		
PVC	CSA, EN 50085-1:2005 + A1:2013, EN 50085-2-3_1A, UL	E64139
SL1.5X4		
PVC	CSA, EN 50085-1:2005 + A1:2013, EN 50085-2-3_1A, UL	E64139
SL1x1		
PVC	CSA, EN 50085-1:2005 + A1:2013, EN 50085-2-3_1A, UL	E64139
SL1X1.5		
PVC	CSA, EN 50085-1:2005 + A1:2013, EN 50085-2-3_1A, UL	E64139
SL1X2		
PVC	CSA, EN 50085-1:2005 + A1:2013, EN 50085-2-3_1A, UL	E64139
SL1X3		
PVC	CSA, EN 50085-1:2005 + A1:2013, EN 50085-2-3_1A, UL	E64139

Material	Specifications	File#
SL1X4		
PVC	CSA, EN 50085-1:2005 + A1:2013, EN 50085-2-3_1A, UL	E64139
SL2.5X3		
PVC	CSA, EN 50085-1:2005 + A1:2013, EN 50085-2-3_1A, UL	E64139
SL2X1		
PVC	CSA, EN 50085-1:2005 + A1:2013, EN 50085-2-3_1A, UL	E64139
SL2X2		
PVC	CSA, EN 50085-1:2005 + A1:2013, EN 50085-2-3_1A, UL	E64139
SL2X3		
PVC	CSA, EN 50085-1:2005 + A1:2013, EN 50085-2-3_1A, UL	E64139
SL2X4		
PVC	CSA, EN 50085-1:2005 + A1:2013, EN 50085-2-3_1A, UL	E64139
SL2X5		
PVC	CSA, EN 50085-1:2005 + A1:2013, EN 50085-2-3_1A, UL	E64139
SL3X1		
PVC	CSA, EN 50085-1:2005 + A1:2013, EN 50085-2-3_1A, UL	E64139
SL3X2		
PVC	CSA, EN 50085-1:2005 + A1:2013, EN 50085-2-3_1A, UL	E64139
SL3X3		
PVC	CSA, EN 50085-1:2005 + A1:2013, EN 50085-2-3_1A, UL	E64139
SL3X4		
PVC	CSA, EN 50085-1:2005 + A1:2013, EN 50085-2-3_1A, UL	E64139
SL3X5		
PVC	CSA, EN 50085-1:2005 + A1:2013, EN 50085-2-3_1A, UL	E64139
SL4X2		
PVC	CSA, EN 50085-1:2005 + A1:2013, EN 50085-2-3_1A, UL	E64139
SL4X3		
PVC	CSA, EN 50085-1:2005 + A1:2013, EN 50085-2-3_1A, UL	E64139
SL4X4		
PVC	CSA, EN 50085-1:2005 + A1:2013, EN 50085-2-3_1A, UL	E64139
SL4X5		
PVC	CSA, EN 50085-1:2005 + A1:2013, EN 50085-2-3_1A, UL	E64139
SLA1.5X1		
PVC	CSA, EN 50085-1:2005 + A1:2013, EN 50085-2-3_1A, UL	E64139
SLA1.5X1.5		
PVC	CSA, EN 50085-1:2005 + A1:2013, EN 50085-2-3_1A, UL	E64139
SLA1.5X2		
PVC	CSA, EN 50085-1:2005 + A1:2013, EN 50085-2-3_1A, UL	E64139

Standards for HellermannTyton Routing Protection Insulation

Material	Specifications	File#
SLA1.5X3		
PVC	CSA, EN 50085-1:2005 + A1:2013, EN 50085-2-3_1A, UL	E64139
SLA1.5X4		
PVC	CSA, EN 50085-1:2005 + A1:2013, EN 50085-2-3_1A, UL	E64139
SLA1X1		
PVC	CSA, EN 50085-1:2005 + A1:2013, EN 50085-2-3_1A, UL	E64139
SLA1X1.5		
PVC	CSA, EN 50085-1:2005 + A1:2013, EN 50085-2-3_1A, UL	E64139
SLA1X2		
PVC	CSA, EN 50085-1:2005 + A1:2013, EN 50085-2-3_1A, UL	E64139
SLA1X3		
PVC	CSA, EN 50085-1:2005 + A1:2013, EN 50085-2-3_1A, UL	E64139
SLA1X4		
PVC	CSA, EN 50085-1:2005 + A1:2013, EN 50085-2-3_1A, UL	E64139
SLA2.5X3		
PVC	CSA, EN 50085-1:2005 + A1:2013, EN 50085-2-3_1A, UL	E64139
SLA2X1		
PVC	CSA, EN 50085-1:2005 + A1:2013, EN 50085-2-3_1A, UL	E64139
SLA2X2		
PVC	CSA, EN 50085-1:2005 + A1:2013, EN 50085-2-3_1A, UL	E64139
SLA2X3		
PVC	CSA, EN 50085-1:2005 + A1:2013, EN 50085-2-3_1A, UL	E64139
SLA2X4		
PVC	CSA, EN 50085-1:2005 + A1:2013, EN 50085-2-3_1A, UL	E64139
SLA2X5		
PVC	CSA, EN 50085-1:2005 + A1:2013, EN 50085-2-3_1A, UL	E64139
SLA3X1		
PVC	CSA, EN 50085-1:2005 + A1:2013, EN 50085-2-3_1A, UL	E64139
SLA3X2		
PVC	CSA, EN 50085-1:2005 + A1:2013, EN 50085-2-3_1A, UL	E64139
SLA3X3		
PVC	CSA, EN 50085-1:2005 + A1:2013, EN 50085-2-3_1A, UL	E64139
SLA3X4		
PVC	CSA, EN 50085-1:2005 + A1:2013, EN 50085-2-3_1A, UL	E64139
SLA3X5		
PVC	CSA, EN 50085-1:2005 + A1:2013, EN 50085-2-3_1A, UL	E64139

Material	Specifications	File#
SLA4X2		
PVC	CSA, EN 50085-1:2005 + A1:2013, EN 50085-2-3_1A, UL	E64139
SLA4X3		
PVC	CSA, EN 50085-1:2005 + A1:2013, EN 50085-2-3_1A, UL	E64139
SLA4X4		
PVC	CSA, EN 50085-1:2005 + A1:2013, EN 50085-2-3_1A, UL	E64139
SLA4X5		
PVC	CSA, EN 50085-1:2005 + A1:2013, EN 50085-2-3_1A, UL	E64139
SLHD1.5X1		
PVC	CSA, EN 50085-1:2005 + A1:2013, EN 50085-2-3_1A, UL	E64139
SLHD1.5X1.5		
PVC	CSA, EN 50085-1:2005 + A1:2013, EN 50085-2-3_1A, UL	E64139
SLHD1.5X2		
PVC	CSA, EN 50085-1:2005 + A1:2013, EN 50085-2-3_1A, UL	E64139
SLHD1.5X3		
PVC	CSA, EN 50085-1:2005 + A1:2013, EN 50085-2-3_1A, UL	E64139
SLHD1.5X4		
PVC	CSA, EN 50085-1:2005 + A1:2013, EN 50085-2-3_1A, UL	E64139
SLHD1X1		
PVC	CSA, EN 50085-1:2005 + A1:2013, EN 50085-2-3_1A, UL	E64139
SLHD1X1.5		
PVC	CSA, EN 50085-1:2005 + A1:2013, EN 50085-2-3_1A, UL	E64139
SLHD1X2		
PVC	CSA, EN 50085-1:2005 + A1:2013, EN 50085-2-3_1A, UL	E64139
SLHD1X3		
PVC	CSA, EN 50085-1:2005 + A1:2013, EN 50085-2-3_1A, UL	E64139
SLHD1X4		
PVC	CSA, EN 50085-1:2005 + A1:2013, EN 50085-2-3_1A, UL	E64139
SLHD2.5X3		
PVC	CSA, EN 50085-1:2005 + A1:2013, EN 50085-2-3_1A, UL	E64139
SLHD2X1		
PVC	CSA, EN 50085-1:2005 + A1:2013, EN 50085-2-3_1A, UL	E64139
SLHD2X2		
PVC	CSA, EN 50085-1:2005 + A1:2013, EN 50085-2-3_1A, UL	E64139
SLHD2X3		
PVC	CSA, EN 50085-1:2005 + A1:2013, EN 50085-2-3_1A, UL	E64139

Appendix

Product Approvals and Specifications

Standards for HellermannTyton Routing Protection Insulation

Material	Specifications	File#
SLHD2X4		
PVC	CSA, EN 50085-1:2005 + A1:2013, EN 50085-2-3_1A, UL	E64139
SLHD2X5		
PVC	CSA, EN 50085-1:2005 + A1:2013, EN 50085-2-3_1A, UL	E64139
SLHD3X1		
PVC	CSA, EN 50085-1:2005 + A1:2013, EN 50085-2-3_1A, UL	E64139
SLHD3X2		
PVC	CSA, EN 50085-1:2005 + A1:2013, EN 50085-2-3_1A, UL	E64139
SLHD3X3		
PVC	CSA, EN 50085-1:2005 + A1:2013, EN 50085-2-3_1A, UL	E64139
SLHD3X4		
PVC	CSA, EN 50085-1:2005 + A1:2013, EN 50085-2-3_1A, UL	E64139
SLHD3X5		
PVC	CSA, EN 50085-1:2005 + A1:2013, EN 50085-2-3_1A, UL	E64139
SLHD4X2		
PVC	CSA, EN 50085-1:2005 + A1:2013, EN 50085-2-3_1A, UL	E64139
SLHD4X3		
PVC	CSA, EN 50085-1:2005 + A1:2013, EN 50085-2-3_1A, UL	E64139
SLHD4X4		
PVC	CSA, EN 50085-1:2005 + A1:2013, EN 50085-2-3_1A, UL	E64139
SLHD4X5		
PVC	CSA, EN 50085-1:2005 + A1:2013, EN 50085-2-3_1A, UL	E64139
SLHDA1.5X1		
PVC	CSA, EN 50085-1:2005 + A1:2013, EN 50085-2-3_1A, UL	E64139
SLHDA1.5X1.5		
PVC	CSA, EN 50085-1:2005 + A1:2013, EN 50085-2-3_1A, UL	E64139
SLHDA1.5X2		
PVC	CSA, EN 50085-1:2005 + A1:2013, EN 50085-2-3_1A, UL	E64139
SLHDA1.5X3		
PVC	CSA, EN 50085-1:2005 + A1:2013, EN 50085-2-3_1A, UL	E64139
SLHDA1.5X4		
PVC	CSA, EN 50085-1:2005 + A1:2013, EN 50085-2-3_1A, UL	E64139
SLHDA1X1		
PVC	CSA, EN 50085-1:2005 + A1:2013, EN 50085-2-3_1A, UL	E64139
SLHDA1X1.5		
PVC	CSA, EN 50085-1:2005 + A1:2013, EN 50085-2-3_1A, UL	E64139

Material	Specifications	File#
SLHDA1X2		
PVC	CSA, EN 50085-1:2005 + A1:2013, EN 50085-2-3_1A, UL	E64139
SLHDA1X3		
PVC	CSA, EN 50085-1:2005 + A1:2013, EN 50085-2-3_1A, UL	E64139
SLHDA1X4		
PVC	CSA, EN 50085-1:2005 + A1:2013, EN 50085-2-3_1A, UL	E64139
SLHDA2.5X3		
PVC	CSA, EN 50085-1:2005 + A1:2013, EN 50085-2-3_1A, UL	E64139
SLHDA2X1		
PVC	CSA, EN 50085-1:2005 + A1:2013, EN 50085-2-3_1A, UL	E64139
SLHDA2X2		
PVC	CSA, EN 50085-1:2005 + A1:2013, EN 50085-2-3_1A, UL	E64139
SLHDA2X3		
PVC	CSA, EN 50085-1:2005 + A1:2013, EN 50085-2-3_1A, UL	E64139
SLHDA2X4		
PVC	CSA, EN 50085-1:2005 + A1:2013, EN 50085-2-3_1A, UL	E64139
SLHDA2X5		
PVC	CSA, EN 50085-1:2005 + A1:2013, EN 50085-2-3_1A, UL	E64139
SLHDA3X1		
PVC	CSA, EN 50085-1:2005 + A1:2013, EN 50085-2-3_1A, UL	E64139
SLHDA3X2		
PVC	CSA, EN 50085-1:2005 + A1:2013, EN 50085-2-3_1A, UL	E64139
SLHDA3X3		
PVC	CSA, EN 50085-1:2005 + A1:2013, EN 50085-2-3_1A, UL	E64139
SLHDA3X4		
PVC	CSA, EN 50085-1:2005 + A1:2013, EN 50085-2-3_1A, UL	E64139
SLHDA3X5		
PVC	CSA, EN 50085-1:2005 + A1:2013, EN 50085-2-3_1A, UL	E64139
SLHDA4X2		
PVC	CSA, EN 50085-1:2005 + A1:2013, EN 50085-2-3_1A, UL	E64139
SLHDA4X3		
PVC	CSA, EN 50085-1:2005 + A1:2013, EN 50085-2-3_1A, UL	E64139
SLHDA4X4		
PVC	CSA, EN 50085-1:2005 + A1:2013, EN 50085-2-3_1A, UL	E64139
SLHDA4X5		
PVC	CSA, EN 50085-1:2005 + A1:2013, EN 50085-2-3_1A, UL	E64139

Standards for HellermannTyton Routing Protection Insulation

Material	Specifications	File#
TAN33-ST-12/4 BK		
PO-X	CSA	E125182
TAN33-ST-19/6 BK		
PO-X	CSA	E125182
TAN33-ST-24/8 BK		
PO-X	CSA	E125182
TAN33-ST-3/1 BK		
PO-X	CSA	E125182
TAN33-ST-4.8/1.5 BK		
PO-X	CSA	E125182
TAN33-ST-40/13 BK		
PO-X	CSA	E125182
TAN33-ST-6/2 BK		
PO-X	CSA	E125182
TAN33-ST-9/3 BK		
PO-X	CSA	E125182
TC.5		
PVC	CSA, EN 50085-1:2005 + A1:2013, EN 50085-2-3_1A, UL	E64139
TC.75		
PVC	CSA, EN 50085-1:2005 + A1:2013, EN 50085-2-3_1A, UL	E64139
TC1		
PVC	CSA, EN 50085-1:2005 + A1:2013, EN 50085-2-3_1A, UL	E64139
TC1.5		
PVC	CSA, EN 50085-1:2005 + A1:2013, EN 50085-2-3_1A, UL	E64139
TC2		
PVC	CSA, EN 50085-1:2005 + A1:2013, EN 50085-2-3_1A, UL	E64139
TC2.5		
PVC	CSA, EN 50085-1:2005 + A1:2013, EN 50085-2-3_1A, UL	E64139
TC3		
PVC	CSA, EN 50085-1:2005 + A1:2013, EN 50085-2-3_1A, UL	E64139
TC4		
PVC	CSA, EN 50085-1:2005 + A1:2013, EN 50085-2-3_1A, UL	E64139
TC6		
PVC	CSA, EN 50085-1:2005 + A1:2013, EN 50085-2-3_1A, UL	E64139
TC8		
PVC	CSA, EN 50085-1:2005 + A1:2013, EN 50085-2-3_1A, UL	E64139
TCN20-1.6/0.8		
PO-X	C22.2 no. 198.1-06, UL 224 125 °C 600V VW-1	E143529
TCN20-12.7/6.4		
PO-X	C22.2 no. 198.1-06, UL 224 125 °C 600V VW-1	E143529

Material	Specifications	File#
TCN20-19.1/9.5		
PO-X	C22.2 no. 198.1-06, UL 224 125 °C 600V VW-1	E143529
TCN20-2.4/1.2		
PO-X	C22.2 no. 198.1-06, UL 224 125 °C 600V VW-1	E143529
TCN20-25.4/12.7		
PO-X	C22.2 no. 198.1-06, UL 224 125 °C 600V VW-1	E143529
TCN20-3.2/1.6		
PO-X	C22.2 no. 198.1-06, UL 224 125 °C 600V VW-1	E143529
TCN20-38.1/19.1		
PO-X	C22.2 no. 198.1-06, UL 224 125 °C 600V VW-1	E143529
TCN20-4.8/2.4		
PO-X	C22.2 no. 198.1-06, UL 224 125 °C 600V VW-1	E143529
TCN20-50.8/25.4		
PO-X	C22.2 no. 198.1-06, UL 224 125 °C 600V VW-1	E143529
TCN20-9.5/4.8		
PO-X	C22.2 no. 198.1-06, UL 224 125 °C 600V VW-1	E143529
TFN21 1.2/0.6		
PO-X	ANSI/UL 224, CSA	E143529
TFN21 1.6/0.8		
PO-X	ANSI/UL 224, CSA	E143529
TFN21 102.0/50.8		
PO-X	ANSI/UL 224, CSA	E143529
TFN21 12.7/6.4		
PO-X	ANSI/UL 224, CSA	E143529
TFN21 16.0/8.0		
PO-X	ANSI/UL 224, CSA	E143529
TFN21 19.1/9.5		
PO-X	ANSI/UL 224, CSA	E143529
TFN21 2.4/1.2		
PO-X	ANSI/UL 224, CSA	E143529
TFN21 25.4/12.7		
PO-X	ANSI/UL 224, CSA	E143529
TFN21 3.2/1.6		
PO-X	ANSI/UL 224, CSA	E143529
TFN21 31.8/16.0		
PO-X	ANSI/UL 224, CSA	E143529
TFN21 38.1/19.1		
PO-X	ANSI/UL 224, CSA	E143529
TFN21 4.8/2.4		
PO-X	ANSI/UL 224, CSA	E143529
TFN21 50.8/25.4		
PO-X	ANSI/UL 224, CSA	E143529

Standards for HellermannTyton Routing Protection Insulation

Material	Specifications	File#
TFN21 6.4/3.2		
PO-X	ANSI/UL 224, CSA	E143529
TFN21 76.2/38.1		
PO-X	ANSI/UL 224, CSA	E143529
TFN21 9.5/4.8		
PO-X	ANSI/UL 224, CSA	E143529
TFN21-ST 1.6/0.8		
PO-X	ANSI/UL 224, CSA	E143529
TFN21-ST 102/50.8		
PO-X	ANSI/UL 224, CSA	E143529
TFN21-ST 12.7/6.4		
PO-X	ANSI/UL 224, CSA	E143529
TFN21-ST 19.1/9.5		
PO-X	ANSI/UL 224, CSA	E143529
TFN21-ST 2.4/1.2		
PO-X	ANSI/UL 224, CSA	E143529
TFN21-ST 25.4/12.7		
PO-X	ANSI/UL 224, CSA	E143529
TFN21-ST 3.2/1.6		
PO-X	ANSI/UL 224, CSA	E143529
TFN21-ST 31.8/16.0		
PO-X	ANSI/UL 224, CSA	E143529
TFN21-ST 38.1/19.1		
PO-X	ANSI/UL 224, CSA	E143529
TFN21-ST 4.8/2.4		
PO-X	ANSI/UL 224, CSA	E143529
TFN21-ST 50.8/25.4		
PO-X	ANSI/UL 224, CSA	E143529
TFN21-ST 6.4/3.2		
PO-X	ANSI/UL 224, CSA	E143529
TFN21-ST 76.2/38.1		
PO-X	ANSI/UL 224, CSA	E143529
TFN21-ST 9.5/4.8		
PO-X	ANSI/UL 224, CSA	E143529
TFN31 12/4		
PO-X	ANSI/UL 224, C22.2 no. 198.1-06	E143529
TFN31 18/6		
PO-X	ANSI/UL 224, C22.2 no. 198.1-06	E143529
TFN31 24/8		
PO-X	ANSI/UL 224, C22.2 no. 198.1-06	E143529
TFN31 3/1		
PO-X	ANSI/UL 224, C22.2 no. 198.1-06	E143529
TFN31 39/13		
PO-X	ANSI/UL 224, C22.2 no. 198.1-06	E143529
TFN31 6/2		
PO-X	ANSI/UL 224, C22.2 no. 198.1-06	E143529

Material	Specifications	File#
TFN31 9/3		
PO-X	ANSI/UL 224, C22.2 no. 198.1-06	E143529
TFN31-ST-1.5/0.5		
PO-X	ANSI/UL 224, C22.2 no. 198.1-06	E143529
TFN31-ST-12/4		
PO-X	ANSI/UL 224, C22.2 no. 198.1-06	E143529
TFN31-ST-18/6		
PO-X	ANSI/UL 224, C22.2 no. 198.1-06	E143529
TFN31-ST-24/8		
PO-X	ANSI/UL 224, C22.2 no. 198.1-06	E143529
TFN31-ST-3/1		
PO-X	ANSI/UL 224, C22.2 no. 198.1-06	E143529
TFN31-ST-4.5/1.5		
PO-X	ANSI/UL 224, C22.2 no. 198.1-06	E143529
TFN31-ST-6/2		
PO-X	ANSI/UL 224, C22.2 no. 198.1-06	E143529
TFN31-ST-9/3		
PO-X	ANSI/UL 224, C22.2 no. 198.1-06	E143529
TSRP1-12		
PVC		E211305
TSRP1-14		
PVC		E211305
TSRP1-21-1		
PVC		E211305
TSRP1-25-1		
PVC		E211305
TSRP1-29-1		
PVC		E211305
TSRP1-33-1		
PVC		E211305
TSRP1-36		
PVC		E211305
TSRP1-50		
PVC		E211305
TSRP1-6A		
PVC		E192902
TSRP1-8A		
PVC		E192902
TSRP2-12		
PVC		E211305
TSRP2-14		
PVC		E211305
TSRP2-21-1		
PVC		E211305

Standards for HellermannTyton Routing Protection Insulation

Material	Specifications	File#
TSRP2-25-1		
PVC		E211305
TSRP2-29-1		
PVC		E211305
TSRP2-33-1		
PVC		E211305
TSRP2-36		
PVC		E211305
TSRP2-50		
PVC		E211305
TSRP2-6A		
PVC		E192902
TSRP2-8A		
PVC		E192902
TSRP3-12		
PVC		E211305
TSRP3-14		
PVC		E211305
TSRP3-21-1		
PVC		E211305
TSRP3-25-1		
PVC		E211305
TSRP3-29-1		
PVC		E211305
TSRP3-33-1		
PVC		E211305
TSRP3-36		
PVC		E211305
TSRP3-50		
PVC		E211305
TSRP3-6A		
PVC		E192902
TSRP3-8A		
PVC		E192902
TSRPFW-RB		
PVC		E211305
TSRPI-RB		
PVC		E211305
TSRP-JB1		
PVC		E211305
TSRP-JB2		
PVC		E211305
TSRP-JB3		
PVC		E211305
TSRP-JBD		
PVC		E211305
TSRP-JBD2		
PVC		E211305
TSRPW-RB		
PVC		E211305

Appendix

Product Approvals and Specifications

Standards for HellermannTyton Identification

Material	Color (short)	Specifications	File#
120VOLT			
443/552	OG	NEC2017, UL 969	MH11410
120VOLT10			
443/552	OG	NEC2017, UL 969	MH11410
120VOLTM5			
AA	OG	NEC2017	
120VOLTS			
443/552	OG	UL 969	MH11410
175REF			
100	WH		MH18396
3X2CAUTION			
PET	YE		MH16736
3X2CAUTIONUV			
PET	YE	ANSI Standard Z535.4, CSA 66956, IFC 2012, NEC2011, NEC2014, UL 969	MH16736
3X2DANGER			
PET	RD		MH16736
3X2DANGERUV			
PET	RD	ANSI Standard Z535.4, CSA 66956, IFC 2012, NEC2011, NEC2014, UL 969	MH16736
3X2NOTICE			
PET	BU		MH16736
3X2SAFETY			
PET	GN		MH16736
3X2WARNING			
PET	OG		MH16736
3X2WARNINGUV			
PET	OG	ANSI Standard Z535.4, CSA 66956, IFC 2012, NEC2011, NEC2014, UL 969	MH16736
4X6CAUTION			
PET	YE		MH16736
4X6CAUTIONUV			
PET	YE	ANSI Standard Z535.4, CSA 66956, IFC 2012, NEC2011, NEC2014, UL 969	MH16736
4X6DANGER			
PET	RD		MH16736
4X6DANGERUV			
PET	RD	ANSI Standard Z535.4, CSA 66956, IFC 2012, NEC2011, NEC2014, UL 969	MH16736
4X6NOTICE			
PET	BU		MH16736
4X6SAFETY			
PET	GN		MH16736
4X6WARNING			
PET	OG		MH16736

Material	Color (short)	Specifications	File#
4X6WARNINGUV			
PET	OG	ANSI Standard Z535.4, CSA 66956, IFC 2012, NEC2011, NEC2014, UL 969	MH16736
514REF			
100	WH		MH18396
AC2011			
840/926	RD	CSA 66956, IFC 2012, NEC2011, UL 969	MH16736
AC2011-1			
840/926	RD	UL 969	MH16736
AC201110			
840/926	RD	CSA 66956, NEC2017, UL 969	MH16736
AC2011M5			
AA	BK	NEC2014, NEC2017	
AC2011M5ENG			
AA	BK	NEC2014, NEC2017	
AC2011S			
840/926	RD	CSA 66956	MH16736
ACCB			
V	RD		MH11410
ACCB10			
443/552	RD	NEC2014	MH16736
ACDISC-1			
840/926	RD	UL 969	MH16736
ACDISCS			
840/926	RD	CSA 66956	MH16736
ACDISCT			
840/926	RD	CSA 66956, IFC 2012, NEC2011, UL 969	MH16736
ACDISCT10			
840/926	RD	CSA 66956, NEC2017, UL 969	MH16736
ACDISCTM5			
AA	BK	NEC2014, NEC2017	
ACRATING			
840/926	RD	CSA 66956, IFC 2012, NEC2011, UL 969	MH16736
AF5X35D			
840/926	RD		MH11410
AF5X35W			
840/926	OG		MH11410
BIPOLARPV			
443/552	OG	UL 969	MH11410
BIPOLARPV10			
443/552	OG	NEC2014	MH11410
BIPOLARPVM5			
AA	OG	NEC2014	
BLANK2X125			
AA	BK	NEC2014, NEC2017	

Standards for HellermannTyton Identification

Material	Color (short)	Specifications	File#
BLANK375X2			
AA	BK	NEC2014, NEC2017	
BLANK4X75			
AA	BK	NEC2014, NEC2017	
CBACKFED			
443/552	RD	UL 969	MH11410
	YE	NEC2017, UL 969	
CBACKFED10			
443/552	YE	NEC2017, UL 969	MH11410
CBACKFEDM5			
AA	YE	NEC2017	
CBACKFEDS			
443/552	OG	UL 969	MH11410
	YE		
CSCIRLBL			
242/552	YE	ANSI Standard Z535.4, IFC 2012, NEC2011, NEC2014, UL 969	MH16736
CSCIRLBL10			
242/552	YE	NEC2014	MH11410
CSCSNAP4R			
V	RDRF	IFC 2012, NEC2011	
CSCSNAP72R			
V	RDRF	IFC 2012, NEC2011	
CSESC			
242/552	RD	IFC 2012, NEC2011, UL 969	MH11410
	YE	ANSI Standard Z535.4, IFC 2012, NEC2011, NEC2014, UL 969	MH16736
CSESC10			
242/552	YE	NEC2014	MH11410
CSESCS			
242/552	YE		MH16736
DC2011			
840/926	RD	CSA 66956, IFC 2012, NEC2011, UL 969	MH16736
DC2011-1			
840/926	RD	UL 969	MH16736
DC201110			
840/926	RD	CSA 66956, NEC2014	MH16736
DC2011M5			
AA	BK	NEC2014	
DC2011M5ENG			
AA	BK	NEC2014	
DC20115			
840/926	RD	CSA 66956, UL 969	MH16736
DC2017			
840/926	RD	CSA 66956, IFC 2012, NEC2017, UL 969	MH16736
DC201710			
840/926	RD	CSA 66956, NEC2017, UL 969	MH16736

Material	Color (short)	Specifications	File#
DC2017M5			
AA	BK	NEC2017	
DC2017M5ENG			
AA	BK	NEC2017	
DCCB			
V	RD		MH11410
DCCB10			
443/552	RD	NEC2014	MH16736
DCD			
V	RD		MH11410
DCD10			
443/552	RD		MH16736
DCDISC-1			
840/926	RD	UL 969	MH16736
DCDISCS			
840/926	RD	CSA 66956, UL 969	MH16736
DCDISCT			
840/926	RD	CSA 66956, IFC 2012, NEC2011, UL 969	MH16736
DCDISCT10			
840/926	RD	CSA 66956, NEC2017, UL 969	MH16736
DCDISCTM5			
AA	BK	NEC2014, NEC2017	
DCDISCTM5ENG			
AA	BK	NEC2014, NEC2017	
DCJB			
V	RD		MH11410
DCJB10			
443/552	RD	NEC2014	MH16736
DCRATING			
840/926	RD	CSA 66956, IFC 2012, NEC2011, UL 969	MH16736
DCRATING-1			
840/926	RD	UL 969	MH16736
DCRATING10			
840/926	RD	CSA 66956, NEC2014	MH16736
DCRATINGM5			
AA	BK	NEC2014	
DCRATINGM5ENG			
AA	BK	NEC2014	
DNALP			
V	RD		MH11410
DNDCUL			
242/552	RD	IFC 2012, NEC2011, NEC2017, UL 969	MH16736
DNDCUL10			
242/552	RD	NEC2017, UL 969	MH16736
DS275X135			
PET	RD		MH16736

Appendix

Product Approvals and Specifications

Standards for HellermannTyton Identification

Material	Color (short)	Specifications	File#
DS55X275			
PET	RD		MH16736
DV275X135			
PET	RD		MH16736
DV55X275			
PET	RD		MH16736
ECCMPV			
V	RD		MH11410
ECCMPV10			
443/552	RD	NEC2014	MH11410
ESSDCD			
443/552	RD	NEC2017, UL 969	MH11410
HFST39-13WH-S			
PO-X	WH	SAE - AMS - DTL-23053/5 Class 1 and 3, SAE - AS81531 , UL 224 125 °C 600V VW-1	
HFST39-13YE			
PO-X	YE	SAE - AMS - DTL-23053/5 Class 1 and 3, SAE - AS81531 , UL 224 125 °C 600V VW-1	
HFST39-13YE-S			
PO-X	YE	SAE - AMS - DTL-23053/5 Class 1 and 3, SAE - AS81531 , UL 224 125 °C 600V VW-1	
HL2X2YE			
PET	YE		MH16736
HL3X3YE			
PET	YE		MH16736
HST12-4BK			
PO-X	BK	UL 224 125 °C 600V VW-1	
HST12-4WH			
PO-X	WH	UL 224 125 °C 600V VW-1	
HST12-4WH-3S			
PO-X	WH	UL 224 125 °C 600V VW-1	
HST12-4WHAP			
PO-X	WH	UL 224 125 °C 600V VW-1	
HST12-4WH-S			
PO-X	WH	UL 224 125 °C 600V VW-1	
HST12-4YE			
PO-X	YE	UL 224 125 °C 600V VW-1	
HST12-4YE-3S			
PO-X	YE	UL 224 125 °C 600V VW-1	
HST12-4YE-S			
PO-X	YE	UL 224 125 °C 600V VW-1	
HST18-6BK			
PO-X	BK	UL 224 125 °C 600V VW-1	
HST18-6BK-S			
PO-X	BK	UL 224 125 °C 600V VW-1	
HST18-6WH			
PO-X	WH	UL 224 125 °C 600V VW-1	

Material	Color (short)	Specifications	File#
HST18-6WH-S			
PO-X	WH	UL 224 125 °C 600V VW-1	
HST18-6YE			
PO-X	YE	UL 224 125 °C 600V VW-1	
HST18-6YE-S			
PO-X	YE	UL 224 125 °C 600V VW-1	
HST24-8BK			
PO-X	BK	UL 224 125 °C 600V VW-1	
HST24-8BK-S			
PO-X	BK	UL 224 125 °C 600V VW-1	
HST24-8WH			
PO-X	WH	UL 224 125 °C 600V VW-1	
HST24-8WH-S			
PO-X	WH	UL 224 125 °C 600V VW-1	
HST24-8YE			
PO-X	YE	UL 224 125 °C 600V VW-1	
HST24-8YE-S			
PO-X	YE	UL 224 125 °C 600V VW-1	
HST3-1BK			
PO-X	BK	UL 224 125 °C 600V	
HST3-1BK-2S			
PO-X	BK	UL 224 125 °C 600V VW-1	
HST3-1BK-3S			
PO-X	BK	UL 224 125 °C 600V VW-1	
HST3-1BK-S			
PO-X	BK	UL 224 125 °C 600V VW-1	
HST3-1WH			
PO-X	WH	UL 224 125 °C 600V VW-1 CEN	
HST3-1WH-2S			
PO-X	WH	CEN, SAE - AMS - DTL-23053/5 Class 1 and 3, SAE - AS81531 CEN	
HST3-1WH-3S			
PO-X	WH	CEN	
HST3-1WH-S			
PO-X	WH	UL 224 125 °C 600V VW-1 CEN	
HST3-1YE			
PO-X	YE	UL 224 125 °C 600V VW-1	
HST3-1YE-2S			
PO-X	YE	CEN, SAE - AMS - DTL-23053/5 Class 1 and 3, SAE - AS81531 CEN	
HST3-1YE-S			
PO-X	YE	UL 224 125 °C 600V VW-1 CEN, SAE - AMS - DTL-23053/5 Class 1 and 3, SAE - AS81531	

Standards for HellermannTyton Identification

Material	Color (short)	Specifications	File#
HST39-13WH			
PO-X	WH	SAE - AMS - DTL-23053/5 Class 1 and 3, SAE - AS81531 , UL 224 125 °C 600V VW-1	
HST4.8-1.6BK			
PO-X	BK	SAE - AMS - DTL-23053/5 Class 1 and 3, SAE - AS81531 , UL 224 125 °C 600V VW-1	
HST4.8-1.6BK-3S			
PO-X	BK	SAE - AMS - DTL-23053/5 Class 1 and 3, SAE - AS81531 , UL 224 125 °C 600V VW-1	
HST4.8-1.6WH			
PO-X	WH	SAE - AMS - DTL-23053/5 Class 1 and 3, SAE - AS81531 , UL 224 125 °C 600V VW-1	
		CEN	
		UL 224 125 °C 600V VW-1	
		SAE - AMS - DTL-23053/5 Class 1 and 3, SAE - AS81531 , UL 224 125 °C 600V VW-1	
HST4.8-1.6WH-2S			
PO-X	WH	CEN	
HST4.8-1.6WH-3S			
PO-X	WH	CEN, UL 224 125 °C 600V VW-1	
		CEN	
HST4.8-1.6WHAP			
PO-X	WH	SAE - AMS - DTL-23053/5 Class 1 and 3, SAE - AS81531 , UL 224 125 °C 600V VW-1	
HST4.8-1.6WH-S			
PO-X	WH	SAE - AMS - DTL-23053/5 Class 1 and 3, SAE - AS81531 , UL 224 125 °C 600V VW-1	
		CEN	
		SAE - AMS - DTL-23053/5 Class 1 and 3, SAE - AS81531 , UL 224 125 °C 600V VW-1	
		CEN	
HST4.8-1.6YE			
PO-X	YE	SAE - AMS - DTL-23053/5 Class 1 and 3, SAE - AS81531 , UL 224 125 °C 600V VW-1	
HST4.8-1.6YE-2S			
PO-X	YE	CEN, SAE - AMS - DTL-23053/5 Class 1 and 3, SAE - AS81531	
HST4.8-1.6YE-S			
PO-X	YE	SAE - AMS - DTL-23053/5 Class 1 and 3, SAE - AS81531 , UL 224 125 °C 600V VW-1	
HST4.8-1YE-3S			
PO-X	YE	SAE - AMS - DTL-23053/5 Class 1 and 3, SAE - AS81531 , UL 224 125 °C 600V VW-1	

Material	Color (short)	Specifications	File#
HST6-2BK			
PO-X	BK	SAE - AMS - DTL-23053/5 Class 1 and 3, SAE - AS81531 , UL 224 125 °C 600V VW-1	
HST6-2BK-2S			
PO-X	BK	SAE - AMS - DTL-23053/5 Class 1 and 3, SAE - AS81531 , UL 224 125 °C 600V VW-1	
HST6-2BK-3S			
PO-X	BK	SAE - AMS - DTL-23053/5 Class 1 and 3, SAE - AS81531 , UL 224 125 °C 600V VW-1	
HST6-2WH			
PO-X	WH	SAE - AMS - DTL-23053/5 Class 1 and 3, SAE - AS81531 , UL 224 125 °C 600V VW-1	
HST6-2WH-2S			
PO-X	WH	CEN	
HST6-2WH-3S			
PO-X	WH	CEN	
HST6-2WHAP			
PO-X	WH	SAE - AMS - DTL-23053/5 Class 1 and 3, SAE - AS81531 , UL 224 125 °C 600V VW-1	
HST6-2WH-S			
PO-X	WH	SAE - AMS - DTL-23053/5 Class 1 and 3, SAE - AS81531 , UL 224 125 °C 600V VW-1	
		CEN	
		SAE - AMS - DTL-23053/5 Class 1 and 3, SAE - AS81531 , UL 224 125 °C 600V VW-1	
HST6-2YE			
PO-X	YE	SAE - AMS - DTL-23053/5 Class 1 and 3, SAE - AS81531 , UL 224 125 °C 600V VW-1	
HST6-2YE-2S			
PO-X	YE	CEN, SAE - AMS - DTL-23053/5 Class 1 and 3, SAE - AS81531	
HST6-2YE-3S			
PO-X	YE	CEN	
HST6-2YE-S			
PO-X	YE	SAE - AMS - DTL-23053/5 Class 1 and 3, SAE - AS81531 , UL 224 125 °C 600V VW-1	
		CEN	
HST9-3BK			
PO-X	BK	SAE - AMS - DTL-23053/5 Class 1 and 3, SAE - AS81531 , UL 224 125 °C 600V VW-1	
HST9-3BK-3S			
PO-X	BK	SAE - AMS - DTL-23053/5 Class 1 and 3, SAE - AS81531 , UL 224 125 °C 600V VW-1	

Appendix

Product Approvals and Specifications

Standards for HellermannTyton Identification

Material	Color (short)	Specifications	File#
HST9-3WH			
PO-X	WH	SAE - AMS - DTL-23053/5 Class 1 and 3, SAE - AS81531 , UL 224 125 °C 600V VW-1	
HST9-3WH-2S			
PO-X	WH	SAE - AMS - DTL-23053/5 Class 1 and 3, SAE - AS81531 , UL 224 125 °C 600V VW-1	
HST9-3WH-3S			
PO-X	WH	CEN	
HST9-3WHAP			
PO-X	WH	SAE - AMS - DTL-23053/5 Class 1 and 3, SAE - AS81531 , UL 224 125 °C 600V VW-1	
HST9-3WH-S			
PO-X	WH	SAE - AMS - DTL-23053/5 Class 1 and 3, SAE - AS81531 , UL 224 125 °C 600V VW-1	
HST9-3YE			
PO-X	YE	SAE - AMS - DTL-23053/5 Class 1 and 3, SAE - AS81531 , UL 224 125 °C 600V VW-1	
HST9-3YE-S			
PO-X	YE	SAE - AMS - DTL-23053/5 Class 1 and 3, SAE - AS81531 , UL 224 125 °C 600V VW-1	
HT1BK250			
V	BK	UL 969	MH18396
HT1BU250			
V	BU	UL 969	
HT1GN250			
V	GN	UL 969	
HT1OE250			
V	OG	UL 969	
HT1RD250			
V	RD	UL 969	MH18396
HT1RDHB250			
840/926	RD	ANSI Standard Z535.4, CSA 66956, IFC 2012, NEC2011, NEC2014, UL 969	MH18396
HT1RDRF250			
V	RDRF	UL 969	
HT1WH250			
V	WH	UL 969	MH18396
HT1YE250			
V	YE	UL 969	MH18396
HT2BK250			
V	BK	UL 969	MH18396
HT2BU250			
V	BU	UL 969	
HT2GN250			
V	GN	UL 969	

Material	Color (short)	Specifications	File#
HT2OE250			
V	OG	UL 969	
HT2OE50250			
336/926	OG	CSA, UL 969	MH16736
HT2OE50250UV			
840/926	OG	ANSI Standard Z535.4, CSA 66956, IFC 2012, NEC2011, NEC2014, UL 969	MH16736
HT2RD250			
V	RD	UL 969	MH18396
HT2RDHB250			
840/926	RD	ANSI Standard Z535.4, CSA 66956, IFC 2012, NEC2011, NEC2014, UL 969	MH18396
HT2RDRF250			
V	RDRF	UL 969	
HT2WH250			
V	WH	UL 969	MH18396
HT2YE250			
V	YE	UL 969	MH18396
HT2YE50250			
336/926	YE	CSA, UL 969	MH16736
HT3BK250			
V	BK	UL 969	MH18396
HT3BU250			
V	BU	UL 969	
HT3GN250			
V	GN	UL 969	
HT3OE250			
V	OG	UL 969	
HT3OE75250			
336/926	OG	CSA, UL 969	
HT3OE75250UV			
840/926	OG	ANSI Standard Z535.4, CSA 66956, IFC 2012, NEC2011, NEC2014, UL 969	MH16736
HT3RD250			
V	RD	UL 969	MH18396
HT3RDHB250			
840/926	RD	ANSI Standard Z535.4, CSA 66956, IFC 2012, NEC2011, NEC2014, UL 969	MH16736
HT3RDRF250			
V	RDRF	UL 969	MH18396
HT3WH250			
V	WH	UL 969	MH18396
HT3YE250			
V	YE	UL 969	MH18396
HT3YE75250			
336/926	YE	CSA, UL 969	

Standards for HellermannTyton Identification

Material	Color (short)	Specifications	File#
HT4GN250			
V	GN	UL 969	
HT4OE10250			
336/926	OG	CSA, UL 969	
HT4OE10250UV			
840/926	OG	ANSI Standard Z535.4, CSA 66956, IFC 2012, NEC2011, NEC2014, UL 969	MH16736
HT4OE250			
V	OG	UL 969	
HT4RD250			
V	RD	UL 969	MH18396
HT4RDF100			
V	RDRF	UL 969	
HT4WH250			
V	WH	UL 969	MH18396
HT4YE10250			
336/926	YE	CSA, UL 969	
HT4YE250			
V	YE	UL 969	
HTS6-2YE			
PO-X	YE	SAE - AMS - DTL-23053/5 Class 1 and 3, SAE - AS81531 , UL 224 125 °C 600V VW-1	
IOC			
V	YE		MH11410
IOC10			
443/552	YE	NEC2014	MH11410
IOC0D			
443/552	OG	UL 969	MH11410
IOC0D10			
443/552	OG	UL 969	MH11410
IOC0D14			
443/552	OG	UL 969	MH11410
IOC0D17			
443/552	OG	NEC2017, UL 969	MH11410
IOC0D1710			
443/552	OG	NEC2017, UL 969	MH11410
IOC0D17M5			
AA	OG	NEC2017	
IOC0D17ST			
443/552	OG	NEC2017, UL 969	MH11410
IOC0D17ST10			
443/552	OG	NEC2017, UL 969	MH11410
IOC0DM5			
AA	OG	NEC2014	
IOC0DS			
443/552	OG	UL 969	MH11410
LAM1			
443/552	CL	IFC 2012, NEC2011, UL 969	MH11410

Material	Color (short)	Specifications	File#
LAM110			
443/552	CL	NEC2014, NEC2017	MH11410
M-BOSS Compact			
	BU	2006/42/EG, EN 60204-1:2006, EN ISO 12100:2010	
M-BOSS Compact Organiser			
	BU	2006/42/EG, EN 60204-1:2006, EN ISO 12100:2010	
MBSDIS			
840/926	RD	CSA 66956, IFC 2012, NEC2017, UL 969	MH16736
MPVACDIS			
242/552	RD	IFC 2012, NEC2011, NEC2017, UL 969	MH16736
MPVACDIS10			
242/552	RD	NEC2017, UL 969	MH16736
MPVACDISM5			
AA	RD	NEC2017	
MPVSD			
242/552	RD	IFC 2012, NEC2011, NEC2017, UL 969	MH16736
MPVSD10			
242/552	RD	NEC2017, UL 969	MH16736
MPVSDM5			
AA	RD	NEC2017	
PCP2X1			
840W	WH	CSA 66956	MH16736
PCP3X1			
840W	WH	CSA 66956	MH16736
PCP4X3			
840W	WH	CSA 66956	MH16736
PLB3P			
PET	BK		MH18396
PLW3P			
PET	WH		MH16736
PSEWRS			
242/552	RD	ANSI Standard Z535.4, IFC 2012, NEC2011, NEC2014, UL 969	MH16736
PSEWRS10			
242/552	RD	NEC2014	MH16736
PSEWRS17			
242/552	RD	NEC2017	MH16736
PSEWRS1710			
242/552	RD	NEC2017, UL 969	MH16736
PSEWRSS			
242/552	RD	UL 969	MH16736
PSKWH			
V	RD		MH11410
PSKWH10			
443/552	RD	NEC2014	MH11410

Appendix

Product Approvals and Specifications

Standards for HellermannTyton Identification

Material	Color (short)	Specifications	File#
PVACDIS			
840/926	RD	CSA 66956, IFC 2012, NEC2011, UL 969	MH16736
PVACDIS-1			
840/926	RD	UL 969	MH16736
PVACDIS10			
840/926	RD	CSA 66956, NEC2014	MH16736
PVACDIS17			
840/926	RD	CSA 66956	MH16736
PVACDIS1710			
840/926	RD	CSA 66956, NEC2017, UL 969	MH16736
PVACDIS17M5			
AA	BK	NEC2017	
PVACDIS17M5ENG			
AA	BK	NEC2017	
PVACDISM5			
AA	BK	NEC2014	
PVACDISM5ENG			
AA	BK	NEC2014	
PVACDISS			
840/926	RD	CSA 66956, UL 969	MH16736
PVPSR			
242/552	RD	IFC 2012, NEC2011, NEC2017, UL 969	MH16736
PVPSR10			
242/552	RD	NEC2017, UL 969	MH16736
PVPSR500			
242/552	RD	IFC 2012, NEC2011, UL 969	MH16736
PVPSRTM			
242/552	RDRF	IFC 2012, NEC2011, UL 969	MH16736
PVPSSNAP4			
V	RDRF	IFC 2012, NEC2011	
PVPSSNAP72			
V	RDRF	IFC 2012, NEC2011	
PW.25W1			
V	WH	UL-Recognized	MH18396
PW.50W1			
V	WH	UL-Recognized	MH18396
PW.50W2			
V	WH	UL-Recognized	MH18396
PW2.75W1			
V	WH	UL-Recognized	MH18396
PW2.75W2			
V	WH	UL-Recognized	MH18396
RO175			
100	WH		MH18396
RO175WP			
100	WH		MH18396
RO512			
100	WH, CL		MH18396

Material	Color (short)	Specifications	File#
RO512REF			
100	WH		MH18396
RO514			
100	WH		MH18396
RSDRD17			
242/552	RD	NEC2017	MH16736
RSDRD1710			
242/552	RD	NEC2017, UL 969	MH16736
RSDYL17			
242/552	YE	NEC2017	MH16736
RSDYL1710			
242/552	YE	NEC2017, UL 969	MH16736
SMPV			
V	OG		MH11410
SMPV10			
443/552	OG	NEC2014	MH11410
SOLARD			
242/552	RD	IFC 2012, NEC2011, UL 969	MH16736
SOLARD10			
242/552	RD	NEC2014	MH16736
SOLARDS			
242/552	RD		MH16736
SSB			
V	RD		MH11410
TAG1			
100	WH	UL-Recognized	MH18396
TAG10			
100	WH	UL-Recognized	MH18396
TAG10T2			
100B	WH	UL-Recognized	MH18396
TAG11T4			
822	WH	UL-Recognized	MH18396
822C	CL		
TAG13T4			
822	WH	UL-Recognized	MH18396
TAG14			
400	WH	UL-Recognized	MH18396
TAG15			
400	WH	UL-Recognized	MH18396
600	SR		
TAG15T3			
795	SR	UL-Recognized	MH18396
822	WH		
822C	CL		
TAG16			
400	WH	UL-Recognized	MH18396
TAG16T3			
822	WH	UL-Recognized	MH18396

Standards for HellermannTyton Identification

Material	Color (short)	Specifications	File#
TAG17T2			
822	WH	UL-Recognized	MH18396
TAG1T1			
100B	WH	UL-Recognized	MH18396
TAG2			
100	WH	UL-Recognized	MH18396
TAG22			
100	WH	UL-Recognized	MH18396
TAG22T2			
100B	WH	UL-Recognized	MH18396
TAG22T3			
100B	WH	UL-Recognized	MH18396
TAG23			
100	WH	UL-Recognized	MH18396
TAG24			
100	WH	UL-Recognized	MH18396
TAG24T1			
100B	WH	UL-Recognized	MH18396
TAG25			
100	WH	UL-Recognized	MH18396
TAG26			
100	WH	UL-Recognized	MH18396
TAG26T6			
100B	WH	UL-Recognized	MH18396
TAG27			
400	WH	UL-Recognized	MH18396
600			
TAG27T1			
795	SR	UL-Recognized	MH18396
822	WH		
822C	CL		
TAG2T5			
100B	WH	UL-Recognized	MH18396
TAG3			
100	WH	UL-Recognized	MH18396
TAG38T4			
100B	WH	UL-Recognized	MH18396
TAG3T3			
100B	WH	UL-Recognized	MH18396
TAG44			
400	WH	UL-Recognized	MH18396
TAG5			
100	WH	UL-Recognized	MH18396
TAG51T3			
100B	WH	UL-Recognized	MH18396
TAG53T2			
100B	WH	UL-Recognized	MH18396
TAG6			
100	WH	UL-Recognized	MH18396

Material	Color (short)	Specifications	File#
TAG68T1			
336	WH	UL-Recognized	MH16736
TAG69T1			
336	WH	UL-Recognized	MH16736
TAG6T1			
100B	WH	UL-Recognized	MH18396
TAG70T12			
822	WH	UL-Recognized	MH18396
TAG71T5			
822	WH	UL-Recognized	MH18396
TAG72T1			
795	SR	UL-Recognized	MH18396
822	WH		
TAG73T1			
795	SR	UL-Recognized	MH18396
822	WH		
PO			
TAG75T1			
795	SR	UL-Recognized	MH18396
822	WH		
TAG76T1			
795	SR	UL-Recognized	MH18396
TAG78T1			
795	SR	UL-Recognized	MH18396
TAG79T1			
795	SR	UL-Recognized	MH18396
TAG7T1			
100B	WH	UL-Recognized	MH18396
TAG80T1			
795	SR	UL-Recognized	MH18396
TAG81T8			
822	WH	UL-Recognized	MH18396
TAG82T2			
822	WH	UL-Recognized	MH18396
TAG83T1			
822	WH	UL-Recognized	MH18396
TAG84T3			
822	WH	UL-Recognized	MH18396
TAG9			
100	WH	UL-Recognized	MH18396
TAG96T1			
336	WH	UL-Recognized	MH16736
TAG9T3			
100B	WH	UL-Recognized	MH18396
TAGPP1T6			
822	WH	UL-Recognized	MH18396
822C	CL		

Appendix

Product Approvals and Specifications

Standards for HellermannTyton Identification

Material	Color (short)	Specifications	File#
TAGPP3T4			
822	WH	UL-Recognized	MH18396
TIPTAGVA10X65YEWH			
PO	BK	BS-4G-198-3, Type 11a, MIL-STD-202G Method 215K, SAE - AS81531	
TIPTAGVA10X90YEWH			
PO	BK	BS-4G-198-3, Type 11a, MIL-STD-202G Method 215K, SAE - AS81531	
TIPTAGVA15X65YEWH			
PO	BK	BS-4G-198-3, Type 11a, CEN	

TIPTAGVA15X90YEWH			
PO	WH, YE	BS-4G-198-3, Type 11a, MIL-STD-202G Method 215K, SAE - AS81531	
TT4030			
MET	GY	2011/65/EU, 2014/35/EU, CE 2014/35/EU, DIN EN 55032:2012-12, DIN EN 55032:2016-02, DIN EN 55032 Berichtigung 1:2013-04, DIN EN 61000-6-2:2006-03, DIN EN 61000-6-2 Berichtigung 1:2011-06, EN 61000-3-2, EN 61000-6-2, IEC 60950-1, IEC 60950-1;am1, IEC 60950-1;am2	
TT822OUT			
PET	BK		MH18396
WDCCU			
443/552	OG RD	UL 969	MH11410
WDCCU10			
443/552	OG	NEC2014	MH11410
WDCCUM5			
AA	OG	NEC2014	
WDGC17			
443/552	OG	NEC2017, UL 969	MH11410
WDGC1710			
443/552	OG	NEC2017, UL 969	MH11410
WDGC17M5			
AA	OG	NEC2017	
WDPSLBL			
443/552	OG RD	NEC2017, UL 969 UL 969	MH11410
WDPSLBL10			
443/552	OG	NEC2017, UL 969	MH11410
WDPSLBLM5			
AA	OG	NEC2017	
WESHLBL			
443/552	OG RD	UL 969	MH11410

Material	Color (short)	Specifications	File#
WESHLBL10			
443/552	OG	NEC2014	MH11410
WESHLBL17			
443/552	OG	NEC2017, UL 969	MH11410
WESHLBL1710			
443/552	OG	NEC2017, UL 969	MH11410
WESHLBL17M5			
AA	OG	NEC2017	
WESHLBLDC			
443/552	OG RD	UL 969	MH11410
WESHLBLDC10			
443/552	OG	UL 969	MH11410
WESHLBLDC17			
443/552	OG	NEC2017, UL 969	MH11410
WESHLBLDC1710			
443/552	OG	NEC2017, UL 969	MH11410
WESHLBLDC17M5			
AA	OG	NEC2017	
WESHLBLDCM5			
AA	OG	NEC2014	
WESHLBLDCS			
443/552	OG	UL 969	MH11410
WESHLBLM5			
AA	OG	NEC2014	
WGCME			
443/552	OG RD	UL 969	MH11410
WGCME10			
443/552	OG	UL 969	MH11410
WGCMEM5			
AA	OG	NEC2014	
WS275X135			
PET	OG		MH16736
WS55X275			
PET	OG		MH16736
WTOPVLBL			
443/552	OG RD	NEC2017, UL 969 UL 969	MH11410
WTOPVLBL10			
443/552	OG	NEC2017, UL 969	MH11410
WTOPVLBLM5			
AA	OG	NEC2017	
WV275X135			
PET	OG		MH16736
WV55X275			
PET	OG		MH16736

Standards for HellermannTyton Application Tools

Material	Colour (short)	Specifications	File#
AZ100			
PA66	NA	ANSI/UL 1565, ANSI/UL 62275	E64962
PA66HSW	BK		
EVO7			
MET, PL	BK	CAGE Code 53421	
T18RA50			
PA66	NA	CAGE Code 53421, UL-ZODZ2.E64139	E64139
PA66HS	BK		
PA66V0	WH	ANSI/UL 1565, ANSI/UL 62275	E64962
T18RA5000			
PA66	NA	CAGE Code 53421, UL-ZODZ2.E64139	E64139
PA66HS	BK		
T30RA			
PA66	NA	CAGE Code 53421, UL-ZODZ2.E64139	E64139
PA66HS	BK		

Standards for HellermannTyton Electrical Installation

Material	Colour (short)	Specifications	File#
ET33			
PVC	BK		E50292
ET66			
PVC	BK		E50292
ETCW66			
PVC	BK	MIL-1-24391-A	E50292
ETST66			
PVC	BU		E50292
	GN		
	GY		
	OG		
	RD		
	WH		
YE			
HCPM-2			
PC	CL, YE	2006/65/EC, ANSI/UL 486-A, ANSI/UL 486-B, ANSI/UL 486-C, cULus, EN 60998-2-2:2004, EN 60998-2-2:201, ENEC	E316080
HCPM-3			
PC	CL, OG	2006/65/EC, ANSI/UL 486-A, ANSI/UL 486-B, ANSI/UL 486-C, cULus, EN 60998-2-2:2004, EN 60998-2-2:201, ENEC	E316080
HCPM-4			
PC	CL	2006/65/EC, ANSI/UL 486-A, ANSI/UL 486-B, ANSI/UL 486-C, cULus, EN 60998-2-2:2004, EN 60998-2-2:201, ENEC	E316080
HCPM-5			
PC	CL, BU	2006/65/EC, ANSI/UL 486-A, ANSI/UL 486-B, ANSI/UL 486-C, cULus, EN 60998-2-2:2004, EN 60998-2-2:201, ENEC	E316080
HCPM-6			
PC	CL, VT	2006/65/EC, ANSI/UL 486-A, ANSI/UL 486-B, ANSI/UL 486-C, cULus, EN 60998-2-2:2004, EN 60998-2-2:201, ENEC	E316080
HCPM-8			
PC	CL, BK	2006/65/EC, ANSI/UL 486-A, ANSI/UL 486-B, ANSI/UL 486-C, cULus, EN 60998-2-2:2004, EN 60998-2-2:201, ENEC	E316080

Appendix

Index by Part Number

Part No.	Type	Page
106-00000	Autotool 2000 CPK	491
106-00040	Bench mount kit CPK	492
106-00050	Overhead suspension CPK	492
106-00071	SP CPK hanger cpl.	492
106-00100	Power pack CPK	491
106-00110	Power pack CPK with control box	491
109-00001	Q18R	48
109-00004	Q18I	48
109-00007	Q18L	48
109-00010	Q30R	48
109-00012	Q30L	48
109-00014	Q30LR	48
109-00018	Q50R	49
109-00020	Q50I	49
109-00022	Q50L	49
109-00024	Q120I	49
109-00026	Q120R	49
109-00028	Q120M	49
109-00030	Q18R	48
109-00033	Q18I	48
109-00036	Q18L	48
109-00039	Q30R	48
109-00041	Q30L	48
109-00043	Q30LR	48
109-00047	Q50R	49
109-00049	Q50I	49
109-00051	Q50L	49
109-00053	Q120I	49
109-00055	Q120R	49
109-00057	Q120M	49
109-00088	Q18R	50
109-00091	Q18I	50
109-00094	Q18L	50
109-00097	Q30R	50
109-00099	Q30L	50
109-00101	Q30LR	50
109-00105	Q50R	51
109-00107	Q50I	51
109-00109	Q50L	51
109-00111	Q120I	51
109-00113	Q120R	51
109-00115	Q120M	51
109-00117	Q18R	50
109-00120	Q18I	50
109-00123	Q18L	50
109-00126	Q30R	50
109-00128	Q30L	50
109-00130	Q30LR	50
109-00134	Q50R	51
109-00136	Q50I	51
109-00138	Q50L	51
109-00140	Q120I	51
109-00142	Q120R	51
109-00144	Q120M	51
109-00300	SNP14A	196
109-00301	SNP14A	196
109-00302	SNP14A	198
110-09980	MK9RC	503
110-11329	MK7P-NP-STD	500
110-11330	MK7-NP-3MM	500
110-11331	MK7P-NP-3MM	500
110-11332	MK7P-NP-4MM	500

Part No.	Type	Page
110-70083	EVO7	501
110-70084	EVO7SP	501
110-70089	CALTOOL	501
110-70091	T8SD	501
110-70106	BLADEKIT	501
110-70131	EVO7 nosepiece 1mm	501
110-70132	EVO7 nosepiece 2mm	501
110-70133	EVO7 nosepiece 3mm	501
110-80000	EVO9	502
110-80001	EVO9SP	502
110-80004	EVO9HT	502
110-80018	EVO9	502
110-80037	Replacement Blade	502
110-80064	EVO9	502
110-80065	EVO9	502
110-80066	EVO9	502
110-80067	EVO9	502
110-95273	SP MK9SST replacement blade	504
110-95291	Front Nosepiece	504
110-95300	MK9PSST	499
110-99000	UC200	505
111-00659	T18R	39
111-00698	T30R	39
111-00718	T50L	39
111-00732	T50R	39
111-00815	T50R	30
111-00829	MCT30R	41
111-00830	MCT50R	41
111-00831	MCT50L	41
111-00925	T250M	34
111-00931	T50R	35
111-00937	MCTRELK2M	41
111-00965	T150M	30
111-00966	T150R(U)	30
111-00968	T30R	30
111-01125	T120R	39
111-01126	T250XL	35
111-01128	T50L	35
111-01136	MCT120R	41
111-01138	T120S	35
111-01196	T250M	35
111-01225	MCT18R	41
111-01235	PT220	31
111-01301	MBT14UH	70
111-01302	MBT20UH	70
111-01303	MBT27UH	70
111-01304	MBT33UH	70
111-01305	MBT43UH	70
111-01306	MBT49UH	70
111-01386	MCTS200	41
111-01459	T30R	30
111-01560	T50R	36
111-01561	T50L(US)	36
111-01562	T50L(US)	36
111-01563	T50XL(US)	36
111-01564	T50R	36
111-01568	T50R	30
111-01601	T50I	35
111-01619	T120I	30
111-01664	MCTPP18R	41
111-01665	MCTPP30R	41
111-01666	MCTPP50R	41
111-01667	MCTPP50L	41

Part No.	Type	Page
111-01668	MCTPP120R	41
111-01670	PAT100R	32
111-01671	TAS120M	79
111-01672	TAS120L	79
111-01699	PAT100L	32
111-01703	T50R	30
111-01752	T150M	36
111-01933	T18R	24
111-01934	T18R	24
111-01935	T18R	24
111-01936	T18R	24
111-05350	T50IFT7	101
111-12300	WSS	46
111-12301	WSI	46
111-12302	WSR	46
111-85460	T50SL6	94
111-85519	T18RSF	93
111-85560	T18RSF	93
111-85720	T50RSFM	94
111-85810	T50RFT10	102
111-85850	T50MD7	88
111-85871	T50RFT7	101
111-95148	MBT14XH5	67
111-95149	MBT14XH	69
111-95208	MBT20XH5	67
111-95209	MBT20XH	69
111-95278	MBT27XH5	67
111-95279	MBT27XH	69
111-95338	MBT33XH5	67
111-95339	MBT33XH	70
113-00060	T50MRX	121
113-00061	T50MRX	121
115-00030	SpeedyTie (RTT750HR)	56
115-00046	RF140	59
115-00047	RF140	59
115-00049	RF250	59
115-00054	RF250	59
115-06960	RT50SFK	99
116-01812	T18R	24
116-01814	T18R	24
116-01815	T18R	24
116-01816	T18R	24
116-01818	T18R	24
117-00012	SDCTR312	134
117-00017	T50SDH	61
117-00018	T50SDH	61
117-00019	T50SDH	61
118-00032	PT2A	31
118-00110	T50SOS	47
118-00111	T50ROS	47
118-04700	T18ROS	47
118-04800	T30ROS	47
118-04900	T30LOS	47
118-05050	T50ROS	47
118-05850	T50SOS	47
118-05900	T50LOS	47
120-05015	T18RA5000	493
121-00680	KR6/8	504
121-63560	KR6/35	80
121-74359	KR8/43	80
121-82119	KR8/21	80
121-82160	KR8/21	80
121-83355	KR8/33	80

Part No.	Type	Page
121-83360	KR8/33	80
121-83378	KR8/33	80
126-00000	T50SOSEC13E	122
126-00001	T50SL5	94
126-00005	T50SL5	94
126-00015	T50SDOP	88
126-00017	T50SST5	88
126-00036	T50SOSEC34E	122
126-00041	T18RWPM	93
126-00042	T18RWPM	93
126-00043	T50SSF	91
126-00044	T50SSF	91
126-00045	T50SSF	91
126-00046	T50SSF	91
126-00049	T50SSFM	95
126-00069	T50SSFM	95
126-00074	T50RSFM	94
126-00075	T50SOSK5FT5.4E	87
126-00076	T60SOS5FT65x130-E-MD	97
126-00079	T60SOS5FT70x120-E-MD	97
126-00080	T60SOS5FT62x122-E-MD	97
126-00081	T50SOSK5FT6.5E	87
126-00082	T50SSFM	95
126-00099	T50SOSK5FT5SE	87
126-00111	T50SOSK5FT5SE	87
126-00114	T50ROSAH6U	88
126-00115	T50ROSAH6U	88
126-00116	T50RSFM	94
126-00117	T50RSFM	94
126-00183	PT2ASFT6.5PT0.7-1.5-E	88
126-00186	T60SOS5FT65x130-E-MS-MD	97
126-00243	T50SOS5FT6.5E-MD	96
126-00244	T50SOS5FT6.5E-MD	96
126-00245	T50SOS5FT6.5E-MS-MD	96
126-00326	T50SOSK5FT6.5S2-E	87
126-02204	T50SSL5	95
126-02300	T50SST5	88
126-03102	T50SOS5FT6.5E	88
132-00032	BT105L	128
132-00033	BT105R	128
132-00034	BT130LDP	128
132-00035	BT130RDP	128
133-00059	T40XEC5SP-E	122
133-00285	CG52	163
133-00993	HC2A	137
133-00994	HC2B	137
133-00995	HC2C	137
133-00996	HC2D	137
133-00997	HC2E	137
133-00998	HC3A	137
133-01476	MINICHNLU	178
133-01477	90MINICHNL2	179
133-01478	45MINICHNL2	179
133-01479	90MINICHNL	179
133-01480	45MINICHNL	179
148-00088	T50SOSWA2.0E	81
148-00089	T50SOSWA1.8E	81
148-00090	T50SOSWB1.8E	81
148-00091	T50SOSWB4.3E	81
148-00092	T50SOSWA4.3E	81
148-00093	T50SOSWB2.0E	81
148-00095	T50SOSWA3.4E	81
148-00096	T50SOSWB3.4E	81

Part No.	Type	Page
148-00200	T50SOSEC12E	122
148-90036	HCPM-2	508
148-90037	HCPM-3	508
148-90038	HCPM-4	509
148-90039	HCPM-5	509
148-90040	HCPM-6	509
148-90041	HCPM-8	509
148-90048	HCPM-2	508
148-90049	HCPM-3	508
148-90050	HCPM-4	509
148-90051	HCPM-5	509
148-90052	HCPM-6	509
148-90053	HCPM-8	509
150-08110	CHA1	182
150-09201	COW20DP7	184
150-15395	T50SST5	88
150-31090	T3ORFT6LG	100
150-31091	T5ORFT6LG	101
150-31093	T5OSFT6LG	101
150-31098	T5ORFT6LG	101
150-37791	T5OROSSFT6.5 16-3	89
150-37799	T5OROSSFT6.5 16-3MD	90
150-45397	STAND OFF CLIP	186
150-55500	REL30SDP6	110
150-55850	T3ORFT5	100
150-55948	T3ORFT5	100
150-77940	T3ORFT6	100
150-93100	T5OROSSFT6.5-D16-2 MD	90
150-95500	TC5FT6S	182
151-00006	CGS1	163
151-00016	BC30	187
151-00017	BC2212	187
151-00018	CTC10FT6LG	194
151-00019	CTC13FT6LG	194
151-00023	SOC6	184
151-00029	TCOP70x120	182
151-00074	SOC5FT6LG	184
151-00077	CH20D6	184
151-00080	COW30DP7	184
151-00152	EC31	190
151-00180	YCCFT62x122	188
151-00194	CCSFT7x12	189
151-00235	Big YCC TS	189
151-00429	EC42	189
151-00430	EC43	189
151-00459	FT6LG.JAE.CONNECT.TS	189
151-00464	EC6mod	189
151-00499	ECC1CPT	189
151-00513	YCCSFT62122	188
151-00620	CCIISFT6.5x13	189
151-00621	CTCL16FT6LG	194
151-00623	SOCHFT6	186
151-00629	SOC7FT6	184
151-00644	DSWS4	135
151-00646	MB4A	141
151-00650	SOC8FT6	184
151-00651	TC6FT6LG	182
151-00663	TC6FT6	182
151-00665	SOC8FT6LG	185
151-00667	WAC075	223
151-00668	WAC100	223
151-00669	WAC100	223
151-00677	CC08	189

Part No.	Type	Page
151-00757	CTAM1	148
151-00758	CTAM2	148
151-00765	CC09	188
151-00775	CCSFT6.5	189
151-00783	CTCFT6	194
151-00785	CCFT6LG	189
151-00786	CCFT6XLG	189
151-00810	MB4A	141
151-00812	HM5	169
151-00813	HM6	169
151-00814	HM7	169
151-00833	YCCSFT62x122PT0.7-1.3 90°	189
151-00834	YCCSFT62x122PT1.7-2.3 90°	189
151-00835	YCCSFT62x122PT0.7-1.3	189
151-00836	YCCSFT62x122PT1.7-2.3	189
151-00903	SOC10FT6LG	185
151-00925	CCOVAL	188
151-00927	SC6.6	173
151-00932	SOC11FTOVAL	185
151-00950	MCKR6G5	151
151-00973	HM4	169
151-00975	HM5A	170
151-00976	HM6A	170
151-00982	MSC2	192
151-00992	SOC11FTOVAL	185
151-00993	BC90FT6	180
151-00994	BC90AH	181
151-00997	MCCTAM1	148
151-01017	LOC59FT6LG	225
151-01018	SOC13FTOVAL	186
151-01020	MCKR8G5-5	151
151-01022	LOC15-19FT6LG	226
151-01023	LOC15-19FT6LG2	225
151-01033	CCOVAL6	188
151-01051	BC90FT6B	180
151-01108	CCOVAL2	188
151-01109	BC90AH2	181
151-01113	EC46	189
151-01117	SOC12FTOVAL	185
151-01122	LPM25	166
151-01125	SOC13FT6LGL	185
151-01126	SOC13FT6LGR	185
151-01136	CC12	188
151-01153	SOC9FT6	185
151-01154	SOC9FT6XLG	185
151-01166	LOC1014FT6LG	225
151-01169	MCMB3	146
151-01170	MCMB4	146
151-01206	EC48	190
151-01231	HDHC59	138
151-01238	SOC12FTOVAL	185
151-01239	BCFTOVAL	183
151-01240	BCFTOVAL2	182
151-01244	CCOVAL3	188
151-01246	CCOVAL4	189
151-01259	CCOVAL	188
151-01286	CCOVAL5	188
151-01306	LOC5-9FTOVAL	225
151-01371	LOC20-25FT6.5LG	226
151-01390	RCB180SM10	208
151-01403	BCFTOVAL	183
151-01416	RCA180SM8	205
151-01417	RCA180SM10	206

Appendix

Index by Part Number

Part No.	Type	Page
151-01418	RCA180SM12	206
151-01419	RCA180MM8	205
151-01420	RCA180MM10	205
151-01421	RCA180MM12	205
151-01422	RCA180LM8	205
151-01423	RCA180LM10	205
151-01424	RCA180LM12	205
151-01425	RCA15SM8	204
151-01426	RCA15SM10	204
151-01427	RCA15SM12	204
151-01428	RCA30SM8	204
151-01429	RCA30SM10	204
151-01430	RCA30SM12	205
151-01431	RCA30LM8	204
151-01432	RCA30LM10	204
151-01433	RCA30LM12	204
151-01434	RCA90SM8	205
151-01435	RCA90SM10	205
151-01436	RCA90SM12	205
151-01437	RCA90LM8	205
151-01438	RCA90LM10	205
151-01439	RCA90LM12	205
151-01440	RCB180SM8	208
151-01441	RCB180SM12	208
151-01442	RCB180MM8	208
151-01443	RCB180MM10	208
151-01444	RCB180MM12	208
151-01445	RCB180LM8	208
151-01446	RCB180LM10	208
151-01447	RCB180LM12	208
151-01448	RCB15SM8	207
151-01449	RCB15SM10	207
151-01450	RCB15SM12	207
151-01451	RCB30SM8	207
151-01452	RCB30SM10	208
151-01453	RCB30SM12	208
151-01454	RCB30LM8	207
151-01455	RCB30LM10	207
151-01456	RCB30LM12	207
151-01457	RCB90SM8	208
151-01458	RCB90SM10	208
151-01459	RCB90SM12	208
151-01460	RCB90LM8	208
151-01461	RCB90LM10	208
151-01462	RCB90LM12	208
151-01474	RCC180SM8	210
151-01475	RCC180SM10	210
151-01476	RCC180SM12	210
151-01477	RCC180MM8	210
151-01478	RCC180MM10	210
151-01479	RCC180MM12	210
151-01480	RCC180LM8	210
151-01481	RCC180LM10	210
151-01482	RCC180LM12	210
151-01483	RCC15SM8	209
151-01484	RCC15SM10	209
151-01485	RCC15SM12	209
151-01486	RCC30SM8	209
151-01487	RCC30SM10	209
151-01488	RCC30SM12	210
151-01489	RCC30LM8	209
151-01490	RCC30LM10	209
151-01491	RCC30LM12	209

Part No.	Type	Page
151-01492	RCC90SM8	210
151-01493	RCC90SM10	210
151-01494	RCC90SM12	210
151-01495	RCC90LM8	210
151-01496	RCC90LM10	210
151-01497	RCC90LM12	210
151-01499	RCD180SM8	212
151-01501	RCD180SM10	212
151-01502	RCD180SM12	212
151-01503	RCD180MM8	212
151-01504	RCD180MM10	212
151-01505	RCD180MM12	212
151-01506	RCD180LM8	212
151-01507	RCD180LM10	212
151-01508	RCD180LM12	212
151-01509	RCD15SM8	211
151-01510	RCD15SM10	211
151-01511	RCD15SM12	211
151-01512	RCD30SM8	211
151-01513	RCD30SM10	211
151-01514	RCD30SM12	212
151-01515	RCD30LM8	211
151-01516	RCD30LM10	211
151-01517	RCD30LM12	211
151-01518	RCD90SM8	212
151-01519	RCD90SM10	212
151-01520	RCD90SM12	212
151-01521	RCD90LM8	212
151-01522	RCD90LM10	212
151-01523	RCD90LM12	212
151-01527	FMB4APT-I	145
151-01528	FMB4APT-I	145
151-01529	RCTT	221
151-01530	RCINSERTA	221
151-01531	RCINSERTB	221
151-01532	RCINSERTC	221
151-01533	RCINSERTD	221
151-01565	BCAA	193
151-01566	BCBLGA	193
151-01567	BCCLGA	193
151-01628	RCD90LM6	212
151-01629	MB3A	142
151-01630	MB3A	142
151-01631	MB4A	142
151-01632	MB4A	142
151-01633	MB5A	142
151-01634	MB5A	142
151-01637	RCA180SM6	205
151-01638	RCA180MM6	205
151-01639	RCA180LM6	205
151-01640	RCA15SM6	204
151-01641	RCA30SM6	204
151-01642	RCA30LM6	204
151-01643	RCA90SM6	205
151-01644	RCA90LM6	205
151-01645	RCB180SM6	208
151-01646	RCB180MM6	208
151-01647	RCB180LM6	208
151-01648	RCB15SM6	207
151-01649	RCB30SM6	207
151-01650	RCB30LM6	207
151-01651	RCB90SM6	208
151-01652	RCB90LM6	208

Part No.	Type	Page
151-01653	RCC180SM6	210
151-01654	RCC180MM6	210
151-01655	RCC180LM6	210
151-01656	RCC15SM6	209
151-01657	RCC30SM6	209
151-01658	RCC30LM6	209
151-01659	RCC90SM6	210
151-01660	RCC90LM6	210
151-01661	RCD180SM6	212
151-01662	RCD180MM6	212
151-01663	RCD180LM6	212
151-01664	RCD15SM6	211
151-01665	RCD30SM6	211
151-01666	RCD30LM6	211
151-01667	RCD90SM6	212
151-01670	RCA180SM6	205
151-01671	RCA180SM6	208
151-01672	RCC180SM6	210
151-01673	RCD180SM6	212
151-01699	MSC2LP	192
151-01857	WSMB5AHB	144
151-01883	BCSFTOVAL	183
151-01884	BCSFTOVAL2	182
151-01888	BCFTOVALXL	183
151-01911	RCA180SM6SS	214
151-01912	RCA180SM8SS	214
151-01913	RCA180SM10SS	214
151-01914	RCA180SM12SS	214
151-01915	RCA180MM6SS	214
151-01916	RCA180MM8SS	214
151-01917	RCA180MM10SS	214
151-01918	RCA180MM12SS	214
151-01919	RCA180LM6SS	214
151-01920	RCA180LM8SS	214
151-01921	RCA180LM10SS	214
151-01922	RCA180LM12SS	214
151-01923	RCA15SM6SS	213
151-01924	RCA15SM8SS	213
151-01925	RCA15SM10SS	213
151-01926	RCA15SM12SS	213
151-01927	RCA30SM6SS	213
151-01928	RCA30SM8SS	213
151-01929	RCA30SM10SS	213
151-01930	RCA30SM12SS	214
151-01931	RCA30LM6SS	213
151-01932	RCA30LM8SS	213
151-01933	RCA30LM10SS	213
151-01934	RCA30LM12SS	213
151-01935	RCA90SM6SS	214
151-01936	RCA90SM8SS	214
151-01937	RCA90SM10SS	214
151-01938	RCA90SM12SS	214
151-01939	RCA90LM6SS	214
151-01940	RCA90LM8SS	214
151-01941	RCA90LM10SS	214
151-01942	RCA90LM12SS	214
151-01943	RCB180SM6SS	216
151-01944	RCB180SM8SS	216
151-01945	RCB180SM10SS	216
151-01946	RCB180SM12SS	216
151-01947	RCB180MM6SS	216
151-01948	RCB180MM8SS	216
151-01949	RCB180MM10SS	216

Part No.	Type	Page
151-01950	RCB180MM12SS	216
151-01951	RCB180LM6SS	216
151-01952	RCB180LM8SS	216
151-01953	RCB180LM10SS	216
151-01954	RCB180LM12SS	216
151-01955	RCB15SM6SS	215
151-01956	RCB15SM8SS	215
151-01957	RCB15SM10SS	215
151-01958	RCB15SM12SS	215
151-01959	RCB30SM6SS	215
151-01960	RCB30SM8SS	215
151-01961	RCB30SM10SS	215
151-01962	RCB30SM12SS	216
151-01963	RCB30LM6SS	215
151-01964	RCB30LM8SS	215
151-01965	RCB30LM10SS	215
151-01966	RCB30LM12SS	215
151-01967	RCB90SM6SS	216
151-01968	RCB90SM8SS	216
151-01969	RCB90SM10SS	216
151-01970	RCB90SM12SS	216
151-01971	RCB90LM6SS	216
151-01972	RCB90LM8SS	216
151-01973	RCB90LM10SS	216
151-01974	RCB90LM12SS	216
151-01975	RCC180SM6SS	218
151-01976	RCC180SM8SS	218
151-01977	RCC180SM10SS	218
151-01978	RCC180SM12SS	218
151-01979	RCC180MM6SS	218
151-01980	RCC180MM8SS	218
151-01981	RCC180MM10SS	218
151-01982	RCC180MM12SS	218
151-01983	RCC180LM6SS	218
151-01984	RCC180LM8SS	218
151-01985	RCC180LM10SS	218
151-01986	RCC180LM12SS	218
151-01987	RCC15SM6SS	217
151-01988	RCC15SM8SS	217
151-01989	RCC15SM10SS	217
151-01990	RCC15SM12SS	217
151-01991	RCC30SM6SS	217
151-01992	RCC30SM8SS	217
151-01993	RCC30SM10SS	218
151-01994	RCC30SM12SS	218
151-01995	RCC30LM6SS	217
151-01996	RCC30LM8SS	217
151-01997	RCC30LM10SS	217
151-01998	RCC30LM12SS	217
151-01999	RCC90SM6SS	218
151-02001	RCC90SM8SS	218
151-02002	RCC90SM10SS	218
151-02003	RCC90SM12SS	218
151-02004	RCC90LM6SS	218
151-02005	RCC90LM8SS	218
151-02006	RCC90LM10SS	218
151-02007	RCC90LM12SS	218
151-02008	RCD180SM6SS	220
151-02009	RCD180SM8SS	220
151-02010	RCD180SM10SS	220
151-02011	RCD180SM12SS	220
151-02012	RCD180MM6SS	220
151-02013	RCD180MM8SS	220

Part No.	Type	Page
151-02014	RCD180MM10SS	220
151-02015	RCD180MM12SS	220
151-02016	RCD180LM6SS	220
151-02017	RCD180LM8SS	220
151-02018	RCD180LM10SS	220
151-02019	RCD180LM12SS	220
151-02020	RCD15SM6SS	219
151-02021	RCD15SM8SS	219
151-02022	RCD15SM10SS	219
151-02023	RCD15SM12SS	219
151-02024	RCD30SM6SS	219
151-02025	RCD30SM8SS	219
151-02026	RCD30SM10SS	220
151-02027	RCD30SM12SS	220
151-02028	RCD30LM6SS	219
151-02029	RCD30LM8SS	219
151-02030	RCD30LM10SS	219
151-02031	RCD30LM12SS	219
151-02032	RCD90SM6SS	220
151-02033	RCD90SM8SS	220
151-02034	RCD90SM10SS	220
151-02035	RCD90SM12SS	220
151-02036	RCD90LM6SS	220
151-02037	RCD90LM8SS	220
151-02038	RCD90LM10SS	220
151-02039	RCD90LM12SS	220
151-02094	HDM320	160
151-02096	HDM500	160
151-02097	HDM500	160
151-02098	HDM320	160
151-02099	SAM320B	164
151-02102	SAM400B	164
151-02103	SAM500B	164
151-02104	HDM375BDM4W	161
151-02189	MSC90	191
151-02218	LOC1014FT9x12	225
151-02501	LOC1014FT9x12	225
151-02600	CH20D7	184
151-02901	CHA2	182
151-03401	EC15	190
151-03402	EC16	190
151-03403	EC17	190
151-03404	EC14	190
151-06500	DSW54	135
151-10901	QM20	152
151-10902	QM30	152
151-10903	QM40	152
151-10904	QM20A	143
151-10905	QM30A	143
151-10906	QM40A	143
151-10911	QM20	152
151-10912	QM30	152
151-10913	QM40	152
151-10914	QM20A	143
151-10915	QM30A	143
151-10916	QM40A	143
151-10920	CTQM5	152
151-10930	CTQM5	152
151-10950	QT7016R	434
151-10951	QT7040R	434
151-10952	QT7040S	434
151-10953	QT10065R	434
151-13601	RB8	222

Part No.	Type	Page
151-14059	RB5	222
151-14312	CTC13FT6	194
151-26101	TC-SB5C	187
155-01600	STAND-OFF-CLIP-2	186
155-03800	FT6LG-AMP	189
155-05800	T50SOSFT6E	103
155-11601	BCSFT6.5 16-3MD	182
155-16301	WICKELCLIP-VDS	182
155-17801	CTC10FT9	194
155-30702	FT6LG.YAZ.CONNECT-T5	189
155-30802	TC2FT6LG	182
155-30902	SOC4 M.FT6	184
155-32602	FT6LG.M.St.Aufn.II	189
155-36002	STECKERHALTER SITZ	188
155-38102	YCC-FT6-S	189
155-46302	T50SOS5B6HE	112
156-00012	T3OROC1A	85
156-00013	T3OROC2A	85
156-00014	T3OROC2A	85
156-00016	T50S0SEC20	127
156-00017	T50S0SEC21	127
156-00025	T50RFT5	100
156-00036	T50ROC1A	86
156-00054	T50IFT6LG	101
156-00055	T50LFT7	101
156-00056	T50SFT7	101
156-00057	T30RFT7	100
156-00066	T50LFT6	101
156-00067	T120RFT9A	102
156-00068	W5SFT9A	102
156-00069	WSIFT9A	102
156-00070	WSRFT9A	102
156-00071	T120RFT9B	102
156-00072	W5SFT9B	102
156-00074	WSRFT9B	102
156-00089	T30RFT10	100
156-00091	T50RFT10	102
156-00092	T50IFT10	102
156-00093	T50LFT10	102
156-00156	T50SFT6	101
156-00157	T50RFT6	101
156-00282	T50LFT7	101
156-00329	T50RFT7HD	101
156-00375	T30RFT8	100
156-00376	T50RFT8	101
156-00377	T50IFT8	101
156-00378	T50LFT8	101
156-00444	T50ROSAH6MDU	96
156-00455	T50ROSP1SFT6.5	98
156-00456	T50ROSP2SFT6.5	98
156-00457	T50RFT7HD	101
156-00468	T50RECSB	124
156-00520	T3OROC5J	85
156-00537	T50REC19	124
156-00538	T50REC4B	123
156-00539	T50REC4A	123
156-00540	T50REC5B	124
156-00541	T50REC5A	124
156-00551	T50REC9SD	124
156-00553	T50REC21	124
156-00554	T50REC22	124
156-00555	T50REC20	124
156-00556	T50REC23	125

Appendix

Index by Part Number

Part No.	Type	Page
156-00557	T50REC24	125
156-00561	T50REC20	124
156-00564	T50REC4A	123
156-00565	T50REC4B	123
156-00567	T50REC23	125
156-00577	T50SMVCOC19-24.5	83
156-00588	T50REC4B	123
156-00589	T50REC5A	124
156-00590	T50REC19	124
156-00591	T50REC20	124
156-00592	T50REC23	125
156-00593	T50REC24	125
156-00635	T50REC4A	123
156-00838	T30ROC2B	85
156-00858	T50SOSEC4A	126
156-00859	T50SOSEC4B	126
156-00860	T50ROSEC4A	126
156-00861	T50ROSEC4B	126
156-00862	T50ROSEC5B	127
156-00863	T50SOSEC5B	126
156-00864	T50ROSEC5A	126
156-00865	T50SOSEC5A	126
156-00866	T50SOSEC9SD	127
156-00867	T50ROSEC9	127
156-00870	T50SOSEC10	127
156-00871	T50ROSEC10	127
156-00872	T50ROSEC19	127
156-00873	T50ROSEC20	127
156-00874	T50ROSEC21	127
156-00875	T50SOSEC22	127
156-00876	T50ROSEC22	127
156-00877	T50ROSEC23	127
156-00878	T50ROSEC24	127
156-00882	T50RFT5.5SD	101
156-00894	T30ROC5J-P	86
156-00895	T30ROC5J-P	86
156-00953	T30RFT4	100
156-01031	T50LOC1A	86
156-01060	T50IOC2A	86
156-01090	PT2AP1SFT6.5	89
156-01091	PT2AP2SFT6.5	89
156-01146	PT2AP3SFT6.5	89
156-01162	T50REC23	125
156-01336	PT2AFT6LG	102
156-01337	T50SVCOC10-14	84
156-01339	T50SVCOC15-18	84
156-01340	T50SMVCOC15-18	82
156-01341	T50SVCOC19-24.5	84
156-01342	T50SMVCOC19-24.5	83
156-01343	T50SVCOC25-31	84
156-01344	T50SMVCOC25-31	83
156-01345	T50SVCOC31-39	84
156-01346	T50SMVCOC31-39	83
156-01347	T50SVCOC39-45	84
156-01348	T50SMVCOC39-45	83
156-01349	T50SVC4S	83
156-01350	T50SVC3.5	83
156-01385	T50SVCOC10-14	84
156-01513	PAT100LFT6LG	102
156-01516	T50SVC5	83
156-01546	T30ROSECO.5-2.5SP-SVB	126
156-01547	T50ROSSB55-6U-SET	115
156-01555	PAT100RFT6LG	102

Part No.	Type	Page
156-01601	CBTO50R	123
156-01668	T50R1SB5-6USET	115
156-01670	T50SVC6.5	83
156-01690	T50SMVCLOC15-19	82
156-01714	T50SMVCLOC20-25	82
156-01726	T50RBHMB	131
156-01795	T50IOC1B	86
156-01796	T50ROSBHMB	131
156-01797	T30ROSECO.5-2.5SP-SVA	126
156-01807	T50SOSEBHM	131
156-02224	T50REC5B	124
156-02225	T50REC5B	124
156-02226	T50REC5A	124
156-02227	T50REC5A	124
156-02228	T50REC4B	123
156-02229	T50REC4B	123
156-02230	T50REC4A	123
156-02231	T50REC4A	123
156-02232	PAT100LSB55-6U2SET	115
156-02383	T50SMVCLOC10-14	82
156-02384	T50SMVCLOC5-9	82
156-02512	T50RPBM9SET	129
156-02513	T50RPBM9SET	129
156-04601	T50SOSEC19	127
157-00014	T50SOS2DOP62X122-E	108
157-00034	WSS8MM	117
157-00035	WSI8MM	118
157-00036	WSR8MM	118
157-00050	T50SOSFT6LGLU	103
157-00052	T50SOSFT6LGLU	103
157-00053	T50SOSFT7X12U	108
157-00060	SDCTL	134
157-00069	T50SOS2DOP62X122-E	108
157-00072	T50SOSFT8E	103
157-00073	T50RTM25E	104
157-00105	T50SOSB5-High-E-C-CC	112
157-00106	T50SOSB5-High-E-O-US	112
157-00112	T50SOSFTQM6	130
157-00115	T50SOSFT8E	103
157-00118	T50ROSFTM6SO12.5A	105
157-00119	T50ROSFT6SO25A	105
157-00120	T50ROSFT8SO25A	105
157-00130	T50ROSFT6SO12.5A	105
157-00131	T50ROSFTM6SO12.5B	105
157-00142	T50ROSFTOVALU	107
157-00143	T50SOSFTOVALU	108
157-00144	T50ROSFTQM6	130
157-00145	T50ROSFT6SO12.5A	105
157-00150	T50ROSFT6SO25A	105
157-00151	T50SOSB5-High-E-C-CC	112
157-00153	T50ROSFTOVALU	107
157-00154	T50SOSFTOVALU	108
157-00157	T50ROSFTOVALU	107
157-00158	T50ROSFT6SO25A	105
157-00163	T50ROSFTQM6	130
157-00164	T50ROSFT6SO25R	105
157-00165	T50ROSFT6SO12.5R	105
157-00184	T50SOS3DOP65X130-E	108
157-00195	T50ROSFT625SO	105
157-00196	T50ROSFT825SO	105
157-00205	T50ROSFTOVAL25A	107
157-00216	T50ROSFT612.5SO	105
157-00217	T50ROSFT812.5SO	105

Part No.	Type	Page
157-00218	T50ROSFTOVAL12.5SO	109
157-00219	T50ROSFTOVAL25SO	109
157-00221	T50ROSFTOVAL25R	106
157-00222	T50ROSFTOVAL25A	107
157-00224	T50ROSFTOVAL12.5A	106
157-00225	T50ROSFTOVAL12.5A	106
157-00232	T50ROSFTOVALR	107
157-00233	T50ROSSB5-6U	111
157-00247	T50ROSFTOVAL25B	107
157-00249	T50ROSFTOVAL12.5B	106
157-00253	T50SOSFTOVALU	108
157-00254	T50ROSFTOVALU	107
157-00266	T50SOSFTOVALU	108
157-00268	T50ROSFTOVAL	108
157-00281	WSS6MM	117
157-00282	WSI6MM	117
157-00283	WSR6MM	117
157-00284	WSS10MM	118
157-00285	WSI10MM	118
157-00286	WSR10MM	118
157-00287	T50SOSFT6.5LG-E4X	103
157-00288	T50ROSFTOVAL25A	107
157-00290	T8ROSSB8U	111
157-00291	T8ROSSB10U	111
157-00292	T8ROSSB12U	111
157-00293	T8ROSSB8U	111
157-00294	T8ROSSB10U	111
157-00295	T8ROSSB12U	111
157-00296	T50SOSFT6.5LG-E4	103
157-00302	T50SOSFT6.5LG-E4X	103
157-00303	T50SOSFT6.5LG-E4	103
157-00306	T50ROSFT6.5LG-E4	103
157-00323	T50ROSFTOVAL12.5A	107
157-00325	T50ROSFTM6MSO25	113
157-00326	T50ROSFTM6MSO25	113
157-00327	T50ROSFTM8MSO25	113
157-00328	T50ROSFTM8MSO25	113
157-00329	T50ROSFTM8MSO18	132
157-00332	T50ROSFTOVAL25B	107
157-00333	T50ROSFTOVAL12.5B	107
157-00335	T50ROSFTM6MSO25	114
157-00338	T50ROSFTM6MSO25	114
157-00340	T8ROSLPSB8U	116
157-00341	T8ROSLPSB8U	116
157-00342	T8ROSLPSB10U	116
157-00343	T8ROSLPSB10U	116
157-00344	T8ROSLPSB12U	116
157-00345	T8ROSLPSB12U	116
157-00355	T50SOSFT6.5LG-E4	103
157-00359	T50SOSFT6.5LG-E4X	103
157-00361	T50ROSFTM8MSO25	114
157-00362	T50ROSFTM8MSO25	114
157-00373	T50SOSFT6.5LG-E4	103
157-00376	T50SOSFT6.5-E4	103
157-00379	T50ROSFTOVAL12.5SO	109
157-00391	T50ROSFTOVALU	107
157-00400	WSS250	117
157-00401	WSI250	117
157-00402	WSR250	117
157-00403	WSS380	117
157-00404	WSI380	117
157-00405	WSR380	117
161-05084	5FRP	356

Part No.	Type	Page
161-60001	HAT8	353
161-60002	HAT16	353
161-60003	HAT20	353
161-60004	HAT25	353
161-60005	HAT30	353
161-62000	HWPP16	349
161-62001	HWPP25	349
161-63103	HWPAV08	350
161-63203	HWPAV016	350
161-63303	HWPAV020	350
161-63403	HWPAV025	350
161-63503	HWPAV030	350
161-64002	HWCLIP08	351
161-64004	HWCLIP16	351
161-64006	HWCLIP20	351
161-64008	HWCLIP25	351
161-64010	HWCLIP30	351
161-64013	HWBASEA	352
161-64014	HWBASE	352
161-64112	HWPP8	348
161-64213	HWPP16	348
161-64216	HWPP16	348
161-64217	HWPP16	349
161-64310	HWPP20	348
161-64311	HWPP20	348
161-64414	HWPP25	348
161-64416	HWPP25	348
161-64417	HWPP25	349
161-64507	HWPP30	348
169-60018	CTN380	360
169-60019	CTN120	360
169-60020	CTN340	360
169-60021	CTN10	360
169-60022	CTN140	360
169-60024	CTN580 UNSLIT	359
170-03000	BSP140	327
170-03001	BSP120	327
170-03002	BSP340	327
170-03003	BSP100	327
170-03004	BSP1140	327
170-03005	BSP1120	327
170-03006	BSPFR140	331
170-03007	BSPFR120	331
170-03008	BSPFR340	331
170-03010	BSPFR1140	331
170-03011	BSPFR1120	331
170-03012	BSPSC120	329
170-03013	BSPSC340	329
170-03014	BSPSC100	329
170-03015	BSPSC1140	329
170-03016	BSPSC1120	329
170-03017	BSSCFR120	332
170-03018	BSSCFR340	332
170-03019	BSSCFR100	332
170-03020	BSSCFR1140	332
170-03021	BSSCFR1120	332
170-03024	BSPSW120	340
170-03025	BSPSW100	340
170-03026	BSPSW1140	340
170-03027	BSPA66120	343
170-03028	BSPA66340	343
170-03029	BSPA66100	343
170-03030	BSPA661140	343

Part No.	Type	Page
170-03031	BSDISPLAY	345
170-03032	BSWTOOL12	347
170-03033	BSWTOOL1	347
170-03034	BSWTOOL114	347
170-03035	BSPSC140	329
170-03036	BSSCFR140	332
170-03037	BSPSW140	340
170-03038	BSPSW340	340
170-03039	BSBHK	346
170-03040	BSPHK	346
170-03041	BSP140B	327
170-03042	BSP120B	327
170-03043	BSP340B	327
170-03044	BSP100B	327
170-03045	BSP1140B	327
170-03046	BSPA66120B	343
170-03047	BSPA66340B	343
170-03048	BSPA66100B	343
170-03049	BSPA661140B	343
170-03050	BSHTFG140B	335
170-03051	BSHTFG120B	335
170-03052	BSHTFG340B	335
170-03053	BSHTFG100B	335
170-03054	BSHTTST12SRB	337
170-03055	BSHTTST34SRB	337
170-03056	BSHTTST10SRB	337
170-03057	BSHTTST134SRB	337
170-03058	BSHTFG140	335
170-03059	BSHTFG120	335
170-03060	BSHTFG340	335
170-03061	BSHTFG100	335
170-03062	BSHTTST12SR	337
170-03063	BSHTTST34SR	337
170-03064	BSHTTST10SR	337
170-03065	BSHTTST134SR	337
170-03066	BSPFR1128	331
170-03067	BSWTOOL14	347
170-03068	BSWTOOL34	347
170-03069	BSPA66140	343
170-03070	BSPA66140B	343
170-03071	BSPFR188	331
170-03072	BSPFR148	331
170-03073	BSPFR128	331
170-03074	BSPFR348	331
170-03076	BSP143B	328
170-03077	BSP123B	328
170-03078	BSP343B	328
170-03079	BSP103B	328
170-03080	BSP1143B	328
170-03081	BSP1123B	328
170-03082	BSPSW143B	341
170-03083	BSPSW123B	341
170-03084	BSPSW343B	341
170-03085	BSPSW103B	341
170-03086	BSPSW1143B	341
170-03087	BSPSW1123B	341
170-03088	BSPSW203B	341
170-03089	BSPFR180B	331
170-03090	BSPFR140B	331
170-03091	BSPFR120B	331
170-03092	BSPFR340B	331
170-03093	BSPFR100B	331
170-03094	BSPFR1140B	331

Part No.	Type	Page
170-03095	BSPFR1120B	331
170-03097	BSHTTST212SR	337
170-03116	BSSCFR180B	332
170-03117	BSSCFR140B	332
170-03118	BSSCFR120B	332
170-03119	BSSCFR340B	332
170-03120	BSSCFR100B	332
170-03121	BSSCFR1140B	332
170-03122	BSSCFR1120B	332
170-03123	BSPSC180	329
170-03124	BSPSW180B	340
170-03125	BSPSW140B	340
170-03126	BSPSW120B	340
170-03127	BSPSW340B	340
170-03128	BSPSW100B	340
170-03129	BSPSW1140B	340
170-03130	BSPSW1120B	340
170-03131	BSPSW200B	340
170-03132	BSPSW180LB	340
170-03133	BSPSW140LB	340
170-03134	BSPSW120LB	340
170-03135	BSPSW340LB	340
170-03136	BSPSW100LB	340
170-03137	BSPSW1140LB	340
170-03138	BSPSW1120LB	340
170-03139	BSPSW200LB	340
170-03140	BSSWFR180B	334
170-03141	BSSWFR140B	334
170-03142	BSSWFR120B	334
170-03143	BSSWFR340B	334
170-03144	BSSWFR100B	334
170-03145	BSSWFR1140B	334
170-03146	BSSWFR1120B	334
170-03147	BSSWFR200B	334
170-03148	BSHKL120B	342
170-03149	BSHKL340B	342
170-03150	BSHKL1140B	342
170-03151	BSHKL200B	342
170-03152	BSHKL212B	342
170-03153	BSHKL120B	333
170-03154	BSHKL340B	333
170-03155	BSHKL140B	333
170-03156	BSHKL200B	333
170-03157	BSHKL212B	333
170-03158	BSNM185B	336
170-03159	BSNM145B	336
170-03160	BSNM385B	336
170-03161	BSNM125B	336
170-03162	BSNM345B	336
170-03163	BSNM105B	336
170-03164	BSNM1145B	336
170-03165	BSNM1125B	336
170-03166	BSNM1345B	336
170-03174	BSP180B	327
170-03175	BSHTTST38SR	337
170-03177	BSP180	327
170-03178	BSP200B	327
170-03181	BSSWV380B	339
170-03182	BSSWV120B	339
170-03183	BSSWV580B	339
170-03184	BSSWV340B	339
170-03185	BSSWV100B	339
170-03186	BSSWV1120B	339

Appendix

Index by Part Number

Part No.	Type	Page
170-03187	BSPFR380	331
170-03190	BSHTTSW145B	338
170-03191	BSHTTSW385B	338
170-03192	BSHTTSW125B	338
170-03193	BSHTTSW585B	338
170-03194	BSHTTSW345B	338
170-03195	BSHTTSW15B	338
170-03196	BSHTTSW1145B	338
170-03197	BSHTTSW1125B	338
170-03198	BSHTTSW25B	338
170-03199	BSHTTSW12LB	338
170-03200	BSHTTSW34LB	338
170-03201	BSHTTSW1LB	338
170-03202	BSHTTSW112LB	338
170-03203	BSHDWV	330
170-03204	BSHDWV	330
170-03205	BSHDWV	330
170-03206	BSHDWV	330
170-03207	BSHDWV	330
170-03209	BSPA66180	343
170-03210	BSPA66580	343
170-03213	BSPSW380LB	340
170-20400	HEGPA6604	344
170-20600	HEGPA6606	344
170-20800	HEGPA6608	344
170-21000	HEGPA6610	344
170-21200	HEGPA6612	344
170-22000	HEGPA6620	344
170-22500	HEGPA6625	344
170-23000	HEGPA6630	344
170-25000	HEGPA6650	344
175REF	175REF	436
181-00001	CSG	284
181-00002	CSW	284
181-00003	SCG	284
181-00004	SCW	284
181-00024	SL1X2	231
181-00026	SLA3X2	244
181-00027	SLA1.5X1.5	242
181-00136	SD1X3	262
181-00137	SD4X5	267
181-00142	SDA.75X.75	270
181-00147	SDA3X4	273
181-00148	SDA3X5	274
181-00149	SLHD3X5	251
181-00150	SLHD3X5	251
181-00151	SLHD3X5	251
181-00152	SLHDA4X3	259
181-00153	SLHDA4X3	259
181-00154	SLHDA4X3	259
181-00155	SLA3X5	245
181-00156	SLA3X5	245
181-00157	SLA3X5	245
181-00159	SLA3X3	244
181-00160	SL1.5X1	238
181-00164	SD3X2	265
181-00165	TC8	276
181-00166	TC8	276
181-00170	TD1X1	261
181-00172	SD1X2	261
181-00174	SD1X3	262
181-00175	SDA1.5X1	271
181-00176	SD1.5X1.5	262

Part No.	Type	Page
181-00185	SD4X2	266
181-00187	SD1X2	261
181-00189	SD1X3	262
181-00193	SD1.5X1.5	262
181-00195	SD1.5X2	263
181-00198	SD2X3	264
181-00200	SD3X2	265
181-00203	SD4X2	266
181-00204	SD2X1	264
181-00205	SD2X3	264
181-00210	SL4X3	239
181-00211	SL1.5X3	239
181-00212	SL2.5X3	235
181-00213	SL2.5X3	235
181-00214	SLA2.5X3	244
181-00215	SLA2.5X3	244
181-00216	SL2.5X3	235
181-00217	SL2.5X3	235
181-00218	SLA2.5X3	244
181-00219	SLA2.5X3	244
181-00220	SD2.5X3	265
181-00221	SD2.5X3	265
181-00222	SDA2.5X3	273
181-00223	SDA2.5X3	273
181-00224	SD2.5X3	265
181-00225	SD2.5X3	265
181-00226	SDA2.5X3	273
181-00227	SDA2.5X3	273
181-00228	SLHD2.5X3	250
181-00229	SLHD2.5X3	250
181-00230	SLHDA2.5X3	258
181-00231	SLHDA2.5X3	258
181-00232	SLHD2.5X3	250
181-00233	SLHD2.5X3	250
181-00234	SLHDA2.5X3	258
181-00235	SLHDA2.5X3	258
181-00236	SL2X5	235
181-00237	SL2X5	235
181-00238	SLA2X5	243
181-00239	SLA2X5	243
181-00240	SL2X5	235
181-00241	SL2X5	235
181-00242	SLA2X5	243
181-00243	SLA2X5	243
181-00244	SD2X5	265
181-00245	SD2X5	265
181-00246	SDA2X5	273
181-00248	SD2X5	265
181-00249	SD2X5	265
181-00250	SDA2X5	273
181-00252	SLHD2X5	250
181-00253	SLHD2X5	250
181-00254	SLHDA2X5	258
181-00257	SLHD2X5	250
181-00259	SLHDA2X5	258
181-00260	TC2.5	276
181-00261	TC2.5	276
181-00262	TC2.5	276
181-00263	TC2.5	276
181-00265	SLHD2X5	250
181-00275	SLHD1.5X1	247
181-00276	SLHD1.5X1	247
181-00284	SLHD2X1	249

Part No.	Type	Page
181-00300	DV1	278
181-00301	DV1.5	278
181-00302	DV2	278
181-00303	DV3	278
181-00304	DV4	278
181-00305	DV1	278
181-00306	DV1.5	278
181-00307	DV2	278
181-00308	DV3	278
181-00309	DV4	278
181-00310	SL1X3	231
181-00311	TC2.5	276
181-00312	SD2X5	265
181-00313	SDA2X5	273
181-00314	SD2.5X3	265
181-00315	SDA2.5X3	273
181-00316	SL2X5	235
181-00317	SLA2X5	243
181-00318	SL2.5X3	235
181-00319	SLA2.5X3	244
181-00320	SLHD2X5	250
181-00321	SLHDA2X5	258
181-00322	SLHD2.5X3	250
181-00323	SLHDA2.5X3	258
181-00325	SD1.5X1	262
181-00442	TC.5	275
181-00443	TC.5	275
181-00444	TC1	275
181-00445	TC.75	275
181-00446	TC.75	275
181-00447	TC.75	275
181-00448	TC6	276
181-00449	TC8	276
181-00450	TC8	276
181-00451	TC8	276
181-00452	SD.5X.5	260
181-00453	SD.5X.5	260
181-00456	SD.75X.75	261
181-00457	SD1X1.5	261
181-00458	SD1X2	261
181-00459	SD1X3	262
181-00460	SD1X4	262
181-00461	SD1X4	262
181-00462	SD1.5X2	263
181-00463	SD1.5X3	263
181-00464	SD1.5X3	263
181-00465	SD1.5X4	263
181-00467	SD1.5X4	263
181-00468	SD2X3	264
181-00469	SD2X4	264
181-00470	SD3X1	265
181-00471	SD3X2	265
181-00472	SD3X4	266
181-00473	SD3X5	266
181-00474	SD3X5	266
181-00475	SD3X5	266
181-00476	SD4X2	266
181-00477	SD4X3	267
181-00478	SD4X4	267
181-00479	SD6X4	267
181-00480	SD8X4	267
181-00482	SDA1.5X1.5	271
181-00483	SDA1.5X1.5	271

Part No.	Type	Page
181-00485	SDA1.5X1	271
181-00486	SDA1.5X1	271
181-00487	SDA1.5X2	271
181-00488	SDA1.5X2	271
181-00489	SDA1.5X3	272
181-00490	SDA1X1.5	271
181-00491	SDA1X1.5	271
181-00492	SDA1X1	270
181-00493	SDA1X1	270
181-00494	SDA1X2	271
181-00495	SDA1X2	271
181-00496	SDA1X3	271
181-00497	SDA1X4	271
181-00498	SDA2X1	272
181-00499	SDA2X1	272
181-00500	SDA2X1	272
181-00501	SDA2X2	272
181-00503	SDA2X3	272
181-00504	SDA2X3	272
181-00505	SDA2X4	272
181-00506	SDA2X4	272
181-00507	SDA3X1	273
181-00508	SDA3X1	273
181-00509	SDA3X2	273
181-00510	SDA3X2	273
181-00511	SDA3X3	273
181-00512	SDA3X3	273
181-00513	SDA3X3	273
181-00514	SDA3X4	273
181-00515	SDA3X4	273
181-00516	SDA4X2	274
181-00517	SDA4X2	274
181-00518	SDA4X3	274
181-00519	SDA4X3	274
181-00520	SDA4X4	274
181-00521	SDA4X4	274
181-00522	SDA4X5	274
181-00523	SDA4X5	274
181-00529	SDA1X1.5	271
181-00530	SDA1X2	271
181-00531	SDA1X3	271
181-00532	SDA1X4	271
181-00533	SDA1X4	271
181-00534	SDA1.5X2	271
181-00535	SDA1.5X3	272
181-00536	SDA1.5X3	272
181-00537	SDA1.5X4	272
181-00538	SDA1.5X4	272
181-00539	SDA1.5X4	272
181-00540	SDA2X3	272
181-00541	SDA2X4	272
181-00542	SDA3X2	273
181-00543	SDA3X5	274
181-00544	SDA3X5	274
181-00545	SDA4X2	274
181-00546	SDA4X3	274
181-00547	SDA4X5	274
181-00548	SL1.5X1	232
181-00550	SL1.5X3	233
181-00552	SL1X1.5	231
181-00554	SL2X1	234
181-00557	SL3X1	235
181-00558	SL3X1	235

Part No.	Type	Page
181-00560	SL3X5	236
181-00562	SL4X3	237
181-00563	SL4X4	239
181-00564	SLA1X1.5	240
181-00565	SLA1X2	241
181-00566	SLA1X3	241
181-00567	SLA1X4	241
181-00568	SLA1X4	241
181-00569	SLA1X4	241
181-00570	SLA1.5X1	241
181-00571	SLA1.5X1	241
181-00572	SLA1.5X1	241
181-00573	SLA1.5X2	242
181-00574	SD1.5X4	263
181-00575	SLA1.5X3	242
181-00576	SLA1.5X4	242
181-00577	SLA1.5X4	242
181-00578	SLA1.5X4	242
181-00579	SLA2X1	242
181-00580	SLA2X1	242
181-00581	SLA2X3	243
181-00582	SLA2X3	243
181-00583	SLA2X4	243
181-00584	SLA3X1	244
181-00585	SLA3X1	244
181-00586	SLA3X1	244
181-00588	SLA3X4	245
181-00589	SLA3X4	245
181-00590	SLA3X4	245
181-00591	SLA4X2	245
181-00592	SLA4X2	245
181-00593	SLA4X3	245
181-00594	SLA4X3	245
181-00595	SLA4X4	245
181-00596	SLA4X5	245
181-00597	SLHD1X1	246
181-00598	SLHD1X1.5	246
181-00599	SLHD1X2	247
181-00600	SLHD1X3	247
181-00601	SLHD1X4	247
181-00602	SLHD1.5X1	247
181-00603	SLHD1.5X1.5	248
181-00604	SLHD1.5X2	248
181-00605	SLHD1.5X3	248
181-00606	SLHD1.5X4	248
181-00607	SLHD2X1	249
181-00608	SLHD2X2	249
181-00609	SLHD2X3	249
181-00610	SLHD2X4	249
181-00611	SLHD3X1	250
181-00612	SLHD3X1	250
181-00613	SLHD3X1	250
181-00614	SLHD3X2	250
181-00615	SLHD3X3	251
181-00616	SLHD3X4	251
181-00617	SLHD4X2	252
181-00618	SLHD4X3	252
181-00619	SLHD4X4	252
181-00620	SLHDA1.5X4	257
181-00621	SLHDA1X1	255
181-00622	SLHDA1X1	255
181-00623	SLHDA1X1.5	256
181-00624	SLHDA1X2	256

Part No.	Type	Page
181-00625	SLHDA1X3	256
181-00626	SLHDA1X3	256
181-00627	SLHDA1X4	256
181-00628	SLHDA1X4	256
181-00629	SLHDA1X4	256
181-00630	SLHDA1.5X1	256
181-00631	SLHDA1.5X1	256
181-00632	SLHDA1.5X1	256
181-00633	SLHDA1.5X1.5	257
181-00634	SLHDA1.5X2	257
181-00635	SLHDA1.5X3	257
181-00636	SLHDA1.5X3	257
181-00637	SLHDA1X1	255
181-00638	SLHDA1.5X4	257
181-00639	SLHDA1.5X4	257
181-00640	SLHDA2X1	257
181-00641	SLHDA2X1	257
181-00642	SLHDA2X1	257
181-00643	SLHDA2X2	257
181-00644	SLHDA2X2	257
181-00645	SLHDA2X3	258
181-00646	SLHDA2X3	258
181-00647	SLHDA2X4	258
181-00648	SLHDA2X4	258
181-00649	SLHDA3X1	258
181-00651	SLHDA3X1	258
181-00652	SLHDA3X1	258
181-00653	SLHDA3X2	259
181-00654	SLHDA3X2	259
181-00655	SLHDA3X2	259
181-00656	SLHDA3X3	259
181-00657	SLHDA3X3	259
181-00658	SLHDA3X4	259
181-00659	SLHDA3X4	259
181-00660	SLHDA3X5	259
181-00661	SLHDA3X5	259
181-00662	SLHDA3X5	259
181-00663	SLHDA4X2	259
181-00664	SLHDA4X2	259
181-00665	SLHDA4X2	259
181-00666	SLHDA4X4	259
181-00667	SLHDA4X4	259
181-00668	SLHDA4X5	259
181-00669	SLHDA4X5	259
181-00670	SLHDA4X5	259
181-00671	SDA1X3	271
181-00672	SDA3X1	273
181-00676	SLHDA2X1	257
181-00680	SLA4X4	245
181-00681	SLA2X2	243
181-00684	DVM	279
181-00686	SLHD3X4	254
181-00690	SLHD4X5	252
181-00691	SLHD4X5	252
181-00692	SLHD4X5	252
181-01400	SD3X5	266
181-05100	SD.5X1	260
181-05102	SD.5X1	260
181-05500	SD.5X.5	260
181-05501	SD.5X.5	260
181-05503	SD.5X.5	260
181-05505	SD.5X.5	260
181-05510	SD.5X1	260

Appendix

Index by Part Number

Part No.	Type	Page
181-05514	SD.75X.75	261
181-05515	SD.75X.75	261
181-05518	SD1X1	268
181-05519	SD1X1	261
181-05527	SD1X1.5	268
181-05529	SL1X1.5	231
181-05532	SLHD1X1.5	253
181-05539	SLHD1.5X1	247
181-05540	SD1.5X1.5	268
181-05546	SD1.5X2	268
181-05547	SD1.5X2	263
181-05550	SL1.5X2	238
181-05551	SL1.5X2	233
181-05555	SD3X1	269
181-05561	SL3X1	235
181-05565	SL1X2	231
181-05567	SD1X3	268
181-05568	SD1X3	262
181-05571	SD1X2	261
181-05572	SD1X2	268
181-05573	SD1X4	268
181-05580	SL1X4	238
181-05581	SL1X4	232
181-05583	SD1.5X1	268
181-05584	SD1.5X1	262
181-05585	SD1.5X1	262
181-05588	SL1.5X1	232
181-05593	SD4X2	269
181-05594	SD4X2	266
181-05596	SL4X2	239
181-05599	SD4X4	269
181-05603	SD4X5	269
181-05604	SL4X5	239
181-11000	SD1X1	261
181-11002	SD1X1	261
181-11004	SD1X1	261
181-11005	SD1X1	261
181-11006	SDA1X1	270
181-11008	SDA1X1	270
181-11009	SL1x1	230
181-11011	SL1x1	230
181-11013	SL1x1	230
181-11014	SL1x1	230
181-11015	SL1x1	230
181-11016	SLA1X1	240
181-11017	SLA1X1	240
181-11019	SLA1X1	240
181-11021	SLA1X1	240
181-11501	SD1X1.5	261
181-11502	SD1X1.5	261
181-11503	SL1X1.5	231
181-11505	SL1X1.5	231
181-11506	SL1X1.5	231
181-11507	SL1X1.5	231
181-11509	SLA1X1.5	240
181-11510	SLA1X1.5	240
181-11511	SLA1X1.5	240
181-12001	SD1X2	261
181-12002	SD1X2	261
181-12003	SL1X2	238
181-12004	SL1X2	231
181-12005	SL1X2	231
181-12007	SL1X2	231

Part No.	Type	Page
181-12008	SL1X2	231
181-12010	SLA1X2	241
181-12011	SLA1X2	241
181-12012	SLA1X2	241
181-12013	SLA1X2	241
181-13001	SD1X3	262
181-13003	SL1X3	231
181-13004	SL1X3	238
181-13005	SL1X3	231
181-13006	SL1X3	231
181-13007	SL1X3	231
181-13008	SL1X3	231
181-13009	SLA1X3	241
181-13010	SLA1X3	241
181-13011	SLA1X3	241
181-13012	SLA1X3	241
181-14000	SD1X4	262
181-14001	SL1X4	232
181-14002	SL1X4	232
181-14003	SL1X4	232
181-14005	SL1X4	232
181-14006	SL1X4	232
181-15100	SD1.5X1	262
181-15101	SD1.5X1	262
181-15102	SD1.5X1	262
181-15103	SL1.5X1	238
181-15104	SL1.5X1	232
181-15105	SL1.5X1	232
181-15106	SL1.5X1	232
181-15107	SL1.5X1	232
181-15108	SLA1.5X1	241
181-15109	SLA1.5X1	241
181-15200	SD1.5X2	263
181-15201	SD1.5X2	263
181-15202	SD1.5X2	263
181-15203	SL1.5X2	233
181-15206	SL1.5X2	233
181-15207	SL1.5X2	233
181-15208	SL1.5X2	233
181-15209	SL1.5X2	233
181-15210	SLA1.5X2	242
181-15211	SLA1.5X2	242
181-15212	SLA1.5X2	242
181-15213	SLA1.5X2	242
181-15300	SD1.5X3	263
181-15302	SL1.5X3	233
181-15304	SL1.5X3	233
181-15305	SL1.5X3	233
181-15306	SL1.5X3	233
181-15307	SLA1.5X3	242
181-15308	SLA1.5X3	242
181-15400	SL1.5X4	233
181-15403	SL1.5X4	233
181-15404	SL1.5X4	233
181-15405	SL1.5X4	233
181-15406	SL1.5X4	233
181-15500	SD1.5X1.5	262
181-15502	SD1.5X1.5	262
181-15503	SD1.5X1.5	262
181-15504	SDA1.5X1.5	271
181-15505	SL1.5X1.5	232
181-15506	SL1.5X1.5	238
181-15507	SL1.5X1.5	232

Part No.	Type	Page
181-15509	SL1.5X1.5	232
181-15510	SL1.5X1.5	232
181-15511	SL1.5X1.5	232
181-15512	SLA1.5X1.5	242
181-15513	SLA1.5X1.5	242
181-15514	SLA1.5X1.5	242
181-15515	SLA1.5X1.5	242
181-15517	SD1.5X1.5	262
181-21000	SD2X1	264
181-21001	SD2X1	264
181-21002	SD2X1	264
181-21003	SD2X1	264
181-21004	SL2X1	234
181-21005	SL2X1	234
181-21006	SL2X1	234
181-21007	SL2X1	234
181-21008	SLA2X1	242
181-21009	SLA2X1	242
181-21010	SLA2X1	242
181-22005	SD2X2	264
181-22006	SD2X2	264
181-22008	SD2X2	264
181-22011	SD2X2	264
181-22013	SD2X2	264
181-22016	SDA2X2	272
181-22017	SDA2X2	272
181-22018	SDA2X2	272
181-22019	SL2X2	234
181-22020	SL2X2	234
181-22021	SL2X2	239
181-22022	SL2X2	234
181-22024	SL2X2	234
181-22027	SL2X2	234
181-22028	SL2X2	234
181-22031	SLA2X2	243
181-22032	SLA2X2	243
181-22033	SLA2X2	243
181-22034	SLA2X2	243
181-23000	SD2X3	264
181-23001	SD2X3	264
181-23002	SD2X3	264
181-23003	SL2X3	234
181-23004	SL2X3	239
181-23005	SL2X3	234
181-23007	SL2X3	234
181-23008	SL2X3	234
181-23009	SL2X3	234
181-23010	SLA2X3	243
181-23011	SLA2X3	243
181-23012	SLA2X3	243
181-23013	SL2X3	234
181-23020	SD2X2	269
181-23021	SD2X2	264
181-23022	SD2X3	269
181-23025	SD2X4	269
181-23032	SD2X5	269
181-23033	SD2X5	265
181-23035	SL2X5	239
181-23036	SL2X5	235
181-23038	SD2.5X3	269
181-23039	SD2.5X3	265
181-23040	SD3X2	269
181-23044	SL3X2	239

Part No.	Type	Page
181-23045	SD3X4	269
181-23046	SD3X4	266
181-23048	SD3X4	266
181-23052	SL3X4	239
181-23056	SD3X5	269
181-23057	SD3X5	266
181-23058	SD3X5	266
181-23062	SL3X5	239
181-23063	SD1.5X3	268
181-23064	SD1.5X3	263
181-23065	SD1.5X3	263
181-23071	SD1.5X4	269
181-23072	SD1.5X4	263
181-23073	SD1.5X4	263
181-23074	SD1.5X4	263
181-23078	SL1.5X4	239
181-23079	SL1.5X4	233
181-23081	SD2X1	269
181-23082	SD2X1	264
181-23085	SL2X1	239
181-23091	SL2.5X3	239
181-23092	SL2.5X3	235
181-23094	SD3X3	269
181-23097	SD4X3	269
181-23104	SL4X3	237
181-24000	SD2X4	264
181-24001	SD2X4	264
181-24002	SD2X4	264
181-24003	SL2X4	234
181-24005	SL2X4	234
181-24006	SL2X4	239
181-24007	SL2X4	234
181-24008	SL2X4	234
181-24010	SL2X4	234
181-24011	SL2X4	234
181-24013	SLA2X4	243
181-24014	SLA2X4	243
181-31001	SD3X1	265
181-31002	SD3X1	265
181-31003	SL3X1	239
181-31004	SL3X1	235
181-31006	SL3X1	235
181-31007	SL3X1	235
181-32002	SD3X2	265
181-32003	SD3X2	265
181-32004	SL3X2	236
181-32005	SL3X2	236
181-32006	SL3X2	236
181-32008	SL3X2	236
181-32009	SL3X2	236
181-32010	SLA3X2	244
181-32012	SLA3X2	244
181-32014	SLA3X2	244
181-32015	SLA3X2	244
181-32016	SL3X2	236
181-33000	SD3X3	266
181-33002	SD3X3	266
181-33004	SD3X3	266
181-33005	SD3X3	266
181-33006	SD3X3	266
181-33008	SL3X3	236
181-33009	SL3X3	236
181-33012	SL3X3	239

Part No.	Type	Page
181-33014	SL3X3	236
181-33016	SL3X3	236
181-33017	SL3X3	236
181-33018	SL3X3	236
181-33019	SLA3X3	244
181-33020	SLA3X3	244
181-33021	SLA3X3	244
181-33022	SLA3X3	244
181-33023	SLA3X3	244
181-34000	SD3X4	266
181-34001	SD3X4	266
181-34002	SL3X4	236
181-34003	SL3X4	236
181-34004	SL3X4	236
181-34006	SL3X4	236
181-34007	SL3X4	236
181-34009	SLA3X4	245
181-34021	SL3X4	236
181-35001	SL3X5	236
181-35002	SL3X5	236
181-35005	SL3X5	236
181-35006	SL3X5	236
181-42002	SD4X2	266
181-42004	SD4X2	266
181-42005	SL4X2	237
181-42006	SL4X2	237
181-42008	SL4X2	237
181-42009	SL4X2	237
181-42010	SL4X2	237
181-42012	SLA4X2	245
181-42014	SLA4X2	245
181-42020	SL4X2	237
181-43001	SD4X3	267
181-43002	SD4X3	267
181-43003	SL4X3	237
181-43004	SL4X3	237
181-43005	SL4X3	237
181-43006	SL4X3	237
181-43008	SLA4X3	245
181-44006	SD4X4	267
181-44007	SD4X4	267
181-44009	SD4X4	267
181-44013	SD4X4	267
181-44015	SD4X4	267
181-44018	SDA4X4	274
181-44019	SL4X4	237
181-44020	SL4X4	237
181-44024	SL4X4	239
181-44025	SL4X4	237
181-44027	SL4X4	237
181-44030	SL4X4	237
181-44031	SL4X4	237
181-44033	SLA4X4	245
181-44035	SLA4X4	245
181-45000	SD4X5	267
181-45001	SD4X5	267
181-45002	SL4X5	237
181-45010	SL4X5	237
181-45011	SL4X5	237
181-45012	SLA4X5	245
181-45013	SLA4X5	245
181-64000	SD6X4	267
181-75750	SD.75X.75	261

Part No.	Type	Page
181-75752	SDA.75X.75	270
181-84004	SD8X4	267
181-84007	SD8X4	267
181-90050	TC.5	275
181-90051	TC.5	275
181-90052	TC.5	275
181-90750	TC.75	275
181-90751	TC.75	275
181-91000	TC1	275
181-91002	TC1	277
181-91003	TC1	275
181-91004	TC1	275
181-91007	TC1	275
181-91008	TC1	275
181-91503	TC1.5	276
181-91505	TC1.5	277
181-91506	TC1.5	276
181-91507	TC1.5	276
181-91509	TC1.5	276
181-91510	TC1.5	276
181-91516	TC1.5	276
181-91517	TC.5	275
181-92001	TC2	276
181-92002	TC2	277
181-92003	TC2	277
181-92004	TC2	276
181-92005	TC2	276
181-92010	TC2	276
181-92011	TC2	276
181-92015	TC2	276
181-93000	TC3	276
181-93003	TC3	276
181-93005	TC3	277
181-93007	TC3	276
181-93008	TC3	276
181-93010	TC3	276
181-93011	TC3	276
181-94000	TC4	276
181-94003	TC4	276
181-94007	TC4	277
181-94008	TC4	276
181-94009	TC4	276
181-94013	TC4	276
181-94014	TC4	276
181-96000	TC6	276
181-96002	TC6	276
184-05524	SLHD1X1	253
184-05525	SLHD1X1	246
184-05534	SLHD1X1.5	246
184-05537	SLHD1.5X1	253
184-05543	SLHD1.5X1.5	253
184-05544	SLHD1.5X1.5	248
184-05553	SLHD1.5X2	253
184-05557	SLHD3X5	254
184-05558	SLHD3X5	251
184-05559	SLHD3X5	251
184-05560	SLHD3X5	251
184-05564	SLHD4X2	254
184-05565	SLHD3X1	254
184-05566	SLHD3X1	250
184-05567	SLHD1X2	247
184-05568	SLHD1X3	253
184-05570	SLHD1X2	253

Appendix

Index by Part Number

Part No.	Type	Page
184-05571	SLHD1X4	253
184-05572	SLHD1X4	247
184-05576	SLHD4X4	252
184-05603	SLHD4X4	254
184-11000	SLHD1X1	246
184-11001	SLHDA1X1	255
184-11002	SLHDA1X1	255
184-11004	SLHD1X1	246
184-11005	SLHD1X1	246
184-11006	SLHD1X1	246
184-11007	SLHD1X1.5	246
184-11008	SLHDA1X1.5	256
184-11009	SLHDA1X1.5	256
184-11010	SLHD1X1.5	246
184-11011	SLHD1X1.5	246
184-11012	SLHD1X1.5	246
184-12000	SLHD1X2	247
184-12001	SLHDA1X2	256
184-12002	SLHDA1X2	256
184-12003	SLHDA1X2	256
184-12004	SLHDA1X2	256
184-12005	SLHD1X2	247
184-12006	SLHD1X2	247
184-12007	SLHD1X2	247
184-12019	SLHD1X3	247
184-13000	SLHD1X3	247
184-13001	SLHDA1X3	256
184-13002	SLHDA1X3	256
184-13003	SLHDA1X3	256
184-13005	SLHD1X3	247
184-13006	SLHD1X3	247
184-13007	SLHD1X3	247
184-14000	SLHD1X4	247
184-14002	SLHD1X4	247
184-14003	SLHD1X4	247
184-14004	SLHD1X4	247
184-15101	SLHD1.5X1	247
184-15102	SLHD1.5X1	247
184-15150	SLHD1.5X1.5	248
184-15151	SLHDA1.5X1.5	257
184-15152	SLHD1.5X1.5	248
184-15153	SLHDA1.5X1.5	257
184-15154	SLHD1.5X1.5	248
184-15155	SLHD1.5X1.5	248
184-15200	SLHD1.5X2	248
184-15201	SLHDA1.5X2	257
184-15202	SLHD1.5X2	248
184-15204	SLHD1.5X2	248
184-15205	SLHDA1.5X2	257
184-15206	SLHD1.5X2	248
184-15214	SLHD1.5X2	248
184-15300	SLHD1.5X3	248
184-15301	SLHDA1.5X3	257
184-15302	SLHD1.5X3	248
184-15303	SLHD1.5X3	248
184-15304	SLHD1.5X3	248
184-15400	SLHD1.5X4	248
184-15401	SLHD1.5X4	248
184-15402	SLHD1.5X4	248
184-15403	SLHD1.5X4	248
184-21000	SLHD2X1	249
184-21001	SLHDA2X1	257
184-21002	SLHD2X1	249

Part No.	Type	Page
184-21003	SLHD2X1	249
184-21006	SLHD2X1	249
184-22000	SLHD2X2	249
184-22001	SLHDA2X2	257
184-22002	SLHDA2X2	257
184-22003	SLHDA2X2	257
184-22005	SLHD2X2	249
184-22006	SLHD2X2	249
184-22007	SLHD2X2	249
184-22008	SLHD2X2	249
184-22022	SLHD2X2	254
184-22024	SLHD2X3	254
184-22025	SLHD2X3	249
184-22026	SLHD2X4	254
184-22028	SLHD2X5	254
184-22029	SLHD2X5	250
184-22032	SLHD3X4	251
184-22034	SLHD1.5X3	254
184-22035	SLHD1.5X3	248
184-22037	SLHD1.5X4	254
184-22038	SLHD1.5X4	248
184-22040	SLHD2X1	254
184-22044	SLHD3X2	254
184-22050	SLHD2.5X3	254
184-22051	SLHD2.5X3	250
184-22053	SLHD3X3	254
184-22055	SLHD4X3	254
184-22056	SLHD4X3	252
184-22060	SLHD3X1	250
184-22061	SLHD3X1	250
184-23000	SLHD2X3	249
184-23001	SLHDA2X3	258
184-23002	SLHDA2X3	258
184-23003	SLHDA2X3	258
184-23004	SLHD2X3	249
184-23005	SLHD2X3	249
184-23006	SLHD2X3	249
184-24000	SLHD2X4	249
184-24001	SLHDA2X4	258
184-24002	SLHDA2X4	258
184-24003	SLHDA2X4	258
184-24004	SLHD2X4	249
184-24006	SLHD2X4	249
184-24007	SLHD2X4	249
184-32000	SLHD3X2	250
184-32001	SLHD3X2	250
184-32002	SLHD3X2	250
184-32003	SLHD3X2	250
184-32004	SLHD3X2	250
184-33000	SLHD3X3	251
184-33001	SLHDA3X3	259
184-33002	SLHD3X3	251
184-33003	SLHD3X3	251
184-33004	SLHD3X3	251
184-33014	SLHD3X3	251
184-34000	SLHD3X4	251
184-34001	SLHDA3X4	259
184-34003	SLHD3X4	251
184-34004	SLHD3X4	251
184-34005	SLHD3X4	251
184-42000	SLHD4X2	252
184-42001	SLHD4X2	252
184-42002	SLHD4X2	252

Part No.	Type	Page
184-42003	SLHD4X2	252
184-42004	SLHD4X2	252
184-43000	SLHD4X3	252
184-43001	SLHD4X3	252
184-43002	SLHD4X3	252
184-43003	SLHD4X3	252
184-44000	SLHD4X4	252
184-44001	SLHDA4X4	259
184-44002	SLHD4X4	252
184-44003	SLHD4X4	252
184-44004	SLHD4X4	252
190-00303	SNP14A	198
1FRPOC	1FRP	356
1FRP9C	1FRP	356
1NOC	1N	354
1N9C	1N	354
1NFP0C	1NFP	355
1NFP9C	1NFP	355
1P9C	1P	357
2.5FRPOC	2.5FRP	356
2.5FRP9C	2.5FRP	356
2.5N0C	2.5N	354
2.5N9C	2.5N	354
2.5NFP0C	2.5NFP	355
2.5NFP9C	2.5NFP	355
2.5P9C	2.5P	357
201-20010	R1	351
211-00261	H1P	200
211-00262	H2P	200
211-00263	H2P	200
211-00264	H3P	200
211-00266	H5P	200
211-00267	H5P	200
211-00269	H7P	201
211-00271	H9P	201
211-60000	H1P	200
211-60001	H2P	200
211-60002	H3P	200
211-60003	H4P	200
211-60004	H5P	200
211-60005	H6P	200
211-60006	H7P	201
211-60007	H8P	201
211-60008	H9P	201
211-60009	H10P	201
211-60010	H1P	200
211-60019	H1P	200
211-60029	H2P	200
211-60039	H3P	200
211-60040	H3P	200
211-60049	H4P	200
211-60050	H4P	200
211-60059	H5P	200
211-60061	H6P	200
211-60078	H7P	201
211-60079	H7P	201
211-60089	H8P	201
211-60090	H8P	201
211-60099	H9P	201
211-60130	H12P	201
211-60140	H13P	201
211-60150	H14P	201
211-60160	H15P	201

Part No.	Type	Page
251-30309	G51TC	365
251-30409	G51TD	365
251-30509	G51TE	365
251-30609	G51TF	365
251-30709	G51TG	365
251-30809	G51TH	365
2FRPOC	2FRP	356
2FRP9C	2FRP	356
2NOC	2N	354
2N9C	2N	354
2NFPOC	2NFP	355
2NFPP9C	2NFP	355
2P9C	2P	357
300-73601	TCN20-1.6/0.8	380
300-73602	TCN20-2.4/1.2	380
300-73603	TCN20-3.2/1.6	380
300-73604	TCN20-4.8/2.4	380
300-73606	TCN20-9.5/4.8	380
300-73607	TCN20-12.7/6.4	380
300-73608	TCN20-19.1/9.5	380
300-73609	TCN20-25.4/12.7	380
300-73610	TCN20-38.1/19.1	380
300-73611	TCN20-50.8/25.4	380
308-30320	HIS-3-BAG 3/1 BK	369
308-30321	HIS-3-BAG 3/1 CL	369
308-30420	HIS-3-BAG 4.5/1.5 BK	369
308-30421	HIS-3-BAG 4.5/1.5 CL	369
308-30620	HIS-3-BAG 6/2 BK	369
308-30621	HIS-3-BAG 6/2 CL	369
308-30920	HIS-3-BAG 9/3 BK	369
308-30921	HIS-3-BAG 9/3 CL	369
308-31220	HIS-3-BAG 12/4 BK	369
308-31221	HIS-3-BAG 12/4 CL	369
309-60107	TFN21 1.6/0.8	373
309-60108	TFN21 1.6/0.8	373
309-60109	TFN21 1.6/0.8	373
309-60118	TFN21 2.4/1.2	373
309-60197	TFN21 1.2/0.6	373
309-60280	TFN21 1.6/0.8	373
309-60281	TFN21 1.6/0.8	373
309-60282	TFN21 1.6/0.8	373
309-60283	TFN21 1.6/0.8	373
309-60284	TFN21 1.6/0.8	373
309-60285	TFN21 2.4/1.2	373
309-60286	TFN21 2.4/1.2	373
309-60287	TFN21 2.4/1.2	373
309-60288	TFN21 2.4/1.2	373
309-60289	TFN21 2.4/1.2	373
309-60290	TFN21 3.2/1.6	374
309-60291	TFN21 3.2/1.6	374
309-60292	TFN21 3.2/1.6	374
309-60293	TFN21 3.2/1.6	374
309-60294	TFN21 4.8/2.4	374
309-60295	TFN21 4.8/2.4	374
309-60296	TFN21 4.8/2.4	374
309-60297	TFN21 4.8/2.4	374
309-60298	TFN21 6.4/3.2	374
309-60299	TFN21 6.4/3.2	374
309-60300	TFN21 6.4/3.2	374
309-60301	TFN21 6.4/3.2	374
309-60302	TFN21 9.5/4.8	374
309-60303	TFN21 9.5/4.8	374
309-60304	TFN21 9.5/4.8	374

Part No.	Type	Page
309-60305	TFN21 9.5/4.8	374
309-60306	TFN21 12.7/6.4	374
309-60307	TFN21 12.7/6.4	374
309-60308	TFN21 12.7/6.4	374
309-60309	TFN21 12.7/6.4	374
309-60310	TFN21 16.0/8.0	375
309-60311	TFN21 19.1/9.5	375
309-60312	TFN21 19.1/9.5	375
309-60313	TFN21 19.1/9.5	375
309-60314	TFN21 19.1/9.5	375
309-60315	TFN21 25.4/12.7	375
309-60316	TFN21 25.4/12.7	375
309-60317	TFN21 25.4/12.7	375
309-60318	TFN21 25.4/12.7	375
309-60319	TFN21 31.8/16.0	375
309-60320	TFN21 31.8/16.0	375
309-60321	TFN21 31.8/16.0	375
309-60322	TFN21 31.8/16.0	375
309-60323	TFN21 31.8/16.0	375
309-60324	TFN21 31.8/16.0	375
309-60325	TFN21 31.8/16.0	375
309-60326	TFN21 38.1/19.1	375
309-60327	TFN21 38.1/19.1	375
309-60328	TFN21 38.1/19.1	375
309-60329	TFN21 38.1/19.1	375
309-60330	TFN21 38.1/19.1	375
309-60331	TFN21 38.1/19.1	375
309-60332	TFN21 50.8/25.4	375
309-60333	TFN21 50.8/25.4	375
309-60334	TFN21 50.8/25.4	375
309-60335	TFN21 50.8/25.4	375
309-60336	TFN21 50.8/25.4	375
309-60337	TFN21 50.8/25.4	375
309-60338	TFN21 50.8/25.4	375
309-65100	TFN21-ST 1.6/0.8	376
309-65101	TFN21-ST 1.6/0.8	376
309-65102	TFN21-ST 1.6/0.8	376
309-65103	TFN21-ST 1.6/0.8	376
309-65104	TFN21-ST 1.6/0.8	376
309-65105	TFN21-ST 1.6/0.8	376
309-65106	TFN21-ST 1.6/0.8	376
309-65110	TFN21-ST 2.4/1.2	376
309-65111	TFN21 2.4/1.2	373
309-65112	TFN21 2.4/1.2	373
309-65113	TFN21-ST 2.4/1.2	376
309-65114	TFN21-ST 2.4/1.2	376
309-65115	TFN21-ST 2.4/1.2	376
309-65116	TFN21-ST 2.4/1.2	376
309-65117	TFN21-ST 2.4/1.2	376
309-65118	TFN21-ST 2.4/1.2	376
309-65120	TFN21 3.2/1.6	374
309-65121	TFN21 3.2/1.6	374
309-65122	TFN21 3.2/1.6	374
309-65123	TFN21 3.2/1.6	374
309-65124	TFN21-ST 3.2/1.6	377
309-65125	TFN21-ST 3.2/1.6	377
309-65126	TFN21-ST 3.2/1.6	377
309-65127	TFN21-ST 3.2/1.6	377
309-65128	TFN21-ST 3.2/1.6	377
309-65129	TFN21-ST 3.2/1.6	377
309-65130	TFN21 4.8/2.4	374
309-65131	TFN21 4.8/2.4	374
309-65132	TFN21 4.8/2.4	374

Part No.	Type	Page
309-65133	TFN21 4.8/2.4	374
309-65134	TFN21-ST 4.8/2.4	377
309-65135	TFN21-ST 4.8/2.4	377
309-65136	TFN21-ST 4.8/2.4	377
309-65137	TFN21-ST 4.8/2.4	377
309-65138	TFN21-ST 4.8/2.4	377
309-65139	TFN21-ST 4.8/2.4	377
309-65140	TFN21 6.4/3.2	374
309-65141	TFN21 6.4/3.2	374
309-65142	TFN21 6.4/3.2	374
309-65143	TFN21 6.4/3.2	374
309-65144	TFN21-ST 6.4/3.2	377
309-65145	TFN21-ST 6.4/3.2	377
309-65146	TFN21-ST 12.7/6.4	377
309-65147	TFN21-ST 6.4/3.2	377
309-65148	TFN21-ST 6.4/3.2	377
309-65149	TFN21-ST 6.4/3.2	377
309-65150	TFN21 9.5/4.8	374
309-65151	TFN21 9.5/4.8	374
309-65152	TFN21 9.5/4.8	374
309-65153	TFN21 9.5/4.8	374
309-65154	TFN21-ST 9.5/4.8	377
309-65155	TFN21-ST 9.5/4.8	377
309-65156	TFN21-ST 9.5/4.8	377
309-65157	TFN21-ST 9.5/4.8	377
309-65158	TFN21-ST 9.5/4.8	377
309-65159	TFN21-ST 9.5/4.8	377
309-65160	TFN21 12.7/6.4	374
309-65161	TFN21 12.7/6.4	374
309-65162	TFN21 12.7/6.4	374
309-65163	TFN21 12.7/6.4	374
309-65164	TFN21-ST 12.7/6.4	377
309-65165	TFN21-ST 12.7/6.4	377
309-65166	TFN21-ST 6.4/3.2	377
309-65167	TFN21-ST 12.7/6.4	377
309-65168	TFN21-ST 12.7/6.4	377
309-65169	TFN21-ST 12.7/6.4	377
309-65170	TFN21 19.1/9.5	375
309-65171	TFN21 19.1/9.5	375
309-65172	TFN21 19.1/9.5	375
309-65173	TFN21 19.1/9.5	375
309-65174	TFN21-ST 19.1/9.5	378
309-65175	TFN21-ST 19.1/9.5	378
309-65176	TFN21-ST 19.1/9.5	378
309-65177	TFN21-ST 19.1/9.5	378
309-65178	TFN21-ST 19.1/9.5	378
309-65179	TFN21-ST 19.1/9.5	378
309-65180	TFN21 25.4/12.7	375
309-65181	TFN21 25.4/12.7	375
309-65182	TFN21 25.4/12.7	375
309-65183	TFN21 25.4/12.7	375
309-65184	TFN21-ST 25.4/12.7	378
309-65192	TFN21 38.1/19.1	375
309-65193	TFN21-ST 38.1/19.1	378
309-65194	TFN21-ST 38.1/19.1	378
309-65195	TFN21-ST 3.2/1.6	377
309-65210	TFN21-ST 50.8/25.4	378
309-65211	TFN21-ST 50.8/25.4	378
309-65212	TFN21-ST 50.8/25.4	378
309-65213	TFN21-ST 50.8/25.4	378
309-65214	TFN21-ST 50.8/25.4	378
309-65215	TFN21-ST 50.8/25.4	378
309-65216	TFN21-ST 50.8/25.4	378

Appendix

Index by Part Number

Part No.	Type	Page
309-65220	TFN21-ST 76.2/38.1	379
309-65221	TFN21-ST 76.2/38.1	379
309-65222	TFN21-ST 76.2/38.1	379
309-65223	TFN21-ST 76.2/38.1	379
309-65224	TFN21-ST 76.2/38.1	379
309-65225	TFN21-ST 76.2/38.1	379
309-65226	TFN21-ST 76.2/38.1	379
309-65227	TFN21 76.2/38.1	375
309-65230	TFN21-ST 102/50.8	379
309-65231	TFN21-ST 102/50.8	379
309-65232	TFN21-ST 102/50.8	379
309-65233	TFN21-ST 102/50.8	379
309-65234	TFN21-ST 102/50.8	379
309-65235	TFN21-ST 102/50.8	379
309-65236	TFN21-ST 102/50.8	379
309-65237	TFN21 102.0/50.8	375
309-65270	TFN21-ST 31.8/16.0	378
309-65271	TFN21-ST 31.8/16.0	378
309-65272	TFN21-ST 31.8/16.0	378
309-65273	TFN21-ST 31.8/16.0	378
309-65274	TFN21-ST 31.8/16.0	378
309-65275	TFN21-ST 31.8/16.0	378
309-65276	TFN21-ST 31.8/16.0	378
309-65280	TFN21-ST 25.4/12.7	378
309-65290	TFN21-ST 4.8/2.4	377
309-65291	TFN21-ST 6.4/3.2	377
309-65292	TFN21-ST 6.4/3.2	377
309-65293	TFN21-ST 9.5/4.8	377
309-65294	TFN21-ST 12.7/6.4	377
309-65295	TFN21-ST 12.7/6.4	377
309-65296	TFN21-ST 19.1/9.5	378
309-65297	TFN21-ST 25.4/12.7	378
309-65298	TFN21-ST 25.4/12.7	378
309-65299	TFN21-ST 25.4/12.7	378
309-65300	TFN21-ST 25.4/12.7	378
309-65301	TFN21-ST 25.4/12.7	378
309-65302	TFN21-ST 38.1/19.1	378
309-65303	TFN21-ST 38.1/19.1	378
309-65304	TFN21-ST 38.1/19.1	378
309-65305	TFN21-ST 38.1/19.1	378
309-65306	TFN21-ST 38.1/19.1	378
318-60150	TAN33-ST-3/1 BK	372
318-60151	TAN33-ST-4.8/1.5 BK	372
318-60152	TAN33-ST-6/2 BK	372
318-60153	TAN33-ST-9/3 BK	372
318-60154	TAN33-ST-12/4 BK	372
318-60155	TAN33-ST-19/6 BK	372
318-60156	TAN33-ST-24/8 BK	372
318-60158	TAN33-ST-40/13 BK	372
321-50010	TREDUX HA47-48ST-13/4	382
321-50011	TREDUX HA47-48ST-19/6	382
321-50012	TREDUX HA47-48ST-33/8	382
321-50013	TREDUX HA47-48ST-45/12	382
321-50014	TREDUX HA47-48ST-51/16	382
321-50015	TREDUX HA47-48ST-68/22	382
321-50016	TREDUX HA47-48ST-85/25	382
323-50010	TREDUX MA47-48ST-12/3	381
323-50011	TREDUX MA47-48ST-19/6	381
323-50012	TREDUX MA47-48ST-30/8	381
323-50013	TREDUX MA47-48ST-40/12	381
323-50014	TREDUX MA47-48ST-50/16	381
323-50015	TREDUX MA47-48ST-63/19	381
323-50016	TREDUX MA47-48ST-75/22	381

Part No.	Type	Page
323-50017	TREDUX MA47-48ST-95/30	381
333-41500	TFN31 3/1	370
333-41501	TFN31 6/2	370
333-41502	TFN31 9/3	370
333-41503	TFN31 12/4	370
333-41504	TFN31 18/6	370
333-41505	TFN31 24/8	370
333-41506	TFN31 39/13	370
333-41507	TFN31-ST-1.5/0.5	371
333-41508	TFN31-ST-3/1	371
333-41509	TFN31-ST-4.5/1.5	371
333-41510	TFN31-ST-6/2	371
333-41511	TFN31-ST-9/3	371
333-41512	TFN31-ST-12/4	371
333-41513	TFN31-ST-18/6	371
333-41514	TFN31-ST-24/8	371
380-03001	ShrinkKit 321 Basic	367
380-03005	ShrinkKit 321 Universal Basic	368
3FRPOC	3FRP	356
3FRP9C	3FRP	356
3NOC	3N	354
3N9C	3N	354
3NFP9C	3NFP	355
3NFP9C	3NFP	355
3P9C	3P	357
4FRPOC	4FRP	356
4FRP9C	4FRP	356
4NOC	4N	354
4N9C	4N	354
4NFP9C	4NFP	355
4NFP9C	4NFP	355
4P9C	4P	357
512REF	RO512REF	436
514REF	514REF	436
544-20000	M-BOSS Compact	468
544-21000	M-BOSS Compact Organiser	468
544-80101	MBML10X45	469
544-80102	MBML10X90	469
544-80201	MBML20X45	469
544-80202	MBML20X90	469
553-50001	HST3-1BK	423
553-50002	HST3-1WH	423
553-50003	HST3-1WH	423
553-50004	HST3-1WH-S	423
553-50005	HST3-1YE	423
553-50006	HST3-1YE	423
553-50007	HST3-1YE-S	423
553-50008	HST4.8-1.6BK	423
553-50009	HST4.8-1.6WH	423
553-50010	HST4.8-1.6WH	423
553-50011	HST4.8-1.6WH-S	423
553-50012	HST4.8-1.6YE	423
553-50014	HST4.8-1.6YE-S	423
553-50015	HST6-2BK	424
553-50016	HST6-2WH	424
553-50017	HST6-2WH	424
553-50018	HST6-2WH	424
553-50019	HST6-2WH-S	424
553-50020	HST6-2YE	424
553-50021	HST6-2YE	424
553-50022	HST6-2YE-S	424
553-50023	HST9-3BK	424
553-50024	HST9-3WH	424

Part No.	Type	Page
553-50025	HST9-3WH-S	424
553-50026	HST9-3YE	424
553-50027	HST9-3YE-S	424
553-50028	HST12-4BK	425
553-50029	HST12-4WH	425
553-50030	HST12-4WH-S	425
553-50031	HST12-4YE	425
553-50032	HST12-4YE-S	425
553-50033	HST18-6BK	425
553-50034	HST18-6WH	425
553-50035	HST18-6WH-S	425
553-50036	HST18-6YE	425
553-50037	HST18-6YE-S	425
553-50038	HST24-8BK	425
553-50039	HST24-8WH	425
553-50040	HST24-8WH-S	425
553-50041	HST24-8YE	425
553-50042	HST24-8YE-S	425
553-50063	HST3-1WH-3S	422
553-50064	HST4.8-1.6WH-3S	423
553-50065	HST6-2WH-3S	424
553-50066	HST9-3WH-3S	424
553-50067	HST3-1WH-S	423
553-50068	HST4.8-1.6WH-2S	423
553-50069	HST4.8-1.6YE-2S	423
553-50070	HST3-1WH-2S	422
553-50071	HST3-1YE-2S	422
553-50072	HST4.8-1.6WH-2S	423
553-50073	HST4.8-1.6YE-2S	423
553-50074	HST3-1WH-S	423
553-50075	HST3-1WH-2S	422
553-50076	HST3-1YE-S	423
553-50077	HST3-1YE-2S	422
553-50078	HST3-1WH	423
553-50079	HST4.8-1.6WH	423
553-50080	HST4.8-1.6WH-S	423
553-50081	HST4.8-1.6WH-3S	423
553-50082	HST6-2WH-2S	424
553-50083	HST6-2YE-2S	424
553-50084	HST6-2WH-S	424
553-50085	HST6-2YE-S	424
553-50086	HST12-4WH-3S	424
553-50087	HST12-4YE-3S	424
553-50088	HST3-1WH-3S	422
553-50089	HST6-2WH-3S	424
553-50090	HST4.8-1.6WH	423
553-50176	HST4.8-1.6WH-S	423
553-50177	HST4.8-1.6WH	423
553-50178	HST6-2BK-3S	423
553-50179	HST3-1BK-S	423
553-50180	HST3-1BK-2S	422
553-50181	HST3-1BK-3S	422
553-50184	HST4.8-1.6BK-3S	423
553-50186	HST6-2BK-2S	424
553-50189	HST9-3BK-3S	424
553-50192	HST9-3WH	424
553-50193	HST12-4WH	425
553-50195	HST4.8-1.6WH	423
553-50196	HST6-2WH	424
553-50199	HST18-6WH	425
553-50203	HST4.8-1.6WHAP	423
553-50204	HST6-2WHAP	424
553-50205	HST9-3WHAP	424

Part No.	Type	Page
553-50206	HST12-4WHAP	425
553-50209	HST39-13WH	425
553-50210	HST6-2YE-3S	424
553-50211	HST3-1WH-3S	422
553-50212	HST6-2WH-3S	424
553-50213	HST4.8-1.6WH-S	423
553-50222	HST18-6BK-S	425
553-50223	HST24-8BK-S	425
553-50225	HFST39-13YE	425
553-50226	HFST39-13WH-S	425
553-50227	HFST39-13YE-S	425
553-50231	HST12-4WH	425
553-50232	HST12-4WH-S	425
553-50233	HST18-6WH	425
553-50234	HST18-6WH-S	425
553-50236	HST9-3WH	424
553-50237	HST24-8WH	425
553-50239	HST4.8-1YE-3S	423
553-50240	HST18-6YE	425
553-50241	HST18-6YE-S	425
553-50242	HST6-2WH-S	424
553-50250	HST12-4WH-S	425
553-50251	HST9-3WH-2S	424
556-00035	TAGPRINT3	485
556-00036	TAGPRINT3LIC	485
556-00037	TAGPRINT5LIC	485
556-00038	TAGPRINT10LIC	485
556-00039	TAGPRINT25LIC	485
556-00042	TAGPRINT3UPGRD	485
556-00043	TAGPRINT3UPGRD3S	485
556-00044	TAGPRINT3UPGRD5S	485
556-00045	TAGPRINT3UPGRD10S	485
556-00046	TAGPRINT3UPGRD25S	485
556-00052	TAGPRINT50LIC	485
556-00189	TTWHITEOUT	483
556-00190	TTWHITEOUTSM	481
556-00205	TTWHITEOUTSM-2	479
556-00230	TT230SM	480
556-00231	CASE230SM	480
556-00232	PRH TT230SM	480
556-00233	RPS TT230SM	480
556-00234	RPR TT230SM	480
556-00235	LABEL HOLDER	480
556-00238	CASE LG TT230SM	480
556-00239	TT230SM KIT	480
556-00240	TT230SMC	480
556-00250	TT130SMC	478
556-00251	TT130RPHHEAD	478
556-00252	TT130PWRSLY	478
556-00253	TT130SMCCASE	478
556-00254	TT130SMCKIT	478
556-00255	TT130SMCCORD	478
556-00256	TT230SMC KIT	480
556-00257	2TT130SMCKIT	478
556-00258	TTWHITEOUTSM2	481
556-00259	TTWHITEOUT2	483
556-00430	TTM430	482
556-00431	430CFP	482
556-00432	430WLAN	482
556-00433	430RLH	482
556-00434	430RRH	482
556-00443	TTM430-SC	482
556-00460	TTM460	482

Part No.	Type	Page
556-00461	TTM460 Printhead	482
556-03065	Printhead TTM430	482
556-03068	TTM430SPH300	482
556-03069	TTM430SPH600	482
556-04005	Printer Roller TT4030/TT4000+	484
556-04037	TT4030	484
556-04041	TT4030 Printhead	484
556-04050	S4030 Cutter	484
556-26006	TIPTAGVA10X65YEW	438
556-26007	TIPTAGVA10X90YEW	438
556-26008	TIPTAGVA15X65YEW	438
556-26009	TIPTAGVA15X90YEW	438
558-00006	HT3RD250	399
558-00307	HT1BK250	398
558-00308	HT1RD250	398
558-00309	HT1WH250	398
558-00310	HT1YE250	398
558-00311	HT2BK250	398
558-00312	HT2RD250	399
558-00313	HT2WH250	399
558-00314	HT2YE250	399
558-00327	HT2OE50250	402
558-00328	HT2YE50250	402
558-00330	HT3OE75250	402
558-00331	HT3YE75250	402
558-00333	HT4OE10250	402
558-00334	HT4YE10250	402
558-00336	HT1OE250	398
558-00337	HT2OE250	398
558-00338	HT3OE250	399
558-00339	HT1BU250	398
558-00340	HT1GN250	398
558-00341	HT2BU250	398
558-00342	HT2GN250	398
558-00343	HT3BU250	399
558-00344	HT3GN250	399
558-00345	HT3WH250	399
558-00346	HT3YE250	399
558-00350	HT4WH250	399
558-00351	HT4GN250	399
558-00358	HT4YE250	399
558-00370	HT4RD250	399
558-00372	HT2RDRF250	399
558-00373	HT3RDRF250	399
558-00374	HT3BK250	399
558-00377	HT1RDRF250	399
558-00380	HT2OE50250UV	400
558-00381	HT3OE75250UV	400
558-00382	HT4OE10250UV	400
558-00407	HT4RDF100	399
558-00411	HT4OE250	399
558-00501	HT1RDHB250	401
558-00502	HT2RDHB250	401
558-00503	HT3RDHB250	401
596-00202	NPL60X60YE	428
596-00203	4X6DANGER	404
596-00204	4X6NOTICE	404
596-00206	PVPSR	459
596-00207	PVPSSNAP4	458
596-00208	PVPSSNAP72	458
596-00231	WDPSLBL	452
596-00232	WESHLBLC	452
596-00233	WESHLBL	452

Part No.	Type	Page
596-00234	WGCME	453
596-00235	WTOPVLBL	453
596-00236	CBACKFED	451
596-00237	ACDISCT	455
596-00238	DCDISCT	456
596-00239	PVACDIS	456
596-00240	ACRATING	455
596-00241	DCRATING	456
596-00242	LAM1	454
596-00243	MPVSD	459
596-00244	DNDCUL	459
596-00245	CSESC	459
596-00246	SOLARD	460
596-00249	CSCSNAP4R	458
596-00251	CSCSNAP72R	458
596-00252	AC2011	455
596-00253	DC2011	455
596-00255	MPVACDIS	459
596-00257	PVPSRTM	457
596-00258	WDCCU	452
596-00371	4X6SAFETY	404
596-00372	3X2SAFETY	403
596-00376	VV55X275	403
596-00377	DV55X275	403
596-00378	VV275X135	403
596-00379	DV275X135	403
596-00380	TBL375	405
596-00381	TBL500	405
596-00382	PLW3P	406
596-00383	PLB3P	406
596-00386	WS275X135	403
596-00387	DS275X135	403
596-00388	WS55X275	403
596-00389	DS55X275	403
596-00404	NPLH31X38WH22.5	427
596-00407	NPLH31X38BK22.5	427
596-00412	NPLH31X31WH22.5	427
596-00413	NPLH31X31BK22.5	427
596-00414	NPLH44X44WH30.5	427
596-00415	NPLH44X44BK30.5	427
596-00417	NPLH76X101WH	426
596-00424	3X2DANGER	404
596-00425	3X2CAUTION	404, 446
596-00426	3X2NOTICE	404
596-00427	4X6CAUTION	404
596-00474	PSEWRS	459
596-00495	WDPSLBL	452
596-00496	WESHLBLC	452
596-00497	WESHLBL	452
596-00498	WGCME	453
596-00499	WTOPVLBL	453
596-00500	NPL27X13WH	426
596-00503	NPL27X13BK	426
596-00504	NPL51X25WH	426
596-00507	NPL51X25BK	426
596-00587	CBACKFED	451
596-00588	WDCCU	452
596-00589	IOCDO	451
596-00590	BIPOLARPV	451
596-00591	120VOLT	451
596-00613	CSESC	459
596-00615	CSCIRLBL	459
596-00621	4X6WARNING	404

Appendix

Index by Part Number

Part No.	Type	Page
596-00622	3X2WARNING	404
596-00633	4X6WARNINGUV	446
596-00634	3X2WARNINGUV	446
596-00635	3X2CAUTIONUV	446
596-00636	4X6CAUTIONUV	446
596-00646	4X6DANGERUV	446
596-00648	3X2DANGERUV	446
596-00650	ACDISC-1	466
596-00651	DCDISC-1	466
596-00652	PVACDIS-1	466
596-00653	DC2011-1	466
596-00654	DCRATING-1	466
596-00655	AC2011-1	466
596-00660	WESHLBL10	463
596-00661	WESHLBLDC10	463
596-00662	WDCCU10	463
596-00663	WGCME10	463
596-00664	WTOPVLBL10	463
596-00665	WDPSLBL10	463
596-00666	CBACKFED10	462
596-00667	BIOPOLARPV10	462
596-00668	IOCOD10	463
596-00669	120VOLT10	462
596-00670	LAM110	454
596-00671	DNDCUL10	461
596-00672	CSESC10	461
596-00673	CSCIRLBL10	461
596-00674	SOLARD10	461
596-00675	MPVSD10	461
596-00676	MPVACDIS10	461
596-00677	PSEWRS10	461
596-00678	PVPSR10	461
596-00735	SMPV	450
596-00737	PSKWH	450
596-00738	DCIB	450
596-00739	DNALP	450
596-00740	DCCB	450
596-00743	PSKWH10	463
596-00744	DCIB10	462
596-00746	DCCB10	462
596-00747	SMPV10	463
596-00748	ECCMPV	450
596-00749	ECCMPV10	462
596-00750	IOC	450
596-00751	SSB	450
596-00753	IOC10	462
596-00756	ACCB	450
596-00757	DCD	450
596-00758	ACCB10	462
596-00759	DCD10	462
596-00792	PAINTSHIELD1	467
596-00793	PAINTSHIELD2	467
596-00794	PAINTSHIELD3	467
596-00795	PAINTSHIELD4	467
596-00796	PAINTSHIELD5	467
596-00797	PAINTSHIELD6	467
596-00800	HLX2YE	447
596-00801	HLX3YE	447
596-00802	WESHLBLDCS	453
596-00808	CBACKFEDS	451
596-00810	SOLARDS	460
596-00813	ACDISCS	455
596-00814	DCDISCS	456

Part No.	Type	Page
596-00816	AC2011S	455
596-00817	DC2011S	455
596-00818	PVACDIS5	456
596-00821	CSESCS	459
596-00823	PSEWRS	459
596-00824	120VOLTS	451
596-00826	IOCODS	452
596-00827	CBACKFEDS	451
596-00828	WESHLBLM5	449
596-00829	WESHLBLDCM5	449
596-00830	WGCME5	449
596-00831	WDCCUM5	448
596-00832	WTOPVLBLM5	449
596-00833	WDPSLBLM5	448
596-00834	CBACKFEDM5	448
596-00835	BIOPOLARVM5	448
596-00836	IOCODM5	448
596-00837	120VOLTM5	448
596-00838	PVACDISM5	444
596-00839	DC2011M5	444
596-00840	AC2011M5	444
596-00841	ACDISCTM5	444
596-00842	DCDISCTM5	444
596-00846	IOCOD14	452
596-00850	DC201110	464
596-00851	DCRATING10	465
596-00852	PVACDIS10	465
596-00853	ACDISCT10	464
596-00854	DCDISCT10	464
596-00855	AC201110	464
596-00858	DCDISCTM5ENG	445
596-00859	PVACDISM5ENG	445
596-00860	MPVSDM5	448
596-00861	MPVACDISM5	448
596-00862	AC2011M5ENG	445
596-00863	DC2011M5ENG	445
596-00864	DCRATINGM5	444
596-00865	DCRATINGM5ENG	445
596-00866	BLANK2X125	445
596-00867	BLANK4X75	445
596-00868	BLANK375X2	445
596-00878	WESHLBL17	452
596-00879	WESHLBLDC17	452
596-00880	IOCOD17	452
596-00881	DC201710	464
596-00882	PVACDIS1710	465
596-00883	IOCOD17ST	452
596-00884	IOCOD17ST10	463
596-00885	RSYDL17	460
596-00886	RSYDR17	460
596-00887	PSEWRS17	459
596-00888	RSYDL1710	461
596-00889	RSYDR1710	461
596-00890	PSEWRS1710	461
596-00891	DC2017	455
596-00892	PVACDIS17	456
596-00893	WESHLBL1710	463
596-00894	WESHLBLDC1710	463
596-00895	IOCOD1710	463
596-00896	PVPSR500	459
596-00904	AF5X35D	464
596-00905	AF5X35W	464
596-00915	NPLH31X48WH2.5	427

Part No.	Type	Page
596-00916	NPLH31X48BK2.5	427
596-00917	IOCOD17M5	448
596-00918	DC2017M5	444
596-00919	PVACDIS17M5	444
596-00920	WESHLBLDC17M5	449
596-00921	WESHLBL17M5	449
596-00922	DC2017M5ENG	445
596-00923	PVACDIS17M5ENG	445
596-00924	WDGC17M5	448
596-00925	VM120A	472
596-00926	VM120B	472
596-00927	VM120C	472
596-00928	VM120/208A	472
596-00929	VM120/208B	472
596-00930	VM120/208C	472
596-00931	VM208A	472
596-00932	VM208B	472
596-00933	VM208C	472
596-00934	VM240A	472
596-00935	VM240B	473
596-00936	VM240C	473
596-00937	VM277C	473
596-00938	VM277/480A	473
596-00939	VM277/480B	473
596-00940	VM277/480C	473
596-00941	VM480A	473
596-00942	VM480B	473
596-00943	VM480C	473
596-00944	VMSINGLEPHASEB	473
596-00945	VMTHREEPHASEB	473
596-00946	VM110A	472
596-00947	VM110C	472
596-00948	VM440A	473
596-00949	VM440C	473
596-00950	VM460A	473
596-00951	VM460C	473
596-00952	VM600A	473
596-00953	VM600C	473
596-00954	VM4160A	473
596-00955	VM230C	472
596-00956	VMHIGHVOLTAGEA	473
596-00957	VM220B	472
596-00958	VM120/240B	472
596-00986	ESSDCD	451
596-00987	MBSDIS	456
596-06321	Paint Pen	437
596-09323	WDGC17	452
596-09324	WDGC1710	463
596-21251	TAG21T6	396
596-28251	TAG28T4	396
596-73833	PCP2X1	394
596-73834	PCP3X1	394
596-73835	PCP4X3	394
596-96253	PW.25W1	470
596-96254	PW.50W2	470
596-96255	PW.25W1P	471
596-96256	PW.50W2P	471
596-96257	PW2.75W2	470
596-96258	PW2.75W2P	471
596-96260	PW.50W1	470
596-96261	PW.50W1P	471
596-96262	PW2.75W1	470
596-96263	PW2.75W1P	471

Part No.	Type	Page
597-00068	DS710NSM	474
597-00072	DS710DHV	474
597-00074	DS710CSEBPO	474
597-00077	DS710TMSASA	475
597-00078	CS710CWYS	475
597-00079	CS710DNOWG	475
597-00080	NS710APO	474
597-00081	NS710SGRITA	474
597-00082	ES710EXIT	475
597-00083	FS710FE	475
597-00085	FS710FAS	474
597-00086	NS710NAES	475
597-00088	DS1014NSM	475
597-00092	DS1014DHV	475
597-00094	DS1014CSEBPO	475
597-00097	DS1014TMSASA	476
597-00098	CS1014CWYS	476
597-00099	CS1014DNOWG	476
597-00100	NS1014SGRITA	475
597-00101	NS1014APO	475
597-00102	ES1014EXIT	476
597-00103	FS1014FE	476
597-00106	NS1014NAES	476
597-00121	CS710AFEP	475
597-00122	CS1014AFEP	476
597-00123	EE710AWS	474
597-00124	EE1014AWS	475
5FRP9C	5FRP	356
5N0C	5N	354
5N9C	5N	354
5NFPOC	5NFP	355
5NFP9C	5NFP	355
5P9C	5P	357
904-00295	Wiring Duct Cutting Tool	282
904-00296	Wiring Duct Cutting Tool Replacement Blade	282
904-00297	Wiring Duct Safety Guide	282
ASNP2-22	ASNP2-22	199
ASNP24-70	ASNP24-70	199
AT2060	AT2060	488
AT2BMNT	AT2BMNT	488
AT2OVHD	AT2OVHD	488
ATS10200000	ATS3080	489
ATS10200040	Bench mount kit 3080	489
ATS10200050	Overhead suspension 3080	489
ATS10266110	Strap Black ATS3080	495
ATS10266210	Closures Black ATS3080	495
CMFO4	CMF	439
CMFO72	CMF	439
CT0753X2	CT0753	429
CT1503X2	CT1503	429
CT2003X2	CT2003	429
CT2012X2	CT2012	429
CTA0753X2	CTA0753	429
CTA1503X2	CTA1503	429
CTAM10C2	CTAM1	148
CTAM10M4	CTAM1	148
CTAM110C2	CTAM1	148
CTAM110M4	CTAM1	148
CTAM20C2	CTAM2	148
CTAM20M4	CTAM2	148
CTAM210C2	CTAM2	148
CTAM210M4	CTAM2	148

Part No.	Type	Page
CTAP10C2	CTAP1	149
CTAP10M4	CTAP1	149
CTAP110C2	CTAP1	149
CTAP110M4	CTAP1	149
CTAP210C2	CTAP2	149
CTM00C2	CTM0	150
CTM00M4	CTM0	150
CTM010C2	CTM0	150
CTM010M4	CTM0	150
CTM10C2	CTM1	150
CTM10M4	CTM1	150
CTM110C2	CTM1	150
CTM110M4	CTM1	150
CTM20C2	CTM2	150
CTM20M4	CTM2	150
CTM210C2	CTM2	150
CTM210M4	CTM2	150
CTM30C2	CTM3	151
CTM30M4	CTM3	151
CTM310C2	CTM3	151
CTM310M4	CTM3	151
CTM40C2	CTM4	151
CTM40M4	CTM4	151
CTM410C2	CTM4	151
CTM410M4	CTM4	151
CTN10	CTN10	359
CTN10STD	CTN10	359
CTN1120	CTN1120	359
CTN1120STD	CTN1120	359
CTN1140	CTN1140	359
CTN1140STD	CTN1140	359
CTN120	CTN120	359
CTN120STD	CTN120	359
CTN140	CTN140	359
CTN140STD	CTN140	359
CTN20STD	CTN20	359
CTN340	CTN340	359
CTN340STD	CTN340	359
CTN380	CTN380	359
CTN380STD	CTN380	359
CTN580STD	CTN580	359
CTP10	CTP10	361
CTP10STD	CTP10	361
CTP1120	CTP1120	361
CTP1120STD	CTP1120	361
CTP1140	CTP1140	361
CTP1140STD	CTP1140	361
CTP120	CTP120	361
CTP120STD	CTP120	361
CTP140	CTP140	361
CTP140STD	CTP140	361
CTP20STD	CTP20	361
CTP340	CTP340	361
CTP340STD	CTP340	361
CTP380	CTP380	361
CTP380STD	CTP380	361
CTP580	CTP580	361
CTP580STD	CTP580	361
CCT20R0C2	CCT20R	60
CCT20R0HSC2	CCT20R	60
CCT20R0HSM4	CCT20R	60
CCT20R9C2	CCT20R	60
CCT20R9M4	CCT20R	60

Part No.	Type	Page
CTT60R0C2	CTT60R	60
CTT60R0HIRC2	CTT60R	60
CTT60R0HIRHSM4	CTT60R	60
CTT60R0HSC2	CTT60R	60
CTT60R0HSM4	CTT60R	60
CTT60R9C2	CTT60R	60
CTT60R9M4	CTT60R	60
D10H4	8D10	175
D15L4	8D15	175
D20L4	8D20	175
DCT110HIRC2	DCT11	133
DCT110HIRH1	DCT11	133
DCT110HIRK2	DCT11	133
DCT90HIRC2	DCT9	133
DCT90HIRH1	DCT9	133
DCT90HIRK2	DCT9	133
DSWS50HSH1	DSWS5	136
DSWS50HSH2	DSWS5	136
EC30.HB6P	EC30	190
FC1.2AH4	FC1.2A	202
FC1.2AK2	FC1.2A	202
FC1.2K2	FC1.2	203
FC140	FC14	176
FC1410	FC14	176
FC2.2AH4	FC2.2A	202
FC2.2AK2	FC2.2A	202
FC2.2H4	FC2.2	203
FC2.2K2	FC2.2	203
FHA	G51NA	363
FHB	G51NB	363
FHC	G51NC	363
FHD	G51ND	363
FHE	G51NE	363
FHF	G51NF	363
FHG	G51NG	363
FOM-150	FOM	431
FOM-175	FOM	431
FOM-75	FOM	431
FPA	G51PA	364
FPAA	G51PAA	364
FPB	G51PB	364
FPC	G51PC	364
FPD	G51PD	364
FPE	G51PE	364
FPF	G51PF	364
FPG	G51PG	364
FPH	G51PH	364
FTA	G51TA	365
FTB	G51TB	365
GT.375X60C2	GT.375X6	71
GT.50X110C2	GT.50X11	72
GT.50X110C2W	GT.50X11W	77
GT.50X110P2	GT.50X11	72
GT.50X110P2W	GT.50X11W	77
GT.50X112C2	GT.50X11	72
GT.50X112P2	GT.50X11	72
GT.50X113C2	GT.50X11	72
GT.50X113P2	GT.50X11	72
GT.50X114C2	GT.50X11	72
GT.50X114P2	GT.50X11	72
GT.50X115C2	GT.50X11	72
GT.50X115P2	GT.50X11	72
GT.50X116C2	GT.50X11	72

Appendix

Index by Part Number

Part No.	Type	Page
GT.50X116P2	GT.50X11	72
GT.50X12MP2V2	GT.50X12	76
GT.50X60C2	GT.50X6	71
GT.50X60C2W	GT.50X6W	77
GT.50X60P2	GT.50X6	71
GT.50X60P2W	GT.50X6W	77
GT.50X62C2	GT.50X6	71
GT.50X62P2	GT.50X6	71
GT.50X63C2	GT.50X6	71
GT.50X63P2	GT.50X6	71
GT.50X64C2	GT.50X6	71
GT.50X64P2	GT.50X6	71
GT.50X65C2	GT.50X6	71
GT.50X65P2	GT.50X6	71
GT.50X66C2	GT.50X6	71
GT.50X66P2	GT.50X6	71
GT.50X6MP2V2	GT.50X6	76
GT.50X80C2	GT.50X8	71
GT.50X80C2W	GT.50X8W	77
GT.50X80P2	GT.50X8	71
GT.50X80P2W	GT.50X8W	77
GT.50X82C2	GT.50X8	71
GT.50X82P2	GT.50X8	71
GT.50X83C2	GT.50X8	71
GT.50X83P2	GT.50X8	71
GT.50X84C2	GT.50X8	71
GT.50X84P2	GT.50X8	71
GT.50X85C2	GT.50X8	71
GT.50X85P2	GT.50X8	71
GT.50X86C2	GT.50X8	71
GT.50X86P2	GT.50X8	71
GT.50X8MP2V2	GT.50X8	76
GT.75X150C2	GT.75X15	73
GT.75X150P2	GT.75X15	73
GT.75X152C2	GT.75X15	73
GT.75X152P2	GT.75X15	73
GT.75X153C2	GT.75X15	73
GT.75X153P2	GT.75X15	73
GT.75X154C2	GT.75X15	73
GT.75X154P2	GT.75X15	73
GT.75X155C2	GT.75X15	73
GT.75X155P2	GT.75X15	73
GT.75X156C2	GT.75X15	73
GT.75X156P2	GT.75X15	73
GT.75X1800	GT.75X180	74
GT.75X1800W	GT.75X180W	74
GT.75X18010	GT.75X180	74
GT.75X1802	GT.75X180	74
GT.75X1803	GT.75X180	74
GT.75X1804	GT.75X180	74
GT.75X1805	GT.75X180	74
GT.75X1806	GT.75X180	74
GT.75X6000	GT.75X600	74
GT.75X9000	GT.75X900	74
GT.75X9004	GT.75X900	74
GTLF50X110P2	GTLF50X11	75
GTLF50X60P2	GTLF50X6	75
GTLF50X80P2	GTLF50X8	75
GTM1000C2	GTM100	157
GTM100A0C2	GTM100A	157
GTM500C2	GTM50	157
GTM50A0C2	GTM50A	157
GWCO03X2	GW	430

Part No.	Type	Page
GWTO03X2	GW	430
HDM190HIRC2	HDM19	158
HDM190HIRH4	HDM19	158
HDM250HIRC2	HDM25	158
HDM250HIRH4	HDM25	158
HDM3120HIRC2	HDM312	158
HDM3120HIRH4	HDM312	158
HDM321HIHSUVH4	HDM321	159
HDM401HIHSUVH4	HDM401	159
HDM501HIHSUVH4	HDM501	159
HH-20	HH20	174, 492
IMP1.510C2	IMP1.5	433
IMP1.7510C2	IMP1.75	433
IMP2.510C2	IMP2.5	433
IMP2.510M4	IMP2.5	433
IMP2.5W1.7510C2	IMP2.5	433
IMP2.5W1.7510H4	IMP2.5	433
IMP210C2	IMP2	433
IMP3.510C2	IMP3.5	433
IT18FL0C2	IT18FL	64
IT18FL0L4	IT18FL	64
IT18FL10L4	IT18FL	64
IT18FL2L4	IT18FL	64
IT18FL3L4	IT18FL	64
IT18FL4L4	IT18FL	64
IT18FL6L4	IT18FL	64
IT18FL9C2	IT18FL	64
IT18FL9L4	IT18FL	64
IT18ROC2	IT18R	63
IT18ROL4	IT18R	63
IT18R10C2	IT18R	63
IT18R10L4	IT18R	63
IT18R2C2	IT18R	63
IT18R2L4	IT18R	63
IT18R3C2	IT18R	63
IT18R3L4	IT18R	63
IT18R4L4	IT18R	63
IT18R6C2	IT18R	63
IT18R6L4	IT18R	63
IT18R8C2	IT18R	63
IT18R9C2	IT18R	63
IT18R9L4	IT18R	63
IT50L0M4	IT50L	65
IT50L3M4	IT50L	65
IT50L4M4	IT50L	65
IT50L6M4	IT50L	65
IT50L9C2	IT50L	65
IT50R0C2	IT50R	64
IT50R0M4	IT50R	64
IT50R10C2	IT50R	64
IT50R2C2	IT50R	64
IT50R3M4	IT50R	64
IT50R4C2	IT50R	64
IT50R9C2	IT50R	64
IT50R9M4	IT50R	64
IT50RD0K2	IT50RD	64
IT50RD4K2	IT50RD	64
IT50RD9K2	IT50RD	64
IT50RT0K2	IT50RT	65
IT50RT4K2	IT50RT	65
IT50RT9K2	IT50RT	65
LTM2500C2	LTM250	165
MB10C2	MB1	147

Part No.	Type	Page
MB10M4	MB1	147
MB19C2	MB1	147
MB19M4	MB1	147
MB2.50C2	MB2.5	146
MB2.510C2	MB2.5	146
MB2.510M4	MB2.5	146
MB2.5A0C2	MB2.5A	139
MB2.5A0M4	MB2.5A	139
MB2.5A10C2	MB2.5A	139
MB2.5A10M4	MB2.5A	139
MB29C2	MB2	147
MB29M4	MB2	147
MB30C2	MB3	146
MB30M4	MB3	146
MB310C2	MB3	146
MB310M4	MB3	146
MB3A0A2H4	MB3A	141
MB3A0C2	MB3A	139
MB3A0M4	MB3A	139
MB3A10A2C2	MB3A	141
MB3A10A2H4	MB3A	141
MB3A10C2	MB3A	139
MB3A10M4	MB3A	139
MB40C2	MB4	146
MB40H4	MB4	146
MB410C2	MB4	146
MB410H4	MB4	146
MB4A0A2H4	MB4A	141
MB4A0C2	MB4A	139
MB4A0H4	MB4A	139
MB4A10A2C2	MB4A	141
MB4A10A2H4	MB4A	141
MB4A10C2	MB4A	139
MB4A10H4	MB4A	139
MB4SH10C2	MB4SH	146
MB4SH10H4	MB4SH	146
MB4SHA0C2	MB4SHA	140
MB4SHA0H4	MB4SHA	140
MB4SHA10C2	MB4SHA	140
MB4SHA10H4	MB4SHA	140
MB50C2	MB5	146
MB50F4	MB5	146
MB510C2	MB5	146
MB510F4	MB5	146
MB5A0A2F4	MB5A	141
MB5A0C2	MB5A	140
MB5A0F4	MB5A	140
MB5A10A2F4	MB5A	141
MB5A10C2	MB5A	140
MB5A10F4	MB5A	140
MBT14H	MBT14H	69
MBT14H-S	MBT14HS	67
MBT14S	MBT14S	68
MBT14S-S	MBT14SS	66
MBT20H	MBT20H	69
MBT20H-S	MBT20HS	67
MBT20S	MBT20S	68
MBT20S-S	MBT20SS	66
MBT27H	MBT27H	69
MBT27H-S	MBT27HS	67
MBT27S	MBT27S	68
MBT27S-S	MBT27SS	66
MBT33H	MBT33H	69

Part No.	Type	Page
MBT33H-S	MBT33HS	67
MBT33S	MBT33S	69
MBT33S-S	MBT33SS	66
MBT5S	MBT5S	68
MBT5S-S	MBT5SS	66
MBT8H	MBT8H	69
MBT8H-S	MBT8HS	67
MBT8S	MBT8S	68
MBT8S-S	MBT8SS	66
MCRFW-B10	MCR-B10	309
MCRFW-B8	MCR-B8	309
MCRFW-B5	MCR-B5	310
MCRFW-B510	MCR-B510	309
MCRFW-B58	MCR-B58	309
MCRFW-C10	MCR-C10	309
MCRFW-C8	MCR-C8	309
MCRFW-CD10	MCR-CD10	311
MCRFW-CD8	MCR-CD8	311
MCRFW-CS	MCR-CS	315
MCRFW-EC	MCR-EC	316
MCRFW-EE	MCR-EE	312
MCRFW-ENT	MCR-ENT	321
MCRFW-FE	MCR-FE	313
MCRFW-IE	MCR-IE	314
MCRFW-OB	MCR-OB	318
MCRFW-OE	MCR-OE	322
MCRFW-OEB	MCR-OEB	323
MCRFW-PTF	MCR-PTF	317
MCRFW-RDB	MCR-RDB	319
MCRFW-REB	MCR-REB	320
MCRFW-TE	MCR-TE	324
MCRG-TM	MCR-TM	326
MCRG-WR	MCR-WR	326
MCR-I-B10	MCR-B10	309
MCR-I-B8	MCR-B8	309
MCR-I-B5	MCR-B5	310
MCR-I-B510	MCR-B510	309
MCR-I-B58	MCR-B58	309
MCR-I-C10	MCR-C10	309
MCR-I-C8	MCR-C8	309
MCR-I-CD10	MCR-CD10	311
MCR-I-CD8	MCR-CD8	311
MCR-I-CS	MCR-CS	315
MCR-I-EC	MCR-EC	316
MCR-I-EE	MCR-EE	312
MCR-I-ENT	MCR-ENT	321
MCR-I-FE	MCR-FE	313
MCR-I-IE	MCR-IE	314
MCR-I-OB	MCR-OB	318
MCR-I-OE	MCR-OE	322
MCR-I-PTF	MCR-PTF	317
MCR-I-RDB	MCR-RDB	319
MCR-I-REB	MCR-REB	320
MCR-I-TE	MCR-TE	324
MCR-LTD	MCR-LTD	325
MCRW-SD10	MCR-SD10	311
MCRW-SD8	MCR-SD8	311
MK7HT	MK7HT	503
MK7P	MK7P	497
MK7P-342	SP MK7P replacement blade	500
MK7P-446	MK7P-446	500
MK9P	MK9P	498
MK9P-109	SP MK9P replacement blade	500

Part No.	Type	Page
MK9PUA	MK9P	498
MK9SST	MK9SST	504
MKPCOHOSE	MKPCOHOSE	500
MMB.50C2	MMB.5	156
MMB.50M4	MMB.5	156
MMB00C2	MMB0	156
MMB10C2	MMB1	156
MMB10H4	MMB1	156
MP1M3.NN3P	MP1M3	153
MP1M5.NN3P	MP1M5	153
MP2M3.NN3P	MP2M3	153
MP2M5.NN3P	MP2M5	153
MP3M3.NN3P	MP3M3	153
MP3M5.NN3P	MP3M5	153
MP4M3.NN3P	MP4M3	153
MP4M5.NN3P	MP4M5	153
MP5M3.NN3P	MP5M3	153
MP5M5.NN3P	MP5M5	153
MSBT1200HIRH5H1	MSBT120	168
MSBT1200HIRH5X2	MSBT120	168
MSMP6-109C2	MSMP6/10	153
MSMP6-69C2	MSMP6/6	153
MSNP1-70	MSNP1-70	199
NC110	NC11	176
NC1110	NC11	176
NC3.50	NC3.5	176
NC3.510	NC3.5	176
NC50	NC5	176
NC510	NC5	176
NC60	NC6	176
NC610	NC6	176
NC70	NC7	176
NC710	NC7	176
NC80	NC8	176
NC810	NC8	176
NC90	NC9	176
NC910	NC9	176
PBM0C2	PBM	155
PBM0M4	PBM	155
PBM10C2	PBM	155
PBM10M4	PBM	155
PBM9C2	PBM	155
PBM9M4	PBM	155
PC15FT7	PC15FT7	177
PHSNP2-36	PHSNP2-36	199
PHSNP38-100	PHSNP38-100	199
PR1M4	PR1	283
PRT1	PRT1	283
PSNP2-22	PSNP2-22	199
QS101	QS101	490
QTIE0H5	AZ100	496
QTIE9	AZ100	496
RB14L4	RB14	222
RB8L4	RB8	222
REZ200.NB3P	REZ200	53
REZ300.NB3P	REZ300	53
RO175	RO175	435
RO175WP	RO175WP	435
RO512	RO512	435
RO514	RO514	435
RT150LEPOX2	RT150LEP	54
RT150MEPOX2	RT150MEP	54
RT150REPOX2	RT150REP	54

Part No.	Type	Page
RT250I0UVX2	RT250I	55
RT250I0X2	RT250I	55
RT250I9X2	RT250I	55
RT250L0UVX2	RT250L	55
RT250L0X2	RT250L	55
RT250L9X2	RT250L	55
RT250M0UVX2	RT250M	55
RT250M0X2	RT250M	55
RT250M9X2	RT250M	55
RT250R0UVX2	RT250R	55
RT250R0X2	RT250R	55
RT250R9X2	RT250R	55
RT250S0UVX2	RT250S	55
RT250S0X2	RT250S	55
RT250S9X2	RT250S	55
RT250XL0UVX2	RT250XL	55
RT250XL0X2	RT250XL	55
RT250XL9X2	RT250XL	55
RT255R0HIRX2	RT255R	57
RT255S0HIRX2	RT255S	57
RT40ROC2	RT40R	52
RT40R0M4	RT40R	52
RT40R9C2	RT40R	52
RT40R9M4	RT40R	52
RT50LL0M4	RT50LL	52
RT50LL0UVC2	RT50LL	52
RT50LL9C2	RT50LL	52
RT50LL9M4	RT50LL	52
RT50S0C2	RT50S	52
RT50S9C2	RT50S	52
RT50S9M4	RT50S	52
RTT750HR.NX1P	SpeedyTie (RTT750HR)	56
RTT750HR.NX900	SpeedyTie (RTT750HR)	56
S2CM258HIRHSH1	S2CM25	167
S2CM258HIRHSHK2	S2CM25	167
S2HM250HIRHSH1	S2HM25	167
S2HM250HIRHSHK2	S2HM25	167
S3STM500HIRHSC2	S3STM50	171
S3STM500HIRHSF1	S3STM50	171
SAM83HIRHSH1	SAM83	162
SAOM80HIRHSH1	SAOM8	162
SAOM820HIRHSH1	SAOM82	162
SDWR2X20K2	SDWR2X20	280
SDWR4X40P2	SDWR4X40	280
SLWR20C2	SLWR20	281
SLWR30C2	SLWR30	281
SLWR40C2	SLWR40	281
SM1BK75MT	SM1	366
SNP1.2510C2	SNP1.25	197
SNP1.2510M4	SNP1.25	197
SNP1.25GH50C2	SNP1.25	195
SNP1.25GH50M4	SNP1.25	195
SNP1.510C2	SNP1.5	197
SNP1.510M4	SNP1.5	197
SNP1.5GH50C2	SNP1.5	195
SNP1.5GH50M4	SNP1.5	195
SNP10010X2	SNP100	198
SNP100GH50C2	SNP100	196
SNP1010C2	SNP10	197
SNP1010M4	SNP10	197
SNP10110X2	SNP101	198
SNP101GH50X2	SNP101	196
SNP10GH50C2	SNP10	196

Appendix

Index by Part Number

Part No.	Type	Page
SNP10GH50M4	SNP10	196
SNP110C2	SNP1	197
SNP110M4	SNP1	197
SNP12A10C2	SNP12A	198
SNP12A10M4	SNP12A	198
SNP12AGH50C2	SNP12A	196
SNP12AGH50M4	SNP12A	196
SNP1610C2	SNP16	198
SNP1610M4	SNP16	198
SNP16GH50C2	SNP16	196
SNP16GH50M4	SNP16	196
SNP18A10C2	SNP18A	198
SNP18A10M4	SNP18A	198
SNP18AGH50C2	SNP18A	196
SNP18AGH50M4	SNP18A	196
SNP1910C2	SNP19	198
SNP1910M4	SNP19	198
SNP19GH50C2	SNP19	196
SNP19GH50M4	SNP19	196
SNP1GH50C2	SNP1	195
SNP1GH50M4	SNP1	195
SNP210C2	SNP2	197
SNP210M4	SNP2	197
SNP2210C2	SNP22	198
SNP2210M4	SNP22	198
SNP22GH50C2	SNP22	196
SNP22GH50M4	SNP22	196
SNP2410C2	SNP24	198
SNP2410H4	SNP24	198
SNP24GH50C2	SNP24	196
SNP24GH50H4	SNP24	196
SNP2810C2	SNP28	198
SNP2810H4	SNP28	198
SNP28GH50C2	SNP28	196
SNP28GH50H4	SNP28	196
SNP2GH50C2	SNP2	195
SNP2GH50M4	SNP2	195
SNP310C2	SNP3	197
SNP310M4	SNP3	197
SNP3210H4	SNP32	198
SNP3210K2	SNP32	198
SNP32GH50H4	SNP32	196
SNP32GH50K2	SNP32	196
SNP3310H4	SNP33	198
SNP3310K2	SNP33	198
SNP33GH50H4	SNP33	196
SNP3410H4	SNP34	198
SNP3410K2	SNP34	198
SNP34GH50H4	SNP34	196
SNP34GH50K2	SNP34	196
SNP3610H4	SNP36	198
SNP3610K2	SNP36	198
SNP36GH50H4	SNP36	196
SNP36GH50K2	SNP36	196
SNP3810H4	SNP38	198
SNP3810K2	SNP38	198
SNP38GH50H4	SNP38	196
SNP38GH50K2	SNP38	196
SNP3GH50C2	SNP3	195
SNP3GH50M4	SNP3	195
SNP410C2	SNP4	197
SNP410M4	SNP4	197
SNP42N10C2	SNP42N	198

Part No.	Type	Page
SNP42N10K2	SNP42	198
SNP42NGH50C2	SNP42N	196
SNP42NGH50K2	SNP42	196
SNP4GH50C2	SNP4	195
SNP4GH50M4	SNP4	195
SNP5010C2	SNP50	198
SNP50GH50C2	SNP50	196
SNP6010C2	SNP60	198
SNP60GH50C2	SNP60	196
SNP610C2	SNP6	197
SNP610M4	SNP6	197
SNP6GH50C2	SNP6	195
SNP6GH50M4	SNP6	195
SNP7010C2	SNP70	198
SNP7010X2	SNP70	198
SNP70GH50C2	SNP70	196
SNP710C2	SNP7	197
SNP710M4	SNP7	197
SNP7610C2	SNP76	198
SNP76GH50C2	SNP76	196
SNP76GH50X2	SNP76	196
SNP7GH50C2	SNP7	195
SNP7GH50M4	SNP7	195
SNP8010C2	SNP80	198
SNP80GH50C2	SNP80	196
SNP810C2	SNP8	197
SNP810M4	SNP8	197
SNP8GH50C2	SNP8	195
SNP8GH50M4	SNP8	195
SNP9010C2	SNP90	198
SNP90GH50X2	SNP90	196
SR2550HIHSUVX2	SR255S	58
SR2550HIHSUVX2	SR255X	58
SR2550HIHSUVX2	SR255X	58
SRCI0500C2	SRCI0500	224
SRCI0750C2	SRCI0750	224
SRCI1000K2	SRCI1000	224
T120I0H4	T120I	42
T120I0HIRUVH4	T120I	35
T120I0H5H4	T120I	29
T120I0K2	T120I	42
T120I0UVK2	T120I	33
T120I9H4	T120I	42
T120I9K2	T120I	42
T120LOH5K2	T120L	29
T120L0K2	T120L	42
T120LOUVK2	T120L	33
T120L9K2	T120L	42
T120MROH4	T120MR	120
T120MR0K2	T120MR	120
T120MR0UVK2	T120MR	120
T120MR9H4	T120MR	120
T120MR9K2	T120MR	120
T120R0H4	T120R	42
T120R0H5H4	T120R	29
T120R0H5K2	T120R	29
T120R0K2	T120R	42
T120R0PPH4	T120R	38
T120R0PPK2	T120R	38
T120R0UVC2	T120R	33
T120R0UVH4	T120R	33
T120R9H4	T120R	42
T120R9K2	T120R	42

Part No.	Type	Page
T120RDH0H4	T120RDH	62
T120RDH0K2	T120RDH	62
T120S0H4	T120S	42
T120S0H5H4	T120S	29
T120S0K2	T120S	42
T120S0PPH4	T120S	38
T120S0UVK2	T120S	33
T120S9H4	T120S	42
T120S9K2	T120S	42
T150L0UVX2	T150L	34
T150L0X2	T150L	43
T150L9X2	T150L	43
T150LLOUVX2	T150LL	34
T150LLOX2	T150LL	43
T150LL9X2	T150LL	43
T150M0H5X2	T150M	29
T150M0UVX2	T150M	34
T150M0X2	T150M	43
T150M9X2	T150M	43
T150R0UVX2	T150R(U)	34
T150R0X2	T150R(U)	43
T150R9X2	T150R(U)	43
T150XL0H5X2	T150XL	29
T150XL0UVX2	T150XL	34
T150XL0X2	T150XL	43
T150XL9X2	T150XL	43
T150XLL0UVX2	T150XLL	34
T150XLL0X2	T150XLL	43
T150XLL9X2	T150XLL	43
T18I0C2	T18I	20
T18I0H5M4	T18I	28
T18I0M4	T18I	20
T18I9C2	T18I	20
T18I9M4	T18I	20
T18I9VOM4	T18I	37
T18L0C2	T18L	20
T18L0H5C2	T18L	28
T18L0H5M4	T18L	28
T18L0M4	T18L	20
T18L0VOC2	T18L	37
T18L9C2	T18L	20
T18L9M4	T18L	20
T18L9VOM4	T18L	37
T18MR0C2	T18MR	119
T18MR0M4	T18MR	119
T18MR9C2	T18MR	119
T18MR9M4	T18MR	119
T18R0C2	T18R	20
T18R0H5C2	T18R	28
T18R0H5M4	T18R	28
T18R0M4	T18R	20
T18R0PPC2	T18R	38
T18R0UVC2	T18R	33
T18R0UVM4	T18R	33
T18R0VOC2	T18R	37
T18R10M4	T18R	24
T18R1M4	T18R	24
T18R2HALC2	T18R	40
T18R2HALM4	T18R	40
T18R2M4	T18R	24
T18R3M4	T18R	24
T18R4M4	T18R	24
T18R5M4	T18R	24

Part No.	Type	Page
T18R6M4	T18R	24
T18R7M4	T18R	24
T18R8M4	T18R	24
T18R9C2	T18R	20
T18R9M4	T18R	20
T18R9PPM4	T18R	38
T18R9VOC2	T18R	37
T18R9VOM4	T18R	37
T18RA50	T18RA50	493
T18RA5000	T18RA5000	493
T18RA5000HSW	T18RA5000	493
T18RA50HSW	T18RA50	493
T18RA50VO	T18RA50	493
T18RWPM9M4	T18RWPM	93
T18S0C2	T18S	20
T18S0HSM4	T18S	28
T18S0M4	T18S	20
T18S9C2	T18S	20
T18S9M4	T18S	20
T250I0X2	T250I	44
T250I9X2	T250I	44
T250L0X2	T250L	44
T250L9X2	T250L	44
T250M0X2	T250M	44
T250M9X2	T250M	44
T250R0HIRUVX2	T250R	35
T250R0X2	T250R	44
T250R9X2	T250R	44
T250S0X2	T250S	44
T250S9X2	T250S	44
T250XLOX2	T250XL	44
T250XL9X2	T250XL	44
T255M0HIRX2	T255M	45
T255R0HIRX2	T255R	45
T255S0HIRX2	T255S	45
T30L0C2	T30L	21
T30L0M4	T30L	21
T30LOUVC2	T30L	33
T30LOUVM4	T30L	33
T30L9C2	T30L	21
T30L9M4	T30L	21
T30LLOC2	T30LL	21
T30LLOHSM4	T30LL	28
T30LLOM4	T30LL	21
T30LL9C2	T30LL	21
T30LL9M4	T30LL	21
T30MROC2	T30MR	119
T30MROM4	T30MR	119
T30MR9C2	T30MR	119
T30MR9M4	T30MR	119
T30ROC2	T30R	21
T30R0HIRM4	T30R	35
T30R0HSC2	T30R	28
T30R0HSM4	T30R	28
T30R0M4	T30R	21
T30ROUVC2	T30R	33
T30ROUVM4	T30R	33
T30R0VOC2	T30R	37
T30R10C2	T30R	25
T30R10M4	T30R	25
T30R1C2	T30R	25
T30R1M4	T30R	25
T30R2C2	T30R	25

Part No.	Type	Page
T30R2M4	T30R	25
T30R3C2	T30R	25
T30R3M4	T30R	25
T30R4C2	T30R	25
T30R4M4	T30R	25
T30R5C2	T30R	25
T30R5M4	T30R	25
T30R6C2	T30R	25
T30R6M4	T30R	25
T30R7C2	T30R	25
T30R7M4	T30R	25
T30R8C2	T30R	25
T30R8M4	T30R	25
T30R9C2	T30R	21
T30R9M4	T30R	21
T30R9PPC2	T30R	38
T30RA30	T30RA	494
T30RA3000	T30RA	494
T30RA3000OHS	T30RA	494
T30RA300OHS	T30RA	494
T30RSF0C2	T30RSF(U)	91
T30RSF0M4	T30RSF(U)	91
T30RSF9C2	T30RSF(U)	91
T30RSF9M4	T30RSF(U)	91
T30XLOC2	T30XL	21
T30XL0M4	T30XL	21
T30XL9C2	T30XL	21
T30XL9M4	T30XL	21
T40I0C2	T40I	22
T40I0M4	T40I	22
T40I9C2	T40I	22
T40I9M4	T40I	22
T40L0C2	T40L	22
T40L0HSC2	T40L	28
T40L0M4	T40L	22
T40L9C2	T40L	22
T40L9M4	T40L	22
T40ROC2	T40R(U)	22
T40R0HSM4	T40R(U)	28
T40R0M4	T40R(U)	22
T40R9C2	T40R(U)	22
T40R9M4	T40R(U)	22
T50I0C2	T50I	23
T50I0HSC2	T50I	28
T50I0HSM4	T50I	28
T50I0M4	T50I	23
T50I0UVC2	T50I	33
T50I0UVM4	T50I	33
T50I0VOC2	T50I	37
T50I9C2	T50I	23
T50I9M4	T50I	23
T50I9VOC2	T50I	37
T50I9VOM4	T50I	37
T50IDH0C2	T50IDH	62
T50IDH0HSM4	T50IDH	62
T50IDH0M4	T50IDH	62
T50IDH0UVC2	T50IDH	62
T50IDH9C2	T50IDH	62
T50IDH9M4	T50IDH	62
T50L0C2	T50L	23
T50L0HSC2	T50L	28
T50L0HSM4	T50L	28
T50L0M4	T50L	23

Part No.	Type	Page
T50L0UVC2	T50L	33
T50L0UVM4	T50L	33
T50L10C2	T50L	27
T50L10M4	T50L	27
T50L1C2	T50L	27
T50L15TNLM4	T50L	30
T50L2C2	T50L	27
T50L2M4	T50L	27
T50L3C2	T50L	27
T50L3M4	T50L	27
T50L4C2	T50L	27
T50L4M4	T50L	27
T50L5C2	T50L	27
T50L5M4	T50L	27
T50L6C2	T50L	27
T50L6M4	T50L	27
T50L8C2	T50L	27
T50L8M4	T50L	27
T50L9C2	T50L	23
T50L9M4	T50L	23
T50LDH0C2	T50LDH	62
T50LDH0HSM4	T50LDH	62
T50LDH0M4	T50LDH	62
T50LDH0UVC2	T50LDH	62
T50LDH9C2	T50LDH	62
T50LDH9M4	T50LDH	62
T50MIOC2	T50MI	119
T50MI9C2	T50MI	119
T50MI9M4	T50MI	119
T50MLOC2	T50ML	120
T50MLOM4	T50ML	120
T50ML9C2	T50ML	120
T50ML9M4	T50ML	120
T50MROC2	T50MR	120
T50MROHSM4	T50MR	120
T50MR0M4	T50MR	120
T50MR9C2	T50MR	120
T50MR9M4	T50MR	120
T50MR9X2	T50MR	120
T50ROC2	T50R	23
T50R0HIRM4	T50R	35
T50R0HSC2	T50R	28
T50R0HSM4	T50R	28
T50R0M4	T50R	23
T50R0PPC2	T50R	38
T50R0PPM4	T50R	38
T50R0UVC2	T50R	33
T50R0UVM4	T50R	33
T50R10C2	T50R	26
T50R10M4	T50R	26
T50R1C2	T50R	26
T50R1M4	T50R	26
T50R2C2	T50R	26
T50R2HALC2	T50R	40
T50R2HALM4	T50R	40
T50R2M4	T50R	26
T50R3C2	T50R	26
T50R3M4	T50R	26
T50R4C2	T50R	26
T50R4M4	T50R	26
T50R5C2	T50R	26
T50R5M4	T50R	26
T50R6C2	T50R	26

Appendix

Index by Part Number

Part No.	Type	Page
T50R6M4	T50R	26
T50R7C2	T50R	26
T50R7M4	T50R	26
T50R8C2	T50R	26
T50R8M4	T50R	26
T50R9C2	T50R	23
T50R9M4	T50R	23
T50R9PPC2	T50R	38
T50R9VOC2	T50R	37
T50R9VOM4	T50R	37
T50RDH0C2	T50RDH	61
T50RDH0HSM4	T50RDH	61
T50RDH0M4	T50RDH	61
T50RDH0UVC2	T50RDH	61
T50RDH9C2	T50RDH	61
T50RDH9M4	T50RDH	61
T50RSFC2	T50RSF(U)	92
T50RSF0M4	T50RSF(U)	92
T50RSF9C2	T50RSF(U)	92
T50RSF9M4	T50RSF(U)	92
T50RTM250HSC2	T50RTM25	104
T50RTM250HSM4	T50RTM25	104
T50RTM25E0HSM4	T50RTM25E	104
T50RTM25E8HM4	T50RTM25E	104
T50S0C2	T50S	22
T50S0M4	T50S	22
T50S9C2	T50S	22
T50S9M4	T50S	22
T50SD60HSH4	T50SD6	88
T50SL6.NN6P	T50SL6	94
T50SL7.NN6P	T50SL7	95
T82S	T82S-BK	437
TAG10-100	TAG10	421
TAG10L-105	TAG10L	413
TAG10T2-100B	TAG10T2	387
TAG1-100	TAG1	421
TAG110BL	TAG110	411
TAG110BR	TAG110	411
TAG110GR	TAG110	411
TAG110GY	TAG110	411
TAG110OR	TAG110	411
TAG110PL	TAG110	411
TAG110RD	TAG110	411
TAG110WT	TAG110	411
TAG110YL	TAG110	411
TAG11J-450	TAG11J	416
TAG11L-789	TAG11L	409
TAG11T4-250	TAG11T4	388
TAG11T4-822	TAG11T4	391
TAG11T4-822C	TAG11T4	393
TAG13J-450	TAG13J	416
TAG13L-789	TAG13L	409
TAG13T4-822	TAG13T4	391
TAG13T4-DTH	TAG13T4	397
TAG14-400	TAG14	418
TAG14J-450	TAG14J	416
TAG14L-789	TAG14L	409
TAG15-400	TAG15	418
TAG15-600	TAG15	419
TAG15J-450	TAG15J	416
TAG15L-789	TAG15L	409
TAG15T3-250	TAG15T3	388
TAG15T3-795	TAG15T3	390

Part No.	Type	Page
TAG15T3-822	TAG15T3	392
TAG15T3-822C10M	TAG15T3	393
TAG15T3-DTH	TAG15T3	397
TAG16-400	TAG16	418
TAG16T3-822	TAG16T3	391
TAG16T3-DTH	TAG16T3	397
TAG17T2-822	TAG17T2	392
TAG19J-450	TAG19J	416
TAG1L-105	TAG1L	413
TAG1T1-100B	TAG1T1	387
TAG2-100	TAG2	420
TAG21J-450	TAG21J	416
TAG21T6-250	TAG21T6	388
TAG22-100	TAG22	420
TAG22J-994	TAG22J	417
TAG22T2-100B	TAG22T2	386
TAG22T3-100B	TAG22T3	386
TAG23-100	TAG23	421
TAG24-100	TAG24	421
TAG24T1-100B	TAG24T1	387
TAG25-100	TAG25	420
TAG26-100	TAG26	420
TAG26J-994	TAG26J	417
TAG26L-105	TAG26L	412
TAG26T6-100B	TAG26T6	386
TAG27-400	TAG27	418
TAG27-600	TAG27	419
TAG27T1-795	TAG27T1	390
TAG27T1-822	TAG27T1	392
TAG27T1-822C	TAG27T1	393
TAG27T2-DTH	TAG27T2	397
TAG28J-450	TAG28J	416
TAG28T4-250	TAG28T4	388
TAG2L-105	TAG2L	412
TAG2T5-100B	TAG2T5	386
TAG3-100	TAG3	420
TAG33T1-DTH	TAG33T1	397
TAG35T2-250	TAG35T2	388
TAG38T4-100B	TAG38T4	387
TAG3T3-100B	TAG3T3	387
TAG44-400	TAG44	418
TAG45L-789	TAG45L	409
TAG49L-105	TAG49L	412
TAG50L-105	TAG50L	413
TAG5-100	TAG5	420
TAG51J-994	TAG51J	417
TAG51L-105	TAG51L	412
TAG51T3-100B	TAG51T3	386
TAG52L-105	TAG52L	413
TAG53L-788	TAG53L	407
TAG53T2-100B	TAG53T2	387
TAG54L-788	TAG54L	407
TAG55L-788	TAG55L	407
TAG59J-108	TAG59J	415
TAG59L-788	TAG59L	407
TAG5J-994	TAG5J	417
TAG5L-105	TAG5L	412
TAG60L-788	TAG60L	407
TAG6-100	TAG6	421
TAG61L-788	TAG61L	407
TAG62L-788	TAG62L	407
TAG63L-105	TAG63L	412
TAG64J-994	TAG64J	417

Part No.	Type	Page
TAG64L-105	TAG64L	413
TAG65L-105	TAG65L	412
TAG66L-789	TAG66L	409
TAG67L-789	TAG67L	409
TAG68L-789	TAG68L	409
TAG68T1-336	TAG68T1	389
TAG69L-789	TAG69L	409
TAG69T1-336	TAG69T1	389
TAG6T1-100B	TAG6T1	387
TAG70T12-822	TAG70T12	391
TAG71T5-822	TAG71T5	391
TAG72T1-795	TAG72T1	390
TAG72T1-822	TAG72T1	392
TAG73T1-795	TAG73T1	390
TAG73T1-822	TAG73T1	392
TAG73T1-DTH	TAG73T1	397
TAG75T1-795	TAG75T1	390
TAG75T1-822	TAG75T1	392
TAG76T1-795	TAG76T1	390
TAG77T1-101	TAG77T1	395
TAG78T1-795	TAG78T1	390
TAG79T1-795	TAG79T1	390
TAG7T1-100B	TAG7T1	387
TAG80T1-795	TAG80T1	390
TAG81T8-822	TAG81T8	391
TAG82T2-822	TAG82T2	392
TAG83T1-822	TAG83T1	392
TAG84T3-822	TAG84T3	392
TAG9-100	TAG9	420
TAG96L-789	TAG96L	409
TAG96T1-336	TAG96T1	389
TAG9J-994	TAG9J	417
TAG9L-105	TAG9L	413
TAG9T3-100B	TAG9T3	386
TAGPHONE	TAGPHONE	414
TAGPP1-788	TAGPP1L	407
TAGPP1-788C	TAGPP1	408
TAGPP1J-108	TAGPP1J	415
TAGPP1T6-822	TAGPP1T6	391
TAGPP1T6-82210M	TAGPP1T6	391
TAGPP1T6-822C	TAGPP1T6	393
TAG-PP1T6-822C10M	TAGPP1T6	393
TAGPP2-788C	TAGPP2	408
TAGPP3T4-822	TAGPP3T4	391
TCWM1	TCWM1	440
TCWM10	TCWM10	440
TCWM11	TCWM11	440
TCWM12	TCWM12	440
TCWM13	TCWM13	440
TCWM14	TCWM14	440
TCWM15	TCWM15	440
TCWM16	TCWM16	440
TCWM2	TCWM2	440
TCWM3	TCWM3	440
TCWM4	TCWM4	440
TCWM5	TCWM5	440
TCWM6	TCWM6	440
TCWM7	TCWM7	440
TCWM8	TCWM8	440
TCWM9	TCWM9	440
TDNT	TDNT	282
TELS-1	EL-TY (TELS1)	78

Part No.	Type	Page
TELS-13	TELS-13	78
TELS-27	TELS-27	78
TELS-H	EL-TY (TELSH)	78
TELS-SPK2	EL-TY (TELS-SPK2)	78
TELS-SPOOL	TELS-SPOOL	78
TFOT-1	TFOT1	432
TM1SF0C2	TM1SF	154
TM1SF0M4	TM1SF	154
TM1SF1OC2	TM1SF	154
TM1SF1OM4	TM1SF	154
TM1SF9M4	TM1SF	154
TSR1FW-12	TSR1-12	294
TSR1FW-14	TSR1-14	293
TSR1FW-21-1	TSR1-21-1	292
TSR1FW-25-1	TSR1-25-1	291
TSR1FW-29-1	TSR1-29-1	290
TSR1FW-33-1	TSR1-33-1	289
TSR1FW-36	TSR1-36	288
TSR1FW-50	TSR1-50	287
TSR1FW-6A	TSR1-6A	285
TSR1FW-8A	TSR1-8A	285
TSR1I-12	TSR1-12	294
TSR1I-14	TSR1-14	293
TSR1I-21-1	TSR1-21-1	292
TSR1I-25-1	TSR1-25-1	291
TSR1I-29-1	TSR1-29-1	290
TSR1I-33-1	TSR1-33-1	289
TSR1I-36	TSR1-36	288
TSR1I-50	TSR1-50	287
TSR1I-6A	TSR1-6A	285
TSR1I-8A	TSR1-8A	285
TSR1W-12	TSR1-12	294
TSR1W-14	TSR1-14	293
TSR1W-21-1	TSR1-21-1	292
TSR1W-25-1	TSR1-25-1	291
TSR1W-29-1	TSR1-29-1	290
TSR1W-33-1	TSR1-33-1	289
TSR1W-36	TSR1-36	288
TSR1W-50	TSR1-50	287
TSR1W-6A	TSR1-6A	285
TSR1W-8A	TSR1-8A	285
TSR2FW-12	TSR2-12	294
TSR2FW-14	TSR2-14	293
TSR2FW-21-1	TSR2-21-1	292
TSR2FW-25-1	TSR2-25-1	291
TSR2FW-29-1	TSR2-29-1	290
TSR2FW-33-1	TSR2-33-1	289
TSR2FW-36	TSR2-36	288
TSR2FW-50	TSR2-50	287
TSR2FW-6A	TSR2-6A	286
TSR2FW-8A	TSR2-8A	285
TSR2I-12	TSR2-12	294
TSR2I-14	TSR2-14	293
TSR2I-21-1	TSR2-21-1	292
TSR2I-25-1	TSR2-25-1	291
TSR2I-29-1	TSR2-29-1	290
TSR2I-33-1	TSR2-33-1	289
TSR2I-36	TSR2-36	288
TSR2I-50	TSR2-50	287
TSR2I-6A	TSR2-6A	286
TSR2I-8A	TSR2-8A	285
TSR2W-12	TSR2-12	294
TSR2W-14	TSR2-14	293

Part No.	Type	Page
TSR2W-21-1	TSR2-21-1	292
TSR2W-25-1	TSR2-25-1	291
TSR2W-29-1	TSR2-29-1	290
TSR2W-33-1	TSR2-33-1	289
TSR2W-36	TSR2-36	288
TSR2W-50	TSR2-50	287
TSR2W-6A	TSR2-6A	286
TSR2W-8A	TSR2-8A	285
TSR3FW-12	TSR3-12	294
TSR3FW-14	TSR3-14	293
TSR3FW-21-1	TSR3-21-1	292
TSR3FW-25-1	TSR3-25-1	291
TSR3FW-29-1	TSR3-29-1	290
TSR3FW-33-1	TSR3-33-1	289
TSR3FW-36	TSR3-36	288
TSR3FW-50	TSR3-50	287
TSR3FW-6A	TSR3-6A	286
TSR3FW-8A	TSR3-8A	286
TSR3I-12	TSR3-12	294
TSR3I-14	TSR3-14	293
TSR3I-21-1	TSR3-21-1	292
TSR3I-25-1	TSR3-25-1	291
TSR3I-29-1	TSR3-29-1	290
TSR3I-33-1	TSR3-33-1	289
TSR3I-36	TSR3-36	288
TSR3I-50	TSR3-50	287
TSR3I-6A	TSR3-6A	286
TSR3I-8A	TSR3-8A	286
TSR3W-12	TSR3-12	294
TSR3W-14	TSR3-14	293
TSR3W-21-1	TSR3-21-1	292
TSR3W-25-1	TSR3-25-1	291
TSR3W-29-1	TSR3-29-1	290
TSR3W-33-1	TSR3-33-1	289
TSR3W-36	TSR3-36	288
TSR3W-50	TSR3-50	287
TSR3W-6A	TSR3-6A	286
TSR3W-8A	TSR3-8A	286
TSRFW-JB1	TSR-JB1	295
TSRFW-JB2	TSR-JB2	295
TSRFW-JB3	TSR-JB3	295
TSRFW-JBD	TSR-JBD	296
TSRFW-JBD2	TSR-JBD2	296
TSRI-JB1	TSR-JB1	295
TSRI-JB2	TSR-JB2	295
TSRI-JB3	TSR-JB3	295
TSRI-JBD	TSR-JBD	296
TSRI-JBD2	TSR-JBD2	296
TSRP1FW-12	TSRP1-12	303
TSRP1FW-14	TSRP1-14	304
TSRP1FW-21-1	TSRP1-21-1	305
TSRP1FW-25-1	TSRP1-25-1	299
TSRP1FW-29-1	TSRP1-29-1	302
TSRP1FW-33-1	TSRP1-33-1	301
TSRP1FW-36	TSRP1-36	300
TSRP1FW-50	TSRP1-50	298
TSRP1FW-6A	TSRP1-6A	297
TSRP1FW-8A	TSRP1-8A	297
TSRP1I-12	TSRP1-12	303
TSRP1I-14	TSRP1-14	304
TSRP1I-21-1	TSRP1-21-1	305
TSRP1I-25-1	TSRP1-25-1	299
TSRP1I-29-1	TSRP1-29-1	302
TSRP1I-33-1	TSRP1-33-1	301
TSRP1I-36	TSRP1-36	300
TSRP1I-50	TSRP1-50	298
TSRP1I-6A	TSRP1-6A	297
TSRP1I-8A	TSRP1-8A	297
TSRP1I-12	TSRP1-12	303
TSRP1I-14	TSRP1-14	304
TSRP1I-21-1	TSRP1-21-1	305
TSRP1I-25-1	TSRP1-25-1	299
TSRP1I-29-1	TSRP1-29-1	302
TSRP1I-33-1	TSRP1-33-1	301
TSRP1I-36	TSRP1-36	300
TSRP1I-50	TSRP1-50	298

Part No.	Type	Page
TSRP1I-33-1	TSRP1-33-1	301
TSRP1I-36	TSRP1-36	300
TSRP1I-50	TSRP1-50	298
TSRP1I-6A	TSRP1-6A	297
TSRP1I-8A	TSRP1-8A	297
TSRP1W-12	TSRP1-12	303
TSRP1W-14	TSRP1-14	304
TSRP1W-21-1	TSRP1-21-1	305
TSRP1W-25-1	TSRP1-25-1	299
TSRP1W-29-1	TSRP1-29-1	302
TSRP1W-33-1	TSRP1-33-1	301
TSRP1W-36	TSRP1-36	300
TSRP1W-50	TSRP1-50	298
TSRP1W-6A	TSRP1-6A	297
TSRP1W-8A	TSRP1-8A	297
TSRP2FW-12	TSRP2-12	303
TSRP2FW-14	TSRP2-14	304
TSRP2FW-21-1	TSRP2-21-1	305
TSRP2FW-25-1	TSRP2-25-1	299
TSRP2FW-29-1	TSRP2-29-1	302
TSRP2FW-33-1	TSRP2-33-1	301
TSRP2FW-36	TSRP2-36	300
TSRP2FW-50	TSRP2-50	298
TSRP2FW-6A	TSRP2-6A	297
TSRP2FW-8A	TSRP2-8A	297
TSRP2I-12	TSRP2-12	303
TSRP2I-14	TSRP2-14	304
TSRP2I-21-1	TSRP2-21-1	305
TSRP2I-25-1	TSRP2-25-1	299
TSRP2I-29-1	TSRP2-29-1	302
TSRP2I-33-1	TSRP2-33-1	301
TSRP2I-36	TSRP2-36	300
TSRP2I-50	TSRP2-50	298
TSRP2I-6A	TSRP2-6A	297
TSRP2I-8A	TSRP2-8A	297
TSRP2W-12	TSRP2-12	303
TSRP2W-14	TSRP2-14	304
TSRP2W-21-1	TSRP2-21-1	305
TSRP2W-25-1	TSRP2-25-1	299
TSRP2W-29-1	TSRP2-29-1	302
TSRP2W-33-1	TSRP2-33-1	301
TSRP2W-36	TSRP2-36	300
TSRP2W-50	TSRP2-50	298
TSRP2W-6A	TSRP2-6A	297
TSRP2W-8A	TSRP2-8A	297
TSRP3FW-12	TSRP3-12	303
TSRP3FW-14	TSRP3-14	304
TSRP3FW-21-1	TSRP3-21-1	305
TSRP3FW-25-1	TSRP3-25-1	299
TSRP3FW-29-1	TSRP3-29-1	302
TSRP3FW-33-1	TSRP3-33-1	301
TSRP3FW-36	TSRP3-36	300
TSRP3FW-50	TSRP3-50	298
TSRP3FW-6A	TSRP3-6A	297
TSRP3FW-8A	TSRP3-8A	297
TSRP3I-12	TSRP3-12	303
TSRP3I-14	TSRP3-14	304
TSRP3I-21-1	TSRP3-21-1	305
TSRP3I-25-1	TSRP3-25-1	299
TSRP3I-29-1	TSRP3-29-1	302
TSRP3I-33-1	TSRP3-33-1	301
TSRP3I-36	TSRP3-36	300
TSRP3I-50	TSRP3-50	298

Appendix

Index by Part Number

Part No.	Type	Page
TSRP3I-6A	TSRP3-6A	297
TSRP3I-8A	TSRP3-8A	297
TSRP3W-12	TSRP3-12	303
TSRP3W-14	TSRP3-14	304
TSRP3W-21-1	TSRP3-21-1	305
TSRP3W-25-1	TSRP3-25-1	299
TSRP3W-29-1	TSRP3-29-1	302
TSRP3W-33-1	TSRP3-33-1	301
TSRP3W-36	TSRP3-36	300
TSRP3W-50	TSRP3-50	298
TSRP3W-6A	TSRP3-6A	297
TSRP3W-8A	TSRP3-8A	297
TSRPFW-JB1	TSRP-JB1	307
TSRPFW-JB2	TSRP-JB2	307
TSRPFW-JB3	TSRP-JB3	307
TSRPFW-JBD	TSRP-JBD	308
TSRPFW-JBD2	TSRP-JBD2	308
TSRPFW-RB	TSRPFW-RB	306
TSRPI-JB1	TSRP-JB1	307
TSRPI-JB2	TSRP-JB2	307
TSRPI-JB3	TSRP-JB3	307
TSRPI-JBD	TSRP-JBD	308
TSRPI-JBD2	TSRP-JBD2	308
TSRPI-RB	TSRPI-RB	306
TSRPW-JB1	TSRP-JB1	307
TSRPW-JB2	TSRP-JB2	307
TSRPW-JB3	TSRP-JB3	307
TSRPW-JBD	TSRP-JBD	308
TSRPW-JBD2	TSRP-JBD2	308
TSRPW-RB	TSRPW-RB	306
TSRW-JB1	TSR-JB1	295
TSRW-JB2	TSR-JB2	295
TSRW-JB3	TSR-JB3	295
TSRW-JBD	TSR-JBD	296
TSRW-JBD2	TSR-JBD2	296
TT100OUTSM	TT100OUTSM	481
TT822OUT	TT822OUT	483
TT822OUT2	TT822OUT2	483
TT822OUT3	TT822OUT3	483
TT822OUT4	TT822OUT4	483
TT822OUT5	TT822OUT5	483
TT822OUT6	TT822OUT6	483
TT822OUT7	TT822OUT7	483
TT822OUT8	TT822OUT8	483
TT822OUTSM	TT822OUTSM	481
TT822OUTSM2	TT822OUTSM2	481
TT822OUTSM-2	TT822OUTSM-2	479
TT822OUTSM3	TT822OUTSM3	481
TT822OUTSM4	TT822OUTSM4	481
TT822OUTSM5	TT822OUTSM5	481
TT822OUTSM6	TT822OUTSM6	481
TT822OUTSM7	TT822OUTSM7	481
TT822OUTSM8	TT822OUTSM8	481
TT900OUT	TT900OUT	483
TTDTHOUT	TTDTHOUT	483
TTDTHOUTSM	TTDTHOUTSM	481
TTHSTOUT	TTHSTOUT	483
TTHSTOUTSM	TTHSTOUTSM	481
TWT1	TWT	505
TYHC0	TYHC0	441
TYHC1	TYHC1	441
TYHC10	TYHC10	441
TYHC100	TYHC100	443

Part No.	Type	Page
TYHC11	TYHC11	441
TYHC12	TYHC12	441
TYHC13	TYHC13	442
TYHC1-33	TYHC	441
TYHC14	TYHC14	442
TYHC15	TYHC15	442
TYHC16	TYHC16	442
TYHC17	TYHC17	442
TYHC18	TYHC18	442
TYHC19	TYHC19	442
TYHC2	TYHC2	441
TYHC20	TYHC20	442
TYHC21	TYHC21	442
TYHC22	TYHC22	442
TYHC23	TYHC23	442
TYHC24	TYHC24	442
TYHC25	TYHC25	442
TYHC26	TYHC26	442
TYHC27	TYHC27	442
TYHC28	TYHC28	442
TYHC29	TYHC29	442
TYHC3	TYHC3	441
TYHC30	TYHC30	442
TYHC31	TYHC31	442
TYHC32	TYHC32	442
TYHC33	TYHC33	442
TYHC34	TYHC34	442
TYHC34-66	TYHC34-66	441
TYHC35	TYHC35	442
TYHC36	TYHC36	442
TYHC37	TYHC37	442
TYHC38	TYHC38	442
TYHC39	TYHC39	442
TYHC4	TYHC4	441
TYHC40	TYHC40	442
TYHC41	TYHC41	442
TYHC42	TYHC42	442
TYHC43	TYHC43	442
TYHC44	TYHC44	442
TYHC45	TYHC45	442
TYHC46	TYHC46	442
TYHC47	TYHC47	442
TYHC48	TYHC48	442
TYHC49	TYHC49	442
TYHC5	TYHC5	441
TYHC50	TYHC50	442
TYHC51	TYHC51	443
TYHC52	TYHC52	443
TYHC53	TYHC53	443
TYHC54	TYHC54	443
TYHC55	TYHC55	443
TYHC6	TYHC6	441
TYHC67-99	TYHC67-99	441
TYHC7	TYHC7	441
TYHC8	TYHC8	441
TYHC81	TYHC	443
TYHC9	TYHC9	441
TYHCA	TYHCA	443
TYHCA-Z	TYHCA-Z	441
TYHCB	TYHCB	443
TYHCC	TYHCC	443
TYHCD	TYHCD	443
TYHCF	TYHCF	443

Part No.	Type	Page
TYHCL	TYHCL	443
TYHCN	TYHCN	443
TYHCP	TYHCP	443
TYHCS	TYHCS	443

Type	Part No.	Page
120VOLT	596-00591	451
120VOLT10	596-00669	462
120VOLTMS	596-00837	448
120VOLTS	596-00824	451
175REF	175REF	436
1FRP	1FRPOC	356
1FRP	1FRP9C	356
1N	1NOC	354
1N	1N9C	354
1NFP	1NFPOC	355
1NFP	1NFP9C	355
1P	1P9C	357
2.5FRP	2.5FRPOC	356
2.5FRP	2.5FRP9C	356
2.5N	2.5NOC	354
2.5N	2.5N9C	354
2.5NFP	2.5NFPOC	355
2.5NFP	2.5NFP9C	355
2.5P	2.5P9C	357
2FRP	2FRPOC	356
2FRP	2FRP9C	356
2N	2NOC	354
2N	2N9C	354
2NFP	2NFPOC	355
2NFP	2NFP9C	355
2P	2P9C	357
2TT130SMCKIT	556-00257	478
3FRP	3FRPOC	356
3FRP	3FRP9C	356
3N	3NOC	354
3N	3N9C	354
3NFP	3NFPOC	355
3NFP	3NFP9C	355
3P	3P9C	357
3X2CAUTION	596-00425	404, 446
3X2CAUTIONUV	596-00635	446
3X2DANGER	596-00424	404
3X2DANGERUV	596-00648	446
3X2NOTICE	596-00426	404
3X2SAFETY	596-00372	403
3X2WARNING	596-00622	404
3X2WARNINGUV	596-00634	446
430CFP	556-00431	482
430RLH	556-00433	482
430RRH	556-00434	482
430WLAN	556-00432	482
45MINICHNL	133-01480	179
45MINICHNL2	133-01478	179
4FRP	4FRPOC	356
4FRP	4FRP9C	356
4N	4NOC	354
4N	4N9C	354
4NFP	4NFPOC	355
4NFP	4NFP9C	355
4P	4P9C	357
4X6CAUTION	596-00427	404
4X6CAUTIONUV	596-00636	446
4X6DANGER	596-00203	404
4X6DANGERUV	596-00646	446
4X6NOTICE	596-00204	404
4X6SAFETY	596-00371	404
4X6WARNING	596-00621	404
4X6WARNINGUV	596-00633	446

Type	Part No.	Page
514REF	514REF	436
5FRP	161-05084	356
5FRP	5FRP9C	356
5N	5NOC	354
5N	5N9C	354
5NFP	5NFPOC	355
5NFP	5NFP9C	355
5P	5P9C	357
8D10	D10H4	175
8D15	D15L4	175
8D20	D20L4	175
90MINICHNL	133-01479	179
90MINICHNL2	133-01477	179
AC2011	596-00252	455
AC2011-1	596-00655	466
AC201110	596-00855	464
AC2011M5	596-00840	444
AC2011M5ENG	596-00862	445
AC2011S	596-00816	455
ACCB	596-00756	450
ACCB10	596-00758	462
ACDISC-1	596-00650	466
ACDISCS	596-00813	455
ACDISCT	596-00237	455
ACDISCT10	596-00853	464
ACDISCTM5	596-00841	444
ACRATING	596-00240	455
AF5X35D	596-00904	464
AF5X35W	596-00905	464
ASNP2-22	ASNP2-22	199
ASNP24-70	ASNP24-70	199
AT2060	AT2060	488
AT2BMNT	AT2BMNT	488
AT2OVHD	AT2OVHD	488
ATS3080	ATS10200000	489
ATSBCSKFT6.5	102-69067	182
Autotool 2000 CPK	106-00000	491
AZ100	QTTIEOHS	496
AZ100	QTTIE9	496
BC2212	151-00017	187
BC30	151-00016	187
BC90AH	151-00994	181
BC90AH2	151-01109	181
BC90FT6	151-00993	180
BC90FT6B	151-01051	180
BCAA	151-01565	193
BCBLGA	151-01566	193
BCCLGA	151-01567	193
BCFTOVAL	151-01239	183
BCFTOVAL	151-01403	183
BCFTOVAL2	151-01240	182
BCFTOVALXL	151-01888	183
BCSFT6.5 16-3MD	155-11601	182
BCSFTOVAL	151-01883	183
BCSFTOVAL2	151-01884	182
Bench mount kit 3080	ATS10200040	489
Bench mount kit CPK	106-00040	492
Big YCC T5	151-00235	189
BIPOLARPV	596-00590	451
BIPOLARPV10	596-00667	462
BIPOLARPVM5	596-00835	448
BLADEKIT	110-70106	501
BLANK2X125	596-00866	445

Type	Part No.	Page
BLANK375X2	596-00868	445
BLANK4X75	596-00867	445
BSBHK	170-03039	346
BSDISPLAY	170-03031	345
BSHDWV	170-03203	330
BSHDWV	170-03204	330
BSHDWV	170-03205	330
BSHDWV	170-03206	330
BSHDWV	170-03207	330
BSHKLP1140B	170-03150	342
BSHKLP120B	170-03148	342
BSHKLP200B	170-03151	342
BSHKLP212B	170-03152	342
BSHKLP340B	170-03149	342
BSHKLPFR1140B	170-03155	333
BSHKLPFR120B	170-03153	333
BSHKLPFR200B	170-03156	333
BSHKLPFR212B	170-03157	333
BSHKLPFR340B	170-03154	333
BSHTFG100	170-03061	335
BSHTFG100B	170-03053	335
BSHTFG120	170-03059	335
BSHTFG120B	170-03051	335
BSHTFG140	170-03058	335
BSHTFG140B	170-03050	335
BSHTFG340	170-03060	335
BSHTFG340B	170-03052	335
BSHTTST10SR	170-03064	337
BSHTTST10SRB	170-03056	337
BSHTTST12SR	170-03062	337
BSHTTST12SRB	170-03054	337
BSHTTST134SR	170-03065	337
BSHTTST134SRB	170-03057	337
BSHTTST212SR	170-03097	337
BSHTTST34SR	170-03063	337
BSHTTST34SRB	170-03055	337
BSHTTST38SR	170-03175	337
BSHTTSW112LB	170-03202	338
BSHTTSW1125B	170-03197	338
BSHTTSW1145B	170-03196	338
BSHTTSW12LB	170-03199	338
BSHTTSW125B	170-03192	338
BSHTTSW145B	170-03190	338
BSHTTSW11LB	170-03201	338
BSHTTSW15B	170-03195	338
BSHTTSW25B	170-03198	338
BSHTTSW34LB	170-03200	338
BSHTTSW345B	170-03194	338
BSHTTSW385B	170-03191	338
BSHTTSW585B	170-03193	338
BSNMX105B	170-03163	336
BSNMX1125B	170-03165	336
BSNMX1145B	170-03164	336
BSNMX125B	170-03161	336
BSNMX1345B	170-03166	336
BSNMX145B	170-03159	336
BSNMX185B	170-03158	336
BSNMX345B	170-03162	336
BSNMX385B	170-03160	336
BSP100	170-03003	327
BSP100B	170-03044	327
BSP103B	170-03079	328
BSP1120	170-03005	327

Appendix

Index by Type

Type	Part No.	Page
BSP1123B	170-03081	328
BSP1140	170-03004	327
BSP1140B	170-03045	327
BSP1143B	170-03080	328
BSP120	170-03001	327
BSP120B	170-03042	327
BSP123B	170-03077	328
BSP140	170-03000	327
BSP140B	170-03041	327
BSP143B	170-03076	328
BSP180	170-03177	327
BSP180B	170-03174	327
BSP200B	170-03178	327
BSP340	170-03002	327
BSP340B	170-03043	327
BSP343B	170-03078	328
BSPA66100	170-03029	343
BSPA66100B	170-03048	343
BSPA661140	170-03030	343
BSPA661140B	170-03049	343
BSPA66120	170-03027	343
BSPA66120B	170-03046	343
BSPA66140	170-03069	343
BSPA66140B	170-03070	343
BSPA66180	170-03209	343
BSPA66340	170-03028	343
BSPA66340B	170-03047	343
BSPA66580	170-03210	343
BSPFR100B	170-03093	331
BSPFR1120	170-03011	331
BSPFR1120B	170-03095	331
BSPFR1128	170-03066	331
BSPFR1140	170-03010	331
BSPFR1140B	170-03094	331
BSPFR120	170-03007	331
BSPFR120B	170-03091	331
BSPFR128	170-03073	331
BSPFR140	170-03006	331
BSPFR140B	170-03090	331
BSPFR148	170-03072	331
BSPFR180B	170-03089	331
BSPFR188	170-03071	331
BSPFR340	170-03008	331
BSPFR340B	170-03092	331
BSPFR348	170-03074	331
BSPFR380	170-03187	331
BSPHK	170-03040	346
BSPSC100	170-03014	329
BSPSC1120	170-03016	329
BSPSC1140	170-03015	329
BSPSC120	170-03012	329
BSPSC140	170-03035	329
BSPSC180	170-03123	329
BSPSC340	170-03013	329
BSPSW100	170-03025	340
BSPSW100B	170-03128	340
BSPSW100LB	170-03136	340
BSPSW103B	170-03085	341
BSPSW1120B	170-03130	340
BSPSW1120LB	170-03138	340
BSPSW1123B	170-03087	341
BSPSW1140	170-03026	340
BSPSW1140B	170-03129	340

Type	Part No.	Page
BSPSW1140LB	170-03137	340
BSPSW1143B	170-03086	341
BSPSW120	170-03024	340
BSPSW120B	170-03126	340
BSPSW120LB	170-03134	340
BSPSW123B	170-03083	341
BSPSW140	170-03037	340
BSPSW140B	170-03125	340
BSPSW140LB	170-03133	340
BSPSW143B	170-03082	341
BSPSW180B	170-03124	340
BSPSW180LB	170-03132	340
BSPSW200B	170-03131	340
BSPSW200LB	170-03139	340
BSPSW203B	170-03088	341
BSPSW340	170-03038	340
BSPSW340B	170-03127	340
BSPSW340LB	170-03135	340
BSPSW343B	170-03084	341
BSPSW380LB	170-03213	340
BSSCFR100	170-03019	332
BSSCFR100B	170-03120	332
BSSCFR1120	170-03021	332
BSSCFR1120B	170-03122	332
BSSCFR1140	170-03020	332
BSSCFR1140B	170-03121	332
BSSCFR120	170-03017	332
BSSCFR120B	170-03118	332
BSSCFR140	170-03036	332
BSSCFR140B	170-03117	332
BSSCFR180B	170-03116	332
BSSCFR340	170-03018	332
BSSCFR340B	170-03119	332
BSSWFR100B	170-03144	334
BSSWFR1120B	170-03146	334
BSSWFR1140B	170-03145	334
BSSWFR120B	170-03142	334
BSSWFR140B	170-03141	334
BSSWFR180B	170-03140	334
BSSWFR200B	170-03147	334
BSSWFR340B	170-03143	334
BSSWV100B	170-03185	339
BSSWV1120B	170-03186	339
BSSWV120B	170-03182	339
BSSWV340B	170-03184	339
BSSWV380B	170-03181	339
BSSWV580B	170-03183	339
BSWTOOL1	170-03033	347
BSWTOOL114	170-03034	347
BSWTOOL12	170-03032	347
BSWTOOL14	170-03067	347
BSWTOOL34	170-03068	347
BT105L	132-00032	128
BT105R	132-00033	128
BT130LDP	132-00034	128
BT130RDP	132-00035	128
CALTOOL	110-70089	501
CASEZ30SM	556-00231	480
CASE LG TT230SM	556-00238	480
CBACKFED	596-00236	451
CBACKFED	596-00587	451
CBACKFED10	596-00666	462
CBACKFEDM5	596-00834	448

Type	Part No.	Page
CBACKFEDS	596-00808	451
CBACKFEDS	596-00827	451
CBT050R	156-01601	123
CC08	151-00677	189
CC09	151-00765	188
CC12	151-01136	188
CCFT6LG	151-00785	189
CCFT6XLG	151-00786	189
CCII5FT6.5x13	151-00620	189
CCOVAL	151-00925	188
CCOVAL	151-01259	188
CCOVAL2	151-01108	188
CCOVAL3	151-01244	188
CCOVAL4	151-01246	189
CCOVAL5	151-01286	188
CCOVAL6	151-01033	188
CCSFT6.5	151-00775	189
CCSFT7x12	151-00194	189
CGS1	151-00006	163
CGS2	133-00285	163
CH20D6	151-00077	184
CH20D7	151-02600	184
CHA1	150-08110	182
CHA2	151-02901	182
Closures Black ATS3080	ATS10266210	495
CMF	CMFO4	439
CMF	CMFO72	439
COW20DP7	150-09201	184
COW30DP7	151-00080	184
CS1014AFEP	597-00122	476
CS1014CWYS	597-00098	476
CS1014DNOWG	597-00099	476
CS710AFEP	597-00121	475
CS710CWYS	597-00078	475
CS710DNOWG	597-00079	475
CSCIRLBL	596-00615	459
CSCIRLBL10	596-00673	461
CSCSNAP4R	596-00249	458
CSCSNAP72R	596-00251	458
CSESC	596-00245	459
CSESC	596-00613	459
CSESC10	596-00672	461
CSESC5	596-00821	459
CSG	181-00001	284
CSW	181-00002	284
CT0753	CT0753X2	429
CT1503	CT1503X2	429
CT2003	CT2003X2	429
CT2012	CT2012X2	429
CTA0753	CTA0753X2	429
CTA1503	CTA1503X2	429
CTAM1	151-00757	148
CTAM1	CTAM10C2	148
CTAM1	CTAM10M4	148
CTAM1	CTAM110C2	148
CTAM1	CTAM110M4	148
CTAM2	151-00758	148
CTAM2	CTAM20C2	148
CTAM2	CTAM20M4	148
CTAM2	CTAM210C2	148
CTAM2	CTAM210M4	148
CTAP1	CTAP10C2	149
CTAP1	CTAP10M4	149

Type	Part No.	Page
CTAP1	CTAP110C2	149
CTAP1	CTAP110M4	149
CTAP2	CTAP210C2	149
CTC10FT6LG	151-00018	194
CTC10FT9	155-17801	194
CTC13FT6	151-14312	194
CTC13FT6LG	151-00019	194
CTCFT6	151-00783	194
CTCL16FT6LG	151-00621	194
CTM0	CTM00C2	150
CTM0	CTM00M4	150
CTM0	CTM010C2	150
CTM0	CTM010M4	150
CTM1	CTM10C2	150
CTM1	CTM10M4	150
CTM1	CTM110C2	150
CTM1	CTM110M4	150
CTM2	CTM20C2	150
CTM2	CTM20M4	150
CTM2	CTM210C2	150
CTM2	CTM210M4	150
CTM3	CTM30C2	151
CTM3	CTM30M4	151
CTM3	CTM310C2	151
CTM3	CTM310M4	151
CTM4	CTM40C2	151
CTM4	CTM40M4	151
CTM4	CTM410C2	151
CTM4	CTM410M4	151
CTN10	169-60021	360
CTN10	CTN10	359
CTN10	CTN10STD	359
CTN1120	CTN1120	359
CTN1120	CTN1120STD	359
CTN1140	CTN1140	359
CTN1140	CTN1140STD	359
CTN120	169-60019	360
CTN120	CTN120	359
CTN120	CTN120STD	359
CTN140	169-60022	360
CTN140	CTN140	359
CTN140	CTN140STD	359
CTN20	CTN20STD	359
CTN340	169-60020	360
CTN340	CTN340	359
CTN340	CTN340STD	359
CTN380	169-60018	360
CTN380	CTN380	359
CTN380	CTN380STD	359
CTN580	CTN580STD	359
CTN580 UNSLIT	169-60024	359
CTP10	CTP10	361
CTP10	CTP10STD	361
CTP1120	CTP1120	361
CTP1120	CTP1120STD	361
CTP1140	CTP1140	361
CTP1140	CTP1140STD	361
CTP120	CTP120	361
CTP120	CTP120STD	361
CTP140	CTP140	361
CTP140	CTP140STD	361
CTP20	CTP20STD	361
CTP340	CTP340	361

Type	Part No.	Page
CTP340	CTP340STD	361
CTP380	CTP380	361
CTP380	CTP380STD	361
CTP580	CTP580	361
CTP580	CTP580STD	361
CTQM5	151-10920	152
CTQM5	151-10930	152
CTT20R	CTT20R0C2	60
CTT20R	CTT20R0HSC2	60
CTT20R	CTT20R0HSM4	60
CTT20R	CTT20R9C2	60
CTT20R	CTT20R9M4	60
CTT60R	CTT60R0C2	60
CTT60R	CTT60R0HIRC2	60
CTT60R	CTT60R0HIRHSM4	60
CTT60R	CTT60R0HSC2	60
CTT60R	CTT60R0HSM4	60
CTT60R	CTT60R9C2	60
CTT60R	CTT60R9M4	60
DC2011	596-00253	455
DC2011-1	596-00653	466
DC201110	596-00850	464
DC2011M5	596-00839	444
DC2011M5ENG	596-00863	445
DC2011S	596-00817	455
DC2017	596-00891	455
DC201710	596-00881	464
DC2017M5	596-00918	444
DC2017M5ENG	596-00922	445
DCCB	596-00740	450
DCCB10	596-00746	462
DCD	596-00757	450
DCD10	596-00759	462
DCDISC-1	596-00651	466
DCDISCS	596-00814	456
DCDISCT	596-00238	456
DCDISCT10	596-00854	464
DCDISCTM5	596-00842	444
DCDISCTM5ENG	596-00858	445
DCJB	596-00738	450
DCJB10	596-00744	462
DCRATING	596-00241	456
DCRATING-1	596-00654	466
DCRATING10	596-00851	465
DCRATINGM5	596-00864	444
DCRATINGM5ENG	596-00865	445
DCT11	DCT110HIRC2	133
DCT11	DCT110HIRH1	133
DCT11	DCT110HIRK2	133
DCT9	DCT90HIRC2	133
DCT9	DCT90HIRH1	133
DCT9	DCT90HIRK2	133
DNALP	596-00739	450
DNDCUL	596-00244	459
DNDCUL10	596-00671	461
DS1014CSEBPO	597-00094	475
DS1014DHV	597-00092	475
DS1014NSM	597-00088	475
DS1014TMSASA	597-00097	476
DS275X135	596-00387	403
DS55X275	596-00389	403
DS710CSEBPO	597-00074	474
DS710DHV	597-00072	474

Type	Part No.	Page
DS710NSM	597-00068	474
DS710TMSASA	597-00077	475
DSWS4	151-00644	135
DSWS4	151-06500	135
DSWS5	DSWS50HSH1	136
DSWS5	DSWS50HSH2	136
DV1.5	181-00301	278
DV1.5	181-00306	278
DV1	181-00300	278
DV1	181-00305	278
DV2	181-00302	278
DV2	181-00307	278
DV275X135	596-00379	403
DV3	181-00303	278
DV3	181-00308	278
DV4	181-00304	278
DV4	181-00309	278
DV55X275	596-00377	403
DVM	181-00684	279
EC14	151-03404	190
EC15	151-03401	190
EC16	151-03402	190
EC17	151-03403	190
EC30	EC30.HB6P	190
EC31	151-00152	190
EC42	151-00429	189
EC43	151-00430	189
EC46	151-01113	189
EC48	151-01206	190
EC6mod	151-00464	189
ECC1CPT	151-00499	189
ECCMPV	596-00748	450
ECCMPV10	596-00749	462
EE1014AWS	597-00124	475
EE710AWS	597-00123	474
EL-TY (TELS1)	TELS-1	78
EL-TY (TELSH)	TELS-H	78
EL-TY (TELS-SPK2)	TELS-SPK2	78
ES1014EXIT	597-00102	476
ES710EXIT	597-00082	475
ESSDCD	596-00986	451
EVO7	110-70083	501
EVO7 nosepiece 1mm	110-70131	501
EVO7 nosepiece 2mm	110-70132	501
EVO7 nosepiece 3mm	110-70133	501
EVO7SP	110-70084	501
EVO9	110-80000	502
EVO9	110-80018	502
EVO9	110-80064	502
EVO9	110-80065	502
EVO9	110-80066	502
EVO9	110-80067	502
EVO9HT	110-80004	502
EVO9SP	110-80001	502
FC1.2	FC1.2K2	203
FC1.2A	FC1.2AH4	202
FC1.2A	FC1.2AK2	202
FC14	FC140	176
FC14	FC1410	176
FC2.2	FC2.2H4	203
FC2.2	FC2.2K2	203
FC2.2A	FC2.2AH4	202
FC2.2A	FC2.2AK2	202

Appendix

Index by Type

Type	Part No.	Page
FMB4APT-I	151-01527	145
FMB4APT-I	151-01528	145
FOM	FOM-150	431
FOM	FOM-175	431
FOM	FOM-75	431
Front Nosepiece	110-95291	504
FS1014FE	597-00103	476
FS710FAS	597-00085	474
FS710FE	597-00083	475
FT6LG.JAE.CONNECTTS	151-00459	189
FT6LG.M.St.Aufn.II	155-32602	189
FT6LG.YAZ.CONNECT-TS	155-30702	189
FT6LG-AMP	155-03800	189
G51NA	FHA	363
G51NB	FHB	363
G51NC	FHC	363
G51ND	FHD	363
G51NE	FHE	363
G51NF	FHF	363
G51NG	FHG	363
G51PA	FPA	364
G51PAA	FPA	364
G51PB	FPB	364
G51PC	FPC	364
G51PD	FPD	364
G51PE	FPE	364
G51PF	FPF	364
G51PG	FPG	364
G51PH	FPH	364
G51TA	FTA	365
G51TB	FTB	365
G51TC	251-30309	365
G51TD	251-30409	365
G51TE	251-30509	365
G51TF	251-30609	365
G51TG	251-30709	365
G51TH	251-30809	365
GT.375X6	GT.375X60C2	71
GT.50X11	GT.50X110C2	72
GT.50X11	GT.50X110P2	72
GT.50X11	GT.50X112C2	72
GT.50X11	GT.50X112P2	72
GT.50X11	GT.50X113C2	72
GT.50X11	GT.50X113P2	72
GT.50X11	GT.50X114C2	72
GT.50X11	GT.50X114P2	72
GT.50X11	GT.50X115C2	72
GT.50X11	GT.50X115P2	72
GT.50X11	GT.50X116C2	72
GT.50X11	GT.50X116P2	72
GT.50X11W	GT.50X110C2W	77
GT.50X11W	GT.50X110P2W	77
GT.50X12	GT.50X12MP2V2	76
GT.50X6	GT.50X60C2	71
GT.50X6	GT.50X60P2	71
GT.50X6	GT.50X62C2	71
GT.50X6	GT.50X62P2	71
GT.50X6	GT.50X63C2	71
GT.50X6	GT.50X63P2	71
GT.50X6	GT.50X64C2	71
GT.50X6	GT.50X64P2	71
GT.50X6	GT.50X65C2	71
GT.50X6	GT.50X65P2	71

Type	Part No.	Page
GT.50X6	GT.50X66C2	71
GT.50X6	GT.50X66P2	71
GT.50X6	GT.50X6MP2V2	76
GT.50X6W	GT.50X60C2W	77
GT.50X6W	GT.50X60P2W	77
GT.50X8	GT.50X80C2	71
GT.50X8	GT.50X80P2	71
GT.50X8	GT.50X82C2	71
GT.50X8	GT.50X82P2	71
GT.50X8	GT.50X83C2	71
GT.50X8	GT.50X83P2	71
GT.50X8	GT.50X84C2	71
GT.50X8	GT.50X84P2	71
GT.50X8	GT.50X85C2	71
GT.50X8	GT.50X85P2	71
GT.50X8	GT.50X86C2	71
GT.50X8	GT.50X86P2	71
GT.50X8	GT.50X8MP2V2	76
GT.50X8W	GT.50X80C2W	77
GT.50X8W	GT.50X80P2W	77
GT.75X15	GT.75X150C2	73
GT.75X15	GT.75X150P2	73
GT.75X15	GT.75X152C2	73
GT.75X15	GT.75X152P2	73
GT.75X15	GT.75X153C2	73
GT.75X15	GT.75X153P2	73
GT.75X15	GT.75X154C2	73
GT.75X15	GT.75X154P2	73
GT.75X15	GT.75X155C2	73
GT.75X15	GT.75X155P2	73
GT.75X15	GT.75X156C2	73
GT.75X15	GT.75X156P2	73
GT.75X180	GT.75X1800	74
GT.75X180	GT.75X18010	74
GT.75X180	GT.75X1802	74
GT.75X180	GT.75X1803	74
GT.75X180	GT.75X1804	74
GT.75X180	GT.75X1805	74
GT.75X180	GT.75X1806	74
GT.75X180W	GT.75X1800W	74
GT.75X600	GT.75X6000	74
GT.75X900	GT.75X9000	74
GT.75X900	GT.75X9004	74
GTLP50X11	GTLP50X110P2	75
GTLP50X6	GTLP50X60P2	75
GTLP50X8	GTLP50X80P2	75
GTM100	GTM1000C2	157
GTM100A	GTM100A0C2	157
GTM50	GTM500C2	157
GTM50A	GTM50A0C2	157
GW	GWCO03X2	430
GW	GWTO03X2	430
H10P	211-60009	201
H12P	211-60130	201
H13P	211-60140	201
H14P	211-60150	201
H15P	211-60160	201
H1P	211-00261	200
H1P	211-60000	200
H1P	211-60010	200
H1P	211-60019	200
H2P	211-00262	200
H2P	211-00263	200

Type	Part No.	Page
H2P	211-60001	200
H2P	211-60029	200
H3P	211-00264	200
H3P	211-60002	200
H3P	211-60039	200
H3P	211-60040	200
H4P	211-60003	200
H4P	211-60049	200
H4P	211-60050	200
H5P	211-00266	200
H5P	211-00267	200
H5P	211-60004	200
H5P	211-60059	200
H6P	211-60005	200
H6P	211-60061	200
H7P	211-00269	201
H7P	211-60006	201
H7P	211-60078	201
H7P	211-60079	201
H8P	211-60007	201
H8P	211-60089	201
H8P	211-60090	201
H9P	211-00271	201
H9P	211-60008	201
H9P	211-60099	201
HAT16	161-60002	353
HAT20	161-60003	353
HAT25	161-60004	353
HAT30	161-60005	353
HAT8	161-60001	353
HC2A	133-00993	137
HC2B	133-00994	137
HC2C	133-00995	137
HC2D	133-00996	137
HC2E	133-00997	137
HC3A	133-00998	137
HCPM-2	148-90036	508
HCPM-2	148-90048	508
HCPM-3	148-90037	508
HCPM-3	148-90049	508
HCPM-4	148-90038	509
HCPM-4	148-90050	509
HCPM-5	148-90039	509
HCPM-5	148-90051	509
HCPM-6	148-90040	509
HCPM-6	148-90052	509
HCPM-8	148-90041	509
HCPM-8	148-90053	509
HDHC59	151-01231	138
HDM19	HDM190HIRC2	158
HDM19	HDM190HIRH4	158
HDM25	HDM250HIRC2	158
HDM25	HDM250HIRH4	158
HDM312	HDM3120HIRC2	158
HDM312	HDM3120HIRH4	158
HDM320	151-02094	160
HDM320	151-02098	160
HDM321	HDM321HIHSUVH4159	
HDM375BDM4W	151-02104	161
HDM401	HDM401HIHSUVH4159	
HDM500	151-02096	160
HDM500	151-02097	160
HDM501	HDM501HIHSUVH4159	

Type	Part No.	Page
HEGPA6604	170-20400	344
HEGPA6606	170-20600	344
HEGPA6608	170-20800	344
HEGPA6610	170-21000	344
HEGPA6612	170-21200	344
HEGPA6620	170-22000	344
HEGPA6625	170-22500	344
HEGPA6630	170-23000	344
HEGPA6650	170-25000	344
HFST39-13WH-S	553-50226	425
HFST39-13YE	553-50225	425
HFST39-13YE-S	553-50227	425
HH20	HH-20	174, 492
HIS-3-BAG 12/4 BK	308-31220	369
HIS-3-BAG 12/4 CL	308-31221	369
HIS-3-BAG 3/1 BK	308-30320	369
HIS-3-BAG 3/1 CL	308-30321	369
HIS-3-BAG 4.5/1.5 BK	308-30420	369
HIS-3-BAG 4.5/1.5 CL	308-30421	369
HIS-3-BAG 6/2 BK	308-30620	369
HIS-3-BAG 6/2 CL	308-30621	369
HIS-3-BAG 9/3 BK	308-30920	369
HIS-3-BAG 9/3 CL	308-30921	369
HL2X2YE	596-00800	447
HL3X3YE	596-00801	447
HM4	151-00973	169
HM5	151-00812	169
HMSA	151-00975	170
HM6	151-00813	169
HM6A	151-00976	170
HM7	151-00814	169
HST12-4BK	553-50028	425
HST12-4WH	553-50029	425
HST12-4WH	553-50193	425
HST12-4WH	553-50231	425
HST12-4WH-3S	553-50086	424
HST12-4WHAP	553-50206	425
HST12-4WH-S	553-50030	425
HST12-4WH-S	553-50232	425
HST12-4WH-S	553-50250	425
HST12-4YE	553-50031	425
HST12-4YE-3S	553-50087	424
HST12-4YE-S	553-50032	425
HST18-6BK	553-50033	425
HST18-6BK-S	553-50222	425
HST18-6WH	553-50034	425
HST18-6WH	553-50199	425
HST18-6WH	553-50233	425
HST18-6WH-S	553-50035	425
HST18-6WH-S	553-50234	425
HST18-6YE	553-50036	425
HST18-6YE	553-50240	425
HST18-6YE-S	553-50037	425
HST18-6YE-S	553-50241	425
HST24-8BK	553-50038	425
HST24-8BK-S	553-50223	425
HST24-8WH	553-50039	425
HST24-8WH	553-50237	425
HST24-8WH-S	553-50040	425
HST24-8YE	553-50041	425
HST24-8YE-S	553-50042	425
HST3-1BK	553-50001	423
HST3-1BK-2S	553-50180	422

Type	Part No.	Page
HST3-1BK-3S	553-50181	422
HST3-1BK-S	553-50179	423
HST3-1WH	553-50002	423
HST3-1WH	553-50003	423
HST3-1WH	553-50078	423
HST3-1WH-2S	553-50070	422
HST3-1WH-2S	553-50075	422
HST3-1WH-3S	553-50063	422
HST3-1WH-3S	553-50088	422
HST3-1WH-3S	553-50211	422
HST3-1WH-S	553-50004	423
HST3-1WH-S	553-50067	423
HST3-1WH-S	553-50074	423
HST3-1YE	553-50005	423
HST3-1YE	553-50006	423
HST3-1YE-2S	553-50071	422
HST3-1YE-2S	553-50077	422
HST3-1YE-S	553-50007	423
HST3-1YE-S	553-50076	423
HST39-13WH	553-50209	425
HST4.8-1.6BK	553-50008	423
HST4.8-1.6BK-3S	553-50184	423
HST4.8-1.6WH	553-50009	423
HST4.8-1.6WH	553-50010	423
HST4.8-1.6WH	553-50079	423
HST4.8-1.6WH	553-50090	423
HST4.8-1.6WH	553-50177	423
HST4.8-1.6WH	553-50195	423
HST4.8-1.6WH-2S	553-50068	423
HST4.8-1.6WH-2S	553-50072	423
HST4.8-1.6WH-3S	553-50064	423
HST4.8-1.6WH-3S	553-50081	423
HST4.8-1.6WHAP	553-50203	423
HST4.8-1.6WH-S	553-50011	423
HST4.8-1.6WH-S	553-50080	423
HST4.8-1.6WH-S	553-50176	423
HST4.8-1.6WH-S	553-50213	423
HST4.8-1.6YE	553-50012	423
HST4.8-1.6YE-2S	553-50069	423
HST4.8-1.6YE-2S	553-50073	423
HST4.8-1.6YE-S	553-50014	423
HST4.8-1YE-3S	553-50239	423
HST6-2BK	553-50015	424
HST6-2BK-2S	553-50186	424
HST6-2BK-3S	553-50178	423
HST6-2WH	553-50016	424
HST6-2WH	553-50017	424
HST6-2WH	553-50018	424
HST6-2WH	553-50196	424
HST6-2WH-2S	553-50082	424
HST6-2WH-3S	553-50065	424
HST6-2WH-3S	553-50089	424
HST6-2WH-3S	553-50212	424
HST6-2WHAP	553-50204	424
HST6-2WH-S	553-50019	424
HST6-2WH-S	553-50084	424
HST6-2WH-S	553-50242	424
HST6-2YE	553-50020	424
HST6-2YE-2S	553-50083	424
HST6-2YE-3S	553-50210	424
HST6-2YE-S	553-50022	424
HST6-2YE-S	553-50085	424
HST9-3BK	553-50023	424

Type	Part No.	Page
HST9-3BK-3S	553-50189	424
HST9-3WH	553-50024	424
HST9-3WH	553-50192	424
HST9-3WH	553-50236	424
HST9-3WH-2S	553-50251	424
HST9-3WH-3S	553-50066	424
HST9-3WHAP	553-50205	424
HST9-3WH-S	553-50025	424
HST9-3YE	553-50026	424
HST9-3YE-S	553-50027	424
HT1BK250	558-00307	398
HT1BU250	558-00339	398
HT1GN250	558-00340	398
HT1OE250	558-00336	398
HT1RD250	558-00308	398
HT1RDHB250	558-00501	401
HT1RDRF250	558-00377	399
HT1WH250	558-00309	398
HT1YE250	558-00310	398
HT2BK250	558-00311	398
HT2BU250	558-00341	398
HT2GN250	558-00342	398
HT2OE250	558-00337	398
HT2OE50250	558-00327	402
HT2OE50250UV	558-00380	400
HT2RD250	558-00312	399
HT2RDHB250	558-00502	401
HT2RDRF250	558-00372	399
HT2WH250	558-00313	399
HT2YE250	558-00314	399
HT2YE50250	558-00328	402
HT3BK250	558-00374	399
HT3BU250	558-00343	399
HT3GN250	558-00344	399
HT3OE250	558-00338	399
HT3OE75250	558-00330	402
HT3OE75250UV	558-00381	400
HT3RD250	558-00006	399
HT3RDHB250	558-00503	401
HT3RDRF250	558-00373	399
HT3WH250	558-00345	399
HT3YE250	558-00346	399
HT3YE75250	558-00331	402
HT4GN250	558-00351	399
HT4OE10250	558-00333	402
HT4OE10250UV	558-00382	400
HT4OE250	558-00411	399
HT4RD250	558-00370	399
HT4RDF100	558-00407	399
HT4WH250	558-00350	399
HT4YE10250	558-00334	402
HT4YE250	558-00358	399
HTS6-2YE	553-50021	424
HWBASE	161-64014	352
HWBASEA	161-64013	352
HWCLIP08	161-64002	351
HWCLIP16	161-64004	351
HWCLIP20	161-64006	351
HWCLIP25	161-64008	351
HWCLIP30	161-64010	351
HWPVAV016	161-63203	350
HWPVAV020	161-63303	350
HWPVAV025	161-63403	350

Appendix

Index by Type

Type	Part No.	Page
HWPAV030	161-63503	350
HWPAV08	161-63103	350
HWPP16	161-62000	349
HWPP16	161-64213	348
HWPP16	161-64216	348
HWPP16	161-64217	349
HWPP20	161-64310	348
HWPP20	161-64311	348
HWPP25	161-62001	349
HWPP25	161-64414	348
HWPP25	161-64416	348
HWPP25	161-64417	349
HWPP30	161-64507	348
HWPP8	161-64112	348
IMP1.5	IMP1.510C2	433
IMP1.75	IMP1.7510C2	433
IMP2.5	IMP2.510C2	433
IMP2.5	IMP2.510M4	433
IMP2.5	IMP2.5W1.7510C2	433
IMP2.5	IMP2.5W1.7510H4	433
IMP2	IMP210C2	433
IMP3.5	IMP3.510C2	433
IOC	596-00750	450
IOC10	596-00753	462
IOCOD	596-00589	451
IOCOD10	596-00668	463
IOCOD14	596-00846	452
IOCOD17	596-00880	452
IOCOD1710	596-00895	463
IOCOD17M5	596-00917	448
IOCOD17ST	596-00883	452
IOCOD17ST10	596-00884	463
IOCODM5	596-00836	448
IOCOD5	596-00826	452
IT18FL	IT18FL0C2	64
IT18FL	IT18FL0L4	64
IT18FL	IT18FL10L4	64
IT18FL	IT18FL2L4	64
IT18FL	IT18FL3L4	64
IT18FL	IT18FL4L4	64
IT18FL	IT18FL6L4	64
IT18FL	IT18FL9C2	64
IT18FL	IT18FL9L4	64
IT18R	IT18R0C2	63
IT18R	IT18R0L4	63
IT18R	IT18R10C2	63
IT18R	IT18R10L4	63
IT18R	IT18R2C2	63
IT18R	IT18R2L4	63
IT18R	IT18R3C2	63
IT18R	IT18R3L4	63
IT18R	IT18R4L4	63
IT18R	IT18R6C2	63
IT18R	IT18R6L4	63
IT18R	IT18R8C2	63
IT18R	IT18R9C2	63
IT18R	IT18R9L4	63
IT50L	IT50L0M4	65
IT50L	IT50L3M4	65
IT50L	IT50L4M4	65
IT50L	IT50L6M4	65
IT50L	IT50L9C2	65
IT50R	IT50R0C2	64

Type	Part No.	Page
IT50R	IT50R0M4	64
IT50R	IT50R10C2	64
IT50R	IT50R2C2	64
IT50R	IT50R3M4	64
IT50R	IT50R4C2	64
IT50R	IT50R9C2	64
IT50R	IT50R9M4	64
IT50RD	IT50RD0K2	64
IT50RD	IT50RD4K2	64
IT50RD	IT50RD9K2	64
IT50RT	IT50RT0K2	65
IT50RT	IT50RT4K2	65
IT50RT	IT50RT9K2	65
KR6/35	121-63560	80
KR6/8	121-00680	504
KR8/21	121-82119	80
KR8/21	121-82160	80
KR8/33	121-83355	80
KR8/33	121-83360	80
KR8/33	121-83378	80
KR8/43	121-74359	80
LABEL HOLDER	556-00235	480
LAM1	596-00242	454
LAM110	596-00670	454
LOC1014FT6LG	151-01166	225
LOC1014FT9x12	151-02218	225
LOC1014FT9x12	151-02501	225
LOC15-19FT6LG	151-01022	226
LOC15-19FT6LG2	151-01023	225
LOC20-25FT6.5LG	151-01371	226
LOC59FT6LG	151-01017	225
LOC5-9FTOVAL	151-01306	225
LPM25	151-01122	166
LTM250	LTM2500C2	165
MB1	MB10C2	147
MB1	MB10M4	147
MB1	MB19C2	147
MB1	MB19M4	147
MB2.5	MB2.50C2	146
MB2.5	MB2.510C2	146
MB2.5	MB2.510M4	146
MB2.5A	MB2.5A0C2	139
MB2.5A	MB2.5A0M4	139
MB2.5A	MB2.5A10C2	139
MB2.5A	MB2.5A10M4	139
MB2	MB29C2	147
MB2	MB29M4	147
MB3	MB30C2	146
MB3	MB30M4	146
MB3	MB310C2	146
MB3	MB310M4	146
MB3A	151-01629	142
MB3A	151-01630	142
MB3A	MB3A0A2H4	141
MB3A	MB3A0C2	139
MB3A	MB3A0M4	139
MB3A	MB3A10A2C2	141
MB3A	MB3A10A2H4	141
MB3A	MB3A10C2	139
MB3A	MB3A10M4	139
MB4	MB40C2	146
MB4	MB40H4	146
MB4	MB410C2	146

Type	Part No.	Page
MB4	MB410H4	146
MB4A	151-00646	141
MB4A	151-00810	141
MB4A	151-01631	142
MB4A	151-01632	142
MB4A	MB4A0A2H4	141
MB4A	MB4A0C2	139
MB4A	MB4A0H4	139
MB4A	MB4A10A2C2	141
MB4A	MB4A10A2H4	141
MB4A	MB4A10C2	139
MB4A	MB4A10H4	139
MB4SH	MB4SH10C2	146
MB4SH	MB4SH10H4	146
MB4SHA	MB4SHA0C2	140
MB4SHA	MB4SHA0H4	140
MB4SHA	MB4SHA10C2	140
MB4SHA	MB4SHA10H4	140
MB5	MB50C2	146
MB5	MB50F4	146
MB5	MB510C2	146
MB5	MB510F4	146
MB5A	151-01633	142
MB5A	151-01634	142
MB5A	MB5A0A2F4	141
MB5A	MB5A0C2	140
MB5A	MB5A0F4	140
MB5A	MB5A10A2F4	141
MB5A	MB5A10C2	140
MB5A	MB5A10F4	140
MBML10X45	544-80101	469
MBML10X90	544-80102	469
MBML20X45	544-80201	469
MBML20X90	544-80202	469
M-BOSS Compact	544-20000	468
M-BOSS Compact Organiser	544-21000	468
MBSDIS	596-00987	456
MBT14H	MBT14H	69
MBT14HS	MBT14H-S	67
MBT14S	MBT14S	68
MBT14SS	MBT14S-S	66
MBT14UH	111-01301	70
MBT14XH	111-95149	69
MBT14XH5	111-95148	67
MBT20H	MBT20H	69
MBT20HS	MBT20H-S	67
MBT20S	MBT20S	68
MBT20SS	MBT20S-S	66
MBT20UH	111-01302	70
MBT20XH	111-95209	69
MBT20XH5	111-95208	67
MBT27H	MBT27H	69
MBT27HS	MBT27H-S	67
MBT27S	MBT27S	68
MBT27SS	MBT27S-S	66
MBT27UH	111-01303	70
MBT27XH	111-95279	69
MBT27XH5	111-95278	67
MBT33H	MBT33H	69
MBT33HS	MBT33H-S	67
MBT33S	MBT33S	69
MBT33SS	MBT33S-S	66
MBT33UH	111-01304	70

Type	Part No.	Page
MBT33XH	111-95339	70
MBT33XHS	111-95338	67
MBT43UH	111-01305	70
MBT49UH	111-01306	70
MBT5S	MBT5S	68
MBT5SS	MBT5S-S	66
MBT8H	MBT8H	69
MBT8HS	MBT8H-S	67
MBT8S	MBT8S	68
MBT8SS	MBT8S-S	66
MCCTAM1	151-00997	148
MCKR6G5	151-00950	151
MCKR8G5-5	151-01020	151
MCMB3	151-01169	146
MCMB4	151-01170	146
MCR-B10	MCRFW-B10	309
MCR-B10	MCRI-B10	309
MCR-B8	MCRFW-B8	309
MCR-B8	MCRI-B8	309
MCR-B5	MCRFW-B5	310
MCR-B5	MCRI-B5	310
MCR-B510	MCRFW-B510	309
MCR-B510	MCRI-B510	309
MCR-B58	MCRFW-B58	309
MCR-B58	MCRI-B58	309
MCR-C10	MCRFW-C10	309
MCR-C10	MCRI-C10	309
MCR-C8	MCRFW-C8	309
MCR-C8	MCRI-C8	309
MCR-CD10	MCRFW-CD10	311
MCR-CD10	MCRI-CD10	311
MCR-CD8	MCRFW-CD8	311
MCR-CD8	MCRI-CD8	311
MCR-CS	MCRFW-CS	315
MCR-CS	MCRI-CS	315
MCR-EC	MCRFW-EC	316
MCR-EC	MCRI-EC	316
MCR-EE	MCRFW-EE	312
MCR-EE	MCRI-EE	312
MCR-ENT	MCRFW-ENT	321
MCR-ENT	MCRI-ENT	321
MCR-FE	MCRFW-FE	313
MCR-FE	MCRI-FE	313
MCR-IE	MCRFW-IE	314
MCR-IE	MCRI-IE	314
MCR-LTD	MCR-LTD	325
MCR-OB	MCRFW-OB	318
MCR-OB	MCRI-OB	318
MCR-OE	MCRFW-OE	322
MCR-OE	MCRI-OE	322
MCR-OEB	MCRFW-OEB	323
MCR-PTF	MCRFW-PTF	317
MCR-PTF	MCRI-PTF	317
MCR-RDB	MCRFW-RDB	319
MCR-RDB	MCRI-RDB	319
MCR-REB	MCRFW-REB	320
MCR-REB	MCRI-REB	320
MCR-SD10	MCRFW-SD10	311
MCR-SD8	MCRFW-SD8	311
MCR-TE	MCRFW-TE	324
MCR-TE	MCRI-TE	324
MCR-TM	MCRG-TM	326
MCR-WR	MCRG-WR	326

Type	Part No.	Page
MCT120R	111-01136	41
MCT18R	111-01225	41
MCT30R	111-00829	41
MCT50L	111-00831	41
MCT50R	111-00830	41
MCTPP120R	111-01668	41
MCTPP18R	111-01664	41
MCTPP30R	111-01665	41
MCTPP50L	111-01667	41
MCTPP50R	111-01666	41
MCTRELK2M	111-00937	41
MCTS200	111-01386	41
MINICHNLU	133-01476	178
MK7HT	MK7HT	503
MK7-NP-2MM	110-11330	500
MK7P	MK7P	497
MK7P-446	MK7P-446	500
MK7P-NP-3MM	110-11331	500
MK7P-NP-4MM	110-11332	500
MK7P-NP-STD	110-11329	500
MK9P	MK9P	498
MK9P	MK9PUA	498
MK9P5ST	110-95300	499
MK9RC	110-09980	503
MK9SST	MK9SST	504
MKPCOHOSE	MKPCOHOSE	500
MMB.5	MMB.50C2	156
MMB.5	MMB.50M4	156
MMB0	MMB00C2	156
MMB1	MMB10C2	156
MMB1	MMB10H4	156
MP1M3	MP1M3.NN3P	153
MP1M5	MP1M5.NN3P	153
MP2M3	MP2M3.NN3P	153
MP2M5	MP2M5.NN3P	153
MP3M3	MP3M3.NN3P	153
MP3M5	MP3M5.NN3P	153
MP4M3	MP4M3.NN3P	153
MP4M5	MP4M5.NN3P	153
MP5M3	MP5M3.NN3P	153
MP5M5	MP5M5.NN3P	153
MPVACDIS	596-00255	459
MPVACDIS10	596-00676	461
MPVACDISM5	596-00861	448
MPVSD	596-00243	459
MPVSD10	596-00675	461
MPVSDM5	596-00860	448
MSBT120	MSBT1200HIRHSH1	168
MSBT120	MSBT1200HIRHSX2	168
MSC2	151-00982	192
MSC2LP	151-01699	192
MSC90	151-02189	191
MSMP6/10	MSMP6-109C2	153
MSMP6/6	MSMP6-69C2	153
MSNP1-70	MSNP1-70	199
NC11	NC110	176
NC11	NC1110	176
NC3.5	NC3.50	176
NC3.5	NC3.510	176
NC5	NC50	176
NC5	NC510	176
NC6	NC60	176
NC6	NC610	176

Type	Part No.	Page
NC7	NC70	176
NC7	NC710	176
NC8	NC80	176
NC8	NC810	176
NC9	NC90	176
NC9	NC910	176
NPL27X13BK	596-00503	426
NPL27X13WH	596-00500	426
NPL51X25BK	596-00507	426
NPL51X25WH	596-00504	426
NPL60X60YE	596-00202	428
NPLH31X31BK22.5	596-00413	427
NPLH31X31WH22.5	596-00412	427
NPLH31X38BK22.5	596-00407	427
NPLH31X38WH22.5	596-00404	427
NPLH31X48BK22.5	596-00916	427
NPLH31X48WH22.5	596-00915	427
NPLH44X44BK30.5	596-00415	427
NPLH44X44WH30.5	596-00414	427
NPLH76X101WH	596-00417	426
NS1014APO	597-00101	475
NS1014NAES	597-00106	476
NS1014SGRITA	597-00100	475
NS710APO	597-00080	474
NS710NAES	597-00086	475
NS710SGRITA	597-00081	474
Overhead suspension 3080	ATS10200050	489
Overhead suspension CPK	106-00050	492
Paint Pen	596-06321	437
PAINTSHIELD1	596-00792	467
PAINTSHIELD2	596-00793	467
PAINTSHIELD3	596-00794	467
PAINTSHIELD4	596-00795	467
PAINTSHIELD5	596-00796	467
PAINTSHIELD6	596-00797	467
PAT100L	111-01699	32
PAT100LFT6LG	156-01513	102
PAT100LSB55-6U2SET	156-02232	115
PAT100R	111-01670	32
PAT100RFT6LG	156-01555	102
PBM	PBM0C2	155
PBM	PBM0M4	155
PBM	PBM10C2	155
PBM	PBM10M4	155
PBM	PBM9C2	155
PBM	PBM9M4	155
PC15FT7	PC15FT7	177
PCP2X1	596-73833	394
PCP3X1	596-73834	394
PCP4X3	596-73835	394
PHSNP2-36	PHSNP2-36	199
PHSNP38-100	PHSNP38-100	199
PLB3P	596-00383	406
PLW3P	596-00382	406
Power pack CPK	106-00100	491
Power pack CPK with control box	106-00110	491
PR1	PR1M4	283
PRH TT230SM	556-00232	480
Printer Roller TT4030/TT4000+	556-04005	484
Printhead TTM430	556-03065	482
PRT1	PRT1	283
PSEWRS	596-00474	459
PSEWRS10	596-00677	461

Appendix

Index by Type

Type	Part No.	Page
PSEWRS17	596-00887	459
PSEWRS1710	596-00890	461
PSEWRSS	596-00823	459
PSKWH	596-00737	450
PSKWH10	596-00743	463
PSNP2-22	PSNP2-22	199
PT220	111-01235	31
PT2A	118-00032	31
PT2AFT6LG	156-01336	102
PT2AP1SFT6.5	156-01090	89
PT2AP2SFT6.5	156-01091	89
PT2AP3SFT6.5	156-01146	89
PT2ASFT6.5PT0.7-1.5-E	126-00183	88
PVACDIS	596-00239	456
PVACDIS-1	596-00652	466
PVACDIS10	596-00852	465
PVACDIS17	596-00892	456
PVACDIS1710	596-00882	465
PVACDIS17M5	596-00919	444
PVACDIS17M5ENG	596-00923	445
PVACDISM5	596-00838	444
PVACDISM5ENG	596-00859	445
PVACDISS	596-00818	456
PVPSR	596-00206	459
PVPSR10	596-00678	461
PVPSR500	596-00896	459
PVPSRTM	596-00257	457
PVPSSNAP4	596-00207	458
PVPSSNAP72	596-00208	458
PW.25W1	596-96253	470
PW.25W1P	596-96255	471
PW.50W1	596-96260	470
PW.50W1P	596-96261	471
PW.50W2	596-96254	470
PW.50W2P	596-96256	471
PW2.75W1	596-96262	470
PW2.75W1P	596-96263	471
PW2.75W2	596-96257	470
PW2.75W2P	596-96258	471
Q120I	109-00024	49
Q120I	109-00053	49
Q120I	109-00111	51
Q120I	109-00140	51
Q120M	109-00028	49
Q120M	109-00057	49
Q120M	109-00115	51
Q120M	109-00144	51
Q120R	109-00026	49
Q120R	109-00055	49
Q120R	109-00113	51
Q120R	109-00142	51
Q18I	109-00004	48
Q18I	109-00033	48
Q18I	109-00091	50
Q18I	109-00120	50
Q18L	109-00007	48
Q18L	109-00036	48
Q18L	109-00094	50
Q18L	109-00123	50
Q18R	109-00001	48
Q18R	109-00030	48
Q18R	109-00088	50
Q18R	109-00117	50

Type	Part No.	Page
Q30L	109-00012	48
Q30L	109-00041	48
Q30L	109-00099	50
Q30L	109-00128	50
Q30LR	109-00014	48
Q30LR	109-00043	48
Q30LR	109-00101	50
Q30LR	109-00130	50
Q30R	109-00010	48
Q30R	109-00039	48
Q30R	109-00097	50
Q30R	109-00126	50
Q50I	109-00020	49
Q50I	109-00049	49
Q50I	109-00107	51
Q50I	109-00136	51
Q50L	109-00022	49
Q50L	109-00051	49
Q50L	109-00109	51
Q50L	109-00138	51
Q50R	109-00018	49
Q50R	109-00047	49
Q50R	109-00105	51
Q50R	109-00134	51
QM20	151-10901	152
QM20	151-10911	152
QM20A	151-10904	143
QM20A	151-10914	143
QM30	151-10902	152
QM30	151-10912	152
QM30A	151-10905	143
QM30A	151-10915	143
QM40	151-10903	152
QM40	151-10913	152
QM40A	151-10906	143
QM40A	151-10916	143
QS101	QS101	490
QT10065R	151-10953	434
QT7016R	151-10950	434
QT7040R	151-10951	434
QT7040S	151-10952	434
R1	201-20010	351
RB14	RB14L4	222
RB5	151-14059	222
RB8	151-13601	222
RB8	RB8L4	222
RCA155M10	151-01426	204
RCA155M10SS	151-01925	213
RCA155M12	151-01427	204
RCA155M12SS	151-01926	213
RCA155M6	151-01640	204
RCA155M6SS	151-01923	213
RCA155M8	151-01425	204
RCA155M8SS	151-01924	213
RCA180LM10	151-01423	205
RCA180LM10SS	151-01921	214
RCA180LM12	151-01424	205
RCA180LM12SS	151-01922	214
RCA180LM6	151-01639	205
RCA180LM6SS	151-01919	214
RCA180LM8	151-01422	205
RCA180LM8SS	151-01920	214
RCA180MM10	151-01420	205

Type	Part No.	Page
RCA180MM10SS	151-01917	214
RCA180MM12	151-01421	205
RCA180MM12SS	151-01918	214
RCA180MM6	151-01638	205
RCA180MM6SS	151-01915	214
RCA180MM8	151-01419	205
RCA180MM8SS	151-01916	214
RCA180SM10	151-01417	206
RCA180SM10SS	151-01913	214
RCA180SM12	151-01418	206
RCA180SM12SS	151-01914	214
RCA180SM6	151-01637	205
RCA180SM6	151-01670	205
RCA180SM6SS	151-01911	214
RCA180SM8	151-01416	205
RCA180SM8SS	151-01912	214
RCA30LM10	151-01432	204
RCA30LM10SS	151-01933	213
RCA30LM12	151-01433	204
RCA30LM12SS	151-01934	213
RCA30LM6	151-01642	204
RCA30LM6SS	151-01931	213
RCA30LM8	151-01431	204
RCA30LM8SS	151-01932	213
RCA30SM10	151-01429	204
RCA30SM10SS	151-01929	213
RCA30SM12	151-01430	205
RCA30SM12SS	151-01930	214
RCA30SM6	151-01641	204
RCA30SM6SS	151-01927	213
RCA30SM8	151-01428	204
RCA30SM8SS	151-01928	213
RCA90LM10	151-01438	205
RCA90LM10SS	151-01941	214
RCA90LM12	151-01439	205
RCA90LM12SS	151-01942	214
RCA90LM6	151-01644	205
RCA90LM6SS	151-01939	214
RCA90LM8	151-01437	205
RCA90LM8SS	151-01940	214
RCA90SM10	151-01435	205
RCA90SM10SS	151-01937	214
RCA90SM12	151-01436	205
RCA90SM12SS	151-01938	214
RCA90SM6	151-01643	205
RCA90SM6SS	151-01935	214
RCA90SM8	151-01434	205
RCA90SM8SS	151-01936	214
RCB15SM10	151-01449	207
RCB15SM10SS	151-01957	215
RCB15SM12	151-01450	207
RCB15SM12SS	151-01958	215
RCB15SM6	151-01648	207
RCB15SM6SS	151-01955	215
RCB15SM8	151-01448	207
RCB15SM8SS	151-01956	215
RCB180LM10	151-01446	208
RCB180LM10SS	151-01953	216
RCB180LM12	151-01447	208
RCB180LM12SS	151-01954	216
RCB180LM6	151-01647	208
RCB180LM6SS	151-01951	216
RCB180LM8	151-01445	208

Type	Part No.	Page
RCB180LM85S	151-01952	216
RCB180MM10	151-01443	208
RCB180MM105S	151-01949	216
RCB180MM12	151-01444	208
RCB180MM125S	151-01950	216
RCB180MM6	151-01646	208
RCB180MM65S	151-01947	216
RCB180MM8	151-01442	208
RCB180MM85S	151-01948	216
RCB180SM10	151-01390	208
RCB180SM105S	151-01945	216
RCB180SM12	151-01441	208
RCB180SM125S	151-01946	216
RCB180SM6	151-01645	208
RCB180SM6	151-01671	208
RCB180SM65S	151-01943	216
RCB180SM8	151-01440	208
RCB180SM85S	151-01944	216
RCB30LM10	151-01455	207
RCB30LM105S	151-01965	215
RCB30LM12	151-01456	207
RCB30LM125S	151-01966	215
RCB30LM6	151-01650	207
RCB30LM65S	151-01963	215
RCB30LM8	151-01454	207
RCB30LM85S	151-01964	215
RCB30SM10	151-01452	208
RCB30SM105S	151-01961	215
RCB30SM12	151-01453	208
RCB30SM125S	151-01962	216
RCB30SM6	151-01649	207
RCB30SM65S	151-01959	215
RCB30SM8	151-01451	207
RCB30SM85S	151-01960	215
RCB90LM10	151-01461	208
RCB90LM105S	151-01973	216
RCB90LM12	151-01462	208
RCB90LM125S	151-01974	216
RCB90LM6	151-01652	208
RCB90LM65S	151-01971	216
RCB90LM8	151-01460	208
RCB90LM85S	151-01972	216
RCB90SM10	151-01458	208
RCB90SM105S	151-01969	216
RCB90SM12	151-01459	208
RCB90SM125S	151-01970	216
RCB90SM6	151-01651	208
RCB90SM65S	151-01967	216
RCB90SM8	151-01457	208
RCB90SM85S	151-01968	216
RCC155M10	151-01484	209
RCC155M105S	151-01989	217
RCC155M12	151-01485	209
RCC155M125S	151-01990	217
RCC155M6	151-01656	209
RCC155M65S	151-01987	217
RCC155M8	151-01483	209
RCC155M85S	151-01988	217
RCC180LM10	151-01481	210
RCC180LM105S	151-01985	218
RCC180LM12	151-01482	210
RCC180LM125S	151-01986	218
RCC180LM6	151-01655	210

Type	Part No.	Page
RCC180LM65S	151-01983	218
RCC180LM8	151-01480	210
RCC180LM85S	151-01984	218
RCC180MM10	151-01478	210
RCC180MM105S	151-01981	218
RCC180MM12	151-01479	210
RCC180MM125S	151-01982	218
RCC180MM6	151-01654	210
RCC180MM65S	151-01979	218
RCC180MM8	151-01477	210
RCC180MM85S	151-01980	218
RCC180SM10	151-01475	210
RCC180SM105S	151-01977	218
RCC180SM12	151-01476	210
RCC180SM125S	151-01978	218
RCC180SM6	151-01653	210
RCC180SM6	151-01672	210
RCC180SM65S	151-01975	218
RCC180SM8	151-01474	210
RCC180SM85S	151-01976	218
RCC30LM10	151-01490	209
RCC30LM105S	151-01997	217
RCC30LM12	151-01491	209
RCC30LM125S	151-01998	217
RCC30LM6	151-01658	209
RCC30LM65S	151-01995	217
RCC30LM8	151-01489	209
RCC30LM85S	151-01996	217
RCC30SM10	151-01487	209
RCC30SM105S	151-01993	218
RCC30SM12	151-01488	210
RCC30SM125S	151-01994	218
RCC30SM6	151-01657	209
RCC30SM65S	151-01991	217
RCC30SM8	151-01486	209
RCC30SM85S	151-01992	217
RCC90LM10	151-01496	210
RCC90LM105S	151-02006	218
RCC90LM12	151-01497	210
RCC90LM125S	151-02007	218
RCC90LM6	151-01660	210
RCC90LM65S	151-02004	218
RCC90LM8	151-01495	210
RCC90LM85S	151-02005	218
RCC90SM10	151-01493	210
RCC90SM105S	151-02002	218
RCC90SM12	151-01494	210
RCC90SM125S	151-02003	218
RCC90SM6	151-01659	210
RCC90SM65S	151-01999	218
RCC90SM8	151-01492	210
RCC90SM85S	151-02001	218
RCD155M10	151-01510	211
RCD155M105S	151-02022	219
RCD155M12	151-01511	211
RCD155M125S	151-02023	219
RCD155M6	151-01664	211
RCD155M65S	151-02020	219
RCD155M8	151-01509	211
RCD155M85S	151-02021	219
RCD180LM10	151-01507	212
RCD180LM105S	151-02018	220
RCD180LM12	151-01508	212

Type	Part No.	Page
RCD180LM125S	151-02019	220
RCD180LM6	151-01663	212
RCD180LM65S	151-02016	220
RCD180LM8	151-01506	212
RCD180LM85S	151-02017	220
RCD180MM10	151-01504	212
RCD180MM105S	151-02014	220
RCD180MM12	151-01505	212
RCD180MM125S	151-02015	220
RCD180MM6	151-01662	212
RCD180MM65S	151-02012	220
RCD180MM8	151-01503	212
RCD180MM85S	151-02013	220
RCD180SM10	151-01501	212
RCD180SM105S	151-02010	220
RCD180SM12	151-01502	212
RCD180SM125S	151-02011	220
RCD180SM6	151-01661	212
RCD180SM6	151-01673	212
RCD180SM65S	151-02008	220
RCD180SM8	151-01499	212
RCD180SM85S	151-02009	220
RCD30LM10	151-01516	211
RCD30LM105S	151-02030	219
RCD30LM12	151-01517	211
RCD30LM125S	151-02031	219
RCD30LM6	151-01666	211
RCD30LM65S	151-02028	219
RCD30LM8	151-01515	211
RCD30LM85S	151-02029	219
RCD30SM10	151-01513	211
RCD30SM105S	151-02026	220
RCD30SM12	151-01514	212
RCD30SM125S	151-02027	220
RCD30SM6	151-01665	211
RCD30SM65S	151-02024	219
RCD30SM8	151-01512	211
RCD30SM85S	151-02025	219
RCD90LM10	151-01522	212
RCD90LM105S	151-02038	220
RCD90LM12	151-01523	212
RCD90LM125S	151-02039	220
RCD90LM6	151-01628	212
RCD90LM65S	151-02036	220
RCD90LM8	151-01521	212
RCD90LM85S	151-02037	220
RCD90SM10	151-01519	212
RCD90SM105S	151-02034	220
RCD90SM12	151-01520	212
RCD90SM125S	151-02035	220
RCD90SM6	151-01667	212
RCD90SM65S	151-02032	220
RCD90SM8	151-01518	212
RCD90SM85S	151-02033	220
RCINSERTA	151-01530	221
RCINSERTB	151-01531	221
RCINSERTC	151-01532	221
RCINSERTD	151-01533	221
RCTT	151-01529	221
REL30SDP6	150-55500	110
Replacement Blade	110-80037	502
REZ200	REZ200.NB3P	53
REZ300	REZ300.NB3P	53

Appendix

Index by Type

Type	Part No.	Page
RF140	115-00046	59
RF140	115-00047	59
RF250	115-00049	59
RF250	115-00054	59
RO175	RO175	435
RO175WP	RO175WP	435
RO512	RO512	435
RO512REF	512REF	436
RO514	RO514	435
RPR TT230SM	556-00234	480
RPS TT230SM	556-00233	480
RSDRD17	596-00886	460
RSDRD1710	596-00889	461
RSDYL17	596-00885	460
RSDYL1710	596-00888	461
RT150LEP	RT150LEPOX2	54
RT150MEP	RT150MEPOX2	54
RT150REP	RT150REPOX2	54
RT250I	RT250I0UVX2	55
RT250I	RT250I0X2	55
RT250I	RT250I9X2	55
RT250L	RT250L0UVX2	55
RT250L	RT250L0X2	55
RT250L	RT250L9X2	55
RT250M	RT250M0UVX2	55
RT250M	RT250M0X2	55
RT250M	RT250M9X2	55
RT250R	RT250R0UVX2	55
RT250R	RT250R0X2	55
RT250R	RT250R9X2	55
RT250S	RT250S0UVX2	55
RT250S	RT250S0X2	55
RT250S	RT250S9X2	55
RT250XL	RT250XL0UVX2	55
RT250XL	RT250XL0X2	55
RT250XL	RT250XL9X2	55
RT255R	RT255R0HIRX2	57
RT255S	RT255S0HIRX2	57
RT40R	RT40R0C2	52
RT40R	RT40R0M4	52
RT40R	RT40R9C2	52
RT40R	RT40R9M4	52
RT50LL	RT50LL0M4	52
RT50LL	RT50LL0UVC2	52
RT50LL	RT50LL9C2	52
RT50LL	RT50LL9M4	52
RT50S	RT50S0C2	52
RT50S	RT50S9C2	52
RT50S	RT50S9M4	52
RT50SFK	115-06960	99
S2CM25	S2CM258HIRHSH1	167
S2CM25	S2CM258HIRHSHK2	167
S2HM25	S2HM250HIRHSH1	167
S2HM25	S2HM250HIRHSHK2	167
S3STM50	S3STM500HIRHSHK2	171
S3STM50	S3STM500HIRHSHF1	171
S4030 Cutter	556-04050	484
SAM320B	151-02099	164
SAM400B	151-02102	164
SAM500B	151-02103	164
SAM83	SAM83HIRHSH1	162
SAOM8	SAOM80HIRHSH1	162
SAOM82	SAOM820HIRHSH1	162

Type	Part No.	Page
SC6.6	151-00927	173
SCG	181-00003	284
SCW	181-00004	284
SD.5X.5	181-00452	260
SD.5X.5	181-00453	260
SD.5X.5	181-05500	260
SD.5X.5	181-05501	260
SD.5X.5	181-05503	260
SD.5X.5	181-05505	260
SD.5X1	181-05100	260
SD.5X1	181-05102	260
SD.5X1	181-05510	260
SD.75X.75	181-00456	261
SD.75X.75	181-05514	261
SD.75X.75	181-05515	261
SD.75X.75	181-75750	261
SD1.5X1.5	181-00176	262
SD1.5X1.5	181-00193	262
SD1.5X1.5	181-05540	268
SD1.5X1.5	181-15500	262
SD1.5X1.5	181-15502	262
SD1.5X1.5	181-15503	262
SD1.5X1.5	181-15517	262
SD1.5X1	181-00325	262
SD1.5X1	181-05583	268
SD1.5X1	181-05584	262
SD1.5X1	181-05585	262
SD1.5X1	181-15100	262
SD1.5X1	181-15101	262
SD1.5X2	181-00195	263
SD1.5X2	181-00462	263
SD1.5X2	181-05546	268
SD1.5X2	181-05547	263
SD1.5X2	181-15200	263
SD1.5X2	181-15201	263
SD1.5X2	181-15202	263
SD1.5X3	181-00463	263
SD1.5X3	181-00464	263
SD1.5X3	181-15300	263
SD1.5X3	181-23063	268
SD1.5X3	181-23064	263
SD1.5X3	181-23065	263
SD1.5X4	181-00465	263
SD1.5X4	181-00467	263
SD1.5X4	181-00574	263
SD1.5X4	181-23071	269
SD1.5X4	181-23072	263
SD1.5X4	181-23073	263
SD1.5X4	181-23074	263
SD1X1.5	181-00457	261
SD1X1.5	181-05527	268
SD1X1.5	181-11501	261
SD1X1.5	181-11502	261
SD1X1	181-00170	261
SD1X1	181-05518	268
SD1X1	181-05519	261
SD1X1	181-11000	261
SD1X1	181-11002	261
SD1X1	181-11004	261
SD1X1	181-11005	261
SD1X2	181-00172	261
SD1X2	181-00187	261

Type	Part No.	Page
SD1X2	181-00458	261
SD1X2	181-05571	261
SD1X2	181-05572	268
SD1X2	181-12001	261
SD1X2	181-12002	261
SD1X3	181-00136	262
SD1X3	181-00174	262
SD1X3	181-00189	262
SD1X3	181-00459	262
SD1X3	181-05567	268
SD1X3	181-05568	262
SD1X3	181-13001	262
SD1X4	181-00460	262
SD1X4	181-00461	262
SD1X4	181-05573	268
SD1X4	181-14000	262
SD2.5X3	181-00220	265
SD2.5X3	181-00221	265
SD2.5X3	181-00224	265
SD2.5X3	181-00225	265
SD2.5X3	181-00314	265
SD2.5X3	181-23038	269
SD2.5X3	181-23039	265
SD2X1	181-00204	264
SD2X1	181-21000	264
SD2X1	181-21001	264
SD2X1	181-21002	264
SD2X1	181-21003	264
SD2X1	181-23081	269
SD2X1	181-23082	264
SD2X2	181-22005	264
SD2X2	181-22006	264
SD2X2	181-22008	264
SD2X2	181-22011	264
SD2X2	181-22013	264
SD2X2	181-23020	269
SD2X2	181-23021	264
SD2X3	181-00198	264
SD2X3	181-00205	264
SD2X3	181-00468	264
SD2X3	181-23000	264
SD2X3	181-23001	264
SD2X3	181-23002	264
SD2X3	181-23022	269
SD2X4	181-00469	264
SD2X4	181-23025	269
SD2X4	181-24000	264
SD2X4	181-24001	264
SD2X4	181-24002	264
SD2X5	181-00244	265
SD2X5	181-00245	265
SD2X5	181-00248	265
SD2X5	181-00249	265
SD2X5	181-00312	265
SD2X5	181-23032	269
SD2X5	181-23033	265
SD3X1	181-00470	265
SD3X1	181-05555	269
SD3X1	181-31001	265
SD3X1	181-31002	265
SD3X2	181-00164	265
SD3X2	181-00200	265
SD3X2	181-00471	265

Type	Part No.	Page
SD3X2	181-23040	269
SD3X2	181-32002	265
SD3X2	181-32003	265
SD3X3	181-23094	269
SD3X3	181-33000	266
SD3X3	181-33002	266
SD3X3	181-33004	266
SD3X3	181-33005	266
SD3X3	181-33006	266
SD3X4	181-00472	266
SD3X4	181-23045	269
SD3X4	181-23046	266
SD3X4	181-23048	266
SD3X4	181-34000	266
SD3X4	181-34001	266
SD3X5	181-00473	266
SD3X5	181-00474	266
SD3X5	181-00475	266
SD3X5	181-01400	266
SD3X5	181-23056	269
SD3X5	181-23057	266
SD3X5	181-23058	266
SD4X2	181-00185	266
SD4X2	181-00203	266
SD4X2	181-00476	266
SD4X2	181-05593	269
SD4X2	181-05594	266
SD4X2	181-42002	266
SD4X2	181-42004	266
SD4X3	181-00477	267
SD4X3	181-23097	269
SD4X3	181-43001	267
SD4X3	181-43002	267
SD4X4	181-00478	267
SD4X4	181-05599	269
SD4X4	181-44006	267
SD4X4	181-44007	267
SD4X4	181-44009	267
SD4X4	181-44013	267
SD4X4	181-44015	267
SD4X5	181-00137	267
SD4X5	181-05603	269
SD4X5	181-45000	267
SD4X5	181-45001	267
SD6X4	181-00479	267
SD6X4	181-64000	267
SD8X4	181-00480	267
SD8X4	181-84004	267
SD8X4	181-84007	267
SDA.75X.75	181-00142	270
SDA.75X.75	181-75752	270
SDA1.5X1.5	181-00482	271
SDA1.5X1.5	181-00483	271
SDA1.5X1.5	181-15504	271
SDA1.5X1	181-00175	271
SDA1.5X1	181-00485	271
SDA1.5X1	181-00486	271
SDA1.5X2	181-00487	271
SDA1.5X2	181-00488	271
SDA1.5X2	181-00534	271
SDA1.5X3	181-00489	272
SDA1.5X3	181-00535	272
SDA1.5X3	181-00536	272

Type	Part No.	Page
SDA1.5X4	181-00537	272
SDA1.5X4	181-00538	272
SDA1.5X4	181-00539	272
SDA1X1.5	181-00490	271
SDA1X1.5	181-00491	271
SDA1X1.5	181-00529	271
SDA1X1	181-00492	270
SDA1X1	181-00493	270
SDA1X1	181-11006	270
SDA1X1	181-11008	270
SDA1X2	181-00494	271
SDA1X2	181-00495	271
SDA1X2	181-00530	271
SDA1X3	181-00496	271
SDA1X3	181-00531	271
SDA1X3	181-00671	271
SDA1X4	181-00497	271
SDA1X4	181-00532	271
SDA1X4	181-00533	271
SDA2.5X3	181-00222	273
SDA2.5X3	181-00223	273
SDA2.5X3	181-00226	273
SDA2.5X3	181-00227	273
SDA2.5X3	181-00315	273
SDA2X1	181-00498	272
SDA2X1	181-00499	272
SDA2X1	181-00500	272
SDA2X2	181-00501	272
SDA2X2	181-22016	272
SDA2X2	181-22017	272
SDA2X2	181-22018	272
SDA2X3	181-00503	272
SDA2X3	181-00504	272
SDA2X3	181-00540	272
SDA2X4	181-00505	272
SDA2X4	181-00506	272
SDA2X4	181-00541	272
SDA2X5	181-00246	273
SDA2X5	181-00250	273
SDA2X5	181-00313	273
SDA3X1	181-00507	273
SDA3X1	181-00508	273
SDA3X1	181-00672	273
SDA3X2	181-00509	273
SDA3X2	181-00510	273
SDA3X2	181-00542	273
SDA3X3	181-00511	273
SDA3X3	181-00512	273
SDA3X3	181-00513	273
SDA3X4	181-00147	273
SDA3X4	181-00514	273
SDA3X4	181-00515	273
SDA3X5	181-00148	274
SDA3X5	181-00543	274
SDA3X5	181-00544	274
SDA4X2	181-00516	274
SDA4X2	181-00517	274
SDA4X2	181-00545	274
SDA4X3	181-00518	274
SDA4X3	181-00519	274
SDA4X3	181-00546	274
SDA4X4	181-00520	274
SDA4X4	181-00521	274

Type	Part No.	Page
SDA4X4	181-44018	274
SDA4X5	181-00522	274
SDA4X5	181-00523	274
SDA4X5	181-00547	274
SDCTL	157-00060	134
SDCTR312	117-00012	134
SDWR2X20	SDWR2X20K2	280
SDWR4X40	SDWR4X40P2	280
ShrinKit 321 Basic	380-03001	367
ShrinKit 321 Universal Basic	380-03005	368
SL1.5X1.5	181-15505	232
SL1.5X1.5	181-15506	238
SL1.5X1.5	181-15507	232
SL1.5X1.5	181-15509	232
SL1.5X1.5	181-15510	232
SL1.5X1.5	181-15511	232
SL1.5X1	181-00160	238
SL1.5X1	181-00548	232
SL1.5X1	181-05588	232
SL1.5X1	181-15103	238
SL1.5X1	181-15104	232
SL1.5X1	181-15105	232
SL1.5X1	181-15106	232
SL1.5X1	181-15107	232
SL1.5X2	181-05550	238
SL1.5X2	181-05551	233
SL1.5X2	181-15203	233
SL1.5X2	181-15206	233
SL1.5X2	181-15207	233
SL1.5X2	181-15208	233
SL1.5X2	181-15209	233
SL1.5X3	181-00211	239
SL1.5X3	181-00550	233
SL1.5X3	181-15302	233
SL1.5X3	181-15304	233
SL1.5X3	181-15305	233
SL1.5X3	181-15306	233
SL1.5X4	181-15400	233
SL1.5X4	181-15403	233
SL1.5X4	181-15404	233
SL1.5X4	181-15405	233
SL1.5X4	181-15406	233
SL1.5X4	181-23078	239
SL1.5X4	181-23079	233
SL1X1.5	181-00552	231
SL1X1.5	181-05529	231
SL1X1.5	181-11503	231
SL1X1.5	181-11505	231
SL1X1.5	181-11506	231
SL1X1.5	181-11507	231
SL1x1	181-11009	230
SL1x1	181-11011	230
SL1x1	181-11013	230
SL1x1	181-11014	230
SL1x1	181-11015	230
SL1X2	181-00024	231
SL1X2	181-05565	231
SL1X2	181-12003	238
SL1X2	181-12004	231
SL1X2	181-12005	231
SL1X2	181-12007	231
SL1X2	181-12008	231
SL1X3	181-00310	231

Appendix

Index by Type

Type	Part No.	Page
SL1X3	181-13003	231
SL1X3	181-13004	238
SL1X3	181-13005	231
SL1X3	181-13006	231
SL1X3	181-13007	231
SL1X3	181-13008	231
SL1X4	181-05580	238
SL1X4	181-05581	232
SL1X4	181-14001	232
SL1X4	181-14002	232
SL1X4	181-14003	232
SL1X4	181-14005	232
SL1X4	181-14006	232
SL2.5X3	181-00212	235
SL2.5X3	181-00213	235
SL2.5X3	181-00216	235
SL2.5X3	181-00217	235
SL2.5X3	181-00318	235
SL2.5X3	181-23091	239
SL2.5X3	181-23092	235
SL2X1	181-00554	234
SL2X1	181-21004	234
SL2X1	181-21005	234
SL2X1	181-21006	234
SL2X1	181-21007	234
SL2X1	181-23085	239
SL2X2	181-22019	234
SL2X2	181-22020	234
SL2X2	181-22021	239
SL2X2	181-22022	234
SL2X2	181-22024	234
SL2X2	181-22027	234
SL2X2	181-22028	234
SL2X3	181-23003	234
SL2X3	181-23004	239
SL2X3	181-23005	234
SL2X3	181-23007	234
SL2X3	181-23008	234
SL2X3	181-23009	234
SL2X3	181-23013	234
SL2X4	181-24003	234
SL2X4	181-24005	234
SL2X4	181-24006	239
SL2X4	181-24007	234
SL2X4	181-24008	234
SL2X4	181-24010	234
SL2X4	181-24011	234
SL2X5	181-00236	235
SL2X5	181-00237	235
SL2X5	181-00240	235
SL2X5	181-00241	235
SL2X5	181-00316	235
SL2X5	181-23035	239
SL2X5	181-23036	235
SL3X1	181-00557	235
SL3X1	181-00558	235
SL3X1	181-05561	235
SL3X1	181-31003	239
SL3X1	181-31004	235
SL3X1	181-31006	235
SL3X1	181-31007	235
SL3X2	181-23044	239
SL3X2	181-32004	236

Type	Part No.	Page
SL3X2	181-32005	236
SL3X2	181-32006	236
SL3X2	181-32008	236
SL3X2	181-32009	236
SL3X2	181-32016	236
SL3X3	181-33008	236
SL3X3	181-33009	236
SL3X3	181-33012	239
SL3X3	181-33014	236
SL3X3	181-33016	236
SL3X3	181-33017	236
SL3X3	181-33018	236
SL3X4	181-23052	239
SL3X4	181-34002	236
SL3X4	181-34003	236
SL3X4	181-34004	236
SL3X4	181-34006	236
SL3X4	181-34007	236
SL3X4	181-34021	236
SL3X5	181-00560	236
SL3X5	181-23062	239
SL3X5	181-35001	236
SL3X5	181-35002	236
SL3X5	181-35005	236
SL3X5	181-35006	236
SL4X2	181-05596	239
SL4X2	181-42005	237
SL4X2	181-42006	237
SL4X2	181-42008	237
SL4X2	181-42009	237
SL4X2	181-42010	237
SL4X2	181-42020	237
SL4X3	181-00210	239
SL4X3	181-00562	237
SL4X3	181-23104	237
SL4X3	181-43003	237
SL4X3	181-43004	237
SL4X3	181-43005	237
SL4X3	181-43006	237
SL4X4	181-00563	239
SL4X4	181-44019	237
SL4X4	181-44020	237
SL4X4	181-44024	239
SL4X4	181-44025	237
SL4X4	181-44027	237
SL4X4	181-44030	237
SL4X4	181-44031	237
SL4X5	181-05604	239
SL4X5	181-45002	237
SL4X5	181-45010	237
SL4X5	181-45011	237
SLA1.5X1.5	181-00027	242
SLA1.5X1.5	181-15512	242
SLA1.5X1.5	181-15513	242
SLA1.5X1.5	181-15514	242
SLA1.5X1.5	181-15515	242
SLA1.5X1	181-00570	241
SLA1.5X1	181-00571	241
SLA1.5X1	181-00572	241
SLA1.5X1	181-15108	241
SLA1.5X1	181-15109	241
SLA1.5X2	181-00573	242
SLA1.5X2	181-15210	242

Type	Part No.	Page
SLA1.5X2	181-15211	242
SLA1.5X2	181-15212	242
SLA1.5X2	181-15213	242
SLA1.5X3	181-00575	242
SLA1.5X3	181-15307	242
SLA1.5X3	181-15308	242
SLA1.5X4	181-00576	242
SLA1.5X4	181-00577	242
SLA1.5X4	181-00578	242
SLA1X1.5	181-00564	240
SLA1X1.5	181-11509	240
SLA1X1.5	181-11510	240
SLA1X1.5	181-11511	240
SLA1X1	181-11016	240
SLA1X1	181-11017	240
SLA1X1	181-11019	240
SLA1X1	181-11021	240
SLA1X2	181-00565	241
SLA1X2	181-12010	241
SLA1X2	181-12011	241
SLA1X2	181-12012	241
SLA1X2	181-12013	241
SLA1X3	181-00566	241
SLA1X3	181-13009	241
SLA1X3	181-13010	241
SLA1X3	181-13011	241
SLA1X3	181-13012	241
SLA1X4	181-00567	241
SLA1X4	181-00568	241
SLA1X4	181-00569	241
SLA2.5X3	181-00214	244
SLA2.5X3	181-00215	244
SLA2.5X3	181-00218	244
SLA2.5X3	181-00219	244
SLA2.5X3	181-00319	244
SLA2X1	181-00579	242
SLA2X1	181-00580	242
SLA2X1	181-21008	242
SLA2X1	181-21009	242
SLA2X1	181-21010	242
SLA2X2	181-00681	243
SLA2X2	181-22031	243
SLA2X2	181-22032	243
SLA2X2	181-22033	243
SLA2X2	181-22034	243
SLA2X3	181-00581	243
SLA2X3	181-00582	243
SLA2X3	181-23010	243
SLA2X3	181-23011	243
SLA2X3	181-23012	243
SLA2X4	181-00583	243
SLA2X4	181-24013	243
SLA2X4	181-24014	243
SLA2X5	181-00238	243
SLA2X5	181-00239	243
SLA2X5	181-00242	243
SLA2X5	181-00243	243
SLA2X5	181-00317	243
SLA3X1	181-00584	244
SLA3X1	181-00585	244
SLA3X1	181-00586	244
SLA3X2	181-00026	244
SLA3X2	181-32010	244

Type	Part No.	Page
SLA3X2	181-32012	244
SLA3X2	181-32014	244
SLA3X2	181-32015	244
SLA3X3	181-00159	244
SLA3X3	181-33019	244
SLA3X3	181-33020	244
SLA3X3	181-33021	244
SLA3X3	181-33022	244
SLA3X3	181-33023	244
SLA3X4	181-00588	245
SLA3X4	181-00589	245
SLA3X4	181-00590	245
SLA3X4	181-34009	245
SLA3X5	181-00155	245
SLA3X5	181-00156	245
SLA3X5	181-00157	245
SLA4X2	181-00591	245
SLA4X2	181-00592	245
SLA4X2	181-42012	245
SLA4X2	181-42014	245
SLA4X3	181-00593	245
SLA4X3	181-00594	245
SLA4X3	181-43008	245
SLA4X4	181-00595	245
SLA4X4	181-00680	245
SLA4X4	181-44033	245
SLA4X4	181-44035	245
SLA4X5	181-00596	245
SLA4X5	181-45012	245
SLA4X5	181-45013	245
SLHD1.5X1.5	181-00603	248
SLHD1.5X1.5	184-05543	253
SLHD1.5X1.5	184-05544	248
SLHD1.5X1.5	184-15150	248
SLHD1.5X1.5	184-15152	248
SLHD1.5X1.5	184-15154	248
SLHD1.5X1.5	184-15155	248
SLHD1.5X1	181-00275	247
SLHD1.5X1	181-00276	247
SLHD1.5X1	181-00602	247
SLHD1.5X1	181-05539	247
SLHD1.5X1	184-05537	253
SLHD1.5X1	184-15101	247
SLHD1.5X1	184-15102	247
SLHD1.5X2	181-00604	248
SLHD1.5X2	184-05553	253
SLHD1.5X2	184-15200	248
SLHD1.5X2	184-15202	248
SLHD1.5X2	184-15204	248
SLHD1.5X2	184-15206	248
SLHD1.5X2	184-15214	248
SLHD1.5X3	181-00605	248
SLHD1.5X3	184-15300	248
SLHD1.5X3	184-15302	248
SLHD1.5X3	184-15303	248
SLHD1.5X3	184-15304	248
SLHD1.5X3	184-22034	254
SLHD1.5X3	184-22035	248
SLHD1.5X4	181-00606	248
SLHD1.5X4	184-15400	248
SLHD1.5X4	184-15401	248
SLHD1.5X4	184-15402	248
SLHD1.5X4	184-15403	248

Type	Part No.	Page
SLHD1.5X4	184-22037	254
SLHD1.5X4	184-22038	248
SLHD1X1.5	181-00598	246
SLHD1X1.5	181-05532	253
SLHD1X1.5	184-05534	246
SLHD1X1.5	184-11007	246
SLHD1X1.5	184-11010	246
SLHD1X1.5	184-11011	246
SLHD1X1.5	184-11012	246
SLHD1X1	181-00597	246
SLHD1X1	184-05524	253
SLHD1X1	184-05525	246
SLHD1X1	184-11000	246
SLHD1X1	184-11004	246
SLHD1X1	184-11005	246
SLHD1X1	184-11006	246
SLHD1X2	181-00599	247
SLHD1X2	184-05567	247
SLHD1X2	184-05570	253
SLHD1X2	184-12000	247
SLHD1X2	184-12005	247
SLHD1X2	184-12006	247
SLHD1X2	184-12007	247
SLHD1X3	181-00600	247
SLHD1X3	184-05568	253
SLHD1X3	184-12019	247
SLHD1X3	184-13000	247
SLHD1X3	184-13005	247
SLHD1X3	184-13006	247
SLHD1X3	184-13007	247
SLHD1X4	181-00601	247
SLHD1X4	184-05571	253
SLHD1X4	184-05572	247
SLHD1X4	184-14000	247
SLHD1X4	184-14002	247
SLHD1X4	184-14003	247
SLHD1X4	184-14004	247
SLHD2.5X3	181-00228	250
SLHD2.5X3	181-00229	250
SLHD2.5X3	181-00232	250
SLHD2.5X3	181-00233	250
SLHD2.5X3	181-00322	250
SLHD2.5X3	184-22050	254
SLHD2.5X3	184-22051	250
SLHD2X1	181-00284	249
SLHD2X1	181-00607	249
SLHD2X1	184-21000	249
SLHD2X1	184-21002	249
SLHD2X1	184-21003	249
SLHD2X1	184-21006	249
SLHD2X1	184-22040	254
SLHD2X2	181-00608	249
SLHD2X2	184-22000	249
SLHD2X2	184-22005	249
SLHD2X2	184-22006	249
SLHD2X2	184-22007	249
SLHD2X2	184-22008	249
SLHD2X2	184-22022	254
SLHD2X3	181-00609	249
SLHD2X3	184-22024	254
SLHD2X3	184-22025	249
SLHD2X3	184-23000	249
SLHD2X3	184-23004	249

Type	Part No.	Page
SLHD2X3	184-23005	249
SLHD2X3	184-23006	249
SLHD2X4	181-00610	249
SLHD2X4	184-22026	254
SLHD2X4	184-24000	249
SLHD2X4	184-24004	249
SLHD2X4	184-24006	249
SLHD2X4	184-24007	249
SLHD2X5	181-00252	250
SLHD2X5	181-00253	250
SLHD2X5	181-00257	250
SLHD2X5	181-00265	250
SLHD2X5	181-00320	250
SLHD2X5	184-22028	254
SLHD2X5	184-22029	250
SLHD3X1	181-00611	250
SLHD3X1	181-00612	250
SLHD3X1	181-00613	250
SLHD3X1	184-05565	254
SLHD3X1	184-05566	250
SLHD3X1	184-22060	250
SLHD3X1	184-22061	250
SLHD3X2	181-00614	250
SLHD3X2	184-22044	254
SLHD3X2	184-32000	250
SLHD3X2	184-32001	250
SLHD3X2	184-32002	250
SLHD3X2	184-32003	250
SLHD3X2	184-32004	250
SLHD3X2	181-00615	251
SLHD3X3	184-22053	254
SLHD3X3	184-33000	251
SLHD3X3	184-33002	251
SLHD3X3	184-33003	251
SLHD3X3	184-33004	251
SLHD3X3	184-33014	251
SLHD3X4	181-00616	251
SLHD3X4	181-00686	254
SLHD3X4	184-22032	251
SLHD3X4	184-34000	251
SLHD3X4	184-34003	251
SLHD3X4	184-34004	251
SLHD3X4	184-34005	251
SLHD3X5	181-00149	251
SLHD3X5	181-00150	251
SLHD3X5	181-00151	251
SLHD3X5	184-05557	254
SLHD3X5	184-05558	251
SLHD3X5	184-05559	251
SLHD3X5	184-05560	251
SLHD4X2	181-00617	252
SLHD4X2	184-05564	254
SLHD4X2	184-42000	252
SLHD4X2	184-42001	252
SLHD4X2	184-42002	252
SLHD4X2	184-42003	252
SLHD4X2	184-42004	252
SLHD4X3	181-00618	252
SLHD4X3	184-22055	254
SLHD4X3	184-22056	252
SLHD4X3	184-43000	252
SLHD4X3	184-43001	252
SLHD4X3	184-43002	252

Appendix

Index by Type

Type	Part No.	Page
SLHD4X3	184-43003	252
SLHD4X4	181-00619	252
SLHD4X4	184-05576	252
SLHD4X4	184-05603	254
SLHD4X4	184-44000	252
SLHD4X4	184-44002	252
SLHD4X4	184-44003	252
SLHD4X4	184-44004	252
SLHD4X5	181-00690	252
SLHD4X5	181-00691	252
SLHD4X5	181-00692	252
SLHDA1.5X1.5	181-00633	257
SLHDA1.5X1.5	184-15151	257
SLHDA1.5X1.5	184-15153	257
SLHDA1.5X1	181-00630	256
SLHDA1.5X1	181-00631	256
SLHDA1.5X1	181-00632	256
SLHDA1.5X2	181-00634	257
SLHDA1.5X2	184-15201	257
SLHDA1.5X2	184-15205	257
SLHDA1.5X3	181-00635	257
SLHDA1.5X3	181-00636	257
SLHDA1.5X3	184-15301	257
SLHDA1.5X4	181-00620	257
SLHDA1.5X4	181-00638	257
SLHDA1.5X4	181-00639	257
SLHDA1X1.5	181-00623	256
SLHDA1X1.5	184-11008	256
SLHDA1X1.5	184-11009	256
SLHDA1X1	181-00621	255
SLHDA1X1	181-00622	255
SLHDA1X1	181-00637	255
SLHDA1X1	184-11001	255
SLHDA1X1	184-11002	255
SLHDA1X2	181-00624	256
SLHDA1X2	184-12001	256
SLHDA1X2	184-12002	256
SLHDA1X2	184-12003	256
SLHDA1X2	184-12004	256
SLHDA1X3	181-00625	256
SLHDA1X3	181-00626	256
SLHDA1X3	184-13001	256
SLHDA1X3	184-13002	256
SLHDA1X3	184-13003	256
SLHDA1X4	181-00627	256
SLHDA1X4	181-00628	256
SLHDA1X4	181-00629	256
SLHDA2.5X3	181-00230	258
SLHDA2.5X3	181-00231	258
SLHDA2.5X3	181-00234	258
SLHDA2.5X3	181-00235	258
SLHDA2.5X3	181-00323	258
SLHDA2X1	181-00640	257
SLHDA2X1	181-00641	257
SLHDA2X1	181-00642	257
SLHDA2X1	181-00676	257
SLHDA2X1	184-21001	257
SLHDA2X2	181-00643	257
SLHDA2X2	181-00644	257
SLHDA2X2	184-22001	257
SLHDA2X2	184-22002	257
SLHDA2X2	184-22003	257
SLHDA2X3	181-00645	258

Type	Part No.	Page
SLHDA2X3	181-00646	258
SLHDA2X3	184-23001	258
SLHDA2X3	184-23002	258
SLHDA2X3	184-23003	258
SLHDA2X4	181-00647	258
SLHDA2X4	181-00648	258
SLHDA2X4	184-24001	258
SLHDA2X4	184-24002	258
SLHDA2X4	184-24003	258
SLHDA2X5	181-00254	258
SLHDA2X5	181-00259	258
SLHDA2X5	181-00321	258
SLHDA3X1	181-00649	258
SLHDA3X1	181-00651	258
SLHDA3X1	181-00652	258
SLHDA3X2	181-00653	259
SLHDA3X2	181-00654	259
SLHDA3X2	181-00655	259
SLHDA3X3	181-00656	259
SLHDA3X3	181-00657	259
SLHDA3X3	184-33001	259
SLHDA3X4	181-00658	259
SLHDA3X4	181-00659	259
SLHDA3X4	184-34001	259
SLHDA3X5	181-00660	259
SLHDA3X5	181-00661	259
SLHDA3X5	181-00662	259
SLHDA4X2	181-00663	259
SLHDA4X2	181-00664	259
SLHDA4X2	181-00665	259
SLHDA4X3	181-00152	259
SLHDA4X3	181-00153	259
SLHDA4X3	181-00154	259
SLHDA4X4	181-00666	259
SLHDA4X4	181-00667	259
SLHDA4X4	184-44001	259
SLHDA4X5	181-00668	259
SLHDA4X5	181-00669	259
SLHDA4X5	181-00670	259
SLWR20	SLWR20C2	281
SLWR30	SLWR30C2	281
SLWR40	SLWR40C2	281
SM1	SM1BK75MT	366
SMPV	596-00735	450
SMPV10	596-00747	463
SNP1.25	SNP1.2510C2	197
SNP1.25	SNP1.2510M4	197
SNP1.25	SNP1.25GHS0C2	195
SNP1.25	SNP1.25GHS0M4	195
SNP1.5	SNP1.510C2	197
SNP1.5	SNP1.510M4	197
SNP1.5	SNP1.5GHS0C2	195
SNP1.5	SNP1.5GHS0M4	195
SNP1	SNP110C2	197
SNP1	SNP110M4	197
SNP1	SNP1GHS0C2	195
SNP1	SNP1GHS0M4	195
SNP10	SNP1010C2	197
SNP10	SNP1010M4	197
SNP10	SNP10GHS0C2	196
SNP10	SNP10GHS0M4	196
SNP100	SNP10010X2	198
SNP100	SNP100GHS0C2	196

Type	Part No.	Page
SNP101	SNP10110X2	198
SNP101	SNP101GHS0X2	196
SNP12A	SNP12A10C2	198
SNP12A	SNP12A10M4	198
SNP12A	SNP12AGHS0C2	196
SNP12A	SNP12AGHS0M4	196
SNP14A	109-00300	196
SNP14A	109-00301	196
SNP14A	109-00302	198
SNP14A	190-00303	198
SNP16	SNP1610C2	198
SNP16	SNP1610M4	198
SNP16	SNP16GHS0C2	196
SNP16	SNP16GHS0M4	196
SNP18A	SNP18A10C2	198
SNP18A	SNP18A10M4	198
SNP18A	SNP18AGHS0C2	196
SNP18A	SNP18AGHS0M4	196
SNP19	SNP1910C2	198
SNP19	SNP1910M4	198
SNP19	SNP19GHS0C2	196
SNP19	SNP19GHS0M4	196
SNP2	SNP210C2	197
SNP2	SNP210M4	197
SNP2	SNP2GHS0C2	195
SNP2	SNP2GHS0M4	195
SNP22	SNP2210C2	198
SNP22	SNP2210M4	198
SNP22	SNP22GHS0C2	196
SNP22	SNP22GHS0M4	196
SNP24	SNP2410C2	198
SNP24	SNP2410H4	198
SNP24	SNP24GHS0C2	196
SNP24	SNP24GHS0H4	196
SNP28	SNP2810C2	198
SNP28	SNP2810H4	198
SNP28	SNP28GHS0C2	196
SNP28	SNP28GHS0H4	196
SNP3	SNP310C2	197
SNP3	SNP310M4	197
SNP3	SNP3GHS0C2	195
SNP3	SNP3GHS0M4	195
SNP32	SNP3210H4	198
SNP32	SNP3210K2	198
SNP32	SNP32GHS0H4	196
SNP32	SNP32GHS0K2	196
SNP33	SNP3310H4	198
SNP33	SNP3310K2	198
SNP33	SNP33GHS0H4	196
SNP34	SNP3410H4	198
SNP34	SNP3410K2	198
SNP34	SNP34GHS0H4	196
SNP34	SNP34GHS0K2	196
SNP36	SNP3610H4	198
SNP36	SNP3610K2	198
SNP36	SNP36GHS0H4	196
SNP36	SNP36GHS0K2	196
SNP38	SNP3810H4	198
SNP38	SNP3810K2	198
SNP38	SNP38GHS0H4	196
SNP38	SNP38GHS0K2	196
SNP4	SNP410C2	197
SNP4	SNP410M4	197

Type	Part No.	Page
SNP4	SNP4GHS0C2	195
SNP4	SNP4GHS0M4	195
SNP42	SNP42N10K2	198
SNP42	SNP42NGHS0K2	196
SNP42N	SNP42N10C2	198
SNP42N	SNP42NGHS0C2	196
SNP50	SNP5010C2	198
SNP50	SNP50GHS0C2	196
SNP6	SNP610C2	197
SNP6	SNP610M4	197
SNP6	SNP6GHS0C2	195
SNP6	SNP6GHS0M4	195
SNP60	SNP6010C2	198
SNP60	SNP60GHS0C2	196
SNP7	SNP710C2	197
SNP7	SNP710M4	197
SNP7	SNP7GHS0C2	195
SNP7	SNP7GHS0M4	195
SNP70	SNP7010C2	198
SNP70	SNP7010X2	198
SNP70	SNP70GHS0C2	196
SNP76	SNP7610C2	198
SNP76	SNP76GHS0C2	196
SNP76	SNP76GHS0X2	196
SNP8	SNP810C2	197
SNP8	SNP810M4	197
SNP8	SNP8GHS0C2	195
SNP8	SNP8GHS0M4	195
SNP80	SNP8010C2	198
SNP80	SNP80GHS0C2	196
SNP90	SNP9010C2	198
SNP90	SNP90GHS0X2	196
SOC10FT6LG	151-00903	185
SOC11FTOVAL	151-00932	185
SOC11FTOVAL	151-00992	185
SOC12FTOVAL	151-01117	185
SOC12FTOVAL	151-01238	185
SOC13FT6LGL	151-01125	185
SOC13FT6LGR	151-01126	185
SOC13FTOVAL	151-01018	186
SOC4 M.FT6	155-30902	184
SOC5FT6LG	151-00074	184
SOC6	151-00023	184
SOC7FT6	151-00629	184
SOC8FT6	151-00650	184
SOC8FT6LG	151-00665	185
SOC9FT6	151-01153	185
SOC9FT6XLG	151-01154	185
SOCHFT6	151-00623	186
SOLARD	596-00246	460
SOLARD10	596-00674	461
SOLARDS	596-00810	460
SP CPK hanger cpl.	106-00071	492
SpeedyTie (RTT750HR)	115-00030	56
SpeedyTie (RTT750HR)	RTT750HR.NX1P	56
SpeedyTie (RTT750HR)	RTT750HR.NX900	56
SP MK7P replacement blade	MK7P-342	500
SP MK9P replacement blade	MK9P-109	500
SP MK9SST replacement blade	110-95273	504
SR255S	SR255S0HIHSUVX2	58
SR255X	SR255X0HIHSUVC2	58
SR255X	SR255X0HIHSUVX2	58
SRCI0500	SRCI0500C2	224

Type	Part No.	Page
SRCI0750	SRCI0750C2	224
SRCI1000	SRCI1000K2	224
SSB	596-00751	450
STAND OFF CLIP	150-45397	186
STAND-OFF-CLIP-2	155-01600	186
STECKERHALTER SITZ	155-36002	188
Strap Black ATS3080	ATS10266110	495
T120I	111-01619	30
T120I	T120I0H4	42
T120I	T120I0HIRUVH4	35
T120I	T120I0H5H4	29
T120I	T120I0K2	42
T120I	T120I0UVK2	33
T120I	T120I9H4	42
T120I	T120I9K2	42
T120L	T120L0H5K2	29
T120L	T120L0K2	42
T120L	T120L0UVK2	33
T120L	T120L9K2	42
T120MR	T120MR0H4	120
T120MR	T120MR0K2	120
T120MR	T120MR0UVK2	120
T120MR	T120MR9H4	120
T120MR	T120MR9K2	120
T120R	111-01125	39
T120R	T120R0H4	42
T120R	T120R0H5H4	29
T120R	T120R0H5K2	29
T120R	T120R0K2	42
T120R	T120R0PPH4	38
T120R	T120R0PPK2	38
T120R	T120R0UVC2	33
T120R	T120R0UVH4	33
T120R	T120R9H4	42
T120R	T120R9K2	42
T120RDH	T120RDH0H4	62
T120RDH	T120RDH0K2	62
T120RFT9A	156-00067	102
T120RFT9B	156-00071	102
T120S	111-01138	35
T120S	T120S0H4	42
T120S	T120S0H5H4	29
T120S	T120S0K2	42
T120S	T120S0PPH4	38
T120S	T120S0UVK2	33
T120S	T120S9H4	42
T120S	T120S9K2	42
T150L	T150L0UVX2	34
T150L	T150L0X2	43
T150L	T150L9X2	43
T150LL	T150LL0UVX2	34
T150LL	T150LL0X2	43
T150LL	T150LL9X2	43
T150M	111-00965	30
T150M	111-01752	36
T150M	T150M0HSX2	29
T150M	T150M0UVX2	34
T150M	T150M0X2	43
T150M	T150M9X2	43
T150R(U)	111-00966	30
T150R(U)	T150R0UVX2	34
T150R(U)	T150R0X2	43
T150R(U)	T150R9X2	43

Type	Part No.	Page
T150XL	T150XL0HSX2	29
T150XL	T150XL0UVX2	34
T150XL	T150XL0X2	43
T150XL	T150XL9X2	43
T150XLL	T150XLL0UVX2	34
T150XLL	T150XLL0X2	43
T150XLL	T150XLL9X2	43
T18I	T18I0C2	20
T18I	T18I0H5M4	28
T18I	T18I0M4	20
T18I	T18I9C2	20
T18I	T18I9M4	20
T18I	T18I9VOM4	37
T18L	T18L0C2	20
T18L	T18L0H5C2	28
T18L	T18L0H5M4	28
T18L	T18L0M4	20
T18L	T18L0VOC2	37
T18L	T18L9C2	20
T18L	T18L9M4	20
T18L	T18L9VOM4	37
T18MR	T18MR0C2	119
T18MR	T18MR0M4	119
T18MR	T18MR9C2	119
T18MR	T18MR9M4	119
T18R	111-00659	39
T18R	111-01933	24
T18R	111-01934	24
T18R	111-01935	24
T18R	111-01936	24
T18R	116-01812	24
T18R	116-01814	24
T18R	116-01815	24
T18R	116-01816	24
T18R	116-01818	24
T18R	T18R0C2	20
T18R	T18R0H5C2	28
T18R	T18R0H5M4	28
T18R	T18R0M4	20
T18R	T18R0PPC2	38
T18R	T18R0UVC2	33
T18R	T18R0UVM4	33
T18R	T18R0VOC2	37
T18R	T18R10M4	24
T18R	T18R1M4	24
T18R	T18R2HALC2	40
T18R	T18R2HALM4	40
T18R	T18R2M4	24
T18R	T18R3M4	24
T18R	T18R4M4	24
T18R	T18R5M4	24
T18R	T18R6M4	24
T18R	T18R7M4	24
T18R	T18R8M4	24
T18R	T18R9C2	20
T18R	T18R9M4	20
T18R	T18R9PPM4	38
T18R	T18R9VOC2	37
T18R	T18R9VOM4	37
T18RA50	T18RA50	493
T18RA50	T18RA50HSW	493
T18RA50	T18RA50VO	493
T18RA5000	120-05015	493

Appendix

Index by Type

Type	Part No.	Page
T18RA5000	T18RA5000	493
T18RA5000	T18RA5000HSW	493
T18ROS	118-04700	47
T18RSF	111-85519	93
T18RSF	111-85560	93
T18RWPM	126-00041	93
T18RWPM	126-00042	93
T18RWPM	T18RWPM9M4	93
T18S	T1850C2	20
T18S	T1850HSM4	28
T18S	T1850M4	20
T18S	T1859C2	20
T18S	T1859M4	20
T250I	T250I0X2	44
T250I	T250I9X2	44
T250L	T250L0X2	44
T250L	T250L9X2	44
T250M	111-00925	34
T250M	111-01196	35
T250M	T250M0X2	44
T250M	T250M9X2	44
T250R	T250R0HIRUVX2	35
T250R	T250R0X2	44
T250R	T250R9X2	44
T250S	T250S0X2	44
T250S	T250S9X2	44
T250XL	111-01126	35
T250XL	T250XL0X2	44
T250XL	T250XL9X2	44
T255M	T255M0HIRX2	45
T255R	T255R0HIRX2	45
T255S	T255S0HIRX2	45
T30L	T30L0C2	21
T30L	T30L0M4	21
T30L	T30L0UVC2	33
T30L	T30L0UVM4	33
T30L	T30L9C2	21
T30L	T30L9M4	21
T30LL	T30LL0C2	21
T30LL	T30LL0HSM4	28
T30LL	T30LL0M4	21
T30LL	T30LL9C2	21
T30LL	T30LL9M4	21
T30LOS	118-04900	47
T30MR	T30MR0C2	119
T30MR	T30MR0M4	119
T30MR	T30MR9C2	119
T30MR	T30MR9M4	119
T30R	111-00698	39
T30R	111-00968	30
T30R	111-01459	30
T30R	T30R0C2	21
T30R	T30R0HIRM4	35
T30R	T30R0HSC2	28
T30R	T30R0HSM4	28
T30R	T30R0M4	21
T30R	T30R0UVC2	33
T30R	T30R0UVM4	33
T30R	T30R0VOC2	37
T30R	T30R10C2	25
T30R	T30R10M4	25
T30R	T30R1C2	25
T30R	T30R1M4	25

Type	Part No.	Page
T30R	T30R2C2	25
T30R	T30R2M4	25
T30R	T30R3C2	25
T30R	T30R3M4	25
T30R	T30R4C2	25
T30R	T30R4M4	25
T30R	T30R5C2	25
T30R	T30R5M4	25
T30R	T30R6C2	25
T30R	T30R6M4	25
T30R	T30R7C2	25
T30R	T30R7M4	25
T30R	T30R8C2	25
T30R	T30R8M4	25
T30R	T30R9C2	21
T30R	T30R9M4	21
T30R	T30R9PPC2	38
T30RA	T30RA30	494
T30RA	T30RA3000	494
T30RA	T30RA3000OHS	494
T30RA	T30RA300OHS	494
T30RFT10	156-00089	100
T30RFT4	156-00953	100
T30RFT5	150-55850	100
T30RFT5	150-55948	100
T30RFT6	150-77940	100
T30RFT6LG	150-31090	100
T30RFT7	156-00057	100
T30RFT8	156-00375	100
T30ROC1A	156-00012	85
T30ROC2A	156-00013	85
T30ROC2A	156-00014	85
T30ROC2B	156-00838	85
T30ROC5J	156-00520	85
T30ROC5J-P	156-00894	86
T30ROC5J-P	156-00895	86
T30ROS	118-04800	47
T30ROSEC0.5-2.5SP-SVA	156-01797	126
T30ROSEC0.5-2.5SP-SVB	156-01546	126
T30RSF(U)	T30RSFOC2	91
T30RSF(U)	T30RSF0M4	91
T30RSF(U)	T30RSF9C2	91
T30RSF(U)	T30RSF9M4	91
T30XL	T30XL0C2	21
T30XL	T30XL0M4	21
T30XL	T30XL9C2	21
T30XL	T30XL9M4	21
T40I	T40I0C2	22
T40I	T40I0M4	22
T40I	T40I9C2	22
T40I	T40I9M4	22
T40L	T40L0C2	22
T40L	T40L0HSC2	28
T40L	T40L0M4	22
T40L	T40L9C2	22
T40L	T40L9M4	22
T40R(U)	T40R0C2	22
T40R(U)	T40R0HSM4	28
T40R(U)	T40R0M4	22
T40R(U)	T40R9C2	22
T40R(U)	T40R9M4	22
T40XEC5SP-E	133-00059	122
T50I	111-01601	35

Type	Part No.	Page
T50I	T50I0C2	23
T50I	T50I0HSC2	28
T50I	T50I0HSM4	28
T50I	T50I0M4	23
T50I	T50I0UVC2	33
T50I	T50I0UVM4	33
T50I	T50I0VOC2	37
T50I	T50I9C2	23
T50I	T50I9M4	23
T50I	T50I9VOC2	37
T50I	T50I9VOM4	37
T50IDH	T50IDH0C2	62
T50IDH	T50IDH0HSM4	62
T50IDH	T50IDH0M4	62
T50IDH	T50IDH0UVC2	62
T50IDH	T50IDH9C2	62
T50IDH	T50IDH9M4	62
T50IFT10	156-00092	102
T50IFT6LG	156-00054	101
T50IFT7	111-05350	101
T50IFT8	156-00377	101
T50IOC1B	156-01795	86
T50IOC2A	156-01060	86
T50L(US)	111-01561	36
T50L(US)	111-01562	36
T50L	111-00718	39
T50L	111-01128	35
T50L	T50L0C2	23
T50L	T50L0HSC2	28
T50L	T50L0HSM4	28
T50L	T50L0M4	23
T50L	T50L0UVC2	33
T50L	T50L0UVM4	33
T50L	T50L10C2	27
T50L	T50L10M4	27
T50L	T50L1C2	27
T50L	T50L1STNLM4	30
T50L	T50L2C2	27
T50L	T50L2M4	27
T50L	T50L3C2	27
T50L	T50L3M4	27
T50L	T50L4C2	27
T50L	T50L4M4	27
T50L	T50L5C2	27
T50L	T50L5M4	27
T50L	T50L6C2	27
T50L	T50L6M4	27
T50L	T50L8C2	27
T50L	T50L8M4	27
T50L	T50L9C2	23
T50L	T50L9M4	23
T50LDH	T50LDH0C2	62
T50LDH	T50LDH0HSM4	62
T50LDH	T50LDH0M4	62
T50LDH	T50LDH0UVC2	62
T50LDH	T50LDH9C2	62
T50LDH	T50LDH9M4	62
T50LFT10	156-00093	102
T50LFT6	156-00066	101
T50LFT7	156-00055	101
T50LFT7	156-00282	101
T50LFT8	156-00378	101
T50LOC1A	156-01031	86

Type	Part No.	Page
T50LOS	118-05900	47
T50MD7	111-85850	88
T50MI	T50MI0C2	119
T50MI	T50MI9C2	119
T50MI	T50MI9M4	119
T50ML	T50ML0C2	120
T50ML	T50ML0M4	120
T50ML	T50ML9C2	120
T50ML	T50ML9M4	120
T50MR	T50MROC2	120
T50MR	T50MROHSM4	120
T50MR	T50MROM4	120
T50MR	T50MR9C2	120
T50MR	T50MR9M4	120
T50MR	T50MR9X2	120
T50MRX	113-00060	121
T50MRX	113-00061	121
T50R	111-00732	39
T50R	111-00815	30
T50R	111-00931	35
T50R	111-01560	36
T50R	111-01564	36
T50R	111-01568	30
T50R	111-01703	30
T50R	T50ROC2	23
T50R	T50ROHIRM4	35
T50R	T50ROHSC2	28
T50R	T50ROHSM4	28
T50R	T50ROM4	23
T50R	T50ROPPC2	38
T50R	T50ROPPM4	38
T50R	T50ROUVC2	33
T50R	T50ROUVM4	33
T50R	T50R10C2	26
T50R	T50R10M4	26
T50R	T50R1C2	26
T50R	T50R1M4	26
T50R	T50R2C2	26
T50R	T50R2HALC2	40
T50R	T50R2HALM4	40
T50R	T50R2M4	26
T50R	T50R3C2	26
T50R	T50R3M4	26
T50R	T50R4C2	26
T50R	T50R4M4	26
T50R	T50R5C2	26
T50R	T50R5M4	26
T50R	T50R6C2	26
T50R	T50R6M4	26
T50R	T50R7C2	26
T50R	T50R7M4	26
T50R	T50R8C2	26
T50R	T50R8M4	26
T50R	T50R9C2	23
T50R	T50R9M4	23
T50R	T50R9PPC2	38
T50R	T50R9VOC2	37
T50R	T50R9VOM4	37
T50ROSBS5-6U-SET	156-01547	115
T50R1SB5-6USET	156-01668	115
T50RBHMB	156-01726	131
T50RDH	T50RDH0C2	61
T50RDH	T50RDH0HSM4	61

Type	Part No.	Page
T50RDH	T50RDH0M4	61
T50RDH	T50RDH0UVC2	61
T50RDH	T50RDH9C2	61
T50RDH	T50RDH9M4	61
T50REC19	156-00537	124
T50REC19	156-00590	124
T50REC20	156-00555	124
T50REC20	156-00561	124
T50REC20	156-00591	124
T50REC21	156-00553	124
T50REC22	156-00554	124
T50REC23	156-00556	125
T50REC23	156-00567	125
T50REC23	156-00592	125
T50REC23	156-01162	125
T50REC24	156-00557	125
T50REC24	156-00593	125
T50REC4A	156-00539	123
T50REC4A	156-00564	123
T50REC4A	156-00635	123
T50REC4A	156-02230	123
T50REC4A	156-02231	123
T50REC4B	156-00538	123
T50REC4B	156-00565	123
T50REC4B	156-00588	123
T50REC4B	156-02228	123
T50REC4B	156-02229	123
T50REC5A	156-00541	124
T50REC5A	156-00589	124
T50REC5A	156-02226	124
T50REC5A	156-02227	124
T50REC5B	156-00468	124
T50REC5B	156-00540	124
T50REC5B	156-02224	124
T50REC5B	156-02225	124
T50REC9SD	156-00551	124
T50RFT10	111-85810	102
T50RFT10	156-00091	102
T50RFT5.5SD	156-00882	101
T50RFT5	156-00025	100
T50RFT6	156-00157	101
T50RFT6LG	150-31091	101
T50RFT6LG	150-31098	101
T50RFT7	111-85871	101
T50RFT7HD	156-00329	101
T50RFT7HD	156-00457	101
T50RFT8	156-00376	101
T50ROC1A	156-00036	86
T50ROS	118-00111	47
T50ROS	118-05050	47
T50ROS AH6MDU	156-00444	96
T50ROS AH6U	126-00114	88
T50ROS AH6U	126-00115	88
T50ROSBHMB	156-01796	131
T50ROSBHMB5018	157-00329	132
T50ROSEC10	156-00871	127
T50ROSEC19	156-00872	127
T50ROSEC20	156-00873	127
T50ROSEC21	156-00874	127
T50ROSEC22	156-00876	127
T50ROSEC23	156-00877	127
T50ROSEC24	156-00878	127
T50ROSEC4A	156-00860	126

Type	Part No.	Page
T50ROSEC4B	156-00861	126
T50ROSEC5A	156-00864	126
T50ROSEC5B	156-00862	127
T50ROSEC9	156-00867	127
T50ROSFT6.5LG-E4	157-00306	103
T50ROSFT612.5SO	157-00216	105
T50ROSFT625SO	157-00195	105
T50ROSFT6LGU	157-00052	103
T50ROSFT6SO12.5A	157-00130	105
T50ROSFT6SO12.5A	157-00145	105
T50ROSFT6SO12.5R	157-00165	105
T50ROSFT6SO25A	157-00119	105
T50ROSFT6SO25A	157-00150	105
T50ROSFT6SO25A	157-00158	105
T50ROSFT6SO25R	157-00164	105
T50ROSFT812.5SO	157-00217	105
T50ROSFT825SO	157-00196	105
T50ROSFT8SO25A	157-00120	105
T50ROSFTM6SO12.5A	157-00118	105
T50ROSFTM6SO12.5B	157-00131	105
T50ROSFTOVAL12.5A	157-00224	106
T50ROSFTOVAL12.5A	157-00225	106
T50ROSFTOVAL12.5B	157-00249	106
T50ROSFTOVAL12.5SO	157-00218	109
T50ROSFTOVAL25A	157-00205	107
T50ROSFTOVAL25A	157-00222	107
T50ROSFTOVAL25A	157-00288	107
T50ROSFTOVAL25B	157-00247	107
T50ROSFTOVAL25B	157-00332	107
T50ROSFTOVAL25R	157-00221	106
T50ROSFTOVAL25SO	157-00219	109
T50ROSFTOVAL1125SO	157-00379	109
T50ROSFTOVAL1125A	157-00323	107
T50ROSFTOVAL1125B	157-00333	107
T50ROSFTOVALR	157-00232	107
T50ROSFTOVALU	157-00142	107
T50ROSFTOVALU	157-00153	107
T50ROSFTOVALU	157-00157	107
T50ROSFTOVALU	157-00254	107
T50ROSFTOVALU	157-00391	107
T50ROSFTQM6	157-00112	130
T50ROSFTQM6	157-00144	130
T50ROSFTQM6	157-00163	130
T50ROSFTSOVAL	157-00268	108
T50ROSLPM6SMSO25	157-00335	114
T50ROSLPM6SMSO25	157-00338	114
T50ROSLPM8SMSO25	157-00361	114
T50ROSLPM8SMSO25	157-00362	114
T50ROSM6SMSO25	157-00325	113
T50ROSM6SMSO25	157-00326	113
T50ROSM8SMSO25	157-00327	113
T50ROSM8SMSO25	157-00328	113
T50ROSP15FT6.5	156-00455	98
T50ROSP25FT6.5	156-00456	98
T50ROSSB5-6U	157-00233	111
T50ROSSFT6.5 16-3	150-37791	89
T50ROSSFT6.5 16-3MD	150-37799	90
T50ROSSFT6.5-D16-2 MD	150-93100	90
T50RPBM9SET	156-02512	129
T50RPBM9SET	156-02513	129
T50RSF(U)	T50RSF0C2	92
T50RSF(U)	T50RSF0M4	92
T50RSF(U)	T50RSF9C2	92

Appendix

Index by Type

Type	Part No.	Page
T5ORSF(U)	T5ORSF9M4	92
T5ORSFM	111-85720	94
T5ORSFM	126-00074	94
T5ORSFM	126-00116	94
T5ORSFM	126-00117	94
T5ORTM25	T5ORTM250HSC2	104
T5ORTM25	T5ORTM250HSM4	104
T5ORTM25E	157-00073	104
T5ORTM25E	T5ORTM25E0HSM4	104
T5ORTM25E	T5ORTM25E8HM4	104
T5OS	T5OS0C2	22
T5OS	T5OS0M4	22
T5OS	T5OS9C2	22
T5OS	T5OS9M4	22
T5OSD6	T5OSD60HSH4	88
T5OSDH	117-00017	61
T5OSDH	117-00018	61
T5OSDH	117-00019	61
T5OSDOP	126-00015	88
T5OSFT6	156-00156	101
T5OSFT6LG	150-31093	101
T5OSFT7	156-00056	101
T5OSL5	126-00001	94
T5OSL5	126-00005	94
T5OSL6	111-85460	94
T5OSL6	T5OSL6.NN6P	94
T5OSL7	T5OSL7.NN6P	95
T5OSMVCLOC10-14	156-02383	82
T5OSMVCLOC15-19	156-01690	82
T5OSMVCLOC20-25	156-01714	82
T5OSMVCLOC5-9	156-02384	82
T5OSMVCOC15-18	156-01340	82
T5OSMVCOC19-24.5	156-00577	83
T5OSMVCOC19-24.5	156-01342	83
T5OSMVCOC25-31	156-01344	83
T5OSMVCOC31-39	156-01346	83
T5OSMVCOC39-45	156-01348	83
T5OSOS	118-00110	47
T5OSOS	118-05850	47
T5OSOS2DOP62X122-E	157-00014	108
T5OSOS2DOP62X122-E	157-00069	108
T5OSOS3DOP65X130-E	157-00184	108
T5OSOSBHMB	156-01807	131
T5OSOSEC10	156-00870	127
T5OSOSEC12E	148-00200	122
T5OSOSEC13E	126-00000	122
T5OSOSEC19	156-04601	127
T5OSOSEC20	156-00016	127
T5OSOSEC21	156-00017	127
T5OSOSEC22	156-00875	127
T5OSOSEC34E	126-00036	122
T5OSOSEC4A	156-00858	126
T5OSOSEC4B	156-00859	126
T5OSOSEC5A	156-00865	126
T5OSOSEC5B	156-00863	126
T5OSOSEC9SD	156-00866	127
T5OSOSFT6.5-E4	157-00376	103
T5OSOSFT6.5LG-E4	157-00296	103
T5OSOSFT6.5LG-E4	157-00303	103
T5OSOSFT6.5LG-E4	157-00355	103
T5OSOSFT6.5LG-E4	157-00373	103
T5OSOSFT6.5LG-E4X	157-00287	103
T5OSOSFT6.5LG-E4X	157-00302	103

Type	Part No.	Page
T5OSOSFT6.5LG-E4X	157-00359	103
T5OSOSFT6E	155-05800	103
T5OSOSFT6LGU	157-00050	103
T5OSOSFT7X12U	157-00053	108
T5OSOSFT8E	157-00072	103
T5OSOSFT8E	157-00115	103
T5OSOSFTOVALU	157-00143	108
T5OSOSFTOVALU	157-00154	108
T5OSOSFTOVALU	157-00253	108
T5OSOSFTOVALU	157-00266	108
T5OSOSKSF75.4E	126-00075	87
T5OSOSKSF75SE	126-00099	87
T5OSOSKSF75SE	126-00111	87
T5OSOSKSF76.5E	126-00081	87
T5OSOSKSF76.552-E	126-00326	87
T5OSOSSB5-High-E-C-CC	157-00105	112
T5OSOSSB5-High-E-C-CC	157-00151	112
T5OSOSSB5-High-E-O-US	157-00106	112
T5OSOSSB6HE	155-46302	112
T5OSOSSFT6.5E	126-03102	88
T5OSOSSFT6.5E-MD	126-00243	96
T5OSOSSFT6.5E-MD	126-00244	96
T5OSOSSFT6.5E-MS-MD	126-00245	96
T5OSOSWA1.8E	148-00089	81
T5OSOSWA2.0E	148-00088	81
T5OSOSWA3.4E	148-00095	81
T5OSOSWA4.3E	148-00092	81
T5OSOSWB1.8E	148-00090	81
T5OSOSWB2.0E	148-00093	81
T5OSOSWB3.4E	148-00096	81
T5OSOSWB4.3E	148-00091	81
T5OSSF	126-00043	91
T5OSSF	126-00044	91
T5OSSF	126-00045	91
T5OSSF	126-00046	91
T5OSSFM	126-00049	95
T5OSSFM	126-00069	95
T5OSSFM	126-00082	95
T5OSLS	126-02204	95
T5OSST5	126-00017	88
T5OSST5	126-02300	88
T5OSST5	150-15395	88
T5OSVC3.5	156-01350	83
T5OSVC4S	156-01349	83
T5OSVC5	156-01516	83
T5OSVC6.5	156-01670	83
T5OSVCOC10-14	156-01337	84
T5OSVCOC10-14	156-01385	84
T5OSVCOC15-18	156-01339	84
T5OSVCOC19-24.5	156-01341	84
T5OSVCOC25-31	156-01343	84
T5OSVCOC31-39	156-01345	84
T5OSVCOC39-45	156-01347	84
T5OXL(US)	111-01563	36
T6OSSSFT62x122-E-MD	126-00080	97
T6OSSSFT65x130-E-MD	126-00076	97
T6OSSSFT65x130-E-MS-MD	126-00186	97
T6OSSSFT70x120-E-MD	126-00079	97
T8OROSLPSB10U	157-00342	116
T8OROSLPSB10U	157-00343	116
T8OROSLPSB12U	157-00344	116
T8OROSLPSB12U	157-00345	116
T8OROSLPSB8U	157-00340	116

Type	Part No.	Page
T8OROSLPSB8U	157-00341	116
T8OROSSB10U	157-00291	111
T8OROSSB10U	157-00294	111
T8OROSSB12U	157-00292	111
T8OROSSB12U	157-00295	111
T8OROSSB8U	157-00290	111
T8OROSSB8U	157-00293	111
T82S-BK	T82S	437
T8SD	110-70091	501
TAG1	TAG1-100	421
TAG10	TAG10-100	421
TAG10L	TAG10L-105	413
TAG10T2	TAG10T2-100B	387
TAG110	TAG110BL	411
TAG110	TAG110BR	411
TAG110	TAG110GR	411
TAG110	TAG110GY	411
TAG110	TAG110OR	411
TAG110	TAG110PL	411
TAG110	TAG110RD	411
TAG110	TAG110WT	411
TAG110	TAG110YL	411
TAG11J	TAG11J-450	416
TAG11L	TAG11L-789	409
TAG11T4	TAG11T4-250	388
TAG11T4	TAG11T4-822	391
TAG11T4	TAG11T4-822C	393
TAG13J	TAG13J-450	416
TAG13L	TAG13L-789	409
TAG13T4	TAG13T4-822	391
TAG13T4	TAG13T4-DTH	397
TAG14	TAG14-400	418
TAG14J	TAG14J-450	416
TAG14L	TAG14L-789	409
TAG15	TAG15-400	418
TAG15	TAG15-600	419
TAG15J	TAG15J-450	416
TAG15L	TAG15L-789	409
TAG15T3	TAG15T3-250	388
TAG15T3	TAG15T3-795	390
TAG15T3	TAG15T3-822	392
TAG15T3	TAG15T3-822C10M393	
TAG15T3	TAG15T3-DTH	397
TAG16	TAG16-400	418
TAG16T3	TAG16T3-822	391
TAG16T3	TAG16T3-DTH	397
TAG17T2	TAG17T2-822	392
TAG19J	TAG19J-450	416
TAG1L	TAG1L-105	413
TAG1T1	TAG1T1-100B	387
TAG2	TAG2-100	420
TAG21J	TAG21J-450	416
TAG21T6	596-21251	396
TAG21T6	TAG21T6-250	388
TAG22	TAG22-100	420
TAG22J	TAG22J-994	417
TAG22T2	TAG22T2-100B	386
TAG22T3	TAG22T3-100B	386
TAG23	TAG23-100	421
TAG24	TAG24-100	421
TAG24T1	TAG24T1-100B	387
TAG25	TAG25-100	420
TAG26	TAG26-100	420

Type	Part No.	Page
TAG26J	TAG26J-994	417
TAG26L	TAG26L-105	412
TAG26T6	TAG26T6-100B	386
TAG27	TAG27-400	418
TAG27	TAG27-600	419
TAG27T1	TAG27T1-795	390
TAG27T1	TAG27T1-822	392
TAG27T1	TAG27T1-822C	393
TAG27T2	TAG27T2-DTH	397
TAG28J	TAG28J-450	416
TAG28T4	596-28251	396
TAG28T4	TAG28T4-250	388
TAG2L	TAG2L-105	412
TAG2T5	TAG2T5-100B	386
TAG3	TAG3-100	420
TAG33T1	TAG33T1-DTH	397
TAG35T2	TAG35T2-250	388
TAG38T4	TAG38T4-100B	387
TAG3T3	TAG3T3-100B	387
TAG44	TAG44-400	418
TAG45L	TAG45L-789	409
TAG49L	TAG49L-105	412
TAG5	TAG5-100	420
TAG50L	TAG50L-105	413
TAG51J	TAG51J-994	417
TAG51L	TAG51L-105	412
TAG51T3	TAG51T3-100B	386
TAG52L	TAG52L-105	413
TAG53L	TAG53L-788	407
TAG53T2	TAG53T2-100B	387
TAG54L	TAG54L-788	407
TAG55L	TAG55L-788	407
TAG59J	TAG59J-108	415
TAG59L	TAG59L-788	407
TAG5J	TAG5J-994	417
TAG5L	TAG5L-105	412
TAG6	TAG6-100	421
TAG60L	TAG60L-788	407
TAG61L	TAG61L-788	407
TAG62L	TAG62L-788	407
TAG63L	TAG63L-105	412
TAG64J	TAG64J-994	417
TAG64L	TAG64L-105	413
TAG65L	TAG65L-105	412
TAG66L	TAG66L-789	409
TAG67L	TAG67L-789	409
TAG68L	TAG68L-789	409
TAG68T1	TAG68T1-336	389
TAG69L	TAG69L-789	409
TAG69T1	TAG69T1-336	389
TAG6T1	TAG6T1-100B	387
TAG70T12	TAG70T12-822	391
TAG71T5	TAG71T5-822	391
TAG72T1	TAG72T1-795	390
TAG72T1	TAG72T1-822	392
TAG73T1	TAG73T1-795	390
TAG73T1	TAG73T1-822	392
TAG73T1	TAG73T1-DTH	397
TAG75T1	TAG75T1-795	390
TAG75T1	TAG75T1-822	392
TAG76T1	TAG76T1-795	390
TAG77T1	TAG77T1-101	395
TAG78T1	TAG78T1-795	390

Type	Part No.	Page
TAG79T1	TAG79T1-795	390
TAG7T1	TAG7T1-100B	387
TAG80T1	TAG80T1-795	390
TAG81T8	TAG81T8-822	391
TAG82T2	TAG82T2-822	392
TAG83T1	TAG83T1-822	392
TAG84T3	TAG84T3-822	392
TAG9	TAG9-100	420
TAG96L	TAG96L-789	409
TAG96T1	TAG96T1-336	389
TAG9J	TAG9J-994	417
TAG9L	TAG9L-105	413
TAG9T3	TAG9T3-100B	386
TAGPHONE	TAGPHONE	414
TAGPP1	TAGPP1-788C	408
TAGPP1J	TAGPP1J-108	415
TAGPP1L	TAGPP1L-788	407
TAGPP1T6	TAGPP1T6-822	391
TAGPP1T6	TAGPP1T6-82210M	391
TAGPP1T6	TAGPP1T6-822C	393
TAGPP1T6	TAG-PP1T6-822C10M	393
TAGPP2	TAGPP2-788C	408
TAGPP3T4	TAGPP3T4-822	391
TAGPRINT10LIC	556-00038	485
TAGPRINT25LIC	556-00039	485
TAGPRINT3	556-00035	485
TAGPRINT3LIC	556-00036	485
TAGPRINT3UPGRD	556-00042	485
TAGPRINT3UPGRD10S	556-00045	485
TAGPRINT3UPGRD25S	556-00046	485
TAGPRINT3UPGRD3S	556-00043	485
TAGPRINT3UPGRD5S	556-00044	485
TAGPRINT50LIC	556-00052	485
TAGPRINT5LIC	556-00037	485
TAN33-ST-12/4 BK	318-60154	372
TAN33-ST-19/6 BK	318-60155	372
TAN33-ST-24/8 BK	318-60156	372
TAN33-ST-3/1 BK	318-60150	372
TAN33-ST-4.8/1.5 BK	318-60151	372
TAN33-ST-40/13 BK	318-60158	372
TAN33-ST-6/2 BK	318-60152	372
TAN33-ST-9/3 BK	318-60153	372
TAS120L	111-01672	79
TAS120M	111-01671	79
TBL375	596-00380	405
TBL500	596-00381	405
TC.5	181-00442	275
TC.5	181-00443	275
TC.5	181-90050	275
TC.5	181-90051	275
TC.5	181-90052	275
TC.5	181-91517	275
TC.75	181-00445	275
TC.75	181-00446	275
TC.75	181-00447	275
TC.75	181-90750	275
TC.75	181-90751	275
TC1.5	181-91503	276
TC1.5	181-91505	277
TC1.5	181-91506	276
TC1.5	181-91507	276
TC1.5	181-91509	276

Type	Part No.	Page
TC1.5	181-91510	276
TC1.5	181-91516	276
TC1	181-00444	275
TC1	181-91000	275
TC1	181-91002	277
TC1	181-91003	275
TC1	181-91004	275
TC1	181-91007	275
TC1	181-91008	275
TC2.5	181-00260	276
TC2.5	181-00261	276
TC2.5	181-00262	276
TC2.5	181-00263	276
TC2.5	181-00311	276
TC2	181-92001	276
TC2	181-92002	277
TC2	181-92003	277
TC2	181-92004	276
TC2	181-92005	276
TC2	181-92010	276
TC2	181-92011	276
TC2	181-92015	276
TC2FT6LG	155-30802	182
TC3	181-93000	276
TC3	181-93003	276
TC3	181-93005	277
TC3	181-93007	276
TC3	181-93008	276
TC3	181-93010	276
TC3	181-93011	276
TC4	181-94000	276
TC4	181-94003	276
TC4	181-94007	277
TC4	181-94008	276
TC4	181-94009	276
TC4	181-94013	276
TC4	181-94014	276
TC5FT6S	150-95500	182
TC6	181-00448	276
TC6	181-96000	276
TC6	181-96002	276
TC6FT6	151-00663	182
TC6FT6LG	151-00651	182
TC8	181-00165	276
TC8	181-00166	276
TC8	181-00449	276
TC8	181-00450	276
TC8	181-00451	276
TCN20-1.6/0.8	300-73601	380
TCN20-12.7/6.4	300-73607	380
TCN20-19.1/9.5	300-73608	380
TCN20-2.4/1.2	300-73602	380
TCN20-25.4/12.7	300-73609	380
TCN20-3.2/1.6	300-73603	380
TCN20-38.1/19.1	300-73610	380
TCN20-4.8/2.4	300-73604	380
TCN20-50.8/25.4	300-73611	380
TCN20-9.5/4.8	300-73606	380
TCOP70x120	151-00029	182
TC-SB5C	151-26101	187
TCWM1	TCWM1	440
TCWM10	TCWM10	440
TCWM11	TCWM11	440

Appendix

Index by Type

Type	Part No.	Page
TCWM12	TCWM12	440
TCWM13	TCWM13	440
TCWM14	TCWM14	440
TCWM15	TCWM15	440
TCWM16	TCWM16	440
TCWM2	TCWM2	440
TCWM3	TCWM3	440
TCWM4	TCWM4	440
TCWM5	TCWM5	440
TCWM6	TCWM6	440
TCWM7	TCWM7	440
TCWM8	TCWM8	440
TCWM9	TCWM9	440
TDNT	TDNT	282
TELS-13	TELS-13	78
TELS-27	TELS-27	78
TELS-SPOOL	TELS-SPOOL	78
TFN21 1.2/0.6	309-60197	373
TFN21 1.6/0.8	309-60107	373
TFN21 1.6/0.8	309-60108	373
TFN21 1.6/0.8	309-60109	373
TFN21 1.6/0.8	309-60280	373
TFN21 1.6/0.8	309-60281	373
TFN21 1.6/0.8	309-60282	373
TFN21 1.6/0.8	309-60283	373
TFN21 1.6/0.8	309-60284	373
TFN21 102.0/50.8	309-65237	375
TFN21 12.7/6.4	309-60306	374
TFN21 12.7/6.4	309-60307	374
TFN21 12.7/6.4	309-60308	374
TFN21 12.7/6.4	309-60309	374
TFN21 12.7/6.4	309-65160	374
TFN21 12.7/6.4	309-65161	374
TFN21 12.7/6.4	309-65162	374
TFN21 12.7/6.4	309-65163	374
TFN21 16.0/8.0	309-60310	375
TFN21 19.1/9.5	309-60311	375
TFN21 19.1/9.5	309-60312	375
TFN21 19.1/9.5	309-60313	375
TFN21 19.1/9.5	309-60314	375
TFN21 19.1/9.5	309-65170	375
TFN21 19.1/9.5	309-65171	375
TFN21 19.1/9.5	309-65172	375
TFN21 19.1/9.5	309-65173	375
TFN21 2.4/1.2	309-60118	373
TFN21 2.4/1.2	309-60285	373
TFN21 2.4/1.2	309-60286	373
TFN21 2.4/1.2	309-60287	373
TFN21 2.4/1.2	309-60288	373
TFN21 2.4/1.2	309-60289	373
TFN21 2.4/1.2	309-65111	373
TFN21 2.4/1.2	309-65112	373
TFN21 25.4/12.7	309-60315	375
TFN21 25.4/12.7	309-60316	375
TFN21 25.4/12.7	309-60317	375
TFN21 25.4/12.7	309-60318	375
TFN21 25.4/12.7	309-65180	375
TFN21 25.4/12.7	309-65181	375
TFN21 25.4/12.7	309-65182	375
TFN21 25.4/12.7	309-65183	375
TFN21 3.2/1.6	309-60290	374
TFN21 3.2/1.6	309-60291	374
TFN21 3.2/1.6	309-60292	374

Type	Part No.	Page
TFN21 3.2/1.6	309-60293	374
TFN21 3.2/1.6	309-65120	374
TFN21 3.2/1.6	309-65121	374
TFN21 3.2/1.6	309-65122	374
TFN21 3.2/1.6	309-65123	374
TFN21 31.8/16.0	309-60319	375
TFN21 31.8/16.0	309-60320	375
TFN21 31.8/16.0	309-60321	375
TFN21 31.8/16.0	309-60322	375
TFN21 31.8/16.0	309-60323	375
TFN21 31.8/16.0	309-60324	375
TFN21 31.8/16.0	309-60325	375
TFN21 38.1/19.1	309-60326	375
TFN21 38.1/19.1	309-60327	375
TFN21 38.1/19.1	309-60328	375
TFN21 38.1/19.1	309-60329	375
TFN21 38.1/19.1	309-60330	375
TFN21 38.1/19.1	309-60331	375
TFN21 38.1/19.1	309-65192	375
TFN21 4.8/2.4	309-60294	374
TFN21 4.8/2.4	309-60295	374
TFN21 4.8/2.4	309-60296	374
TFN21 4.8/2.4	309-60297	374
TFN21 4.8/2.4	309-65130	374
TFN21 4.8/2.4	309-65131	374
TFN21 4.8/2.4	309-65132	374
TFN21 4.8/2.4	309-65133	374
TFN21 50.8/25.4	309-60332	375
TFN21 50.8/25.4	309-60333	375
TFN21 50.8/25.4	309-60334	375
TFN21 50.8/25.4	309-60335	375
TFN21 50.8/25.4	309-60336	375
TFN21 50.8/25.4	309-60337	375
TFN21 50.8/25.4	309-60338	375
TFN21 6.4/3.2	309-60298	374
TFN21 6.4/3.2	309-60299	374
TFN21 6.4/3.2	309-60300	374
TFN21 6.4/3.2	309-60301	374
TFN21 6.4/3.2	309-65140	374
TFN21 6.4/3.2	309-65141	374
TFN21 6.4/3.2	309-65142	374
TFN21 6.4/3.2	309-65143	374
TFN21 76.2/38.1	309-65227	375
TFN21 9.5/4.8	309-60302	374
TFN21 9.5/4.8	309-60303	374
TFN21 9.5/4.8	309-60304	374
TFN21 9.5/4.8	309-60305	374
TFN21 9.5/4.8	309-65150	374
TFN21 9.5/4.8	309-65151	374
TFN21 9.5/4.8	309-65152	374
TFN21 9.5/4.8	309-65153	374
TFN21-ST 1.6/0.8	309-65100	376
TFN21-ST 1.6/0.8	309-65101	376
TFN21-ST 1.6/0.8	309-65102	376
TFN21-ST 1.6/0.8	309-65103	376
TFN21-ST 1.6/0.8	309-65104	376
TFN21-ST 1.6/0.8	309-65105	376
TFN21-ST 1.6/0.8	309-65106	376
TFN21-ST 102/50.8	309-65230	379
TFN21-ST 102/50.8	309-65231	379
TFN21-ST 102/50.8	309-65232	379
TFN21-ST 102/50.8	309-65233	379
TFN21-ST 102/50.8	309-65234	379

Type	Part No.	Page
TFN21-ST 102/50.8	309-65235	379
TFN21-ST 102/50.8	309-65236	379
TFN21-ST 12.7/6.4	309-65146	377
TFN21-ST 12.7/6.4	309-65164	377
TFN21-ST 12.7/6.4	309-65165	377
TFN21-ST 12.7/6.4	309-65167	377
TFN21-ST 12.7/6.4	309-65168	377
TFN21-ST 12.7/6.4	309-65169	377
TFN21-ST 12.7/6.4	309-65294	377
TFN21-ST 12.7/6.4	309-65295	377
TFN21-ST 19.1/9.5	309-65174	378
TFN21-ST 19.1/9.5	309-65175	378
TFN21-ST 19.1/9.5	309-65176	378
TFN21-ST 19.1/9.5	309-65177	378
TFN21-ST 19.1/9.5	309-65178	378
TFN21-ST 19.1/9.5	309-65179	378
TFN21-ST 19.1/9.5	309-65296	378
TFN21-ST 2.4/1.2	309-65110	376
TFN21-ST 2.4/1.2	309-65113	376
TFN21-ST 2.4/1.2	309-65114	376
TFN21-ST 2.4/1.2	309-65115	376
TFN21-ST 2.4/1.2	309-65116	376
TFN21-ST 2.4/1.2	309-65117	376
TFN21-ST 2.4/1.2	309-65118	376
TFN21-ST 25.4/12.7	309-65184	378
TFN21-ST 25.4/12.7	309-65280	378
TFN21-ST 25.4/12.7	309-65297	378
TFN21-ST 25.4/12.7	309-65298	378
TFN21-ST 25.4/12.7	309-65299	378
TFN21-ST 25.4/12.7	309-65300	378
TFN21-ST 25.4/12.7	309-65301	378
TFN21-ST 3.2/1.6	309-65124	377
TFN21-ST 3.2/1.6	309-65125	377
TFN21-ST 3.2/1.6	309-65126	377
TFN21-ST 3.2/1.6	309-65127	377
TFN21-ST 3.2/1.6	309-65128	377
TFN21-ST 3.2/1.6	309-65129	377
TFN21-ST 3.2/1.6	309-65195	377
TFN21-ST 31.8/16.0	309-65270	378
TFN21-ST 31.8/16.0	309-65271	378
TFN21-ST 31.8/16.0	309-65272	378
TFN21-ST 31.8/16.0	309-65273	378
TFN21-ST 31.8/16.0	309-65274	378
TFN21-ST 31.8/16.0	309-65275	378
TFN21-ST 31.8/16.0	309-65276	378
TFN21-ST 38.1/19.1	309-65193	378
TFN21-ST 38.1/19.1	309-65194	378
TFN21-ST 38.1/19.1	309-65302	378
TFN21-ST 38.1/19.1	309-65303	378
TFN21-ST 38.1/19.1	309-65304	378
TFN21-ST 38.1/19.1	309-65305	378
TFN21-ST 38.1/19.1	309-65306	378
TFN21-ST 4.8/2.4	309-65134	377
TFN21-ST 4.8/2.4	309-65135	377
TFN21-ST 4.8/2.4	309-65136	377
TFN21-ST 4.8/2.4	309-65137	377
TFN21-ST 4.8/2.4	309-65138	377
TFN21-ST 4.8/2.4	309-65139	377
TFN21-ST 4.8/2.4	309-65290	377
TFN21-ST 50.8/25.4	309-65210	378
TFN21-ST 50.8/25.4	309-65211	378
TFN21-ST 50.8/25.4	309-65212	378
TFN21-ST 50.8/25.4	309-65213	378

Type	Part No.	Page
TFN21-ST 50.8/25.4	309-65214	378
TFN21-ST 50.8/25.4	309-65215	378
TFN21-ST 50.8/25.4	309-65216	378
TFN21-ST 6.4/3.2	309-65144	377
TFN21-ST 6.4/3.2	309-65145	377
TFN21-ST 6.4/3.2	309-65147	377
TFN21-ST 6.4/3.2	309-65148	377
TFN21-ST 6.4/3.2	309-65149	377
TFN21-ST 6.4/3.2	309-65166	377
TFN21-ST 6.4/3.2	309-65291	377
TFN21-ST 6.4/3.2	309-65292	377
TFN21-ST 76.2/38.1	309-65220	379
TFN21-ST 76.2/38.1	309-65221	379
TFN21-ST 76.2/38.1	309-65222	379
TFN21-ST 76.2/38.1	309-65223	379
TFN21-ST 76.2/38.1	309-65224	379
TFN21-ST 76.2/38.1	309-65225	379
TFN21-ST 76.2/38.1	309-65226	379
TFN21-ST 9.5/4.8	309-65154	377
TFN21-ST 9.5/4.8	309-65155	377
TFN21-ST 9.5/4.8	309-65156	377
TFN21-ST 9.5/4.8	309-65157	377
TFN21-ST 9.5/4.8	309-65158	377
TFN21-ST 9.5/4.8	309-65159	377
TFN21-ST 9.5/4.8	309-65293	377
TFN31 12/4	333-41503	370
TFN31 18/6	333-41504	370
TFN31 24/8	333-41505	370
TFN31 3/1	333-41500	370
TFN31 39/13	333-41506	370
TFN31 6/2	333-41501	370
TFN31 9/3	333-41502	370
TFN31-ST-1.5/0.5	333-41507	371
TFN31-ST-12/4	333-41512	371
TFN31-ST-18/6	333-41513	371
TFN31-ST-24/8	333-41514	371
TFN31-ST-3/1	333-41508	371
TFN31-ST-4.5/1.5	333-41509	371
TFN31-ST-6/2	333-41510	371
TFN31-ST-9/3	333-41511	371
TFOT1	TFOT-1	432
TIPTAGVA10X65YEW	556-26006	438
TIPTAGVA10X90YEW	556-26007	438
TIPTAGVA15X65YEW	556-26008	438
TIPTAGVA15X90YEW	556-26009	438
TM1SF	TM1SF0C2	154
TM1SF	TM1SF0M4	154
TM1SF	TM1SF10C2	154
TM1SF	TM1SF10M4	154
TM1SF	TM1SF9M4	154
TREDUX HA47-48ST-13/4	321-50010	382
TREDUX HA47-48ST-19/6	321-50011	382
TREDUX HA47-48ST-33/8	321-50012	382
TREDUX HA47-48ST-45/12	321-50013	382
TREDUX HA47-48ST-51/16	321-50014	382
TREDUX HA47-48ST-68/22	321-50015	382
TREDUX HA47-48ST-85/25	321-50016	382
TREDUX MA47-48ST-12/3	323-50010	381
TREDUX MA47-48ST-19/6	323-50011	381
TREDUX MA47-48ST-30/8	323-50012	381
TREDUX MA47-48ST-40/12	323-50013	381
TREDUX MA47-48ST-50/16	323-50014	381
TREDUX MA47-48ST-63/19	323-50015	381

Type	Part No.	Page
TREDUX MA47-48ST-75/22	323-50016	381
TREDUX MA47-48ST-95/30	323-50017	381
TSR1-12	TSR1FW-12	294
TSR1-12	TSR11-12	294
TSR1-12	TSR1W-12	294
TSR1-14	TSR1FW-14	293
TSR1-14	TSR11-14	293
TSR1-14	TSR1W-14	293
TSR1-21-1	TSR1FW-21-1	292
TSR1-21-1	TSR11-21-1	292
TSR1-21-1	TSR1W-21-1	292
TSR1-25-1	TSR1FW-25-1	291
TSR1-25-1	TSR11-25-1	291
TSR1-25-1	TSR1W-25-1	291
TSR1-29-1	TSR1FW-29-1	290
TSR1-29-1	TSR11-29-1	290
TSR1-29-1	TSR1W-29-1	290
TSR1-33-1	TSR1FW-33-1	289
TSR1-33-1	TSR11-33-1	289
TSR1-33-1	TSR1W-33-1	289
TSR1-36	TSR1FW-36	288
TSR1-36	TSR11-36	288
TSR1-36	TSR1W-36	288
TSR1-50	TSR1FW-50	287
TSR1-50	TSR11-50	287
TSR1-50	TSR1W-50	287
TSR1-6A	TSR1FW-6A	285
TSR1-6A	TSR11-6A	285
TSR1-6A	TSR1W-6A	285
TSR1-8A	TSR1FW-8A	285
TSR1-8A	TSR11-8A	285
TSR1-8A	TSR1W-8A	285
TSR2-12	TSR2FW-12	294
TSR2-12	TSR21-12	294
TSR2-12	TSR2W-12	294
TSR2-14	TSR2FW-14	293
TSR2-14	TSR21-14	293
TSR2-14	TSR2W-14	293
TSR2-21-1	TSR2FW-21-1	292
TSR2-21-1	TSR21-21-1	292
TSR2-21-1	TSR2W-21-1	292
TSR2-25-1	TSR2FW-25-1	291
TSR2-25-1	TSR21-25-1	291
TSR2-25-1	TSR2W-25-1	291
TSR2-29-1	TSR2FW-29-1	290
TSR2-29-1	TSR21-29-1	290
TSR2-29-1	TSR2W-29-1	290
TSR2-33-1	TSR2FW-33-1	289
TSR2-33-1	TSR21-33-1	289
TSR2-33-1	TSR2W-33-1	289
TSR2-36	TSR2FW-36	288
TSR2-36	TSR21-36	288
TSR2-36	TSR2W-36	288
TSR2-50	TSR2FW-50	287
TSR2-50	TSR21-50	287
TSR2-50	TSR2W-50	287
TSR2-6A	TSR2FW-6A	286
TSR2-6A	TSR21-6A	286
TSR2-6A	TSR2W-6A	286
TSR2-8A	TSR2FW-8A	285
TSR2-8A	TSR21-8A	285
TSR2-8A	TSR2W-8A	285
TSR3-12	TSR3FW-12	294

Type	Part No.	Page
TSR3-12	TSR31-12	294
TSR3-12	TSR3W-12	294
TSR3-14	TSR3FW-14	293
TSR3-14	TSR31-14	293
TSR3-14	TSR3W-14	293
TSR3-21-1	TSR3FW-21-1	292
TSR3-21-1	TSR31-21-1	292
TSR3-21-1	TSR3W-21-1	292
TSR3-25-1	TSR3FW-25-1	291
TSR3-25-1	TSR31-25-1	291
TSR3-25-1	TSR3W-25-1	291
TSR3-29-1	TSR3FW-29-1	290
TSR3-29-1	TSR31-29-1	290
TSR3-29-1	TSR3W-29-1	290
TSR3-33-1	TSR3FW-33-1	289
TSR3-33-1	TSR31-33-1	289
TSR3-33-1	TSR3W-33-1	289
TSR3-36	TSR3FW-36	288
TSR3-36	TSR31-36	288
TSR3-36	TSR3W-36	288
TSR3-50	TSR3FW-50	287
TSR3-50	TSR31-50	287
TSR3-50	TSR3W-50	287
TSR3-6A	TSR3FW-6A	286
TSR3-6A	TSR31-6A	286
TSR3-6A	TSR3W-6A	286
TSR3-8A	TSR3FW-8A	286
TSR3-8A	TSR31-8A	286
TSR3-8A	TSR3W-8A	286
TSR-JB1	TSRFBW-JB1	295
TSR-JB1	TSR1-JB1	295
TSR-JB1	TSRW-JB1	295
TSR-JB2	TSRFBW-JB2	295
TSR-JB2	TSR1-JB2	295
TSR-JB2	TSRW-JB2	295
TSR-JB3	TSRFBW-JB3	295
TSR-JB3	TSR1-JB3	295
TSR-JB3	TSRW-JB3	295
TSR-JBD	TSRFBW-JBD	296
TSR-JBD	TSR1-JBD	296
TSR-JBD	TSRW-JBD	296
TSR-JBD2	TSRFBW-JBD2	296
TSR-JBD2	TSR1-JBD2	296
TSR-JBD2	TSRW-JBD2	296
TSRP1-12	TSRP1FW-12	303
TSRP1-12	TSRP11-12	303
TSRP1-12	TSRP1W-12	303
TSRP1-14	TSRP1FW-14	304
TSRP1-14	TSRP11-14	304
TSRP1-14	TSRP1W-14	304
TSRP1-21-1	TSRP1FW-21-1	305
TSRP1-21-1	TSRP11-21-1	305
TSRP1-21-1	TSRP1W-21-1	305
TSRP1-25-1	TSRP1FW-25-1	299
TSRP1-25-1	TSRP11-25-1	299
TSRP1-25-1	TSRP1W-25-1	299
TSRP1-29-1	TSRP1FW-29-1	302
TSRP1-29-1	TSRP11-29-1	302
TSRP1-29-1	TSRP1W-29-1	302
TSRP1-33-1	TSRP1FW-33-1	301
TSRP1-33-1	TSRP11-33-1	301
TSRP1-33-1	TSRP1W-33-1	301
TSRP1-36	TSRP1FW-36	300

Appendix

Index by Type

Type	Part No.	Page
TSRP1-36	TSRP1I-36	300
TSRP1-36	TSRP1W-36	300
TSRP1-50	TSRP1FW-50	298
TSRP1-50	TSRP1I-50	298
TSRP1-50	TSRP1W-50	298
TSRP1-6A	TSRP1FW-6A	297
TSRP1-6A	TSRP1I-6A	297
TSRP1-6A	TSRP1W-6A	297
TSRP1-8A	TSRP1FW-8A	297
TSRP1-8A	TSRP1I-8A	297
TSRP1-8A	TSRP1W-8A	297
TSRP2-12	TSRP2FW-12	303
TSRP2-12	TSRP2I-12	303
TSRP2-12	TSRP2W-12	303
TSRP2-14	TSRP2FW-14	304
TSRP2-14	TSRP2I-14	304
TSRP2-14	TSRP2W-14	304
TSRP2-21-1	TSRP2FW-21-1	305
TSRP2-21-1	TSRP2I-21-1	305
TSRP2-21-1	TSRP2W-21-1	305
TSRP2-25-1	TSRP2FW-25-1	299
TSRP2-25-1	TSRP2I-25-1	299
TSRP2-25-1	TSRP2W-25-1	299
TSRP2-29-1	TSRP2FW-29-1	302
TSRP2-29-1	TSRP2I-29-1	302
TSRP2-29-1	TSRP2W-29-1	302
TSRP2-33-1	TSRP2FW-33-1	301
TSRP2-33-1	TSRP2I-33-1	301
TSRP2-36	TSRP2FW-36	300
TSRP2-36	TSRP2I-36	300
TSRP2-36	TSRP2W-36	300
TSRP2-50	TSRP2FW-50	298
TSRP2-50	TSRP2I-50	298
TSRP2-50	TSRP2W-50	298
TSRP2-6A	TSRP2FW-6A	297
TSRP2-6A	TSRP2I-6A	297
TSRP2-6A	TSRP2W-6A	297
TSRP2-8A	TSRP2FW-8A	297
TSRP2-8A	TSRP2I-8A	297
TSRP2-8A	TSRP2W-8A	297
TSRP3-12	TSRP3FW-12	303
TSRP3-12	TSRP3I-12	303
TSRP3-12	TSRP3W-12	303
TSRP3-14	TSRP3FW-14	304
TSRP3-14	TSRP3I-14	304
TSRP3-14	TSRP3W-14	304
TSRP3-21-1	TSRP3FW-21-1	305
TSRP3-21-1	TSRP3I-21-1	305
TSRP3-21-1	TSRP3W-21-1	305
TSRP3-25-1	TSRP3FW-25-1	299
TSRP3-25-1	TSRP3I-25-1	299
TSRP3-25-1	TSRP3W-25-1	299
TSRP3-29-1	TSRP3FW-29-1	302
TSRP3-29-1	TSRP3I-29-1	302
TSRP3-29-1	TSRP3W-29-1	302
TSRP3-33-1	TSRP3FW-33-1	301
TSRP3-33-1	TSRP3I-33-1	301
TSRP3-33-1	TSRP3W-33-1	301
TSRP3-36	TSRP3FW-36	300
TSRP3-36	TSRP3I-36	300
TSRP3-36	TSRP3W-36	300
TSRP3-50	TSRP3FW-50	298

Type	Part No.	Page
TSRP3-50	TSRP3I-50	298
TSRP3-50	TSRP3W-50	298
TSRP3-6A	TSRP3FW-6A	297
TSRP3-6A	TSRP3I-6A	297
TSRP3-6A	TSRP3W-6A	297
TSRP3-8A	TSRP3FW-8A	297
TSRP3-8A	TSRP3I-8A	297
TSRP3-8A	TSRP3W-8A	297
TSRPFW-RB	TSRPFW-RB	306
TSRPI-RB	TSRPI-RB	306
TSRP-JB1	TSRPFW-JB1	307
TSRP-JB1	TSRPI-JB1	307
TSRP-JB1	TSRPW-JB1	307
TSRP-JB2	TSRPFW-JB2	307
TSRP-JB2	TSRPI-JB2	307
TSRP-JB2	TSRPW-JB2	307
TSRP-JB3	TSRPFW-JB3	307
TSRP-JB3	TSRPI-JB3	307
TSRP-JB3	TSRPW-JB3	307
TSRP-JBD	TSRPFW-JBD	308
TSRP-JBD	TSRPI-JBD	308
TSRP-JBD	TSRPW-JBD	308
TSRP-JBD2	TSRPFW-JBD2	308
TSRP-JBD2	TSRPI-JBD2	308
TSRP-JBD2	TSRPW-JBD2	308
TSRPW-RB	TSRPW-RB	306
TT100OUTSM	TT100OUTSM	481
TT130PWRSLY	556-00252	478
TT130RHEAD	556-00251	478
TT130SMC	556-00250	478
TT130SMCCASE	556-00253	478
TT130SMCCORD	556-00255	478
TT130SMCKIT	556-00254	478
TT230SM	556-00230	480
TT230SMC	556-00240	480
TT230SMC KIT	556-00256	480
TT230SM KIT	556-00239	480
TT4030	556-04037	484
TT4030 Printhead	556-04041	484
TT822OUT	TT822OUT	483
TT822OUT2	TT822OUT2	483
TT822OUT3	TT822OUT3	483
TT822OUT4	TT822OUT4	483
TT822OUT5	TT822OUT5	483
TT822OUT6	TT822OUT6	483
TT822OUT7	TT822OUT7	483
TT822OUT8	TT822OUT8	483
TT822OUTSM	TT822OUTSM	481
TT822OUTSM2	TT822OUTSM2	481
TT822OUTSM-2	TT822OUTSM-2	479
TT822OUTSM3	TT822OUTSM3	481
TT822OUTSM4	TT822OUTSM4	481
TT822OUTSM5	TT822OUTSM5	481
TT822OUTSM6	TT822OUTSM6	481
TT822OUTSM7	TT822OUTSM7	481
TT822OUTSM8	TT822OUTSM8	481
TT900OUT	TT900OUT	483
TTDTHOUT	TTDTHOUT	483
TTDTHOUTSM	TTDTHOUTSM	481
TTHTOUT	TTHTOUT	483
TTHTOUTSM	TTHTOUTSM	481
TTM430	556-00430	482
TTM430-SC	556-00443	482

Type	Part No.	Page
TTM430SPH300	556-03068	482
TTM430SPH600	556-03069	482
TTM460	556-00460	482
TTM460 Printhead	556-00461	482
TTWHITEOUT	556-00189	483
TTWHITEOUT2	556-00259	483
TTWHITEOUTSM	556-00190	481
TTWHITEOUTSM-2	556-00205	479
TTWHITEOUTSM2	556-00258	481
TWT	TWT1	505
TYHC	TYHC1-33	441
TYHC	TYHC81	443
TYHC0	TYHC0	441
TYHC1	TYHC1	441
TYHC10	TYHC10	441
TYHC100	TYHC100	443
TYHC11	TYHC11	441
TYHC12	TYHC12	441
TYHC13	TYHC13	442
TYHC14	TYHC14	442
TYHC15	TYHC15	442
TYHC16	TYHC16	442
TYHC17	TYHC17	442
TYHC18	TYHC18	442
TYHC19	TYHC19	442
TYHC2	TYHC2	441
TYHC20	TYHC20	442
TYHC21	TYHC21	442
TYHC22	TYHC22	442
TYHC23	TYHC23	442
TYHC24	TYHC24	442
TYHC25	TYHC25	442
TYHC26	TYHC26	442
TYHC27	TYHC27	442
TYHC28	TYHC28	442
TYHC29	TYHC29	442
TYHC3	TYHC3	441
TYHC30	TYHC30	442
TYHC31	TYHC31	442
TYHC32	TYHC32	442
TYHC33	TYHC33	442
TYHC34	TYHC34	442
TYHC34-66	TYHC34-66	441
TYHC35	TYHC35	442
TYHC36	TYHC36	442
TYHC37	TYHC37	442
TYHC38	TYHC38	442
TYHC39	TYHC39	442
TYHC4	TYHC4	441
TYHC40	TYHC40	442
TYHC41	TYHC41	442
TYHC42	TYHC42	442
TYHC43	TYHC43	442
TYHC44	TYHC44	442
TYHC45	TYHC45	442
TYHC46	TYHC46	442
TYHC47	TYHC47	442
TYHC48	TYHC48	442
TYHC49	TYHC49	442
TYHC5	TYHC5	441
TYHC50	TYHC50	442
TYHC51	TYHC51	443
TYHC52	TYHC52	443

Type	Part No.	Page
TYHC53	TYHC53	443
TYHC54	TYHC54	443
TYHC55	TYHC55	443
TYHC6	TYHC6	441
TYHC67-99	TYHC67-99	441
TYHC7	TYHC7	441
TYHC8	TYHC8	441
TYHC9	TYHC9	441
TYHCA	TYHCA	443
TYHCA-Z	TYHCA-Z	441
TYHCB	TYHCB	443
TYHCC	TYHCC	443
TYHCD	TYHCD	443
TYHCF	TYHCF	443
TYHCL	TYHCL	443
TYHCN	TYHCN	443
TYHCP	TYHCP	443
TYHCS	TYHCS	443
UC200	110-99000	505
VM110A	596-00946	472
VM110C	596-00947	472
VM120/208A	596-00928	472
VM120/208B	596-00929	472
VM120/208C	596-00930	472
VM120/240B	596-00958	472
VM120A	596-00925	472
VM120B	596-00926	472
VM120C	596-00927	472
VM208A	596-00931	472
VM208B	596-00932	472
VM208C	596-00933	472
VM220B	596-00957	472
VM230C	596-00955	472
VM240A	596-00934	472
VM240B	596-00935	473
VM240C	596-00936	473
VM277/480A	596-00938	473
VM277/480B	596-00939	473
VM277/480C	596-00940	473
VM277C	596-00937	473
VM4160A	596-00954	473
VM440A	596-00948	473
VM440C	596-00949	473
VM460A	596-00950	473
VM460C	596-00951	473
VM480A	596-00941	473
VM480B	596-00942	473
VM480C	596-00943	473
VM600A	596-00952	473
VM600C	596-00953	473
VMHIGHVOLTAGEA	596-00956	473
VMSINGLEPHASEB	596-00944	473
VMTHREEPHASEB	596-00945	473
WAC075	151-00667	223
WAC100	151-00668	223
WAC100	151-00669	223
WDCCU	596-00258	452
WDCCU	596-00588	452
WDCCU10	596-00662	463
WDCCUM5	596-00831	448
WDGC17	596-09323	452
WDGC1710	596-09324	463
WDGC17M5	596-00924	448

Type	Part No.	Page
WDPSLBL	596-00231	452
WDPSLBL	596-00495	452
WDPSLBL10	596-00665	463
WDPSLBLM5	596-00833	448
WESHLBL	596-00233	452
WESHLBL	596-00497	452
WESHLBL10	596-00660	463
WESHLBL17	596-00878	452
WESHLBL1710	596-00893	463
WESHLBL17M5	596-00921	449
WESHLBLDC	596-00232	452
WESHLBLDC	596-00496	452
WESHLBLDC10	596-00661	463
WESHLBLDC17	596-00879	452
WESHLBLDC1710	596-00894	463
WESHLBLDC17M5	596-00920	449
WESHLBLDCM5	596-00829	449
WESHLBLDCS	596-00802	453
WESHLBLM5	596-00828	449
WGCME	596-00234	453
WGCME	596-00498	453
WGCME10	596-00663	463
WGCMEM5	596-00830	449
WICKELCLIP-VDS	155-16301	182
Wiring Duct Cutting Tool	904-00295	282
Wiring Duct Cutting Tool Replacement Blade	904-00296	282
Wiring Duct Safety Guide	904-00297	282
WS275X135	596-00386	403
WS55X275	596-00388	403
WSI	111-12301	46
WSI10MM	157-00285	118
WSI250	157-00401	117
WSI380	157-00404	117
WSI6MM	157-00282	117
WSI8MM	157-00035	118
WSIFT9A	156-00069	102
WSMBSAHB	151-01857	144
WSR	111-12302	46
WSR10MM	157-00286	118
WSR250	157-00402	117
WSR380	157-00405	117
WSR6MM	157-00283	117
WSR8MM	157-00036	118
WSRFT9A	156-00070	102
WSRFT9B	156-00074	102
WSS	111-12300	46
WSS10MM	157-00284	118
WSS250	157-00400	117
WSS380	157-00403	117
WSS6MM	157-00281	117
WSS8MM	157-00034	117
WSSFT9A	156-00068	102
WSSFT9B	156-00072	102
WTOPVLBL	596-00235	453
WTOPVLBL	596-00499	453
WTOPVLBL10	596-00664	463
WTOPVLBLM5	596-00832	449
WV275X135	596-00378	403
WV55X275	596-00376	403
YCCFT62x122	151-00180	188
YCC-FT6-S	155-38102	189
YCCSFT62x122PT0.7-1.3	151-00835	189

Type	Part No.	Page
YCCSFT62x122PT0.7-1.3 90°	151-00833	189
YCCSFT62x122PT1.7-2.3	151-00836	189
YCCSFT62x122PT1.7-2.3 90°	151-00834	189
YCCSFT62122	151-00513	188



HellermannTyton is your partner for close, onsite collaboration

We meet growing global challenges by being everywhere our clients are. Our people speak your language, not just literally, but when it comes to developing better solutions and optimizing processes. We want you to be able to provide your customers with the best results.



Stay in touch with us!





MADE FOR REAL[®]

HellermannTyton

HellermannTyton North American Corporate Headquarters

7930 N. Faulkner Rd, PO Box 245017

Milwaukee, WI 53224-9517

Phone: (414) 355-1130, (800) 537-1512

Fax: (414) 355-7341, (800) 848-9866

email: corp@htamericas.com

www.hellermann.tyton.com

IATF 16949, AS9100, ISO 9001 and ISO14001 certified

HellermannTyton Canada

Unit #4, 205 Industrial Parkway North

Aurora, Ontario L4G 4C4 Canada

Phone: (800) 661-2461

Fax: (800) 390-3904

email: sales@hellermanntyton.ca

HellermannTyton Mexico

Anillo Periferico Sur 7980 Edificio 6A

Parque Industrial Tecnologico II

Santa María Tequepexpan

Tlaquepaque, Jalisco, Mexico 45601

Phone: 011-52-33-3-133-9880

Fax: 011-52-33-3-133-9861

email: info@htamericas.com.mx

ISO 9001 certified