



PRO SERIES

INPULSE+

Multi-Biometric Finger Vein & Fingerprint Access Control Reader

inPulse+ is a multi-biometric reader capable of capturing and processing BOTH finger vein pattern & fingerprint biometric data at the same time.



Biometric Performance:

Combines revolutionary SilkID fingerprint sensor and powerful finger vein pattern sensor to achieve the highest degree of accuracy. Identifies users in less than 2 seconds.



Easy Operation and Management:

Works without a computer. Complete setup and programming can be done via the "inPulse+ keypad and embeded firmware. Audio-Visual indication for acceptance and rejection of valid/invalid fingerprints, cards and passwords.



Communication:

Weigand output for when connecting to an access control panel and Ethernet port for fast and reliable network communication.

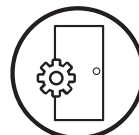

Access control:

Relay Outputs for electric lock and alarm. Inputs for door status sensor and request to exit hardware. Supports multiple time zones and personnel groups for programming valid entry zones.



Capacity:

Stores up to 1,000 finger vein and 1,000 fingerprint templates. Data can be backed up to a USB flash drive and transferred to another inPulse+ in the absence of network connectivity.



Options:

Internal Proximity Card reader allows dual factor authentication for access control.



For Software Developers:

Free SDK and development tools are available for developers/partners who wish to integrate inPulse+ with any application which requires verifying people. Custom development is also available for OEM partners upon request.

CONFIGURATION

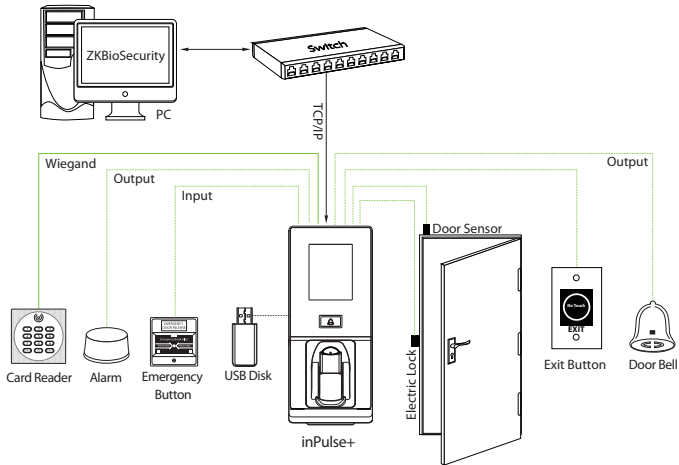

DIMENSIONS

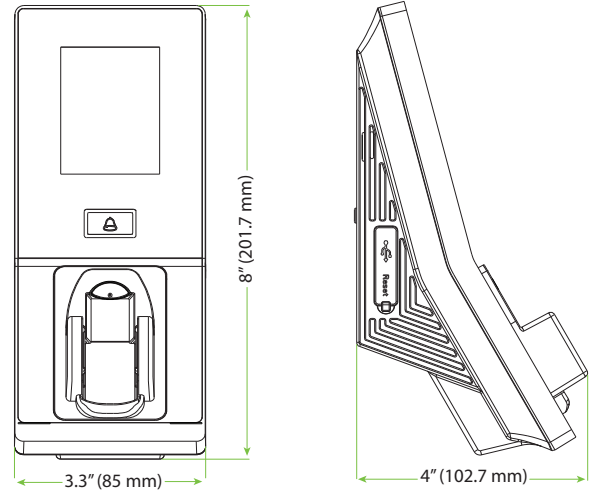

SPECIFICATIONS

Capacity

Finger Veins: 1,500
 Fingerprints: 1,500
 Cards: 2,000

Access Control Interface

Lock Relay Output
 Alarm Output/Auxiliary
 Input Exit Button/Door
 Sensor Doorbell Output

Communication

TCP/IP
 USB Host
 Wiegand Input/Output

Hardware

ZK Fingerprint Sensor
 2.8 Inch TFT-LCD Touch
 Screen 125 kHz ZKAccess Card
 Reader Tamper Switch Alarm

Standard Functions

Access Levels/Groups/
 Holidays DST/Bell Schedule
 Duress Mode (Password)
 Anti-Passback
 Record Query
 Custom Wallpaper & Screen
 Saver

Software Compatibility

ZKBioSecurity

Additional Info

Working Temperature:
 14° F to 122° F (-10° C to 50°
 C) Dimensions: 8 x 3.3 x 4
 inches Package Includes:
 12V 3A Power Supply

Power

Operating Voltage 12V DC
 Current Draw < 500mA

Part Numbers

inPulse+
 includes ZKAccess card
 reader

inPulse+ HID
 includes HID 125 kHz card
 reader

inPulse+ iClass
 includes HID iClass card
 reader

WHAT'S IN THE BOX

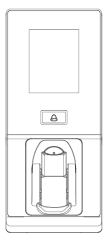

inPulse+



Installation
 Template

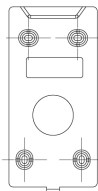

Back Plate

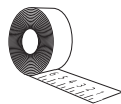

Measuring Tape

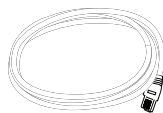

Network Cable



Screws

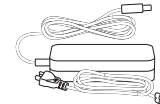

AC Power Adapter

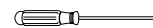

Screwdriver



Cables

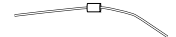

Diode