

REJECT FILTER

769-775 & 799-809 & 851-854MHz

Product Features

- Compact, low weight
- Low PIM
- High reliability

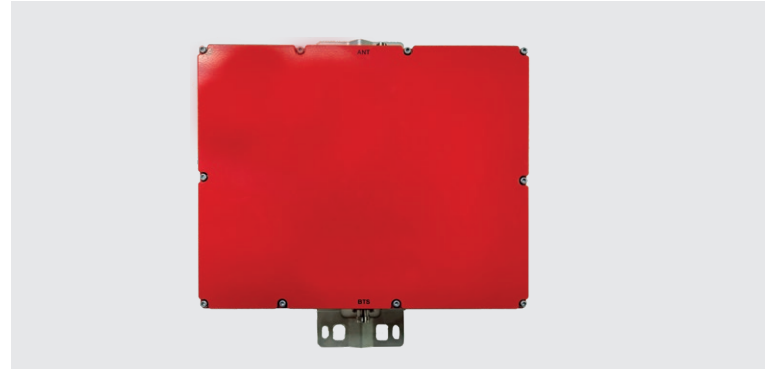

Electrical Specification	Value
Frequency	769-775 & 799-809 & 851-854MHz
Return Loss/VSWR	≤-19dB/1.25
Insertion loss	≤2.0dB
Out-of-band Rejection	≥30dBc @DC-767MHz ≥30dBc @777-797MHz ≥30dBc @810-849MHz ≥30dBc @855-2200MHz
Power handling	30 W AVG (100W Peak)
Intermodulation (9rd order)	≤ -150dBc @ 2 x 20 W
Impedance	50 Ohms

Environmental Specification	Value
Operating temperature range	-20°C to +65°C
Storage temperature range	-40°C to +85°C
Relative humidity	5% - 95%
Barometric pressure	55 KPa -106KPa
Lightening Protection (all ports)	3kA 10/350us, 8kA 8/20 us
Applications	IP67

Mechanical Specification	Value
Connectors type	N Female
Weight	7Kg
Outer Dimension(mm)	339*272*65.5mm(excluding Connectors and Brackets/Clamps)
Mounting	Brackets/Clamps for Ø40-115 mm Pole/Mast installation

REJECT FILTER

806-809 MHz & 851-854 MHz

Product Features

- Compact, low weight
- Low PIM
- High reliability



Electrical Specification	Value
Frequency	806-809 MHz & 851-854 MHz
Return Loss/VSWR	≤-19dB/1.25
Insertion loss	≤2.0dB
Out-of-band Rejection	30dBc @810-849&855-869MHz
Power handling	30 W AVG (100W Peak)
Intermodulation (9rd order)	≤ -150dBc @ 2 x 20 W
Impedance	50 Ohms

Environmental Specification	Value
Operating temperature range	-20°C to +65°C
Storage temperature range	-40°C to +85°C
Relative humidity	5% - 95%
Barometric pressure	55 KPa -106KPa
Lightening Protection (all ports)	3kA 10/350us, 8kA 8/20 us
Applications	IP67

Mechanical Specification	Value
Connectors type	N Female
Weight	6Kg
Outer Dimension(mm)	303*273*65.5mm(excluding Connectors and Brackets/Clamps)
Mounting	Brackets/Clamps for Ø40-115 mm Pole/Mast installation

REJECT FILTER

806-809 MHz & 851-854 MHz

BDA-FBPS-03

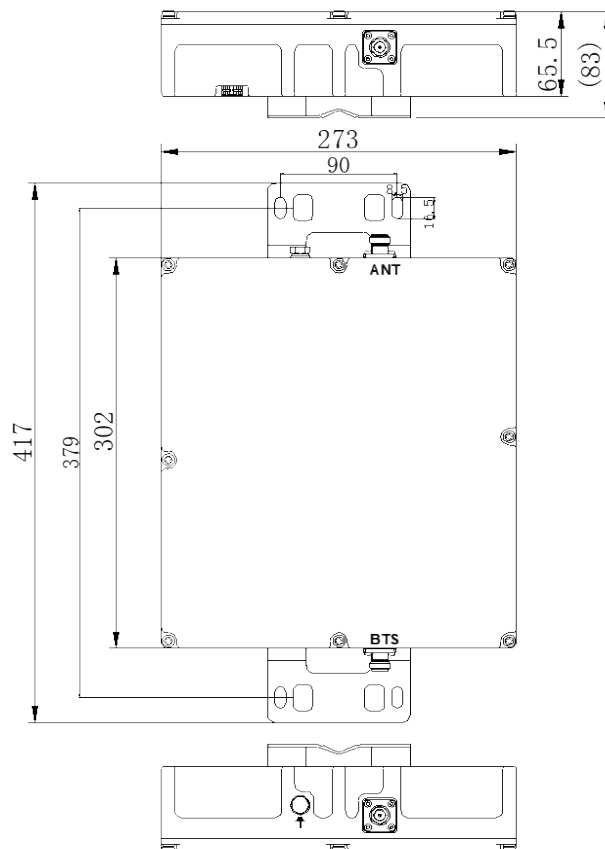
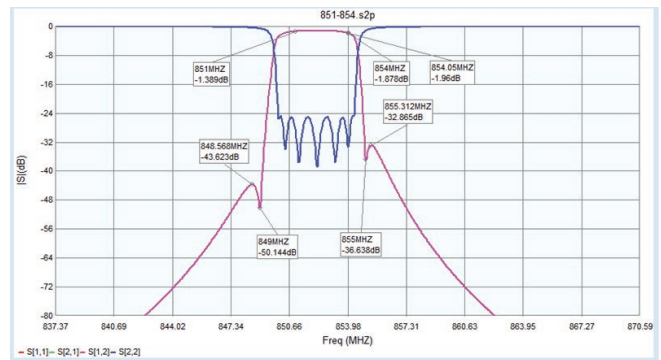
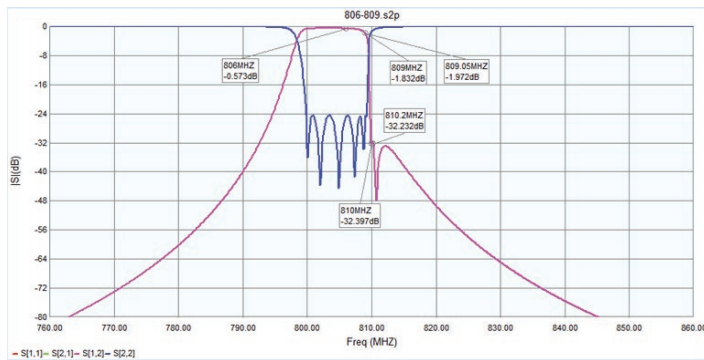

REJECT FILTER

769-775 & 799-816 & 851-861MHz

Product Features

- Compact, low weight
- Low PIM
- High reliability

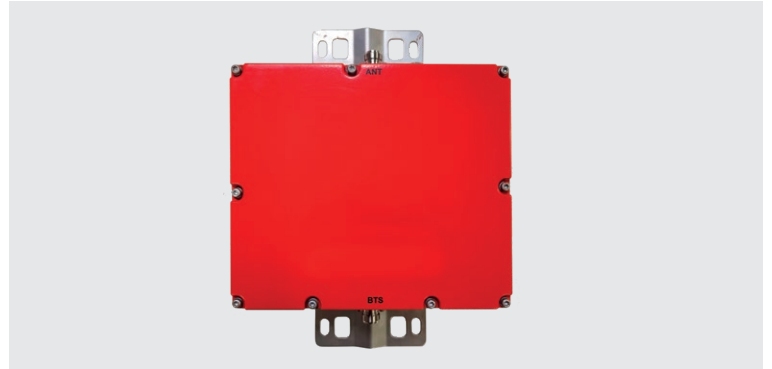

Electrical Specification	Value
Frequency	769-775 & 799-816 & 851-861 MHz
Return Loss/VSWR	≤-19dB/1.25
Insertion loss	≤2.0dB
Out-of-band Rejection	≥30dBc @DC-767MHz ≥30dBc @777-797MHz ≥30dBc @818-849MHz ≥30dBc @863-2200MHz
Power handling	150 W AVG (1500W Peak)
Intermodulation (9rd order)	≤ -150dBc @ 2 x 20 W
Impedance	50 Ohms

Environmental Specification	Value
Operating temperature range	-20°C to +65°C
Storage temperature range	-40°C to +85°C
Relative humidity	5% - 95%
Barometric pressure	55 KPa -106KPa
Lightening Protection (all ports)	3kA 10/350us, 8kA 8/20 us
Applications	IP67

Mechanical Specification	Value
Connectors type	N Female
Weight	5Kg
Outer Dimension(mm)	224*193*55.5mm(excluding Connectors and Brackets/Clamps)
Mounting	Brackets/Clamps for Ø40-115 mm Pole/Mast installation

REJECT FILTER

769-775 & 799-816 & 851-861MHz

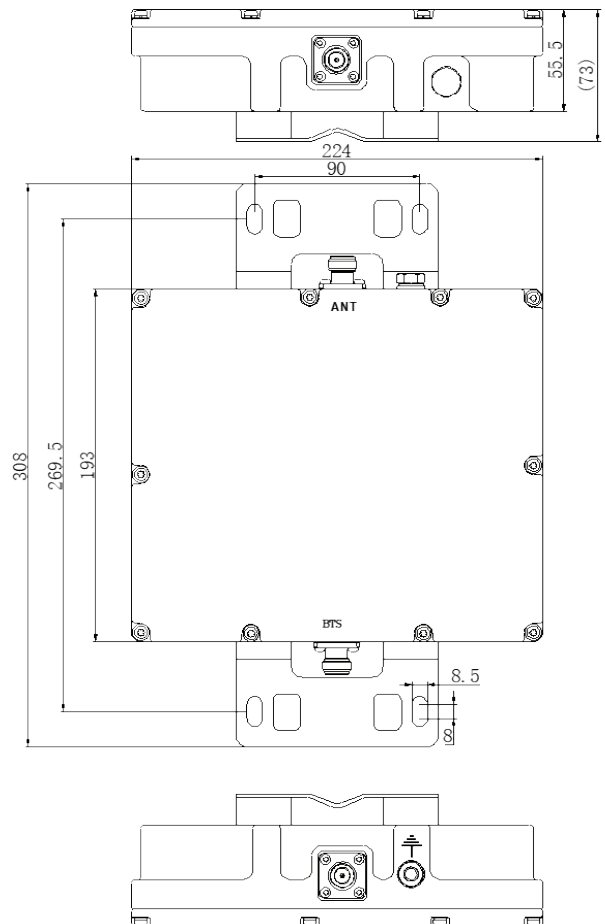
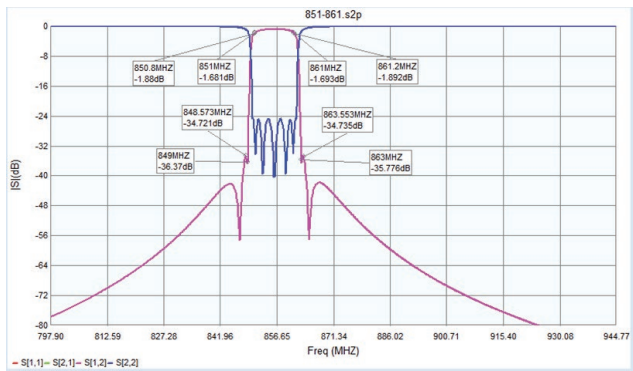
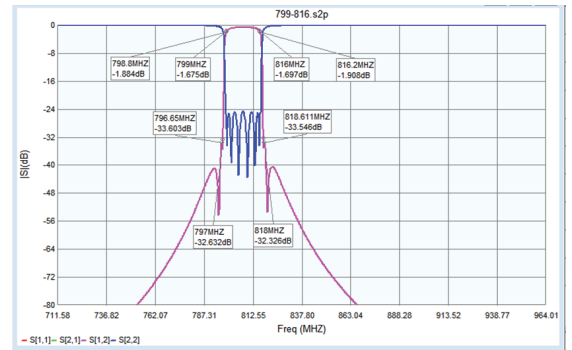
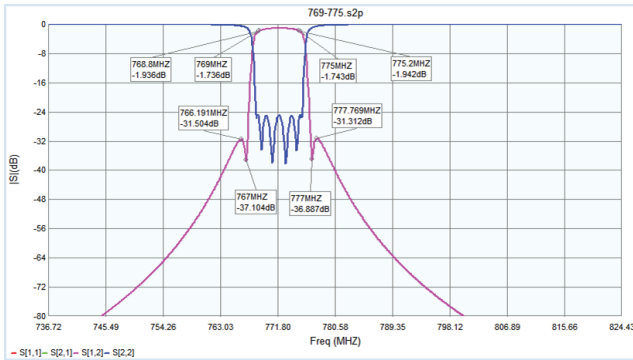

REJECT FILTER

806-816 MHz & 851-861 MHz

Product Features

- Compact, low weight
- Low PIM
- High reliability

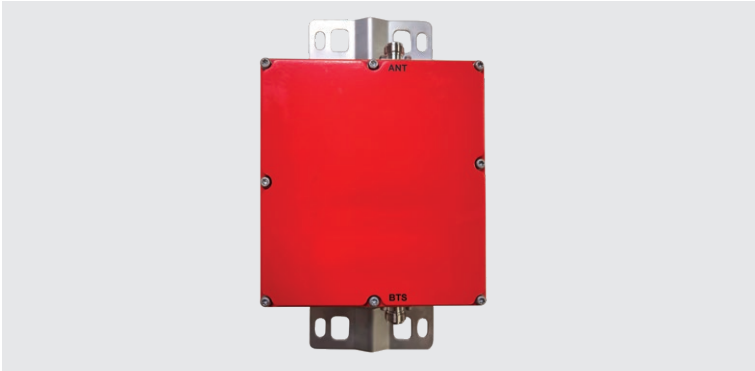

Electrical Specification	Value
Frequency	806-816 MHz & 851-861 MHz
Return Loss/VSWR	≤-19dB/1.25
Insertion loss	≤2.0dB
Out-of-band Rejection	30dBc @818-849&863-869MHz
Power handling	150 W AVG (1500W Peak)
Intermodulation (9rd order)	≤ -150dBc @ 2 x 20 W
Impedance	50 Ohms

Environmental Specification	Value
Operating temperature range	-20°C to +65°C
Storage temperature range	-40°C to +85°C
Relative humidity	5% - 95%
Barometric pressure	55 KPa -106KPa
Lightening Protection (all ports)	3kA 10/350us, 8kA 8/20 us
Applications	IP67

Mechanical Specification	Value
Connectors type	N Female
Weight	3.5Kg
Outer Dimension(mm)	174*158*55.5mm(excluding Connectors and Brackets/Clamps)
Mounting	Brackets/Clamps for Ø40-115 mm Pole/Mast installation

REJECT FILTER

806-816 MHz & 851-861 MHz

BDA-FBPS-10

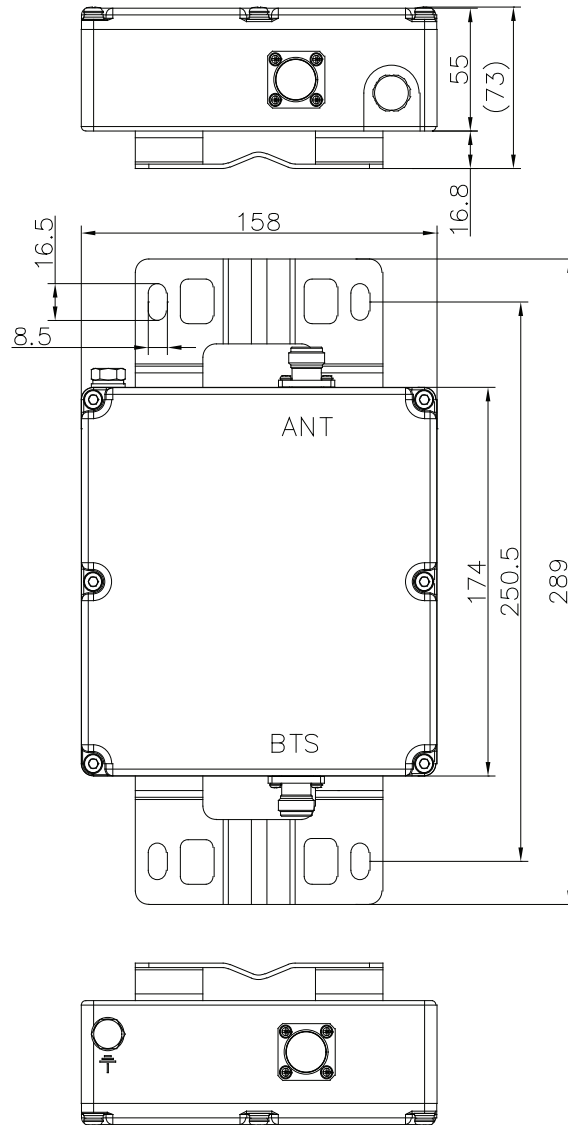
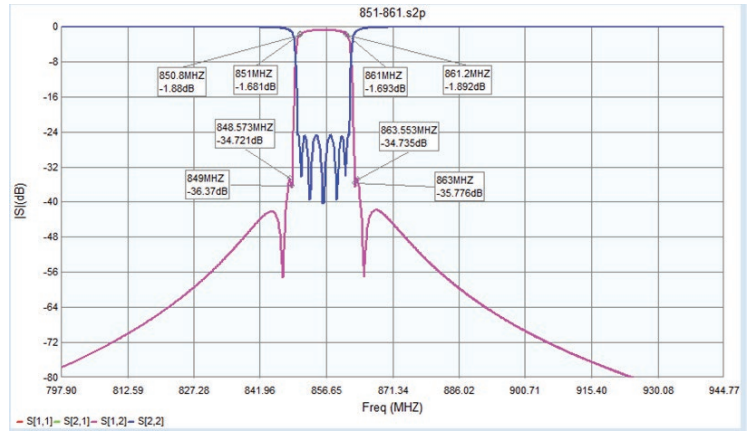
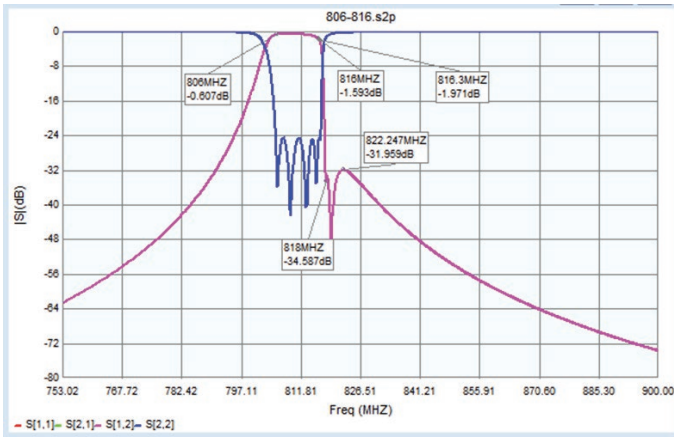

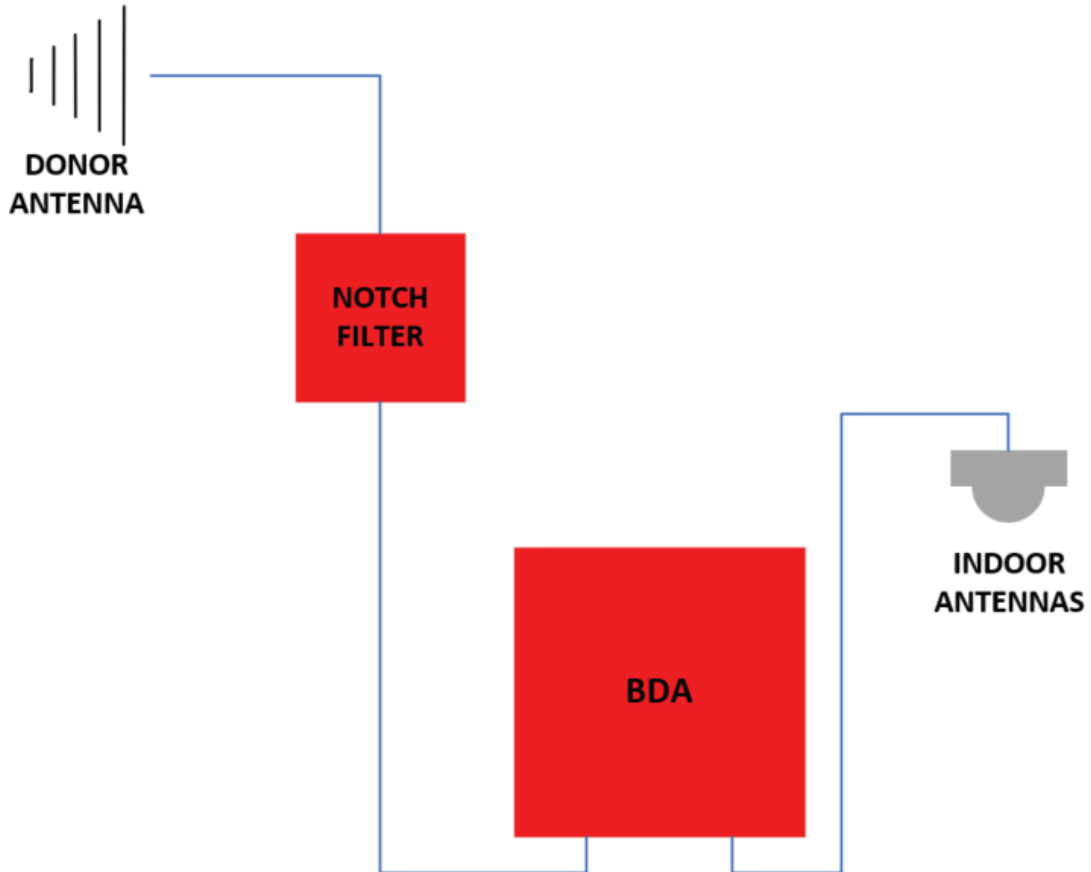

DOC HON-62143.01 • 06222022 • DM