

# HITACHI

Inspire the Next



## PREMISE & FIBER OPTIC CABLE CATALOG

# PREMISE & FIBER OPTIC CABLE

Since 1986, Hitachi Cable has been developing technologically advanced copper and fiber optic communication cables. Our dedication to engineering perfection is evident in the consistent quality and performance of all the cable products we manufacture. Through the development of high-performance cable products, such as the world's first UL verified 10-gigabit Ethernet Category 6A cable, Hitachi Cable has established itself as a leader in the industry. These products and the others found in this catalog are the result of Hitachi Cable's relentless desire to manufacture the finest communication cables in the world. After using our products, we are confident you will agree.

## Trademarks Referenced In This Catalog:

Power+™, Plus™, XST™, Supra™, Supra 10G™, Supra 10G-XE™, and 350™ are trademarks of Hitachi Cable America Inc.

DryBit® and Nanocore® are registered trademarks of Hitachi Cable America Inc.

MTP® is a registered trademarks of US Conec Ltd.

Corning® and ClearCurve® are registered trademarks of Corning Incorporated.

**HITACHI**  
Inspire the Next

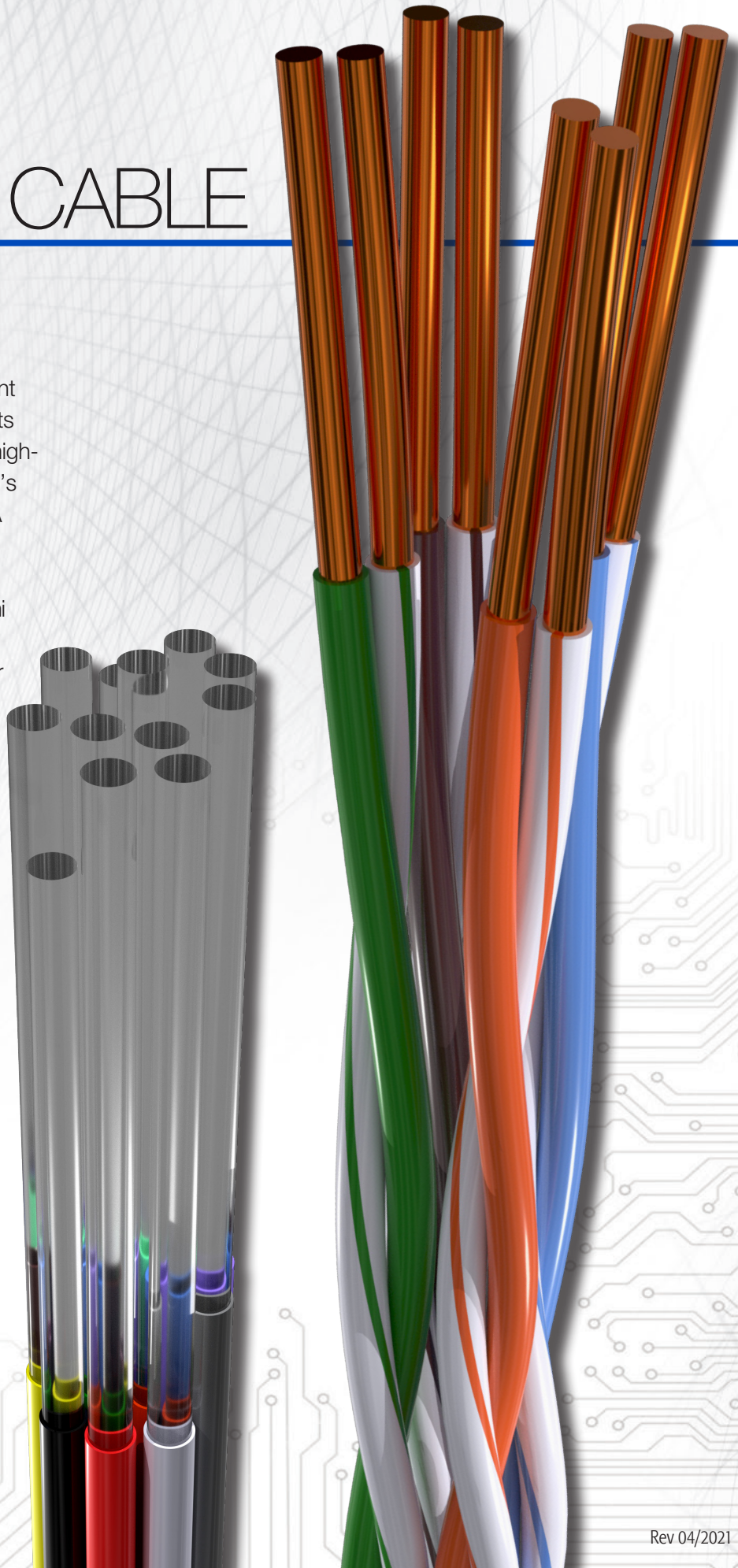

# Table of Contents

<b>INTRO</b>	HCA Overview	<b>4</b>
	Other HCA Products	<b>8</b>
<b>COPPER</b>	Indoor Copper Solutions	<b>10</b>
	Category 6A Copper	<b>10</b>
	Category 6 Copper	<b>16</b>
	Category 5e Copper	<b>26</b>
	Category 7A Copper	<b>34</b>
	Category 7 Copper	<b>36</b>
	Multi-Pair Copper	<b>38</b>
	Indoor / Outdoor Copper Solutions	<b>42</b>
	Category 6A DryBit	<b>42</b>
	Category 6 DryBit	<b>44</b>
	Outdoor Copper Solutions	<b>46</b>
Category 6A Copper	<b>46</b>	
Category 6 Copper	<b>50</b>	
Category 5e Copper	<b>52</b>	
<b>FIBER</b>	Fiber Selection Guide	<b>54</b>
	Indoor Fiber Solutions	<b>56</b>
	Interconnect	<b>56</b>
	Single-Unit	<b>62</b>
	Multi-Unit	<b>66</b>
	Nanocore® Micro Distribution	<b>70</b>
	Nanocore® CPR Listed Micro Distribution	<b>78</b>
	Nanocore® Armored Micro Distribution	<b>80</b>
	Armored Tight Buffered	<b>84</b>
	Indoor / Outdoor Fiber Solutions	<b>88</b>
	Tight Buffered	<b>88</b>
	Armored Tight Buffered	<b>92</b>
	Outdoor Fiber Solutions	<b>94</b>
Non-Armored Loose Tube	<b>94</b>	
Armored Loose Tube	<b>96</b>	
<b>HYBRID</b>	Indoor / Outdoor Hybrid Solutions	<b>98</b>
	Power+™ Composite	<b>98</b>
<b>REFERENCE</b>	Color Codes	<b>100</b>
	Code References	<b>101</b>
	Applications	<b>102</b>
	Standards and Configurations	<b>104</b>
	Glossary	<b>106</b>
	Part Number Reference	<b>110</b>
	Installation Reference and Cable Ampacity chart	<b>115</b>



**Hitachi Cable America has a long history** of designing innovation into our cables. All of our designs are carefully engineered for peak performance, ease of use, and reliability. We go to great lengths to ensure our products surpass our customers expectations.

### Hitachi's Manufacturing Advantage

Hitachi Cable America (HCA) never stops innovating. Whether it's installing the very latest in cable manufacturing technology, or designing and building custom equipment for a one of a kind cable, HCA has the resources to maintain a technological edge over the competition. We are ISO certified 9001-2015, so you can be confident that all of our processes and materials are properly tracked and recorded.

### On-site Copper Extrusion

The Manchester, NH facility is one of a handful of cable manufacturing facilities in the U.S. that performs on-site drawing of copper. When drawing copper, Hitachi Cable starts with 13 AWG solid copper conductor on custom built deploying devices, called Stems. The copper is pulled into the drawing mills where it is reduced to the appropriate size, conditioned in what is called the annealing process, then insulated with the appropriate insulation. Drawing our own copper allows us to better control the performance of the primary conductors and maximize overall cable performance.



### Better Materials and Practices for a Better Earth

All the products manufactured within our facility are compliant to EU Directive 2011/65/EU, also known as the Restriction of Hazardous Substances (RoHS2) which regulates the use of harmful materials such as lead, cadmium and mercury. All products are also REACH compliant. REACH (Registration, Evaluation, Authorization and Restriction of Chemicals), formerly referred to as EC 1907/2006, identifies multiple chemicals that have been found harmful to people and/or the environment. HCA endeavors to be compliant to any and all environmental regulations as soon as possible and typically prior to their formal release.

HCA has also made advancements in waste reduction in both the raw materials used and the packaging. Since program inception, the facility has reduced landfill bound waste by 90% and dramatically increased recycling efforts. In addition, Manchester significantly reduced the facilities carbon footprint and eliminated the monthly use of over 1,800 pounds of propane by converting its entire fork truck fleet from propane to electric.

### The Advantage of Hitachi's Cable Packaging

When it comes to the performance of our products, Hitachi doesn't just evaluate the cable, we also evaluate the package from which it is dispensed. Hitachi's easy-payout boxes for Category 5e and Category 6 cables consistently receive positive reviews from distributors and installers. Designed with direct input from users, our boxes feature dual reinforced handles, vibrant, easy-to-read graphics and have proven to be as durable as the cable they contain. The boxes also have a product specific conduit fill chart printed right on the back of the box. When it comes to reels, we only use the best sanded wooden reels and durable thick-gauge plastic reels. When transporting large reels, we go to great lengths to ensure our product arrives safely. We don't cut corners when it comes to packaging and it shows.

### New Products in Development

Hitachi and its significant research and development team are constantly releasing new products and developing future ones. As wireless applications and Power over Ethernet (PoE) grows in popularity, Ethernet cables are finding their way into a wide range of physical environments. From oil refineries in Mississippi to cell towers in Anchorage, Ethernet cables are being required to perform in some extremely harsh environments. To meet this growing need, Hitachi is constantly developing new cable constructions. Hitachi offers a vast selection of industrial Ethernet cables. Designs include high-temp shielded cables, oil and chemical resistant cables, high flex cables that can accommodate millions of flex cycles and tactical cables that are designed for extreme environments. To accommodate various Ethernet data rates a wide array of designs. These cables and more can be found in our Advanced Cabling Solutions catalog and on our website. With dozens of cable constructions available and more on the way, Hitachi Cable will have the solution you need.



# The Open System Architecture Solution

Whether you are installing the highest-performing Category copper cabling or fiber optic infrastructure, there are a number of well-known brands available to choose from. So, what makes one brand a wiser choice than another and which one offers maximum performance, while also providing the best value?

Open System Architecture (OSA) from Hitachi Cable America (HCA) provides world class performance using virtually any combination of HCA verified cables with verified connective hardware in the design of the network. The ANSI/TIA-568.2-D standard specifies the performance requirements of all network components and defines interoperability base-line limits to ensure that combinations of cable with connectivity will meet or exceed the system's intended application. By employing a Hitachi OSA solution, end users have the freedom to choose from a wide range of quality connectivity products that best meet their specific needs and be confident that the chosen solution will support all applications designed to operate over that solution and be backed by our industry-leading lifetime warranty\*.

## Beyond-The-Link Building Systems

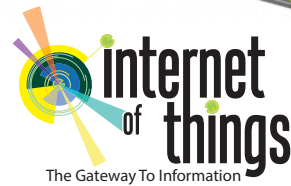
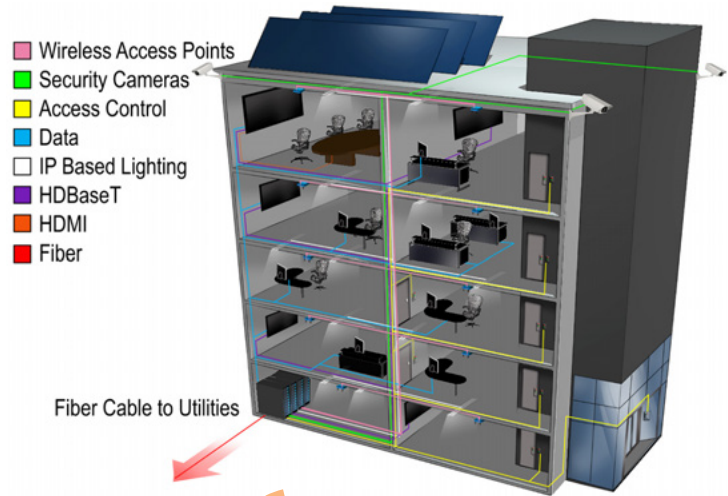

### Hitachi Open System Architecture

- Provides for standards-based verifiable cable performance
- Enables a range of connectivity options
- Opens up competitive solution offerings
- Delivers substantial benefits to the end user



### It's all in the Cable

In virtually all cable based communication links, it is the cable that determines the ultimate performance of that link. It is the cable, not the connectors, that establishes how well the applications will perform. This is the reason why many cable manufacturers make different performance levels of Category 6 cable while jack and plug manufacturers make only one jack or plug to mate to them. The desirable headroom that results from the link is provided by the cable. With a growing list of applications for category cables, many of them critical to a facility's operations, selecting a quality cable from an established manufacturer is recommended. Additionally, with an increase in counterfeit and unestablished brands flooding the market, it is important to protect your investment by sourcing only through trusted distribution channels.

### Cable is Key!

- Cable is the highest cost component of passive infrastructures
- Cable determines margin of performance headroom in the link and channel
- Cable vendor should be the lead warranty provider



\*Lifetime Warranty available only through Hitachi certified installers.



## Hitachi Cable Offers a LIFETIME WARRANTY

Hitachi Cable America (HCA) is pleased to offer a lifetime warranty on certified installations. The lifetime warranty, which is only available through Hitachi Cable Certified Installers and directly backed by HCA, offers a product performance and application assurance warranty. This means that we guarantee that the solution will pass the appropriate category test for the life of the network as well as support all applications designed to operate over that solution. The warranty covers both the cables and all the connective hardware directly attached to the HCA cables. It also includes any labor that could be associated with a warranty claim. Only a manufacturer with exceptional confidence in their products would offer a warranty like this.



### Hitachi Cable Warranted Systems feature:

- Compliance to TIA and ISO Cabling Standards
- Lifetime Product Performance Warranty
- Lifetime Applications Support Warranty
- Open Architecture Connectivity Specification
- One Point-of-Contact for all Warranty Features

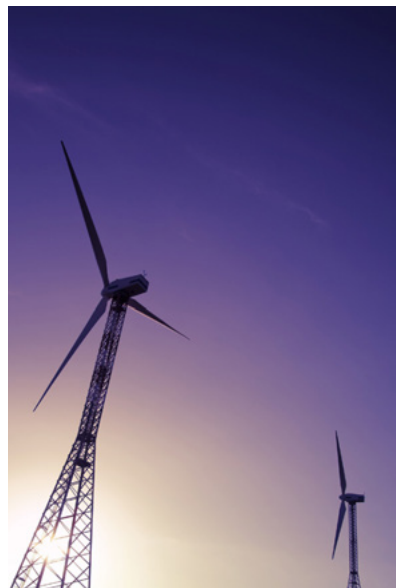



### Wireless

There are many cable solutions needed to provide a wireless infrastructure to our communities. We can design and build large gauge power wires, combined with fiber optic cables and data or control pairs, for the largest freestanding cell towers. Hitachi Cable America (HCA) provides 5G Small Cell / Distributed Antenna System (DAS) cabling solutions for outdoor venues to enable mobile vehicular communications, provide phone services at sporting events or deliver UL approved infrastructure designs for indoor spaces such as airports, malls, subway stations or skyscrapers.



### Transportation

Automotive, Rail & Rolling Stock, and Aerospace passenger safety are a primary design concerns for all transportation environments. We are material science experts and can offer guidance on cable and shielding designs to exceed U.S. and international aerospace, rapid transit / rail, and automotive standards and expectations. Flammability designs to comply with NFPA130-2010 standards or FAA regulations are part of our everyday design portfolio.



### Industrial / Robotics

Industrial / Robotics environments require innovation in design expertise. Data speed, flexibility, miniaturization, torsional control, flex life, environmental and chemical resistance are just a few of the characteristics that HCA offers in our portfolio of solutions. Thermoplastics, thermoset materials and fluoropolymers can be combined to deliver environment-suitable interconnect cable, connectors and assemblies, especially for Industrial Ethernet solutions. Robot designers rely on our low particulate, high flex flat interconnection cable and assembly solutions.



### Medical

Our Medical components include solutions for the surgical, catheter, endoscopy and ultrasound markets. Whether a cable, a multilumen catheter, a luer and hub PICC assembly, or ultrasound probe assembly, we can provide custom cables or tubes up to finished medical devices. With our global production and design centers, we can bring you from concept to high volume production wherever you are located.



### Oil / Gas / Mining / Energy

Cable applications for the energy sector require rugged designs, especially for fiber optic communications to survive wide temperature extremes. Mining in certain regions require regional approvals. From very large cables to small ultrasound cable assemblies for non-destructive pipeline testing, Hitachi can bring our years of design experience to your next project.



### Defense / Security

HCA has cables installed in a wide range of U.S. government and military facilities both domestically and abroad. With ruggedized, tactical cables for a variety of physical environments, shielded cables for secure data transmissions and composite cables for long distance CCTV applications, Hitachi's U.S. made cables deliver the performance and reliability required by our government agencies. Whether establishing a fiber optic link from one corner of the base to another or delivering 10 Gigabit Ethernet to the desktop, Hitachi has the solution.



### Building Infrastructure

High speed data communications in or between buildings requires both electrical design and material science expertise. Size, flammability and installation are all factors important to building designers. We offer low-smoke, non-halogen designs as well as UL approved Plenum / Riser rated designs in copper and fiber optics for a broad portfolio of building and Industrial communication applications.



### Data Center

Delivering many single mode fibers in a compact and rugged, easy to terminate cable for a mega data center is our normal mission. HCA offers HDMI, Ethernet, USB, DisplayPort cables to support applications within the data center and many mobile and robotics devices.





## Advanced Cabling Solutions

Hitachi Cable America (HCA) offers unique cabling solutions that provide superior performance for applications which may require power, data, video or control signals within a high performance small package. These designs can accommodate a variety of performance needs, such as, high flexibility, extended flex life, mechanical ruggedness, environmental resistance and cleanliness. With the ability to mix and match copper conductors, for data and power use, with fiber optics, gives designers the maximum configurability for advanced cabling solutions and assemblies. See Hitachi's Advanced Cabling Solutions catalog for more information.

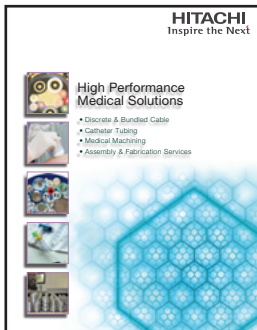

## Cabling Solutions for Medical

HCA offers a wide range of high-performance medical products for highly demanding and critical-to-care applications within the medical field and other non-medical markets. Our products and services are the backbone for customers that require a technological advantage for their next generation devices.



## ChannelFLEX® High Flex Flat Cabling

ChannelFLEX® is a unique cabling solution suitable for medical, semiconductor clean rooms and standard industrial applications requiring high flex and particulate free operation. The system permits the owner to safely run cables and/or hoses in flat pods, from Point A to Point B, without concerns of binding or kinking. ChannelFLEX® reduces installation time, minimizes cable related downtime and ensures maximum performance of the applications operating over it.

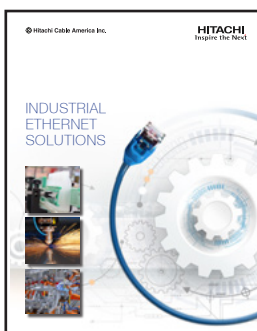

## Cabling Solutions for Industrial Ethernet

To accommodate a wide variety of applications, Hitachi Cable offers dozens of unique designs intended to meet your specific needs. From high-flex to static, solid conductor to stranded, high and low temperature, oil and chemical resistant, we have the right industrial Ethernet solution.

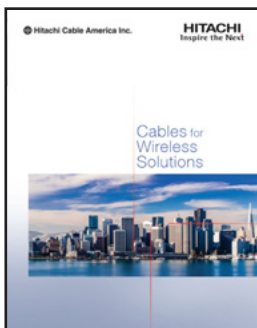

## Cabling Solutions for Wireless Applications

As more and more devices go wireless, the importance of the cable infrastructure supporting those wireless networks grows as well. Hitachi Cable manufactures fiber optic cables, coaxial cables, shielded and unshielded twisted pair cables and hybrid cables to support wireless applications, such as Distributed Antenna System (DAS) and Fiber to the Antenna (FTTA).

# Indoor

Enhanced UTP

Copper

## Product Highlights

- REACH & RoHS 2 compliant
- Made in U.S.A.
- UL Verified ANSI/TIA-568.2-D
- Low Smoke Plenum construction
- Tested from 1 to 660 MHz
- Small O.D. allows more cables per conduit
- Noise Control Barrier (NCB™) technology allows for a reduced outside diameter and electrical performance that is superior to discontinuous shield designs
- UL Tested (LP) for maximum power support

TIA Parameter	Guaranteed Headroom
PSANEXT loss	+6 dB
PSACRF	+6 dB

## Packaging

- 1,000 feet (305 m)
- Reverse sequential footage markings standard on each 1,000 foot package
- Unit/pallet: 12 Reels  
 CMP Carton Weight (lbs): 43.64  
 CMP Product Weight (lbs): 40.34  
\*weight may vary, call for CMR information

## Applications

- Including:
  - HDBase-T A & B
  - 10 Gigabit Ethernet (IEEE 802.3an)
  - 5 Gigabit Ethernet (IEEE 802.3bz)
  - 2.5 Gigabit Ethernet (IEEE 802.3bz)
  - Gigabit Ethernet (IEEE 802.3ab)
  - 100 Mbps Ethernet (IEEE 802.3u)
  - 1000 Mbps ATM
  - 622 Mbps ATM
  - 15W PoE (IEEE 802.3af)
  - 30W PoE+ (IEEE 802.3at)
  - 60W PoE++ (IEEE 802.3bt Type 3)
  - 100W PoE++ (IEEE 802.3bt Type 4)

## Temp. Range

- Storage Temperature
  - 40°C to +60°C
  - (-40°F to +140°F)
- Installation Temperature
  - 0°C to +60°C
  - (+32°F to +140°F)
- Operation Temperature
  - Plenum**
  - 20°C to +90°C
  - (-4°F to +194°F)
  - Riser/Low Smoke Halogen Free**
  - 20°C to +75°C
  - (-4°F to +167°F)

## Supra 10G-XE (Plenum)

c(UL)us Listed Type CMP (NFPA 262), CSA Type FT6

PART #	# OF PAIRS	CALCULATED CABLE O.D.		CABLE WEIGHT	
		inches	mm	lbs/1000 ft	kg/305 m
30303-8-XXY	4	0.250	6.35	34.60	15.69

## Supra 10G-XE (Riser)

c(UL)us Listed Type CMR (UL 1666), CSA Type FT4

PART #	# OF PAIRS	CALCULATED CABLE O.D.		CABLE WEIGHT	
		inches	mm	lbs/1000 ft	kg/305 m
30304-8-XXY	4	0.275	6.985	39.02	17.70

## Supra 10G-XE (Riser-Low Smoke Zero Halogen Jacket)

c(UL)us Listed Type CMR (UL1666), CSA Type FT4

PART #	# OF PAIRS	CALCULATED CABLE O.D.		CABLE WEIGHT	
		inches	mm	lbs/1000 ft	kg/305 m
30295-8-XXY	4	0.28	7.11	39.02	17.70

## Building a Part Number

Base Part Number	Ex.	No. of Conductors	Jacket Color	Reel Type
30303		8	XX	Y

Jacket Colors (XX):

Black (BK); Blue (BL); Brown (BR); Gray (GA); Green (GR); Red (RD); White (WH); Violet (VI); Yellow (YE)

Reel Type (Y):

Reels (3); Reel-in-a-box (4)

## Features



### PAIR DETAIL

### DIELECTRIC MATERIALS

#### PLENUM

Primary Insulation: Plenum-rated fluoropolymer  
 Overall Jacket: Low-smoke, flame-retardant thermoplastic  
 Star Filler: Plenum-rated polymer

#### RISER

Primary Insulation: Polyolefin  
 Overall Jacket: Flame-retardant Thermoplastic  
 Star Filler: Flame-retardant Thermoplastic

Hitachi Cable America reserves the right to revise any specifications.

# Cat 6A Supra 10G-XE™

## Transmission Specifications ANSI/TIA-568.2-D Category 6A Verified ISO/IEC 11801, 2nd ed. Class EA Compliant

	Ins. Loss	NEXT	PSNEXT	ACR	PSACR	ACRF	PSACRF	Return Loss	PSANEXT	PSANEXT	PSAACRF	PSAACRF
Freq. (MHz)	Max.	Min.	Min.	Min.	Min.	Min.	Min.	Min.	TIA Std.	Min	TIA Std.	Min
1	2.1	74.3	72.3	72.2	70.2	67.8	64.8	20.0	67.0	73.0	67.0	73.0
4	3.8	65.3	63.3	61.5	59.5	55.8	52.8	23.0	67.0	73.0	66.2	72.2
8	5.3	60.8	58.8	55.4	53.4	49.7	46.7	24.5	67.0	73.0	60.1	66.1
10	5.9	59.3	57.3	53.4	51.4	47.8	44.8	25.0	67.0	73.0	58.2	64.2
16	7.5	56.2	54.2	48.8	46.8	43.7	40.7	25.0	67.0	73.0	54.1	60.1
20	8.4	54.8	52.8	46.4	44.4	41.8	38.8	25.0	67.0	73.0	52.2	58.2
25	9.4	53.3	51.3	44.0	42.0	39.8	36.8	2.3	67.0	73.0	50.2	56.2
31.25	10.5	51.9	49.9	41.4	39.4	37.9	34.9	23.6	67.0	73.0	48.3	54.3
62.5	15.0	47.4	45.4	32.4	30.4	31.9	28.9	21.5	65.6	71.6	42.3	48.3
100	19.1	44.3	42.3	25.2	23.2	27.8	24.8	20.1	62.5	68.5	38.2	44.2
155	24.1	41.4	39.4	17.4	15.4	24.0	21.0	18.8	59.6	65.6	34.4	40.4
200	27.6	39.8	37.8	12.2	10.2	21.8	18.8	18.0	58.0	64.0	32.2	38.2
250	31.1	38.3	36.3	7.3	5.3	19.8	16.8	17.3	56.5	62.5	30.2	36.2
300	34.3	37.1	35.1	2.9	0.9	18.3	15.3	16.8	55.3	61.3	28.7	34.7
350	37.2	36.1	34.1	-	-	16.9	13.9	16.3	54.3	60.3	27.3	33.3
400	40.1	35.3	33.3	-	-	15.8	12.8	15.9	53.5	59.3	26.2	32.2
500	45.3	33.8	31.8	-	-	13.8	10.8	15.2	52.0	58.0	24.2	30.2
555*	47.9	33.1	31.1	-	-	12.9	9.9	14.9	51.3	57.3	23.3	29.3
660*	52.8	32.0	30.0	-	-	11.4	8.4	14.4	50.2	56.2	21.8	27.8

\*Frequencies beyond the TIA and ISO requirements are for information only. All values are dB/100m.

Photo is for representation purposes only.



Copper

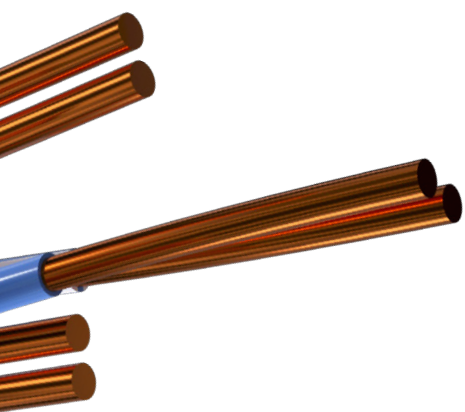

## Electrical Characteristics

Input Impedance:	100 ± 15Ω (1.0 to 100 MHz) 100 ± 20Ω (100 to 250 MHz) 100 ± 25Ω (251 to 500 MHz)
Maximum Resistance Unbalance:	3%
Maximum Capacitance Unbalance:	330 pF/100 meters
Maximum Delay Skew:	45 ns/100 meters
Nominal Velocity Of Propagation (Nvp):	70%, Plenum 68%, Riser
Voltage Rating:	300 Volts
LP Rating (UL) - CMP	0.6 Amps/conductor

Cable Ampacity Chart														
Bundle Size	1		2-7		8-19		20-37		38-61		62-91		92-192	
	75°C	90°C	75°C	90°C	75°C	90°C	75°C	90°C	75°C	90°C	75°C	90°C	75°C	90°C
23 AWG	2.5	2.5	1.5	1.7	1.1	1.7	0.8	0.9	0.7	0.8	0.7	0.8	0.5	0.6

The table above is derived from the one approved by the National Fire Protection Agency and used in the National Electrical Code, NFPA-70. The complete table can be found in sections 725.144 and 800 Communication Circuits of the code. The table identifies the ampacity of each conductor (in amperes) in a 4-pair Class 2 or Class 3 data cable. Ambient temperature used for development of the table is 30°C (86°F) with all conductors in all cables carrying current. The table is based on 60°C (140°F), 75°C (167°F) and 90°C (194°F) rated cables. All cable temps are operational temp ratings. Cables with temp ratings above 90c would deliver additional power handling capacity.

# Indoor

Enhanced F/UTP

Copper

## Product Highlights

- REACH & RoHS 2 compliant
- Made in U.S.A.
- UL Verified
- Low Smoke Plenum construction.
- Tested from 1 to 660 MHz
- Small O.D. allows more cables per conduit
- Proven shield technology improves RFi, EMI and alien crosstalk performance

## Packaging

- 1,000 foot (305 m) reels
- Reverse sequential footage markings standard on each 1,000 foot package
- Unit/pallet: 12  
 CMP Carton Weight (lbs): 43.64  
 CMP Product Weight (lbs): 40.34  
\*weight may vary, call for CMR information

## Options

- Available in LSZH

## Applications

- Including:
  - HDBase-T A & B
  - 10 Gigabit Ethernet (IEEE 802.3an)
  - 5 Gigabit Ethernet (IEEE 802.3bz)
  - 2.5 Gigabit Ethernet (IEEE 802.3ab)
  - 100 Mbps Ethernet (IEEE 802.3u)
  - 1000 Mbps ATM
  - 622 Mbps ATM
  - 15W PoE (IEEE 802.3af)
  - 30W PoE+ (IEEE 802.3at)
  - 60W PoE++ (IEEE 802.3bt Type 3)
  - 100W PoE++ (IEEE 802.3bt Type 4)

## Temp. Range

- Storage Temperature  
 -40°C to +60°C  
 (-40°F to +140°F)
- Installation Temperature  
 0°C to +60°C  
 (+32°F to +140°F)
- Operation Temperature  
 -20°C to +75°C  
 (-4°F to +167°F)

## Supra 10G 6A F/UTP (Plenum)

c(UL)us Listed Type CMP (NFPA 262), CSA Type FT6

PART #	# OF PAIRS	CALCULATED CABLE O.D.		CABLE WEIGHT	
		inches	mm	lbs/1000 ft	kg/305 m
30233-8-XXY	4	0.275	6.98	40.34	18.29

## Supra 10G 6A F/UTP (Riser-Low Smoke Zero Halogen)

c(UL)us Listed Type CMR (UL 1666), CSA Type FT4

PART #	# OF PAIRS	CALCULATED CABLE O.D.		CABLE WEIGHT	
		inches	mm	lbs/1000 ft	kg/305 m
30234-8-XXY	4	0.28	7.11	39.02	17.70

## Building a Part Number

Base Part Number Ex.	No. of Conductors	Jacket Color	Reel Type
30233	8	XX	Y

Jacket Colors (XX):

Black (BK); Blue (BL); Brown (BR); Gray (GA); Green (GR); Red (RD); White (WH); Yellow (YE)

Reel Type (Y):

Reels (3)

## Features



### DIELECTRIC MATERIALS

#### PLENUM

Primary Insulation: Plenum-rated fluoropolymer  
 Overall Jacket: Low-smoke, Flame-retardant Thermoplastic  
 Star Filler: Plenum-rated polymer

#### RISER

Primary Insulation: Polyolefin  
 Overall Jacket: Flame-retardant Thermoplastic  
 Star Filler: Flame-retardant Thermoplastic

Hitachi Cable America reserves the right to revise any specifications.

# Cat 6A Supra 10G™ F/UTP

## Transmission Specifications

ANSI/TIA-568.2-D Category 6A Verified  
ISO/IEC 11801, 2nd ed. Class EA Compliant

	Ins. Loss	NEXT	PSNEXT	ACR	PSACR	ACRF	PSACRF	Return Loss	PSANEXT	PSANEXT	PSAACRF	PSAACRF
Freq. (MHz)	Max.	Min.	Min.	Min.	Min.	Min.	Min.	Min.	TIA Std.	Min	TIA Std.	Min
1	2.1	74.3	72.3	72.2	70.2	67.8	64.8	20.0	67.0	73.0	67.0	73.0
4	3.8	65.3	63.3	61.5	59.5	55.8	52.8	23.0	67.0	73.0	66.2	72.2
8	5.3	60.8	58.8	55.4	53.4	49.7	46.7	24.5	67.0	73.0	60.1	66.1
10	5.9	59.3	57.3	53.4	51.4	47.8	44.8	25.0	67.0	73.0	58.2	64.2
16	7.5	56.2	54.2	48.8	46.8	43.7	40.7	25.0	67.0	73.0	54.1	60.1
20	8.4	54.8	52.8	46.4	44.4	41.8	38.8	25.0	67.0	73.0	52.2	58.2
25	9.4	53.3	51.3	44.0	42.0	39.8	36.8	24.3	67.0	73.0	50.2	56.2
31.25	10.5	51.9	49.9	41.4	39.4	37.9	34.9	23.6	67.0	73.0	48.3	54.3
62.5	15.0	47.4	45.4	32.4	30.4	31.9	28.9	21.5	65.6	71.6	42.3	48.3
100	19.1	44.3	42.3	25.2	23.2	27.8	24.8	20.1	62.5	68.5	38.2	44.2
155	24.1	41.4	39.4	17.4	15.4	24.0	21.0	18.8	59.6	65.6	34.4	40.4
200	27.6	39.8	37.8	12.2	10.2	21.8	18.8	18.0	58.0	64.0	32.2	38.2
250	31.1	39.3	36.3	7.3	5.3	19.8	16.8	17.3	56.5	62.5	30.2	36.2
300	34.3	37.1	35.1	2.9	0.9	18.3	15.3	16.8	55.3	61.3	28.7	34.7
350	37.2	36.1	34.1	-	-	16.9	13.9	16.3	54.3	60.3	27.3	33.3
400	40.1	35.3	33.3	-	-	15.8	12.8	15.9	53.5	59.3	26.2	32.2
500	45.3	33.8	31.8	-	-	13.8	10.8	15.2	52.0	58.0	24.2	30.2
555*	47.9	33.1	31.1	-	-	12.9	9.9	14.9	51.3	57.3	23.3	29.3
660*	52.8	32.0	30.0	-	-	11.4	8.4	14.4	50.2	56.2	21.8	27.8



Copper

Photo is for representation purposes only.

\*Frequencies beyond the TIA and ISO requirements are for information only. All values are dB/100m.

## Electrical Characteristics

Input Impedance:	100 ± 15Ω (1.0 to 100 MHz) 100 ± 20Ω (100 to 250 MHz) 100 ± 25Ω (251 to 500 MHz)
Maximum Resistance Unbalance:	3%
Maximum Capacitance Unbalance:	330 pF/100 meters
Maximum Delay Skew:	45 ns/100 meters
Nominal Velocity Of Propagation (Nvp):	70%, Plenum 68%, Riser
Voltage Rating:	300 Volts
LP Rating (UL) - CMP	0.6 Amps/conductor

### Cable Ampacity Chart

Bundle Size	1		2-7		8-19		20-37		38-61		62-91		92-192	
	75°C	90°C	75°C	90°C	75°C	90°C	75°C	90°C	75°C	90°C	75°C	90°C	75°C	90°C
23 AWG	2.5	2.5	1.5	1.7	1.1	1.7	0.8	0.9	0.7	0.8	0.7	0.8	0.5	0.6

The table above is derived from the one approved by the National Fire Protection Agency and used in the National Electrical Code, NFPA-70. The complete table can be found in sections 725.144 and 800 Communication Circuits of the code. The table identifies the ampacity of each conductor (in amperes) in a 4-pair Class 2 or Class 3 data cable. Ambient temperature used for development of the table is 30°C (86°F) with all conductors in all cables carrying current. The table is based on 60°C (140°F), 75°C (167°F) and 90°C (194°F) rated cables. All cable temps are operational temp ratings. Cables with temp ratings above 90c would deliver additional power handling capacity.

# Indoor

Enhanced F/UTP

Copper

## Product Highlights

- REACH & RoHS 2 compliant
- Made in U.S.A.
- UL Verified
- Low Smoke Plenum construction.
- Tested from 1 to 660 MHz
- Small O.D. allows more cables per conduit
- Proven shield technology improves RFI, EMI and alien crosstalk performance
- UL Tested (LP) for maximum power support

## Packaging

- 1,000 foot (305 m) reels
- Reverse sequential footage markings standard on each 1,000 foot package
- Unit/pallet: 12  
CMP Carton Weight (lbs): 43.64  
CMP Product Weight (lbs): 40.34  
\*weight may vary, call for CMR information

## Options

- Available in LSZH

## Applications

- Including:
  - HDBase-T A & B
  - 10 Gigabit Ethernet (IEEE 802.3an)
  - 5 Gigabit Ethernet (IEEE 802.3bz)
  - 2.5 Gigabit Ethernet (IEEE 802.3bz)
  - Gigabit Ethernet (IEEE 802.3ab)
  - 100 Mbps Ethernet (IEEE 802.3u)
  - 1000 Mbps ATM
  - 622 Mbps ATM
  - 15W PoE (IEEE 802.3af)
  - 30W PoE+ (IEEE 802.3at)
  - 60W PoE++ (IEEE 802.3bt Type 3)
  - 100W PoE++ (IEEE 802.3bt Type 4)

## Temp. Range

- Storage Temperature  
-40°C to +60°C  
(-40°F to +140°F)
- Installation Temperature  
0°C to +60°C  
(+32°F to +140°F)
- Operation Temperature  
-20°C to +105°C  
(-4°F to +221°F)

## Supra 10G 6A F/UTP (Plenum)

c(UL)us Listed Type CMP (NFPA 262), CSA Type FT6

PART #	# OF PAIRS	CALCULATED CABLE O.D.		CABLE WEIGHT	
		inches	mm	lbs/1000 ft	kg/305 m
30233-8-XXY	4	0.275	6.98	40.34	18.29

## Cable Print Legend

HITACHI CABLE AMERICA CATEGORY 6A SUPRA 10G F/UTP -  
4PR/23 c(UL)us CMP-LP (0.6A) (105C) - CAT 6A

ANSI/TIA 568.2-D - Z/Y/XY (XXXX) - Mx - R# - NNNN FEET

WHERE: Z = MONTH OF MFG.

YY = YEAR OF MFG.

XXXX = JOB NUMBER

x = RESPOOL MACHINE #

# = MASTER REEL #

NNNN = SEQUENTIAL FOOTAGE MARKERS

## Building a Part Number

Base Part Number Ex.	No. of Conductors	Jacket Color	Reel Type
30327	8	XX	Y

Jacket Colors (XX):

Black (BK); Blue (BL); Brown (BR); Gray (GA); Green (GR); Red (RD); White (WH); Yellow (YE)

Reel Type (Y):

Reels (3)

## Features

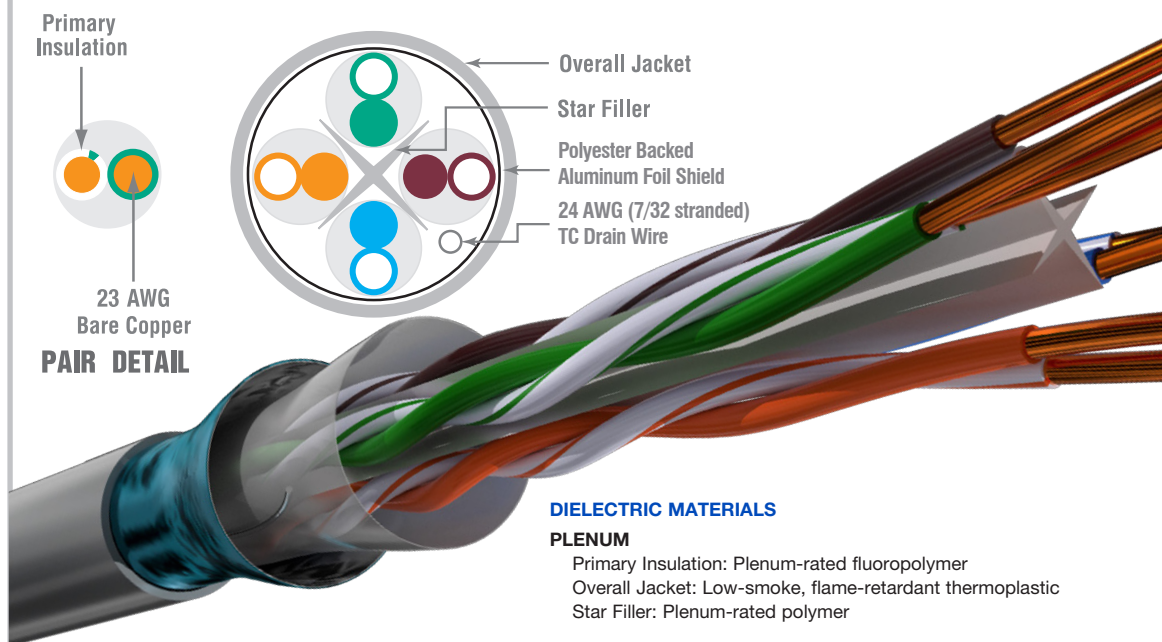

### DIELECTRIC MATERIALS

#### PLENUM

Primary Insulation: Plenum-rated fluoropolymer

Overall Jacket: Low-smoke, flame-retardant thermoplastic

Star Filler: Plenum-rated polymer

Hitachi Cable America reserves the right to revise any specifications.

# Cat 6A Supra 10G™ F/UTP

## Transmission Specifications

ANSI/TIA-568.2-D Category 6A Verified  
ISO/IEC 11801, 2nd ed. Class EA Compliant

Freq. (MHz)	Ins. Loss Max.	NEXT Min.	PSNEXT Min.	ACR Min.	PSACR Min.	ACRF Min.	PSACRF Min.	Return Loss Min.	PSANEXT TIA Std.	PSANEXT Min.	PSAACRF TIA Std.	PSAACRF Min.
1	2.1	74.3	72.3	72.2	70.2	67.8	64.8	20.0	67.0	73.0	67.0	73.0
4	3.8	65.3	63.3	61.5	59.5	55.8	52.8	23.0	67.0	73.0	66.2	72.2
8	5.3	60.8	58.8	55.4	53.4	49.7	46.7	24.5	67.0	73.0	60.1	66.1
10	5.9	59.3	57.3	53.4	51.4	47.8	44.8	25.0	67.0	73.0	58.2	64.2
16	7.5	56.2	54.2	48.8	46.8	43.7	40.7	25.0	67.0	73.0	54.1	60.1
20	8.4	54.8	52.8	46.4	44.4	41.8	38.8	25.0	67.0	73.0	52.2	58.2
25	9.4	53.3	51.3	44.0	42.0	39.8	36.8	24.3	67.0	73.0	50.2	56.2
31.25	10.5	51.9	49.9	41.4	39.4	37.9	34.9	23.6	67.0	73.0	48.3	54.3
62.5	15.0	47.4	45.4	32.4	30.4	31.9	28.9	21.5	65.6	71.6	42.3	48.3
100	19.1	44.3	42.3	25.2	23.2	27.8	24.8	20.1	62.5	68.5	38.2	44.2
155	24.1	41.4	39.4	17.4	15.4	24.0	21.0	18.8	59.6	65.6	34.4	40.4
200	27.6	39.8	37.8	12.2	10.2	21.8	18.8	18.0	58.0	64.0	32.2	38.2
250	31.1	39.3	36.3	7.3	5.3	19.8	16.8	17.3	56.5	62.5	30.2	36.2
300	34.3	37.1	35.1	2.9	0.9	18.3	15.3	16.8	55.3	61.3	28.7	34.7
350	37.2	36.1	34.1	-	-	16.9	13.9	16.3	54.3	60.3	27.3	33.3
400	40.1	35.3	33.3	-	-	15.8	12.8	15.9	53.5	59.3	26.2	32.2
500	45.3	33.8	31.8	-	-	13.8	10.8	15.2	52.0	58.0	24.2	30.2
555*	47.9	33.1	31.1	-	-	12.9	9.9	14.9	51.3	57.3	23.3	29.3
660*	52.8	32.0	30.0	-	-	11.4	8.4	14.4	50.2	56.2	21.8	27.8



Copper

Photo is for representation purposes only.

\*Frequencies beyond the TIA and ISO requirements are for information only. All values are dB/100m.

## Electrical Characteristics

Input Impedance:	100 ± 15Ω (1.0 to 100 MHz) 100 ± 20Ω (100 to 250 MHz) 100 ± 25Ω (251 to 500 MHz)
Maximum Resistance Unbalance:	3%
Maximum Capacitance Unbalance:	330 pF/100 meters
Maximum Delay Skew:	45 ns/100 meters
Nominal Velocity Of Propagation (Nvp):	70%, Plenum
Voltage Rating:	300 Volts
LP Rating (UL) - CMP	0.6 Amps/conductor

Cable Ampacity Chart

Bundle Size	1		2-7		8-19		20-37		38-61		62-91		92-192	
	75°C	90°C	75°C	90°C	75°C	90°C	75°C	90°C	75°C	90°C	75°C	90°C	75°C	90°C
23 AWG	2.5	2.5	1.5	1.7	1.1	1.7	0.8	0.9	0.7	0.8	0.7	0.8	0.5	0.6

The table above is derived from the one approved by the National Fire Protection Agency and used in the National Electrical Code, NFPA-70. The complete table can be found in sections 725.144 and 800 Communication Circuits of the code. The table identifies the ampacity of each conductor (in amperes) in a 4-pair Class 2 or Class 3 data cable. Ambient temperature used for development of the table is 30°C (86°F) with all conductors in all cables carrying current. The table is based on 60°C (140°F), 75°C (167°F) and 90°C (194°F) rated cables. All cable temps are operational temp ratings. Cables with temp ratings above 90c would deliver additional power handling capacity.

# Indoor

## Enhanced UTP

Copper

### Product Highlights

- REACH & RoHS 2 compliant
- Made in U.S.A.
- UL Verified
- Low Smoke Plenum construction
- Guaranteed minimum performance
- Enhanced performance beyond TIA Standard
- Tested from 1 to 660 MHz

TIA Parameter	Guaranteed Headroom
Insertion loss	+3%
NEXT loss	+9 dB
PSNEXT loss	+9 dB
ACRF	+8 dB
PSACRF	+8 dB

### Packaging

- 1,000 feet (305 m)
- Reverse sequential footage markings standard on each 1,000 foot package
- Unit/pallet: 32 Reels  
CMP Carton Weight (lbs): 28.79  
CMP Product Weight (lbs): 25.49  
\*weight may vary, call for CMR information

### Options

- CMP-50 rated cables available

### Applications

- Including:  
HDBase-T A & B  
5 Gigabit Ethernet (IEEE 802.3bz)  
2.5 Gigabit Ethernet (IEEE 802.3bz)  
Gigabit Ethernet (IEEE 802.3ab)  
100 Mbps Ethernet (IEEE 802.3u)  
1000 Mbps ATM  
622 Mbps ATM  
15W PoE (IEEE 802.3af)  
30W PoE+ (IEEE 802.3at)  
60W PoE++ (IEEE 802.3bt Type 3)  
100W PoE++ (IEEE 802.3bt Type 4)

### Temp. Range

- Storage Temperature  
-40°C to +60°C  
(-40°F to +140°F)
- Installation Temperature  
0°C to +60°C  
(+32°F to +140°F)
- Operation Temperature  
-20°C to +75°C  
(-4°F to +167°F)

## Supra™ 660 UTP (Plenum)

c(UL)us Listed Type CMP (NFPA 262), CSA Type FT6

PART #	# OF PAIRS	CALCULATED CABLE O.D.		CABLE WEIGHT	
		inches	mm	lbs/1000 ft	kg/305 m
30016-8-XXY	4	0.22	5.59	25.49	11.56

## Supra™ 660 UTP (Riser)

c(UL)us Listed Type CMR (UL 1666), CSA Type FT4

PART #	# OF PAIRS	CALCULATED CABLE O.D.		CABLE WEIGHT	
		inches	mm	lbs/1000 ft	kg/305 m
30022-8-XXY	4	0.215	6.09	26.93	12.22

### Building a Part Number

Base Part Number Ex.	No. of Conductors	Jacket Color	Reel Type
30016	8	XX	Y

Jacket Colors (XX):

Black (BK); Blue (BL); Brown (BR); Gray (GA); Green (GR); Red (RD); White (WH); Violet (VI); Yellow (YE)

Reel Type (Y):

Reellex (2); Reels (3); Reel-in-a-box (4)

## Features

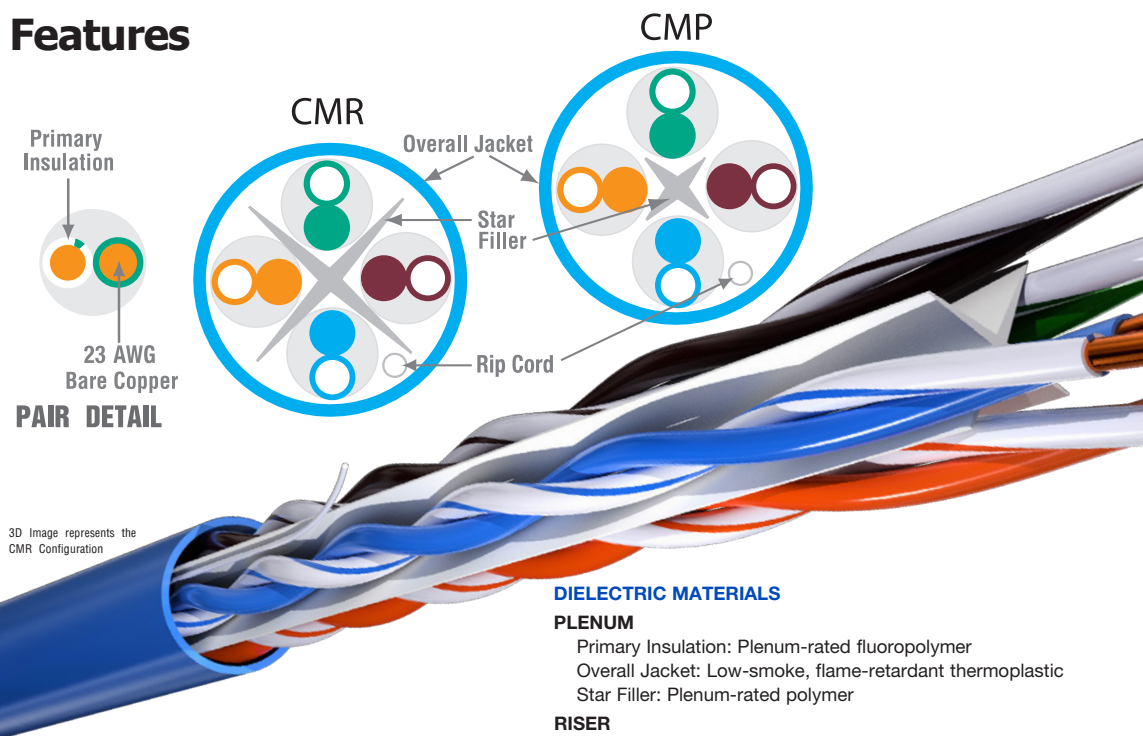

3D Image represents the CMR Configuration

### DIELECTRIC MATERIALS

#### PLENUM

Primary Insulation: Plenum-rated fluoropolymer  
Overall Jacket: Low-smoke, flame-retardant thermoplastic  
Star Filler: Plenum-rated polymer

#### RISER

Primary Insulation: Polyolefin  
Overall Jacket: Flame-retardant Thermoplastic  
Star Filler: Flame-retardant Thermoplastic

Hitachi Cable America reserves the right to revise any specifications.



# Cat 6 Supra™ 660

## Transmission Specifications ANSI/TIA-568.2-D Category 6 Verified ISO/IEC 11801, 2nd ed. Class E Compliant

Freq. (MHz)	Ins. Loss		NEXT		PSNEXT		ACR		PSACR		ACRF		PSACRF		Return Loss	
	Std.	Max.	Std.	Min.	Std.	Min.	Cal.	Min.	Cal.	Min.	Std.	Min.	Std.	Min.	Std.	Min.
1	2.0	2.0	74.3	83.3	72.3	81.3	72.3	81.3	70.3	79.3	67.8	75.8	64.8	72.8	20.0	20.0
4	3.8	3.7	65.3	74.3	63.3	72.3	61.5	70.6	59.5	68.6	55.8	63.8	52.8	60.8	23.0	24.2
8	5.3	5.2	60.8	69.8	58.8	67.8	55.4	64.6	53.4	62.6	49.7	57.7	46.7	54.7	24.5	26.3
10	6.0	5.8	59.3	68.3	57.3	66.3	53.3	62.5	51.3	60.5	47.8	55.8	44.8	52.8	25.0	27.0
16	7.6	7.3	56.2	65.2	54.2	63.2	48.7	57.9	46.7	55.9	43.7	51.7	40.7	48.7	25.0	27.0
31.25	10.7	10.4	51.9	60.9	49.9	58.9	41.2	50.5	39.2	48.5	37.9	45.9	34.9	42.9	23.6	25.9
62.5	15.4	14.9	47.4	56.4	45.4	54.4	32.0	41.4	30.0	39.4	31.9	39.9	28.9	36.9	21.5	24.2
100	19.8	19.2	44.3	53.3	42.3	51.3	24.5	34.1	22.5	32.1	27.8	35.8	24.8	32.8	20.1	23.1
155	25.2	24.4	41.1	50.4	39.4	48.4	15.9	26.0	14.3	24.0	24.0	32.0	21.0	29.0	18.8	22.0
200	29.0	28.1	39.8	48.8	37.8	46.8	10.8	20.7	8.8	18.7	21.8	29.8	18.8	26.8	18.0	21.4
250	32.8	31.9	38.3	47.3	36.3	45.3	5.5	15.5	3.5	13.5	19.8	27.8	16.8	24.8	17.3	20.9
300*	-	35.3	-	46.1	-	44.1	-	10.8	-	8.8	-	26.3	-	23.3	-	20.4
350*	-	38.6	-	45.1	-	43.1	-	6.5	-	4.5	-	24.9	-	21.9	-	20.1
400*	-	41.7	-	44.3	-	42.3	-	2.6	-	0.6	-	23.8	-	20.8	-	19.7
500*	-	47.5	-	42.8	-	40.8	-	-	-	-	-	21.8	-	18.8	-	19.2
555*	-	50.5	-	42.1	-	40.1	-	-	-	-	-	20.9	-	17.9	-	18.9
660*	-	55.9	-	41.0	-	39.0	-	-	-	-	-	19.4	-	16.4	-	18.5

\*Frequencies beyond the TIA and ISO requirements are for information only. All values are dB/100m.



Copper

Photo is for representation purposes only.



## Electrical Characteristics

Input Impedance:	100 ± 15Ω (1.0 to 100 MHz) 100 ± 20Ω (100 to 250 MHz)
Maximum Resistance Unbalance:	3%
Maximum Capacitance Unbalance:	330 pF/100 meters
Maximum Delay Skew:	35 ns/100 meters
Nominal Velocity Of Propagation (Nvp):	70%, Plenum 68%, Riser
Voltage Rating:	300 Volts

Cable Ampacity Chart							
Bundle Size	1	2-7	8-19	20-37	38-61	62-91	92-192
Cable Temp	75°C	75°C	75°C	75°C	75°C	75°C	75°C
23 AWG	2.5	1.5	1.1	0.8	0.7	0.7	0.5

The table above is derived from the one approved by the National Fire Protection Agency and used in the National Electrical Code, NFPA-70. The complete table can be found in sections 725.144 and 800 Communication Circuits of the code. The table identifies the ampacity of each conductor (in amperes) in a 4-pair Class 2 or Class 3 data cable. Ambient temperature used for development of the table is 30°C (86°F) with all conductors in all cables carrying current. The table is based on 60°C (140°F), 75°C (167°F) and 90°C (194°F) rated cables. All cable temps are operational temp ratings. Cables with temp ratings above 90c would deliver additional power handling capacity.

# Indoor

## Enhanced UTP

Copper

### Product Highlights

- REACH & RoHS 2 compliant
- Made in U.S.A.
- UL Verified
- Low Smoke Plenum construction
- Guaranteed minimum performance
- Enhanced performance beyond TIA Standard
- Tested from 1 to 660 MHz

TIA Parameter	Guaranteed Headroom
NEXT loss	+5 dB
PSNEXT loss	+5 dB
ACRF	+6 dB
PSACRF	+6 dB

### Packaging

- 1,000 feet (305 m)
- Reverse sequential footage markings standard on each 1,000 foot package
- Unit/pallet: 32 Reels  
CMP Carton Weight (lbs): 29.04  
CMP Product Weight (lbs): 25.74  
\*weight may vary, call for CMR information

### Options

- CMP-50 rated cables available

### Applications

- Including:
  - HDBase-T A & B
  - 5 Gigabit Ethernet (IEEE 802.3bz)
  - 2.5 Gigabit Ethernet (IEEE 802.3bz)
  - Gigabit Ethernet (IEEE 802.3ab)
  - 100 Mbps Ethernet (IEEE 802.3u)
  - 1000 Mbps ATM
  - 622 Mbps ATM
  - 15W PoE (IEEE 802.3af)
  - 30W PoE+ (IEEE 802.3at)
  - 60W PoE++ (IEEE 802.3bt Type 3)
  - 100W PoE++ (IEEE 802.3bt Type 4)

### Temp. Range

- Storage Temperature  
-40°C to +60°C  
(-40°F to +140°F)
- Installation Temperature  
0°C to +60°C  
(+32°F to +140°F)
- Operation Temperature  
-20°C to +75°C  
(-4°F to +167°F)

## Premium UTP (Plenum)

c(UL)us Listed Type CMP (NFPA 262), CSA Type FT6

PART #	# OF PAIRS	CALCULATED CABLE O.D.		CABLE WEIGHT	
		inches	mm	lbs/1000 ft	kg/305 m
30183-8-XXY	4	0.20	5.1	25.74	11.68

## Premium UTP (Riser)

c(UL)us Listed Type CMR (UL 1666), CSA Type FT4

PART #	# OF PAIRS	CALCULATED CABLE O.D.		CABLE WEIGHT	
		inches	mm	lbs/1000 ft	kg/305 m
30212-8-XXY	4	0.215	6.22	26.93	12.22

### Building a Part Number

Base Part Number Ex.	No. of Conductors	Jacket Color	Reel Type
30183	8	XX	Y

Jacket Colors (XX):

Black (BK); Blue (BL); Brown (BR); Gray (GA); Green (GR); Red (RD); White (WH); Violet (VI); Yellow (YE)

Reel Type (Y):

Reelex (2); Reels (3)

## Features

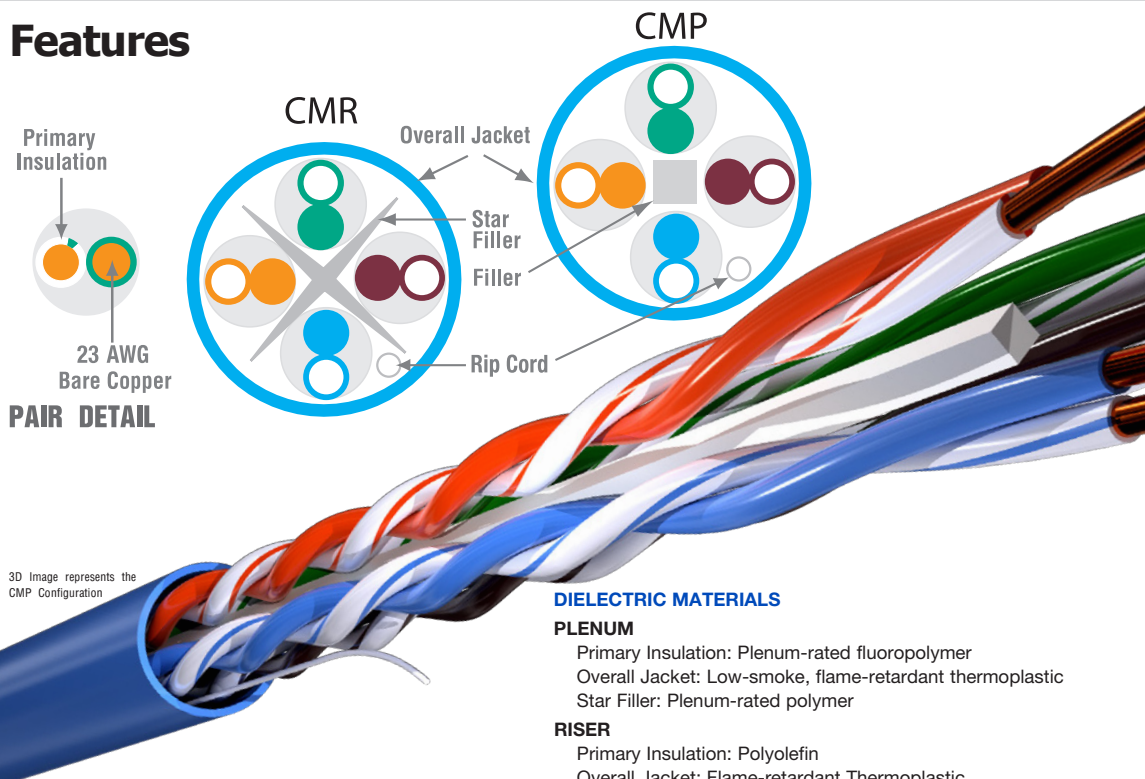

3D Image represents the CMP Configuration

### DIELECTRIC MATERIALS

#### PLENUM

Primary Insulation: Plenum-rated fluoropolymer  
Overall Jacket: Low-smoke, flame-retardant thermoplastic  
Star Filler: Plenum-rated polymer

#### RISER

Primary Insulation: Polyolefin  
Overall Jacket: Flame-retardant Thermoplastic  
Star Filler: Flame-retardant Thermoplastic

Hitachi Cable America reserves the right to revise any specifications.

# Cat 6 Premium

## Transmission Specifications

ANSI/TIA-568.2-D Category 6 Verified  
ISO/IEC 11801, 2nd ed. Class E Compliant

Freq. (MHz)	Ins. Loss		NEXT		PSNEXT		ACR		PSACR		ACRF		PSACRF		Return Loss	
	Std.	Max.	Std.	Min.	Std.	Min.	Cal.	Min.	Cal.	Min.	Std.	Min.	Std.	Min.	Std.	Min.
1	2.0	2.0	74.3	79.3	72.3	77.3	72.3	77.3	70.3	75.3	67.8	73.8	64.8	70.8	20.0	20.0
4	3.8	3.8	65.3	70.3	63.3	68.7	61.5	66.5	59.5	64.5	55.8	61.8	52.8	58.8	23.0	23.0
8	5.3	5.3	60.8	65.8	58.8	63.8	55.4	60.4	53.4	58.4	49.7	55.7	46.7	52.7	24.5	24.5
10	6.0	6.0	59.3	64.3	57.3	62.3	53.3	58.3	51.3	56.3	47.8	53.8	44.8	50.8	25.0	25.0
16	7.6	7.6	56.2	61.2	54.2	59.2	48.7	53.7	46.7	51.7	43.7	49.7	40.7	46.7	25.0	25.0
31.25	10.7	10.7	51.9	56.9	49.9	54.9	41.2	46.2	39.2	44.2	37.9	43.9	34.9	40.9	23.6	23.6
62.50	15.4	15.4	47.4	52.4	45.4	50.4	32.0	37.0	30.0	35.0	31.9	37.9	28.9	34.9	21.5	21.5
100	19.8	19.8	44.3	49.3	42.3	47.3	24.5	29.5	22.5	27.5	27.8	33.8	24.8	30.8	20.1	20.1
155	25.2	25.2	41.1	46.4	39.4	44.4	16.3	21.3	14.3	19.2	24.0	30.0	21.0	27.0	18.8	18.8
200	29.0	29.0	39.8	44.8	37.8	42.8	10.8	15.8	8.8	13.8	21.8	27.8	18.8	24.8	18.0	18.0
250	32.8	32.8	38.3	43.3	36.3	41.3	5.5	10.5	3.5	8.5	19.8	25.8	16.8	22.8	17.3	17.3
300*	-	36.4	-	42.1	-	40.1	0.7	5.7	-	3.7	-	24.3	-	21.3	-	16.8
350*	-	39.8	-	41.1	-	39.1	-	1.4	-	-	-	22.9	-	19.9	-	16.3
400*	-	43.0	-	40.3	-	38.3	-	-	-	-	-	21.8	-	18.8	-	15.9
500*	-	48.9	-	38.8	-	36.8	-	-	-	-	-	19.8	-	16.8	-	15.2
555*	-	52.0	-	38.1	-	36.1	-	-	-	-	-	18.9	-	15.9	-	14.9
660*	-	57.7	-	37.0	-	35.0	-	-	-	-	-	17.4	-	14.4	-	14.4

\*Frequencies beyond the TIA and ISO requirements are for information only. All values are dB/100m.



Copper

Photo is for representation purposes only.



## Electrical Characteristics

Input Impedence:	100 ± 15Ω (1.0 to 100 MHz) 100 ± 20Ω (101 to 160 MHz) 100 ± 25Ω (161 to 250 MHz)
Maximum Resistance Unbalance:	3%
Maximum Capacitance Unbalance:	330 pF/100 meters
Maximum Delay Skew:	35 ns/100 meters (CMP)   45 ns/100 meters (CMR)
Nominal Velocity Of Propagation (Nvp):	70%, Plenum 68%, Riser
Voltage Rating:	300 Volts

Cable Ampacity Chart							
Bundle Size	1	2-7	8-19	20-37	38-61	62-91	92-192
Cable Temp	75°C	75°C	75°C	75°C	75°C	75°C	75°C
23 AWG	2.5	1.5	1.1	0.8	0.7	0.7	0.5

The table above is derived from the one approved by the National Fire Protection Agency and used in the National Electrical Code, NFPA-70. The complete table can be found in sections 725.144 and 800 Communication Circuits of the code. The table identifies the ampacity of each conductor (in amperes) in a 4-pair Class 2 or Class 3 data cable. Ambient temperature used for development of the table is 30°C (86°F) with all conductors in all cables carrying current. The table is based on 60°C (140°F), 75°C (167°F) and 90°C (194°F) rated cables. All cable temps are operational temp ratings. Cables with temp ratings above 90c would deliver additional power handling capacity.

# Indoor

## Enhanced UTP

Copper

### Product Highlights

- REACH & RoHS 2 compliant
- Made in U.S.A.
- UL Verified
- Low Smoke Plenum construction
- Guaranteed minimum performance
- Enhanced performance beyond TIA Standard
- Tested from 1 to 555 MHz

TIA Parameter	Guaranteed Headroom
NEXT loss	+3 dB
PSNEXT loss	+3 dB
ACRF	+3 dB
PSACRF	+3 dB

### Packaging

- 1,000 feet (305 m)
- Reverse sequential footage markings standard on each 1,000 foot package
- Unit/pallet: 32 Reels  
CMP Carton Weight (lbs): 29.04  
CMP Product Weight (lbs): 25.74  
\*weight may vary, call for CMR information

### Options

- CMP-50 rated cables available

### Applications

- Including:
  - HDBase-T A & B
  - 5 Gigabit Ethernet (IEEE 802.3bz)
  - 2.5 Gigabit Ethernet (IEEE 802.3bz)
  - Gigabit Ethernet (IEEE 802.3ab)
  - 100 Mbps Ethernet (IEEE 802.3u)
  - 1000 Mbps ATM
  - 622 Mbps ATM
  - 15W PoE (IEEE 802.3af)
  - 30W PoE+ (IEEE 802.3at)
  - 60W PoE++ (IEEE 802.3bt Type 3)
  - 100W PoE++ (IEEE 802.3bt Type 4)

### Temp. Range

- Storage Temperature  
-40°C to +60°C  
(-40°F to +140°F)
- Installation Temperature  
0°C to +60°C  
(+32°F to +140°F)
- Operation Temperature  
-20°C to +75°C  
(-4°F to +167°F)

## Plus™ UTP (Plenum)

c(UL)us Listed Type CMP (NFPA 262), CSA Type FT6

PART #	# OF PAIRS	CALCULATED CABLE O.D.		CABLE WEIGHT	
		inches	mm	lbs/1000 ft	kg/305 m
30025-8-XXY	4	0.20	5.1	25.74	11.67

## Plus™ UTP (Riser)

c(UL)us Listed Type CMR (UL 1666), CSA Type FT4

PART #	# OF PAIRS	CALCULATED CABLE O.D.		CABLE WEIGHT	
		inches	mm	lbs/1000 ft	kg/305 m
30024-8-XXY	4	0.23	5.84	22.87	10.37

### Building a Part Number

Base Part Number Ex.	No. of Conductors	Jacket Color	Reel Type
30025	8	XX	Y

Jacket Colors (XX):

Black (BK); Blue (BL); Brown (BR); Gray (GA); Green (GR); Red (RD); White (WH); Violet (VI); Yellow (YE)

Reel Type (Y):

Reellex (2); Reels (3); Reel-in-a-box (4)

## Features

Primary Insulation



23 AWG Bare Copper

PAIR DETAIL

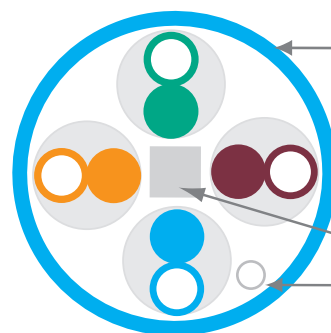

Overall Jacket

Filler

Rip Cord

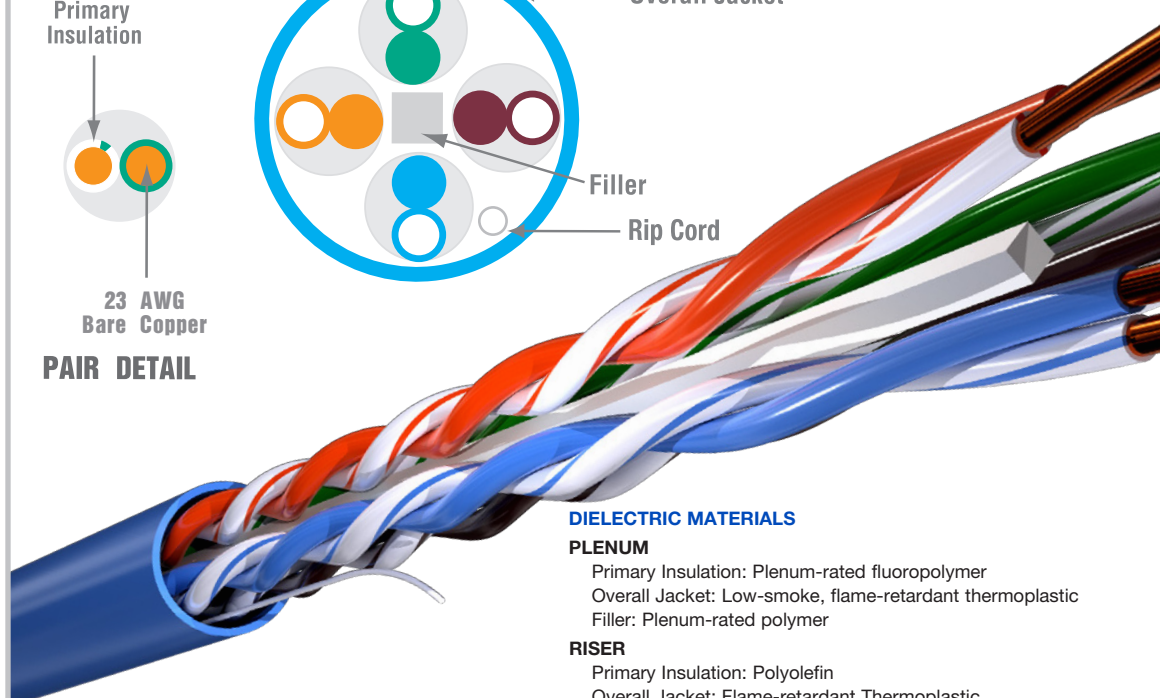

### DIELECTRIC MATERIALS

#### PLENUM

Primary Insulation: Plenum-rated fluoropolymer  
Overall Jacket: Low-smoke, flame-retardant thermoplastic  
Filler: Plenum-rated polymer

#### RISER

Primary Insulation: Polyolefin  
Overall Jacket: Flame-retardant Thermoplastic  
Filler: Flame-retardant Thermoplastic

Hitachi Cable America reserves the right to revise any specifications.

## Transmission Specifications ANSI/TIA-568.2-D Category 6 Verified ISO/IEC 11801, 2nd ed. Class E Compliant

Freq. (MHz)	Ins. Loss		NEXT		PSNEXT		ACR		PSACR		ACRF		PSACRF		Return Loss	
	Std.	Max.	Std.	Min.	Std.	Min.	Cal.	Min.	Cal.	Min.	Std.	Min.	Std.	Min.	Std.	Min.
1	2.0	2.0	74.3	77.3	72.3	75.3	72.3	75.3	70.3	73.3	67.8	70.8	64.8	67.8	20.0	20.0
4	3.8	3.8	65.3	68.3	63.3	66.3	61.5	64.5	59.5	62.5	55.8	58.8	52.8	55.8	23.0	23.0
8	5.3	5.3	60.8	63.8	58.8	61.8	55.4	58.4	53.4	56.4	49.7	52.7	46.7	49.7	24.5	24.5
10	6.0	6.0	59.3	62.3	57.3	60.3	53.3	56.3	51.3	54.3	47.8	50.8	44.8	47.8	25.0	25.0
16	7.6	7.6	56.2	59.2	54.2	57.2	48.7	51.7	46.7	49.7	43.7	46.7	40.7	43.7	25.0	25.0
31.25	10.7	10.7	51.9	54.9	49.9	52.9	41.2	44.2	39.2	42.2	37.9	40.9	34.9	37.9	23.6	23.6
62.5	15.4	15.4	47.4	50.4	45.4	48.4	32.0	35.0	30.0	33.0	31.9	34.9	28.9	31.9	21.5	21.5
100	19.8	19.8	44.3	47.3	42.3	45.3	24.5	27.5	22.5	25.5	27.8	30.8	24.8	27.8	20.1	20.1
200	29.0	29.0	39.8	42.8	37.8	40.8	10.8	13.8	8.8	11.8	21.8	24.8	18.8	21.8	18.0	18.0
250	32.8	32.8	38.3	41.3	36.3	39.3	5.5	8.5	3.5	6.5	19.8	22.8	16.8	19.8	17.3	17.3
300*	-	36.4	-	40.1	-	38.1	-	3.7	-	1.7	-	21.3	-	18.3	-	16.8
350*	-	39.8	-	39.1	-	37.1	-	-	-	-	-	19.9	-	16.9	-	16.3
400*	-	43.0	-	39.3	-	36.3	-	-	-	-	-	18.8	-	15.8	-	15.9
500*	-	48.9	-	36.8	-	34.8	-	-	-	-	-	16.8	-	13.8	-	15.2
555*	-	52.0	-	36.1	-	34.1	-	-	-	-	-	15.9	-	12.9	-	14.9

\*Frequencies beyond the TIA and ISO requirements are for information only. All values are dB/100m.



Copper

Photo is for representation purposes only.



## Electrical Characteristics

Input Impedence:	100 ± 15Ω (1.0 to 250 MHz)
Maximum conductor resistance	9.38 Ω/100 meters @ 20°C
Maximum Resistance Unbalance:	5%
Maximum Capacitance Unbalance:	330 pF/100 meters
Maximum Delay Skew:	45 ns/100 meters
Nominal Velocity Of Propagation (Nvp):	70%, Plenum 68%, Riser
Voltage Rating:	300 Volts

Cable Ampacity Chart							
Bundle Size	1	2-7	8-19	20-37	38-61	62-91	92-192
Cable Temp	75°C	75°C	75°C	75°C	75°C	75°C	75°C
23 AWG	2.5	1.5	1.1	0.8	0.7	0.7	0.5

The table above is derived from the one approved by the National Fire Protection Agency and used in the National Electrical Code, NFPA-70. The complete table can be found in sections 725.144 and 800 Communication Circuits of the code. The table identifies the ampacity of each conductor (in amperes) in a 4-pair Class 2 or Class 3 data cable. Ambient temperature used for development of the table is 30°C (86° F) with all conductors in all cables carrying current. The table is based on 60°C (140°F), 75°C (167°F) and 90°C (194°F) rated cables. All cable temps are operational temp ratings. Cables with temp ratings above 90c would deliver additional power handling capacity.

# Indoor

UTP

Copper

## Product Highlights

- REACH & RoHS 2 compliant
- Made in U.S.A.
- UL Verified
- Low Smoke Plenum construction
- Guaranteed minimum performance
- Tested from 1 to 555 MHz
- No internal pair separator
- Small outside diameter permits more cables per conduit than typical Category 6 cable
- Standard Reelex™ package made with 100% post consumer materials
- CMR-LSZH version offers a halogen free design for improved environmental performance

## Packaging

- 1,000 feet (305 m)
- Reverse sequential footage markings standard on each 1,000 foot package
- Unit/pallet: 48 Reels  
CMP Carton Weight (lbs): 22.5  
CMP Product Weight (lbs): 20.5  
\*weight may vary, call for CMR information

## Options

- 23 AWG Conductors available

## Applications

- Including:
  - 5 Gigabit Ethernet (IEEE 802.3bz)
  - 2.5 Gigabit Ethernet (IEEE 802.3bz)
  - Gigabit Ethernet (IEEE 802.3ab)
  - 100 Mbps Ethernet (IEEE 802.3u)
  - 1000 Mbps ATM
  - 622 Mbps ATM
  - 15W PoE (IEEE 802.3af)
  - 30W PoE+ (IEEE 802.3at)
  - 60W PoE++ (IEEE 802.3bt Type 3)
  - 100W PoE++ (IEEE 802.3bt Type 4)

## Temp. Range

- Storage Temperature  
-40°C to +60°C  
(-40°F to +140°F)
- Installation Temperature  
0°C to +60°C  
(+32°F to +140°F)
- Operation Temperature
  - Plenum**  
-20°C to +90°C  
(-4°F to +194°F)
  - Riser/Low Smoke Halogen Free**  
-20°C to +75°C  
(-4°F to +167°F)

## XS™ UTP (Plenum)

c(UL)us Listed Type CMP (NFPA 262), CSA Type FT6

PART #	# OF PAIRS	CALCULATED CABLE O.D.		CABLE WEIGHT	
		inches	mm	lbs/1000 ft	kg/305 m
30237-8-XXY	4	0.20	5.08	25.24	11.45

## XS™ UTP (Riser)

c(UL)us Listed Type CMR (UL 1666), CSA Type FT4

PART #	# OF PAIRS	CALCULATED CABLE O.D.		CABLE WEIGHT	
		inches	mm	lbs/1000 ft	kg/305 m
30238-8-XXY	4	0.21	5.48	23.12	10.5

## XS™ UTP (Riser-Low Smoke Zero Halogen)

c(UL)us Listed Type CMR (UL 1666), CSA Type FT44

PART #	# OF PAIRS	CALCULATED CABLE O.D.		CABLE WEIGHT	
		inches	mm	lbs/1000 ft	kg/305 m
30309-8-XXY	4	0.21	5.26	23.12	10.5

## Building a Part Number

Base Part Number Ex.	No. of Conductors	Jacket Color	Reel Type
30237	8	XX	Y

Jacket Colors (XX):

Black (BK); Blue (BL); Brown (BR); Gray (GA); Green (GR); Red (RD); White (WH); Violet (VI); Yellow (YE)

Reel Type (Y):

Reelex (2); Reels (3); Reel-in-a-box (4)

## Features

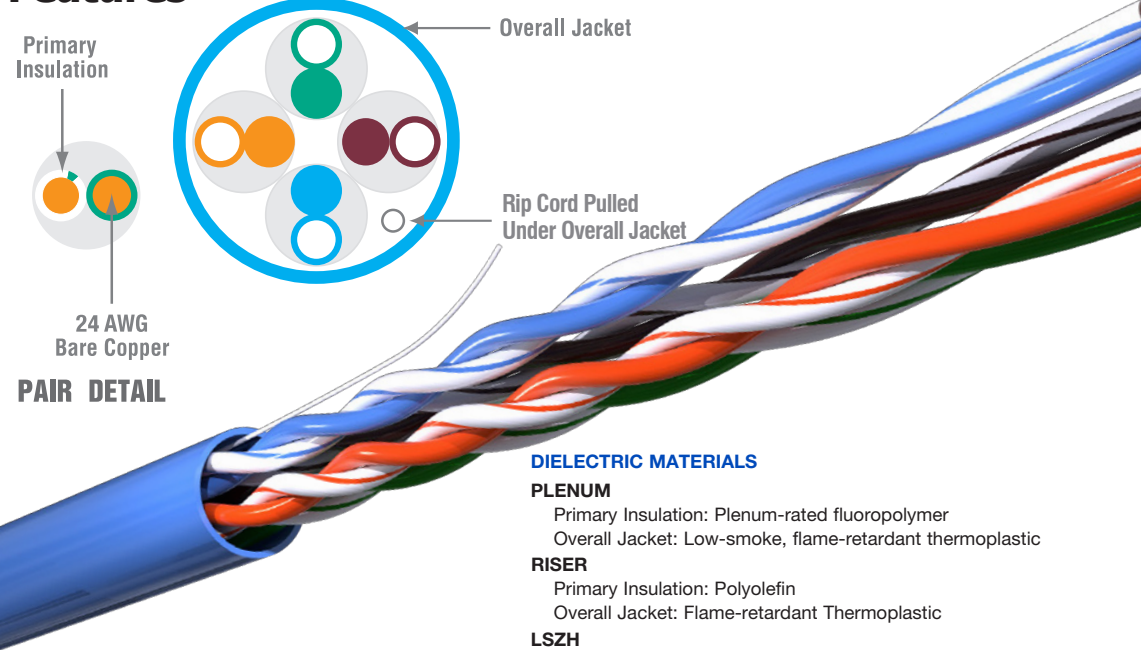

### DIELECTRIC MATERIALS

#### PLENUM

Primary Insulation: Plenum-rated fluoropolymer  
Overall Jacket: Low-smoke, flame-retardant thermoplastic

#### RISER

Primary Insulation: Polyolefin  
Overall Jacket: Flame-retardant Thermoplastic

#### LSZH

Primary Insulation: Polyethylene  
Overall Jacket: Zero-Halogen Flame-retardant Thermoplastic

Hitachi Cable America reserves the right to revise any specifications.

## Transmission Specifications

ANSI/TIA-568.2-D Category 6 Verified  
ISO/IEC 11801, 2nd ed. Class E Compliant

Freq. (MHz)	Ins. Loss		NEXT		PSNEXT		ACR		PSACR		ACRF		PSACRF		Return Loss	
	Std.	Max.	Std.	Min.	Std.	Min.	Cal.	Min.	Cal.	Min.	Std.	Min.	Std.	Min.	Std.	Min.
1	2.0	2.0	74.3	74.3	72.3	72.3	72.3	72.3	70.3	70.3	67.8	67.8	64.8	64.8	20.0	20.0
4	3.8	3.8	65.3	65.3	63.3	63.3	61.5	61.5	59.5	59.5	55.8	55.8	52.8	52.8	23.0	23.0
8	5.3	5.3	60.8	60.8	58.8	58.8	55.4	55.4	53.4	53.4	49.7	49.7	46.7	46.7	24.5	24.5
10	6.0	6.0	59.3	59.3	57.3	57.3	53.3	53.3	51.3	51.3	47.8	47.8	44.8	44.8	25.0	25.0
16	7.6	7.6	56.2	56.2	54.2	54.2	48.7	48.7	46.7	46.7	43.7	43.7	40.7	40.7	25.0	25.0
31.25	10.7	10.7	51.9	51.9	49.9	49.9	41.2	41.2	39.2	39.2	37.9	37.9	34.9	34.9	23.6	23.6
62.5	15.4	15.4	47.4	47.4	45.4	45.4	32.0	32.0	30.0	30.0	31.9	31.9	28.9	28.9	21.5	21.5
100	19.8	19.8	44.3	44.3	42.3	42.3	24.5	24.5	22.5	22.5	27.8	27.8	24.8	24.8	20.1	20.1
200	29.0	29.0	39.8	39.8	37.8	37.8	10.8	10.8	8.8	8.8	21.8	21.8	18.8	18.8	18.0	18.0
250	32.8	32.8	38.3	38.3	36.3	36.3	5.5	5.5	3.5	3.5	19.8	19.8	16.8	16.8	17.3	17.3
300*	-	36.4	-	37.1	-	35.1	-	-	-	-	-	18.3	-	15.3	-	16.8
350*	-	39.8	-	36.1	-	34.1	-	-	-	-	-	16.9	-	13.9	-	16.3
400*	-	43.0	-	35.3	-	33.3	-	-	-	-	-	15.8	-	12.8	-	15.9
500*	-	48.9	-	33.8	-	31.8	-	-	-	-	-	13.8	-	10.8	-	15.2
555*	-	52.0	-	33.1	-	31.1	-	-	-	-	-	12.9	-	9.9	-	14.9

\*Frequencies beyond the TIA and ISO requirements are for information only. All values are dB/100m.



Copper

Photo is for representation purposes only.

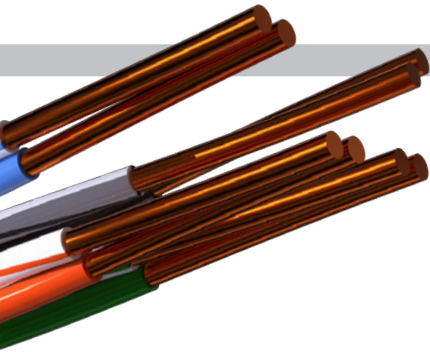

## Electrical Characteristics

Input Impedance:	100 ± 15Ω (1.0 to 100 MHz) 100 ± 20Ω (101 to 250 MHz)
Maximum Resistance Unbalance:	5%
Maximum Capacitance Unbalance:	330 pF/100 meters
Maximum Delay Skew:	45 ns/100 meters
Nominal Velocity Of Propagation (Nvp):	70%, Plenum 68%, Riser
Voltage Rating:	300 Volts

Cable Ampacity Chart														
Bundle Size	1		2-7		8-19		20-37		38-61		62-91		92-192	
Cable Temp	75°C	90°C	75°C	90°C	75°C	90°C	75°C	90°C	75°C	90°C	75°C	90°C	75°C	90°C
24 AWG	2.0	2.0	1.4	1.6	1.0	1.1	0.7	0.9	0.6	0.7	0.5	0.6	0.4	0.5

The table above is derived from the one approved by the National Fire Protection Agency and used in the National Electrical Code, NFPA-70. The complete table can be found in sections 725.144 and 800 Communication Circuits of the code. The table identifies the ampacity of each conductor (in amperes) in a 4-pair Class 2 or Class 3 data cable. Ambient temperature used for development of the table is 30°C (86° F) with all conductors in all cables carrying current. The table is based on 60°C (140°F), 75°C (167°F) and 90°C (194°F) rated cables. All cable temps are operational temp ratings. Cables with temp ratings above 90c would deliver additional power handling capacity.

# Indoor

F/UTP

Copper

## Product Highlights

- REACH & RoHS 2 compliant
- Made in U.S.A.
- UL Verified
- Low Smoke Plenum construction
- Tested from 1 to 555 MHz
- Small O.D. allows more cables per conduit
- Proven shield technology improves RFI and EMI performance

## Packaging

- 1,000 foot (305 m) reels
- Reverse sequential footage markings standard on each 1,000 foot package
- Unit/pallet: 12  
 CMP Carton Weight (lbs): 43.63  
 CMP Product Weight (lbs): 40.33  
\*weight may vary, call for CMR information

## Applications

- Including:
  - 10 Gigabit Ethernet (IEEE 802.3an)
  - 5 Gigabit Ethernet (IEEE 802.3bz)
  - 2.5 Gigabit Ethernet (IEEE 802.3bz)
  - Gigabit Ethernet (IEEE 802.3ab)
  - 100 Mbps Ethernet (IEEE 802.3u)
  - 1000 Mbps ATM
  - 622 Mbps ATM
  - 15W PoE (IEEE 802.3af)
  - 30W PoE+ (IEEE 802.3at)
  - 60W PoE++ (IEEE 802.3bt Type 3)
  - 100W PoE++ (IEEE 802.3bt Type 4)

## Temp. Range

- Storage Temperature  
 -40°C to +60°C  
 (-40°F to +140°F)
- Installation Temperature  
 0°C to +60°C  
 (+32°F to +140°F)
- Operation Temperature  
 -20°C to +75°C  
 (-4°F to +167°F)

## Category 6 F/UTP (Plenum)

c(UL)us Listed Type CMP (NFPA 262), CSA Type FT6

PART #	# OF PAIRS	CALCULATED CABLE O.D.		CABLE WEIGHT	
		inches	mm	lbs/1000 ft	kg/305 m
30154-8-XXY	4	0.275	6.98	40.33	18.29

## Category 6 F/UTP (Riser)

c(UL)us Listed Type CMR (UL 1666), CSA Type FT4

PART #	# OF PAIRS	CALCULATED CABLE O.D.		CABLE WEIGHT	
		inches	mm	lbs/1000 ft	kg/305 m
30129-8-XXY	4	0.29	7.37	39.02	17.70

## Building a Part Number

Base Part Number Ex.	No. of Conductors	Jacket Color	Reel Type
30154	8	XX	Y

Jacket Colors (XX):

Black (BK); Blue (BL); Brown (BR); Gray (GA); Green (GR); Red (RD); White (WH); Violet (VI); Yellow (YE)

Reel Type (Y):

Reels (3)

## Features

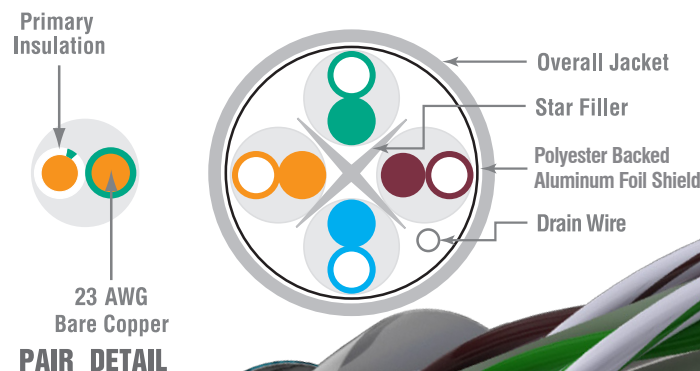

### DIELECTRIC MATERIALS

#### PLENUM

Primary Insulation: Plenum-rated fluoropolymer  
 Overall Jacket: Low-smoke, flame-retardant thermoplastic  
 Star Filler: Plenum-rated polymer

#### RISER

Primary Insulation: Flame-retardant Thermoplastic  
 Overall Jacket: Flame-retardant Thermoplastic  
 Star Filler: Flame-retardant Thermoplastic

Hitachi Cable America reserves the right to revise any specifications.



# Cat 6 F/UTP

## Transmission Specifications

ANSI/TIA-568.2-D Category 6 Verified  
ISO/IEC 11801, 2nd ed. Class E Compliant

Freq. (MHz)	Ins. Loss		NEXT		PSNEXT		ACR		PSACR		ACRF		PSACRF		Return Loss	
	Std.	Max.	Std.	Min.	Std.	Min.	Cal.	Min.	Cal.	Min.	Std.	Min.	Std.	Min.	Std.	Min.
1	2.0	2.0	74.3	74.3	72.3	72.3	72.3	72.3	70.3	70.3	67.8	67.8	64.8	64.8	20.0	20.0
4	3.8	3.8	65.3	65.3	63.3	63.3	61.5	61.5	59.5	59.5	55.8	55.8	52.8	52.8	23.0	23.0
8	5.3	5.3	60.8	60.8	58.8	58.8	55.4	55.4	53.4	53.4	49.7	49.7	46.7	46.7	24.5	24.5
10	6.0	6.0	59.3	59.3	57.3	57.3	53.3	53.3	51.3	51.3	47.8	47.8	44.8	44.8	25.0	25.0
16	7.6	7.6	56.2	56.2	54.2	54.2	48.7	48.7	46.7	46.7	43.7	43.7	40.7	40.7	25.0	25.0
31.25	10.7	10.7	51.9	51.9	49.9	49.9	41.2	41.2	39.2	39.2	37.9	37.9	34.9	34.9	23.6	23.6
62.5	15.4	15.4	47.4	47.4	45.4	45.4	32.0	32.0	30.0	30.0	31.9	21.9	28.9	28.9	21.5	21.5
100	19.8	19.8	44.3	44.3	42.3	42.3	24.5	24.5	22.5	22.5	27.8	27.8	24.8	24.8	20.1	20.1
200	29.0	29.0	39.8	39.8	37.8	37.8	10.8	10.8	8.8	8.8	21.8	21.8	18.8	18.8	18.0	18.0
250	32.8	32.8	38.3	38.3	36.3	36.3	5.5	5.5	3.5	3.5	19.8	19.8	16.8	16.8	17.3	17.3
350*	-	39.8	-	36.1	-	34.1	-	-	-	-	-	16.9	-	13.9	-	16.3
555*	-	52.0	-	33.1	-	31.1	-	-	-	-	-	12.9	-	9.9	-	14.9
660*	-	57.7	-	32.0	-	30.0	-	-	-	-	-	11.4	-	8.4	-	14.4

\*Frequencies beyond the TIA and ISO requirements are for information only. All values are dB/100m.



Copper

Photo is for representation purposes only.

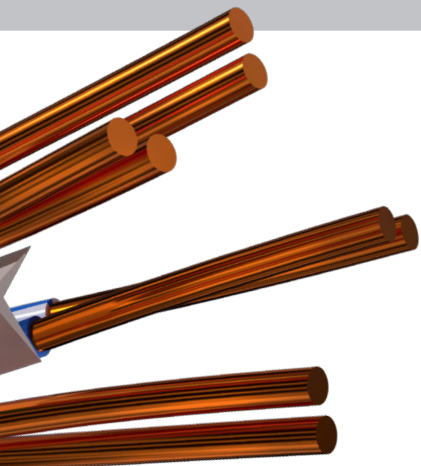

## Electrical Characteristics

Input Impedance:	100 ± 15Ω (1.0 to 100 MHz) 100 ± 20Ω (100 to 250 MHz) 100 ± 25Ω (251 to 500 MHz)
Maximum Resistance Unbalance:	5%
Maximum Capacitance Unbalance:	330 pF/100 meters
Maximum Delay Skew:	45 ns/100 meters
Nominal Velocity Of Propagation (Nvp):	70%, Plenum 68%, Riser
Voltage Rating:	300 Volts

Cable Ampacity Chart							
Bundle Size	1	2-7	8-19	20-37	38-61	62-91	92-192
Cable Temp	75°C	75°C	75°C	75°C	75°C	75°C	75°C
23 AWG	2.5	1.5	1.1	0.8	0.7	0.7	0.5

The table above is derived from the one approved by the National Fire Protection Agency and used in the National Electrical Code, NFPA-70. The complete table can be found in sections 725.144 and 800 Communication Circuits of the code. The table identifies the ampacity of each conductor (in amperes) in a 4-pair Class 2 or Class 3 data cable. Ambient temperature used for development of the table is 30°C (86°F) with all conductors in all cables carrying current. The table is based on 60°C (140°F), 75°C (167°F) and 90°C (194°F) rated cables. All cable temps are operational temp ratings. Cables with temp ratings above 90c would deliver additional power handling capacity.

# Indoor

UTP

Copper

## Product Highlights

- REACH & RoHS 2 compliant
- Made in U.S.A.
- UL Verified
- Low Smoke Plenum construction
- Tested from 1 to 400 MHz
- CMR-LSZH version offers a halogen free design for improved environmental performance

## Packaging

- 1,000 feet (305 m)
- Reverse sequential footage markings standard on each 1,000 foot package
- Unit/pallet: 32 Reels  
CMP Carton Weight (lbs): 23.66  
CMP Product Weight (lbs): 20.36  
\*weight may vary, call for CMR information

## Options

- CMP-50 rated cables available
- Reel-in-a-box available for Plenum

## Applications

- Including:
  - Gigabit Ethernet (IEEE 802.3ab)
  - 100 Mbps Ethernet (IEEE 802.3u)
  - 1000 Mbps ATM
  - 622 Mbps ATM
  - 15W PoE (IEEE 802.3af)
  - 30W PoE+ (IEEE 802.3at)
  - 60W PoE++ (IEEE 802.3bt Type 3)
  - 100W PoE++ (IEEE 802.3bt Type 4)

## Temp. Range

- Storage Temperature  
-40°C to +60°C  
(-40°F to +140°F)
- Installation Temperature  
0°C to +60°C  
(+32°F to +140°F)
- Operation Temperature  
-20°C to +75°C  
(-4°F to +167°F)

## Category 5e UTP (Plenum)

c(UL)us Listed Type CMP (NFPA 262), CSA Type FT6

PART #	# OF PAIRS	CALCULATED CABLE O.D.		CABLE WEIGHT	
		inches	mm	lbs/1000 ft	kg/305 m
39419-8-XXY	4	0.18	4.57	20.36	9.24

## Category 5e UTP (Riser)

c(UL)us Listed Type CMR (UL 1666), CSA Type FT4

PART #	# OF PAIRS	CALCULATED CABLE O.D.		CABLE WEIGHT	
		inches	mm	lbs/1000 ft	kg/305 m
38696-8-XXY	4	0.17	4.55	17.86	8.10

## Building a Part Number

Base Part Number Ex.	No. of Conductors	Jacket Color	Reel Type
39419	8	XX	Y

Jacket Colors (XX):

Black (BK); Blue (BL); Brown (BR); Gray (GA); Green (GR); Red (RD); White (WH); Violet (VI); Yellow (YE)

Reel Type (Y):

Reellex Boxes (2); Reels (3)

## Features

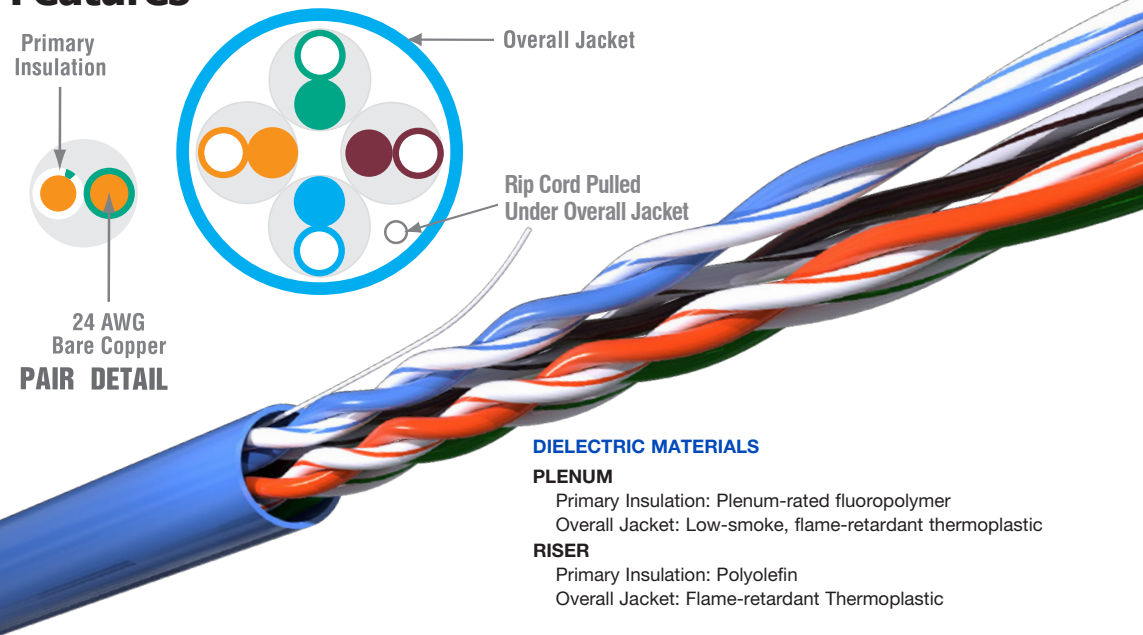

### DIELECTRIC MATERIALS

#### PLENUM

Primary Insulation: Plenum-rated fluoropolymer  
Overall Jacket: Low-smoke, flame-retardant thermoplastic

#### RISER

Primary Insulation: Polyolefin  
Overall Jacket: Flame-retardant Thermoplastic

Hitachi Cable America reserves the right to revise any specifications.

# Cat 5e

## Transmission Specifications

ANSI/TIA-568.2-D Category 5e Verified  
ISO/IEC 11801, 2nd ed. Class D Compliant

Freq. (MHz)	Ins. Loss		NEXT		PSNEXT		ACR		PSACR		ACRF		PSACRF		Return Loss	
	Std.	Max.	Std.	Min.	Std.	Min.	Cal.	Min.	Cal.	Min.	Std.	Min.	Std.	Min.	Std.	Min.
1	2.0	2.0	65.3	65.3	62.3	62.3	63.3	63.3	60.3	60.3	63.8	63.8	60.8	60.8	20.0	20.0
4	4.1	4.1	56.3	56.3	53.3	53.3	52.2	52.2	49.2	49.2	51.8	51.8	48.8	48.8	23.0	23.0
8	5.8	5.8	51.8	51.8	48.8	48.8	46.0	46.0	43.0	43.0	45.7	45.7	42.7	42.7	24.5	24.5
10	6.5	6.5	50.3	50.3	47.3	47.3	43.8	43.8	40.8	40.8	43.8	43.8	40.8	40.8	25.0	25.0
16	8.2	8.2	47.2	47.2	44.2	44.2	39.0	39.0	36.0	36.0	39.7	39.7	36.7	36.7	25.0	25.0
31.25	11.7	11.7	42.9	42.9	39.9	39.9	31.2	31.2	28.2	28.2	33.9	33.9	30.9	30.9	23.6	23.6
62.5	17.0	17.0	38.4	38.4	35.4	35.4	21.4	21.4	18.4	18.4	27.9	27.9	24.9	24.9	21.5	21.5
100	22.0	22.0	35.3	35.3	32.3	32.3	13.3	13.3	10.3	10.3	23.8	23.8	20.8	20.8	20.1	20.1
155*	-	28.1	-	32.4	-	29.4	4.4	4.4	1.4	1.4	-	20.0	-	17.0	-	18.8
200*	-	32.4	-	30.8	-	27.8	-	-	-	-	-	17.8	-	14.8	-	18.0
250*	-	36.9	-	29.3	-	26.3	-	-	-	-	-	15.8	-	12.8	-	17.3
400*	-	48.5	-	26.3	-	23.3	-	-	-	-	-	11.8	-	8.8	-	15.9

\*Frequencies beyond the TIA and ISO requirements are for information only. All values are dB/100m.



Copper

Photo is for representation purposes only.

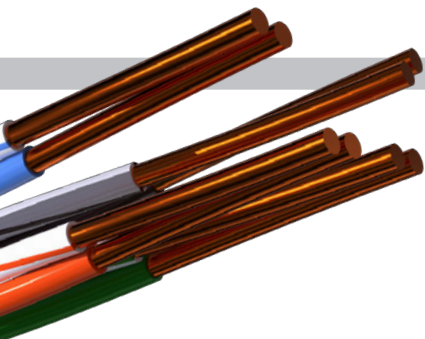

## Electrical Characteristics

Input Impedence:	100 ± 15Ω (1.0 to 100 MHz)
Maximum Resistance Unbalance:	5%
Maximum Capacitance Unbalance:	330 pF/100 meters
Maximum Delay Skew:	45 ns/100 meters
Nominal Velocity Of Propagation (Nvp):	70%, Plenum 68%, Riser
Voltage Rating:	300 Volts

Cable Ampacity Chart							
Bundle Size	1	2-7	8-19	20-37	38-61	62-91	92-192
Cable Temp	75°C	75°C	75°C	75°C	75°C	75°C	75°C
24 AWG	2.0	1.4	1.0	0.7	0.6	0.5	0.4

The table above is derived from the one approved by the National Fire Protection Agency and used in the National Electrical Code, NFPA-70. The complete table can be found in sections 725.144 and 800 Communication Circuits of the code. The table identifies the ampacity of each conductor (in amperes) in a 4-pair Class 2 or Class 3 data cable. Ambient temperature used for development of the table is 30°C (86° F) with all conductors in all cables carrying current. The table is based on 60°C (140°F), 75°C (167°F) and 90°C (194°F) rated cables. All cable temps are operational temp ratings. Cables with temp ratings above 90c would deliver additional power handling capacity.

# Indoor

## Enhanced UTP

Copper

### Product Highlights

- REACH & RoHS 2 compliant
- Made in U.S.A.
- UL Verified
- Low Smoke Plenum construction
- Tested from 1 to 400 MHz

TIA Parameter	Guaranteed Headroom
NEXT loss	+6 dB
PSNEXT loss	+6 dB
ELFEXT	+4 dB
PSELFEXT	+4 dB
Return Loss	N/A

### Packaging

- 1,000 feet (305 m)
- Reverse sequential footage markings standard on each 1,000 foot package
- Unit/pallet: 32 Reels  
CMP Carton Weight (lbs): 23.66  
CMP Product Weight (lbs): 20.36  
\*weight may vary, call for CMR information

### Options

- CMP-50 rated cables available
- Reel-in-a-box available for Plenum

### Applications

- Including:
  - Gigabit Ethernet (IEEE 802.3ab)
  - 100 Mbps Ethernet (IEEE 802.3u)
  - 1000 Mbps ATM
  - 622 Mbps ATM
  - 15W PoE (IEEE 802.3af)
  - 30W PoE+ (IEEE 802.3at)
  - 60W PoE++ (IEEE 802.3bt Type 3)
  - 100W PoE++ (IEEE 802.3bt Type 4)

### Temp. Range

- Storage Temperature  
-40°C to +60°C  
(-40°F to +140°F)
- Installation Temperature  
0°C to +60°C  
(+32°F to +140°F)
- Operation Temperature  
-20°C to +75°C  
(-4°F to +167°F)

## 350™ UTP (Plenum)

c(UL)us Listed Type CMP (NFPA 262), CSA Type FT6

PART #	# OF PAIRS	CALCULATED CABLE O.D.		CABLE WEIGHT	
		inches	mm	lbs/1000 ft	kg/305 m
38891-8-XXY	4	0.18	4.67	20.36	9.24

## 350™ UTP (Riser)

c(UL)us Listed Type CMR (UL 1666), CSA Type FT4

PART #	# OF PAIRS	CALCULATED CABLE O.D.		CABLE WEIGHT	
		inches	mm	lbs/1000 ft	kg/305 m
38893-8-XXY	4	0.179	4.547	17.86	8.10

### Building a Part Number

Base Part Number Ex.	No. of Conductors	Jacket Color	Reel Type
38891	8	XX	Y

Jacket Colors (XX):

Black (BK); Blue (BL); Brown (BR); Gray (GA); Green (GR); Red (RD); White (WH); Violet (VI); Yellow (YE)

Reel Type (Y):

Reel Boxes (2); Reels (3)

## Features

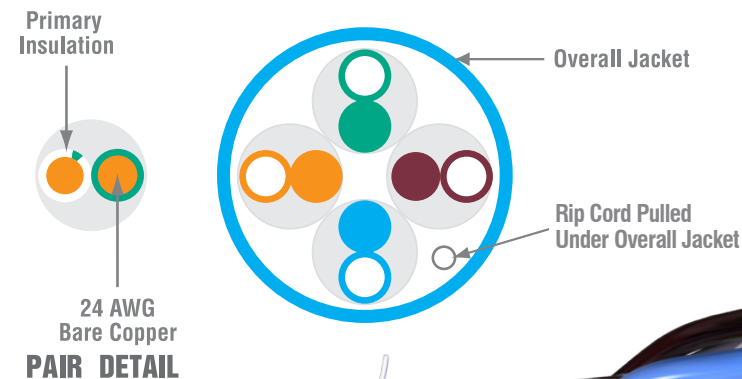

### DIELECTRIC MATERIALS

#### PLENUM

Primary Insulation: Plenum-rated fluoropolymer  
Overall Jacket: Low-smoke, flame-retardant thermoplastic

#### RISER

Primary Insulation: Polyolefin  
Overall Jacket: Flame-retardant Thermoplastic

Hitachi Cable America reserves the right to revise any specifications.

# Cat 5e 350™

## Transmission Specifications ANSI/TIA-568.2-D Category 5e Verified ISO/IEC 11801, 2nd ed. Class D Compliant

Freq. (MHz)	Ins. Loss		NEXT		PSNEXT		ACR		PSACR		ACRF		PSACRF		Return Loss	
	Std.	Max.	Std.	Min.	Std.	Min.	Cal.	Min.	Cal.	Min.	Std.	Min.	Std.	Min.	Std.	Min.
1	2.0	2.0	65.3	71.3	62.3	68.3	63.3	69.3	60.3	66.3	63.8	67.8	60.8	64.8	20.0	20.0
4	4.1	4.1	56.3	62.3	53.3	59.3	52.2	58.2	49.2	55.2	51.8	55.8	48.8	52.8	23.0	23.0
8	5.8	5.8	51.8	57.8	48.8	54.8	46.0	52.0	43.0	49.0	45.7	49.7	42.7	46.7	24.5	24.5
10	6.5	6.5	50.3	56.3	47.3	53.3	43.8	49.8	40.8	46.8	43.8	47.8	40.8	44.8	25.0	25.0
16	8.2	8.2	47.2	53.2	44.2	50.2	39.0	45.0	36.0	42.0	39.7	43.7	36.7	40.7	25.0	25.0
31.25	11.7	11.7	42.9	48.9	39.9	45.9	31.2	37.2	28.2	34.2	33.9	37.9	30.9	34.9	23.6	23.6
62.5	17.0	17.0	38.4	44.4	35.4	41.4	21.4	27.4	18.4	24.4	27.9	31.9	24.9	28.9	21.5	21.5
100	22.0	22.0	35.3	41.3	32.3	38.3	13.3	19.3	10.3	16.3	23.8	27.8	20.8	24.8	20.1	20.1
155*	-	28.1	-	38.4	-	35.4	4.4	10.4	1.4	7.4	-	24.0	-	21.0	-	18.8
200*	-	32.4	-	36.8	-	33.8	-	4.4	-	1.4	-	21.8	-	18.8	-	18.0
250*	-	36.9	-	35.3	-	32.3	-	-	-	-	-	19.8	-	16.8	-	17.3
300*	-	41.0	-	34.1	-	31.1	-	-	-	-	-	18.3	-	15.3	-	16.8
350*	-	44.9	-	33.1	-	30.1	-	-	-	-	-	16.9	-	13.9	-	16.3
400*	-	48.5	-	32.3	-	29.3	-	-	-	-	-	15.8	-	12.8	-	15.9

\*Frequencies beyond the TIA and ISO requirements are for information only. All values are dB/100m.

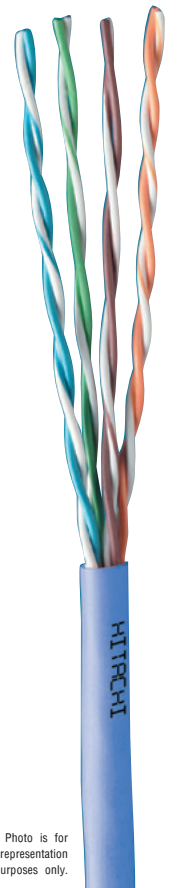

Copper

Photo is for representation purposes only.



## Electrical Characteristics

Input Impedence:	100 ± 15Ω (1.0 to 100 MHz)
Maximum conductor resistance	9.38 Ω/100 meters @ 20°C
Maximum Resistance Unbalance:	5%
Maximum Capacitance Unbalance:	330 pF/100 meters
Maximum Delay Skew:	25 ns/100 meters
Nominal Velocity Of Propagation (Nvp):	70%, Plenum 68%, Riser
Voltage Rating:	300 Volts

Cable Ampacity Chart							
Bundle Size	1	2-7	8-19	20-37	38-61	62-91	92-192
Cable Temp	75°C	75°C	75°C	75°C	75°C	75°C	75°C
24 AWG	2.0	1.4	1.0	0.7	0.6	0.5	0.4

The table above is derived from the one approved by the National Fire Protection Agency and used in the National Electrical Code, NFPA-70. The complete table can be found in sections 725.144 and 800 Communication Circuits of the code. The table identifies the ampacity of each conductor (in amperes) in a 4-pair Class 2 or Class 3 data cable. Ambient temperature used for development of the table is 30°C (86° F) with all conductors in all cables carrying current. The table is based on 60°C (140°F), 75°C (167°F) and 90°C (194°F) rated cables. All cable temps are operational temp ratings. Cables with temp ratings above 90c would deliver additional power handling capacity.

# Indoor

UTP

Copper

## Product Highlights

- REACH & RoHS 2 compliant
- Made in U.S.A.
- UL Verified
- Low Smoke Plenum construction
- Tested from 1 to 400 MHz
- UL Tested (LP) for maximum power support
- Specifically designed to accommodate higher power applications
- Utilizes larger gauge copper (22 AWG)
- Designed for applications where higher power or extended cable length is required

## Packaging

- 1,000 feet (305 m)
- Reverse sequential footage markings standard on each 1,000 foot package
- Unit/pallet: 32 Reels  
 CMP Carton Weight (lbs): 23.66  
 CMP Product Weight (lbs): 20.36  
 \*weight may vary, call for CMR information

## Options

- CMP-50 rated cables available

## Applications

- Including:
  - Gigabit Ethernet (IEEE 802.3ab)
  - 100 Mbps Ethernet (IEEE 802.3u)
  - 1000 Mbps ATM
  - 622 Mbps ATM
  - 15W PoE (IEEE 802.3af)
  - 30W PoE+ (IEEE 802.3at)
  - 60W PoE++ (IEEE 802.3bt Type 3)
  - 100W PoE++ (IEEE 802.3bt Type 4)

## Temp. Range

- Storage Temperature  
 -40°C to +60°C  
 (-40°F to +140°F)
- Installation Temperature  
 0°C to +60°C  
 (+32°F to +140°F)
- Operation Temperature  
 -20°C to +75°C  
 (-4°F to +167°F)

## Category 5e UTP (Plenum)

c(UL)us Listed Type CMP (NFPA 262), CSA Type FT6

PART #	# OF PAIRS	CALCULATED CABLE O.D.		CABLE WEIGHT	
		inches	mm	lbs/1000 ft	kg/305 m
30310-8-XXY	4	0.225	5.71	31.52	14.29

## Building a Part Number

Base Part Number Ex.	No. of Conductors	Jacket Color	Reel Type
39419	8	XX	Y

Jacket Colors (XX):

Black (BK); Blue (BL); Brown (BR); Gray (GA); Green (GR); Red (RD); White (WH); Violet (VI); Yellow (YE)

Reel Type (Y):

Reel Boxes (2); Reels (3)

## Features

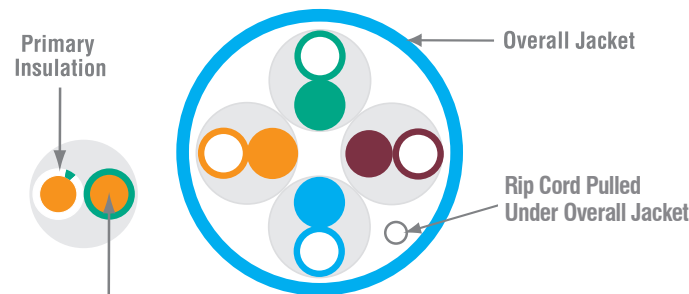

24 AWG  
Bare Copper  
**PAIR DETAIL**

## DIELECTRIC MATERIALS

### PLENUM

Primary Insulation: Plenum-rated fluoropolymer  
 Overall Jacket: Low-smoke, flame-retardant thermoplastic

Hitachi Cable America reserves the right to revise any specifications.

# Cat 5e Power+™

## Transmission Specifications ANSI/TIA-568.2-D Category 5e Verified ISO/IEC 11801, 2nd ed. Class D Compliant

Freq. (MHz)	Ins. Loss		NEXT		PSNEXT		ACR		PSACR		ACRF		PSACRF		Return Loss	
	Std.	Max.	Std.	Min.	Std.	Min.	Cal.	Min.	Cal.	Min.	Std.	Min.	Std.	Min.	Std.	Min.
1	2.0	2.0	65.3	65.3	62.3	62.3	63.3	63.3	60.3	60.3	63.8	63.8	60.8	60.8	20.0	20.0
4	4.1	4.1	56.3	56.3	53.3	53.3	52.2	52.2	49.2	49.2	51.8	51.8	48.8	48.8	23.0	23.0
8	5.8	5.8	51.8	51.8	48.8	48.8	46.0	46.0	43.0	43.0	45.7	45.7	42.7	42.7	24.5	24.5
10	6.5	6.5	50.3	50.3	47.3	47.3	43.8	43.8	40.8	40.8	43.8	43.8	40.8	40.8	25.0	25.0
16	8.2	8.2	47.2	47.2	44.2	44.2	39.0	39.0	36.0	36.0	39.7	39.7	36.7	36.7	25.0	25.0
31.25	11.7	11.7	42.9	42.9	39.9	39.9	31.2	31.2	28.2	28.2	33.9	33.9	30.9	30.9	23.6	23.6
62.5	17.0	17.0	38.4	38.4	35.4	35.4	21.4	21.4	18.4	18.4	27.9	27.9	24.9	24.9	21.5	21.5
100	22.0	22.0	35.3	35.3	32.3	32.3	13.3	13.3	10.3	10.3	23.8	23.8	20.8	20.8	20.1	20.1
155*	-	28.1	-	32.4	-	29.4	4.4	4.4	1.4	1.4	-	20.0	-	17.0	-	18.8
200*	-	32.4	-	30.8	-	27.8	-	-	-	-	-	17.8	-	14.8	-	18.0
250*	-	36.9	-	29.3	-	26.3	-	-	-	-	-	15.8	-	12.8	-	17.3
400*	-	48.5	-	26.3	-	23.3	-	-	-	-	-	11.8	-	8.8	-	15.9

\*Frequencies beyond the TIA and ISO requirements are for information only. All values are dB/100m.



Copper

Photo is for representation purposes only.

## Electrical Characteristics

Input Impedance:	100 ± 15Ω (1.0 to 100 MHz)
Maximum Resistance Unbalance:	5%
Maximum Capacitance Unbalance:	330 pF/100 meters
Maximum Delay Skew:	45 ns/100 meters
Nominal Velocity Of Propagation (Nvp):	70%, Plenum
Voltage Rating:	300 Volts
LP Rating (UL):	.7 Amps/conductor

Note: This is a 22 AWG cable with 105c rating. Its Ampacity performance exceeds the maximum listed in the Ampacity table found in NEC 725.144 of the current electrical code.

Cable Ampacity Chart							
Bundle Size	1	2-7	8-19	20-37	38-61	62-91	92-192
Cable Temp	75°C	75°C	75°C	75°C	75°C	75°C	75°C
24 AWG	2.0	1.4	1.0	0.7	0.6	0.5	0.4

The table above is derived from the one approved by the National Fire Protection Agency and used in the National Electrical Code, NFPA-70. The complete table can be found in sections 725.144 and 800 Communication Circuits of the code. The table identifies the ampacity of each conductor (in amperes) in a 4-pair Class 2 or Class 3 data cable. Ambient temperature used for development of the table is 30°C (86° F) with all conductors in all cables carrying current. The table is based on 60°C (140°F), 75°C (167°F) and 90°C (194°F) rated cables. All cable temps are operational temp ratings. Cables with temp ratings above 90c would deliver additional power handling capacity.

# Indoor

F/UTP

Copper

## Product Highlights

- REACH & RoHS 2 compliant
- Made in U.S.A.
- UL Verified
- Low Smoke Plenum construction
- Tested from 1 to 400 MHz
- Proven shield technology improves RFI and EMI performance

## Packaging

- 1,000 foot (305 m) reels
- Reverse sequential footage markings standard on each 1,000 foot package
- Unit/pallet: 20 Reels  
CMP Carton Weight (lbs): 36.63  
CMP Product Weight (lbs): 33.33  
\*weight may vary, call for CMR information

## Options

- Reellex available for F/UTP

## Applications

- Including:  
Gigabit Ethernet (IEEE 802.3ab)  
100 Mbps Ethernet (IEEE 802.3u)  
1000 Mbps ATM  
622 Mbps ATM  
15W PoE (IEEE 802.3af)  
30W PoE+ (IEEE 802.3at)  
60W PoE++ (IEEE 802.3bt Type 3)  
100W PoE++ (IEEE 802.3bt Type 4)

## Temp. Range

- Storage Temperature  
-40°C to +60°C  
(-40°F to +140°F)
- Installation Temperature  
0°C to +60°C  
(+32°F to +140°F)
- Operation Temperature  
-20°C to +75°C  
(-4°F to +167°F)

## Category 5e F/UTP (Plenum)

c(UL)us Listed Type CMP (NFPA 262), CSA Type FT6

PART #	# OF PAIRS	CALCULATED CABLE O.D.		CABLE WEIGHT	
		inches	mm	lbs/1000 ft	kg/305 m
38653-8-XXY	4	0.25	6.48	33.33	15.12

## Category 5e F/UTP (Riser)

c(UL)us Listed Type CMR (UL 1666), CSA Type FT4

PART #	# OF PAIRS	CALCULATED CABLE O.D.		CABLE WEIGHT	
		inches	mm	lbs/1000 ft	kg/305 m
39092-8-XXY	4	0.25	6.48	30.93	14.03

## Building a Part Number

Base Part Number Ex.	No. of Conductors	Jacket Color	Reel Type
38653	8	XX	Y

Jacket Colors (XX):  
Black (BK)

Reel Type (Y):  
Reels (3)

## Features



### DIELECTRIC MATERIALS

#### PLENUM

Primary Insulation: Plenum-rated fluoropolymer  
Overall Jacket: Low-smoke, flame-retardant thermoplastic

#### RISER

Primary Insulation: Polyolefin  
Overall Jacket: Flame-retardant Thermoplastic

Hitachi Cable America reserves the right to revise any specifications.



# Cat 5e F/UTP

## Transmission Specifications

ANSI/TIA-568.2-D Category 5e Verified  
ISO/IEC 11801, 2nd ed. Class D Compliant

Freq (MHz)	Ins. Loss		NEXT		PSNEXT		ACR		PSACR		ACRF		PSACRF		Return Loss	
	Std.	Max.	Std.	Min.	Std.	Min.	Cal.	Min.	Cal.	Min.	Std.	Min.	Std.	Min.	Std.	Min.
1	2.0	2.0	65.3	65.3	62.3	62.3	63.3	63.3	60.3	60.3	63.8	63.8	60.8	60.8	20.0	20.0
4	4.1	4.1	56.3	56.3	53.3	53.3	52.2	52.2	49.2	49.2	51.8	51.8	48.8	48.8	23.0	23.0
8	5.8	5.8	51.8	51.8	48.8	48.8	46.0	46.0	43.0	43.0	45.7	45.7	42.7	42.7	24.5	24.5
10	6.5	6.5	50.3	50.3	47.3	47.3	43.8	43.8	40.8	40.8	43.8	43.8	40.8	40.8	25.0	25.0
16	8.2	8.2	47.2	47.2	44.2	44.2	39.0	39.0	36.0	36.0	39.7	39.7	36.7	36.7	25.0	25.0
31.25	11.7	11.7	42.9	42.9	39.9	39.9	31.2	31.2	28.2	28.2	33.9	33.9	30.9	30.9	23.6	23.6
62.5	17.0	17.0	38.4	38.4	35.4	35.4	21.4	21.4	18.4	18.4	27.9	27.9	24.9	24.9	21.5	21.5
100	22.0	22.0	35.3	35.3	32.3	32.3	13.3	13.3	10.3	10.3	23.8	23.8	20.8	20.8	20.1	20.1
155*	-	28.1	-	32.4	-	29.4	4.3	4.3	1.3	1.3	-	20.0	-	17.0	-	18.8
200*	-	32.4	-	30.8	-	27.8	-	-	-	-	-	17.8	-	14.8	-	18.0
250*	-	36.9	-	29.3	-	26.3	-	-	-	-	-	15.8	-	12.8	-	17.3
400*	-	48.5	-	26.3	-	23.3	-	-	-	-	-	11.8	-	8.8	-	15.9

\*Frequencies beyond the TIA and ISO requirements are for information only. All values are dB/100m.



Copper

Photo is for representation purposes only.



## Electrical Characteristics

Input Impedance:	100 ± 15Ω (1.0 to 100 MHz)
Maximum Resistance Unbalance:	3%
Maximum Capacitance Unbalance:	330 pF/100 meters
Maximum Delay Skew:	45 ns/100 meters
Nominal Velocity Of Propagation (Nvp):	70%, Plenum 68%, Riser
Voltage Rating:	300 Volts

Cable Ampacity Chart							
Bundle Size	1	2-7	8-19	20-37	38-61	62-91	92-192
Cable Temp	75°C	75°C	75°C	75°C	75°C	75°C	75°C
24 AWG	2.0	1.4	1.0	0.7	0.6	0.5	0.4

The table above is derived from the one approved by the National Fire Protection Agency and used in the National Electrical Code, NFPA-70. The complete table can be found in sections 725.144 and 800 Communication Circuits of the code. The table identifies the ampacity of each conductor (in amperes) in a 4-pair Class 2 or Class 3 data cable. Ambient temperature used for development of the table is 30°C (86° F) with all conductors in all cables carrying current. The table is based on 60°C (140°F), 75°C (167°F) and 90°C (194°F) rated cables. All cable temps are operational temp ratings. Cables with temp ratings above 90c would deliver additional power handling capacity.

# Indoor

S/FTP

Copper

## Product Highlights

- REACH & RoHS 2 compliant
- Made in U.S.A.
- Low Smoke Plenum construction
- Tested to 1 GHz
- Compliant to ISO 11801 Class FA (Category 7A) Requirements
- Conductor pairs are individually wrapped in foil
- Overall braid

## Packaging

- 1,000 foot (305 m) reels
- Reverse sequential footcage markings standard on each 1,000 foot package
- Unit/pallet: 12  
 CMP Carton Weight (lbs): 60.4  
 CMP Product Weight (lbs): 57.1  
\*weight may vary, call for CMR information

## Applications

- Including:
  - HDBase-T A & B
  - 10 Gigabit Ethernet (IEEE 802.3an)
  - 5 Gigabit Ethernet (IEEE 802.3bz)
  - 2.5 Gigabit Ethernet (IEEE 802.3bz)
  - Gigabit Ethernet (IEEE 802.3ab)
  - 100 Mbps Ethernet (IEEE 802.3u)
  - 1000 Mbps ATM
  - 622 Mbps ATM
  - 15W PoE (IEEE 802.3af)
  - 30W PoE+ (IEEE 802.3at)
  - 60W PoE++ (IEEE 802.3bt Type 3)
  - 100W PoE++ (IEEE 802.3bt Type 4)

## Temp. Range

- Storage Temperature  
 -40°C to +60°C  
 (-40°F to +140°F)
- Installation Temperature  
 0°C to +60°C  
 (+32°F to +140°F)
- Operation Temperature
  - Plenum**  
 -20°C to +105°C  
 (-4°F to +221°F)
  - Riser/Low Smoke HF**  
 -20°C to +75°C  
 (-4°F to +167°F)

## Category 7A S/FTP (Plenum)

c(UL)us Listed Type CMP (NFPA 262), CSA Type FT6

PART #	# OF PAIRS	CALCULATED CABLE O.D.		CABLE WEIGHT	
		inches	mm	lbs/1000 ft	kg/305 m
30250-8-XXY	4	0.326	8.28	57.10	25.90

## Category 7A S/FTP (Riser-Low Smoke Zero Halogen)

c(UL)us Listed Type CMR (UL 1666), CSA Type FT44

PART #	# OF PAIRS	CALCULATED CABLE O.D.		CABLE WEIGHT	
		inches	mm	lbs/1000 ft	kg/305 m
30305-8-XXY	4	0.325	8.25	55.10	24.99

## Building a Part Number

Base Part Number Ex.	No. of Conductors	Jacket Color	Reel Type
30250	8	XX	Y

Jacket Colors (XX):

Black (BK); Blue (BL); Brown (BR); Gray (GA); Green (GR); Red (RD); White (WH); Violet (VI); Yellow (YE)

Reel Type (Y):

Reels (3)

## Features

Primary Insulation

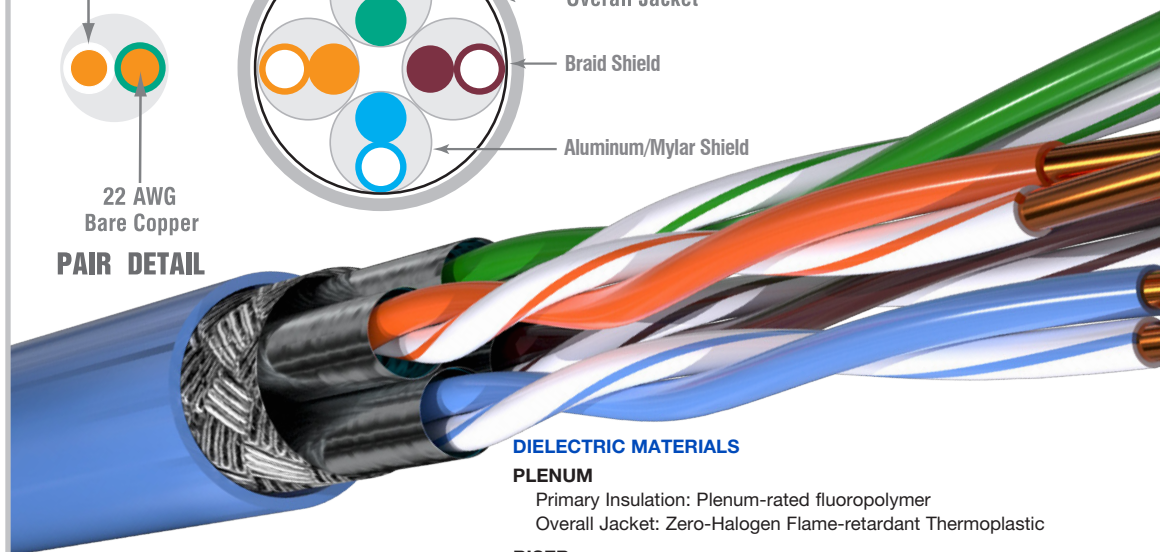
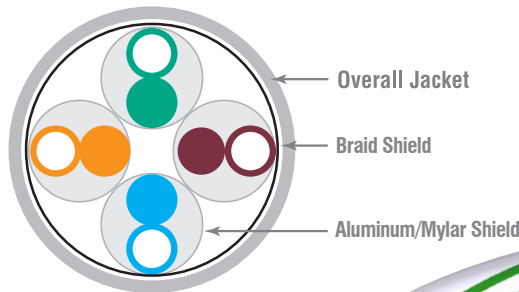
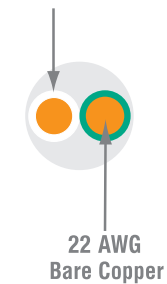

### DIELECTRIC MATERIALS

#### PLENUM

Primary Insulation: Plenum-rated fluoropolymer  
 Overall Jacket: Zero-Halogen Flame-retardant Thermoplastic

#### RISER

Primary Insulation: High-density Polyethylene  
 Overall Jacket: Zero-Halogen Flame-retardant Thermoplastic

Hitachi Cable America reserves the right to revise any specifications.

# Cat 7A S/FTP

## Transmission Specifications ANSI/TIA-568.2-D IEC 61156-5, 2nd ed. Category 7A Compliant

Freq. (MHz)	Ins.Loss	NEXT	PS NEXT	ACR	PSACR	ACRF	PSACRF	TCL	ELTCTL	Return Loss	CA (Type1)
	Max	Min	Min	Cal. Min	Cal. Min	Min	Min	Min	Min	Min	Min
4	3.7	78.0	75.0	74.3	71.3	78.0	75.0	34.0	23.0	23.0	-
8	5.2	78.0	75.0	72.8	69.8	77.2	74.2	31.0	16.9	24.5	-
10	5.8	78.0	75.0	72.2	69.2	75.3	72.3	30.0	15.0	25.0	-
16	7.3	78.0	75.0	70.7	67.7	71.2	68.2	28.0	10.9	25.0	-
20	8.2	78.0	75.0	69.8	66.8	69.3	66.3	27.0	9.0	25.0	-
25	9.2	78.0	75.0	68.8	65.8	67.3	64.3	26.0	7.0	24.3	-
31.25	10.3	78.0	75.0	67.7	64.7	65.4	62.4	25.1	5.1	23.6	85.0
62.5	14.6	78.0	75.0	63.4	60.4	59.4	56.4	22.0	-	21.5	85.0
100	18.5	75.4	72.4	56.9	53.9	55.3	52.3	20.0	-	20.1	85.0
200	26.5	70.9	67.9	44.4	41.4	49.3	46.3	17.0	-	18.0	79.0
300	32.7	68.2	65.2	35.6	32.6	45.8	42.8	-	-	17.3	75.5
400	38.0	66.4	63.4	28.4	25.4	43.3	40.3	-	-	17.3	73.0
500	42.8	64.9	61.9	22.2	19.2	41.3	38.3	-	-	17.3	71.0
600	47.1	63.7	60.7	16.6	13.6	39.7	36.7	-	-	17.3	69.4
700	51.1	62.7	59.7	11.6	8.6	38.4	35.4	-	-	17.3	68.1
800	54.9	61.9	58.8	7.0	3.9	37.2	34.2	-	-	17.3	66.9
900	58.5	61.1	58.1	2.6	-	36.2	33.2	-	-	17.3	65.9
1000	61.9	60.4	57.4			35.3	32.3			17.3	65.0

All values are dB/100m.

Photo is for representation purposes only.



Copper



## Electrical Characteristics

Maximum Resistance Unbalance:	2% (Within Pairs), 4% (Between Pairs)
Maximum Capacitance Unbalance:	160 pF/100 meters
Maximum Delay Skew:	125 ns/100 meters
Nominal Velocity Of Propagation (Nvp):	82%
Voltage Rating:	300 Volts
LP Rating (UL) - CMP	0.9 Amps/conductor

Cable Ampacity Chart

Bundle Size	1		2-7		8-19		20-37		38-61		62-91		92-192	
	75C	90C	75C	90C	75C	90C	75C	90C	75C	90C	75C	90C	75C	90C
22 AWG	3.0	3.0	1.8	2.1	1.2	1.4	0.9	1.1	0.8	0.9	0.7	0.8	0.6	0.7

The table above is derived from the one approved by the National Fire Protection Agency and used in the National Electrical Code, NFPA-70. The complete table can be found in sections 725.144 and 800 Communication Circuits of the code. The table identifies the ampacity of each conductor (in amperes) in a 4-pair Class 2 or Class 3 data cable. Ambient temperature used for development of the table is 30°C (86° F) with all conductors in all cables carrying current. The table is based on 60°C (140°F), 75°C (167°F) and 90°C (194°F) rated cables. All cable temps are operational temp ratings. Cables with temp ratings above 90c would deliver additional power handling capacity.

# Indoor

S/FTP

Copper

## Product Highlights

- REACH & RoHS 2 compliant
- Made in U.S.A.
- Low Smoke Plenum construction
- Tested to 600 MHz
- Compliant to ISO 11801 Class F (Category 7) Requirements
- Conductor pairs are individually wrapped in foil
- Overall braid

## Packaging

- 1,000 foot (305 m) reels
- Reverse sequential footage markings standard on each 1,000 foot package
- Unit/pallet: 12  
 CMP Carton Weight (lbs): 60.4  
 CMP Product Weight (lbs): 57.1  
\*weight may vary, call for CMR information

## Applications

- Including:
  - HDBase-T A & B
  - 10 Gigabit Ethernet (IEEE 802.3an)
  - 5 Gigabit Ethernet (IEEE 802.3bz)
  - 2.5 Gigabit Ethernet (IEEE 802.3bz)
  - Gigabit Ethernet (IEEE 802.3ab)
  - 100 Mbps Ethernet (IEEE 802.3u)
  - 1000 Mbps ATM
  - 622 Mbps ATM
  - 15W PoE (IEEE 802.3af)
  - 30W PoE+ (IEEE 802.3at)
  - 60W PoE++ (IEEE 802.3bt Type 3)
  - 100W PoE++ (IEEE 802.3bt Type 4)

## Temp. Range

- Storage Temperature  
 -40°C to +60°C  
 (-40°F to +140°F)
- Installation Temperature  
 0°C to +60°C  
 (+32°F to +140°F)
- Operation Temperature
  - Plenum**  
 -20°C to +105°C  
 (-4°F to +221°F)
  - Riser/Low Smoke HF**  
 -20°C to +75°C  
 (-4°F to +167°F)

## Category 7 S/FTP (Plenum)

c(UL)us Listed Type CMP (NFPA 262), CSA Type FT6

PART #	# OF PAIRS	CALCULATED CABLE O.D.		CABLE WEIGHT	
		inches	mm	lbs/1000 ft	kg/305 m
30245-8-XXY	4	0.326	8.28	57.10	25.90

## Category 7 S/FTP (Riser-Low Smoke Zero Halogen)

c(UL)us Listed Type CMR (UL 1666), CSA Type FT44

PART #	# OF PAIRS	CALCULATED CABLE O.D.		CABLE WEIGHT	
		inches	mm	lbs/1000 ft	kg/305 m
30319-8-XXY	4	0.326	8.25	55.10	24.99

## Building a Part Number

Base Part Number Ex.	No. of Conductors	Jacket Color	Reel Type
30245	8	XX	Y

Jacket Colors (XX):

Black (BK); Blue (BL); Brown (BR); Gray (GA); Green (GR); Red (RD); White (WH); Violet (VI); Yellow (YE)

Reel Type (Y):

Reels (3)

## Features

Primary Insulation

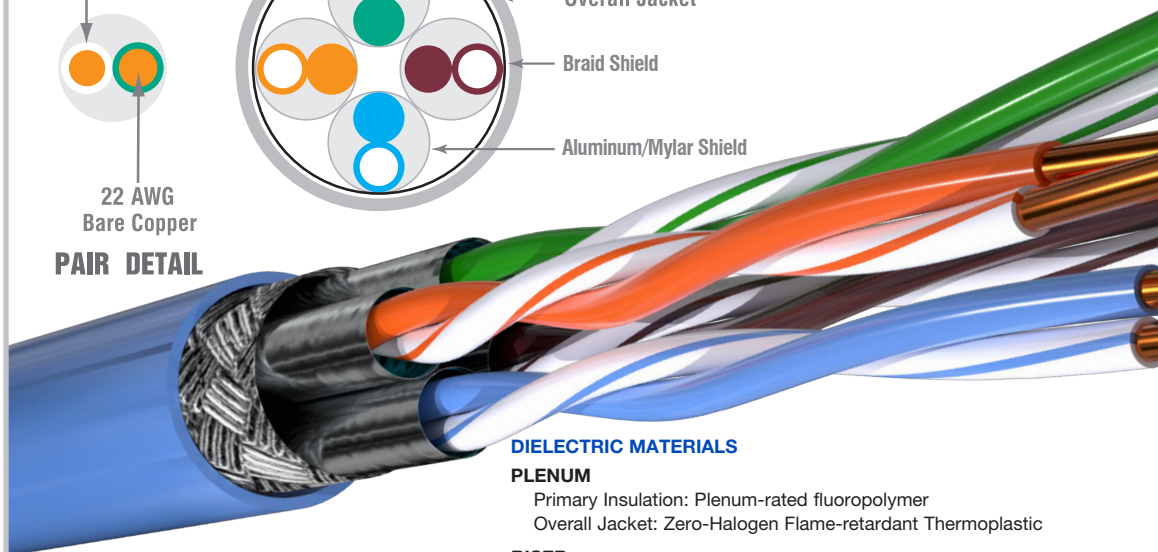
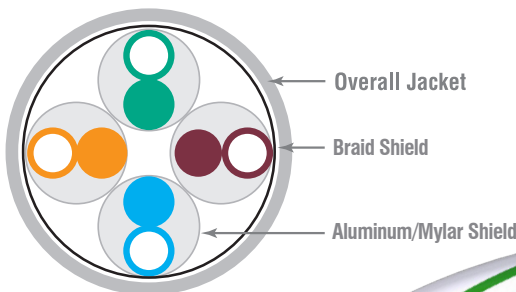
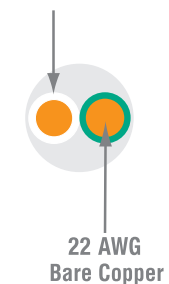

### DIELECTRIC MATERIALS

#### PLENUM

Primary Insulation: Plenum-rated fluoropolymer  
 Overall Jacket: Zero-Halogen Flame-retardant Thermoplastic

#### RISER

Primary Insulation: High-density Polyethylene  
 Overall Jacket: Zero-Halogen Flame-retardant Thermoplastic

Hitachi Cable America reserves the right to revise any specifications.

# Cat 7 S/FTP

## Transmission Specifications ANSI/TIA-568.2-D IEC 61156-5, 2nd ed. Category 7 Compliant

Freq. (MHz)	Ins. Loss	NEXT	PS NEXT	ACR	PSACR	ACRF	PSACRF	TCL	ELTCTL	Return Loss	CA (Type1)
	Max	Min	Min	Cal. Min	Cal. Min	Min	Min	Min	Min	Min	Min
1	2.0	78.0	75.0	76.0	73.0	78.0	75.0	40.0	35.0	-	-
4	3.7	78.0	75.0	74.3	71.3	78.0	75.0	34.0	23.0	-	-
8	5.2	78.0	75.0	72.8	69.8	77.2	74.2	31.0	16.9	-	-
10	5.9	78.0	75.0	72.1	69.1	75.3	72.3	30.0	15.0	-	-
16	7.4	78.0	75.0	70.6	67.6	71.2	68.2	28.0	10.9	-	-
20	8.3	78.0	75.0	69.7	66.7	69.3	66.3	27.0	9.0	25.0	-
25	9.3	78.0	75.0	68.7	65.7	67.3	64.3	26.0	7.0	24.3	-
31.25	10.4	78.0	75.0	67.6	64.6	65.4	62.4	25.1	-	23.6	85.0
62.5	14.9	75.5	72.5	60.6	57.6	59.4	56.4	22.0	-	21.5	85.0
100	19.0	72.4	69.4	53.4	50.4	55.3	52.3	20.0	-	20.1	85.0
200	27.5	67.9	64.9	40.4	37.4	49.3	46.3	17.0	-	18.0	79.0
250	31.0	66.4	63.4	35.5	32.5	47.3	44.3	16.0	-	17.3	77.0
300	34.2	65.2	62.2	31.1	28.1	45.8	42.8	-	-	17.3	75.5
400	40.0	63.4	60.4	23.4	20.4	43.3	40.3	-	-	17.3	73.0
500	45.3	61.9	58.9	16.7	13.7	41.3	38.3	-	-	17.3	71.0
600	50.1	60.7	57.7	10.6	7.6	39.7	36.7	-	-	17.3	69.4
600	50.1	60.7	57.7	10.6	7.6	39.7	36.7	-	-	17.3	39.4

All values are dB/100m.

Photo is for representation purposes only.



## Electrical Characteristics

Maximum Resistance Unbalance:	2% (Within Pairs), 4% (Between Pairs)
Maximum Capacitance Unbalance:	160 pF/100 meters
Maximum Delay Skew:	125 ns/100 meters
Nominal Velocity Of Propagation (Nvp):	82%
Voltage Rating:	300 Volts
LP Rating (UL) - CMP	0.9 Amps/conductor

Cable Ampacity Chart														
Bundle Size	1		2-7		8-19		20-37		38-61		62-91		92-192	
Cable Temp	75C	90C	75C	90C	75C	90C	75C	90C	75C	90C	75C	90C	75C	90C
22 AWG	3.0	3.0	1.8	2.1	1.2	1.4	0.9	1.1	0.8	0.9	0.7	0.8	0.6	0.7

The table above is derived from the one approved by the National Fire Protection Agency and used in the National Electrical Code, NFPA-70. The complete table can be found in sections 725.144 and 800 Communication Circuits of the code. The table identifies the ampacity of each conductor (in amperes) in a 4-pair Class 2 or Class 3 data cable. Ambient temperature used for development of the table is 30°C (86°F) with all conductors in all cables carrying current. The table is based on 60°C (140°F), 75°C (167°F) and 90°C (194°F) rated cables. All cable temps are operational temp ratings. Cables with temp ratings above 90c would deliver additional power handling capacity.

# Indoor

UTP

Copper

## Product Highlights

- REACH & RoHS 2 compliant
- Made in U.S.A.
- UL Verified
- Low Smoke Plenum construction
- Tested from 1 to 100 MHz
- Power sum compliance ensures minimum signal corruption due to alien crosstalk

## Packaging

- 1,000 foot (305 m) reels
- Reverse sequential footage markings standard on each 1,000 foot package
- Unit/pallet: 6 Reels  
CMP Carton Weight (lbs): 144.3  
CMP Product Weight (lbs): 141.0  
\*weight may vary, call for CMR information

## Options

- Consult factory for 50-pair design construction and availability.

## Applications

- Including:
  - Gigabit Ethernet (IEEE 802.3ab)
  - 100 Mbps Ethernet (IEEE 802.3u)
  - 1000 Mbps ATM
  - 622 Mbps ATM
  - 15W PoE (IEEE 802.3af)
  - 30W PoE+ (IEEE 802.3at)
  - 60W PoE++ (IEEE 802.3bt Type 3)
  - 100W PoE++ (IEEE 802.3bt Type 4)

## Temp. Range

- Storage Temperature  
-40°C to +60°C  
(-40°F to +140°F)
- Installation Temperature  
0°C to +60°C  
(+32°F to +140°F)
- Operation Temperature  
-20°C to +75°C  
(-4°F to +167°F)

## Category 5e Power Sum Multi-pair UTP (Plenum)

c(UL)us Listed Type CMP (NFPA 262), CSA Type FT6

PART #	# OF PAIRS	CALCULATED CABLE O.D.		CABLE WEIGHT	
		inches	mm	lbs/1000 ft	kg/305 m
30203-50	25	0.454	11.531	141.0	64.0

## Category 5e Power Sum Multi-pair UTP (Riser)

c(UL)us Listed Type CMR (UL 1666), CSA Type FT4

PART #	# OF PAIRS	CALCULATED CABLE O.D.		CABLE WEIGHT	
		inches	mm	lbs/1000 ft	kg/305 m
30093-50	25	0.49	12.4	133.25	60.44
30172-100	50	0.49 x 099	12.45 x 25.15	267.0	121.11

## Building a Part Number

Base Part Number Ex.	No. of Conductors	Jacket Color	Reel Type
30203	25	XX	Y

Jacket Colors (XX):

Black (BK); Blue (BL); Brown (BR); Gray (GA); Green (GR); Red (RD); White (WH); Violet (VI); Yellow (YE)

Reel Type (Y):

Reels (3)

## Features

Primary Insulation



24 AWG Bare Copper

PAIR DETAIL

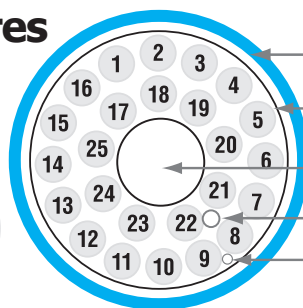

Overall Jacket

Nylon Binder Under Overall Jacket

Central Filler

Pair Filler

Rip Cord Pulled Under Overall Jacket

### DIELECTRIC MATERIALS

#### PLENUM

Primary Insulation: Plenum-rated fluoropolymer  
Overall Jacket: Low-smoke, flame-retardant thermoplastic  
Central Filler: Plenum-rated polymer  
Pair Filler: Plenum-rated polymer

#### RISER

Primary Insulation: Polyolefin  
Overall Jacket: Flame-retardant Thermoplastic  
Central Filler: Flame-retardant Thermoplastic  
Pair Filler: Plenum-rated polymer

Hitachi Cable America reserves the right to revise any specifications.

# Cat 5e Multi-Pair

## Transmission Specifications

ANSI/TIA-568.2-D Category 5e Verified  
ISO/IEC 11801, 2nd ed. Class D Compliant

Freq. (MHz)	Ins. Loss		NEXT		PSNEXT		ACR		PSACR		ACRF		PSACRF		Return Loss	
	Std.	Max.	Std.	Min.	Std.	Min.	Cal.	Min.	Cal.	Min.	Std.	Min.	Std.	Min.	Std.	Min.
1	2.0	2.0	65.3	65.3	62.3	62.3	63.3	63.3	60.3	60.3	63.8	63.8	60.8	60.8	20.0	20.0
4	4.1	4.1	56.3	56.3	53.3	53.3	52.2	52.2	49.2	49.2	51.8	51.8	48.8	48.8	23.0	23.0
8	5.8	5.8	51.8	51.8	48.8	48.8	46.0	46.0	43.0	43.0	45.7	45.7	42.7	42.7	24.5	24.5
10	6.5	6.5	50.3	50.3	47.3	47.3	43.8	43.8	40.8	40.8	43.8	43.8	40.8	40.8	25.0	25.0
16	8.2	8.2	47.2	47.2	44.2	44.2	39.0	39.0	36.0	36.0	39.7	39.7	36.7	36.7	25.0	25.0
31.25	11.7	11.7	42.9	42.9	39.9	39.9	31.2	31.2	28.2	28.2	33.9	33.9	30.9	30.9	23.6	23.6
62.5	17.0	17.0	38.4	38.4	35.4	35.4	21.4	21.4	18.4	18.4	27.9	27.9	24.9	24.9	21.5	21.5
100	22.0	22.0	35.3	35.3	32.3	32.3	13.3	13.3	10.3	10.3	23.8	23.8	20.8	20.8	20.1	20.1

\*Frequencies beyond the TIA and ISO requirements are for information only. All values are dB/100m.



Copper

Photo is for representation purposes only.

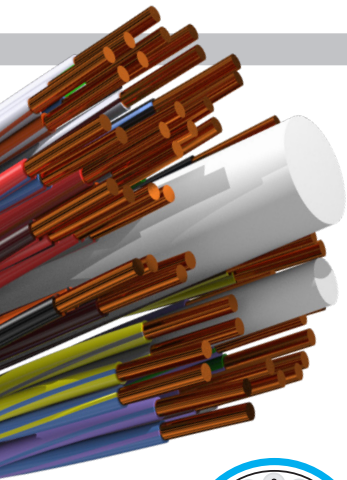

## Electrical Characteristics

Input Impedance:	100 ± 15Ω (1.0 to 100 MHz)
Maximum Resistance Unbalance:	5%
Maximum Capacitance Unbalance:	330 pF/100 meters
Maximum Delay Skew:	45 ns/100 meters
Nominal Velocity Of Propagation (Nvp):	70%, Plenum 68%, Riser
Voltage Rating:	300 Volts

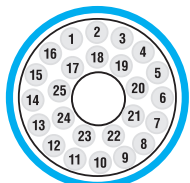

25-pair

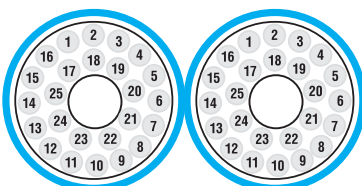

50-pair

Diagram scale approx. 3:1

# Indoor

UTP

Copper

## Product Highlights

- REACH & RoHS 2 compliant
- Made in U.S.A.
- Low Smoke Plenum construction
- Tested from 1 to 16 MHz

## Packaging

- 1,000 foot (305m) reels
- Reverse sequential footage markings standard on each 1,000 foot package

## Options

- Available in 25-, 50-, 100-, 200- and 300-pair constructions
- Consult factory for design and availability of 400-pair constructions

## Applications

- Including:  
10 BASE-T  
4/16 Mbps Token Ring  
25.6 Mbps ATM

## Temp. Range

- Storage Temperature  
-40°C to +60°C  
(-40°F to +140°F)
- Installation Temperature  
0°C to +60°C  
(+32°F to +140°F)
- Operation Temperature  
-20°C to +75°C  
(-4°F to +167°F)

## Category 3 Power Sum Multi-pair UTP (Plenum)

c(UL)us Listed Type CMP (NFPA 262), CSA Type FT6

PART #	# OF PAIRS	CALCULATED CABLE O.D.		CABLE WEIGHT	
		inches	mm	lbs/1000 ft	kg/305 m
30134-50	25	0.38	9.7	111.43	50.54
30134-100	50	0.446 x 0.646	11.316 x 16.396	219.95	99.77
30134-200	100	0.810	20.57	436.63	198.05
30134-400	200	1.151	29.235	874.94	396.87
30134-600	300	1.33	33.7	1275.83	578.71

Note: Standard/stock color for plenum cable is white.

## Category 3 Power Sum Multi-pair UTP (Riser)

c(UL)us Listed Type CMR (UL 1666), CSA Type FT4

PART #	# OF PAIRS	CALCULATED CABLE O.D.		CABLE WEIGHT	
		inches	mm	lbs/1000 ft	kg/305 m
39228-50	25	0.371	9.423	104.95	47.60
39228-100	50	0.420 x 0.641	10.669 x 16.280	202.43	91.82
39228-200	100	0.743	18.872	402.01	182.34
39228-400	200	1.040	26.416	794.70	360.46
39228-600	300	1.310	33.274	1176.73	533.76

Note: Standard/stock color for riser cable is gray.

## Features

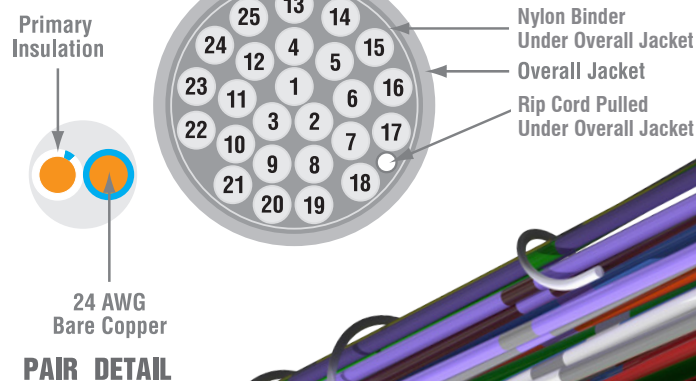

### DIELECTRIC MATERIALS

#### PLENUM

Primary Insulation: Plenum-rated fluoropolymer  
Overall Jacket (<100-pair): Low-smoke, Flame-retardant Thermoplastic

#### RISER

Primary Insulation: Polyolefin  
Overall Jacket (<100-pair): Flame-retardant Thermoplastic

\*Hitachi Cable America reserves the right to revise any specifications.



# Cat 3 Multi-Pair

## Transmission Specifications ANSI/TIA-568.2-D Category 3 Verified

Frequency (MHz)	Insertion Loss	NEXT Loss	ACR	Structural Return Loss
1	2.6	41.3	38.7	12.0
4	5.6	32.3	26.7	12.0
8	8.5	27.8	19.3	12.0
10	9.7	26.3	16.6	12.0
16	13.1	23.2	10.1	10.0

All values are dB/100m.



Copper

Photo is for representation purposes only.

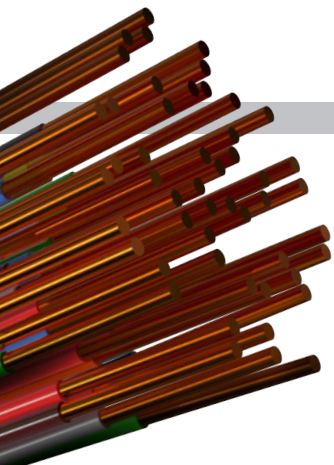

## Electrical Characteristics

Input Impedance:	100 ± 15Ω (1.0 to 16 MHz)
Maximum Resistance Unbalance:	5%
Maximum Capacitance Unbalance:	330 pF/100 meters
Maximum Delay Skew:	45 ns/100 meters
Voltage Rating:	300 Volts



25-pair

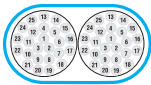

50-pair

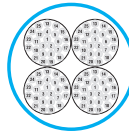

100-pair

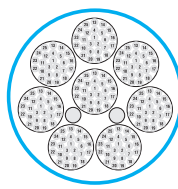

200-pair

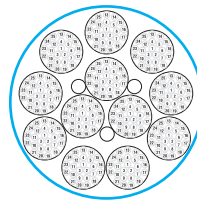

300-pair

# Indoor / Outdoor

UTP & FUTP

Copper

## Product Highlights

- REACH & RoHS 2 compliant
- Made in U.S.A.
- Guaranteed minimum performance
- Tested from 1 to 660 MHz
- UL Verified TIA-568-D.2 Category 6A
- UL Verified (UL B627696) for long term water submersion
- UL Listed for use in plenum areas.
- UV resistant jacket
- Specifically designed for below-grade conduit or other environments where water is likely to infiltrate
- Ideal for industrial & harsh environments
- Resistant to over 2,000 chemicals
- No-gel construction simplifies termination
- DryBit® Barrier ensures optimum electrical performance even in harsh environments
- Available in both UTP and FUTP
- Standard jacket color is black
- Custom colors available

## Packaging

- 1,000 foot (305 m) reels
- Unit/pallet: 12  
CMP Carton Weight (lbs): 23.66  
CMP Product Weight (lbs): 20.36  
\*weight may vary

## Applications

- Including:  
HDBase-T A & B  
10 Gigabit Ethernet (IEEE 802.3an)  
5 Gigabit Ethernet (IEEE 802.3bz)  
2.5 Gigabit Ethernet (IEEE 802.3bz)  
Gigabit Ethernet (IEEE 802.3ab)  
100 Mbps Ethernet (IEEE 802.3u)  
1000 Mbps ATM  
622 Mbps ATM  
15W PoE (IEEE 802.3af)  
30W PoE+ (IEEE 802.3at)  
60W PoE++ (IEEE 802.3bt Type 3)  
100W PoE++ (IEEE 802.3bt Type 4)

## Temp. Range

- Storage Temperature  
-40°C to +70°C  
(-40°F to +158°F)
- Installation Temperature  
0°C to +60°C  
(+32°F to +140°F)
- Operation Temperature  
-40°C to +90°C  
(-40°F to +194°F)

## DryBit® Indoor-Outdoor CMP UTP (Plenum)

c(UL)us Listed Type CMP (NFPA 262), CSA Type FT6

PART #	# OF PAIRS	CALCULATED CABLE O.D.		CABLE WEIGHT	
		inches	mm	lbs/1000 ft	kg/305 m
30323-8-BK3	4	0.31	7.87	54.7	24.8

## DryBit® Indoor-Outdoor CMP FUTP (Plenum)

c(UL)us Listed Type CMP (NFPA 262), CSA Type FT6

PART #	# OF PAIRS	CALCULATED CABLE O.D.		CABLE WEIGHT	
		inches	mm	lbs/1000 ft	kg/305 m
30322-8-BK3	4	0.31	7.87	56.0	25.4

## Building a Part Number

Base Part Number Ex.	No. of Conductors	Jacket Color	Reel Type
30323	8	XX	Y

Jacket Colors (XX):  
Black (BK)

Reel Type (Y):  
Reels (3)

## Features

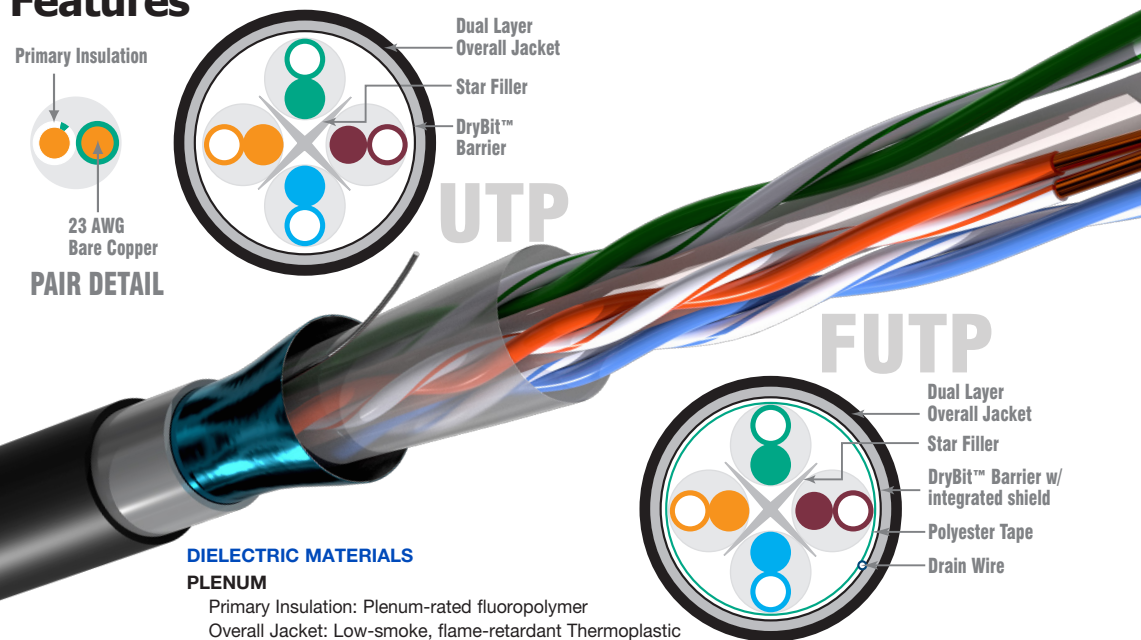

Hitachi Cable America reserves the right to revise any specifications.

# Cat 6A DryBit®

## Transmission Specifications ANSI/TIA-568.2-D Category 6A Verified ISO/IEC 11801, 2nd ed. Class EA Compliant

	Ins. Loss	NEXT	PSNEXT	ACR	PSACR	ACRF	PSACRF	Return Loss	PSANEXT	PSANEXT	PSAACRF	PSAACRF
Freq. (MHz)	Max.	Min.	Min.	Min.	Min.	Min.	Min.	Min.	TIA Std.	Min	TIA Std.	Min
1	2.1	74.3	72.3	72.2	70.2	67.8	64.8	20.0	67.0	73.0	67.0	73.0
4	3.8	65.3	63.3	61.5	59.5	55.8	52.8	23.0	67.0	73.0	66.2	72.2
8	5.3	60.8	58.8	55.4	53.4	49.7	46.7	24.5	67.0	73.0	60.1	66.1
10	5.9	59.3	57.3	53.4	51.4	47.8	44.8	25.0	67.0	73.0	58.2	64.2
16	7.5	56.2	54.2	48.8	46.8	43.7	40.7	25.0	67.0	73.0	54.1	60.1
20	8.4	54.8	52.8	46.4	44.4	41.8	38.8	25.0	67.0	73.0	52.2	58.2
25	9.4	53.3	51.3	44.0	42.0	39.8	36.8	2.3	67.0	73.0	50.2	56.2
31.25	10.5	51.9	49.9	41.4	39.4	37.9	34.9	23.6	67.0	73.0	48.3	54.3
62.5	15.0	47.4	45.4	32.4	30.4	31.9	28.9	21.5	65.6	71.6	42.3	48.3
100	19.1	44.3	42.3	25.2	23.2	27.8	24.8	20.1	62.5	68.5	38.2	44.2
155	24.1	41.4	39.4	17.4	15.4	24.0	21.0	18.8	59.6	65.6	34.4	40.4
200	27.6	39.8	37.8	12.2	10.2	21.8	18.8	18.0	58.0	64.0	32.2	38.2
250	31.1	38.3	36.3	7.3	5.3	19.8	16.8	17.3	56.5	62.5	30.2	36.2
300	34.3	37.1	35.1	2.9	0.9	18.3	15.3	16.8	55.3	61.3	28.7	34.7
350	37.2	36.1	34.1	-	-	16.9	13.9	16.3	54.3	60.3	27.3	33.3
400	40.1	35.3	33.3	-	-	15.8	12.8	15.9	53.5	59.3	26.2	32.2
500	45.3	33.8	31.8	-	-	13.8	10.8	15.2	52.0	58.0	24.2	30.2
555*	47.9	33.1	31.1	-	-	12.9	9.9	14.9	51.3	57.3	23.3	29.3
660*	52.8	32.0	30.0	-	-	11.4	8.4	14.4	50.2	56.2	21.8	27.8

\*Frequencies beyond the TIA and ISO requirements are for information only. All values are dB/100m.  
Hitachi Cable America reserves the right to revise any specifications.

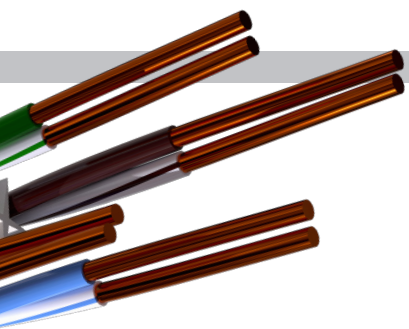
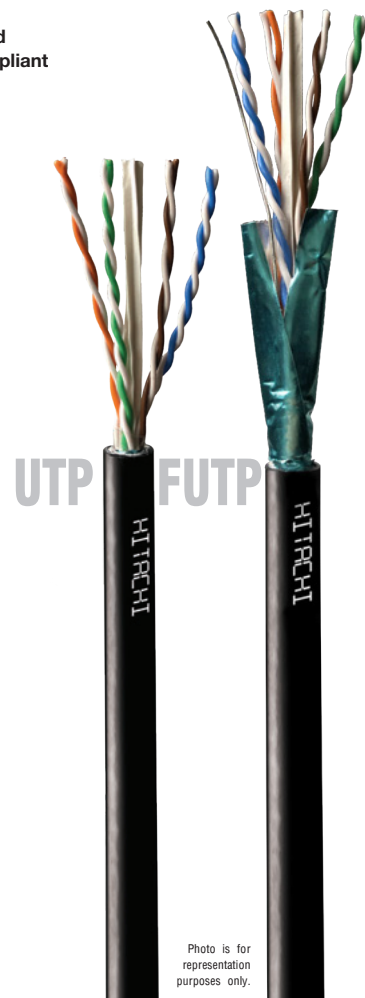

## Electrical Characteristics

Input Impedance:	100 ± 15Ω (1.0 to 250 MHz)
Maximum conductor resistance:	9.38 Ω/100 meters @ 20°C
Maximum Resistance Unbalance:	5%
Maximum Capacitance Unbalance:	330 pF/100 meters
Maximum Delay Skew:	45 ns/100 meters
Nominal Velocity Of Propagation (Nvp):	70%, Plenum
Voltage Rating:	300 Volts

Cable Ampacity Chart							
Bundle Size	1	2-7	8-19	20-37	38-61	62-91	92-192
Cable Temp	90°C	90°C	90°C	90°C	90°C	90°C	90°C
23 AWG	2.5	1.7	1.2	0.9	0.8	0.8	0.6

The table above is derived from the one approved by the National Fire Protection Agency and used in the National Electrical Code, NFPA-70. The complete table can be found in sections 725.144 and 800 Communication Circuits of the code. The table identifies the ampacity of each conductor (in amperes) in a 4-pair Class 2 or Class 3 data cable. Ambient temperature used for development of the table is 30°C (86° F) with all conductors in all cables carrying current. The table is based on 60°C (140°F), 75°C (167°F) and 90°C (194°F) rated cables. All cable temps are operational temp ratings. Cables with temp ratings above 90c would deliver additional power handling capacity.

**Installation Notes:** To ensure safe operation, install cables according to all applicable local and national electrical codes.

"During installation, take precautions to ensure any water present in pathway does not enter the open end of the cable. Water infiltration via the open ends of the cable will negatively impact cable performance and void any applicable product warranty."

# Indoor / Outdoor

UTP & FUTP

Copper

## Product Highlights

- REACH & RoHS 2 compliant
- Made in U.S.A.
- Guaranteed minimum performance
- Tested from 1 to 660 MHz
- UL Verified TIA-568-D.2 Category 6
- UL Verified (UL B627696) for long term water submersion
- UL Listed for use in plenum areas.
- UV resistant jacket
- Specifically designed for below-grade conduit or other environments where water is likely to infiltrate
- Ideal for industrial & harsh environments
- Resistant to over 2,000 chemicals
- No-gel construction simplifies termination
- DryBit® Barrier ensures optimum electrical performance even in harsh environments
- Available in both UTP and FUTP
- Standard jacket color is black. Custom colors available

## Packaging

- 1,000 foot (305 m) reels
  - Unit/pallet: 12  
UTP Carton Weight (LBS): 23.66  
UTP Product Weight (LBS): 20.36
- \*weight may vary, call for FUTP information

## Applications

- Including:
  - HDBase-T A & B
  - 5 Gigabit Ethernet (IEEE 802.3bz)
  - 2.5 Gigabit Ethernet (IEEE 802.3bz)
  - Gigabit Ethernet (IEEE 802.3ab)
  - 100 Mbps Ethernet (IEEE 802.3u)
  - 1000 Mbps ATM
  - 622 Mbps ATM
  - 15W PoE (IEEE 802.3af)
  - 30W PoE+ (IEEE 802.3at)
  - 60W PoE++ (IEEE 802.3bt Type 3)
  - 100W PoE++ (IEEE 802.3bt Type 4)

## Temp. Range

- Storage Temperature  
-40°C to +60°C  
(-40°F to +140°F)
- Installation Temperature  
0°C to +60°C  
(+32°F to +140°F)
- Operation Temperature  
-40°C to +90°C  
(-40°F to +194°F)

## DryBit® Indoor-Outdoor CMP UTP (Plenum)

c(UL)us Listed Type CMP (NFPA 262), CSA Type FT6

PART #	# OF PAIRS	CALCULATED CABLE O.D.		CABLE WEIGHT	
		inches	mm	lbs/1000 ft	kg/305 m
30315-8-BK3	4	0.31	7.87	54.7	24.8

## DryBit® Indoor-Outdoor CMP FUTP (Plenum)

c(UL)us Listed Type CMP (NFPA 262), CSA Type FT6

PART #	# OF PAIRS	CALCULATED CABLE O.D.		CABLE WEIGHT	
		inches	mm	lbs/1000 ft	kg/305 m
30277-8-BK3	4	0.31	7.87	56.0	25.4

## Building a Part Number

Base Part Number Ex.	No. of Conductors	Jacket Color	Reel Type
30315	8	XX	Y

Jacket Colors (XX):  
Black (BK)

Reel Type (Y):  
Reels (3)

## Features

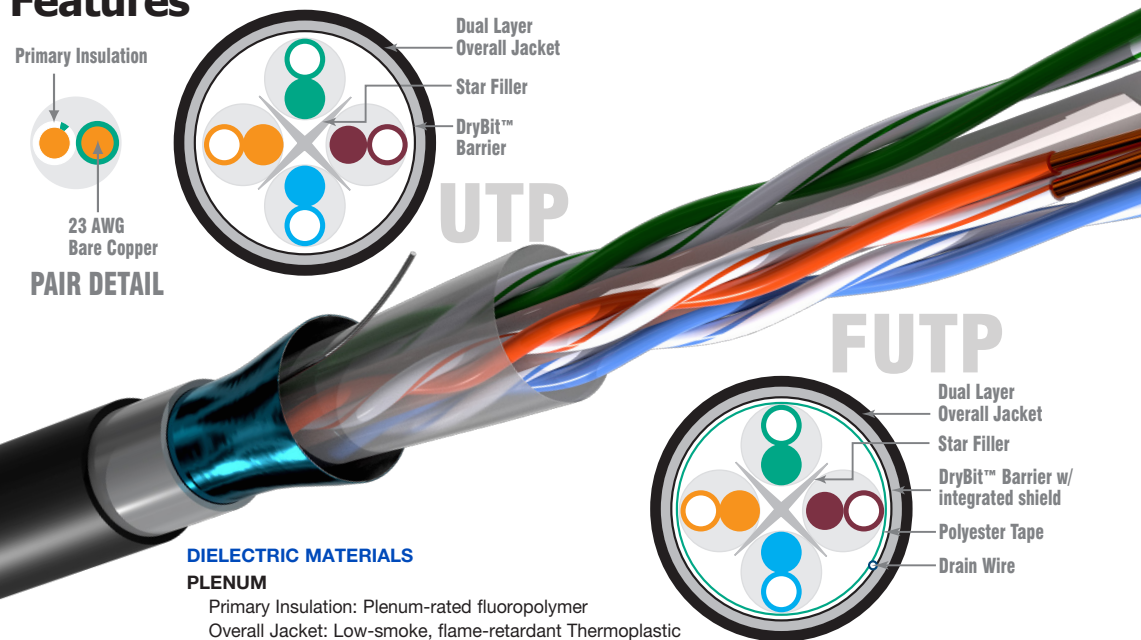

Hitachi Cable America reserves the right to revise any specifications.

# Cat 6 DryBit®

## Transmission Specifications

ANSI/TIA-568.2-D Category 6 Verified  
ISO/IEC 11801, 2nd ed. Class EA Compliant

Freq. (MHz)	Ins. Loss		NEXT		PSNEXT		ACR		PSACR		ACRF		PSACRF		Return Loss	
	Std.	Max.	Std.	Min.	Std.	Min.	Cal.	Min.	Cal.	Min.	Std.	Min.	Std.	Min.	Std.	Min.
1	2.0	2.0	74.3	74.3	72.3	72.3	72.3	72.3	70.3	70.3	67.8	67.8	64.8	64.8	20.0	20.0
4	3.8	3.8	65.3	65.3	63.3	63.3	61.5	61.5	59.5	59.5	55.8	55.8	52.8	52.8	23.0	23.0
8	5.3	5.3	60.8	60.8	58.8	58.8	55.4	55.4	53.4	53.4	49.7	49.7	46.7	46.7	24.5	24.5
10	6.0	6.0	59.3	59.3	57.3	57.3	53.3	53.3	51.3	51.3	47.8	47.8	44.8	44.8	25.0	25.0
16	7.6	7.6	56.2	56.2	54.2	54.2	48.7	48.7	46.7	46.7	43.7	43.7	40.7	40.7	25.0	25.0
31.25	10.7	10.7	51.9	51.9	49.9	49.9	41.2	41.2	39.2	39.2	37.9	37.9	34.9	34.9	23.6	23.6
62.5	15.4	15.4	47.4	47.4	45.4	45.4	32.0	32.0	30.0	30.0	31.9	31.9	28.9	28.9	21.5	21.5
100	19.8	19.8	44.3	44.3	42.3	42.3	24.5	24.5	22.5	22.5	27.8	27.8	24.8	24.8	20.1	20.1
200	29.0	29.0	39.8	39.8	37.8	37.8	10.8	10.8	8.8	8.8	21.8	21.8	18.8	18.8	18.0	18.0
250	32.8	32.8	38.3	38.3	36.3	36.3	5.5	5.5	3.5	3.5	19.8	19.8	16.8	16.8	17.3	17.3
300*	-	36.4	-	37.1	-	35.1	-	-	-	-	-	18.3	-	15.3	-	16.8
350*	-	39.8	-	36.1	-	34.1	-	-	-	-	-	16.9	-	13.9	-	16.3
400*	-	43.0	-	35.3	-	33.3	-	-	-	-	-	15.8	-	12.8	-	15.9
500*	-	48.9	-	33.8	-	31.8	-	-	-	-	-	13.8	-	10.8	-	15.2
555*	-	52.0	-	33.1	-	31.1	-	-	-	-	-	12.9	-	9.9	-	14.9

\*Frequencies beyond the TIA and ISO requirements are for information only. All values are dB/100m.

Hitachi Cable America reserves the right to revise any specifications.

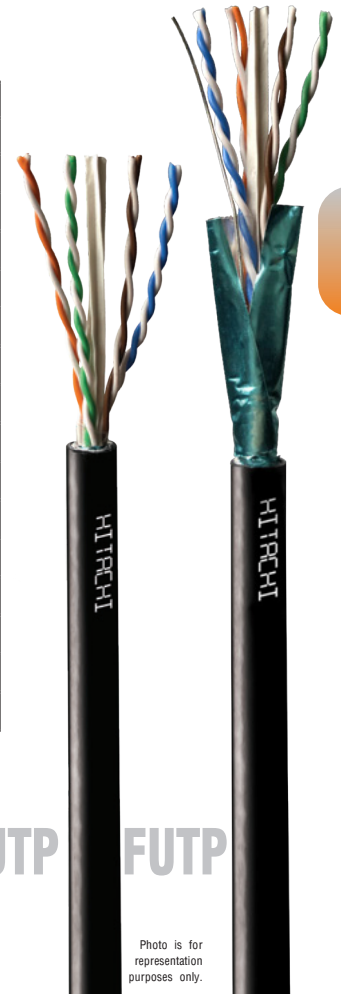

Copper

UTP FUTP

Photo is for representation purposes only.



## Electrical Characteristics

Input Impedance:	100 ± 15Ω (1.0 to 250 MHz)
Maximum Conductor Resistance	9.38 Ω/100 meters @ 20°C
Maximum Resistance Unbalance:	5%
Maximum Capacitance Unbalance:	330 pF/100 meters
Maximum Delay Skew:	45 ns/100 meters
Nominal Velocity Of Propagation (Nvp):	70%, Plenum
Voltage Rating:	300 Volts

Cable Ampacity Chart							
Bundle Size	1	2-7	8-19	20-37	38-61	62-91	92-192
Cable Temp	90°C	90°C	90°C	90°C	90°C	90°C	90°C
23 AWG	2.5	1.7	1.2	0.9	0.8	0.8	0.6

The table above is derived from the one approved by the National Fire Protection Agency and used in the National Electrical Code, NFPA-70. The complete table can be found in sections 725.144 and 800 Communication Circuits of the code. The table identifies the ampacity of each conductor (in amperes) in a 4-pair Class 2 or Class 3 data cable. Ambient temperature used for development of the table is 30°C (86° F) with all conductors in all cables carrying current. The table is based on 60°C (140°F), 75°C (167°F) and 90°C (194°F) rated cables. All cable temps are operational temp ratings. Cables with temp ratings above 90c would deliver additional power handling capacity.

**Installation Notes:** To ensure safe operation, install cables according to all applicable local and national electrical codes.

"During installation, take precautions to ensure any water present in pathway does not enter the open end of the cable. Water infiltration via the open ends of the cable will negatively impact cable performance and void any applicable product warranty."

# Outdoor

F/UTP

Copper

## Product Highlights

- REACH & RoHS 2 compliant
- Made in U.S.A.
- Suitable for direct burial, lashed aerial, duct and underground conduit applications
- Cable core is filled with non-conductive, water-blocking gel
- Rugged black polyolefin jacket
- UV resistant jacket
- Proven shield technology improves RFI and EMI performance

## Packaging

- 1,000 foot (305 m) reels
- Reverse sequential footage markings standard on each 1,000 foot package
- Unit/pallet: 16  
CMP Carton Weight (lbs): 47.0  
CMP Product Weight (lbs): 43.7  
\*weight may vary

## Applications

- Including:
  - 10 Gigabit Ethernet (IEEE 802.3an)
  - 5 Gigabit Ethernet (IEEE 802.3bz)
  - 2.5 Gigabit Ethernet (IEEE 802.3bz)
  - Gigabit Ethernet (IEEE 802.3ab)
  - 100 Mbps Ethernet (IEEE 802.3u)
  - 1000 Mbps ATM
  - 622 Mbps ATM
  - 15W PoE (IEEE 802.3af)
  - 30W PoE+ (IEEE 802.3at)
  - 60W PoE++ (IEEE 802.3bt Type 3)
  - 100W PoE++ (IEEE 802.3bt Type 4)

## Temp. Range

- Storage Temperature  
-40°C to +70°C  
(-40°F to +158°F)
- Installation Temperature  
-20°C to +70°C  
(-4°F to +158°F)
- Operation Temperature  
-40°C to +70°C  
(-40°F to +158°F)

## Category 6A F/UTP Single Jacket

c(UL)us Listed Type CMP (NFPA 262), CSA Type FT6

PART #	# OF PAIRS	CALCULATED CABLE O.D.		CABLE WEIGHT	
		inches	mm	lbs/1000 ft	kg/305 m
30348-8-XXY	4	0.320	8.128	40.6	18.4

## Building a Part Number

Base Part Number Ex.	No. of Conductors	Jacket Color	Reel Type
30348	8	XX	Y

Jacket Colors (XX):  
Black (BK)

Reel Type (Y):  
Reels (3)

## Features

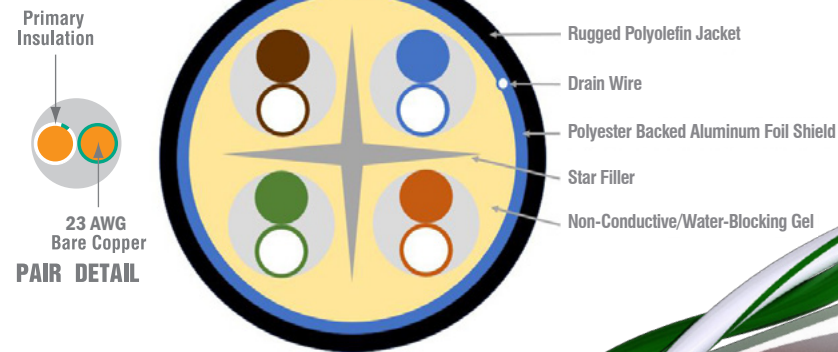

### DIELECTRIC MATERIALS

#### OUTDOOR F/UTP CABLES

Primary Insulation: Polyolefin  
Overall Jacket: Medium density polyolefin

Hitachi Cable America reserves the right to revise any specifications.

# Cat 6A OSP

## Transmission Specifications ANSI/TIA-568.2-D Category 6A Verified ISO/IEC 11801, 2nd ed. Class EA Compliant

Frequency (MHz)	Insertion Loss Max. (dB / 100 m)	NEXT Loss Min. (dB / 100 m)		ACR Min. (dB / 100 m)		ACRF Min. (dB / 100 m)		Return Loss Min. (dB/100m)	Delay Max. (ns/100m)
		WP	PS	WP	PS	WP	PS		
1	2.1	74.3	72.3	72.2	70.2	67.8	64.8	20.0	599
4	3.8	65.3	63.3	61.5	59.5	55.8	52.8	23.0	580
8	5.3	60.8	58.8	55.4	53.4	49.7	46.7	24.5	574
10	5.9	59.3	57.3	53.4	51.4	47.8	44.8	25.0	573
16	7.5	56.2	54.2	48.8	46.8	43.7	40.7	25.0	570
20	8.4	54.8	52.8	46.4	44.4	41.8	38.8	25.0	569
25	9.4	53.3	51.3	44.0	42.0	39.8	36.8	24.3	568
31.25	10.5	51.9	49.9	41.4	39.4	37.9	34.9	23.6	567
62.5	15.0	47.4	45.4	32.4	30.4	31.9	28.9	21.5	565
100	19.1	44.3	42.3	25.2	23.2	27.8	24.8	20.1	564
155	24.1	41.4	39.4	17.4	15.4	24.0	21.0	18.8	564
200	27.6	39.8	37.8	12.2	10.2	21.8	18.8	18.0	563
250	31.1	38.3	36.3	7.3	5.3	19.8	16.8	17.3	563
300	34.3	37.1	35.1	2.9	0.9	18.3	15.3	16.8	563
350	37.2	36.1	34.1	-	-	16.9	13.9	16.3	563
400	40.1	35.3	33.3	-	-	15.8	12.8	15.9	563
500	45.3	33.8	31.8	-	-	13.8	10.8	15.2	562
555*	47.9	33.1	31.1	-	-	12.9	9.9	14.9	562
660*	52.8	32.0	30.0	-	-	11.4	8.4	14.4	562

\*Frequencies beyond the TIA and ISO requirements are for information only. All values are dB/100m.

Photo is for representation purposes only.



## Electrical Characteristics

Input Impedance:	100 ± 15Ω (1.0 to 100 MHz) 100 ± 20Ω (100 to 250 MHz) 100 ± 25Ω (251 to 500 MHz)
Maximum Conductor Resistance:	9.38 Ω /100 Meters @ 20°C
Maximum Resistance Unbalance:	3%
Maximum Mutual Capacitance:	5.6 nF/100 Meters @ 1 kHz
Maximum Capacitance Unbalance:	330 pF/100 meters
Maximum Delay Skew:	45 ns/100 meters
Nominal Velocity Of Propagation (Nvp):	67%

Cable Ampacity Chart							
Bundle Size	1	2-7	8-19	20-37	38-61	62-91	92-192
Cable Temp	60°C	60°C	60°C	60°C	60°C	60°C	60°C
23 AWG	2.5	1.2	0.8	0.6	0.5	0.5	0.4

The table above is derived from the one approved by the National Fire Protection Agency and used in the National Electrical Code, NFPA-70. The complete table can be found in sections 725.144 and 800 Communication Circuits of the code. The table identifies the ampacity of each conductor (in amperes) in a 4-pair Class 2 or Class 3 data cable. Ambient temperature used for development of the table is 30°C (86° F) with all conductors in all cables carrying current. The table is based on 60°C (140°F), 75°C (167°F) and 90°C (194°F) rated cables. All cable temps are operational temp ratings. Cables with temp ratings above 90c would deliver additional power handling capacity.

# Outdoor

F/UTP

Copper

## Product Highlights

- REACH & RoHS 2 compliant
- Made in U.S.A.
- Suitable for direct burial, lashed aerial, duct and underground conduit applications
- Cable core is filled with non-conductive, water-blocking gel
- Rugged black polyolefin jacket
- UV resistant jacket.
- Proven shield technology improves RFI and EMI performance

## Packaging

- 1,000 foot (305 m) reels
- Reverse sequential footage markings standard on each 1,000 foot package
- Unit/pallet: 12  
CMP Carton Weight (lbs): 60.17  
CMP Product Weight (lbs): 56.87  
\*weight may vary

## Applications

- Including:
  - 10 Gigabit Ethernet (IEEE 802.3an)
  - 5 Gigabit Ethernet (IEEE 802.3bz)
  - 2.5 Gigabit Ethernet (IEEE 802.3bz)
  - Gigabit Ethernet (IEEE 802.3ab)
  - 100 Mbps Ethernet (IEEE 802.3u)
  - 1000 Mbps ATM
  - 622 Mbps ATM
  - 15W PoE (IEEE 802.3af)
  - 30W PoE+ (IEEE 802.3at)
  - 60W PoE++ (IEEE 802.3bt Type 3)
  - 100W PoE++ (IEEE 802.3bt Type 4)

## Temp. Range

- Storage Temperature  
-40°C to +70°C  
(-40°F to +158°F)
- Installation Temperature  
-20°C to +70°C  
(-4°F to +158°F)
- Operation Temperature  
-40°C to +70°C  
(-40°F to +158°F)

## Category 6A F/UTP Dual Jacket

c(UL)us Listed Type CMP (NFPA 262), CSA Type FT6

PART #	# OF PAIRS	CALCULATED CABLE O.D.		CABLE WEIGHT	
		inches	mm	lbs/1000 ft	kg/305 m
30287-8-XXY	4	0.360	9.144	56.87	25.8

## Building a Part Number

Base Part Number Ex.	No. of Conductors	Jacket Color	Reel Type
30287	8	XX	Y

Jacket Colors (XX):  
Black (BK)

Reel Type (Y):  
Reels (3)

## Features

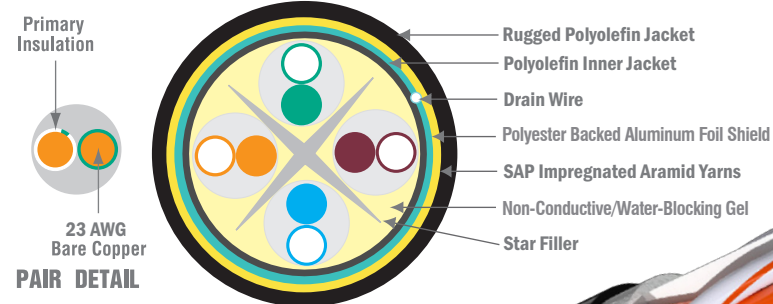

### DIELECTRIC MATERIALS OUTDOOR F/UTP CABLES

Primary Insulation: Polyolefin and/or Fluoropolymer  
Overall Jacket: Medium density polyolefin

Hitachi Cable America reserves the right to revise any specifications.



# Cat 6A OSP

## Transmission Specifications ANSI/TIA-568.2-D Category 6A Verified ISO/IEC 11801, 2nd ed. Class EA Compliant

Frequency (MHz)	Insertion Loss Max. (dB / 100 m)	NEXT Loss Min. (dB / 100 m)		ACR Min. (dB / 100 m)		ACRF Min. (dB / 100 m)		Return Loss Min. (dB/100m)	Delay Max. (ns/100m)
		WP	PS	WP	PS	WP	PS		
1	2.1	74.3	72.3	72.2	70.2	67.8	64.8	20.0	599
4	3.8	65.3	63.3	61.5	59.5	55.8	52.8	23.0	580
8	5.3	60.8	58.8	55.4	53.4	49.7	46.7	24.5	574
10	5.9	59.3	57.3	53.4	51.4	47.8	44.8	25.0	573
16	7.5	56.2	54.2	48.8	46.8	43.7	40.7	25.0	570
20	8.4	54.8	52.8	46.4	44.4	41.8	38.8	25.0	569
25	9.4	53.3	51.3	44.0	42.0	39.8	36.8	24.3	568
31.25	10.5	51.9	49.9	41.4	39.4	37.9	34.9	23.6	567
62.5	15.0	47.4	45.4	32.4	30.4	31.9	28.9	21.5	565
100	19.1	44.3	42.3	25.2	23.2	27.8	24.8	20.1	564
155	24.1	41.4	39.4	17.4	15.4	24.0	21.0	18.8	564
200	27.6	39.8	37.8	12.2	10.2	21.8	18.8	18.0	563
250	31.1	38.3	36.3	7.3	5.3	19.8	16.8	17.3	563
300	34.3	37.1	35.1	2.9	0.9	18.3	15.3	16.8	563
350	37.2	36.1	34.1	-	-	16.9	13.9	16.3	563
400	40.1	35.3	33.3	-	-	15.8	12.8	15.9	563
500	45.3	33.8	31.8	-	-	13.8	10.8	15.2	562
555*	47.9	33.1	31.1	-	-	12.9	9.9	14.9	562
660*	52.8	32.0	30.0	-	-	11.4	8.4	14.4	562

\*Frequencies beyond the TIA and ISO requirements are for information only. All values are dB/100m.

Photo is for representation purposes only.



## Electrical Characteristics

Input Impedance:	100 ± 15Ω (1.0 to 100 MHz) 100 ± 20Ω (100 to 250 MHz) 100 ± 25Ω (251 to 500 MHz)
Maximum Conductor Resistance:	9.38 Ω /100 Meters @ 20°C
Maximum Resistance Unbalance:	3%
Maximum Mutual Capacitance:	5.6 nF/100 Meters @ 1 kHz
Maximum Capacitance Unbalance:	330 pF/100 meters
Maximum Delay Skew:	45 ns/100 meters
Nominal Velocity Of Propagation (Nvp):	67%

Cable Ampacity Chart							
Bundle Size	1	2-7	8-19	20-37	38-61	62-91	92-192
Cable Temp	60°C	60°C	60°C	60°C	60°C	60°C	60°C
23 AWG	2.5	1.2	0.8	0.6	0.5	0.5	0.4

The table above is derived from the one approved by the National Fire Protection Agency and used in the National Electrical Code, NFPA-70. The complete table can be found in sections 725.144 and 800 Communication Circuits of the code. The table identifies the ampacity of each conductor (in amperes) in a 4-pair Class 2 or Class 3 data cable. Ambient temperature used for development of the table is 30°C (86°F) with all conductors in all cables carrying current. The table is based on 60°C (140°F), 75°C (167°F) and 90°C (194°F) rated cables. All cable temps are operational temp ratings. Cables with temp ratings above 90c would deliver additional power handling capacity.

# Outdoor

UTP

Copper

## Product Highlights

- REACH & RoHS 2 compliant
- Made in U.S.A.
- Suitable for direct burial, lashed aerial, duct and underground conduit applications
- Cable core is filled with non-conductive, water-blocking gel
- Rugged black polyolefin jacket
- UV resistant jacket

## Packaging

- 1,000 foot (305 m) reels
- Reverse sequential footage markings standard on each 1,000 foot package
- Unit/pallet: 12 Reels  
CMP Carton Weight (lbs): 43.63  
CMP Product Weight (lbs): 40.33  
\*weight may vary

## Applications

- Including:
  - HDBase-T A & B (Cat 6)
  - 5 Gigabit Ethernet (IEEE 802.3bz)(Cat 6)
  - 2.5 Gigabit Ethernet (IEEE 802.3bz)
  - Gigabit Ethernet (IEEE 802.3ab)
  - 100 Mbps Ethernet (IEEE 802.3u)
  - 1000 Mbps ATM
  - 622 Mbps ATM
  - 15W PoE (IEEE 802.3af)
  - 30W PoE+ (IEEE 802.3at)
  - 60W PoE++ (IEEE 802.3bt Type 3)
  - 100W PoE++ (IEEE 802.3bt Type 4)

## Temp. Range

- Storage Temperature  
-40°C to +70°C  
(-40°F to +158°F)
- Installation Temperature  
-20°C to +70°C  
(-4°F to +158°F)
- Operation Temperature  
-40°C to +70°C  
(-40°F to +158°F)

## Category 6 UTP Single Jacket

c(UL)us Listed Type CMP (NFPA 262), CSA Type FT6

PART #	# OF PAIRS	CALCULATED CABLE O.D.		CABLE WEIGHT	
		inches	mm	lbs/1000 ft	kg/305 m
30180-8-XXY	4	0.270	6.858	34.65	15.72

## Building a Part Number

Base Part Number Ex.	No. of Conductors	Jacket Color	Reel Type
30180	8	XX	Y

Jacket Colors (XX):  
Black (BK)

Reel Type (Y):  
Reels (3)

## Features

Primary Insulation



24 AWG  
Bare Copper  
**PAIR DETAIL**

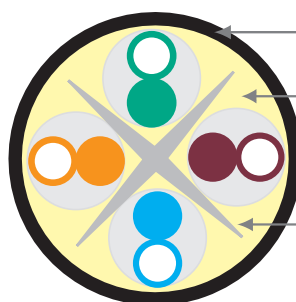

Rugged Polyolefin Overall Jacket

Non-Conductive Water-Blocking Gel

Star Filler



### DIELECTRIC MATERIALS

#### OUTDOOR F/UTP CABLES

Primary Insulation: Polyolefin

Overall Jacket: Medium density polyolefin

Hitachi Cable America reserves the right to revise any specifications.

# Cat 6 OSP

## Transmission Specifications ANSI/TIA-568.2-D Category 6 Verified ISO/IEC 11801, 2nd ed. Class E Compliant

Freq. (MHz)	Ins. Loss		NEXT		PSNEXT		ACR		PSACR		ACRF		PSACRF		Return Loss	
	Std.	Max.	Std.	Min.	Std.	Min.	Cal.	Min.	Cal.	Min.	Std.	Min.	Std.	Min.	Std.	Min.
1	2.0	2.0	74.3	74.3	72.3	72.3	72.3	72.3	70.3	70.3	67.8	67.8	64.8	64.8	20.0	20.0
4	3.8	3.8	65.3	65.3	63.3	63.3	61.5	61.5	59.5	59.5	55.8	55.8	52.8	52.8	23.0	23.0
8	5.3	5.3	60.8	60.8	58.8	58.8	55.4	55.4	53.4	53.4	49.7	49.7	46.7	46.7	24.5	24.5
10	6.0	6.0	59.3	59.3	57.3	57.3	53.3	53.3	51.3	51.3	47.8	47.8	44.8	44.8	25.0	25.0
16	7.6	7.6	56.2	56.2	54.2	54.2	48.7	48.7	46.7	46.7	43.7	43.7	40.7	40.7	25.0	25.0
31.25	10.7	10.7	51.9	51.9	49.9	49.9	41.2	41.2	39.2	39.2	37.9	37.9	34.9	34.9	23.6	23.6
62.5	15.4	15.4	47.4	47.4	45.4	45.4	32.0	32.0	30.0	30.0	31.9	21.9	28.9	28.9	21.5	21.5
100	19.8	19.8	44.3	44.3	42.3	42.3	24.5	24.5	22.5	22.5	27.8	27.8	24.8	24.8	20.1	20.1
155	25.2	25.2	41.1	41.1	39.4	39.4	16.3	16.3	14.3	14.3	24.0	24.0	21.0	21.0	18.8	18.8
200	29.0	29.0	39.8	39.8	37.8	37.8	10.8	10.8	8.8	8.8	21.8	21.8	18.8	18.8	18.0	18.0
250	32.8	32.8	38.3	38.3	36.3	36.3	5.5	5.5	3.5	3.5	19.8	19.8	16.8	16.8	17.3	17.3
350*	-	39.8	-	36.1	-	34.1	-	-	-	-	-	16.9	-	13.9	-	16.3
555*	-	52.0	-	33.1	-	31.1	-	-	-	-	-	12.9	-	9.9	-	14.9
660*	-	57.7	-	32.0	-	30.0	-	-	-	-	-	11.4	-	8.4	-	14.4

\*Frequencies beyond the TIA and ISO requirements are for information only. All values are dB/100m.

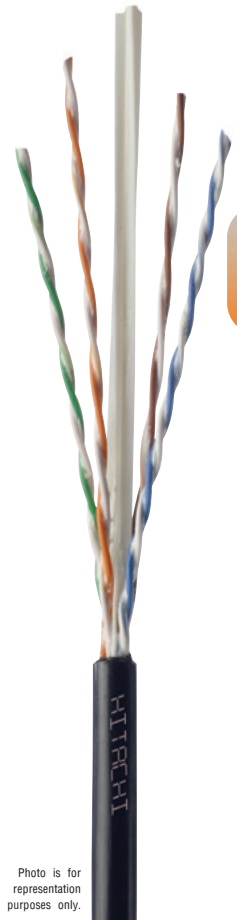

Copper

Photo is for representation purposes only.



## Electrical Characteristics

Input Impedance:	100 ± 15Ω (1.0 to 100 MHz) 100 ± 15Ω (101 to 250 MHz)
Maximum Resistance Unbalance:	5%
Maximum Capacitance Unbalance:	330 pF/100 meters
Maximum Delay Skew:	45 ns/100 meters
Nominal Velocity Of Propagation (Nvp):	67%
Voltage Rating:	300 Volts

Cable Ampacity Chart							
Bundle Size	1	2-7	8-19	20-37	38-61	62-91	92-192
Cable Temp	60°C	60°C	60°C	60°C	60°C	60°C	60°C
24 AWG	2.0	1.0	0.8	0.6	0.5	0.4	0.3

The table above is derived from the one approved by the National Fire Protection Agency and used in the National Electrical Code, NFPA-70. The complete table can be found in sections 725.144 and 800 Communication Circuits of the code. The table identifies the ampacity of each conductor (in amperes) in a 4-pair Class 2 or Class 3 data cable. Ambient temperature used for development of the table is 30°C (86° F) with all conductors in all cables carrying current. The table is based on 60°C (140°F), 75°C (167°F) and 90°C (194°F) rated cables. All cable temps are operational temp ratings. Cables with temp ratings above 90c would deliver additional power handling capacity.

# Outdoor

UTP

Copper

## Product Highlights

- REACH & RoHS 2 compliant
- Made in U.S.A.
- Suitable for direct burial, lashed aerial, duct and underground conduit applications
- Cable core is filled with non-conductive, water-blocking gel
- Rugged black polyolefin jacket
- UV resistant jacket

## Packaging

- 1,000 foot (305 m) reels
- Reverse sequential footage markings standard on each 1,000 foot package
- Unit/pallet: 20 Reels  
CMP Carton Weight (lbs): 20.05  
CMP Product Weight (lbs): 25.75  
\*weight may vary

## Applications

- Including:
  - HDBase-T A & B (Cat 6)
  - 5 Gigabit Ethernet (IEEE 802.3bz)(Cat 6)
  - 2.5 Gigabit Ethernet (IEEE 802.3bz)
  - Gigabit Ethernet (IEEE 802.3ab)
  - 100 Mbps Ethernet (IEEE 802.3u)
  - 1000 Mbps ATM
  - 622 Mbps ATM
  - 15W PoE (IEEE 802.3af)
  - 30W PoE+ (IEEE 802.3at)
  - 60W PoE++ (IEEE 802.3bt Type 3)
  - 100W PoE++ (IEEE 802.3bt Type 4)

## Temp. Range

- Storage Temperature  
-40°C to +70°C  
(-40°F to +158°F)
- Installation Temperature  
-20°C to +70°C  
(+40°F to +158°F)
- Operation Temperature  
-40°C to +70°C  
(-40°F to +158°F)

## Category 5e UTP Single Jacket

c(UL)us Listed Type CMP (NFPA 262), CSA Type FT6

PART #	# OF PAIRS	CALCULATED CABLE O.D.		CABLE WEIGHT	
		inches	mm	lbs/1000 ft	kg/305 m
30145-8-XXY	4	0.23	5.8	25.75	11.68

## Building a Part Number

Base Part Number Ex.	No. of Conductors	Jacket Color	Reel Type
30145	8	XX	Y

Jacket Colors (XX):  
Black (BK)

Reel Type (Y):  
Reel (3)

## Features

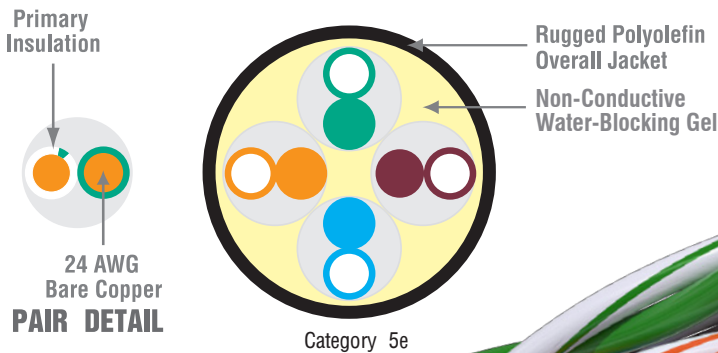

## DIELECTRIC MATERIALS OUTDOOR F/UTP CABLES

Primary Insulation: Polyolefin  
Overall Jacket: Medium density polyolefin

Hitachi Cable America reserves the right to revise any specifications.

# Cat 5e OSP

## Transmission Specifications

ANSI/TIA-568.2-D Category 5e Verified  
ISO/IEC 11801, 2nd ed. Class D Compliant

Freq. (MHz)	Ins. Loss		NEXT		PSNEXT		ACR		PSACR		ACRF		PSACRF		Return Loss	
	Std.	Max.	Std.	Min.	Std.	Min.	Cal.	Min.	Cal.	Min.	Std.	Min.	Std.	Min.	Std.	Min.
1	2.0	2.0	65.3	65.3	62.3	62.3	63.3	63.3	60.3	60.3	63.8	63.8	60.8	60.8	20.0	20.0
4	4.1	4.1	56.3	56.3	53.3	53.3	52.2	52.2	49.2	49.2	51.8	51.8	48.8	48.8	23.0	23.0
8	5.8	5.8	51.8	51.8	48.8	48.8	46.0	46.0	43.0	43.0	45.7	45.7	42.7	42.7	24.5	24.5
10	6.5	6.5	50.3	50.3	47.3	47.3	43.8	43.8	40.8	40.8	43.8	43.8	40.8	40.8	25.0	25.0
16	8.2	8.2	47.2	47.2	44.2	44.2	39.0	39.0	36.0	36.0	39.7	39.7	36.7	36.7	25.0	25.0
31.25	11.7	11.7	42.9	42.9	39.9	39.9	31.2	31.2	28.2	28.2	33.9	33.9	30.9	30.9	23.6	23.6
62.5	17.0	17.0	38.4	38.4	35.4	35.4	21.4	21.4	18.4	18.4	27.9	27.9	24.9	24.9	21.5	21.5
100	22.0	22.0	35.3	35.3	32.3	32.3	13.3	13.3	10.3	10.3	23.8	23.8	20.8	20.8	20.1	20.1
155*	-	28.1	-	32.4	-	29.4	4.4	4.4	1.4	1.4	-	20.0	-	17.0	-	18.8
200*	-	32.4	-	30.8	-	27.8	-	-	-	-	-	17.8	-	14.8	-	18.0
250*	-	36.9	-	29.3	-	26.3	-	-	-	-	-	15.8	-	12.8	-	17.3
400*	-	48.5	-	26.3	-	23.3	-	-	-	-	-	11.8	-	8.8	-	15.9

\*Frequencies beyond the TIA and ISO requirements are for information only. All values are dB/100m.



Copper

Photo is for representation purposes only.



## Electrical Characteristics

Input Impedance:	100 ± 15Ω (1.0 to 100 MHz) 100 ± 15Ω (101 to 250 MHz)
Maximum Resistance Unbalance:	5%
Maximum Capacitance Unbalance:	330 pF/100 meters
Maximum Delay Skew:	45 ns/100 meters
Nominal Velocity Of Propagation (Nvp):	63%, Riser
Voltage Rating:	300 Volts

Cable Ampacity Chart							
Bundle Size	1	2-7	8-19	20-37	38-61	62-91	92-192
Cable Temp	60°C	60°C	60°C	60°C	60°C	60°C	60°C
24 AWG	2.0	1.0	0.8	0.6	0.5	0.4	0.3

The table above is derived from the one approved by the National Fire Protection Agency and used in the National Electrical Code, NFPA-70. The complete table can be found in sections 725.144 and 800 Communication Circuits of the code. The table identifies the ampacity of each conductor (in amperes) in a 4-pair Class 2 or Class 3 data cable. Ambient temperature used for development of the table is 30°C (86° F) with all conductors in all cables carrying current. The table is based on 60°C (140°F), 75°C (167°F) and 90°C (194°F) rated cables. All cable temps are operational temp ratings. Cables with temp ratings above 90c would deliver additional power handling capacity.

# Fiber Selection GUIDE

FIBER

## Fiber Selection Guide

### How much fiber do you need?

- Fiber optic cables are frequently cut to length by the manufacturer or by an authorized distributor. This allows you to get exactly the length you need for each cable run. You can also order a reel equivalent in length to all your cable run lengths and cut your own cable segments.
- Even though extreme care may have been taken when measuring the distances between termination points, it is highly recommended to build in a safety buffer when ordering fiber optic cable. An additional 10% is typical.

### How many strands of fiber do you need?

- Fiber optic cables typically come in multiples of 2 fiber increments and are commonly available in 6, 12, 24, 48, 72 and 144 fiber configurations.
- Design engineers allow for a number of spare fibers to accommodate possible fiber breaks and for future upgrades to the system. Migration from one Ethernet application to another, such as 1 gigabit to 10 gigabit, may require additional fibers. Accounting for future growth when pulling in the cables now is very cost effective.
- Non-standard fiber counts can be manufactured to specific minimum quantities. Lead times may apply, however. Sometimes using multiple cables to achieve the total fiber count, such as combining a 24-fiber and a 48-fiber cable rather than using a 72-fiber, results in quicker access to product and, depending on the cable pathways, an easier installation.

### Do you want loose tube or tight buffered fibers?

- Tight buffered refers to the type of cable in which the fiber strands have an additional layer of material applied to the fiber, similar to insulation around a copper conductor. This layer usually increases the size of the fiber strand from 250 micron to 900 micron. The 900 micron size is the standard size for terminating fibers on a job site.
- Loose tube refers to cable designs where the fibers are 250 micron in diameter. They are color-coded to differentiate one fiber from another. The small fiber diameter usually permits smaller cable diameters than tight buffered designs. Originally used in high-fiber outside plant cables, loose tube fibers are now used indoors or anywhere where cable pathway space is limited. Termination of loose tubes requires either a fan-out kit or the ability to splice connectors.

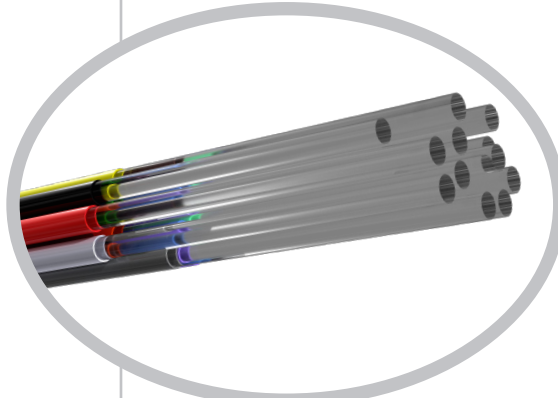

Loose Tube

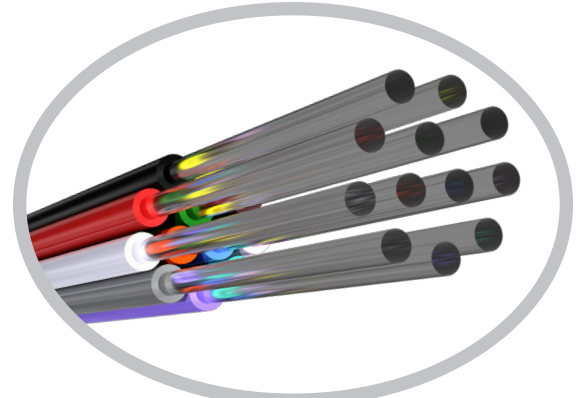

Tight Buffered

## Determine the type of fiber (optical glass) you need.

- Fibers come in two primary categories: singlemode and multimode. Singlemode is typically used in high bandwidth/ long distance applications. Multimode, which can also be used for high bandwidth applications, is typically used in instances where cable runs do not exceed 550 meters. Multimode and singlemode utilize different electronics. Hitachi Cable America's standard singlemode glass is the higher performing OS2.
- Multimode is available in different performance levels starting with low performing OM1 (62.5 micron core) and then increasing performance levels of 50 micron core designs including OM2, OM3, OM4. The designation OM is short for Optical Fiber Multimode. Likewise, OS for singlemode fiber stands for Optical Fiber Singlemode. See the Optical Specifications for each product for more information. Due to the different core size, OM1 fibers cannot be mated to OM2, OM3 or OM4 fibers.

## In what environment will the fiber optic cable be installed?

- Cables constructions are specific to an environment, such as indoor, outdoor or both indoor/ outdoor environments.
- Many cables are also available in armored constructions for additional protection. Interlock armoring is typically used for indoor and indoor/outdoor cables while corrugated armoring is used for traditional outside plant cables.
- When installing cables indoor or indoor/outdoor, ensure the cables are labeled with the appropriate National Electrical Code (NEC) rating required for that location. Ratings such as OFNP (Optical Fiber Non-conductive Plenum) or OFNR (Optical Fiber Non-conductive Riser) are standard designs. Cables that are armored or contain metal must be identified with a C in the rating instead of an N. C stands for conductive.
- Outdoor cables do not require an NEC rating, but must be terminated within 50 feet of entering the building.

## Need help choosing the right fiber optic cable?

- The Optical Specifications table below is an example of the kind of information provided in this catalog for every fiber optic cable. Though attenuation may vary slightly between different cable constructions, the guaranteed application support distance for gigabit (Gb) Ethernet and 10 Gb Ethernet are consistent throughout the catalog.
- If you are uncertain about any aspects of the cable selection process, contact an authorized Hitachi Cable America distributor or contact Hitachi Cable America directly at the Manchester, New Hampshire manufacturing facility.



## Optical Specifications

TIA-568.3-D | ISO/IEC 11801, 2nd edition | Telcordia GR-409-CORE

Fiber type	Max. Attenuation (dB/km)		Min OFL Bandwidth (MHz-km)		Min EMBc Bandwidth (MHz-km)		Gb Ethernet distance (m)		10 Gb Ethernet distance (m)	
	850nm (MM)	1300nm (MM)	850nm (MM)	1300nm (MM)	850nm (MM)	1300nm (MM)	850nm (MM)	1300nm (MM)	850nm (MM)	1300nm (MM)
OM1	3.5	1.0	200	500	220	N/A	300	550	33	N/A
OM2	3.0	1.0	700	500	950	N/A	750	550	150	N/A
OM3	3.0	1.0	1500	500	2000	N/A	1000	550	300	N/A
OM4	3.0	1.0	3500	500	4700	N/A	1100	550	550	N/A
OM5*	3.0	1.0	3500	500	4700	N/A	1100	550	550	N/A
	1310nm (SM)	1550nm (SM)	1310nm (SM)	1550nm (SM)	1310nm (SM)	1550nm (SM)	1310nm (SM)	1550nm (SM)	1310nm (SM)	1550nm (SM)
OS2	0.5	0.5	N/A	N/A	N/A	N/A	> 25,000	> 40,000	10,000 - 25,000	40,000

Hitachi Cable America reserves the right to revise any specifications.

\*OM5 optical fiber tested by glass manufacturer and exceeds the requirements of all applicable industry standards.

# Indoor Tight Buffered

1-fiber, 2-fiber and zip

FIBER

## Product Highlights

- REACH & RoHS 2 compliant
- Made in U.S.A.
- 900 micron buffered design recommended for easy termination
- All multimode, and singlemode cables (except OM1) utilize bend-insensitive optical fibers
- Ideal for patch cords, interconnections, and short runs
- Easy to strip and terminate
- All multimode and singlemode cables (except OM1) utilize bend-insensitive optical fibers
- Easy to strip and terminate
- Lightweight, flexible aramid yarns enhance strength

## Options

- Enhanced bend insensitive OS2 optical fiber is available (ITU-T G.657.B3 & G.657.A2)
- Standard jacket colors are:
  - Yellow: OS2
  - Orange: OM1 & OM2
  - Aqua: OM3 & OM4
  - Lime Green: OM5

*Note: Erika Violet for OM4 is available.*
- OM4+ optical fibers with extended 10 gigabit Ethernet distances are available

## Applications

- Applications include 10, 40 & 100 gigabit Ethernet, Fibre Channel, Video, Security, Automation
- OM5 supports applications utilizing Short Wave Division Multiplexing (SWDM)

## Standards

- ANSI/TIA-568.3-D
- ISO/IEC 11801, 2nd edition
- Telcordia GR-409-CORE

## Interconnect (Riser)

(UL) OFNR c(UL) OFNR FT4

### PART NUMBERS BY FIBER COUNT

FIBER COUNT	62.5 UM OM1	50 UM OM2	50 UM OM3	50 UM OM4	50 UM OM5	8.3 UM OS2
1	60001-1	60004-1	60464-1	61838-1	62720-1	60040-1
1	60037-1	60003-1	60465-1	61791-1	62721-1	60039-1
1	60038-1	60002-1	60466-1	61792-1	62722-1	60010-1
1	60425-1	60462-1	60467-1	61793-1	62723-1	60489-1
2	60001-2	60004-2	60464-2	61838-2	62720-2	60040-2
2	60514-2	60063-2	60463-2	61842-2	62724-2	60012-2
zip	60288-2	60376-2	61483-2	61988-2	62725-2	60289-2
zip	60005-2	60007-2	60501-2	61844-2	62726-2	60011-2

## Optical Specifications

TIA-568.3-D | ISO/IEC 11801, 2nd edition | Telcordia GR-409-CORE

Fiber type	Max. Attenuation (dB/km)		Min OFL Bandwidth (MHz-km)		Min EMBc Bandwidth (MHz-km)		Gb Ethernet distance (m)		10 Gb Ethernet distance(m)	
	850nm (MM)	1300nm (MM)	850nm (MM)	1300nm (MM)	850nm (MM)	1300nm (MM)	850nm (MM)	1300nm (MM)	850nm (MM)	1300nm (MM)
OM1	3.5	1.0	200	500	220	N/A	300	550	33	N/A
OM2	3.0	1.0	700	500	950	N/A	750	550	150	N/A
OM3	3.0	1.0	1500	500	2000	N/A	1000	550	300	N/A
OM4	3.0	1.0	3500	500	4700	N/A	1100	550	550	N/A
OM5*	3.0	1.0	3500	500	4700	N/A	1100	550	550	N/A
	1310nm (SM)	1550nm (SM)	1310nm (SM)	1550nm (SM)	1310nm (SM)	1550nm (SM)	1310nm (SM)	1550nm (SM)	1310nm (SM)	1550nm (SM)
OS2	0.5	0.5	N/A	N/A	N/A	N/A	> 25,000	> 40,000	10,000 - 25,000	40,000

\*OM5 optical fiber tested by glass manufacturer and exceeds the requirements of all applicable industry standards. Hitachi Cable America reserves the right to revise any specifications.

## Cable Temperature Ranges

Storage: -40° to 70°C (-40° to 158°F)  
 Installation: 0° to 60°C (32° to 140°F)  
 Operating: 0° to 70°C (32° to 158°F)

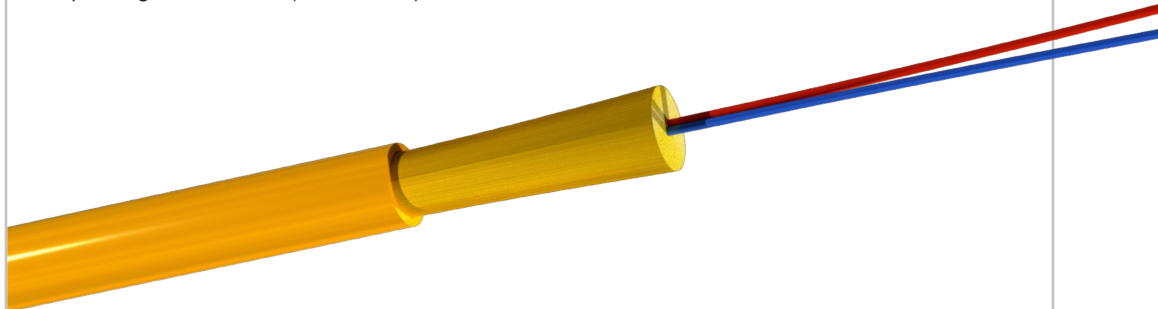



**SPECIFICATIONS BY FIBER COUNT**

FIBERS	CABLE O.D.		RECOMMENDED MAXIMUM LOADS				CABLE WEIGHT	
	inches	mm	INSTALL		OPERATION			
			lbs-f	N	lbs-f	N	lbs/1000 ft	kg/1000 m
1	0.114	2.9	96	427	29	128	4.9	7.3
1	0.094	2.4	64	285	19	85	3.6	5.4
1	0.079	2.0	50	223	15	67	3.2	4.8
1	0.063	1.6	50	223	15	67	1.8	2.7
2	0.114	2.9	96	427	29	128	4.3	6.4
2	0.190	4.8	128	569	38	171	11.5	17.1
zip	.079 x .170	2.0 x 4.3	96	427	29	128	5.7	8.5
zip	.110 x .229	2.8 x 5.8	128	569	38	171	10.2	15.2

## Mechanical Specifications

- Bend radius, no load = 10x cable overall diameter
- Bend radius, load = 15x cable overall diameter



FIBER



## Features

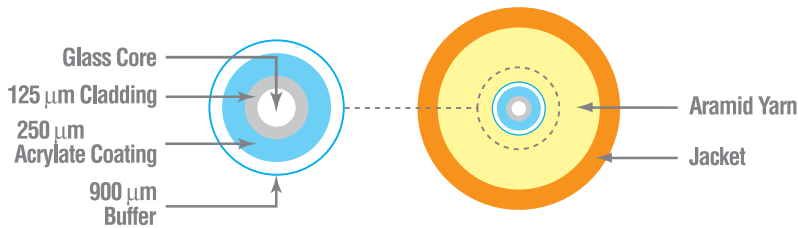

**DIELECTRIC MATERIALS**

**RISER**

Overall Jacket: Flame-retardant Thermoplastic



1-fiber Interconnect

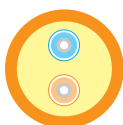

2-fiber Interconnect

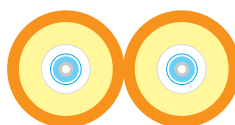

2-fiber Zip Cord

Diagram scale approx. 5:1

Photo is for representation purposes only.

# Indoor Tight Buffered

1-fiber, 2-fiber and zip

FIBER

## Product Highlights

- REACH & RoHS 2 compliant
- Made in U.S.A.
- 900 micron buffered design recommended for easy termination
- All multimode, and singlemode cables (except OM1) utilize bend-insensitive optical fibers
- Ideal for patch cords, interconnections, and short runs
- Easy to strip and terminate
- Lightweight, flexible aramid yarns enhance strength
- Extremely flexible for easy handling

## Options

- Enhanced bend insensitive OS2 optical fiber is available (ITU-T G.657.B3 & G.657.A2)
- Standard jacket colors are:  
 Yellow: OS2  
 Orange: OM1 & OM2  
 Aqua: OM3 & OM4  
 Lime Green: OM5  
*Note: Erika Violet for OM4 is available.*
- OM4+ optical fibers with extended 10 gigabit Ethernet distances are available

## Applications

- Applications include 10, 40 & 100 gigabit Ethernet, Fibre Channel, Video, Security, Automation
- OM5 supports applications utilizing Short Wave Division Multiplexing (SWDM)

## Standards

- ANSI/TIA-568.3-D
- ISO/IEC 11801, 2nd edition
- Telcordia GR-409-CORE

## Interconnect (Plenum)

(UL) OFNP c(UL) OFNP FT6

### PART NUMBERS BY FIBER COUNT

FIBERS	62.5 UM OM1	50 UM OM2	50 UM OM3	50 UM OM4	50 UM OM5	8.3 UM OS2
1	60042-1	60022-1	60472-1	61851-1	62734-1	60044-1
1	60430-1	60468-1	60473-1	61852-1	62735-1	60490-1
1	60431-1	60469-1	60474-1	61853-1	62736-1	60491-1
1	60432-1	60470-1	60475-1	61854-1	62737-1	60492-1
2	60042-2	60022-2	60472-2	61851-2	62734-2	60044-2
2	60024-2	60026-2	60471-2	61855-2	62738-2	60031-2
zip	62956-2	60316-2	62950-2	62951-2	62953-2	62954-2
zip	61379-2	61444-2	61457-2	61986-2	62739-2	61378-2
zip	60023-2	60008-2	60502-2	61857-2	62740-2	60030-2

## Optical Specifications

TIA-568.3-D | ISO/IEC 11801, 2nd edition | Telcordia GR-409-CORE

Fiber type	Max. Attenuation (dB/km)		Min OFL Bandwidth (MHz-km)		Min EMBc Bandwidth (MHz-km)		Gb Ethernet distance (m)		10 Gb Ethernet distance(m)	
	850nm (MM)	1300nm (MM)	850nm (MM)	1300nm (MM)	850nm (MM)	1300nm (MM)	850nm (MM)	1300nm (MM)	850nm (MM)	1300nm (MM)
OM1	3.5	1.0	200	500	220	N/A	300	550	33	N/A
OM2	3.0	1.0	700	500	950	N/A	750	550	150	N/A
OM3	3.0	1.0	1500	500	2000	N/A	1000	550	300	N/A
OM4	3.0	1.0	3500	500	4700	N/A	1100	550	550	N/A
OM5*	3.0	1.0	3500	500	4700	N/A	1100	550	550	N/A
	1310nm (SM)	1550nm (SM)	1310nm (SM)	1550nm (SM)	1310nm (SM)	1550nm (SM)	1310nm (SM)	1550nm (SM)	1310nm (SM)	1550nm (SM)
OS2	0.5	0.5	N/A	N/A	N/A	N/A	> 25,000	> 40,000	10,000 - 25,000	40,000

\*OM5 optical fiber tested by glass manufacturer and exceeds the requirements of all applicable industry standards. Hitachi Cable America reserves the right to revise any specifications.

### Cable Temperature Ranges

Storage: -40° to 70°C (-40° to 158°F)  
 Installation: 0° to 60°C (32° to 140°F)  
 Operating: 0° to 70°C (32° to 158°F)

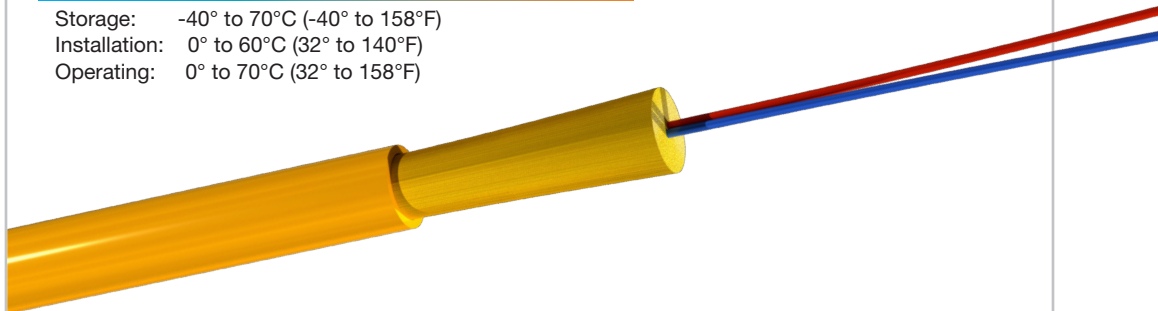

**SPECIFICATIONS BY FIBER COUNT**

FIBERS	CABLE O.D.		RECOMMENDED MAXIMUM LOADS				CABLE WEIGHT	
	inches	mm	INSTALL		OPERATION		lbs/1000 ft	kg/1000 m
			lbs-f	N	lbs-f	N		
1	0.114	2.9	96	427	29	128	5.6	8.3
1	0.094	2.4	64	285	19	85	4.7	6.9
1	0.079	2.0	50	223	15	67	3.6	5.3
1	0.063	1.6	50	223	15	67	2.0	2.9
2	0.114	2.9	96	427	29	128	6.4	9.5
2	0.190	4.8	128	569	38	171	13.1	19.4
zip	.063 x .038	1.6 x 3.5	50	223	15	67	2.67	3.97
zip	.079 x .170	2.0 x 4.3	96	427	48	213	6.27	9.3
zip	.113 x .235	2.9 x 6.0	128	569	64	284	13.2	19.6

## Mechanical Specifications

- Bend radius, no load = 10x cable overall diameter
- Bend radius, load = 15x cable overall diameter



FIBER



## Features

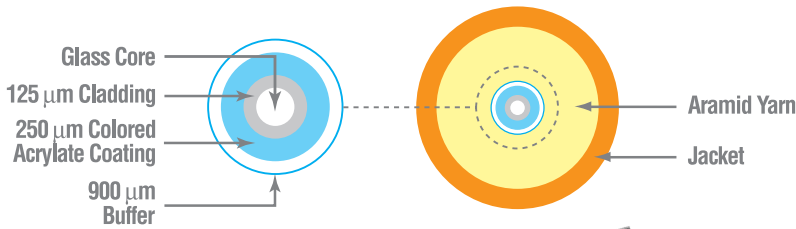

### DIELECTRIC MATERIALS

#### PLENUM

Overall Jacket: Flame-retardant Thermoplastic



1-fiber Interconnect

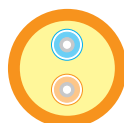

2-fiber Interconnect

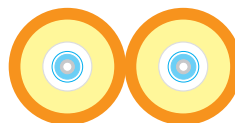

2-fiber Zip Cord

Diagram scale approx. 5:1

# Indoor Tight Buffered

1-fiber, 2-fiber and zip

FIBER

## Product Highlights

- REACH & RoHS 2 compliant
- Made in U.S.A.
- 900 micron buffered design recommended for easy termination
- LSZH with OFNR rating enables use in riser-rated environments
- Halogen free design offers improved safety performance
- All multimode, and singlemode cables (except OM1) utilize bend-insensitive optical fibers
- Ideal for patch cords, interconnections, and short runs
- Easy to strip and terminate
- Lightweight, flexible aramid yarns enhance strength
- LSZH rating established via HCA material testing to IEC 60332-3-24, IEC 60754-1 & 2 and IEC 61034-2

## Options

- Enhanced bend insensitive OS2 optical fiber is available (ITU-T G.657.B3 & G.657.A2)
- Standard jacket colors are:
  - Yellow: OS2
  - Orange: OM1 & OM2
  - Aqua: OM3 & OM4
  - Lime Green: OM5

*Note: Erika Violet for OM4 is available.*
- OM4+ optical fibers with extended 10 gigabit Ethernet distances are available

## Applications

- Applications include 10, 40 & 100 gigabit Ethernet, Fibre Channel, Video, Security, Automation
- OM5 supports applications utilizing Short Wave Division Multiplexing (SWDM)

## Standards

- ANSI/TIA-568.3-D
- ISO/IEC 11801, 2nd edition
- Telcordia GR-409-CORE

## Interconnect (LSZH/Riser)

Low Smoke Zero Halogen (UL) OFNR c(UL) OFNR FT4

### PART NUMBERS BY FIBER COUNT

FIBERS	62.5 UM OM1	50 UM OM2	50 UM OM3	50 UM OM4	50 UM OM5	8.3 UM OS2
1	62124-1	62125-1	62126-1	62127-1	62727-1	62029-1
1	62129-1	62130-1	62131-1	62132-1	62728-1	62133-1
1	62135-1	62136-1	62137-1	62138-1	62729-1	62139-1
1	62141-1	62142-1	62143-1	62144-1	62730-1	62145-1
2	62124-2	62125-2	62126-2	62127-2	62727-2	62029-2
2	62147-2	62148-2	62149-2	62150-2	62731-2	62151-2
zip	62957-2	62958-2	62959-2	62960-2	62962-2	62963-2
zip	62275-2	61769-2	62276-2	62277-2	62732-2	62274-2
zip	62153-2	62154-2	62155-2	62156-2	62733-2	62157-2

## Optical Specifications

TIA-568.3-D | ISO/IEC 11801, 2nd edition | Telcordia GR-409-CORE

Fiber type	Max. Attenuation (dB/km)		Min OFL Bandwidth (MHz-km)		Min EMBc Bandwidth (MHz-km)		Gb Ethernet distance (m)		10 Gb Ethernet distance(m)	
	850nm (MM)	1300nm (MM)	850nm (MM)	1300nm (MM)	850nm (MM)	1300nm (MM)	850nm (MM)	1300nm (MM)	850nm (MM)	1300nm (MM)
OM1	3.5	1.0	200	500	220	N/A	300	550	33	N/A
OM2	3.0	1.0	700	500	950	N/A	750	550	150	N/A
OM3	3.0	1.0	1500	500	2000	N/A	1000	550	300	N/A
OM4	3.0	1.0	3500	500	4700	N/A	1100	550	550	N/A
OM5*	3.0	1.0	3500	500	4700	N/A	1100	550	550	N/A
	1310nm (SM)	1550nm (SM)	1310nm (SM)	1550nm (SM)	1310nm (SM)	1550nm (SM)	1310nm (SM)	1550nm (SM)	1310nm (SM)	1550nm (SM)
OS2	0.5	0.5	N/A	N/A	N/A	N/A	> 25,000	> 40,000	10,000 - 25,000	40,000

\*OM5 optical fiber tested by glass manufacturer and exceeds the requirements of all applicable industry standards. Hitachi Cable America reserves the right to revise any specifications.

### Cable Temperature Ranges

Storage: -40° to 70°C (-40° to 158°F)  
 Installation: 0° to 60°C (32° to 140°F)  
 Operating: 0° to 70°C (32° to 158°F)

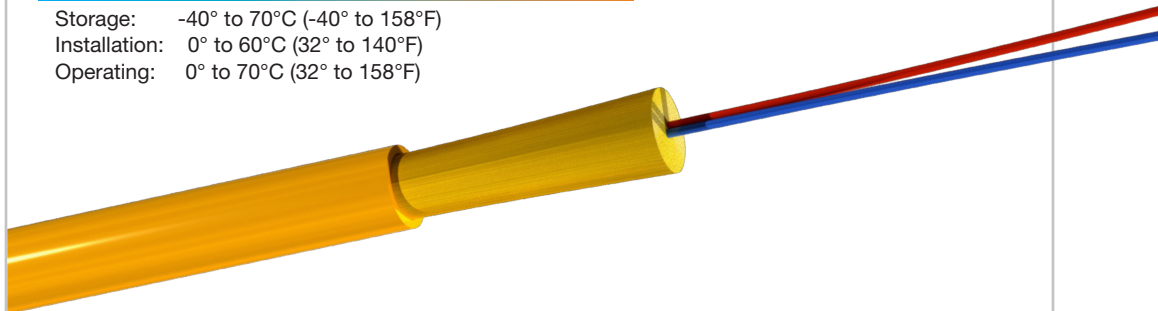

**SPECIFICATIONS BY FIBER COUNT**

FIBERS	CABLE O.D.		RECOMMENDED MAXIMUM LOADS				CABLE WEIGHT	
	inches	mm	INSTALL		OPERATION		lbs/1000 ft	kg/1000 m
			lbs-f	N	lbs-f	N		
1	0.114	2.9	96	427	29	128	4.9	7.3
1	0.094	2.4	64	285	19	85	4.1	6.1
1	0.079	2.0	50	223	15	67	3.5	5.2
1	0.063	1.6	50	223	15	67	1.85	2.8
2	0.114	2.9	96	427	29	128	5.35	8.0
2	0.19	4.8	128	569	38	171	12.9	19.2
zip	.063 x .138	1.6 x 3.5	50	223	15	67	2.67	4.0
zip	.079 x .170	2.0 x 4.3	96	427	48	213	6.2	9.2
zip	.113 x .240	2.9 x 6.1	128	569	64	284	11.5	17.1

## Mechanical Specifications

- Bend radius, no load = 10x cable overall diameter
- Bend radius, load = 15x cable overall diameter



FIBER



## Features

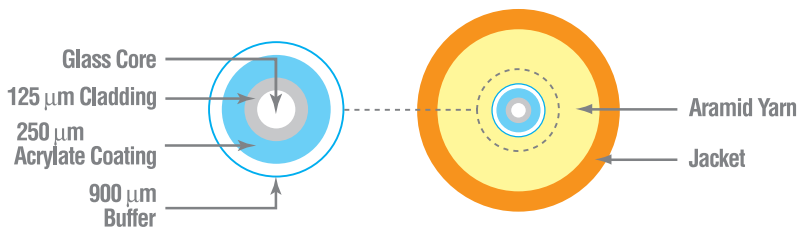

**DIELECTRIC MATERIALS**

**LSZH/RISER**

Overall Jacket: Flame-retardant Thermoplastic



1-fiber Interconnect

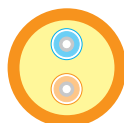

2-fiber Interconnect

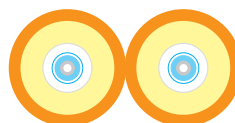

2-fiber Zip Cord

Diagram scale approx. 5:1

Photo is for representation purposes only.

# Indoor Tight Buffered

2 through 24 fibers

FIBER

## Product Highlights

- REACH & RoHS 2 compliant
- Made in U.S.A.
- 900 micron buffered design recommended for easy termination
- All multimode, and singlemode cables (except OM1) utilize bend-insensitive optical fibers
- Each fiber is color coded for easy identification
- Ideal intra-building cable solution
- Flexible and easy to handle.
- Lightweight, flexible aramid yarns enhance strength

## Options

- Enhanced bend insensitive OS2 optical fiber is available (ITU-T G.657.B3 & G.657.A2)
- Standard jacket colors are:  
Yellow: OS2  
Orange: OM1 & OM2  
Aqua: OM3 & OM4  
Lime Green: OM5  
*Note: Erika Violet for OM4 is available.*
- OM4+ optical fibers with extended 10 gigabit Ethernet distances are available

## Applications

- Applications include 10, 40 & 100 gigabit Ethernet, Fibre Channel, Video, Security, Automation
- OM5 supports applications utilizing Short Wave Division Multiplexing (SWDM)

## Standards

- ANSI/TIA-568.3-D
- ISO/IEC 11801, 2nd edition
- Telcordia GR-409-CORE

## Single-Unit (Plenum)

(UL) OFNP c(UL) OFNP FT6

### PART NUMBERS BY FIBER COUNT

FIBERS	62.5 UM OM1	50 UM OM2	50 UM OM3	50 UM OM4	50 UM OM5	8.3 UM OS2
2	60024-2	60026-2	60471-2	61855-2	62738-2	60031-2
4	60517-4	60518-4	60522-4	61868-4	62742-4	60029-4
6	60517-6	60518-6	60522-6	61868-6	62742-6	60029-6
8	60517-8	60518-8	60522-8	61868-8	62742-8	60029-8
10	60517-10	60518-10	60522-10	61868-10	62742-10	60029-10
12	60517-12	60518-12	60522-12	61868-12	62742-12	60029-12
24	60517-24	60518-24	60522-24	61868-24	62742-24	60029-24

## Optical Specifications

TIA-568.3-D | ISO/IEC 11801, 2nd edition | Telcordia GR-409-CORE

Fiber type	Max. Attenuation (dB/km)		Min OFL Bandwidth (MHz-km)		Min EMBc Bandwidth (MHz-km)		Gb Ethernet distance (m)		10 Gb Ethernet distance(m)	
	850nm (MM)	1300nm (MM)	850nm (MM)	1300nm (MM)	850nm (MM)	1300nm (MM)	850nm (MM)	1300nm (MM)	850nm (MM)	1300nm (MM)
OM1	3.5	1.0	200	500	220	N/A	300	550	33	N/A
OM2	3.0	1.0	700	500	950	N/A	750	550	150	N/A
OM3	3.0	1.0	1500	500	2000	N/A	1000	550	300	N/A
OM4	3.0	1.0	3500	500	4700	N/A	1100	550	550	N/A
OM5*	3.0	1.0	3500	500	4700	N/A	1100	550	550	N/A
	1310nm (SM)	1550nm (SM)	1310nm (SM)	1550nm (SM)	1310nm (SM)	1550nm (SM)	1310nm (SM)	1550nm (SM)	1310nm (SM)	1550nm (SM)
OS2	0.5	0.5	N/A	N/A	N/A	N/A	> 25,000	> 40,000	10,000 - 25,000	40,000

\*OM5 optical fiber tested by glass manufacturer and exceeds the requirements of all applicable industry standards.

Hitachi Cable America reserves the right to revise any specifications.

### Cable Temperature Ranges

Storage: -40° to 70°C (-40° to 158°F)  
Installation: -10° to 60°C (14° to 140°F)  
Operating: -20° to 70°C (-4° to 158°F)

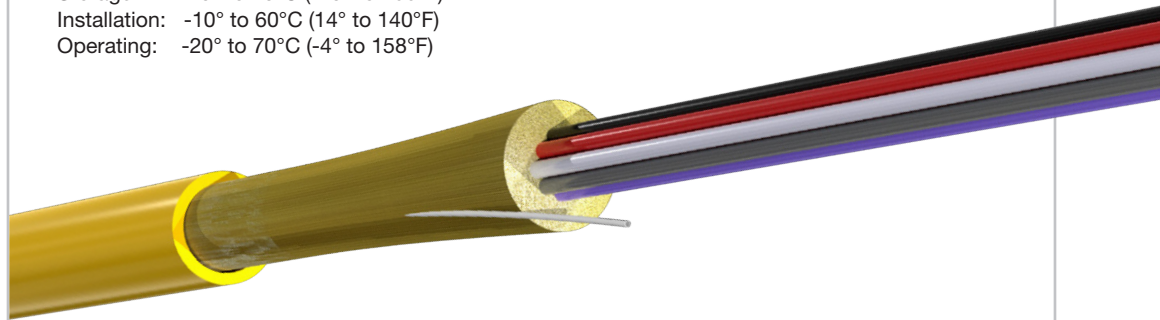

# Multimode and Singlemode Single-Unit

## SPECIFICATIONS BY FIBER COUNT

FIBERS	CABLE O.D.		RECOMMENDED MAXIMUM LOADS				CABLE WEIGHT	
			INSTALL		OPERATION			
	inches	mm	lbs-f	N	lbs-f	N	lbs/1000 ft	kg/1000 m
2	0.190	4.8	128	569	38	171	13.3	19.8
4	0.190	4.8	128	569	38	171	14.5	21.6
6	0.190	4.8	128	569	38	171	15.7	23.4
8	0.230	5.8	160	712	48	214	20.9	31.1
10	0.230	5.8	160	712	48	214	21.7	32.3
12	0.230	5.8	160	712	48	214	23.0	34.3
24	0.330	8.4	288	1282	86	385	50.3	74.9

## Mechanical Specifications

- Bend radius, no load = 10x cable overall diameter
- Bend radius, load = 15x cable overall diameter

plus  
**CORNING®**  
ClearCurve® Optical Fiber

FIBER

## Features

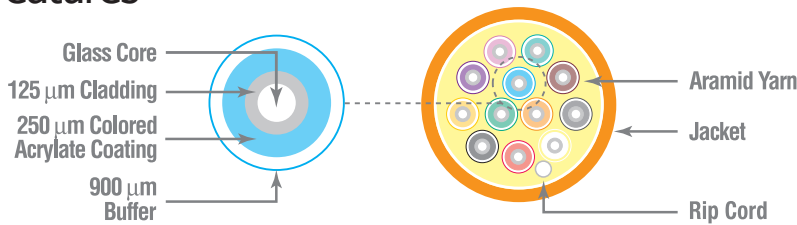

### DIELECTRIC MATERIALS

#### PLENUM

Overall Jacket: Flame-retardant Thermoplastic



2-fiber



4-fiber



6-fiber



8-fiber



10-fiber



12-fiber

Diagram scale approx. 2:1



Photo is for representation purposes only.

# Indoor Tight Buffered

2 through 24 fibers

FIBER

## Product Highlights

- REACH & RoHS 2 compliant
- Made in U.S.A.
- 900 micron buffered design recommended for easy termination
- All multimode, and singlemode cables (except OM1) utilize bend-insensitive optical fibers
- Each fiber is color coded for easy identification
- Ideal intra-building cable solution
- Flexible and easy to handle
- Lightweight, flexible aramid yarns enhance strength

## Options

- Enhanced bend insensitive OS2 optical fiber is available (ITU-T G.657.B3 & G.657.A2)
- Standard jacket colors are:  
 Yellow: OS2  
 Orange: OM1 & OM2  
 Aqua: OM3 & OM4  
 Lime Green: OM5  
*Note: Erika Violet for OM4 is available.*
- OM4+ optical fibers with extended 10 gigabit Ethernet distances are available

## Applications

- Applications include 10, 40 & 100 gigabit Ethernet, Fibre Channel, Video, Security, Automation
- OM5 supports applications utilizing Short Wave Division Multiplexing (SWDM)

## Standards

- ANSI/TIA-568.3-D
- ISO/IEC 11801, 2nd edition
- Telcordia GR-409-CORE

## Single-Unit (Riser)

(UL) OFNR c(UL) OFNR FT4

### PART NUMBERS BY FIBER COUNT

FIBERS	62.5 UM OM1	50 UM OM2	50 UM OM3	50 UM OM4	50 UM OM5	8.3 UM OS2
2	60514-2	60063-2	60463-2	61842-2	62724-2	60012-2
4	60515-4	60516-4	60520-4	61865-4	62741-4	60014-4
6	60515-6	60516-6	60520-6	61865-6	62741-6	60014-6
8	60515-8	60516-8	60520-8	61865-8	62741-8	60014-8
10	60515-10	60516-10	60520-10	61865-10	62741-10	60014-10
12	60515-12	60516-12	60520-12	61865-12	62741-12	60014-12
24	60515-24	60516-24	60520-24	61865-24	62741-24	60014-24

## Optical Specifications

TIA-568.3-D | ISO/IEC 11801, 2nd edition | Telcordia GR-409-CORE

Fiber type	Max. Attenuation (dB/km)		Min OFL Bandwidth (MHz-km)		Min EMBc Bandwidth (MHz-km)		Gb Ethernet distance (m)		10 Gb Ethernet distance(m)	
	850nm (MM)	1300nm (MM)	850nm (MM)	1300nm (MM)	850nm (MM)	1300nm (MM)	850nm (MM)	1300nm (MM)	850nm (MM)	1300nm (MM)
OM1	3.5	1.0	200	500	220	N/A	300	550	33	N/A
OM2	3.0	1.0	700	500	950	N/A	750	550	150	N/A
OM3	3.0	1.0	1500	500	2000	N/A	1000	550	300	N/A
OM4	3.0	1.0	3500	500	4700	N/A	1100	550	550	N/A
OM5*	3.0	1.0	3500	500	4700	N/A	1100	550	550	N/A
	1310nm (SM)	1550nm (SM)	1310nm (SM)	1550nm (SM)	1310nm (SM)	1550nm (SM)	1310nm (SM)	1550nm (SM)	1310nm (SM)	1550nm (SM)
OS2	0.5	0.5	N/A	N/A	N/A	N/A	> 25,000	> 40,000	10,000 - 25,000	40,000

\*OM5 optical fiber tested by glass manufacturer and exceeds the requirements of all applicable industry standards.

Hitachi Cable America reserves the right to revise any specifications.

### Cable Temperature Ranges

Storage: -40° to 70°C (-40° to 158°F)  
 Installation: -10° to 60°C (14° to 140°F)  
 Operating: -20° to 70°C (-4° to 158°F)

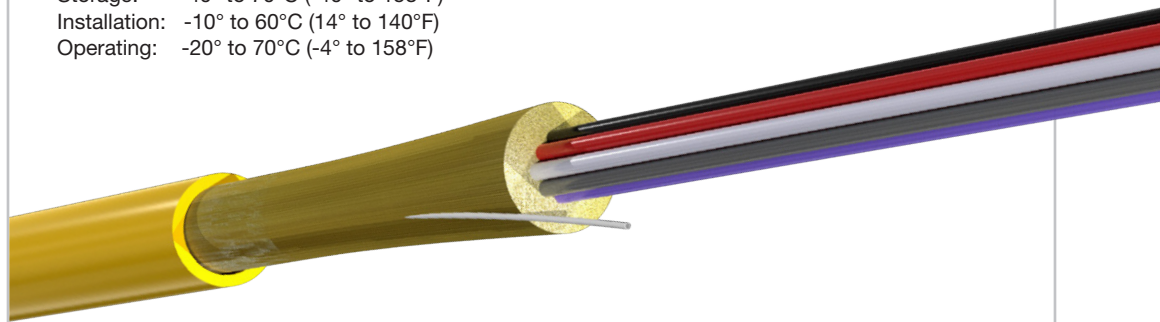



# Multimode and Singlemode Single-Unit

## SPECIFICATIONS BY FIBER COUNT

FIBERS	CABLE O.D.		RECOMMENDED MAXIMUM LOADS				CABLE WEIGHT	
			INSTALL		OPERATION			
	inches	mm	lbs-f	N	lbs-f	N	lbs/1000 ft	kg/1000 m
2	0.190	4.8	128	569	38	171	11.5	17.1
4	0.190	4.8	128	569	38	171	13.0	19.4
6	0.190	4.8	128	569	38	171	14.5	21.6
8	0.230	5.8	160	712	48	214	18.5	27.6
10	0.230	5.8	160	712	48	214	20.0	29.8
12	0.230	5.8	160	712	48	214	21.5	32.0
24	0.330	8.4	288	1282	86	385	50.3	74.9

## Mechanical Specifications

- Bend radius, no load = 10x cable overall diameter
- Bend radius, load = 15x cable overall diameter

plus  
**CORNING**<sup>®</sup>  
ClearCurve<sup>®</sup> Optical Fiber

FIBER



## Features

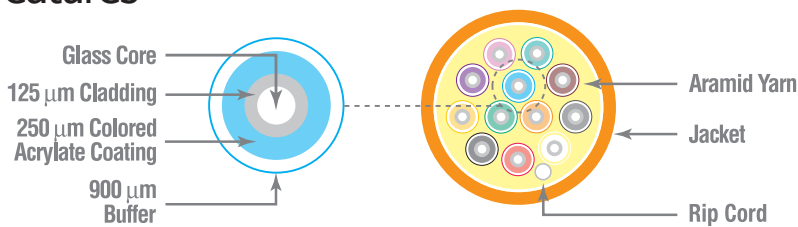

### DIELECTRIC MATERIALS

#### RISER

Overall Jacket: Flame-retardant Thermoplastic



2-fiber



4-fiber



6-fiber



8-fiber



10-fiber



12-fiber

Diagram scale approx. 2:1

Photo is for representation purposes only.

# Indoor Tight Buffered

12 through 72 fibers

FIBER

## Product Highlights

- REACH & RoHS 2 compliant
- Made in U.S.A.
- 900 micron buffered design recommended for easy termination
- All multimode, and singlemode cables (except OM1) utilize bend-insensitive optical fibers
- Each fiber is color coded for easy identification
- Ideal intra-building cable solution
- Flexible and easy to handle
- Compact distribution design
- Lightweight, flexible aramid yarns enhance strength

## Options

- Enhanced bend insensitive OS2 optical fiber is available (ITU-T G.657.B3 & G.657.A2)
- Standard jacket colors are:  
 Yellow: OS2  
 Orange: OM1 & OM2  
 Aqua: OM3 & OM4  
 Lime Green: OM5  
*Note: Erika Violet for OM4 is available.*
- OM4+ optical fibers with extended 10 gigabit Ethernet distances are available

## Applications

- Applications include 10, 40 & 100 gigabit Ethernet, Fibre Channel, Video, Security, Automation
- OM5 supports applications utilizing Short Wave Division Multiplexing (SWDM)

## Standards

- ANSI/TIA-568.3-D
- ISO/IEC 11801, 2nd edition
- Telcordia GR-409-CORE

## Multi-Unit (Plenum)

(UL) OFNP c(UL) OFNP FT6

### PART NUMBERS BY FIBER COUNT

FIBERS	FIBERS/TUBE	62.5 UM OM1	50 UM OM2	50 UM OM3	50 UM OM4	50 UM OM5	8.3 UM OS2
18	6	60258-18	60596-18	60598-18	61877-18	62745-18	60634-18
24	6	60258-24	60596-24	60598-24	61877-24	62745-24	60634-24
36	6	60258-36	60596-36	60598-36	61877-36	62745-36	60634-36
48	6	60258-48	60596-48	60598-48	61877-48	62745-48	60634-48
72	6	60258-72	60596-72	60598-72	61877-72	62745-72	60634-72
36	12	60027-36	60028-36	60614-36	61879-36	62746-36	60033-36
48	12	60027-48	60028-48	60614-48	61879-48	62746-48	60033-48
60	12	60027-60	60028-60	60614-60	61879-60	62746-60	60033-60
72	12	60027-72	60028-72	60614-72	61879-72	62746-72	60033-72

## Optical Specifications

TIA-568.3-D | ISO/IEC 11801, 2nd edition | Telcordia GR-409-CORE

Fiber type	Max. Attenuation (dB/km)		Min OFL Bandwidth (MHz-km)		Min EMBc Bandwidth (MHz-km)		Gb Ethernet distance (m)		10 Gb Ethernet distance(m)	
	850nm (MM)	1300nm (MM)	850nm (MM)	1300nm (MM)	850nm (MM)	1300nm (MM)	850nm (MM)	1300nm (MM)	850nm (MM)	1300nm (MM)
OM1	3.5	1.0	200	500	220	N/A	300	550	33	N/A
OM2	3.0	1.0	700	500	950	N/A	750	550	150	N/A
OM3	3.0	1.0	1500	500	2000	N/A	1000	550	300	N/A
OM4	3.0	1.0	3500	500	4700	N/A	1100	550	550	N/A
OM5*	3.0	1.0	3500	500	4700	N/A	1100	550	550	N/A
	1310nm (SM)	1550nm (SM)	1310nm (SM)	1550nm (SM)	1310nm (SM)	1550nm (SM)	1310nm (SM)	1550nm (SM)	1310nm (SM)	1550nm (SM)
OS2	0.5	0.5	N/A	N/A	N/A	N/A	> 25,000	> 40,000	10,000 - 25,000	40,000

\*OM5 optical fiber tested by glass manufacturer and exceeds the requirements of all applicable industry standards. Hitachi Cable America reserves the right to revise any specifications.

## Cable Temperature Ranges

Storage: -40° to 70°C (-40° to 158°F)  
 Installation: -10° to 60°C (14° to 140°F)  
 Operating: -20° to 70°C (-4° to 158°F)

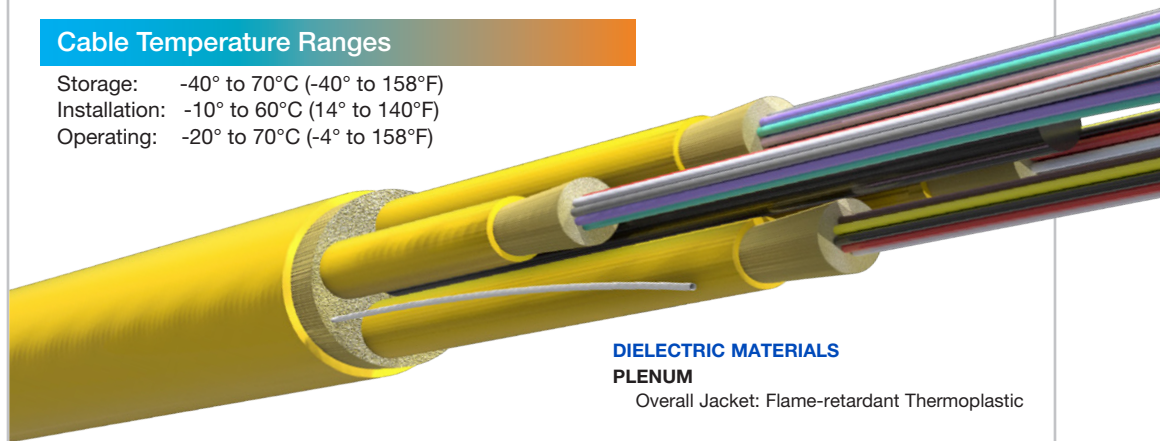

**DIELECTRIC MATERIALS**  
**PLENUM**

Overall Jacket: Flame-retardant Thermoplastic

# Multimode and Singlemode

# Multi-Unit

## SPECIFICATIONS BY FIBER COUNT

FIBERS	FIBERS/ TUBE	TUBE LAYOUT	RECOMMENDED MAXIMUM LOADS							
			CABLE O.D.		INSTALL		OPERATION		CABLE WEIGHT	
			inches	mm	lbs-f	N	lbs-f	N	lbs/1000 ft	kg/1000 m
18	6	3xCSM	.479	12.1	384	1709	115	513	77.0	114.7
24	6	4xCSM	.518	13.1	512	2279	154	684	97.0	144.5
36	6	6xCSM	.630	16.0	768	3418	230	1025	148.0	220.5
48	6	8xCSM	.792	20.1	1024	4557	307	1367	253.0	377.0
72	6	9x3xCSM	.903	22.9	1536	6837	461	2051	280.0	417.2
36	12	3xCSM	.559	14.1	480	2136	144	641	109.0	162.4
48	12	4xCSM	.614	15.5	640	2848	192	854	139.0	207.1
60	12	5xCSM	.681	17.2	800	3561	240	1068	175.0	260.8
72	12	6xCSM	.750	19.0	960	4272	288	1282	216.0	321.8

CSM = Central Strength Member

## Mechanical Specifications

- Bend radius, no load  
= 10x cable overall diameter
- Bend radius, load  
= 15x cable overall diameter

plus  
**CORNING®**  
ClearCurve® Optical Fiber

FIBER

## Features

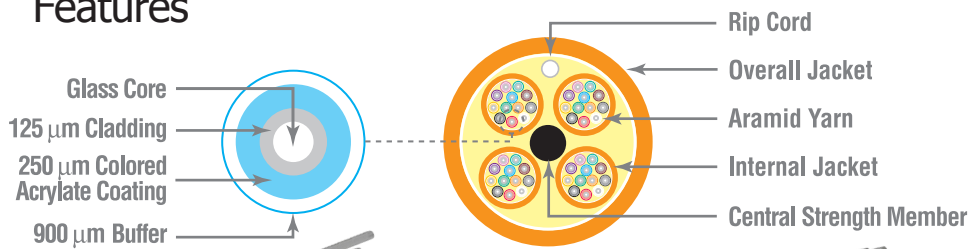

48-fibers  
(8 tubes of 6-fibers)

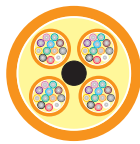

48-fibers  
(4 tubes of 12-fibers)  
Diagram scale approx. 1:1

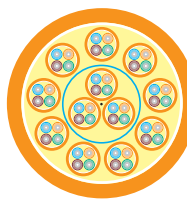

48-fibers  
(12 tubes of 4-fibers)

Photo is for representation purposes only.

# Indoor Tight Buffered

12 through 72 fibers

FIBER

## Product Highlights

- REACH & RoHS 2 compliant
- Made in U.S.A.
- 900 micron buffered design recommended for easy termination
- All multimode, and singlemode cables (except OM1) utilize bend-insensitive optical fibers
- Each fiber is color coded for easy identification
- Ideal intra-building cable solution
- Flexible and easy to handle
- Compact distribution design
- Lightweight, flexible aramid yarns enhance strength

## Options

- Enhanced bend insensitive OS2 optical fiber is available (ITU-T G.657.B3 & G.657.A2)
- Standard jacket colors are:  
 Yellow: OS2  
 Orange: OM1 & OM2  
 Aqua: OM3 & OM4  
 Lime Green: OM5  
*Note: Erika Violet for OM4 is available.*
- OM4+ optical fibers with extended 10 gigabit Ethernet distances are available

## Applications

- Applications include 10, 40 & 100 gigabit Ethernet, Fibre Channel, Video, Security, Automation
- OM5 supports applications utilizing Short Wave Division Multiplexing (SWDM)

## Standards

- ANSI/TIA-568.3-D
- ISO/IEC 11801, 2nd edition
- Telcordia GR-409-CORE

## Multi-Unit (Riser)

(UL) OFNR c(UL) OFNR FT4

### PART NUMBERS BY FIBER COUNT

FIBERS	FIBERS/TUBE	62.5 UM OM1	50 UM OM2	50 UM OM3	50 UM OM4	50 UM OM5	8.3 UM OS2
18	6	60567-18	60595-18	60581-18	61872-18	62743-18	60633-18
24	6	60567-24	60595-24	60581-24	61872-24	62743-24	60633-24
36	6	60567-36	60595-36	60581-36	61872-36	62743-36	60633-36
48	6	60567-48	60595-48	60581-48	61872-48	62743-48	60633-48
72	6	60567-72	60595-72	60581-72	61872-72	62743-72	60633-72
36	12	60006-36	60009-36	60613-36	61874-36	62744-36	60015-36
48	12	60006-48	60009-48	60613-48	61874-48	62744-48	60015-48
60	12	60006-60	60009-60	60613-60	61874-60	62744-60	60015-60
72	12	60006-72	60009-72	60613-72	61874-72	62744-72	60015-72

## Optical Specifications

TIA-568.3-D | ISO/IEC 11801, 2nd edition | Telcordia GR-409-CORE

Fiber type	Max. Attenuation (dB/km)		Min OFL Bandwidth (MHz-km)		Min EMBc Bandwidth (MHz-km)		Gb Ethernet distance (m)		10 Gb Ethernet distance(m)	
	850nm (MM)	1300nm (MM)	850nm (MM)	1300nm (MM)	850nm (MM)	1300nm (MM)	850nm (MM)	1300nm (MM)	850nm (MM)	1300nm (MM)
OM1	3.5	1.0	200	500	220	N/A	300	550	33	N/A
OM2	3.0	1.0	700	500	950	N/A	750	550	150	N/A
OM3	3.0	1.0	1500	500	2000	N/A	1000	550	300	N/A
OM4	3.0	1.0	3500	500	4700	N/A	1100	550	550	N/A
OM5*	3.0	1.0	3500	500	4700	N/A	1100	550	550	N/A
	1310nm (SM)	1550nm (SM)	1310nm (SM)	1550nm (SM)	1310nm (SM)	1550nm (SM)	1310nm (SM)	1550nm (SM)	1310nm (SM)	1550nm (SM)
OS2	0.5	0.5	N/A	N/A	N/A	N/A	> 25,000	> 40,000	10,000 - 25,000	40,000

\*OM5 optical fiber tested by glass manufacturer and exceeds the requirements of all applicable industry standards. Hitachi Cable America reserves the right to revise any specifications.

## Cable Temperature Ranges

Storage: -40° to 70°C (-40° to 158°F)  
 Installation: -10° to 60°C (14° to 140°F)  
 Operating: -20° to 70°C (-4° to 158°F)

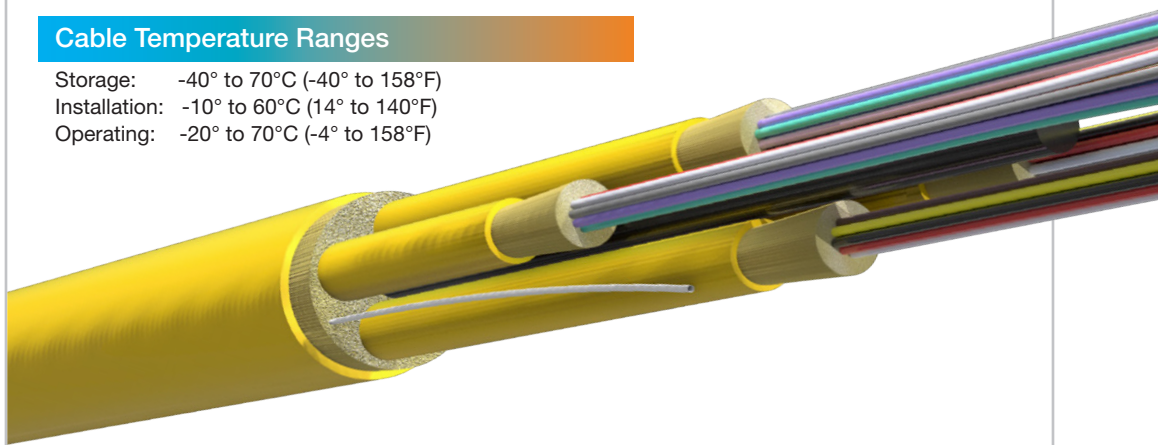

# Multimode and Singlemode Multi-Unit

## SPECIFICATIONS BY FIBER COUNT

FIBERS	FIBERS/ TUBE	TUBE LAYOUT	RECOMMENDED MAXIMUM LOADS							
			CABLE O.D.		INSTALL		OPERATION		CABLE WEIGHT	
			inches	mm	lbs-f	N	lbs-f	N	lbs/1000 ft	kg/1000 m
18	6	3xCSM	0.499	12.6	384	1709	115	513	75.0	111.8
24	6	4xCSM	0.538	13.6	512	2279	154	684	93.0	138.6
36	6	6xCSM	0.650	16.5	768	3418	230	1025	143.0	213.1
48	6	8xCSM	0.792	20.1	1024	4557	307	1367	222.0	330.8
72	6	9x3xCSM	0.903	22.9	1536	6837	461	2051	241.0	359.1
36	12	3xCSM	0.579	14.7	480	2136	144	641	106.0	157.9
48	12	4xCSM	0.634	16.1	640	2848	192	854	134.0	199.7
60	12	5xCSM	0.701	17.8	800	3561	240	1068	169.0	251.8
72	12	6xCSM	0.770	19.5	960	4272	288	1282	208.0	309.9

CSM = Central Strength Member

## Mechanical Specifications

- Bend radius, no load = 10x cable overall diameter
- Bend radius, load = 15x cable overall diameter



FIBER

## Features

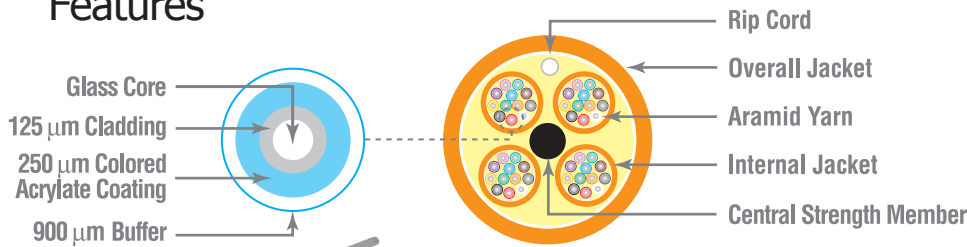

### DIELECTRIC MATERIALS RISER

Overall Jacket: Flame-retardant Thermoplastic



48-fibers  
(8 tubes of 6-fibers)



48-fibers  
(4 tubes of 12-fibers)

Diagram scale approx. 1:1

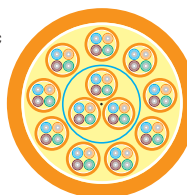

48-fibers  
(12 tubes of 4-fibers)



Photo is for representation purposes only.

# NanoCore<sup>®</sup> 2 Through 32 fibers

FIBER

## Product Highlights

- REACH & RoHS 2 compliant
- Made in U.S.A.
- All multimode, and singlemode cables (except OM1) utilize bend-insensitive optical fibers
- 250 micron loose tube design allows for higher fiber strand counts in a smaller overall diameter cable
- Ideal for MPO (MTP<sup>®</sup>) style connectors
- Each fiber is color coded for easy identification
- Flexible and easy to handle
- Lightweight, flexible Aramid yarns enhance strength
- Now available with a smaller outside diameter
- When necessary, color-coded binders separate fiber strands into bundles of 12

## Options

- Enhanced bend insensitive OS2 optical fiber is available (ITU-T G.657.B3 & G.657.A2)
- Standard jacket colors are:  
 Yellow: OS2  
 Orange: OM1 & OM2  
 Aqua: OM3 & OM4  
 Lime Green: OM5  
*Note: Erika Violet for OM4 is available.*
- 16 Fiber colors are available.
- Colored threads are used to bundle fibers
- OM4+ available

## Applications

- OM5 supports applications utilizing Short Wave Division Multiplexing (SWDM)

## Standards

- ANSI/TIA-568.3-D
- ISO/IEC 11801, 2nd edition
- Telcordia GR-409-CORE
- OS2 glass is compliant to ITU-T G.657.A1

## NanoCore<sup>®</sup> Interconnect (Single Jacket) Micro Distribution (Plenum)

(UL) OFNP c(UL) OFNP FT6

PART NUMBERS BY FIBER COUNT								
FIBERS	Cable O.D. mm	FIBERS/ BUNDLE or TUBE	62.5 UM OM1	50 UM OM2	50 UM OM3	50 UM OM4	50 UM OM5	8.3 UM OS2
2	2.0	-	62241-2	62242-2	62243-2	62244-2	62749-2	62239-2
2	3.0	-	61537-2	61506-2	61507-2	61883-2	62750-2	61538-2
4	2.0	-	62241-4	62242-4	62243-4	62244-4	62749-4	62239-4
4	3.0	-	61537-4	61506-4	61507-4	61883-4	62750-4	61538-4
6	2.0	-	62241-6	62242-6	62243-6	62244-6	62749-6	62239-6
6	3.0	-	61537-6	61506-6	61507-6	61883-6	62750-6	61538-6
8 DJ	4.8	-	62675-8	62676-8	62449-8	62450-8	62678-8	62460-8
12	2.0	-	62241-12	62242-12	62243-12	62244-12	62749-12	62239-12
12	3.0	-	61537-12	61506-12	61507-12	61883-12	62750-12	61538-12
12	3.8	-	62372-12	62373-12	62374-12	62375-12	62751-12	62371-12
12 DJ	4.8	-	62675-12	62676-12	62449-12	62450-12	62678-12	62460-12
16	3.0	-	62683-16	62684-16	62685-16	62686-16	62688-16	62689-16
16*	3.0	8 X 2	62692-16	62693-16	62694-16	62695-16	62697-16	62698-16
16 DJ	4.8	-	62675-16	62676-16	62449-16	62450-16	62678-16	62460-16
24*	3.0	12 X 2	62241-24	62242-24	62243-24	62244-24	62749-24	62239-24
24*	3.8	12 X 2	62372-24	62373-24	62374-24	62375-24	62751-24	62371-24
24*	4.5	12 X 2	61537-24	61506-24	61507-24	61883-24	62750-24	61538-24
24 DJ*	4.8	12 X 2	62675-24	62676-24	62449-24	62450-24	62678-24	62460-24
32*	3.6	8 X 4	62332-32	62333-32	62431-32	62335-32	62712-32	62336-32
32*	3.6	16 X 2	62489-32	62490-32	62491-32	62492-32	62715-32	62494-32
12	3.0 x 6.47	6	62753-12	61546-12	61539-12	61882-12	62752-12	61547-12
24	3.0 x 6.47	12	62753-24	61546-24	61539-24	61882-24	62752-24	61547-24

## Optical Specifications

TIA-568.3-D | ISO/IEC 11801, 2nd edition | Telcordia GR-409-CORE

Fiber type	Max. Attenuation (dB/km)		Min OFL Bandwidth (MHz-km)		Min EMBc Bandwidth (MHz-km)		Gb Ethernet distance (m)		10 Gb Ethernet distance (m)	
	850nm (MM)	1300nm (MM)	850nm (MM)	1300nm (MM)	850nm (MM)	1300nm (MM)	850nm (MM)	1300nm (MM)	850nm (MM)	1300nm (MM)
OM1	3.5	1.0	200	500	220	N/A	300	550	33	N/A
OM2	2.8	1.0	700	500	950	N/A	750	550	150	N/A
OM3	2.8	1.0	1500	500	2000	N/A	1000	550	300	N/A
OM4	2.8	1.0	3500	500	4700	N/A	1100	550	550	N/A
OM5*	2.8	1.0	3500	500	4700	N/A	1100	550	550	N/A
	1310nm (SM)	1550nm (SM)	1310nm (SM)	1550nm (SM)	1310nm (SM)	1550nm (SM)	1310nm (SM)	1550nm (SM)	1310nm (SM)	1550nm (SM)
OS2	0.5	0.5	N/A	N/A	N/A	N/A	> 25,000	> 40,000	10,000 - 25,000	40,000

\*OM5 optical fiber tested by glass manufacturer and exceeds the requirements of all applicable industry standards.

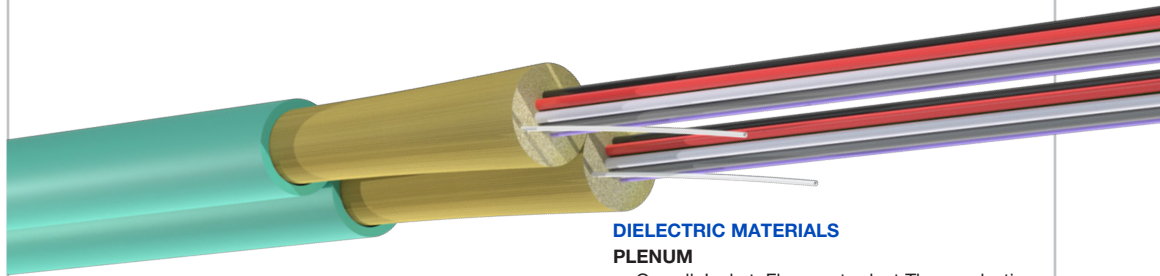

**DIELECTRIC MATERIALS  
PLENUM**

Overall Jacket: Flame-retardant Thermoplastic

Hitachi Cable America reserves the right to revise any specifications.

# Micro Distribution

## SPECIFICATIONS BY FIBER COUNT

FIBERS	FIBERS/ BUNDLE or TUBE	CABLE O.D.		RECOMMENDED MAXIMUM LOADS						CABLE WEIGHT	
		inches	mm	INSTALL		OPERATION		COMPRESSION	IMPACT	lbs/kft	Kg/Km
				lbs	N	lbs	N	N/cm	N-m		
2	-	0.078	2.0	50	222	15	67	35	0.74	2.5	3.7
2	-	0.118	3.0	100	445	30	134	100	0.74	5.5	8.2
4	-	0.078	2.0	50	222	15	67	35	0.74	2.6	3.8
4	-	0.118	3.0	100	445	30	134	100	0.74	5.6	8.3
6	-	0.078	2.0	50	222	15	67	35	0.74	2.7	4.0
6	-	0.118	3.0	100	445	30	134	100	0.74	5.6	8.3
8 DJ	-	0.189	4.8	150	668	45	200	35	2.94	14.3	21.3
12	-	0.078	2.0	50	222	15	67	35	0.74	2.9	4.4
12	-	0.118	3.0	100	445	30	134	100	0.74	5.9	8.8
12	-	0.150	3.8	150	668	45	200	35	2.94	9.1	13.6
12 DJ	-	0.189	4.8	150	668	45	200	35	2.94	14.5	21.6
16	-	0.118	3.0	150	668	45	200	100	0.74	5.2	7.7
16*	8 X 2	0.118	3.0	150	668	45	200	100	0.74	5.2	7.7
16 DJ	-	0.189	4.8	150	668	45	200	35	2.94	14.7	21.9
24*	12 X 2	0.118	3.0	150	668	45	200	100	0.74	5.7	8.5
24*	12 X 2	0.150	3.8	150	668	45	200	35	2.94	9.7	14.5
24*	12 X 2	0.177	4.5	150	668	45	200	100	2.94	13.1	19.5
24 DJ*	12 X 2	0.189	4.8	150	668	45	200	35	2.94	15	22.3
32*	8 X 4	0.142	3.6	150	668	45	200	100	2.94	7.3	10.9
32*	16 X 2	0.142	3.6	150	668	45	200	100	2.94	7.3	10.9
12	6	.118 x .255	3.0 x 6.47	128	569	38	171	100	2.94	11.3	16.8
24	12	.118 x .255	3.0 x 6.47	128	569	38	171	100	2.94	11.4	17.0

\*These cable designs utilize color-coded binders to separate subunits  
DJ = Dual jacket design

## Mechanical Specifications

- Bend radius, no load = 10x cable overall diameter
- Bend radius, load = 15x cable overall diameter



FIBER

## Features

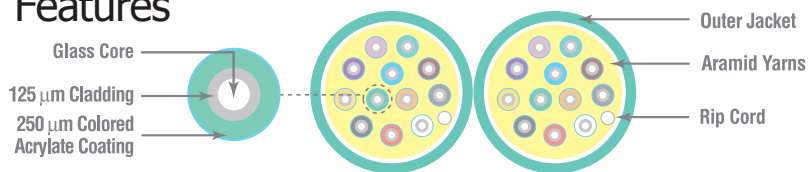

## Cable Temperature Ranges

Storage: -40° to 70°C (-40° to 158°F)  
Installation: 0° to 60°C (32° to 140°F)  
Operating: 0° to 70°C (32° to 158°F)

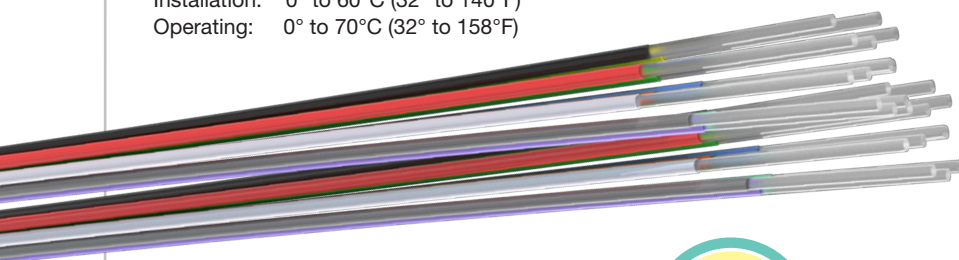

New 2mm cable has 33% smaller OD and 56% smaller area than 3mm cable.

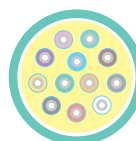
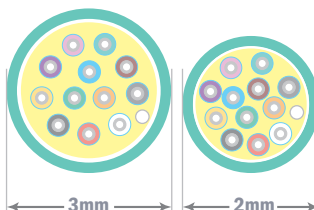

12 Fiber

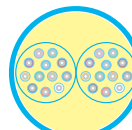

24 Fiber

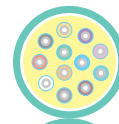

Zip Cord

Diagram scale approx. 5:1

Photo is for representation purposes only.

# NanoCore<sup>®</sup> 2 Through 24 fibers

FIBER

## Product Highlights

- REACH & RoHS 2 compliant
- Made in U.S.A.
- All multimode, and singlemode cables (except OM1) utilize bend-insensitive optical fibers
- 250 micron loose tube design allows for higher fiber strand counts in a smaller overall diameter cable
- LSZH with (OFNR) rating enables use in riser-rated environments. See note under part number table.
- Halogen free design offers improved safety performance
- Ideal for MPO (MTP<sup>®</sup>) style connectors
- Each fiber is color coded for easy identification
- Flexible and easy to handle.
- Lightweight, flexible Aramid yarns enhance strength
- When necessary, color-coded binders separate fiber strands into bundles of 12

## Options

- Enhanced bend insensitive OS2 optical fiber is available (ITU-T G.657.B3 & G.657.A2)
- Standard jacket colors are:
  - Yellow: OS2
  - Orange: OM1 & OM2
  - Aqua: OM3 & OM4
  - Lime Green: OM5

*Note: Erika Violet for OM4 is available.*
- 16 Fiber colors are available
- Colored threads are used to bundle fibers
- OM4+ available

## Applications

- Applications include 10, 40 & 100 gigabit Ethernet, Fibre Channel, Video, Security, Automation
- OM5 supports applications utilizing Short Wave Division Multiplexing (SWDM)

## Standards

- ANSI/TIA-568.3-D
- ISO/IEC 11801, 2nd edition
- Telcordia GR-409-CORE
- OS2 glass is compliant to ITU-T G.657.A1

## NanoCore<sup>®</sup> Interconnect (Single Jacket) Micro Distribution (LSZH/Riser) Low Smoke Zero Halogens & Riser Rated (UL) OFNR c(UL) OFNR FT4 (UL) LSZH

### PART NUMBERS BY FIBER COUNT

FIBERS	Cable O.D. mm	FIBERS/BUNDLE	62.5 UM OM1	50 UM OM2	50 UM OM3	50 UM OM4	50 UM OM5	8.3 UM OS2
2	2.0	-	62424-2	62425-2	62426-2	62427-2	62747-2	62429-2
2	3.0	-	62338-2	61631-2	61632-2	61941-2	62748-2	61772-2
4	2.0	-	62424-4	62425-4	62426-4	62427-4	62747-4	62429-4
4	3.0	-	62338-4	61631-4	61632-4	61941-4	62748-4	61772-4
6	2.0	-	62424-6	62425-6	62426-6	62427-6	62747-6	62429-6
6	3.0	-	62338-6	61631-6	61632-6	61941-6	62748-6	61772-6
12	2.0	-	62424-12	62425-12	62426-12	62427-12	62747-12	62429-12
12	3.0	-	62338-12	61631-12	61632-12	61941-12	62748-12	61772-12
16	3.0	-	62338-16	61631-16	61632-16	61941-16	62716-16	61772-16
16*	3.0	8 X 2	62701-16	62702-16	62703-16	62704-16	62706-16	62707-16
24*	3.0	12 X 2	62424-24	62425-24	62426-24	62427-24	62747-24	62429-24

## Optical Specifications TIA-568.3-D | ISO/IEC 11801, 2nd edition | Telcordia GR-409-CORE

Fiber type	Max. Attenuation (dB/km)		Min OFL Bandwidth (MHz-km)		Min EMBc Bandwidth (MHz-km)		Gb Ethernet distance (m)		10 Gb Ethernet distance (m)	
	850nm (MM)	1300nm (MM)	850nm (MM)	1300nm (MM)	850nm (MM)	1300nm (MM)	850nm (MM)	1300nm (MM)	850nm (MM)	1300nm (MM)
OM1	3.5	1.0	200	500	220	N/A	300	550	33	N/A
OM2	2.8	1.0	700	500	950	N/A	750	550	150	N/A
OM3	2.8	1.0	1500	500	2000	N/A	1000	550	300	N/A
OM4	2.8	1.0	3500	500	4700	N/A	1100	550	550	N/A
OM5*	2.8	1.0	3500	500	4700	N/A	1100	550	550	N/A
	1310nm (SM)	1550nm (SM)	1310nm (SM)	1550nm (SM)	1310nm (SM)	1550nm (SM)	1310nm (SM)	1550nm (SM)	1310nm (SM)	1550nm (SM)
OS2	0.5	0.5	N/A	N/A	N/A	N/A	> 25,000	> 40,000	10,000 - 25,000	40,000

\*OM5 optical fiber tested by glass manufacturer and exceeds the requirements of all applicable industry standards.

## Cable Temperature Ranges

Storage: -40° to 70°C (-40° to 158°F)  
 Installation: -10° to 60°C (32° to 140°F)  
 Operating: -20° to 70°C (32° to 158°F)

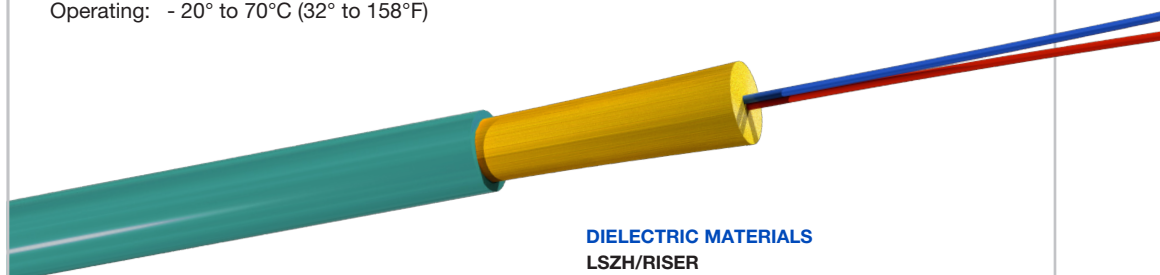

**DIELECTRIC MATERIALS**  
**LSZH/RISER**

Overall Jacket: Flame-retardant Thermoplastic

Hitachi Cable America reserves the right to revise any specifications.



# Micro Distribution

## SPECIFICATIONS BY FIBER COUNT

FIBERS	FIBERS/ BUNDLE	CABLE O.D.		RECOMMENDED MAXIMUM LOADS						CABLE WEIGHT	
				INSTALL		OPERATION		COMPRESSION	IMPACT		
		inches	mm	lbs	N	lbs	N	N/cm	N-m	lbs/kft	Kg/Km
2	-	0.078	2.0	50	222	15	67	35	0.74	2.5	3.7
2	-	0.118	3.0	100	445	30	134	100	2.94	4.8	7.2
4	-	0.078	2.0	50	222	15	67	35	0.74	2.6	3.8
4	-	0.118	3.0	100	445	30	134	100	2.94	4.9	7.4
6	-	0.078	2.0	50	222	15	67	35	0.74	2.7	4.0
6	-	0.118	3.0	100	445	30	134	100	2.94	5.0	7.5
12	-	0.078	2.0	50	222	15	67	35	0.74	3.0	4.4
12	-	0.118	3.0	100	445	30	134	100	2.94	5.3	7.9
16	-	0.118	3.0	150	668	45	200	100	2.94	5.2	7.7
16*	8 X 2	0.118	3.0	150	668	45	200	100	2.94	5.2	7.7
24*	12 X 2	0.118	3.0	150	668	45	200	100	0.74	5.9	8.8

\*These cable designs utilize color-coded binders to separate subunits

## Mechanical Specifications

- Bend radius, no load = 10x cable overall diameter
- Bend radius, load = 15x cable overall diameter



FIBER

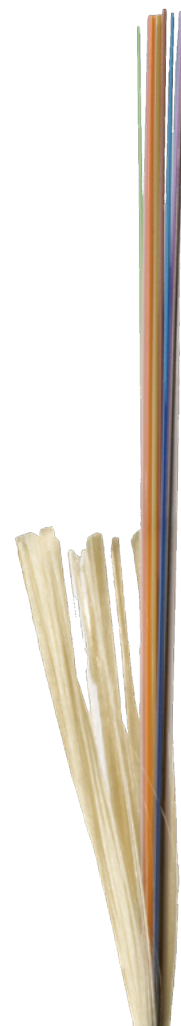

## Features

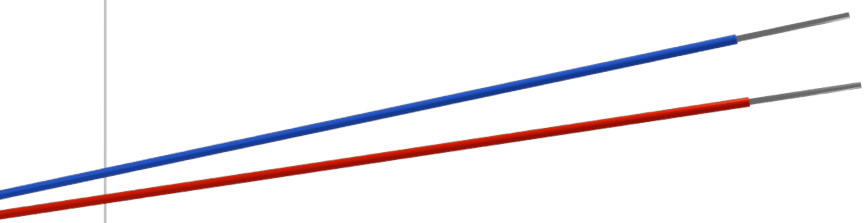
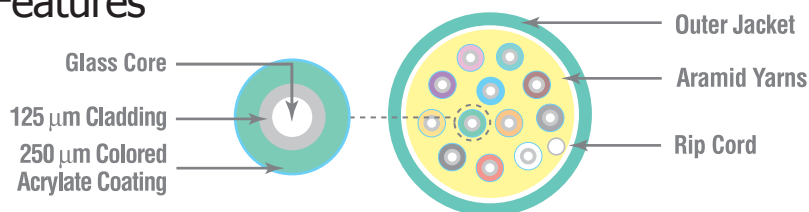

New 2mm cable has 33% smaller OD and 56% smaller area than 3mm cable.

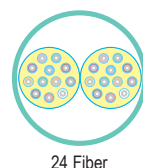
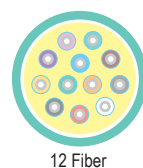
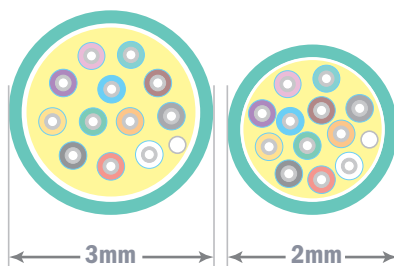

Diagram scale approx. 5:1

Photo is for representation purposes only.

# NanoCore<sup>®</sup> 24 through 288 fibers

FIBER

## Product Highlights

- REACH & RoHS 2 compliant
- Made in U.S.A.
- All multimode, and singlemode cables (except OM1) utilize bend-insensitive optical fibers
- Small, lightweight construction suitable for installations where space is at a premium
- Ideal for MPO (MTP<sup>®</sup>) style connectors
- Each fiber is color coded for easy identification
- Flexible and easy to handle

## Options

- 8 fibers per tube available upto 96 & 16 fibers per tube up to 144
- Standard jacket colors are:  
 Yellow: OS2  
 Orange: OM1 & OM2  
 Aqua: OM3 & OM4  
 Lime Green: OM5  
*Note: Erika Violet for OM4 is available.*
- 16 Fiber colors are available
- Enhanced bend insensitive OS2 optical fiber is available (ITU-TG.657. B3 & G.657.A2)
- OM4+ available

## Applications

- Ideal for high-density installations like data centers, central offices and overall premise applications where current or future data rates include 40 and 100 gigabits per second
- For additional applications, visit the HCA website
- OM5 supports applications utilizing Short Wave Division Multiplexing (SWDM)

## Standards

- ANSI/TIA-568.3-D
- ISO/IEC 11801, 2nd edition
- Telcordia GR-409-CORE
- OS2 glass is compliant to ITU-T G.657.A1

## NanoCore<sup>®</sup> Multi-Unit Micro Distribution (Plenum)

(UL) OFNP c(UL) OFNP FT6

### PART NUMBERS BY FIBER COUNT

FIBER COUNT	FIBERS PER TUBE	TUBE LAYOUT	TUBE O.D. mm	CABLE O.D. mm	62.5 UM OM1	50 UM OM2	50 UM OM3	50 UM OM4	50 UM OM5	8.3 UM OS2
24	12	2+2FxCSM	2.0	7.5	62220-24	62214-24	62216-24	62218-24	62668-24	62205-24
24	12	2+2FxCSM	3.0	9.1	62593-24	62594-24	62595-24	62596-24	62650-24	62598-24
36	12	3+1FxCSM	2.0	7.5	62220-36	62214-36	62216-36	62218-36	62668-36	62205-36
36	12	3+1FxCSM	3.0	9.1	62593-36	62594-36	62595-36	62596-36	62650-36	62598-36
48	12	4xCSTM	2.0	7.5	62220-48	62214-48	62216-48	62218-48	62668-48	62205-48
48	12	4xCSTM	3.0	9.1	62593-48	62594-48	62595-48	62596-48	62650-48	62598-48
72	12	6xCSTM	2.0	8.4	62220-72	62214-72	62216-72	62218-72	62668-72	62205-72
72	12	6xCSTM	3.0	10.4	62593-72	62594-72	62595-72	62596-72	62650-72	62598-72
96	12	8xCSTM	2.0	11.0	62220-96	62214-96	62216-96	62218-96	62668-96	62205-96
96	12	8xCSTM	3.0	12.2	62593-96	62594-96	62595-96	62596-96	62650-96	62598-96
144	12	9x3xCSTM	2.0	11.6	62220-144	62214-144	62216-144	62218-144	62668-144	62205-144
144	12	9x3xCSTM	3.0	14.4	62593-144	62594-144	62595-144	62596-144	62650-144	62598-144
192*	24	8+4FxCSM	3.0	15.8	62544-192	62545-192	62546-192	62547-192	62941-192	62549-198
288*	24	9x3xCSTM	3.0	15.8	62544-288	62545-288	62546-288	62547-288	62941-188	62549-288

## Optical Specifications

TIA-568.3-D | ISO/IEC 11801, 2nd edition | Telcordia GR-409-CORE

Fiber type	Max. Attenuation (dB/km)		Min OFL Bandwidth (MHz-km)		Min EMBC Bandwidth (MHz-km)		Gb Ethernet distance (m)		10 Gb Ethernet distance (m)	
	850nm (MM)	1300nm (MM)	850nm (MM)	1300nm (MM)	850nm (MM)	1300nm (MM)	850nm (MM)	1300nm (MM)	850nm (MM)	1300nm (MM)
OM1	3.5	1.0	200	500	220	N/A	300	550	33	N/A
OM2	2.8	1.0	700	500	950	N/A	750	550	150	N/A
OM3	2.8	1.0	1500	500	2000	N/A	1000	550	300	N/A
OM4	2.8	1.0	3500	500	4700	N/A	1100	550	550	N/A
OM5*	2.8	1.0	3500	500	4700	N/A	1100	550	550	N/A
OS2	0.5	0.5	N/A	N/A	N/A	N/A	> 25,000	> 40,000	10,000 - 25,000	40,000

\*OM5 optical fiber tested by glass manufacturer and exceeds the requirements of all applicable industry standards.

### Cable Temperature Ranges

Storage: -40° to 70°C (-40° to 158°F)  
 Installation: 0° to 60°C (32° to 140°F)  
 Operating: 0° to 70°C (32° to 158°F)

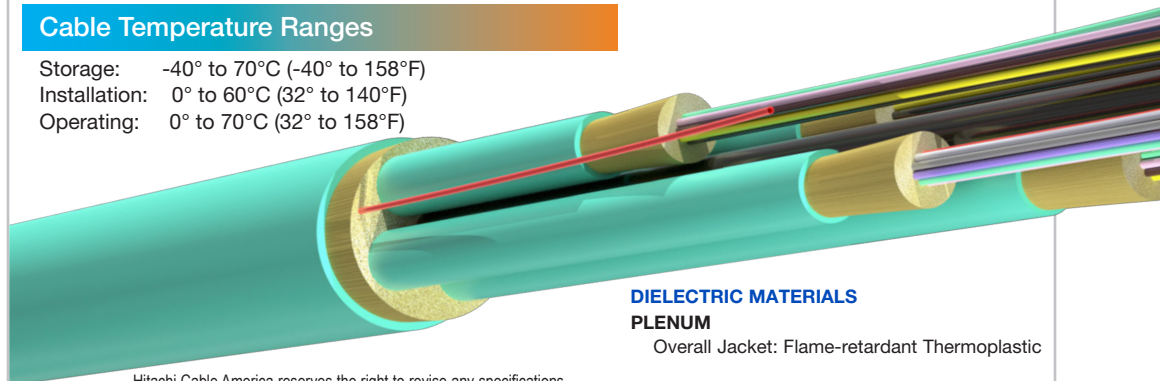

**DIELECTRIC MATERIALS  
 PLENUM**

Overall Jacket: Flame-retardant Thermoplastic

Hitachi Cable America reserves the right to revise any specifications.

# Micro Distribution

## SPECIFICATIONS BY FIBER COUNT

FIBER COUNT	FIBERS/TUBE	TUBE LAYOUT	TUBE O.D.		CABLE O.D.		RECOMMENDED MAXIMUM LOADS				CABLE WEIGHT	
			inches	mm	inches	mm	INSTALL		OPERATION		lbs/kft	kg/km
							lbs	N	lbs	N		
24	12	2+2FxCSM	0.079	2.0	0.296	7.5	150	668	45	200	36.4	54.2
24	12	2+2FxCSM	0.118	3.0	0.357	9.1	150	668	45	200	43.45	64.7
36	12	3+1FxCSM	0.079	2.0	0.296	7.5	150	668	45	200	37.4	55.7
36	12	3+1FxCSM	0.118	3.0	0.357	9.1	150	668	45	200	43.98	65.5
48	12	4xCSM	0.079	2.0	0.296	7.5	150	668	45	200	38.3	57.0
48	12	4xCSM	0.118	3.0	0.357	9.1	150	668	45	200	44.51	66.3
72	12	6xCSM	0.079	2.0	0.332	8.4	150	668	45	200	48.3	71.9
72	12	6xCSM	0.118	3.0	0.411	10.4	150	668	45	200	63.61	94.7
96	12	8xCSM	0.079	2.0	0.433	11.0	150	668	45	200	83.8	124.7
96	12	8xCSM	0.118	3.0	0.482	12.2	150	668	45	200	89.95	133.9
144	12	9x3xCSM	0.079	2.0	0.458	11.6	150	668	45	200	88.9	132.3
144	12	9x3xCSM	0.118	3.0	0.568	14.4	150	668	45	200	95.26	141.8
192*	24	8+4FxCSM	0.118	3.0	0.624	15.8	150	668	45	200	157.36	234.18
288*	24	9x3xCSM	0.118	3.0	0.624	15.8	150	668	45	200	157.36	234.18

\*These cable designs utilize color-coded binders to separate subunits  
 CSM = Central Strength Member  
 F = Filler

## Mechanical Specifications

- Bend radius, no load = 10x cable overall diameter
- Bend radius, load = 15x cable overall diameter



FIBER

## Features

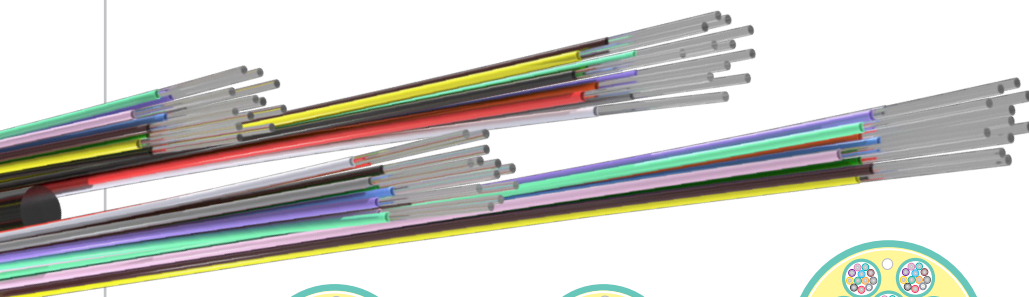
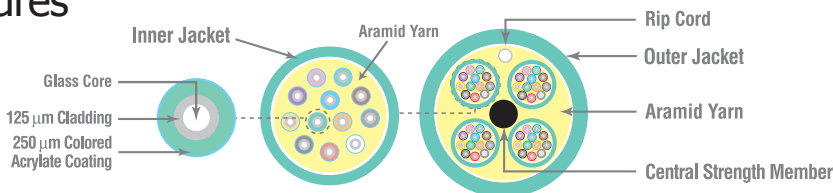

24 fibers

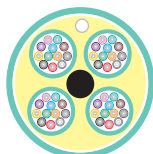

48 fibers

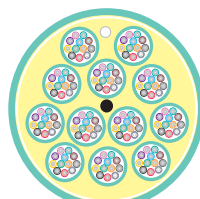

144 fibers

Photo is for representation purposes only.

# NanoCore<sup>®</sup> 24 through 144 fibers

FIBER

## Product Highlights

- REACH & RoHS 2 compliant
- Made in U.S.A.
- All multimode, and singlemode cables (except OM1) utilize bend-insensitive optical fibers
- Small, lightweight construction suitable for installations where space is at a premium
- Ideal for MPO (MTP<sup>®</sup>) style connectors
- Each fiber is color coded for easy identification
- Flexible and easy to handle.
- OFNR rating provided by UL
- Additional IEC test 60332-3-24 performed by HCA to ensure performance to industry standards

## Options

- 8 fibers per tube available upto 96 & 16 fibers per tube up to 144
- Standard jacket colors are:  
 Yellow: OS2  
 Orange: OM1 & OM2  
 Aqua: OM3 & OM4  
 Lime Green: OM5  
*Note: Erika Violet for OM4 is available.*
- 16 Fiber colors are available
- Enhanced bend insensitive OS2 optical fiber is available (ITU-TG.657.B3 & G.657.A2)
- OM4+ available

## Applications

- Ideal for high-density installations like data centers, central offices and overall premise applications where current or future data rates include 40 and 100 gigabits per second
- OM5 supports applications utilizing Short Wave Division Multiplexing (SWDM)

## Standards

- ANSI/TIA-568.3-D
- ISO/IEC 11801, 2nd edition
- Telcordia GR-409-CORE
- OS2 glass is compliant to ITU-T G.657.A1

## NanoCore<sup>®</sup> Multi-Unit Micro Distribution (LSZH/Riser)

Low Smoke Zero Halogens & Riser Rated (UL) OFNR c(UL) OFNR FT4 (UL) LSZH

### PART NUMBERS BY FIBER COUNT

FIBER COUNT	FIBERS PER TUBE	TUBE LAYOUT	TUBE O.D. mm	CABLE O.D. mm	62.5 UM OM1	50 UM OM2	50 UM OM3	50 UM OM4	50 UM OM5	8.3 UM OS2
24	12	2+2FxCSM	2.0	8.0	62337-24	62323-24	62295-24	62296-24	62754-24	62294-24
36	12	3+1FxCSM	2.0	8.0	62337-36	62323-36	62295-36	62296-36	62754-36	62294-36
48	12	4xCSM	2.0	8.0	62337-48	62323-48	62295-48	62296-48	62754-48	62294-48
72	12	6xCSM	2.0	8.8	62337-72	62323-72	62295-72	62296-72	62754-72	62294-72
96	12	8xCSM	2.0	9.9	62337-96	62323-96	62295-96	62296-96	62754-96	62294-96
144	12	9x3xCSM	2.0	11.2	62337-144	62323-144	62295-144	62296-144	62754-144	62294-144

## Optical Specifications

TIA-568.3-D | ISO/IEC 11801, 2nd edition | Telcordia GR-409-CORE

Fiber type	Max. Attenuation (dB/km)		Min OFL Bandwidth (MHz-km)		Min EMBC Bandwidth (MHz-km)		Gb Ethernet distance (m)		10 Gb Ethernet distance (m)	
	850nm (MM)	1300nm (MM)	850nm (MM)	1300nm (MM)	850nm (MM)	1300nm (MM)	850nm (MM)	1300nm (MM)	850nm (MM)	1300nm (MM)
OM1	3.5	1.0	200	500	220	N/A	300	550	33	N/A
OM2	2.8	1.0	700	500	950	N/A	750	550	150	N/A
OM3	2.8	1.0	1500	500	2000	N/A	1000	550	300	N/A
OM4	2.8	1.0	3500	500	4700	N/A	1100	550	550	N/A
OM5*	2.8	1.0	3500	500	4700	N/A	1100	550	550	N/A
	1310nm (SM)	1550nm (SM)	1310nm (SM)	1550nm (SM)	1310nm (SM)	1550nm (SM)	1310nm (SM)	1550nm (SM)	1310nm (SM)	1550nm (SM)
OS2	0.5	0.5	N/A	N/A	N/A	N/A	> 25,000	> 40,000	10,000 - 25,000	40,000

\*OM5 optical fiber tested by glass manufacturer and exceeds the requirements of all applicable industry standards.

### Cable Temperature Ranges

Storage: -40° to 70°C (-40° to 158°F)  
 Installation: -10° to 60°C (32° to 140°F)  
 Operating: -20° to 70°C (32° to 158°F)

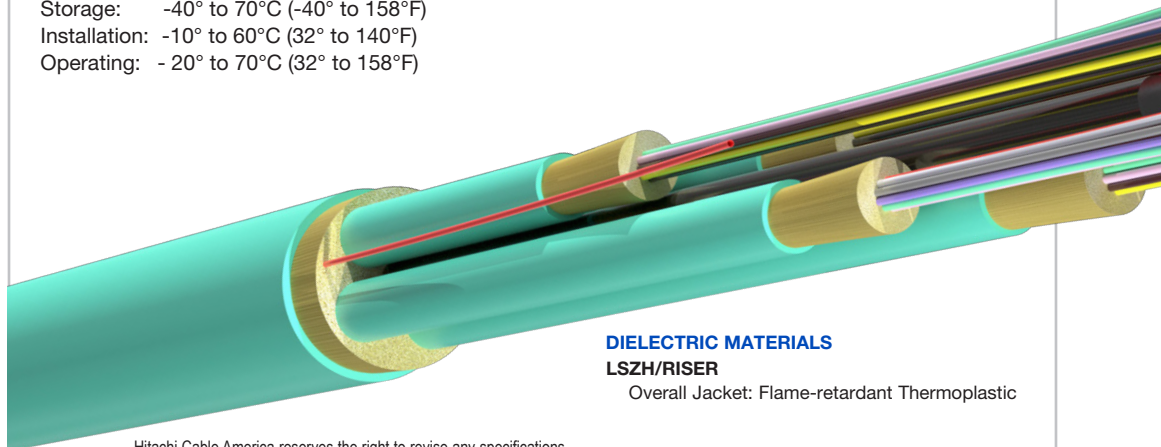

Hitachi Cable America reserves the right to revise any specifications.

# Micro Distribution

## SPECIFICATIONS BY FIBER COUNT

FIBER COUNT	FIBERS/TUBE	TUBE LAYOUT	TUBE O.D.		CABLE O.D.		RECOMMENDED MAXIMUM LOADS				CABLE WEIGHT	
			inches	mm	inches	mm	INSTALL		OPERATION		lbs/kft	kg/km
							lbs	N	lbs	N		
24	12	2+2FxCSM	0.079	2.0	0.315	8.0	300	1335	90	401	36.8	54.8
36	12	3+1FxCSM	0.079	2.0	0.315	8.0	300	1335	90	401	37.4	55.7
48	12	4xCSM	0.079	2.0	0.315	8.0	300	1335	90	401	38.0	56.6
72	12	6xCSM	0.079	2.0	0.346	8.8	300	1335	90	401	47.5	70.7
96	12	8xCSM	0.079	2.0	0.388	9.9	300	1335	90	401	65.1	96.9
144	12	9x3xCSM	0.079	2.0	0.440	11.2	300	1335	90	401	64.6	96.1

CSM = Central Strength Member  
F = Filler

## Mechanical Specifications

- Bend radius, no load  
= 10x cable overall diameter
- Bend radius, load  
= 15x cable overall diameter



FIBER

## Features

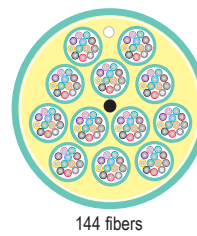
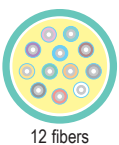
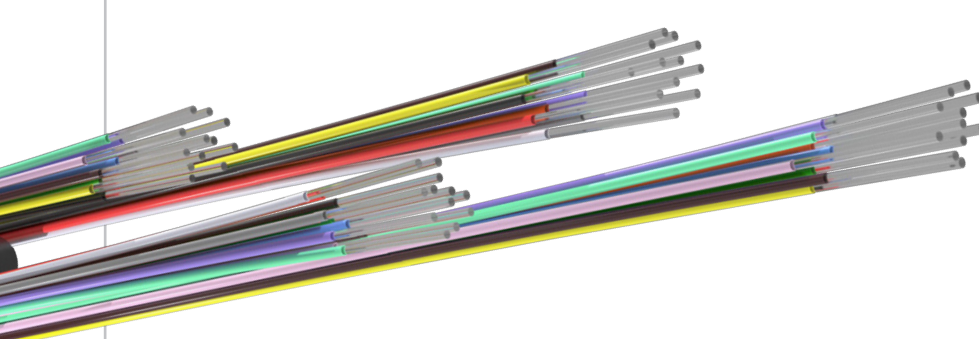
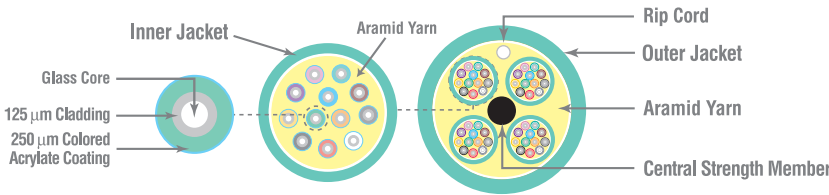

Photo is for representation purposes only.

# NanoCore® CPR Listed

2 through 144 fibers

FIBER

## Product Highlights

- REACH & RoHS 2 compliant
- Made in U.S.A.
- All multimode, and singlemode cables (except OM1) utilize bend-insensitive optical fibers
- Small, lightweight construction suitable for installations where space is at a premium
- Ideal for MPO (MTP®) style connectors
- Each fiber is color coded for easy identification
- Flexible and easy to handle

## Options

- 2.9 mm 2 fiber rounded tight buffered available
- Standard jacket colors are:
  - Yellow: OS2
  - Orange: OM1 & OM2
  - Aqua: OM3 & OM4
  - Lime Green: OM5

*Note: Erika Violet for OM4 is available.*
- 16 Fiber colors are available
- Enhanced bend insensitive OS2 optical fiber is available (ITU-TG.657. B3 & G.657.A2)
- OM4+ available

## Applications

- Ideal for high-density installations like data centers, central offices and overall premise applications where current or future data rates include 40 and 100 gigabits per second
- For additional applications, visit the HCA website
- OM5 supports applications utilizing Short Wave Division Multiplexing (SWDM)

## Standards

- EN 60332-1-2
- EN 50399
- EN 61034-2
- EN 6754-2

## Cable Temperature Ranges

Storage: -40° to 70°C  
(-40° to 158°F)

Installation: 0° to 50°C  
(32° to 122°F)

Operating: -10° to 60°C  
(14° to 140°F)

## NanoCore® Single Jacket Micro Distribution (CPR)

### PART NUMBERS BY FIBER COUNT

FIBER COUNT	CABLE O.D. mm	FIBERS/BUNDLE or TUBE	62.5 UM OM1	50 UM OM2	50 UM OM3	50 UM OM4	50 UM OM5	8.3 UM OS2	CPR
2	2.0	-	63122-2	63123-2	63124-2	63125-2	63127-2	63128-2	Dca-s1a,d0,a1
2	3.0	-	63131-2	63132-2	63133-2	63134-2	63136-2	63137-2	Dca-s1a,d0,a1
6	2.0	-	63122-6	63123-6	63124-6	63125-6	63127-6	63128-6	Dca-s1a,d0,a1
6	3.0	-	63131-6	63132-6	63133-6	63134-6	63136-6	63137-6	Dca-s1a,d0,a1
8	2.0	-	63122-8	63123-8	63124-8	63125-8	63127-8	63128-8	Dca-s1a,d0,a1
8	3.0	-	63131-8	63132-8	63133-8	63134-8	63136-8	63137-8	Dca-s1a,d0,a1
8	3.8	-	63141-8	63142-8	63143-8	63144-8	63146-8	63147-8	Cca-s2,d0, a1
12	2.0	-	63122-12	63123-12	63124-12	63125-12	63127-12	63128-12	Dca-s1a,d0,a1
12	3.0	-	63131-12	63132-12	63133-12	63134-12	63136-12	63137-12	Dca-s1a,d0,a1
12	3.8	-	63141-12	63142-12	63143-12	63144-12	63146-12	63147-12	Cca-s2,d0, a1
24	3.0	-	63131-24	63132-24	63133-24	63134-24	63136-24	63137-24	Dca-s1a,d0,a1
24	3.8	-	63141-24	63142-24	63143-24	63144-24	63146-24	63147-24	Cca-s2,d0, a1
32	3.8	-	63141-32	63142-32	63143-32	63144-32	63146-32	63147-32	Cca-s2,d0, a1

## NanoCore® Dual Jacket Micro Distribution (CPR)

### PART NUMBERS BY FIBER COUNT

FIBER COUNT	FIBERS PER TUBE	TUBE O.D. mm	CABLE O.D. mm	62.5 UM OM1	50 UM OM2	50 UM OM3	50 UM OM4	50 UM OM5	8.3 UM OS2	CPR
2	2	3.0	4.8	63151-2	63152-2	63153-2	63154-2	63156-2	63157-2	Cca-s1a,d0, a1
4	4	3.0	4.8	63151-4	63152-4	63153-4	63154-4	63156-4	63157-4	Cca-s1a,d0, a1
6	6	3.0	4.8	63151-6	63152-6	63153-6	63154-6	63156-6	63157-6	Cca-s1a,d0, a1
8	8	3.0	4.8	63151-8	63152-8	63153-8	63154-8	63156-8	63157-8	Cca-s1a,d0, a1
12	12	3.0	4.8	63151-12	63152-12	63153-12	63154-12	63156-12	63157-12	Cca-s1a,d0, a1
24	24	3.0	4.8	63151-24	63152-24	63153-24	63154-24	63156-24	63157-24	Cca-s1a,d0, a1

## NanoCore® Multi-Unit Micro Distribution (CPR)

### PART NUMBERS BY FIBER COUNT

FIBER COUNT	FIBERS PER TUBE	TUBE LAYOUT	TUBE O.D. mm	CABLE O.D. mm	62.5 UM OM1	50 UM OM2	50 UM OM3	50 UM OM4	50 UM OM5	8.3 UM OS2	CPR
24	12	2+2FxCSM	2.0	8.0	63161-24	63162-24	63163-24	63164-24	63166-24	63167-24	B2ca-s1a,d0, a1
36	12	3+1FxCSM	2.0	8.0	63161-36	63162-36	63163-36	63164-36	63166-36	63167-36	B2ca-s1a,d0, a1
48	12	4xCSM	2.0	8.0	63161-48	63162-48	63163-48	63164-48	63166-48	63167-48	B2ca-s1a,d0, a1
72	12	6xCSM	2.0	8.8	63161-72	63162-72	63163-72	63164-72	63166-72	63167-72	B2ca-s1a,d0, a1
96	12	8xCSM	2.0	9.9	63161-96	63162-96	63163-96	63164-96	63166-96	63167-96	B2ca-s1a,d0, a1
144	12	9x3xCSM	2.0	11.2	63161-144	63162-144	63163-144	63164-144	63166-144	63167-144	B2ca-s1a,d0,a1

### DIELECTRIC MATERIALS

#### CPR

Overall Jacket: Flame-retardant Thermoplastic

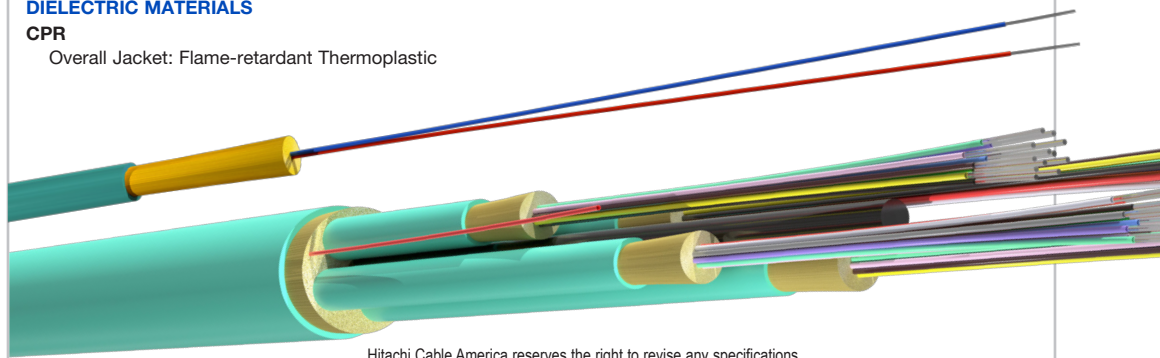

Hitachi Cable America reserves the right to revise any specifications.

# Micro Distribution

## SPECIFICATIONS BY FIBER COUNT

FIBER COUNT	FIBERS/TUBE	TUBE LAYOUT	TUBE O.D.		CABLE O.D.		RECOMMENDED MAXIMUM LOADS					
			inches	mm	inches	mm	INSTALL		OPERATION		CABLE WEIGHT	
							lbs	N	lbs	N	lbs/kft	kg/km
2	-	-	-	-	0.0787	2.0	51	225	16	70	2.5	3.7
2	-	-	-	-	0.118	3.0	51	225	16	70	4.7	7.0
6	-	-	-	-	0.0787	2.0	51	225	16	70	2.5	3.7
6	-	-	-	-	0.118	3.0	51	225	16	70	4.7	7.0
8	-	-	-	-	0.0787	2.0	51	225	16	70	2.5	3.7
8	-	-	-	-	0.118	3.0	51	225	16	70	4.7	7.0
8	-	-	-	-	0.150	3.8	51	225	16	70	10	14
12	-	-	-	-	0.0787	2.0	51	225	16	70	2.5	3.7
12	-	-	-	-	0.118	3.0	51	225	16	70	4.7	7.0
12	-	-	-	-	0.150	3.8	51	225	16	70	10	14
24	-	-	-	-	0.118	3.0	51	225	16	70	4.7	7.0
24	-	-	-	-	0.150	3.8	51	225	16	70	10	14
32	-	-	-	-	0.150	3.8	51	225	16	70	10	14
2	2	-	0.118	3.0	0.189	4.8	90	400	27	120	15	22
4	4	-	0.118	3.0	0.189	4.8	90	400	27	120	15	22
6	6	-	0.118	3.0	0.189	4.8	90	400	27	120	15	22
8	8	-	0.118	3.0	0.189	4.8	90	400	27	120	15	22
12	12	-	0.118	3.0	0.189	4.8	90	400	27	120	15	22
24	24	12X2	0.118	3.0	0.189	4.8	90	400	27	120	15	22
24	12	2+2FxCSM	0.079	2.0	0.315	8.0	90	400	27	120	39	58
36	12	3+1FxCSM	0.079	2.0	0.315	8.0	90	400	27	120	39	58
48	12	4xCSM	0.079	2.0	0.315	8.0	90	400	27	120	39	58
72	12	6xCSM	0.079	2.0	0.346	8.8	90	400	27	120	50	74
96	12	8xCSM	0.079	2.0	0.388	9.9	90	400	27	120	66	98
144	12	9x3xCSM	0.079	2.0	0.440	11.2	90	400	27	120	71	106

CSM = Central Strength Member  
F = Filler

## Mechanical Specifications

- Bend radius, no load = 10x cable overall diameter
- Bend radius, load = 15x cable overall diameter



FIBER

## Features

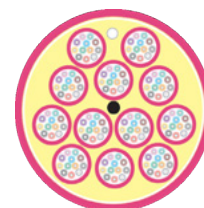

144 fibers



48 fibers



24 fibers

## Optical Specifications ISO/IEC 11801, 2nd edition

Fiber type	Max. Attenuation (dB/km)		Min OFL Bandwidth (MHz-km)		Min EMBc Bandwidth (MHz-km)		Gb Ethernet distance (m)		10 Gb Ethernet distance (m)	
	850nm (MM)	1300nm (MM)	850nm (MM)	1300nm (MM)	850nm (MM)	1300nm (MM)	850nm (MM)	1300nm (MM)	850nm (MM)	1300nm (MM)
OM1	3.5	1.0	200	500	220	N/A	300	550	33	N/A
OM2	2.8	1.0	700	500	950	N/A	750	550	150	N/A
OM3	2.8	1.0	1500	500	2000	N/A	1000	550	300	N/A
OM4	2.8	1.0	3500	500	4700	N/A	1100	550	550	N/A
OM5*	2.8	1.0	3500	500	4700	N/A	1100	550	550	N/A
	1310nm (SM)	1550nm (SM)	1310nm (SM)	1550nm (SM)	1310nm (SM)	1550nm (SM)	1310nm (SM)	1550nm (SM)	1310nm (SM)	1550nm (SM)
OS2	0.5	0.5	N/A	N/A	N/A	N/A	> 25,000	> 40,000	10,000 - 25,000	40,000

\*OM5 optical fiber tested by glass manufacturer and exceeds the requirements of all applicable industry standards.

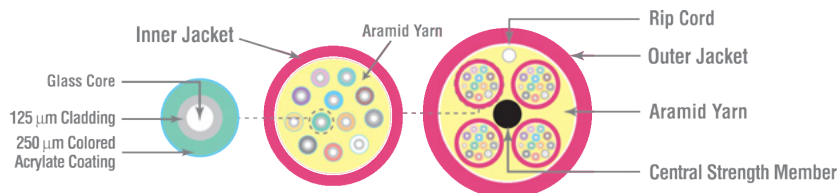
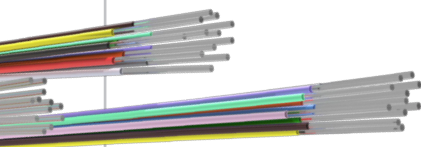

# NanoCore<sup>®</sup> Armored

12 through 144 fibers

FIBER

## Product Highlights

- REACH & RoHS 2 compliant
- Made in U.S.A.
- All multimode, and singlemode cables (except OM1) utilize bend-insensitive optical fibers
- Eliminates need for inner duct or conduit
- Ideal for MPO (MTP<sup>®</sup>) style connectors
- Aluminum interlock armor
- Each fiber is color coded for easy identification
- Flexible and easy to handle

## Options

- Riser/LSZH cables available
- 8 fibers per tube available
- Standard jacket colors are:  
 Yellow: OS2  
 Orange: OM1 & OM2  
 Aqua: OM3 & OM4  
 Lime Green: OM5  
*Note: Erika Violet for OM4 is available.*
- OM4+ optical fibers with extended 10 gigabit Ethernet distances are available
- Enhanced bend insensitive OS2 optical fiber is available (ITU-TG.657. B3)

## Applications

- Ideal for high-density installations like data centers, central offices and overall premise applications where current or future data rates include 40 and 100 gigabits per second
- For additional applications, visit the HCA website
- OM5 supports applications utilizing Short Wave Division Multiplexing (SWDM)

## Standards

- ANSI/TIA-568.3-D
- ISO/IEC 11801, 2nd edition
- Telcordia GR-409-CORE
- OS2 glass is compliant to ITU-T G.657.A1

## Armored NanoCore<sup>®</sup> Micro Distribution (Plenum)

(UL) OFCP c(UL) OFCP FT6

PART NUMBERS BY FIBER COUNT										
FIBER COUNT	FIBERS PER TUBE	TUBE LAYOUT	TUBE O.D. mm	CABLE O.D. mm	62.5 UM OM1	50 UM OM2	50 UM OM3	50 UM OM4	50 UM OM5	8.3 UM OS2
12	12	2+2FxCSM	2.0	14.8	62285-12	62286-12	62251-12	62257-12	62756-12	62255-12
24	12	2+2FxCSM	2.0	14.8	62285-24	62286-24	62251-24	62257-24	62756-24	62255-24
36	12	3+1FxCSM	2.0	14.8	62285-36	62286-36	62251-36	62257-36	62756-36	62255-36
48	12	4xCSM	2.0	14.8	62285-48	62286-48	62251-48	62257-48	62756-48	62255-48
72	12	6xCSM	2.0	16.4	62285-72	62286-72	62251-72	62257-72	62756-72	62255-72
96	12	8xCSM	2.0	17.1	62285-96	62286-96	62251-96	62257-96	62756-96	62255-96
144	12	9x3xCSM	2.0	18.4	62285-144	62286-144	62251-144	62257-144	62756-144	62255-144

## Optical Specifications

TIA-568.3-D | ISO/IEC 11801, 2nd edition | Telcordia GR-409-CORE

Fiber type	Max. Attenuation (dB/km)		Min OFL Bandwidth (MHz-km)		Min EMBC Bandwidth (MHz-km)		Gb Ethernet distance (m)		10 Gb Ethernet distance (m)	
	850nm (MM)	1300nm (MM)	850nm (MM)	1300nm (MM)	850nm (MM)	1300nm (MM)	850nm (MM)	1300nm (MM)	850nm (MM)	1300nm (MM)
OM1	3.5	1.0	200	500	220	N/A	300	550	33	N/A
OM2	2.8	1.0	700	500	950	N/A	750	550	150	N/A
OM3	2.8	1.0	1500	500	2000	N/A	1000	550	300	N/A
OM4	2.8	1.0	3500	500	4700	N/A	1100	550	550	N/A
OM5*	2.8	1.0	3500	500	4700	N/A	1100	550	550	N/A
OS2	0.5	0.5	N/A	N/A	N/A	N/A	> 25,000	> 40,000	10,000 - 25,000	40,000

\*OM5 optical fiber tested by glass manufacturer and exceeds the requirements of all applicable industry standards.

## Cable Temperature Ranges

Storage: -40° to 70°C (-40° to 158°F)  
 Installation: 0° to 60°C (32° to 140°F)  
 Operating: 0° to 70°C (32° to 158°F)

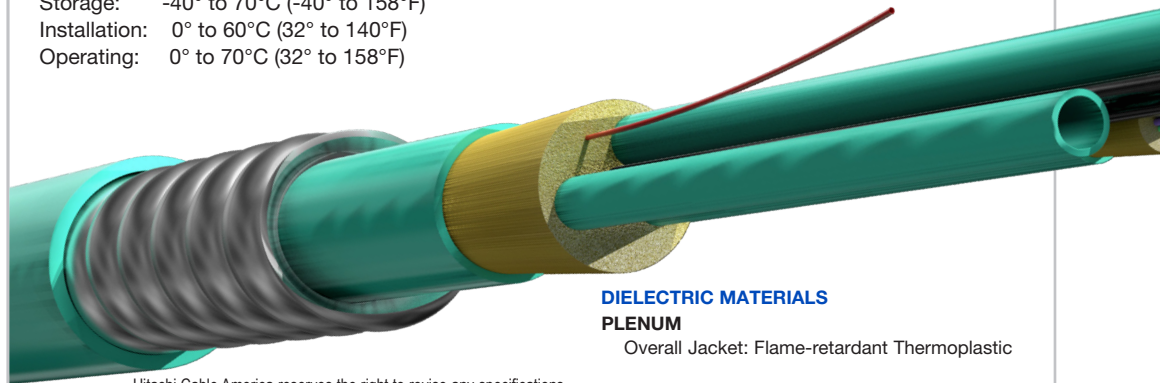

Hitachi Cable America reserves the right to revise any specifications.



# Micro Distribution

## SPECIFICATIONS BY FIBER COUNT

FIBER COUNT	FIBERS/TUBE	TUBE LAYOUT	TUBE O.D.		CABLE O.D.		RECOMMENDED MAXIMUM LOADS				CABLE WEIGHT	
			inches	mm	inches	mm	INSTALL		OPERATION		lbs/kft	Kg/Km
							lbs	N	lbs	N		
12	12	2+2FxCSM	0.079	2.0	0.583	14.8	150	668	45	200	131.0	195.0
24	12	2+2FxCSM	0.079	2.0	0.583	14.8	150	668	45	200	132.0	197.5
36	12	3+1FxCSM	0.079	2.0	0.583	14.8	150	668	45	200	132.0	196.4
48	12	4xCSM	0.079	2.0	0.583	14.8	150	668	45	200	133.0	197.9
72	12	6xCSM	0.079	2.0	0.647	16.4	150	668	45	200	154.0	229.2
96	12	8xCSM	0.079	2.0	0.675	17.1	150	668	45	200	183.0	272.3
144	12	9x3xCSM	0.079	2.0	0.723	18.4	150	668	45	200	194.0	288.7

CSM = Central Strength Member  
F = Filler

## Mechanical Specifications

- Bend radius, no load = 10x cable overall diameter
- Bend radius, load = 15x cable overall diameter



FIBER



## Features

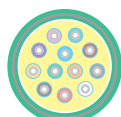
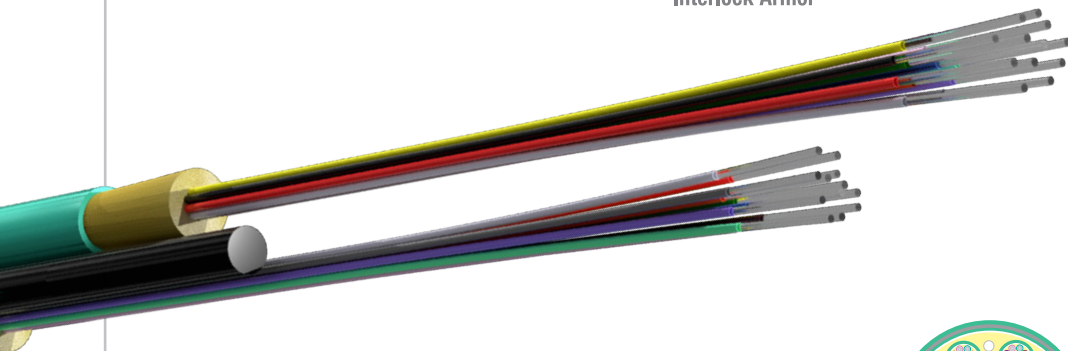
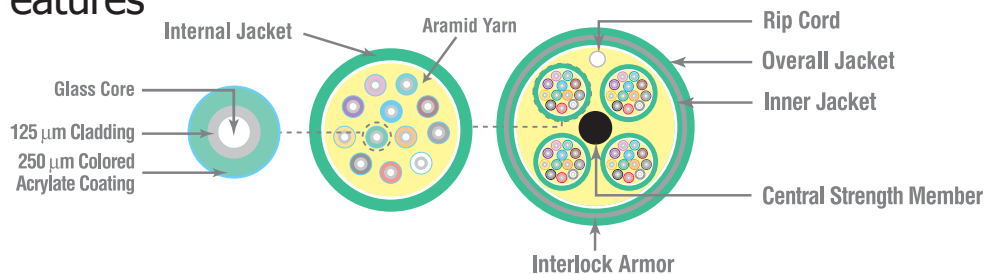

12 fibers

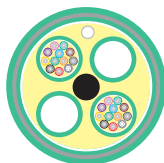

24 fibers

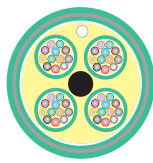

48 fibers

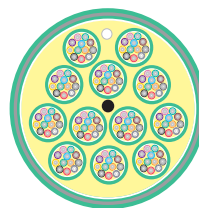

144 fibers

Photo is for representation purposes only.

# NanoCore<sup>®</sup> Armored

24 through 144 fibers

FIBER

## Product Highlights

- REACH & RoHS 2 compliant
- Made in U.S.A.
- All multimode, and singlemode cables (except OM1) utilize bend-insensitive optical fibers
- Eliminates need for inner duct or conduit
- Ideal for MPO (MTP<sup>®</sup>) style connectors
- Aluminum interlock armor
- Each fiber is color coded for easy identification
- Flexible and easy to handle
- Low Smoke Zero Halogen and Riser rating delivers improved environmental characteristics

## Options

- 8 fibers per tube available for cables up to 96 strands
- 16 fibers per tube and 24 fibers per tube up to 144 fiber
- OS2 optical fibers with enhanced bend-insensitive performance are available.
- Standard jacket colors are:  
 Yellow: OS2  
 Orange: OM1 & OM2  
 Aqua: OM3 & OM4  
*Note: Erika Violet for OM4 is available.*
- OM4+ optical fibers with extended 10 gigabit Ethernet distances are available
- Enhanced bend insensitive OS2 optical fiber is available (ITU-TG.657. B3)

## Applications

- Ideal for high-density installations like data centers, central offices and overall premise applications where current or future data rates include 40 and 100 gigabits per second
- OM5 supports applications utilizing Short Wave Division Multiplexing (SWDM)

## Standards

- ANSI/TIA-568.3-D
- ISO/IEC 11801, 2nd edition
- Telcordia GR-409-CORE
- OS2 glass is compliant to ITU-T G.657.A1

## Armored NanoCore<sup>®</sup> Multi-Unit Micro Distribution (LSZH/Riser) Low Smoke Zero Halogen (UL) OFNR c(UL) OFNR FT4

### PART NUMBERS BY FIBER COUNT

FIBER COUNT	FIBERS PER TUBE	TUBE LAYOUT	TUBE O.D. mm	CABLE O.D. mm	62.5 UM OM1	50 UM OM2	50 UM OM3	50 UM OM4	50 UM OM5	8.3 UM OS2
12	12	1T+3FxCSM	2.0	16.1	62353-12	62354-12	62355-12	62356-12	62821-12	62352-12
24	12	2T+2FxCSM	2.0	16.1	62353-24	62354-24	62355-24	62356-24	62821-24	62352-24
36	12	3T+1FxCSM	2.0	16.1	62353-36	62354-36	62355-36	62356-36	62821-36	62352-36
48	12	4xCSM	2.0	16.1	62353-48	62354-48	62355-48	62356-48	62821-48	62352-48
72	12	6xCSM	2.0	17.1	62353-72	62354-72	62355-72	62356-72	62821-72	62352-72
96	12	8xCSM	2.0	18.2	62353-96	62354-96	62355-96	62356-96	62821-96	62352-96
144	12	9x3xCSM	2.0	19.8	62353-144	62354-144	62355-144	62356-144	62821-144	62352-144

## Optical Specifications TIA-568.3-D | ISO/IEC 11801, 2nd edition | Telcordia GR-409-CORE

Fiber type	Max. Attenuation (dB/km)		Min OFL Bandwidth (MHz-km)		Min EMBc Bandwidth (MHz-km)		Gb Ethernet distance (m)		10 Gb Ethernet distance (m)	
	850nm (MM)	1300nm (MM)	850nm (MM)	1300nm (MM)	850nm (MM)	1300nm (MM)	850nm (MM)	1300nm (MM)	850nm (MM)	1300nm (MM)
OM1	3.5	1.0	200	500	220	N/A	300	550	33	N/A
OM2	2.8	1.0	700	500	950	N/A	750	550	150	N/A
OM3	2.8	1.0	1500	500	2000	N/A	1000	550	300	N/A
OM4	2.8	1.0	3500	500	4700	N/A	1100	550	550	N/A
OM5*	2.8	1.0	3500	500	4700	N/A	1100	550	550	N/A
	1310nm (SM)	1550nm (SM)	1310nm (SM)	1550nm (SM)	1310nm (SM)	1550nm (SM)	1310nm (SM)	1550nm (SM)	1310nm (SM)	1550nm (SM)
OS2	0.5	0.5	N/A	N/A	N/A	N/A	> 25,000	> 40,000	10,000 - 25,000	40,000

\*OM5 optical fiber tested by glass manufacturer and exceeds the requirements of all applicable industry standards.

### Cable Temperature Ranges

Storage: -40° to 70°C (-40° to 158°F)  
 Installation: 0° to 60°C (32° to 140°F)  
 Operating: 0° to 70°C (32° to 158°F)

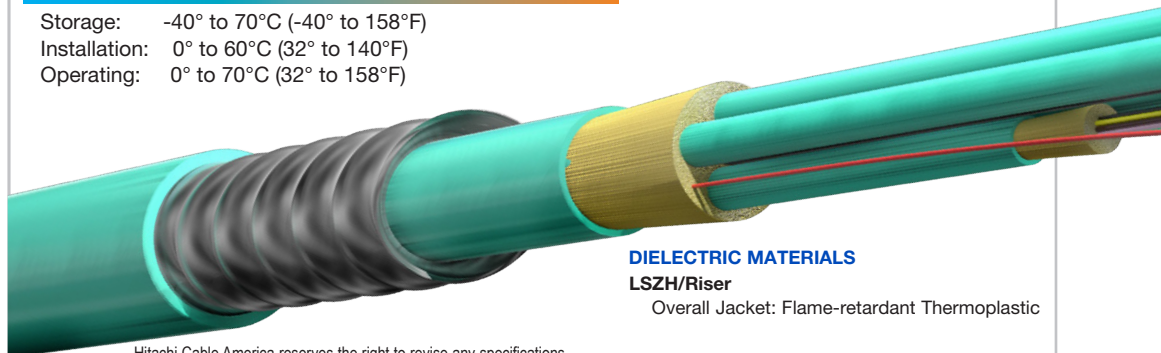

**DIELECTRIC MATERIALS**  
**LSZH/Riser**

Overall Jacket: Flame-retardant Thermoplastic

Hitachi Cable America reserves the right to revise any specifications.

# Micro Distribution

## SPECIFICATIONS BY FIBER COUNT

FIBER COUNT	FIBERS/TUBE	TUBE LAYOUT	TUBE O.D.		CABLE O.D.		RECOMMENDED MAXIMUM LOADS					
			inches	mm	inches	mm	INSTALL		OPERATION		CABLE WEIGHT	
							lbs	N	lbs	N	lbs/kft	kg/km
12	12	1T+3FxCSM	0.079	2.0	0.635	16.1	300	1335	90	401	142.5	212.1
24	12	2T+2FxCSM	0.079	2.0	0.635	16.1	300	1335	90	401	142.5	212.1
36	12	3T+1FxCSM	0.079	2.0	0.635	16.1	300	1335	90	401	143.1	213.0
48	12	4xCSTM	0.079	2.0	0.635	16.1	300	1335	90	401	143.7	213.9
72	12	6xCSTM	0.079	2.0	0.675	17.1	300	1335	90	401	161.3	240.2
96	12	8xCSTM	0.079	2.0	0.715	18.2	300	1335	90	401	187.1	278.5
144	12	9x3xCSTM	0.079	2.0	0.780	19.8	300	1335	90	401	199.9	297.6

CSM = Central Strength Member  
F = Filler

## Mechanical Specifications

- Bend radius, no load = 10x cable overall diameter
- Bend radius, load = 15x cable overall diameter



FIBER

## Features

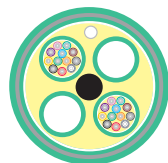
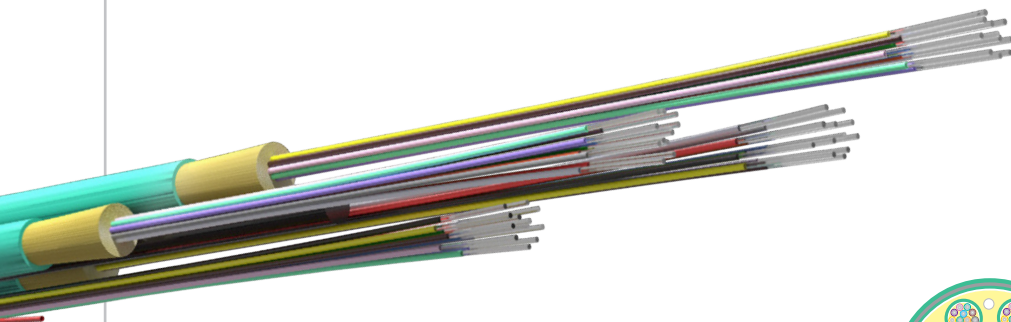
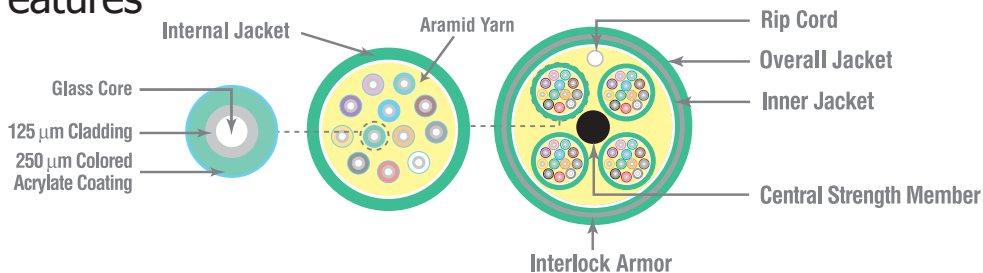

24 fibers

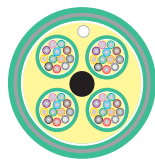

48 fibers

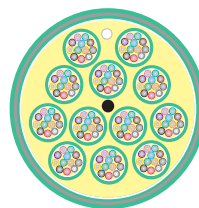

144 fibers



Photo is for representation purposes only.

# Indoor Tight Buffered

FIBER

## Product Highlights

- REACH & RoHS 2 compliant
- Made in U.S.A.
- All multimode, and singlemode cables (except OM1) utilize bend-insensitive optical fibers
- 900 um buffered design recommended for easy termination
- Eliminates need for inner duct or conduit
- Aluminum interlock armor.
- Each fiber is color coded for easy identification
- Ideal intra-building cable solution.
- Flexible and easy to handle
- Lightweight, flexible aramid yarns enhance strength

## Options

- Enhanced bend insensitive OS2 optical fiber is available (ITU-T G.657.B3 & G.657.A2)
- Standard jacket colors are:
  - Yellow: OS2
  - Orange: OM1 & OM2
  - Aqua: OM3 & OM4
  - Lime Green: OM5

*Note: Erika Violet for OM4 is available.*
- OM4+ optical fibers with extended 10 gigabit Ethernet distances are available

## Applications

- Applications include 10, 40 & 100 gigabit Ethernet, Fibre Channel, Video, Security, Automation
- OM5 supports applications utilizing Short Wave Division Multiplexing (SWDM)

## Standards

- ANSI/TIA-568.3-D
- ISO/IEC 11801, 2nd edition
- Telcordia GR-409-CORE

## Armored Tight Buffered (Plenum)

(UL) OFCP c(UL) OFCP FT6

### PART NUMBERS BY FIBER COUNT

FIBERS	62.5 UM OM1	50 UM OM2	50 UM OM3	50 UM OM4	50 UM OM5	8.3 UM OS2
2	60405-2	61319-2	61337-2	61897-2	62813-2	61433-2
4	60405-4	61319-4	61337-4	61897-4	62813-4	61433-4
6	60405-6	61319-6	61337-6	61897-6	62813-6	61433-6
8	60405-8	61319-8	61337-8	61897-8	62813-8	61433-8
10	60405-10	61319-10	61337-10	61897-10	62813-10	61433-10
12	60405-12	61319-12	61337-12	61897-12	62813-12	61433-12
24	60405-24	61319-24	61337-24	61897-24	62813-24	61433-24
48	62183-48	62184-48	62185-48	62186-48	62814-48	62187-48
72	62183-72	62184-72	62185-72	62186-72	62814-72	62187-72

## Optical Specifications

TIA-568.3-D | ISO/IEC 11801, 2nd edition | Telcordia GR-409-CORE

Fiber type	Max. Attenuation (dB/km)		Min OFL Bandwidth (MHz-km)		Min EMBC Bandwidth (MHz-km)		Gb Ethernet distance (m)		10 Gb Ethernet distance(m)	
	850nm (MM)	1300nm (MM)	850nm (MM)	1300nm (MM)	850nm (MM)	1300nm (MM)	850nm (MM)	1300nm (MM)	850nm (MM)	1300nm (MM)
OM1	3.5	1.0	200	500	220	N/A	300	550	33	N/A
OM2	3.0	1.0	700	500	950	N/A	750	550	150	N/A
OM3	3.0	1.0	1500	500	2000	N/A	1000	550	300	N/A
OM4	3.0	1.0	3500	500	4700	N/A	1100	550	550	N/A
OM5*	3.0	1.0	3500	500	4700	N/A	1100	550	550	N/A
	1310nm (SM)	1550nm (SM)	1310nm (SM)	1550nm (SM)	1310nm (SM)	1550nm (SM)	1310nm (SM)	1550nm (SM)	1310nm (SM)	1550nm (SM)
OS2	0.5	0.5	N/A	N/A	N/A	N/A	> 25,000	> 40,000	10,000 - 25,000	40,000

\*OM5 optical fiber tested by glass manufacturer and exceeds the requirements of all applicable industry standards. Hitachi Cable America reserves the right to revise any specifications.

### Cable Temperature Ranges

Storage: -40° to 70°C (-40° to 158°F)  
 Installation: 0° to 60°C (32° to 140°F)  
 Operating: 0° to 70°C (32° to 158°F)

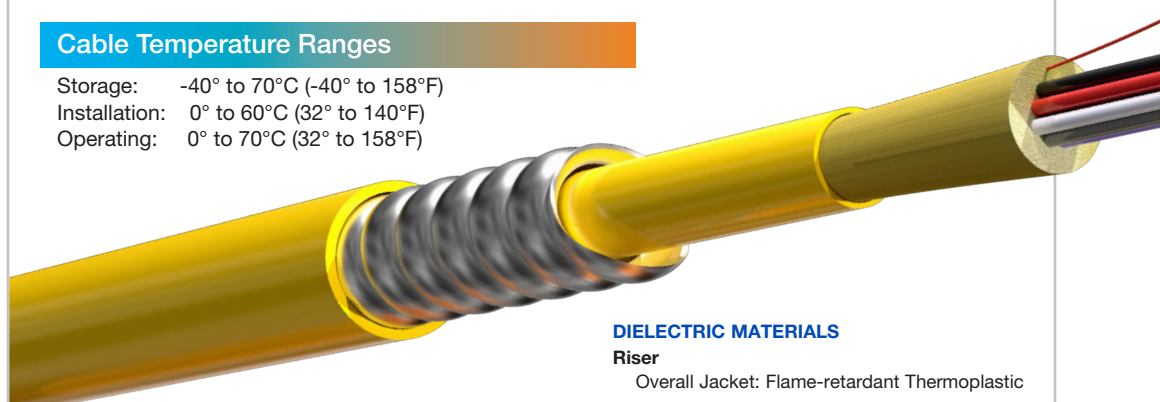

### DIELECTRIC MATERIALS

#### Riser

Overall Jacket: Flame-retardant Thermoplastic

# Multimode and Singlemode Armored

## SPECIFICATIONS BY FIBER COUNT

FIBERS	CABLE	O.D.	RECOMMENDED MAXIMUM LOADS				CABLE WEIGHT	
			INSTALLATION		OPERATION			
			inches	mm	lbs-f	N	lbs-f	N
2	0.520	13.21	128	570	38	171	93.5	139.1
4	0.520	13.21	128	570	38	171	94.8	141.1
6	0.520	13.21	128	570	38	171	96.2	143.1
8	0.520	13.21	160	712	48	214	100.5	149.6
10	0.520	13.21	160	712	48	214	101.9	151.6
12	0.520	13.21	160	712	48	214	103.3	153.7
24	0.643	16.33	288	1282	86	385	158.1	235.3
48	0.964	24.49	640	2849	192	855	305.7	454.9
72	1.099	27.91	960	4273	288	1282	453.8	675.3

## Mechanical Specifications

- Bend radius, no load = 10x cable overall diameter
- Bend radius, load = 15x cable overall diameter

plus  
**CORNING®**  
ClearCurve® Optical Fiber

FIBER

## Features

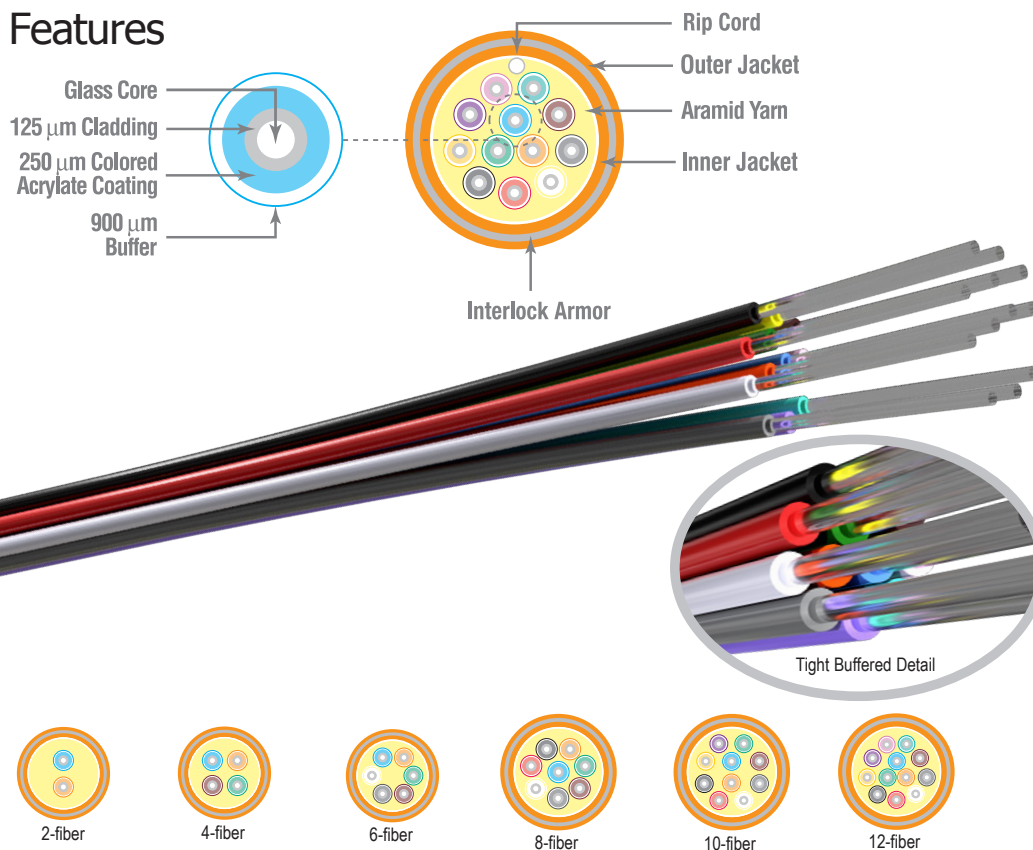

Diagram scale approx. 2:1



Photo is for representation purposes only.

# Indoor Tight Buffered

2 through 72 fibers

FIBER

## Product Highlights

- REACH & RoHS 2 compliant
- Made in U.S.A.
- All multimode, and singlemode cables (except OM1) utilize bend-insensitive optical fibers
- 900 um buffered design recommended for easy termination
- Eliminates need for inner duct or conduit
- Aluminum interlock armor
- Each fiber is color coded for easy identification
- Ideal intra-building cable solution
- Flexible and easy to handle
- Lightweight, flexible aramid yarns enhance strength

## Options

- Enhanced bend insensitive OS2 optical fiber is available (ITU-T G.657.B3 & G.657.A2)
- Standard jacket colors are:  
 Yellow: OS2  
 Orange: OM1 & OM2  
 Aqua: OM3 & OM4  
 Lime Green: OM5  
*Note: Erika Violet for OM4 is available.*
- OM4+ optical fibers with extended 10 gigabit Ethernet distances are available

## Applications

- Applications include 10, 40 & 100 gigabit Ethernet, Fibre Channel, Video, Security, Automation
- OM5 supports applications utilizing Short Wave Division Multiplexing (SWDM)

## Standards

- ANSI/TIA-568.3-D
- ISO/IEC 11801, 2nd edition
- Telcordia GR-409-CORE

## Armored Tight Buffered (Riser)

(UL) OFNR c(UL) OFNR FT4

### PART NUMBERS BY FIBER COUNT

FIBERS	62.5 UM OM1	50 UM OM2	50 UM OM3	50 UM OM4	50 UM OM5	8.3 UM OS2
2	61486-2	61542-2	61421-2	61896-2	62811-2	61540-2
4	61486-4	61542-4	61421-4	61896-4	62811-4	61540-4
6	61486-6	61542-6	61421-6	61896-6	62811-6	61540-6
8	61486-8	61542-8	61421-8	61896-8	62811-8	61540-8
10	61486-10	61542-10	61421-10	61896-10	62811-10	61540-10
12	61486-12	61542-12	61421-12	61896-12	62811-12	61540-12
24	61486-24	61542-24	61421-24	61896-24	62811-24	61540-24
48	62016-48	62017-48	62018-48	62019-48	62812-48	61541-48
72	62016-72	62017-72	62018-72	62019-72	62812-72	61541-72

## Optical Specifications

TIA-568.3-D | ISO/IEC 11801, 2nd edition | Telcordia GR-409-CORE

Fiber type	Max. Attenuation (dB/km)		Min OFL Bandwidth (MHz-km)		Min EMBC Bandwidth (MHz-km)		Gb Ethernet distance (m)		10 Gb Ethernet distance(m)	
	850nm (MM)	1300nm (MM)	850nm (MM)	1300nm (MM)	850nm (MM)	1300nm (MM)	850nm (MM)	1300nm (MM)	850nm (MM)	1300nm (MM)
OM1	3.5	1.0	200	500	220	N/A	300	550	33	N/A
OM2	3.0	1.0	700	500	950	N/A	750	550	150	N/A
OM3	3.0	1.0	1500	500	2000	N/A	1000	550	300	N/A
OM4	3.0	1.0	3500	500	4700	N/A	1100	550	550	N/A
OM5*	3.0	1.0	3500	500	4700	N/A	1100	550	550	N/A
	1310nm (SM)	1550nm (SM)	1310nm (SM)	1550nm (SM)	1310nm (SM)	1550nm (SM)	1310nm (SM)	1550nm (SM)	1310nm (SM)	1550nm (SM)
OS2	0.5	0.5	N/A	N/A	N/A	N/A	> 25,000	> 40,000	10,000 - 25,000	40,000

\*OM5 optical fiber tested by glass manufacturer and exceeds the requirements of all applicable industry standards. Hitachi Cable America reserves the right to revise any specifications.

## Cable Temperature Ranges

Storage: -40° to 70°C (-40° to 158°F)  
 Installation: -10° to 60°C (14° to 140°F)  
 Operating: -20° to 70°C (-4° to 158°F)

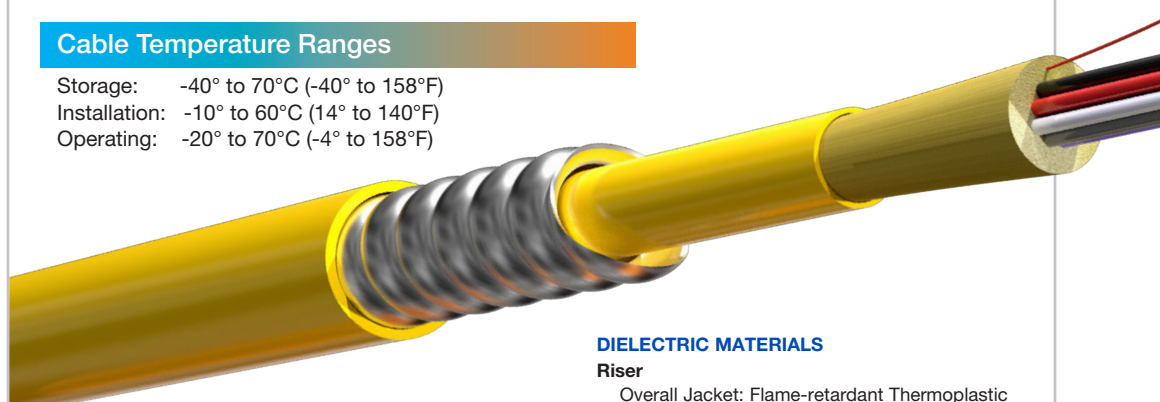

### DIELECTRIC MATERIALS

Riser

Overall Jacket: Flame-retardant Thermoplastic

# Multimode and Singlemode Armored

## SPECIFICATIONS BY FIBER COUNT

FIBERS	CABLE O.D.		RECOMMENDED MAXIMUM LOADS				CABLE WEIGHT	
			INSTALL		OPERATION			
	inches	mm	lbs-f	N	lbs-f	N	lbs/1000 ft	kg/1000 m
2	0.520	13.21	128	570	38	171	93.4	139.2
4	0.520	13.21	128	570	38	171	94.9	141.4
6	0.520	13.21	128	570	38	171	96.4	143.6
8	0.520	13.21	160	712	48	214	109.9	163.8
10	0.520	13.21	160	712	48	214	111.4	166.0
12	0.520	13.21	160	712	48	214	112.9	168.2
24	0.643	16.33	288	1282	86	385	164.1	244.5
48	0.960	24.38	640	2849	192	855	283.7	422.2
72	1.095	27.81	960	4273	288	1282	422.7	629.1

## Mechanical Specifications

- Bend radius, no load = 10x cable overall diameter
- Bend radius, load = 15x cable overall diameter

plus  
**CORNING®**  
ClearCurve® Optical Fiber

FIBER

## Features

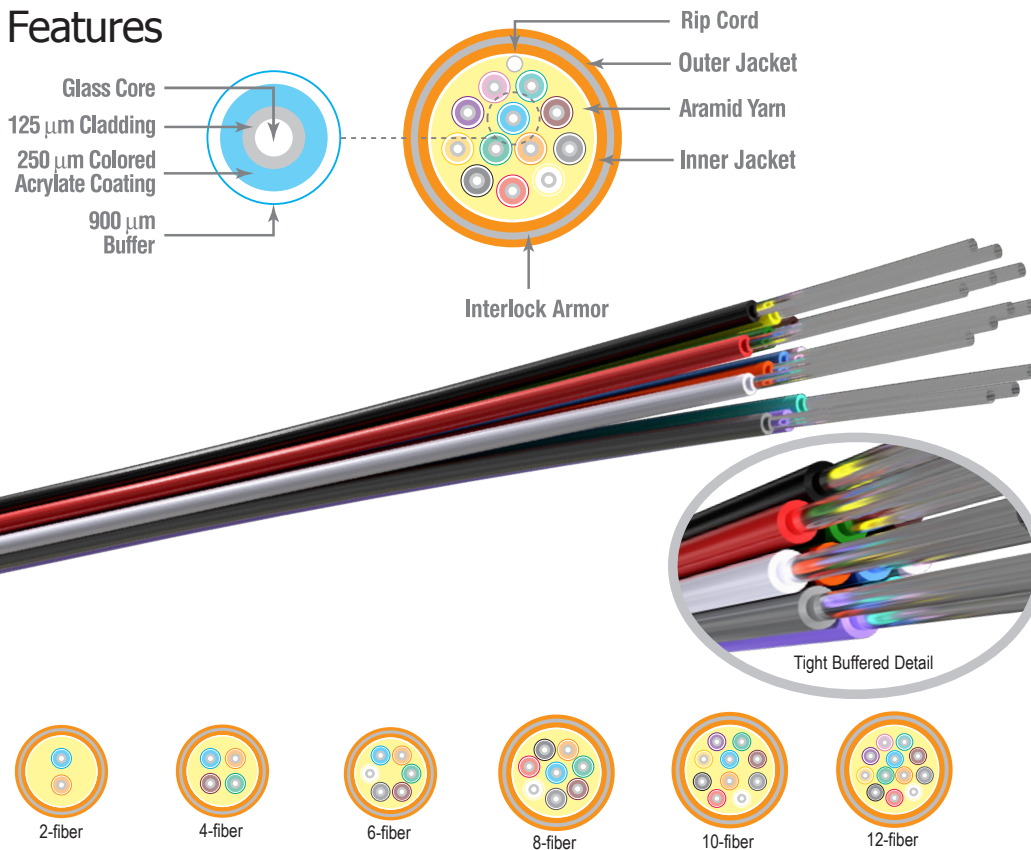

Photo is for representation purposes only.

# Indoor / Outdoor

2 through 72 fibers

FIBER

## Product Highlights

- REACH & RoHS 2 compliant
- Made in U.S.A.
- All multimode, and singlemode cables (except OM1) utilize bend-insensitive optical fibers
- UV and fungus resistant jacket
- Tight buffered construction
- Easy to strip and terminate
- Each fiber is color coded for easy identification
- Dry, super absorbent polymers (SAPs) eliminate water migration in cable interstices
- Suitable for lashed aerial, duct, underground conduit and indoor plenum applications
- 900um buffered design recommended for easy termination
- Cables with more than 24 fibers have fibers segregated into 12-fiber sub-units

## Options

- Enhanced bend insensitive OS2 optical fiber is available (ITU-T G.657.B3 & G.657.A2)
- OM4+ optical fibers with extended 10 gigabit Ethernet distances are available

## Applications

- Applications include 10, 40 & 100 gigabit Ethernet, Fibre Channel, Video, Security, Automation
- OM5 supports applications utilizing Short Wave Division Multiplexing (SWDM)

## Standards

- ANSI/TIA-568.3-D
- ISO/IEC 11801, 2nd edition
- Telcordia GR-409-CORE

## Indoor/Outdoor Tight Buffered (Plenum)

(UL) OFNP c(UL) OFNP FT6

### PART NUMBERS BY FIBER COUNT

FIBERS	FIBERS/TUBE	62.5 UM OM1	50 UM OM2	50 UM OM3	50 UM OM4	50 UM OM5	8.3 UM OS2
2	2	61460-2	61464-2	61468-2	61894-2	62769-2	61459-2
4	4	61460-4	61464-4	61468-4	61894-4	62769-4	61459-4
6	6	61460-6	61464-6	61468-6	61894-6	62769-6	61459-6
8	8	61460-8	61464-8	61468-8	61894-8	62769-8	61459-8
10	10	61460-10	61464-10	61468-10	61894-10	62769-10	61459-10
12	12	61460-12	61464-12	61468-12	61894-12	62769-12	61459-12
24	24	61460-24	61464-24	61468-24	61894-24	62769-24	61459-24
36	6	62178-36	62179-36	62180-36	62181-36	62770-36	62066-36
48	12	61979-48	61956-48	61959-48	61980-48	62771-48	61480-48
72	12	61979-72	61956-72	61959-72	61980-72	62771-72	61480-72

## Optical Specifications

TIA-568.3-D | ISO/IEC 11801, 2nd edition | Telcordia GR-409-CORE

Fiber type	Max. Attenuation (dB/km)		Min OFL Bandwidth (MHz-km)		Min EMBc Bandwidth (MHz-km)		Gb Ethernet distance (m)		10 Gb Ethernet distance(m)	
	850nm (MM)	1300nm (MM)	850nm (MM)	1300nm (MM)	850nm (MM)	1300nm (MM)	850nm (MM)	1300nm (MM)	850nm (MM)	1300nm (MM)
OM1	3.5	1.0	200	500	220	N/A	300	550	33	N/A
OM2	3.0	1.0	700	500	950	N/A	750	550	150	N/A
OM3	3.0	1.0	1500	500	2000	N/A	1000	550	300	N/A
OM4	3.0	1.0	3500	500	4700	N/A	1100	550	550	N/A
OM5*	3.0	1.0	3500	500	4700	N/A	1100	550	550	N/A
	1310nm (SM)	1550nm (SM)	1310nm (SM)	1550nm (SM)	1310nm (SM)	1550nm (SM)	1310nm (SM)	1550nm (SM)	1310nm (SM)	1550nm (SM)
OS2	0.5	0.5	N/A	N/A	N/A	N/A	> 25,000	> 40,000	10,000 - 25,000	40,000

\*OM5 optical fiber tested by glass manufacturer and exceeds the requirements of all applicable industry standards. Hitachi Cable America reserves the right to revise any specifications.

### Cable Temperature Ranges

Storage: -40° to 70°C (-40° to 158°F)  
 Installation: 0°C to 60°C (32° to 140°F)  
 Operating: -40° to 70°C (-40° to 158°F)

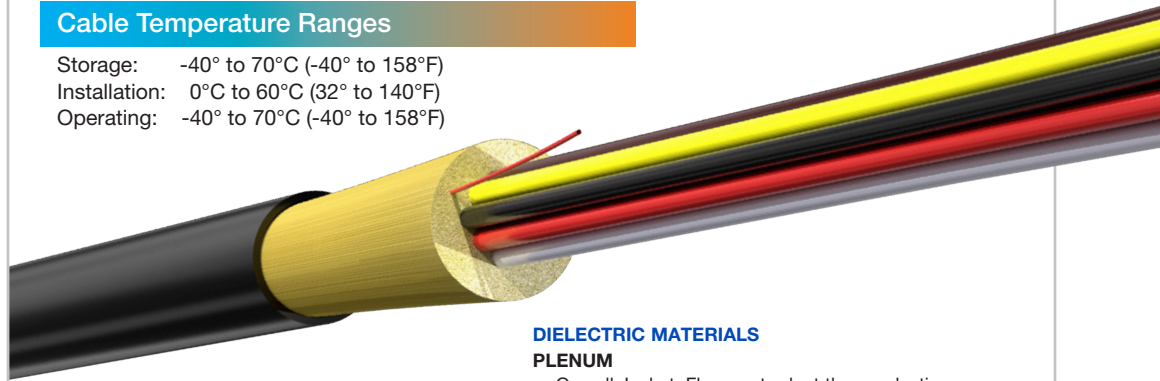

**DIELECTRIC MATERIALS**  
**PLENUM**

Overall Jacket: Flame-retardant thermoplastic



Multimode and Singlemode

# Tight Buffered

## SPECIFICATIONS BY FIBER COUNT

			RECOMMENDED MAXIMUM LOADS							
			CABLE O.D.		INSTALL		OPERATION		CABLE WEIGHT	
FIBERS	FIBERS/TUBE	TUBE LAYOUT	inches	mm	lbs-f	N	lbs-f	N	lbs/1000 ft	kg/1000 m
2	2	x	0.190	4.83	128	570	38	171	12.6	18.8
4	4	x	0.190	4.83	128	570	38	171	13.9	20.7
6	6	x	0.190	4.83	128	570	38	171	15.1	22.5
8	8	x	0.230	5.84	160	712	48	214	20.0	29.8
10	10	x	0.230	5.84	160	712	48	214	21.3	31.7
12	12	x	0.230	5.84	160	712	48	214	22.5	33.5
24	24	x	0.330	8.38	288	1282	86	385	50.2	74.8
36	6	6xCSM	0.639	16.2	600	2670	200	890	159.2	236.9
48	12	4xCSM	0.627	15.9	640	2849	192	855	135.1	201.1
72	12	6xCSM	0.756	19.2	960	4273	288	1282	226.6	337.2

CSM = Central Strength Member

## Mechanical Specifications

- Bend radius, no load = 10x cable overall diameter
- Bend radius, load = 15x cable overall diameter

plus  
**CORNING®**  
ClearCurve® Optical Fiber

FIBER

## Features

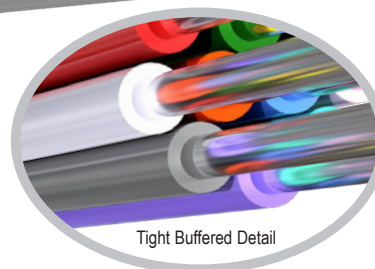
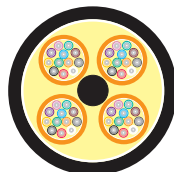
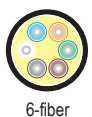
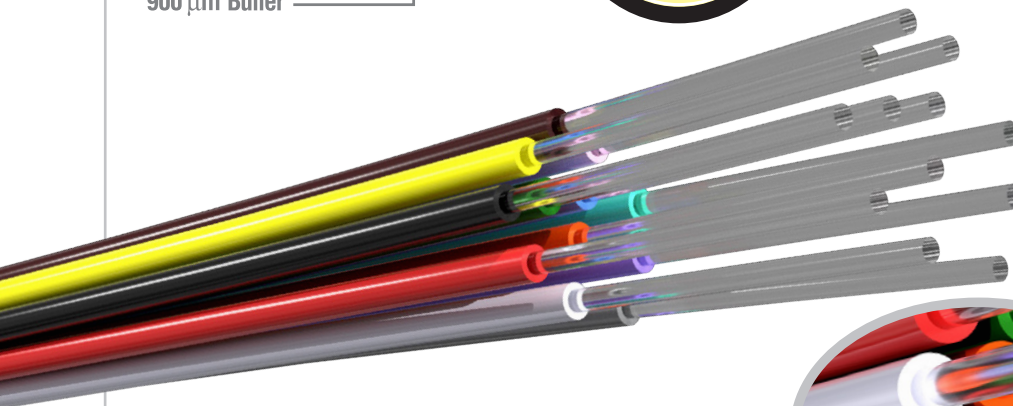
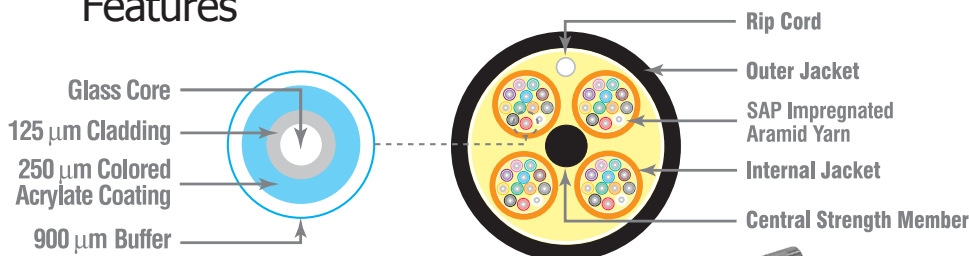

HITACHI

Photo is for representation purposes only.

Diagram scale approx. 3:1

# Indoor / Outdoor

2 through 72 fibers

FIBER

## Product Highlights

- REACH & RoHS 2 compliant
- Made in U.S.A.
- All multimode, and singlemode cables (except OM1) utilize bend-insensitive optical fibers
- UV and fungus resistant jacket
- Tight buffered construction
- Each fiber is color coded for easy identification
- Dry, super absorbent polymers (SAPs) eliminate water migration in cable interstices
- Suitable for lashed aerial, duct, underground conduit and indoor riser applications
- 900um buffered design recommended for easy termination
- Cables with more than 24 fibers have fibers segregated into 12-fiber sub-units

## Options

- Low smoke zero halogen (LSZH) available
- Enhanced bend insensitive OS2 optical fiber is available (ITU-T G.657.B3 & G.657.A2)
- OM4+ optical fibers with extended 10 gigabit Ethernet distances are available

## Applications

- Applications include 10, 40 & 100 gigabit Ethernet, Fibre Channel, Video, Security, Automation
- OM5 supports applications utilizing Short Wave Division Multiplexing (SWDM)

## Standards

- ANSI/TIA-568.3-D
- ISO/IEC 11801, 2nd edition
- Telcordia GR-409-CORE

## Indoor/Outdoor Tight Buffered (Riser)

(UL) OFNR c(UL) OFNR FT4

### PART NUMBERS BY FIBER COUNT

FIBERS	FIBERS PER TUBE	62.5 UM OM1	50 UM OM2	50 UM OM3	50 UM OM4	50 UM OM5	8.3 UM OS2
2	2	61345-2	61347-2	61348-2	61893-2	62766-2	61349-2
4	4	61345-4	61347-4	61348-4	61893-4	62766-4	61349-4
6	6	61345-6	61347-6	61348-6	61893-6	62766-6	61349-6
8	8	61345-8	61347-8	61348-8	61893-8	62766-8	61349-8
10	10	61345-10	61347-10	61348-10	61893-10	62766-10	61349-10
12	12	61345-12	61347-12	61348-12	61893-12	62766-12	61349-12
24	24	61345-24	61347-24	61348-24	61893-24	62766-24	61349-24
36	6	61380-36	61376-36	61523-36	61899-36	62767-36	61415-36
48	12	61495-48	61522-48	61524-48	61898-48	62768-48	61363-48
72	12	61495-72	61522--72	61524-72	61898-72	62768-72	61363-72

## Optical Specifications

TIA-568.3-D | ISO/IEC 11801, 2nd edition | Telcordia GR-409-CORE

Fiber type	Max. Attenuation (dB/km)		Min OFL Bandwidth (MHz-km)		Min EMBc Bandwidth (MHz-km)		Gb Ethernet distance (m)		10 Gb Ethernet distance(m)	
	850nm (MM)	1300nm (MM)	850nm (MM)	1300nm (MM)	850nm (MM)	1300nm (MM)	850nm (MM)	1300nm (MM)	850nm (MM)	1300nm (MM)
OM1	3.5	1.0	200	500	220	N/A	300	550	33	N/A
OM2	3.0	1.0	700	500	950	N/A	750	550	150	N/A
OM3	3.0	1.0	1500	500	2000	N/A	1000	550	300	N/A
OM4	3.0	1.0	3500	500	4700	N/A	1100	550	550	N/A
OM5*	3.0	1.0	3500	500	4700	N/A	1100	550	550	N/A
	1310nm (SM)	1550nm (SM)	1310nm (SM)	1550nm (SM)	1310nm (SM)	1550nm (SM)	1310nm (SM)	1550nm (SM)	1310nm (SM)	1550nm (SM)
OS2	0.5	0.5	N/A	N/A	N/A	N/A	> 25,000	> 40,000	10,000 - 25,000	40,000

\*OM5 optical fiber tested by glass manufacturer and exceeds the requirements of all applicable industry standards. Hitachi Cable America reserves the right to revise any specifications.

## Cable Temperature Ranges

Storage: -40° to 70°C (-40° to 158°F)  
 Installation: -10° to 60°C (14° to 140°F)  
 Operating: -40° to 70°C (-40° to 158°F)

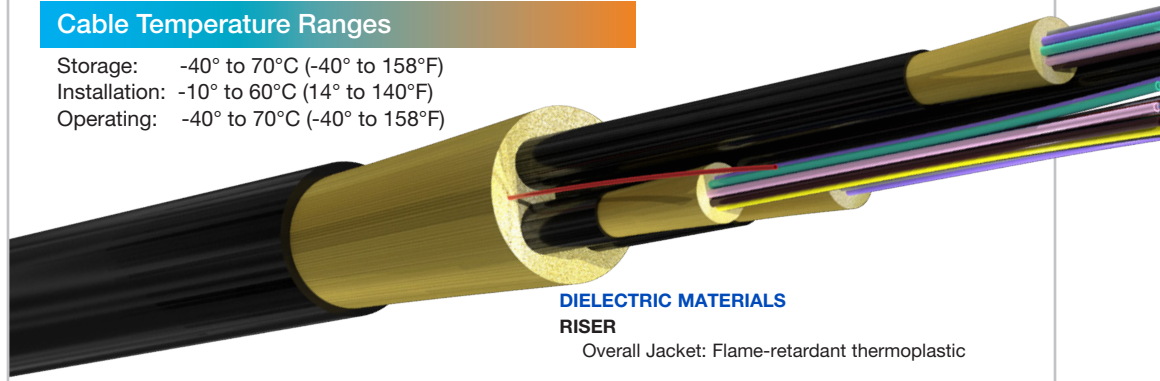

# Tight Buffered

## SPECIFICATIONS BY FIBER COUNT

FIBERS	FIBERS/TUBE	TUBE LAYOUT	CABLE O.D.		RECOMMENDED MAXIMUM LOADS				CABLE WEIGHT	
			inches	mm	INSTALL		OPERATION		lbs/1000 ft	kg/1000 m
					lbs-f	N	lbs-f	N		
2	2	x	0.190	4.83	128	570	38	171	12.6	18.8
4	4	x	0.190	4.83	128	570	38	171	13.9	20.7
6	6	x	0.190	4.83	128	570	38	171	15.1	22.5
8	8	x	0.230	5.84	160	712	48	214	20.0	29.8
10	10	x	0.230	5.84	160	712	48	214	21.3	31.7
12	12	x	0.230	5.84	160	712	48	214	22.5	33.5
24	24	x	0.330	8.38	288	1282	86	385	50.2	74.8
36	6	6xCSM	0.639	16.2	600	2670	200	890	159.2	236.9
48	12	4xCSM	0.627	15.9	640	2849	192	855	135.1	201.1
72	12	6xCSM	0.756	19.2	960	4273	288	1282	226.6	337.2

CSM = Central Strength Member

## Mechanical Specifications

- Bend radius, no load = 10x cable overall diameter
- Bend radius, load = 15x cable overall diameter



FIBER



## Features

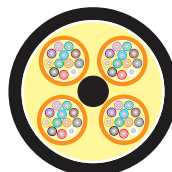
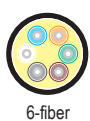
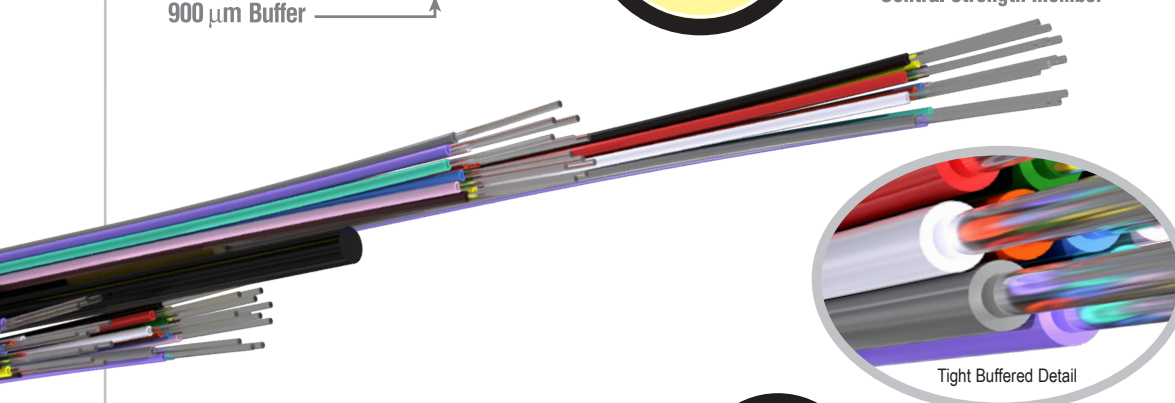
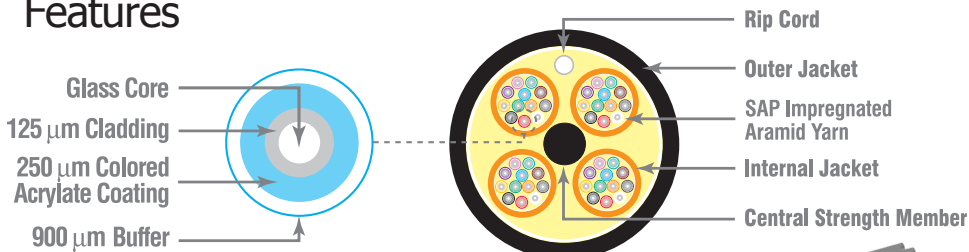

Diagram scale approx. 2:1

Photo is for representation purposes only.

# Tight Buffered

2 Through 24 fibers

FIBER

## Product Highlights

- REACH & RoHS 2 compliant
- Made in U.S.A.
- All multimode, and singlemode cables (except OM1) utilize bend-insensitive optical fibers
- Eliminates need for innerduct or conduit
- Aluminum interlock armor standard
- Each fiber is color coded for easy identification
- Ideal cable solution for campus environments
- Flexible and easy to handle
- UV and fungus resistant jacket
- Dry, super absorbent polymers (SAPs) eliminate water migration in cable interstices
- Suitable for lashed aerial, duct, underground conduit and indoor plenum applications
- 900um buffered design recommended for easy termination

## Options

- Standard color configuration is a black outer jacket with a black inner jacket. Colored inner and outer jackets (orange, yellow & aqua) can be special ordered
- Enhanced bend insensitive OS2 optical fiber is available (ITU-T G.657.B3 & G.657.A2)
- OM4+ optical fibers with extended 10 gigabit Ethernet distances are available
- Steel interlock armor available

## Applications

- Applications include 10, 40 & 100 gigabit Ethernet, Fibre Channel, Video, Security, Automation
- OM5 supports applications utilizing Short Wave Division Multiplexing (SWDM)

## Standards

- ANSI/TIA-568.3-D
- ISO/IEC 11801, 2nd edition
- Telcordia GR-409-CORE

## Indoor/Outdoor Armored Tight Buffered (Plenum)

(UL) OFCP c(UL) OFCP FT6

PART NUMBERS BY FIBER COUNT						
FIBERS	62.5 UM OM1	50 UM OM2	50 UM OM3	50 UM OM4	50 UM OM5	8.3 UM OS2
2	61580-2	61577-2	61578-2	62068-2	62772-2	61579-2
4	61580-4	61577-4	61578-4	62068-4	62772-4	61579-4
6	61580-6	61577-6	61578-6	62068-6	62772-6	61579-6
8	61580-8	61577-8	61578-8	62068-8	62772-8	61579-8
12	61580-12	61577-12	61578-12	62068-12	62772-12	61579-12
24	61580-24	61577-24	61578-24	62068-24	62772-24	61579-24

## Optical Specifications

TIA-568.3-D | ISO/IEC 11801, 2nd edition | Telcordia GR-409-CORE

Fiber type	Max. Attenuation (dB/km)		Min OFL Bandwidth (MHz-km)		Min EMBc Bandwidth (MHz-km)		Gb Ethernet distance (m)		10 Gb Ethernet distance(m)	
	850nm (MM)	1300nm (MM)	850nm (MM)	1300nm (MM)	850nm (MM)	1300nm (MM)	850nm (MM)	1300nm (MM)	850nm (MM)	1300nm (MM)
OM1	3.5	1.0	200	500	220	N/A	300	550	33	N/A
OM2	3.0	1.0	700	500	950	N/A	750	550	150	N/A
OM3	3.0	1.0	1500	500	2000	N/A	1000	550	300	N/A
OM4	3.0	1.0	3500	500	4700	N/A	1100	550	550	N/A
OM5*	3.0	1.0	3500	500	4700	N/A	1100	550	550	N/A
	1310nm (SM)	1550nm (SM)	1310nm (SM)	1550nm (SM)	1310nm (SM)	1550nm (SM)	1310nm (SM)	1550nm (SM)	1310nm (SM)	1550nm (SM)
OS2	0.5	0.5	N/A	N/A	N/A	N/A	> 25,000	> 40,000	10,000 - 25,000	40,000

\*OM5 optical fiber tested by glass manufacturer and exceeds the requirements of all applicable industry standards. Hitachi Cable America reserves the right to revise any specifications.

## Cable Temperature Ranges

Storage: -40° to 70°C (-40° to 158°F)  
 Installation: 0° to 60°C (32° to 140°F)  
 Operating: -40° to 70°C (-40° to 158°F)

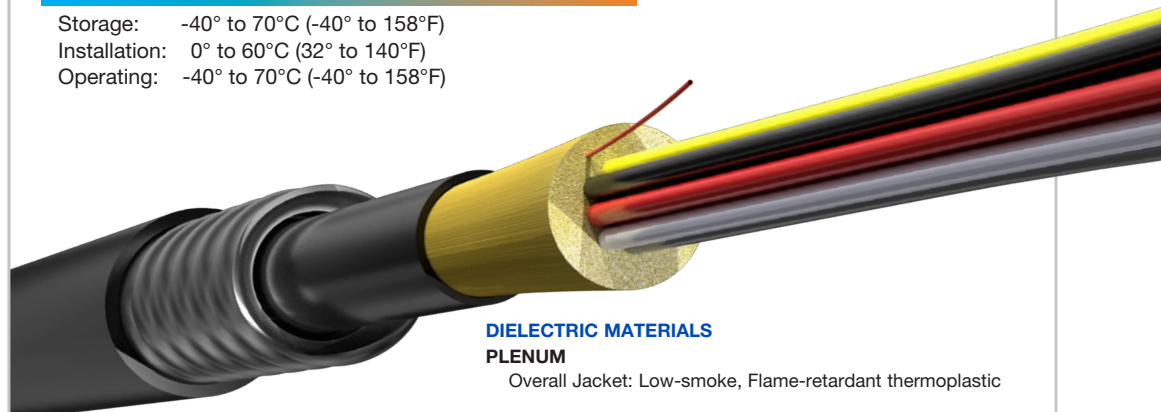

**DIELECTRIC MATERIALS**  
**PLENUM**

Overall Jacket: Low-smoke, Flame-retardant thermoplastic

# Multimode and Singlemode Armored

## SPECIFICATIONS BY FIBER COUNT

FIBERS	CABLE O.D.		RECOMMENDED MAXIMUM LOADS					
			INSTALL		OPERATION		CABLE WEIGHT	
	inches	mm	lbs-f	N	lbs-f	N	lbs/1000 ft	kg/1000bm
2	0.48	12.192	300	1335	100	445	100.4	149.4
4	0.48	12.192	300	1335	100	445	101.7	151.4
6	0.48	12.192	300	1335	100	445	103.0	153.3
8	0.52	13.208	300	1335	100	445	109.1	162.4
12	0.52	13.208	300	1335	100	445	111.8	166.4
24	0.64	16.256	300	1335	100	445	164.1	244.2

## Mechanical Specifications

- Bend radius, no load = 10x cable overall diameter
- Bend radius, load = 15x cable overall diameter

plus  
**CORNING**<sup>®</sup>  
ClearCurve<sup>®</sup> Optical Fiber

FIBER



## Features

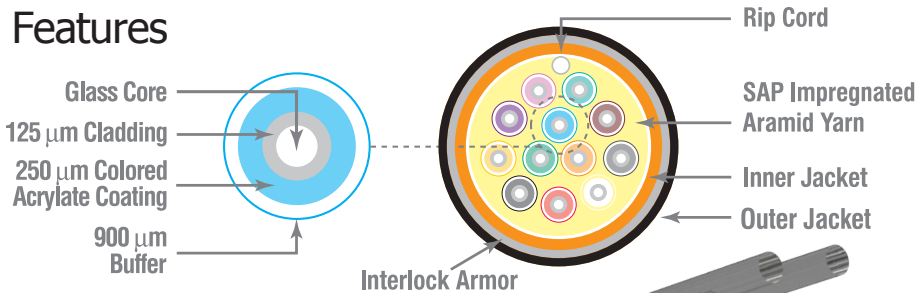

12-fiber  
Diagram scale approx. 2:1

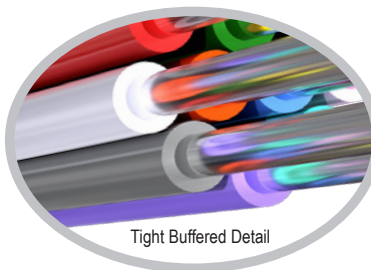

Tight Buffered Detail

Photo is for representation purposes only.

# Non-Armored OSP

12 through 144 fibers

FIBER

## Product Highlights

- REACH & RoHS 2 compliant
- Made in U.S.A.
- All multimode, and singlemode cables (except OM1) utilize bend-insensitive optical fibers
- UV and fungus resistant jacket
- Gel filled loose tubes provide protection against water penetration
- Dry, super absorbent polymers (SAPs) eliminate water migration in cable interstices
- Suitable for lashed aerial, duct, and underground conduit
- SM Fiber optic cable is RDUP approved

## Options

- Other configurations and fiber counts available
- Enhanced bend insensitive OS2 optical fiber is available (ITU-T G.657.B3 & G.657.A2)
- Dual jacket constructions available.
- Low smoke zero halogen (LSZH) available
- Up to 432 fibers available
- OM4+ optical fibers with extended 10 gigabit Ethernet distances are available

## Applications

- Applications include 10, 40 & 100 gigabit Ethernet, Fibre Channel, Video, Security, Automation

## Standards

- ANSI/TIA-568.3-D
- ISO/IEC 11801, 2nd edition
- Telcordia GR-409-CORE

## Outdoor Loose Tube (Outside Plant)

PART NUMBERS BY FIBER COUNT

FIBERS	FIBERS/TUBE	62.5 UM OM1	50 UM OM2	50 UM OM3	50 UM OM4	50 UM OM5	8.3 UM OS2
12	12	60086-12	60088-12	60943-12	61908-12	62774-12	60090-12
24	12	60086-24	60088-24	60943-24	61908-24	62774-24	60090-24
36	12	60086-36	60088-36	60943-36	61908-36	62774-36	60090-36
48	12	60086-48	60088-48	60943-48	61908-48	62774-48	60090-48
60	12	60086-60	60088-60	60943-60	61908-60	62774-60	60090-60
72	12	60086-72	60088-72	60943-72	61908-72	62774-72	60090-72
96	12	60086-96	60088-96	60943-96	61908-96	62774-96	60090-96
144	12	60086-144	60088-144	60943-144	61908-144	62774-144	60090-144

## Optical Specifications TIA-568.3-D | ISO/IEC 11801, 2nd edition | Telcordia GR-409-CORE

Fiber type	Max. Attenuation (dB/km)		Min OFL Bandwidth (MHz-km)		Min EMBc Bandwidth (MHz-km)		Gb Ethernet distance (m)		10 Gb Ethernet distance(m)	
	850nm (MM)	1300nm (MM)	850nm (MM)	1300nm (MM)	850nm (MM)	1300nm (MM)	850nm (MM)	1300nm (MM)	850nm (MM)	1300nm (MM)
OM1	3.5	1.0	200	500	220	N/A	300	550	33	N/A
OM2	3.0	1.0	700	500	950	N/A	750	550	150	N/A
OM3	3.0	1.0	1500	500	2000	N/A	1000	550	300	N/A
OM4	3.0	1.0	3500	500	4700	N/A	1100	550	550	N/A
OM5*	3.0	1.0	3500	500	4700	N/A	1100	550	550	N/A
	1310nm (SM)	1550nm (SM)	1310nm (SM)	1550nm (SM)	1310nm (SM)	1550nm (SM)	1310nm (SM)	1550nm (SM)	1310nm (SM)	1550nm (SM)
OS2	0.5	0.5	N/A	N/A	N/A	N/A	> 25,000	> 40,000	10,000 - 25,000	40,000

\*OM5 optical fiber tested by glass manufacturer and exceeds the requirements of all applicable industry standards. Hitachi Cable America reserves the right to revise any specifications.

### Cable Temperature Ranges

Storage: -40° to 70°C (-40° to 158°F)  
 Installation: -30° to 60°C (-22° to 140°F)  
 Operating: -40° to 70°C (-40° to 158°F)

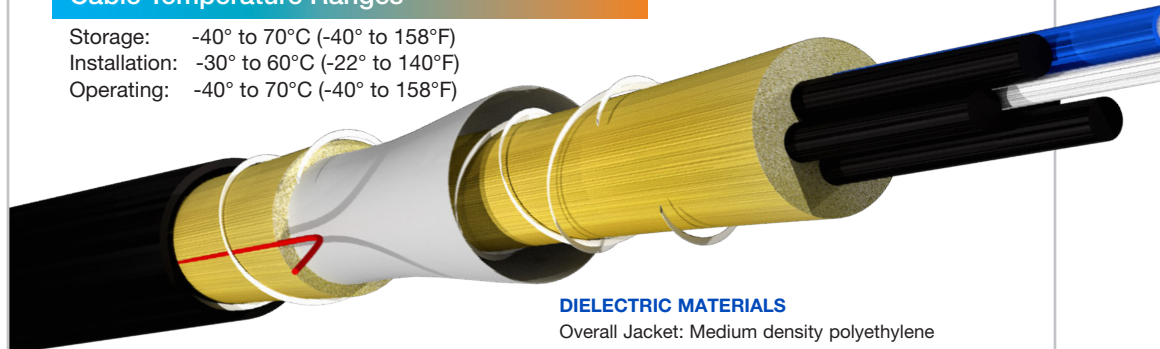

**DIELECTRIC MATERIALS**

Overall Jacket: Medium density polyethylene

# Loose Tube

**SPECIFICATIONS BY FIBER COUNT**

FIBERS	FIBERS/ TUBE	TUBE LAYOUT	RECOMMENDED MAXIMUM LOADS							
			CABLE O.D.		INSTALL		OPERATION		CABLE WEIGHT	
			inches	mm	lbs-f	N	lbs-f	N	lbs/1000 ft	kg/1000 m
12	12	5XCSCM	0.463	11.7	600	2670	180	800	62.9	93.7
24	12	5XCSCM	0.463	11.7	600	2670	180	800	64.2	95.6
36	12	5XCSCM	0.463	11.7	600	2670	180	800	65.1	97.0
48	12	5XCSCM	0.463	11.7	600	2670	180	800	66.2	98.6
60	12	5XCSCM	0.463	11.7	600	2670	180	800	67.0	99.8
72	12	6xCSCM	0.493	12.5	600	2670	180	800	76.0	113.2
96	12	8XCSCM	0.581	14.8	600	2670	180	800	106.0	157.9
144	12	12XCSCM	0.720	18.3	600	2670	180	800	171.0	255.0

CSM = Central Strength Member

## Mechanical Specifications

- Bend radius, no load = 10x cable overall diameter
- Bend radius, load = 15x cable overall diameter

Loose Tube Diameter		
	inches	mm
2-12 fibers per tube	0.110	2.8

plus **CORNING**  
ClearCurve® Optical Fiber

FIBER

## Features

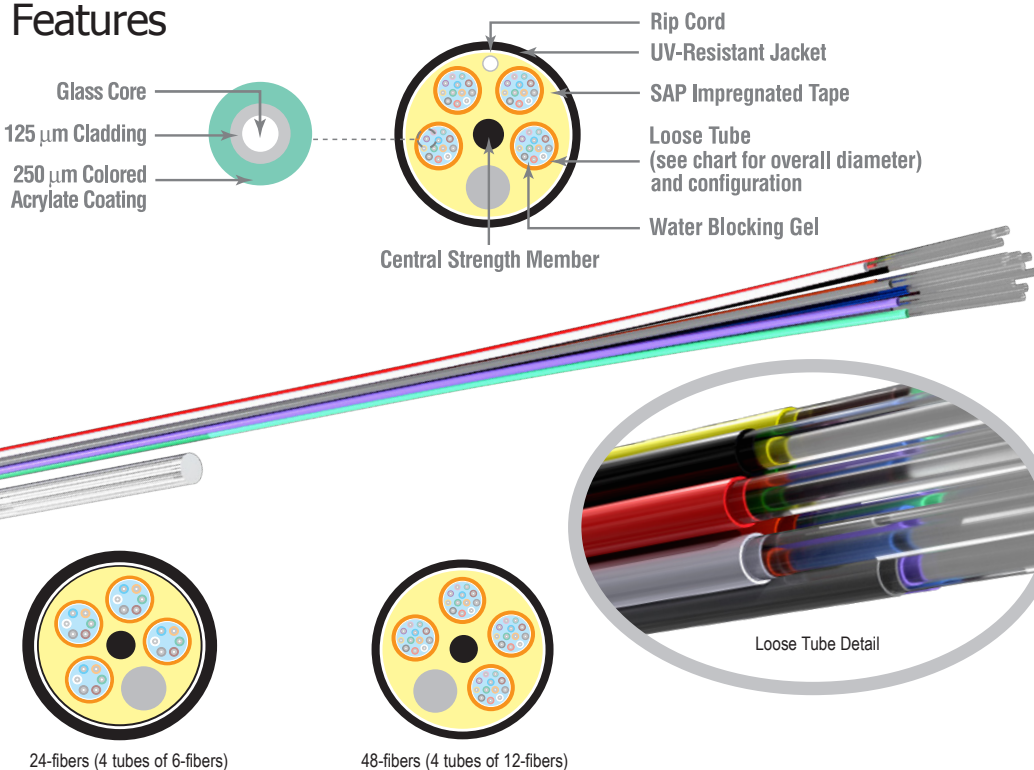

Diagram scale approx. 1:1

Photo is for representation purposes only.

# Armored OSP

12 through 144 fibers

FIBER

## Product Highlights

- REACH & RoHS 2 compliant
- Made in U.S.A.
- All multimode, and singlemode cables (except OM1) utilize bend-insensitive optical fibers
- Rugged corrugated steel armor provides extra crush-resistance and rodent protection
- UV and fungus resistant jacket.
- Gel filled loose tube provides protection against water penetration
- Dry, super absorbent polymers (SAPs) eliminate water migration in cable interstices
- Suitable for lashed aerial, duct, underground conduit and direct bury applications

## Options

- Other configurations and fiber counts available
- Enhanced bend insensitive OS2 optical fiber is available (ITU-T G.657.B3 & G.657.A2)
- Dual jacket constructions available.
- Low smoke zero halogen (LSZH) available
- Up to 432 fibers available
- OM4+ optical fibers with extended 10 gigabit Ethernet distances are available

## Applications

- Applications include 10, 40 & 100 gigabit Ethernet, Fibre Channel, Video, Security, Automation

## Standards

- ANSI/TIA-568.3-D
- ISO/IEC 11801, 2nd edition
- Telcordia GR-409-CORE

## Outdoor Armored Loose Tube (Outside Plant)

PART NUMBERS BY FIBER COUNT

FIBERS	FIBERS/TUBE	62.5 UM OM1	50 UM OM2	50 UM OM3	50 UM OM4	8.3 UM OS2
12	12	60098-12	60937-12	61497-12	61912-12	60102-12
24	12	60098-24	60937-24	61497-24	61912-24	60102-24
48	12	60098-48	60937-48	61497-48	61912-48	60102-48
72	12	60098-72	60937-72	61497-72	61912-72	60102-72
96	12	60098-96	60937-96	61497-96	61912-96	60102-96
144	12	60098-144	60937-144	61497-144	61912-144	60102-144

## Optical Specifications

TIA-568.3-D | ISO/IEC 11801, 2nd edition | Telcordia GR-409-CORE

Fiber type	Max. Attenuation (dB/km)		Min OFL Bandwidth (MHz-km)		Min EMBc Bandwidth (MHz-km)		Gb Ethernet distance (m)		10 Gb Ethernet distance(m)	
	850nm (MM)	1300nm (MM)	850nm (MM)	1300nm (MM)	850nm (MM)	1300nm (MM)	850nm (MM)	1300nm (MM)	850nm (MM)	1300nm (MM)
OM1	3.5	1.0	200	500	220	N/A	300	550	33	N/A
OM2	3.0	1.0	700	500	950	N/A	750	550	150	N/A
OM3	3.0	1.0	1500	500	2000	N/A	1000	550	300	N/A
OM4	3.0	1.0	3500	500	4700	N/A	1100	550	550	N/A
	1310nm (SM)	1550nm (SM)	1310nm (SM)	1550nm (SM)	1310nm (SM)	1550nm (SM)	1310nm (SM)	1550nm (SM)	1310nm (SM)	1550nm (SM)
OS2	0.5	0.5	N/A	N/A	N/A	N/A	> 25,000	> 40,000	10,000 - 25,000	40,000

\*OM5 optical fiber tested by glass manufacturer and exceeds the requirements of all applicable industry standards. Hitachi Cable America reserves the right to revise any specifications.

## Cable Temperature Ranges

Storage: -40° to 70°C (-40° to 158°F)  
 Installation: -30° to 60°C (-22° to 140°F)  
 Operating: -40° to 70°C (-40° to 158°F)

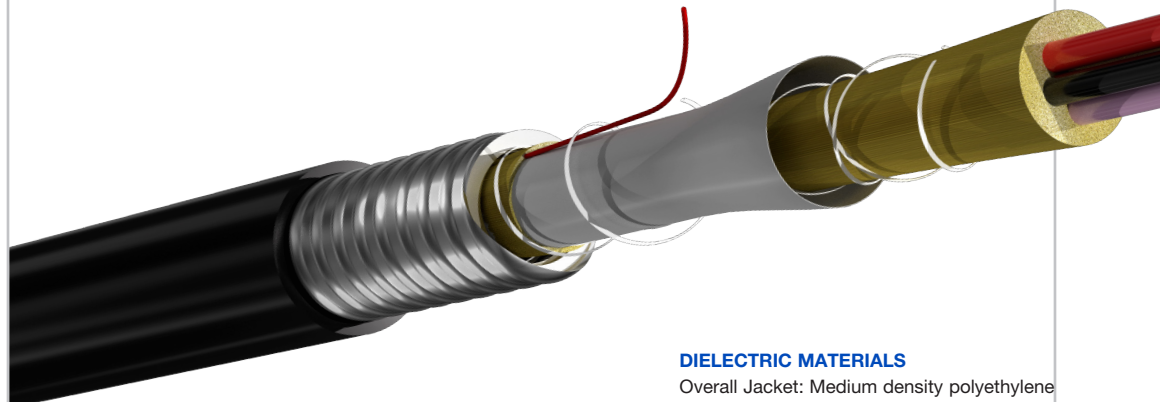

**DIELECTRIC MATERIALS**

Overall Jacket: Medium density polyethylene



Multimode and Singlemode

# Loose Tube <sup>Armored</sup>

## SPECIFICATIONS BY FIBER COUNT

FIBERS	FIBERS/TUBE	TUBE LAYOUT	CABLE O.D.		RECOMMENDED MAXIMUM LOADS				CABLE WEIGHT	
			inches	mm	INSTALL		OPERATION		lbs/1000 ft	kg/1000 m
12	12	5XCSCM	0.508	13.1	600	2670	180	800	112.6	167.7
24	12	5XCSCM	0.508	13.1	600	2670	180	800	114.7	170.8
48	12	5XCSCM	0.508	13.1	600	2670	180	800	115.5	172.0
72	12	6XCSCM	0.539	13.7	600	2670	180	800	135.0	200.9
96	12	8XCSCM	0.626	15.9	600	2670	180	800	173.0	257.5
144	12	12xCSCM	0.768	19.5	600	2670	180	800	241.0	359.1

CSM = Central Strength Member

## Mechanical Specifications

- Bend radius, no load = 10x cable overall diameter
- Bend radius, load = 15x cable overall diameter

Loose Tube Diameter		
	inches	mm
2-12 fibers per tube	0.110	2.8

plus **CORNING**<sup>®</sup>  
ClearCurve<sup>®</sup> Optical Fiber

FIBER

## Features

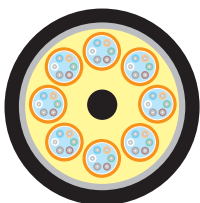
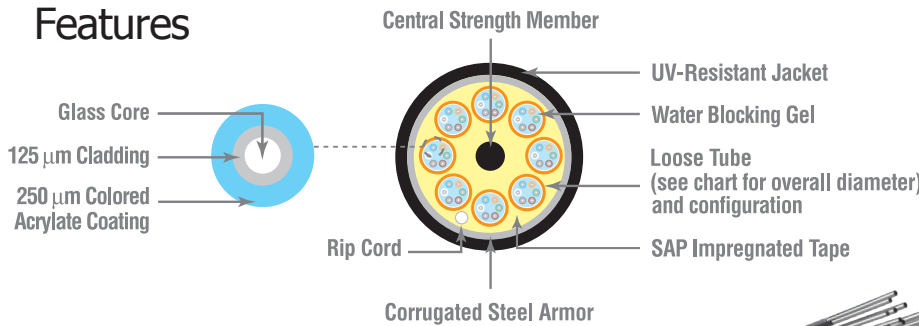

48-fibers (8 tubes of 6-fibers)

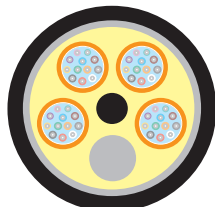

48-fibers (4 tubes of 12-fibers)

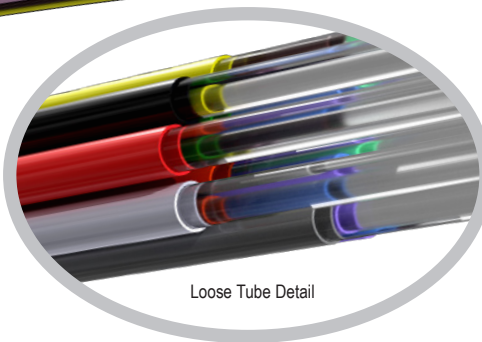

Loose Tube Detail

Photo is for representation purposes only.

# Indoor / Outdoor

2, 6 & 12-fiber, 2 Copper Conductors

## Product Highlights

- REACH & RoHS 2 compliant
- Made in U.S.A.
- Extending PoE and Limited Power SELV data transmission beyond 100 meters
- Provides immunity from electromagnetic and radio frequency interference
- Choice of separate power conductors eliminates concerns associated with heat generation and length derating calculations as required by TIA 568 and NEC
- Plenum and outdoor rating permits use in a wide range of environments
- Dry, super absorbent polymers (SAPs) eliminate water migration in cable interstices
- Suitable for lashed aerial, duct underground conduit and indoor plenum applications
- All multimode and singlemode cables (except OM1) utilize bend-insensitive optical fibers
- Easy to strip and terminate
- Lightweight, flexible aramid yarns throughout the design enhance strength
- Each 900um buffered fiber resides in a 2mm subunit for easy termination to LC, SC connectors and more

## Options

- Available with 2, 6 or 12 strands of tight buffered fiber
- Available with 1 pair of 12, 14, 16, 18, 20 or 22 AWG stranded conductors

## Applications

- High noise areas and extended distance
- Security CCTV Cameras
- Wireless Access Points
- Distributed Antenna Systems (DAS)
- Passive Optical Networks (PON)
- Ideal for all remote powered applications

## Standards

- NEC CL2P-OF rating, compliant with Class 2 SELV (Safety Extra Low Voltage)
- NFPA 262
- ANSI/TIA-568.3-D

## Power+™ Composite (Indoor/Outdoor Plenum)

(UL) OFCP c(UL) OFCP FT6

22 AWG	FIBERS	CABLE O.D. (mm)	62.5 UM OM1	50 UM OM2	50 UM OM3	50 UM OM4	50 UM OM5	8.3 UM OS2
	2	5.8	62860-4	62861-4	62862-4	62863-4	62864-4	62859-4
6	8.0	62860-8	62861-8	62862-8	62863-8	62864-8	62859-8	
12	10.2	62860-14	62861-14	62862-14	62863-14	62864-14	62859-14	

20 AWG	FIBERS	CABLE O.D. (mm)	62.5 UM OM1	50 UM OM2	50 UM OM3	50 UM OM4	50 UM OM5	8.3 UM OS2
	2	6.2	62866-4	62867-4	62868-4	62869-4	62870-4	62865-4
6	8.4	62866-8	62867-8	62868-8	62869-8	62870-8	62865-8	
12	10.5	62866-14	62867-14	62868-14	62869-14	62870-14	62865-14	

18 AWG	FIBERS	CABLE O.D. (mm)	62.5 UM OM1	50 UM OM2	50 UM OM3	50 UM OM4	50 UM OM5	8.3 UM OS2
	2	6.8	62872-4	62873-4	62874-4	62875-4	62876-4	62871-4
6	8.4	62872-8	62873-8	62874-8	62875-8	62876-8	62871-8	
12	10.2	62872-14	62873-14	62874-14	62875-14	62876-14	62871-14	

16 AWG	FIBERS	CABLE O.D. (mm)	62.5 UM OM1	50 UM OM2	50 UM OM3	50 UM OM4	50 UM OM5	8.3 UM OS2
	2	7.1	62878-4	62879-4	62880-4	62881-4	62882-4	62877-4
6	8.4	62878-8	62879-8	62880-8	62881-8	62882-8	62877-8	
12	10.5	62878-14	62879-14	62880-14	62881-14	62882-14	62877-14	

14 AWG	FIBERS	CABLE O.D. (mm)	62.5 UM OM1	50 UM OM2	50 UM OM3	50 UM OM4	50 UM OM5	8.3 UM OS2
	2	7.4	62884-4	62885-4	62886-4	62887-4	62888-4	62883-4
6	9.2	62884-8	62885-8	62886-8	62887-8	62888-8	62883-8	
12	10.8	62884-14	62885-14	62886-14	62887-14	62888-14	62883-14	

12 AWG	FIBERS	CABLE O.D. (mm)	62.5 UM OM1	50 UM OM2	50 UM OM3	50 UM OM4	50 UM OM5	8.3 UM OS2
	2	7.7	62890-4	62891-4	62892-4	62893-4	62894-4	62889-4
6	10.1	62890-8	62891-8	62892-8	62893-8	62894-8	62889-8	
12	11.3	62890-14	62891-14	62892-14	62893-14	62894-14	62889-14	

## Cable Temperature Ranges

Storage: -40° to 70°C (-40° to 158°F)  
 Installation: 0° to 60°C (32° to 140°F)  
 Operating: 0° to 70°C (32° to 158°F)

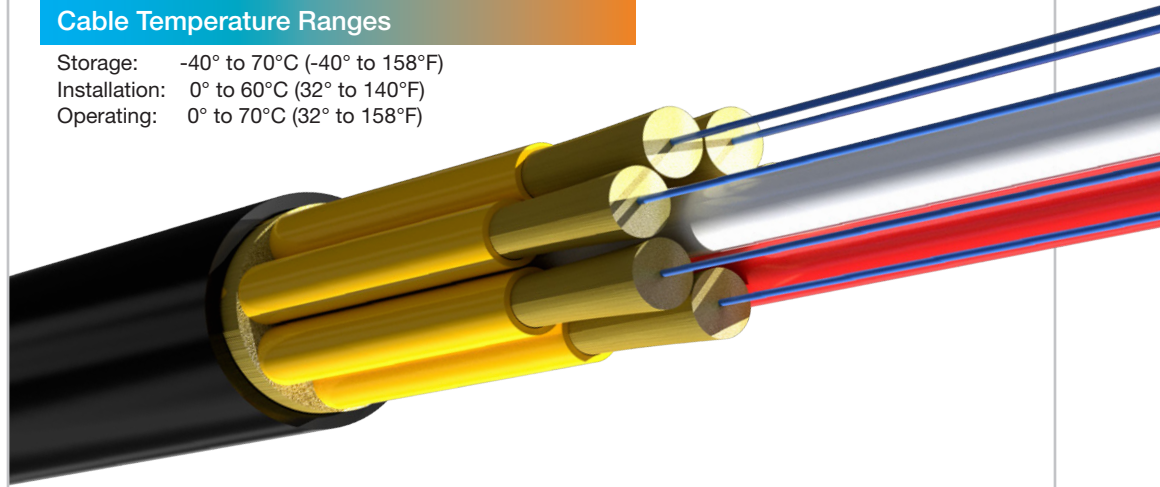

# Power+™ Composite

Multimode and Singlemode

## SPECIFICATION BY FIBER COUNT

CONDUCTORS		# OF FIBERS	CABLE O.D.		RECOMMENDED MAXIMUM LOADS				CABLE WEIGHT	
#	AWG		inches	mm	INSTALL		OPERATION		lbs/kft	kg/km
					lbf	N	lbf	N		
2	22	2	0.229	5.8	180	800	54	240	27.3	40.7
2	22	6	0.314	8.0	180	800	54	240	46.3	69.0
2	22	12	0.400	10.2	180	800	54	240	71.7	106.8
2	20	2	0.243	6.2	180	800	54	240	31.7	47.2
2	20	6	0.333	8.4	180	800	54	240	52.8	78.7
2	20	12	0.413	10.5	180	800	54	240	77.2	115.0
2	18	2	0.268	6.8	180	800	54	240	41.0	61.2
2	18	6	0.329	8.4	180	800	54	240	60.4	90.0
2	18	12	0.403	10.2	180	800	54	240	82.5	123.0
2	16	2	0.279	7.1	180	800	54	240	37.7	56.2
2	16	6	0.329	8.4	180	800	54	240	55.0	82.0
2	16	12	0.415	10.5	180	800	54	240	78.8	117.4
2	14	2	0.291	7.4	180	800	54	240	57.2	85.2
2	14	6	0.363	9.2	180	800	54	240	77.4	115.3
2	14	12	0.427	10.8	180	800	54	240	96.6	143.9
2	12	2	0.302	7.7	180	800	54	240	75.4	112.3
2	12	6	0.398	10.1	180	800	54	240	98.0	146.1
2	12	12	0.444	11.3	180	800	54	240	116.8	174.0

## Optical Specifications

TIA-568.3-D | ISO/IEC 11801, 2nd edition | Telcordia GR-409-CORE

Fiber type	Max. Attenuation (dB/km)		Min OFL Bandwidth (MHz-km)		Min EMBc Bandwidth (MHz-km)		Gb Ethernet distance (m)		10 Gb Ethernet distance (m)	
	850nm (MM)	1300nm (MM)	850nm (MM)	1300nm (MM)	850nm (MM)	1300nm (MM)	850nm (MM)	1300nm (MM)	850nm (MM)	1300nm (MM)
OM1	3.5	1.0	200	500	220	N/A	300	550	33	N/A
OM2	3.0	1.0	700	500	950	N/A	750	550	150	N/A
OM3	3.0	1.0	1500	500	2000	N/A	1000	550	300	N/A
OM4	3.0	1.0	3500	500	4700	N/A	1100	550	550	N/A
OM5*	3.0	1.0	3500	500	4700	N/A	1100	550	550	N/A
	1310nm (SM)	1550nm (SM)	1310nm (SM)	1550nm (SM)	1310nm (SM)	1550nm (SM)	1310nm (SM)	1550nm (SM)	1310nm (SM)	1550nm (SM)
OS2	0.5	0.5	N/A	N/A	N/A	N/A	> 25,000	> 40,000	10,000 - 25,000	40,000

\*OM5 optical fiber tested by glass manufacturer and exceeds the requirements of all applicable industry standards.

## Features

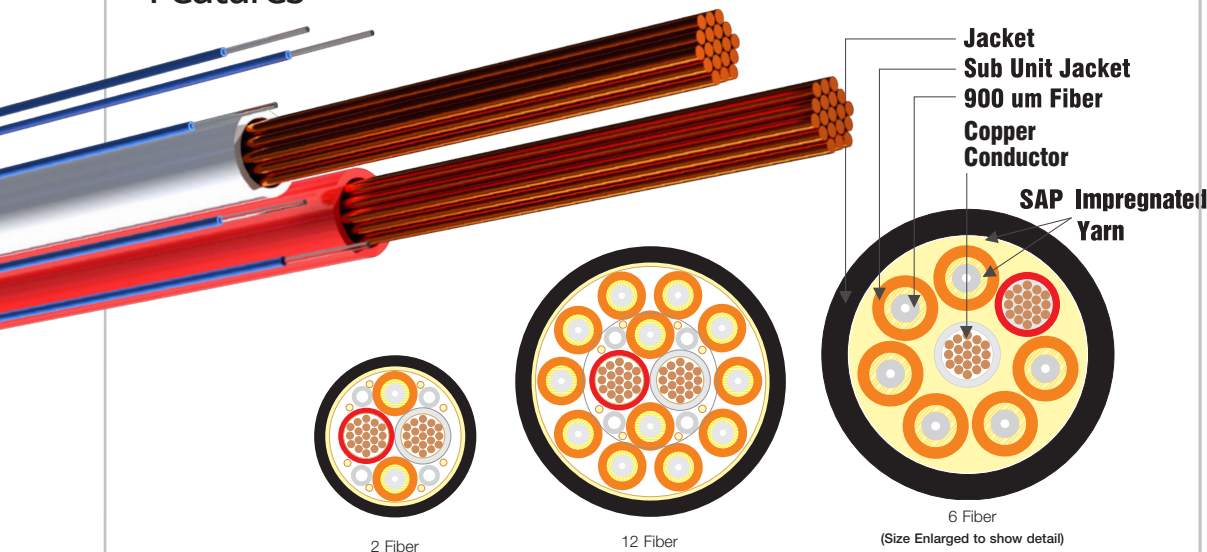

Hitachi Cable America reserves the right to revise any specifications.

# Color Code Chart

## High Pair Count Cables

When cables contain more than one pair group, different color binder tapes are used to differentiate the 25 pair groups.

## Primary Insulation Color Coding

Hitachi Cable America uses a co-extruded color stripe to mark insulated conductors. This process provides several benefits:

- Marking durability is insured for the life of the cable.
- Electrical characteristics of the marking stripe match the insulation.
- Avoids highly toxic ink systems that are required to bond to some materials.

Pair #	Copper Conductor Color Combinations
1	White/Blue - Blue/White
2	White/Orange - Orange/White
3	White/Green - Green/White
4	White/Brown - Brown/White
5	White/Gray - Gray/White
6	Red/Blue - Blue/Red
7	Red/Orange - Orange/Red
8	Red/Green - Green/Red
9	Red/Brown - Brown/Red
10	Red/Gray - Gray/Red
11	Black/Blue - Blue/Black
12	Black/Orange - Orange/Black
13	Black/Green - Green/Black
14	Black/Brown - Brown/Black
15	Black/Gray - Gray/Black
16	Yellow/Blue - Blue/Yellow
17	Yellow/Orange - Orange/Yellow
18	Yellow/Green - Green/Yellow
19	Yellow/Brown - Brown/Yellow
20	Yellow/Gray - Gray/Yellow
21	Violet/Blue - Blue/Violet
22	Violet/Orange - Orange/Violet
23	Violet/Green - Green/Violet
24	Violet/Brown - Brown/Violet
25	Violet/Gray - Gray/Violet

Fiber #	Fiber/Buffer Color
1	Blue
2	Orange
3	Green
4	Brown
5	Gray
6	White
7	Red
8	Black
9	Yellow
10	Violet
11	Pink
12	Aqua
13	Olive
14	Magenta
15	Tan
16	Lime

### Note:

To differentiate bundles in cables with greater than 12 strands, polyester binders or buffer tubes (depending on the construction) are used. Those binders or buffer tubes will incorporate the same color code found in the chart above. The color code is part of the TIA-598 standard. For indoor, multiunit fiber optic cables, subunits will be numbered for identification.

# Code References

National Electric Code

## Cable Substitution Hierarchy

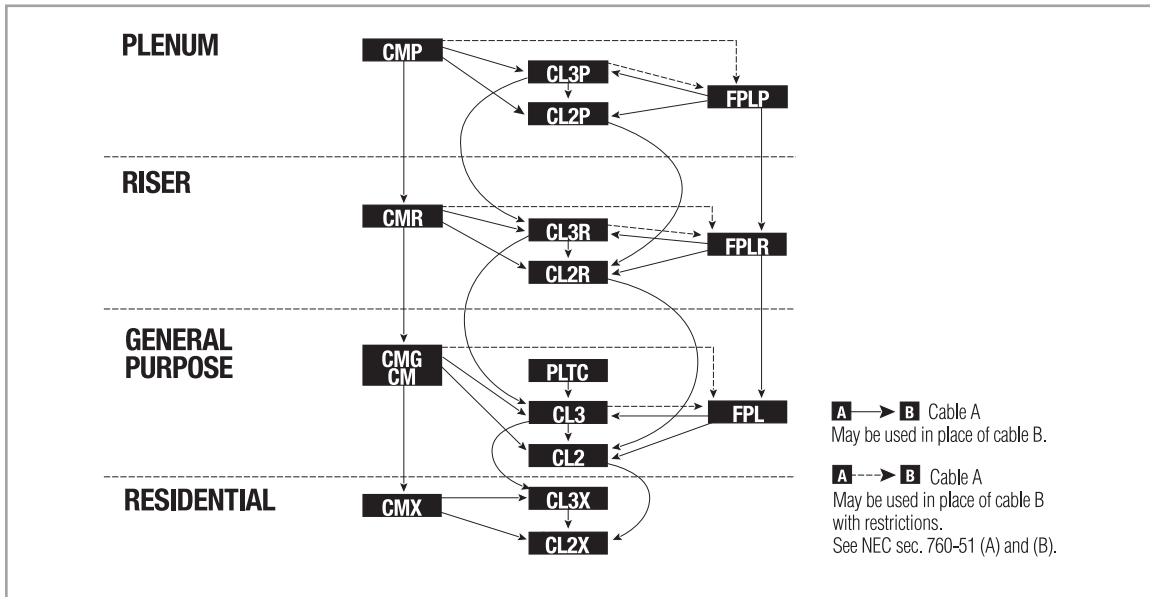

NEC and CSA

## Fire Resistance Levels

Fire Resistance Level	Test Requirement	NEC 725	NEC 760	NEC 800
(Highest) Plenum Cables	NFPA 262 (Steiner Tunnel) CSA-FT6 (Steiner Tunnel)	CL3P CL2P	FPLP	CMP
Riser Cables Multiple Floors	UL-1666 (Vertical Shaft) CSA-FT4, CMG (Vertical Tray)	CL3R CL2R	FPLR	CMR
General Purpose Cables	UL-1581 (Vertical Tray) CSA-FT4, CMG (Vertical Tray)	CL3 CL2	FPL	CM
(Lowest) Residential Cables Restricted Use	UL-1581 VW-1 CSA-FT1	CL3X CL2X		CMX

### Notes

- 1 Cables with a higher fire resistance level may be substituted for those with a lower fire resistance level, except that FT6 must also be marked FT4 for FT4 applications.
- 2 Cables rated CM may be used in runs penetrating one floor. (NEC 800-53)

National Electric Code and NEC are registered trademarks of the National Fire Protection Association, Inc. Quincy, MA.

# Applications

## Copper Applications Matrix

	Category 3	Category 5e	Category 6	Category 6A	Category 7 & 7A
Voice	■	■	■	■	■
T1 Fractional	■	■	■	■	■
IBM Type 3 - 1 Mbps	■	■	■	■	■
4/16 Mbps Token Ring	■	■	■	■	■
10BASE-T Ethernet	■	■	■	■	■
100BASE-T4 Fast Ethernet	■	■	■	■	■
25.6 Mbps ATM	■	■	■	■	■
100 VG - Any LAN	■	■	■	■	■
All other applications developed to operate over Category 3 or class C cabling	■	■	■	■	■
100 Mbps TP-PMD		■	■	■	■
155 Mbps ATM		■	■	■	■
270 Mbps digital video		■	■	■	■
Broadband video		■	■	■	■
100BASE-TX Fast Ethernet		■	■	■	■
1000BASE-T Gigabit Ethernet		■	■	■	■
All other applications developed to operate over Category 5e or class D cabling		■	■	■	■
2.5 Gbase-T Ethernet			■	■	■
5.0 GBase-T Ethernet			■	■	■
1000 Mbps ATM (CBIG)			■	■	■
All other applications developed to operate over Category 6 or Class E cabling			■	■	■
10GBASE-T Ethernet			■ <sup>2</sup>	■	■
All other applications developed to operate over Category 6A or Class EA cabling				■	■
All other applications developed to operate over Category 7 or 7A or class C or CA cabling					■

### Guaranteed Category 5e support of IEEE 1000BASE-T (Gigabit Ethernet) application:

Hitachi Cable America Inc.'s Category 5e cables exceed all of the requirements specified by IEEE 8023.ab for support of Gigabit Ethernet (1000BASE-T) operation over twisted-pair cabling. Furthermore, Hitachi Cable guarantees that all of our Category 5e and higher rated cables will support the 1000BASE-T application.

To demonstrate our compliance, Hitachi Cable's products have been extensively tested for IEEE 1000BASE-T throughput at the University of New Hampshire's Interoperability Lab and found to fully support the IEEE 1000BASE-T Gigabit Ethernet application.

<sup>1</sup> Cat 7 Cable standard has not yet been ratified.

<sup>2</sup> Per TSB-155, Category 6 cable may accommodate 10 gigabit Ethernet up to 55 meters in a channel. Mitigation to achieve 55m may be required. Hitachi Cable's 10G-RD™ Enhanced Category 6 provides guaranteed 10 gigabit support up to 100 meters in a channel.

# Applications

## Fiber Applications Matrix

Standard	Wavelength	Transmission	Fiber type	Length (m)
1000BASE-LX	1300nm	Serialized	OM1	550
			OM2	550
			SM	>2,000
1000BASE-SX	850nm	Serialized	OM1	220
			OM2	550
			OM3	>550
10GBASE-SR	850nm	Serialized	OM1	33
			OM2	82
			OM3	300
			OM4	550
10GBASE-LR	1310nm	Serialized	SM	10,000 - 25,000
10GBASE-LRM	1310nm	Serialized	OM1	220
			OM3	260
10GBASE-ER	1550nm	Serialized	SM	40,000
10GBASE-LX4	1300nm	WDM	MM	240-300
			SM	10,000
40GBASE-SR4	850nm	Parallel Optics	OM3	100
			OM4	125
40GBASE-LR4	1310nm	WDM	SM	10,000
100GBASE-SR10	850nm	Parallel Optics	OM3	100
			OM4	125
100GBASE-LR4	1310nm	WDM	SM	10,000
100GBASE-ER4	1310nm	WDM	SM	40,000
Infiniband SDR	850nm	Parallel Optics	OM1	75
			OM2	125
			OM3	200
Infiniband DDR	850nm	Parallel Optics	OM1	50
			OM2	75
			OM3	150
Infiniband 4x-LX	call	call	OS2	10,000
ITU-T G.957 STM-1, -4 & -16	1550nm	WDM	OS2	2,000
ITU-T G.957 STM-1 & -4				15,000
ITU-T G.957 STM-1		Serialized		40,000
Fibre Channel, 2 Gig	850nm	Serialized	OM2	300
			OM3	500
Fibre Channel, 4 Gig	850nm	Serialized	OM2	150
			OM3	270
Fibre Channel 1, 2 & 4 Gig	1300nm	Serialized	OS2	10,000

Application

Reference

# Standards

All of Hitachi Cable America's products are fully compliant to the requirements of applicable national and international structured cabling standards.

**ANSI/TIA-568.O-E “Generic Telecommunications Cabling Standard (2020)”** This standard, in part, supersedes TIA/EIA-568-B.1 and its addenda. This standard incorporates the following standards: TIA/EIA-568-B.1-1, TIA/EIA-568-B.1-2, TIA/EIA-568-B.1-3, TIA/EIA-568-B.1-7, TIA/EIA TSB125, TIA TSB140, TIA TSB153. This document specifies copper and fiber optic cabling requirements and test methods that will support a multi-product, multi-vendor environment.

**ANSI/TIA-568.1-E “Commercial Building Telecommunications Cabling Standard (2020)”** This standard, in part, supersedes TIA/EIA-568-B.1 and its addenda. This standard incorporates content from ANSI/TIA-568-B.1-4, Addendum 4, as well as ANSI/TIA-568-B.1-5, Addendum 5.

**ANSI/TIA-568.2-D “Balanced Twisted Pair Telecommunications Cabling Components Standard (2018)”** This standard supersedes ANSI/TIA/EIA-568B.2. This document specifies the performance of copper cables, patch cords, and connectors, in addition to the transmission, system models, and the measurement procedures needed for verification of balanced twisted pair cabling performance. This standard incorporates content from the following ANSI/TIA/EIA standards: 568-B.2, 568-B.2-1, 568-B.2-2, 568-B.2-3, 568-B.2-4, 568-B.2-5, 568-B.2-6 and ANSI/TIA standards 568-B.2-7, 568-B.2-9, 568-B.2-10 and 568-B.2-11.

**ANSI/TIA-568.3-D “Optical Fiber Cabling Components Standard (2016)”** This document specifies the performance of the cables, patch cords, and connector used in fiber optic cable systems. This standard replaces ANSI/TIA/EIA-568-B.3 and ANSI/TIA/EIA-568-B.3-1.

**ANSI/TIA-569-D “Commercial Building Standard for Telecommunications Pathways and Spaces (2019)”** This document describes recognized cabling locations both within and between buildings. Included are the pathways in which telecommunications media are placed and the rooms and areas associated with the building used to terminate media and install telecommunications equipment.

**ANSI/TIA-570-D “Residential Telecommunications Cabling Standard (2018)”** The purpose of this document is to standardize requirements for residential telecommunications cabling. The requirements are intended to be implemented for new construction, additions and remodeled single and multi-tenant residential buildings.

**ANSI/TIA-606-C “Administration Standard for Commercial Telecommunications Infrastructure (2017)”**

This standard provides guidelines and choices of classes of administration for maintaining telecommunications infrastructure.

**ANSI/TIA-607-D “Commercial Building Grounding (Earthing) and Bonding Requirements for Telecommunications (2019)”** This purpose of this standard is to enable the planning, design, and installation of telecommunications grounding and bonding systems within a building with or without prior knowledge of the telecommunications systems that will subsequently be installed.

**ANSI/TIA-758-B “Customer-Owned Outside Plant Telecommunications Infrastructure (2012)”** This standard provides requirements used in the design of the cabling, pathways and spaces used between buildings or points in a customer-owned campus environment.

**ANSI/TIA-862-B “Structured Cabling Initiative Standard for Intelligent Building Systems (2016)”** This standard specifies a generic cabling system for building automation systems (BAS) used in commercial systems.

**ISO/IEC 11801, 2nd edition “Generic cabling for Customer Premises (2002)”** This standard is the international counterpart to the TIA/EIA-568 family of standards. It contains requirements for balanced twisted-pair and fiber optic components and cabling systems.

**TSB 155 “Guidelines for the Assessment of Mitigation of Installed Category 6 Cabling to Support 10GBASE-T”** This document specifies the requirements for Category 6 UTP and Sctp (FTP) in regards to accommodating 10GBASE-T Ethernet.

**ANSI/TIA-942-B “Telecommunications Infrastructure Standard for Data Centers”(2017)** This standard establishes the minimum requirements for telecommunications infrastructure associated with data centers and computer rooms.

**ANSI/TIA-1005-A “Telecommunications Infrastructure Standard for Industrial Premises”(2012)** This standard specifies infrastructure requirements within and between industrial buildings.



# Configurations

## Channel Configuration

The channel test configuration is to be used by system designers and users of data communications systems to verify the performance of the overall channel. The channel includes up to 90 m (295 ft) of horizontal cable, a work area equipment cord, a telecommunications outlet/connector, an optional transition/consolidation connector, and two connections in the telecommunications room. The total length of equipment cords, patch cords or jumpers and work area cords shall not exceed 10 m (33 ft). Note that the connections to the equipment at each end of the channel are not included in the channel definition.

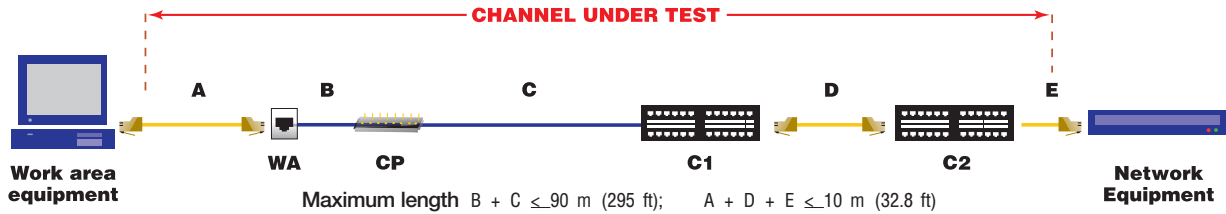

## Permanent Link

The permanent link test configuration is to be used by installers and users of data telecommunications systems to verify the performance of permanently installed cabling. The permanent link consists of up to 90 m (295 ft) of horizontal cabling and one connection at each end and may also include an optional transition/consolidation point connection. Note that the permanent link excludes both the cable portion of the field test instrument cord and the connection to the field test instrument.

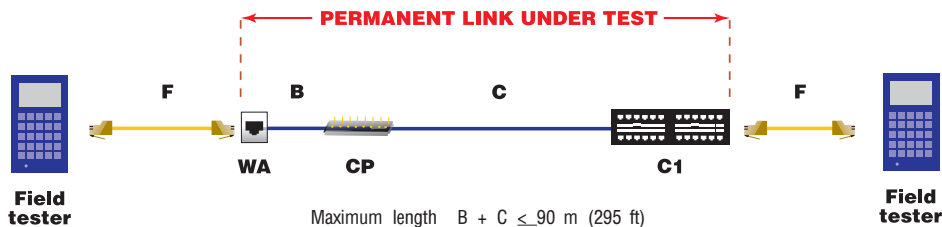

### Cables and cords

- A = Work area cord
- B = Optional transition cabling
- C = Horizontal cabling
- D = Patch cord or jumper cable
- E = Telecommunications room equipment cord
- F = Test equipment cord

### Connecting Hardware

- WA = Telecommunications outlet/connector
- CP = Optional transition/consolidation point connector
- C1, C2 = Horizontal cross-connect or interconnect

## Recommended Backbone Fiber Lengths

The table below is for network design purposes and can be used for establishing the maximum fiber optic cable lengths based on the fiber optic glass type and the maximum data rate at that distance. The maximum lengths are guidelines only. The number of fiber optic strands used and the type of electronics and their transmit speeds will determine the actual maximum performance length.

Backbone Fiber Type	Recommended Backbone Maximum Length	Maximum Data Rates
OM1	2000 m (6562 ft.)	155 Mb/s
OM2	550 m (1804 ft.)	1 GB/s
OM3	300 m (984 ft.)	10 GB/s, 100 GB/s
OM4	550 m (1804 ft.)	10 GB/s, 100 GB/s
OS2	10,000 m (32,808 ft.)	100 GB/s

# Glossary

## Acronyms & Abbreviations

ACR: Attenuation-to-crosstalk ratio  
ACRF: Attenuation-to-crosstalk ratio far-end  
ANSI: American National Standards Institute  
ASTM: American Society for Testing and Materials  
ATM: asynchronous transfer mode  
AWG: American Wire Gauge  
BELLCORE: Bell Communications Research  
BICSI: Building Industry Consulting Services International  
CATV: community antenna television  
EIA: Electronic Industries Alliance  
ELFEXT: equal level far-end crosstalk  
EMC: electromagnetic compatibility  
EMI: electromagnetic interference  
FCC: Federal Communications Commission  
FDDI: fiber distributed data interface  
FEXT: far-end crosstalk  
FOCIS: Fiber Optic Connector Intermateability Standard  
F/UTP: foil over unshielded twisted pairs  
IEC: International Electrotechnical Commission  
IEEE: The Institute of Electrical and Electronics Engineers  
ILD: Insertion loss deviation  
LCL: Longitudinal conversion loss  
LCTL: Longitudinal conversion transfer loss  
ISDN: integrated services digital network  
ISO: International Organization for Standardization  
LAN: local area network  
LED: light emitting diode  
Mb/s: megabits per second  
MUTOA: multi-user telecommunications outlet assembly  
NEC®: National Electrical Code®  
NEMA: National Electrical Manufacturers Association  
NESC®: National Electrical Safety Code®  
NEXT: near-end crosstalk  
NFPA: National Fire Protection Association  
NVP: nominal velocity of propagation  
PSACR: power sum attenuation-to-crosstalk ratio  
PSACRF: power sum attenuation-to-crosstalk ratio far-end  
PSELFEXT: power sum equal level far-end crosstalk  
PSFEXT: power sum far-end crosstalk  
PSNEXT: power sum near-end crosstalk  
SFTP: braided shield over pairs in foil  
STP: shielded twisted-pair  
TIA: Telecommunications Industry Association  
TSB: Telecommunications System Bulletin  
UL: Underwriters Laboratories  
UTP: unshielded twisted-pair

**adapter (copper):** A device that enables any or all of the following: (1) different sizes or types of plugs to mate with one another or to fit into a telecommunications outlet, (2) the rearrangement of leads, (3) large cables with numerous wires to fan out into smaller groups of wires, and (4) interconnection between cables.

**adapter (fiber optic):** optical fiber duplex: A mechanical device designed to align and join two duplex optical fiber connectors (plugs) to form an optical duplex connection.

**administration:**  
The method for labeling, identification, documentation and usage needed to implement moves, additions and changes of the telecommunications infrastructure.

**attenuation:**  
(see insertion loss)

**attenuation-to-crosstalk ratio:** A ratio, expressed in dB, determined by subtracting the insertion loss from the near-end crosstalk loss.

**attenuation-to-crosstalk ratio far-end:** replaces ELFEXT. A measure of the unwanted signal coupling from a transmitter at the near-end into another pair measured at the far-end, and relative to the received signal level.

**backbone cable:**  
A cable that runs between telecommunications rooms, or floor distribution terminals, the entrance facilities, and the equipment rooms within or between buildings.

**balance:** Balance is the ratio of the differential signal output at either end of any pair to a common mode signal input, at either end of the same or a different pair, and vice versa, under specified termination conditions.

**bonding:** The permanent joining of metallic parts to form an electrically conductive path that will assure electrical continuity and the capacity to conduct safely any current likely to be imposed on it.

**bundled cable:**  
An assembly of two or more cables continuously bound together to form a single unit.

**cable:** An assembly of one or more insulated conductors or optical fibers, within an enveloping sheath.

**cable run:** A length of installed media, which may include other components along its path.

**cable sheath:**  
A covering over the optical fiber or conductor assembly that may include one or more metallic members, strength members, or jackets.

**cabling:** A combination of all cables, jumpers, cords, and connecting hardware.

**campus:** The buildings and grounds having legal contiguous interconnection.

**centralized cabling:**  
A cabling configuration from the work area to a centralized cross-connect using pull through cables, an interconnect, or splice in the telecommunications room.

**channel:** The end-to-end transmission path between two points at which application-specific equipment is connected.

**connecting hardware:** A device providing mechanical cable terminations.

**connector, small form factor:** An optical fiber duplex connector with a size approximating that of an 8-position modular outlet/connector typically used for terminating 4-pair copper cable.

**cord (telecommunications):** A cable using stranded conductors for flexibility, as in distribution cords or line cords.

**cross-connect:**  
A facility enabling the termination of cable elements and their interconnection or cross-connection.

**cross-connection:**  
A connection scheme between cabling runs, subsystems, and equipment using patch cords or jumpers that attach to connecting hardware on each end.

# Glossary

**decibels (dB):**

A logarithmic unit that is used to describe a wide range of differences in signal voltage or power levels.

**delay skew:** The difference in propagation delay between any two pairs within the same cable sheath.

**demarcation point:**

A point where the operational control or ownership changes.

**drain wire:** A non-insulated conductor placed in electrical contact with a shield.

**electromagnetic interference:** Radiated or conducted electromagnetic energy that has an undesirable effect on electronic equipment or signal transmissions.

**entrance facility (telecommunications):** An entrance to a building for both public and private network service cables (including wireless) including the entrance point of the building and continuing to the entrance room or space.

**entrance point (telecommunications):** The point of emergence for telecommunications cabling through an exterior wall, a floor, or from a conduit.

**entrance room**

**or space (telecommunications):** A space in which the joining of inter or intra building telecommunications backbone facilities takes place.

**equal level far-end crosstalk: (obsolete)**

A measure of the unwanted signal coupling from a transmitter at the near-end into another pair measured at the far-end, and relative to the received signal level.

**equipment cable, cord:** A cable or cable assembly used to connect telecommunications equipment to horizontal or backbone cabling.

**equipment room (telecommunications):** An environmentally controlled centralized space for telecommunications equipment that usually houses a main or intermediate cross-connect.

**far-end crosstalk loss:** A measure of the unwanted signal coupling from a transmitter at the near end into another pair measured at the far end.

**fiber optic:** See optical fiber.

**ground:** A conducting connection, whether intentional or accidental, between an electrical circuit (e.g., telecommunications) or equipment and the earth, or to some conducting body that serves in place of earth.

**high-order mode transient losses:**

Losses in power caused by the attenuation in the cladding of multimode optical fiber.

**horizontal cabling:** (1)The cabling between and including the telecommunications outlet/connector and the horizontal cross-connect. (2) The cabling between and including the building automation system outlet or the first mechanical termination of the horizontal connection point and the horizontal cross-connect.

**horizontal cross-connect:** A cross-connect of horizontal cabling to other cabling, e.g., horizontal, backbone, and equipment.

**hybrid cable:** An assembly of two or more cables, of the same or different types or categories, covered by one overall sheath.

**hybrid optical fiber cable:** An optical fiber cable containing two or more fiber types (e.g., multimode and singlemode).

**infrastructure (telecommunications):** A collection of those telecommunications components, excluding equipment, that together provide the basic support for the distribution of all information within a building or campus.

**insertion loss:** The signal loss resulting from the insertion of a component, or link, or channel, between a transmitter and receiver.

**insertion loss deviation:** The difference between the actual insertion loss as measured on a permanent link or channel and the insertion loss as determined by adding the component losses.

**interconnection:**

A connection scheme that employs connecting hardware for the direct connection of a cable to another cable without a patch cord or jumper.

**intermediate**

**cross-connect:** A cross-connect between first level and second level backbone cabling.

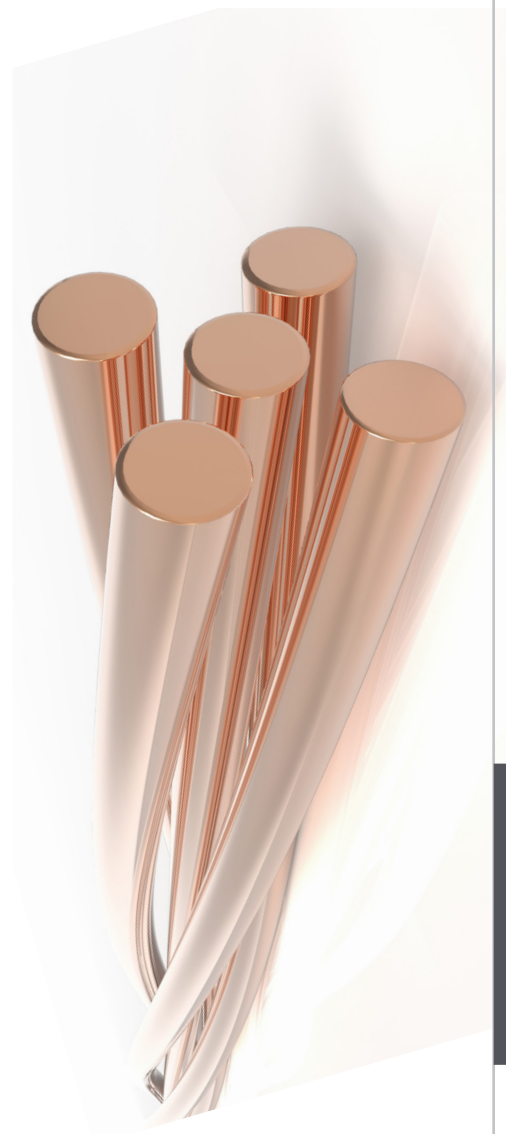

# Glossary

## **intra**building telecommunications

**backbone:** A pathway or cable facility for interconnecting telecommunications service entrance rooms, equipment rooms, or telecommunications rooms within a building.

**jumper:** An assembly of twisted-pairs without connectors, used to join telecommunications circuits/links at the cross-connect.

**keying:** The mechanical feature of a connector system that guarantees correct orientation of a connection, or prevents the connection to a jack, or to an optical fiber adapter of the same type intended for another purpose.

**link:** A transmission path between two points, not including terminal equipment, work area cables, and equipment cables.

**longitudinal conversion loss:** A ratio, expressed in dB, of measured differential voltage relative to the common mode voltage on a conductor pair applied at the same end.

**longitudinal conversion transfer loss:** A ratio, expressed in dB, of measured differential voltage at one end of a conductor pair relative to the common mode voltage applied on any pair at the opposite end or on any other pair on the same end.

**main cross-connect:** A cross-connect for first level backbone cables, entrance cables, and equipment cables.

**main terminal space:** The location of the cross-connect point of incoming cables from the telecommunications external network and the premises cable system.

**megabits per second (Mbps):** An application dependent specification describing the number of discrete bits of information (i.e. a "1" or a "0") transmitted per second.

**megahertz (MHz):** Transmitted signal frequency described as the number of millions of sinusoidal signal cycles per second.

**mode:** A path of light in an optical fiber.

**modular jack:** A female telecommunications

connector that may be keyed or unkeyed and may have 6 or 8 contact positions, but not all the positions need be equipped with jack contacts.

## **modular plug cord:**

A length of cable with a modular plug on both ends.

**multimode optical fiber:** An optical fiber that carries many paths of light.

## **multipair cable:**

A cable having more than four pairs.

**multi-user telecommunications outlet assembly:** A grouping in one location of several telecommunications outlet/connectors.

**open office:** A floor space division provided by furniture, moveable partitions, or other means instead of by building walls.

**optical fiber:** Any filament made of dielectric materials that guides light.

## **optical fiber cable:**

An assembly consisting of one or more optical fibers.

**optical fiber duplex connection:** A mated assembly of two duplex connectors and a duplex adapter.

## **outlet/connector (telecommunications):**

A connecting device in the work area on which horizontal cable or outlet cable terminates.

**patch cord:** A length of cable with a plug on one or both ends.

**patch panel:** A connecting hardware system that facilitates cable termination and cabling administration using patch cords.

**pathway:** A facility for the placement of telecommunications cable.

**permanent link:** A test configuration for a link excluding test cords and patch cords.

**plenum:** A compartment or chamber to which one or more air ducts are connected and that forms part of the air distribution system.

**power sum attenuation-to-crosstalk ratio:** A ratio, expressed in dB, determined by subtracting the insertion loss from the power sum near-end crosstalk loss.

**power sum attenuation-to-crosstalk ratio far-end:** replaces PSELFEXT. A computation of the unwanted signal coupling from multiple transmitters at the near-end into a pair measured at the far-end, and normalized to the received signal level.

**power sum equal level far-end crosstalk:(obsolete)** A computation of the unwanted signal coupling from multiple transmitters at the near-end into a pair measured at the far-end, and normalized to the received signal level.

**power sum near-end crosstalk loss:** A computation of the unwanted signal coupling from multiple transmitters at the far-end into a pair measured at the near-end

**propagation delay:** The time required for a signal to travel from one end of the transmission path to the other end.

**return loss:** A ratio expressed in dB of the power of the outgoing signal to the power of the reflected signal.

**ROOM (telecommunications):** An enclosed space for housing telecommunications equipment, cable terminations, and cross-connect cabling, that is the recognized location of the horizontal cross-connect.

**screen:** An element of a cable formed by a shield.

**screened twisted-pair (SCTP):** A balanced cable with an overall screen.

**shield:** A metallic layer placed around a conductor or group of conductors.

**singlemode optical fiber:** An optical fiber that carries only one path of light.

**splice:** A joining of conductors in a splice closure, meant to be permanent.

**splice closure:** A device used to protect a splice.

**star topology:** A topology in which telecommunications cables are distributed from a central point.

**telecommunications:** Any transmission, emission, and reception of signs, signals, writings, images, and sounds, that is information of any nature by cable, radio, optical, or other electromagnetic systems.

**topology:** The physical or logical arrangement of a telecommunications system.

# Glossary

**transfer impedance:** A measure of shielding performance determined by the ratio of the voltage on the conductors enclosed by a shield to the surface currents on the outside of the shield.

**transition point:**

A location in the horizontal cabling where flat undercarpet cable connects to round cable.

**work area (work station):** A building space where the occupants interact with telecommunications terminal equipment.

**work area cable (cord):** A cable connecting the telecommunications outlet/connector to the terminal equipment.

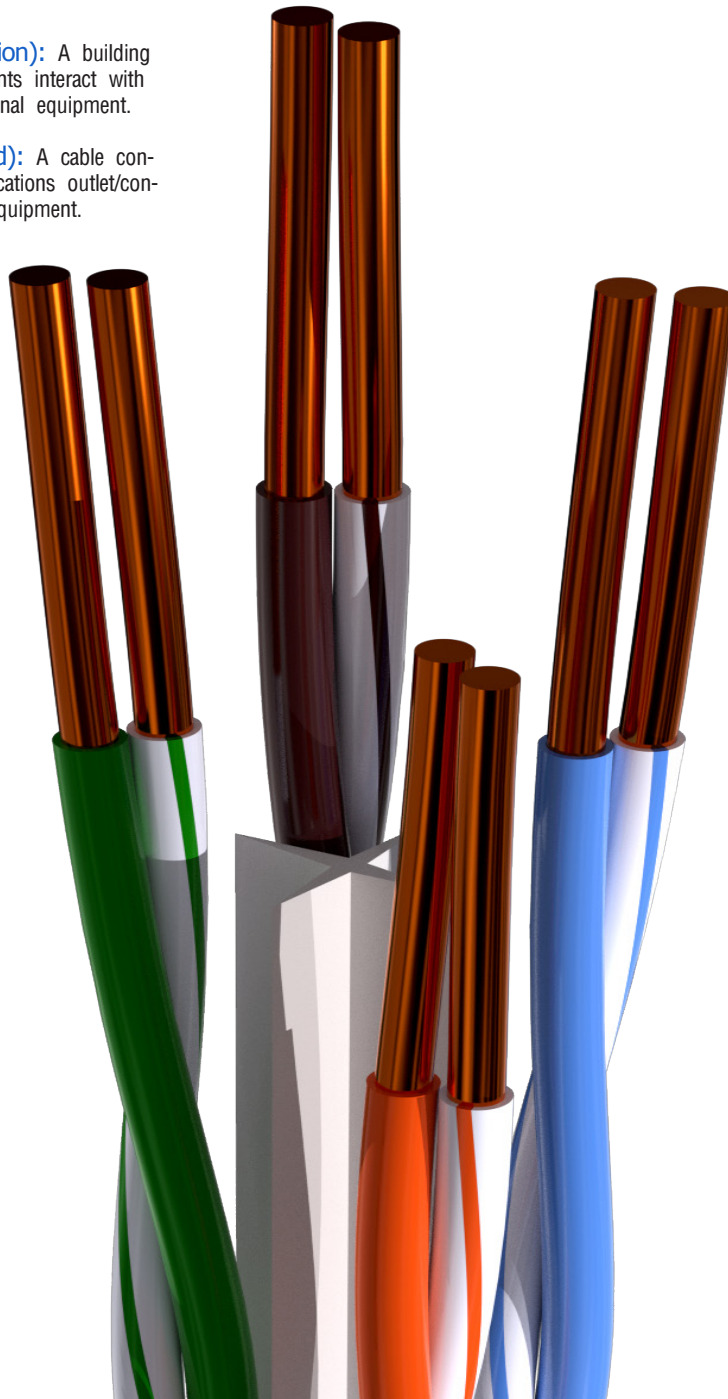

## Units of Measure

°C	degrees Celsius
°F	degrees Fahrenheit
dB	decibel
ft	foot
GHz	gigahertz
in	inch
km	kilometer
lbf	pound force
m	meter
MHz	megahertz
mm	millimeter
N	newton
nm	nanometer
ns	nanosecond
V <sub>rms</sub>	volts root mean square
µm	micron or micrometer

## Conversion Table

### English to Metric

	Multiply by:
from inches to centimeters	2.54
from feet to meters	0.3048
from yards to meters	0.9144
from ounces to grams	28.3495
from pounds to kilograms	0.453592
from Fahrenheit (F) to Celsius (C)	C=(F-32) x 0.555

# Part # Finder

## Fiber

Part #	Page #	Part #	Page #	Part #	Page #	Part #	Page #	Part #	Page #	Part #	Page #
60001	58	60090	94	60502	56	61444	56	61792	58	61988	58
60002	58	60098	98	60514	58 & 64	61457	56	61793	58	62016	86
60003	58	60102	96*	60515	64	61459	88	61838	58	62017	86
60004	58	60258	66	60516	64	61460	88	61842	58 & 64	62018	86
60005	58	60288	58	60517	62	61464	88	61844	58	62019	86
60006	68	60289	58	60518	62	61468	88	61851	56	62029	60
60007	58	60316	56	60520	64	61480	88	61852	56	62066	88
60008	56	60376	58	60522	62	61483	58	61853	56	62068	92
60009	68	60405	84	60567	68	61486	86	61854	56	62124	60
60010	58	60425	58	60581	68	61495	90	61855	56 & 62	62125	60
60011	58	60430	56	60595	68	61497	98	61857	56	62126	60
60012	58 & 64	60431	56	60596	66	61506	70	61865	64	62127	60
60014	64	60432	56	60598	66	61507	70	61868	62	62129	60
60015	68	60462	58	60613	68	61522	90	61872	68	62130	60
60022	56	60463	58 & 64	60614	66	61523	90	61874	68	62131	60
60023	56	60464	58	60633	68	61524	90	61877	66	62132	60
60024	56 & 62	60465	58	60634	66	61537	70	61879	66	62133	60
60026	56 & 62	60466	58	60937	96	61538	70	61882	70	62135	60
60027	66	60467	58	60943	94	61539	70	61883	70	62136	60
60028	66	60468	56	61319	84	61540	86	61893	90	62137	60
60029	62	60469	56	61337	84	61541	86	61894	88	62138	60
60030	56	60470	56	61345	90	61542	86	61896	86	62139	60
60031	56 & 62	60471	56	61347	90	61546	70	61897	84	62141	60
60033	66	60471	62	61348	90	61547	70	61898	90	62142	60
60037	58	60472	56	61349	90	61577	92	61899	90	62143	60
60038	58	60473	56	61363	90	61578	92	61908	94	62144	60
60039	58	60474	56	61376	90	61579	92	61912	96	62145	60
60040	58	60475	56	61378	56	61580	92	61941	72	62147	60
60042	56	60489	58	61379	56	61631	72	61956	88	62148	60
60044	56	60490	56	61380	90	61632	72	61959	88	62149	60
60063	58 & 64	60491	56	61415	90	61769	60	61979	88	62150	60
60086	94	60492	56	61421	86	61772	72	61980	88	62151	60
60088	94	60501	58	61433	84	61791	58	61986	56	62153	60

## Fiber

Part #	Page #	Part #	Page #	Part #	Page #	Part #	Page #	Part #	Page #	Part #	Page #
62154	60	62295	76	62544	74	62711	70	62749	70	63123	78
62155	60	62296	76	62545	74	62712	70	62750	70	63124	78
62156	60	62323	76	62546	74	62715	70	62751	70	63125	78
62157	60	62332	70	62547	74	62716	72	62752	70	63126	78
62178	88	62333	70	62549	74	62720	58	62753	70	63127	78
62179	88	62335	70	62593	74	62721	58	62754	76	63128	78
62180	88	62336	70	62594	74	62722	58	62756	80	63131	78
62181	88	62337	78	62595	74	62723	58	62766	90	63132	78
62183	84	62338	72	62596	74	62724	58 & 64	62767	90	63133	78
62184	84	62352	82	62598	74	62725	58	62768	90	63134	78
62185	84	62353	82	62650	74	62726	58	62769	88	63135	78
62186	84	62354	82	62668	74	62727	60	62770	88	63136	78
62187	84	62355	82	62675	70	62728	60	62771	88	63137	78
62205	74	62356	82	62676	70	62729	60	62772	92	63141	78
62214	74	62371	70	62678	70	62730	60	62774	94	63142	78
62216	74	62372	70	62683	70	62731	60	62811	86	63143	78
62218	74	62373	70	62684	70	62732	60	62812	86	63144	78
62220	74	62374	70	62685	70	62733	60	62813	84	63145	78
62239	70	62375	70	62686	70	62734	56	62814	84	63146	78
62241	70	62424	72	62688	70	62735	56	62821	82	63147	78
62242	70	62425	72	62689	70	62736	56	62941	74	63151	78
62243	70	62426	72	62692	70	62737	56	62950	56	63152	78
62244	70	62427	72	62693	70	62738	56 & 62	62951	56	63153	78
62251	80	62429	72	62694	70	62739	56	62953	56	63154	78
62255	80	62431	70	62695	70	62740	56	62954	56	63155	78
62257	80	62449	70	62697	70	62741	64	62956	56	63156	78
62274	60	62450	70	62698	70	62742	62	62957	60	63157	78
62275	60	62460	70	62701	72	62743	68	62958	60	63161	78
62276	60	62489	70	62702	72	62744	68	62959	60	63162	78
62277	60	62490	70	62703	72	62745	66	62960	60	63163	78
62285	80	62491	70	62704	72	62746	66	62962	60	63164	78
62286	80	62492	70	62706	72	62747	72	62963	60	63166	78
62294	76	62494	70	62707	72	62748	72	63122	78	63167	78

# Part # Finder

## Power+™ Composite

Part #	Page #	Part #	Page #
62352	98	62876	98
62657	98	62877	98
62859	98	62878	98
62860	98	62879	98
62861	98	62880	98
62862	98	62881	98
62863	98	62882	98
62864	98	62883	98
62865	98	62884	98
62866	98	62885	98
62867	98	62886	98
62868	98	62887	98
62869	98	62888	98
62870	98	62889	98
62871	98	62890	98
62872	98	62891	98
62873	98	62892	98
62874	98	62893	98
62875	98	62894	98

## Copper

Part #	Page #	Part #	Page #
30016	16	30287	48
30022	16	30295	10
30024	20	30303	10
30025	20	30304	10
30093	38	30305	34
30129	24	30309	22
30134	40	30310	30
30145	52	30315	44
30154	24	30319	36
30172	38	30322	42
30180	50	30323	42
30183	18	30327	14
30203	38	30348	46
30212	18	38653	32
30233	12	38696	26
30234	12	38891	28
30237	22	38893	28
30238	22	39092	32
30245	36	39228	40
30250	34	39419	26
30277	44		



# How to Build an Hitachi Part Number

Section 1	Section 2	Section 3	Section 4
30327-8	8	BL	2
Base Part Number	Number of Conductors	Jacket Color	Put-Up Type

Part number 30327-8-BL2 is a Category 6A, plenum rated 4-pair cable with a blue jacket and packaged in a reelex-box.  
 Note: Some cable constructions may require additional information when ordering.

### Jacket Color Abbreviations

Black	BK
Blue	BL
Brown	BR
Gray	GA
Green	GR
Red	RD
White	WH
Yellow	YE
Erika Violet	EV
Aqua	AQ
Violet	VI

### Put-Up Code

Reelex-Boxes	2
Reel	3
Reel-In-A-Box	4



Reel-In-A-Box.



Reel.



Reelex-box.

# Notes

Reference

# Installation

## Conduit Fill Chart

Conduit Size	1/2"	3/4"	1"	1-1/4"	1-1/2"	2"	2-1/2"	3"	3-1/2"	4"
40% Int. Area	0.121"	0.213"	.345"	.598"	.814"	1.342"	2.343"	3.538"	4.618"	5.901"
Cable Diameter	0.19"	4	7	12	21	28	47	82	124	208
	0.2"	4	6	11	19	26	42	74	112	188
	0.21"	3	6	10	17	23	38	67	102	170
	0.22"	3	5	9	15	21	35	61	93	155
	0.23"	3	5	8	14	19	32	56	85	142
	0.24"	2	4	7	13	18	29	51	78	130
	0.25"	2	4	7	12	16	27	47	72	120
	0.26"	1	4	6	11	15	25	44	66	111
	0.27"	1	3	6	10	14	23	41	61	103
	0.28"	1	3	5	9	13	21	38	57	96
	0.29"	1	3	5	9	12	20	35	53	89
	0.3"	1	3	5	8	11	19	33	50	83
	0.31"	1	3	4	8	10	17	31	47	78
	0.32"	1	2	4	7	10	16	29	44	73
	0.33"	1	2	4	7	9	15	27	41	69
0.34"	1	2	4	6	9	14	26	39	65	
0.35"	1	1	3	6	8	14	24	36	48	61

The above conduit fill chart is for reference only. The conduit capacity is based on the National Electrical Code requirement of 40% maximum fill. To determine the maximum conduit fill for cable O.D.s other than those referenced above, use the following steps: 1. Square the O.D. of the cable. 2. Multiply the result by .7854. This is the total area of the cable. 3. Multiply the total area of the cable by the number of cables you wish to place in the conduit. This is the total area of the cable bundle. Determine the appropriate conduit size by referencing the 40% Interior Area row.

## Cable Ampacity

The table below is derived from one approved by the National Fire Protection Agency for use in the next edition of the National Electrical Code known as NFPA-70. The complete table will be found in section 725.144 of the code. It will also be referenced in Article 800 Communication Circuits. The table identifies the ampacity of each conductor (in Amperes) in a 4-pair Class 2 or Class 3 data cable. Ambient temperature used for development of the table is 30°C (86°F) with all conductors in all cables carrying current. The table is based on 60°C (140°F), 75°C (167°F) and 90°C (194°F) rated cables.

AWG	Number of 4-Pair Cables in a Bundle																				
	1			2-7			8-19			20-37			38-61			62-91			92-192		
	Temp Rating			Temp Rating			Temp Rating			Temp Rating			Temp Rating			Temp Rating					
	60°C	75°C	90°C	60°C	75°C	90°C	60°C	75°C	90°C	60°C	75°C	90°C	60°C	75°C	90°C	60°C	75°C	90°C	60°C	75°C	90°C
24	2.0	2.0	2.0	1.0	1.4	1.6	0.8	1.0	1.1	0.6	0.7	0.9	0.5	0.6	0.7	0.4	0.5	0.6	0.3	0.4	0.5
23	2.5	2.5	2.5	1.2	1.5	1.7	0.8	1.1	1.2	0.6	0.8	0.9	0.5	0.7	0.8	0.5	0.7	0.8	0.4	0.5	0.6
22	3.0	3.0	3.0	1.4	1.8	2.1	1.0	1.2	1.4	0.7	0.9	1.1	0.6	0.8	0.9	0.6	0.7	0.8	0.5	0.6	0.7

### Product Performance Guarantee

All goods sold are warranted to be free from defects in material and workmanship on the date of delivery of the materials to the F.O.B. point stated. Seller makes no representation or warranty of any kind, expressed or implied with respect to the goods sold hereunder, whether as to merchantability, fitness for particular purpose, or any other matter. Seller's only obligation is to replace goods that are proved defective within one (1) year after the date of delivery, but always provided the product receives normal and proper use, and due care in handling is exercised. If the goods purchased show defects in material or workmanship within one (1) year after date of delivery, Buyer must discontinue use thereof and must properly notify Seller, so that the matter may be investigated and material inspected and examined by the Seller without inference or delay. Contact Hitachi Cable America Inc. for full warranty details.



# WORLDWIDE COVERAGE

**HITACHI**  
Inspire the Next<sup>1</sup>

 **Hitachi Cable America Inc.**

900 Holt Avenue, Manchester, New Hampshire 03109 USA  
Tel: +1-603-669-4347 Fax +1-603-669-9621  
[www.hca.hitachi-cable.com](http://www.hca.hitachi-cable.com)