

Cable Trench System

DataComm Electronics 15" plastic enclosure sections can be used to create a customized Cable Trench System that is designed to help manage the large bundles of bulk wire behind a rack installation. The added feature of a cable passthrough section with multiple cover options gives you more control over your installation.

Features

- Clean, finished look behind the rack
- For residential or commercial applications
- Protects cables from punctures
- Fits within 16" center studs
- Can be any height to fit your installation needs
- Easy re-access to cables
- Flush with the wall
- Modular, customizable and paintable
- Multiple removable cover options
- A la Carte parts available to customize your own Cable Trench
- Service loops and callbacks become more manageable

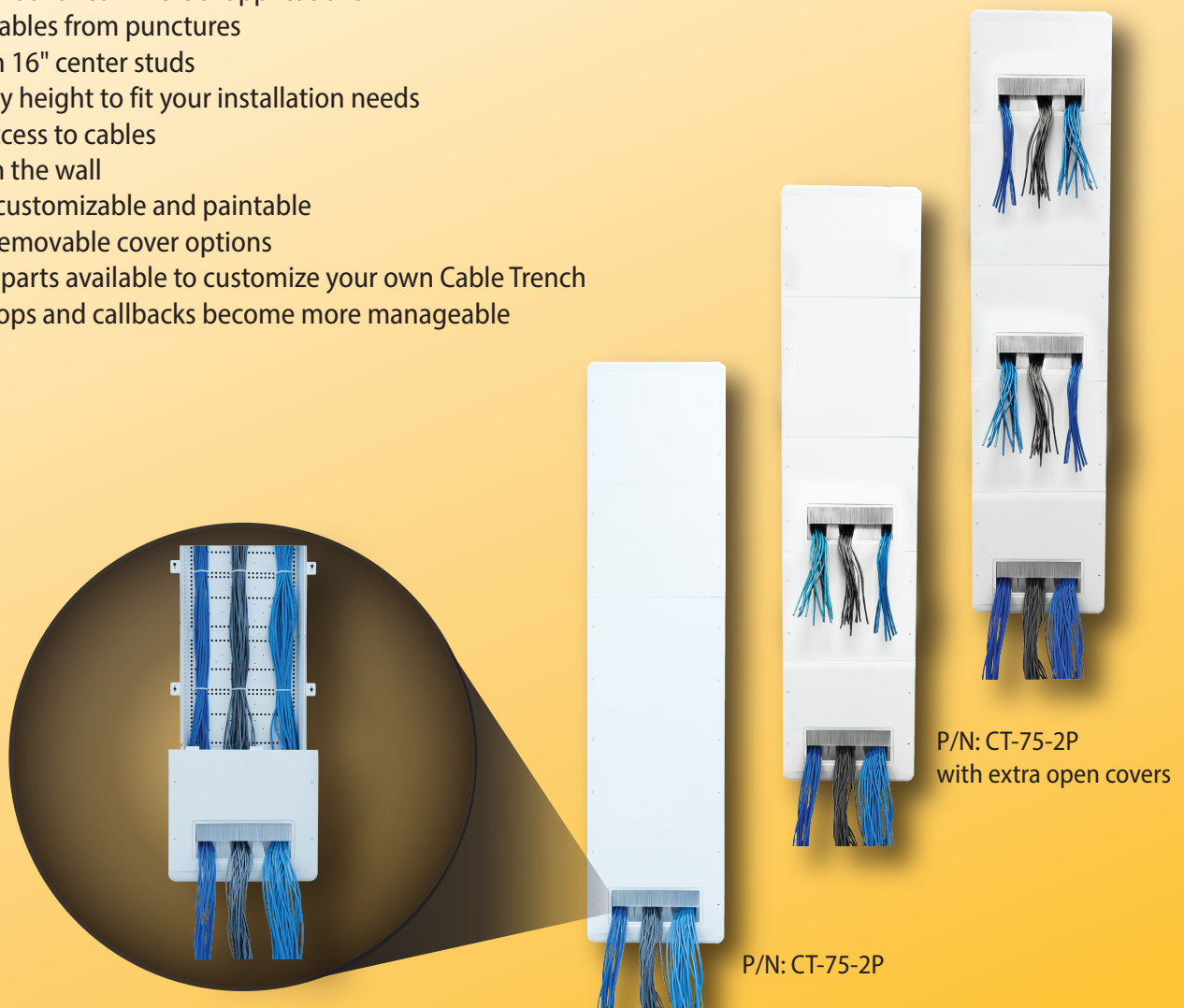

P/N: CT-75-2P

P/N: CT-75-2P
with extra open covers

CT-75-2P

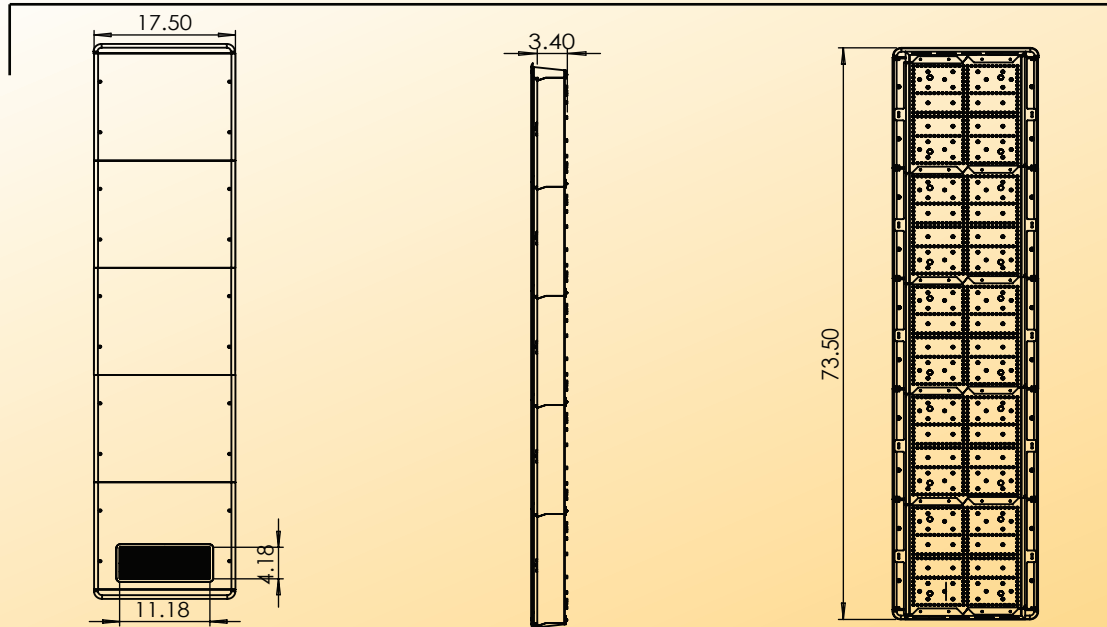

CT-5-SC

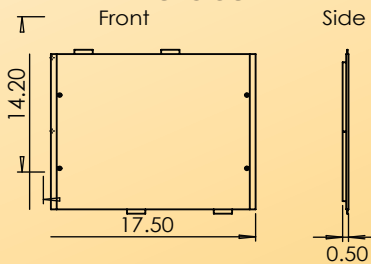

CT-5-BB

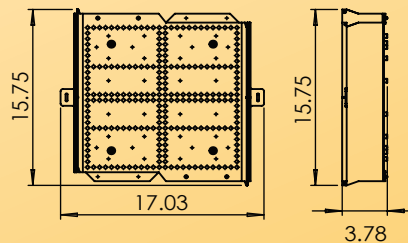

CT-5-TC-BR

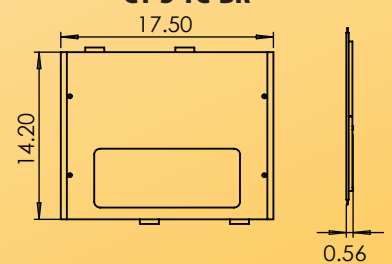

CT-10-CC

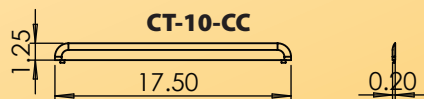

CT-5-END

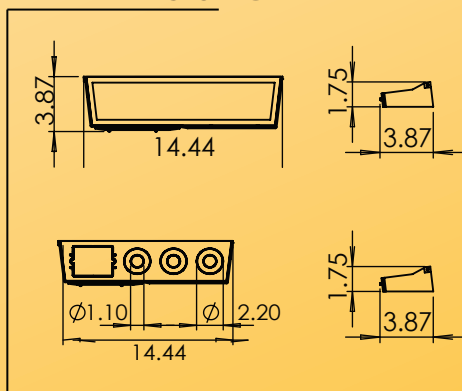

Part Number	Description
CT-75-2P	75" Cable Trench System
CT-5-BB	5 Pack of Unfinished Back Box
CT-5-SC	5 Pack of Unfinished Screw Cover
CT-5-TC-BR	5 Pack of Unfinished Open Cover
CT-5-END	5 Pack of Open End Cap and Knockout End Cap
CT-10-CC	5 Pack of (2) Cover Caps