

CX-ED1689L-4 and CX-ED1799L-8 Low Profile & Dual Monitor 'All in One' Fire Rated Electric Strikes



CX-ED1689L

CX-ED1799L

Camden CX-ED1689L and CX-ED1799L are Grade 1 fire rated "all in one" electric strikes for use with all mortise and cylindrical locksets. Both models include latch monitoring, and are packaged with either 4 or 8 faceplates. Universal performance, with field selectable voltage and fail safe/fail secure operation.

Option for ordering strike bodies and individual faceplates separately. Faceplates also available in black finish.



MORE FLEXIBILITY

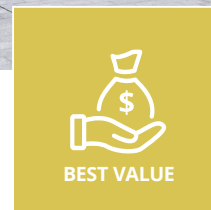

BEST VALUE

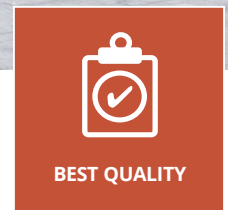

BEST QUALITY

CX-ED1689L-4* low profile strikes are Grade 1 fire rated with (1) latch and strike monitor, additional shim plates in strike cavity.

CX-ED1799L-8** Grade 1 fire rated strikes with dual lock monitors and strike monitor, additional shim plates in strike cavity.

Features

- For mortise and cylindrical locksets
- A range of strike and faceplate packages for latchbolts and deadbolts
- Faceplates also available in black architectural finish (BHMA 622, US19)
- Selectable fail safe / fail secure
- Selectable 12/24V AC/DC
- 1 or 2 latch and deadbolt monitoring switches
- Magnetic door position switch
- Strike power monitor
- Easy fit connectors
- 5 year warranty



DOOR FRAME TYPES

Hollow Metal Frame



Wood Frame

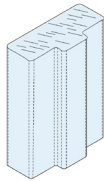

COMPATIBLE LOCKSETS

Cylindrical Lockset

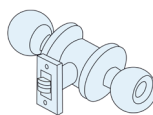

Mortise Locks

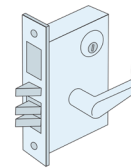

SPECIFICATIONS

VOLTAGE:	12/24V AC/DC
CURRENT DRAW:	300mA @ 12V AC/DC 150mA @ 24V AC/DC
STATIC STRENGTH:	1,500 Lbs.
DYNAMIC STRENGTH:	70 Ft-Lbs.
ENDURANCE:	1,500,000 Cycles (Factory Tested) 250,000 Cycles (UL Verified)
MODE:	Field Selectable Fail Safe/Fail Secure
OPERATION:	AC-Buzz, DC-Silent
DUTY:	Continuous
LOCK MONITOR STATUS:	2 x SPST, 100mA @ 24V DC, Resistive
STRIKE MONITOR STATUS:	SPDT, 100mA @ 24V DC, Resistive
DIMENSIONS (BODY):	CX-ED1689L-4: 4-7/8"H x 1-5/8"W x 1-3/8"D (124mm x 41mm x 36mm) CX-ED1799L-8: 4-7/8"H x 1-5/8"W x 1-21/32"D (124mm x 41mm x 42mm)

ORDERING INFORMATION

STRIKE BODY ONLY



CX-ED1689L
Low Profile Strike Body with
(1) Latch Monitor Switch
(Shown with Faceplate)



CX-ED1799L
Strike Body with
(2) Monitor Switches
(Shown with Faceplate)

FACEPLATE KITS

LOW PROFILE

CX-ED1689L-4

Strike w/ Latch Monitor, (4) Faceplates for Latchbolts
Includes: CX-EMP100, CX-EMP200, CX-EMP300, CX-EMP400

DUAL MONITOR

CX-ED1799L-8

Strike w/ 2 Monitors, (8) Faceplate Package for Latchbolts & Deadbolts
Includes: CX-EMP100, CX-EMP200, CX-EMP300, CX-EMP400, CX-EMP110, CX-EMP210, CX-EMP310, CX-EMP410



FACEPLATES

METAL DOOR FRAME FACEPLATES (ADD '-BK' TO FACEPLATE MODEL NUMBER FOR BLACK FACEPLATE OPTION, BHMA 622, US19)

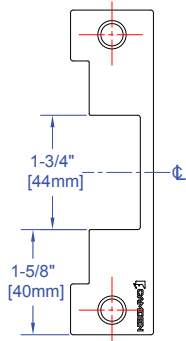

CX-EMP100:

'ANSI' square-metal door frame, center line applications. Compatible with all cylindrical locksets

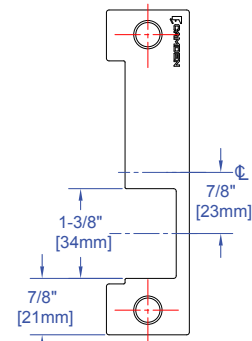

CX-EMP200:

'ANSI' square-metal door frame, Deadlatch positioned above latchbolt. Compatible with Baldwin, PDQ, Marks locksets

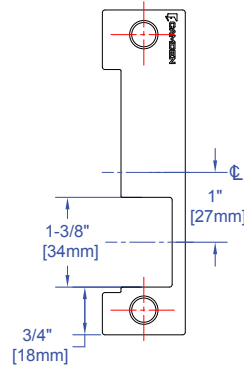

CX-EMP300:

'ANSI' square-metal frame, deadlatch positioned above latch. Compatible with Sargent-8100/7700, Schlage, Yale 8700 locksets

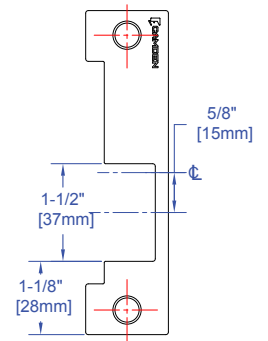

CX-EMP400:

'ANSI' square-metal frame, deadlatch positioned below the latchbolt. Compatible with Corbin Russwin, Falcon, Sargent/7800 locksets

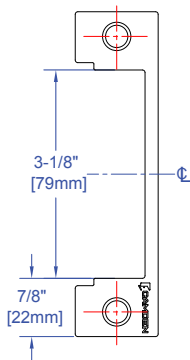

CX-EMP110:

'ANSI' square-metal frame, deadbolt used for night latch function only. Compatible with Marks, Omnia, PDQ, Arrow, Accurate locksets

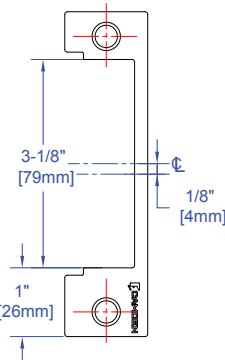

CX-EMP210:

'ANSI' square-metal frame, deadlatch positioned below the latchbolt. Compatible with Corbin Russwin, Best-45/47, Falcon, Sargent-7800/ 8200/ 9200 locksets

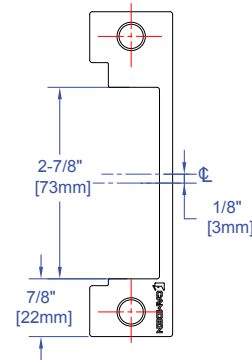

CX-EMP310:

'ANSI' square-metal frame, deadbolt used for night latch function only. Compatible with Sargent-7700/ 8100, Yale 8700 locksets

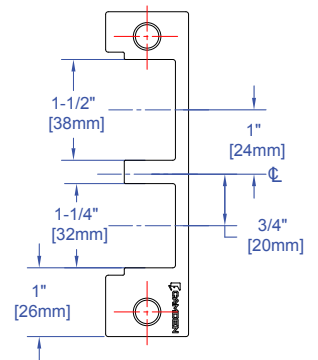

CX-EMP410:

'ANSI' square-metal frame, used for 1\" deadbolt and no latch. Compatible with Marks, Baldwin, Arrow, PDQ, Omnia locksets

WOOD DOOR FRAME FACEPLATES

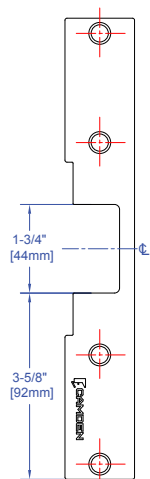

CX-EMP100W:

Wood frames, deadbolt used for night latch function only. Compatible with Marks, Omnia, PDQ, Arrow, Accurate locksets

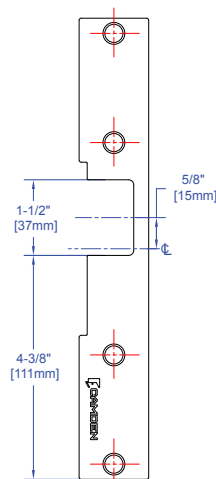

CX-EMP400W:

Wood frames, dead latch positioned above the latch bolt. Compatible with all cylindrical locksets

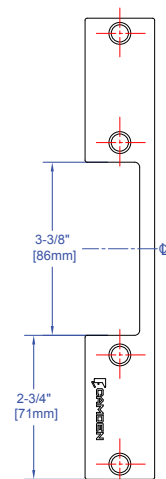

CX-EMP110W:

Wood frames, center line applications. Compatible with all cylindrical locksets



STRIKE DIMENSIONS

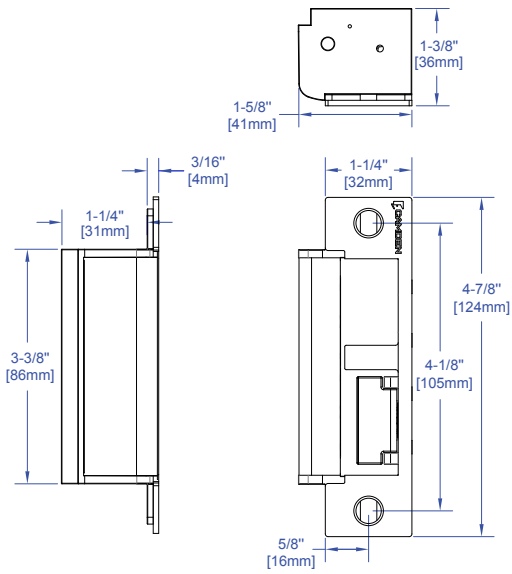

CX-ED1689L-4

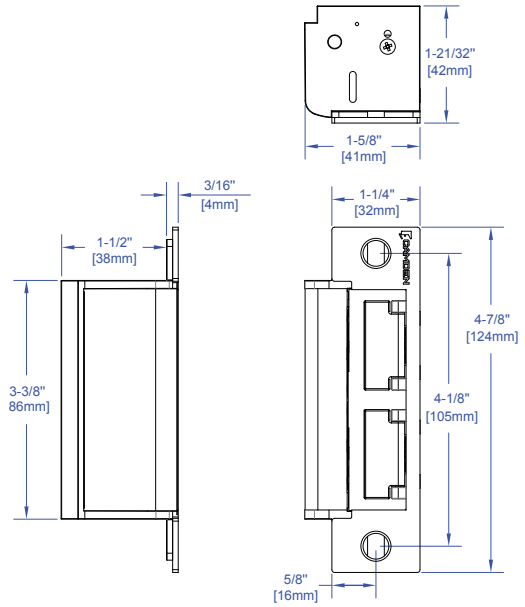

CX-ED1799L-8