

4K/UHD 6 Input Multi-Format Switcher w/Mirrored HDMI and HDBaseT Outputs

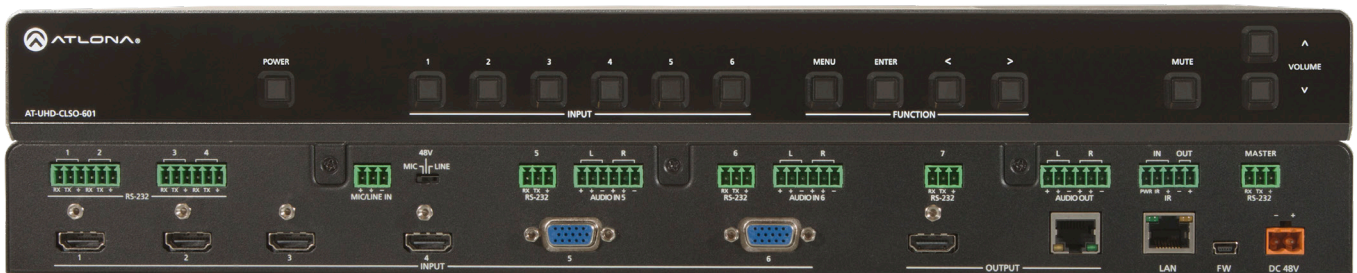

Version Information

Version	Release Date	Notes
1	Oct 2021	Updated to new manual format

Sales, Marketing, and Customer Support

Main Office

Atlona Incorporated
70 Daggett Drive
San Jose, CA 95134
United States

Office: +1.877.536.3976 (US Toll-free)
Office: +1.408.962.0515 (US/International)

Sales and Customer Service Hours
Monday - Friday: 6:00 a.m. - 4:30 p.m. (PST)

<http://atlona.com/>

International Headquarters

Atlona International AG
Tödistrasse 18
8002 Zürich
Switzerland

Office: +41.43.508.4321

Sales and Customer Service Hours
Monday - Friday: 09:00 - 17:00 (UTC +1)

Operating Notes



IMPORTANT: Visit <http://atlona.com/product/AT-UHD-CLSO-601> for the latest firmware updates and User Manual.

Atlona, Inc. (“Atlona”) Limited Product Warranty

Coverage

Atlona warrants its products will substantially perform to their published specifications and will be free from defects in materials and workmanship under normal use, conditions and service.

Under its Limited Product Warranty, Atlona, at its sole discretion, will either:

- repair or facilitate the repair of defective products within a reasonable period of time, restore products to their proper operating condition and return defective products free of any charge for necessary parts, labor and shipping.

OR

- replace and return, free of charge, any defective products with direct replacement or with similar products deemed by Atlona to perform substantially the same function as the original products.

OR

- refund the pro-rated value based on the remaining term of the warranty period, not to exceed MSRP, in cases where products are beyond repair and/or no direct or substantially similar replacement products exist.

Repair, replacement or refund of Atlona products is the purchaser’s exclusive remedy and Atlona liability does not extend to any other damages, incidental, consequential or otherwise.

This Limited Product Warranty extends to the original end-user purchaser of Atlona products and is non-transferrable to any subsequent purchaser(s) or owner(s) of these products.

Coverage Periods

Atlona Limited Product Warranty Period begins on the date of purchase by the end-purchaser. The date contained on the end-purchaser’s sales or delivery receipt is the proof purchase date.

Limited Product Warranty Terms – New Products

- 10 years from proof of purchase date for hardware/electronics products purchased on or after June 1, 2013.
- 3 years from proof of purchase date for hardware/electronics products purchased before June 1, 2013.
- Lifetime Limited Product Warranty for all cable products.

Limited Product Warranty Terms – Refurbished (B-Stock) Products and Discontinued Products

- 3 years from proof of purchase date for all Refurbished (B-Stock) and Discontinued hardware and electronic products purchased on or after June 1, 2013.

Remedy

Atlona recommends that end-purchasers contact their authorized Atlona dealer or reseller from whom they purchased their products. Atlona can also be contacted directly. Visit atlona.com for Atlona’s contact information and hours of operation. Atlona requires that a dated sales or delivery receipt from an authorized dealer, reseller or end-purchaser is provided before Atlona extends its warranty services. Additionally, a return merchandise authorization (RMA) and/or case number, is required to be obtained from Atlona in advance of returns.

Atlona requires that products returned are properly packed, preferably in the original carton, for shipping. Cartons not bearing a return authorization or case number will be refused. Atlona, at its sole discretion, reserves the right to reject any products received without advanced authorization. Authorizations can be requested by calling 1-877-536-3976 (US toll free) or 1-408- 962-0515 (US/international) or via Atlona’s website at atlona.com.

Exclusions

This Limited Product Warranty excludes:

- Damage, deterioration or malfunction caused by any alteration, modification, improper use, neglect, improper packaging or shipping (such claims must be presented to the carrier), lightning, power surges, or other acts of nature.

Atlona, Inc. (“Atlona”) Limited Product Warranty

- Damage, deterioration or malfunction resulting from the installation or removal of this product from any installation, any unauthorized tampering with this product, any repairs attempted by anyone unauthorized by Atlona to make such repairs, or any other cause which does not relate directly to a defect in materials and/or workmanship of this product.
- Equipment enclosures, cables, power supplies, batteries, LCD displays, and any accessories used in conjunction with the product(s).
- Products purchased from unauthorized distributors, dealers, resellers, auction websites and similar unauthorized channels of distribution.

Disclaimers

This Limited Product Warranty does not imply that the electronic components contained within Atlona’s products will not become obsolete nor does it imply Atlona products or their electronic components will remain compatible with any other current product, technology or any future products or technologies in which Atlona’s products may be used in conjunction with. Atlona, at its sole discretion, reserves the right not to extend its warranty offering in instances arising outside its normal course of business including, but not limited to, damage inflicted to its products from acts of god.

Limitation on Liability

The maximum liability of Atlona under this limited product warranty shall not exceed the original Atlona MSRP for its products. To the maximum extent permitted by law, Atlona is not responsible for the direct, special, incidental or consequential damages resulting from any breach of warranty or condition, or under any other legal theory. Some countries, districts or states do not allow the exclusion or limitation of relief, special, incidental, consequential or indirect damages, or the limitation of liability to specified amounts, so the above limitations or exclusions may not apply to you.

Exclusive Remedy

To the maximum extent permitted by law, this limited product warranty and the remedies set forth above are exclusive and in lieu of all other warranties, remedies and conditions, whether oral or written, express or implied. To the maximum extent permitted by law, Atlona specifically disclaims all implied warranties, including, without limitation, warranties of merchantability and fitness for a particular purpose. If Atlona cannot lawfully disclaim or exclude implied warranties under applicable law, then all implied warranties covering its products including warranties of merchantability and fitness for a particular purpose, shall provide to its products under applicable law. If any product to which this limited warranty applies is a “Consumer Product” under the Magnuson-Moss Warranty Act (15 U.S.C.A. §2301, ET SEQ.) or other applicable law, the foregoing disclaimer of implied warranties shall not apply, and all implied warranties on its products, including warranties of merchantability and fitness for the particular purpose, shall apply as provided under applicable law.

Other Conditions

Atlona’s Limited Product Warranty offering gives legal rights, and other rights may apply and vary from country to country or state to state. This limited warranty is void if (i) the label bearing the serial number of products have been removed or defaced, (ii) products are not purchased from an authorized Atlona dealer or reseller. A comprehensive list of Atlona’s authorized distributors, dealers and resellers can be found at atlona.com.

Safety and Certification



CAUTION: TO REDUCE THE RISK OF ELECTRIC SHOCK DO NOT OPEN ENCLOSURE OR EXPOSE TO RAIN OR MOISTURE. NO USER-SERVICEABLE PARTS INSIDE REFER SERVICING TO QUALIFIED SERVICE PERSONNEL.



The exclamation point within an equilateral triangle is intended to alert the user to the presence of important operating and maintenance instructions in the literature accompanying the product.



The information bubble is intended to alert the user to helpful or optional operational instructions in the literature accompanying the product.

1. Read these instructions.
2. Keep these instructions.
3. Heed all warnings.
4. Follow all instructions.
5. Do not use this product near water.
6. Clean only with a dry cloth.
7. Do not block any ventilation openings. Install in accordance with the manufacturer's instructions.
8. Do not install or place this product near any heat sources such as radiators, heat registers, stoves, or other apparatus (including amplifiers) that produce heat.
9. Do not defeat the safety purpose of a polarized or grounding-type plug. A polarized plug has two blades with one wider than the other. A grounding type plug has two blades and a third grounding prong. The wide blade or the third prong are provided for your safety. If the provided plug does not fit into your outlet, consult an electrician for replacement of the obsolete outlet.
10. Protect the power cord from being walked on or pinched particularly at plugs, convenience receptacles, and the point where they exit from the product.
11. Only use attachments/accessories specified by Atlona.
12. To reduce the risk of electric shock and/or damage to this product, never handle or touch this unit or power cord if your hands are wet or damp. Do not expose this product to rain or moisture.
13. Unplug this product during lightning storms or when unused for long periods of time.
14. Refer all servicing to qualified service personnel. Servicing is required when the product has been damaged in any way, such as power-supply cord or plug is damaged, liquid has been spilled or objects have fallen into the product, the product has been exposed to rain or moisture, does not operate normally, or has been dropped.



FCC Compliance

FCC Compliance and Advisory Statement: This hardware device complies with Part 15 of the FCC rules. Operation is subject to the following two conditions: 1) this device may not cause harmful interference, and 2) this device must accept any interference received including interference that may cause undesired operation. This equipment has been tested and found to comply with the limits for a Class A digital device, pursuant to Part 15 of the FCC Rules. These limits are designed to provide reasonable protection against harmful interference in a commercial installation. This equipment generates, uses, and can radiate radio frequency energy and, if not installed or used in accordance with the instructions, may cause harmful interference to radio communications. However there is no guarantee that interference will not occur in a particular installation. If this equipment does cause harmful interference to radio or television reception, which can be determined by turning the equipment off and on, the user is encouraged to try to correct the interference by one or more of the following measures: 1) reorient or relocate the receiving antenna; 2) increase the separation between the equipment and the receiver; 3) connect the equipment to an outlet on a circuit different from that to which the receiver is connected; 4) consult the dealer or an experienced radio/TV technician for help. Any changes or modifications not expressly approved by the party responsible for compliance could void the user's authority to operate the equipment. Where shielded interface cables have been provided with the product or specified additional components or accessories elsewhere defined to be used with the installation of the product, they must be used in order to ensure compliance with FCC regulations.

Copyright, Trademark, and Registration

© 2021 Atlona Inc. All rights reserved. "Atlona" and the Atlona logo are registered trademarks of Atlona Inc. Pricing, specifications and availability subject to change without notice. Actual products, product images, and online product images may vary from images shown here.

HDMI™ The terms HDMI, HDMI High-Definition Multimedia Interface, and the HDMI Logo are trademarks or registered trademarks of HDMI licensing Administrator, Inc.

Dolby, Dolby Atmos, and the double-D symbol are registered trademarks of Dolby Laboratories Licensing Corporation.

For DTS patents, see <http://patents.dts.com>. Manufactured under license from DTS, Inc. DTS, the Symbol, DTS and the Symbol together, and Digital Surround are registered trademarks and/or trademarks of DTS, Inc. in the United States and/or other countries. © DTS, Inc. All Rights Reserved.

All other trademark(s), copyright(s), and registered technologies mentioned(s) in this document are the properties of their respective owner(s).

Table of Contents

Introduction	8
Features	8
Package Contents	8
Panel Description	9
Installation	10
Captive Screw Connections	10
Cable Recommendation Guidelines	11
Mounting Instructions	12
Analog Multi-Function Inputs	13
Control	14
CEC	14
RS-232	14
TCP/IP	14
WebGUI	14
IR Remote	15
On-Screen Display (OSD)	16
WebGUI	19
Network Setup	20
Settings	21
Config	23
EDID	24
Audio	25
Control	27
Update	30
Appendix	31
Updating the Firmware	31
Specifications	32

Introduction

Easy to integrate, the CLSO-601 was designed for conference and classrooms with inputs near the switcher. Displays can be up to 328 feet (100 meters) from the switcher with HDBaseT outputs. Local HDMI and multifunction analog inputs work with any source. Combined with great features such as: 4K up/down scaling, microphone ducking, and audio control, this is the core component of your AV presentation system.

Features

- Four HDMI inputs (accepts DVI and DisplayPort with adaptors)
- Multifunctional VGA ports for RGBHV, component, S-Video, and composite signals
- Microphone (dynamic, phantom, and line) input with ducking
- HDBaseT output mirrored to HDMI output
- PoE output to power compatible receivers (**e.g.** AT-UHD-EX-100CE-RX)
- Auto switching - automated switching to last connected source without using a control system
- Balanced audio inputs for embedding audio
- DID management options including internal and learned EDID
- Balanced (-10 dbu) analog audio output for de-embedding audio to amplifiers or audio systems
- Upscaling and downscaling to ensure compatibility with any display up to 4K @ 30Hz resolution
- Control via RS-232, IR, TCP/IP, WebGUI, front panel, and multi-language On-Screen Display
- Multi-channel audio pass through up to Dolby TrueHD or DTS-HD Master Audio
- Master and sub volume control
- Adjust treble and bass of audio output to ensure the best speaker performance
- IP to RS-232 conversion enables TCP/IP commands to be sent using RS-232 ports
- Independent audio switching enables analog audio inputs to be embedded on any video input
- Multiple RS-232 ports for source control
- HDCP Compliance and management

Package Contents

- 1 x AT-UHD-CLSO-601
- 16 x Female Captive Screw Connector
 - 6 pin: audio (x3) - 5 pin: IR (x1) - 3 pin: RS-232 (x8) - 3 pin: MIC/Line (x1) - 2 pin: power (x1)
- 1 x IR Remote Control
- 1 x Pair of dual purpose wall/rack mounts
- 1 x 48V/3.125A DC power supply adaptor
- 1 x IEC power cord
- 1 x Installation Guide

Panel Description

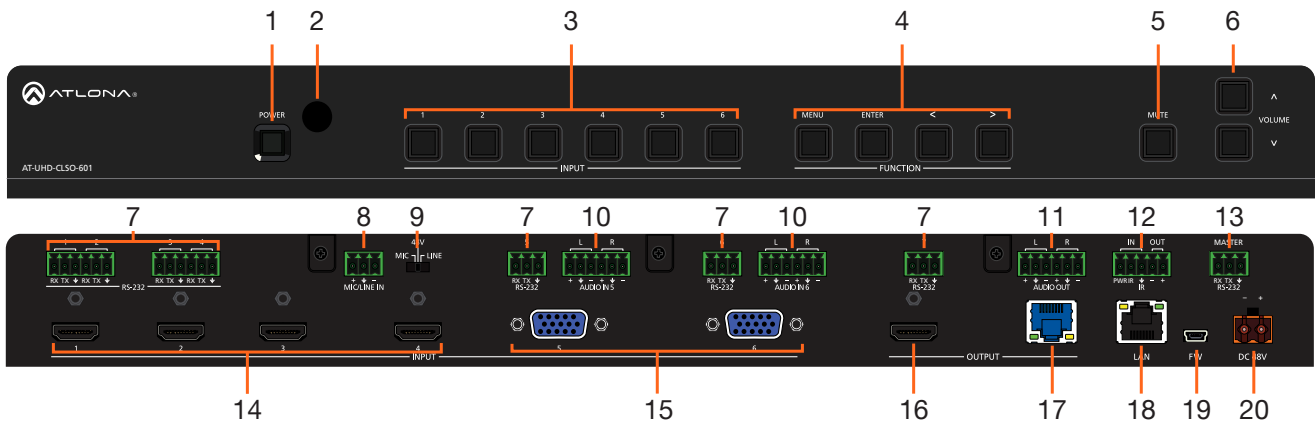

- | | |
|---|---|
| <p>1 POWER button
Use to turn the unit on or place into standby. LED will illuminate blue for on and red for standby.</p> <p>2 INPUT buttons
Select the button that corresponds with the inputs. The currently selected input will illuminate blue.</p> <p>3 INPUT buttons
Select the button that corresponds with the inputs. The currently selected input will illuminate blue.</p> <p>4 FUNCTION buttons
Use these buttons to open, navigate, and select items within the on screen display menu.</p> <p>5 MUTE Button
Use to mute and unmute the output audio.</p> <p>6 Volume Buttons
Increase and decrease the output volume.</p> <p>7 RS-232
Use for device control.</p> <p>8 MIC/LINE IN
Connect microphone or line input to this port.</p> <p>9 MIC/LINE Dip Switch
Use to switch between MIC, 48V, and line level input.</p> <p>10 AUDIO IN
Connect 2CH audio sources to these ports.</p> <p>11 AUDIO OUT
Connect to an audio DSP, amplifier, or other audio distribution devices.</p> | <p>12 IR IN/OUT
Connect an a control system or IR receiver to the IR IN port. Connect an IR blaster/emitter to the IR OUT port for local device control.</p> <p>13 MASTER RS-232
Connect a control system to this port for control of the switcher.</p> <p>14 HDMI IN
Connect HDMI sources here (DVI or DisplayPort compatible with adapters).</p> <p>15 VGA IN
Connect analog video sources here. Compatible with component, composite, and S-Video signals.</p> <p>16 HDMI OUT
Connect to a local display.</p> <p>17 HDBaseT OUT
Connect a CAT5e/6/6a/7 cable from this port to a compatible HDBaseT receiver or HDBaseT display. (e.g. AT-UHD-EX-100CE-RX).</p> <p>18 LAN
Connect an Ethernet cable from this port to a Local Area Network (LAN).</p> <p>19 FW
Connect a mini USB cable from this port to a PC to firmware update the unit.</p> <p>20 DC 48V
Connect the included DC 48V power supply to this port.</p> |
|---|---|

Installation

Captive Screw Connections

RS-232

A 3-pin captive screw connector has been included for RS-232.

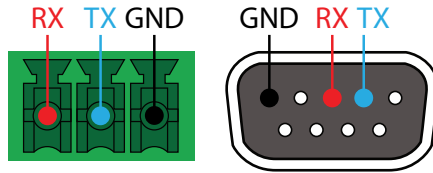
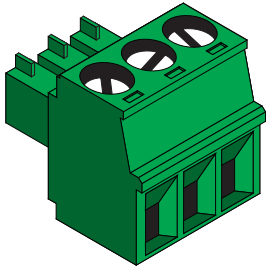

Pin out will be determined by the RS-232 cable and connect as RX (receive), TX (transmit) and \perp (Ground). Ground will be shared between port 1 and port 2.

IR

A 5-pin captive screw connector has been included for IR control of the unit and local devices. Connect a control system or IR receiver to the IR IN port and a IR emitter to the IR OUT port.

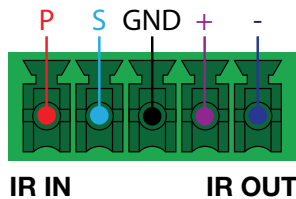
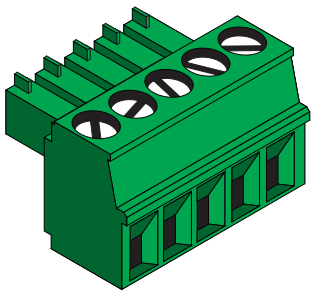

IR IN is connected by a power, ground, and signal wire. Use a 12V IR receiver with this port or connect a compatible control system. (e.g. AT-IR-CS-RX purchasable through atlonac.com)

IR OUT is connected by a ground and signal wire. Use the included IR emitter with this port.

Audio

Connect the input to any audio device and the output to an audio DSP, amplifier, or other audio distribution devices.

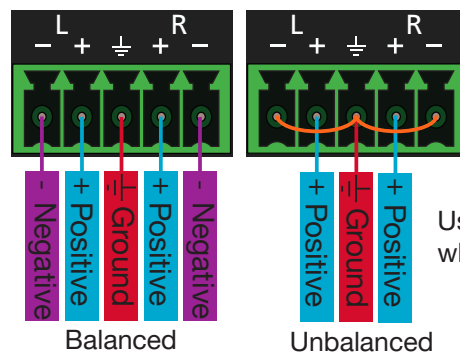
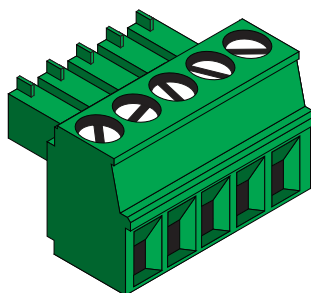

Use a jumper between the negative and ground pins when using an unbalanced connection.

MIC / LINE

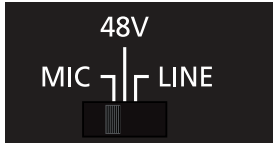

Connect dynamic or self-powered microphones in this mode.

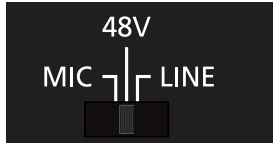

Use this setting for phantom powered microphones. Supplies 48 volts.

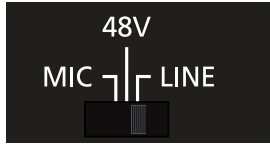

Connect wireless microphone receivers (or other sources) with line level outputs using this setting. Either balanced, unbalanced, mono, or two channel connections may be used.



Cable Recommendation Guidelines

Refer to the tables below for recommended cabling when using Altona products with HDBaseT. The green bars indicate the signal quality when using each type of cable. Higher-quality signals are represented by more bars.

Core	Shielding	CAT5e	CAT6	CAT6a	CAT7
Solid	UTP (unshielded)	■	■■■	■■■■	N/A
	STP (shielded)	■■	■■■■	■■■■■	■■■■■
Performance Rating (MHz)		350	500	600	800

IMPORTANT: Stranded or patch cables are not recommended due to performance issues.

Cable	Max. Distance @ 4K	Max. Distance @ 1080p
CAT5e	295 feet (90 meters)	330 feet (100 meters)
CAT6 / CAT6a / CAT7	330 feet (100 meters)	330 feet (100 meters)

Use of a TIA/EIA 568B termination is recommended for optimal performance.

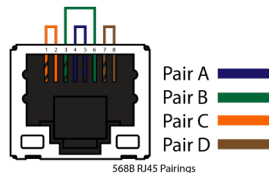

Mounting Instructions

The AT-UHD-CLSO-601 can be mounted in a standard 19-inch rack or placed freestanding on top of a desk or table.

Rack Installation

1. Remove the front two case screws from the sides of the case.
2. Attach the included rack ears to each side of the AT-UHD-CLSO-601 using the case screws.

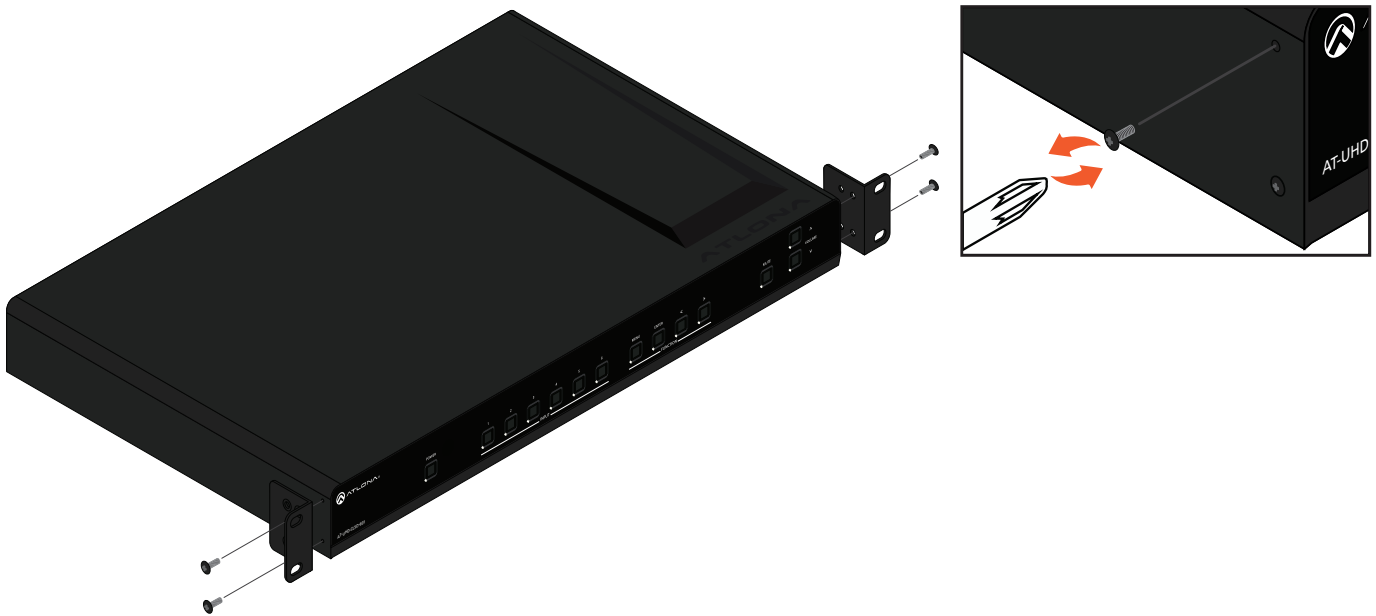

3. Install the AT-UHD-CLSO-601 into a rack, using four rack screws.

- i** **NOTE:** Increase the air flow as needed to maintain the recommended temperature inside the rack.
- i** **NOTE:** Do not exceed the maximum weight loads for the rack. Install heavier equipment in the lower part of the rack for stability.

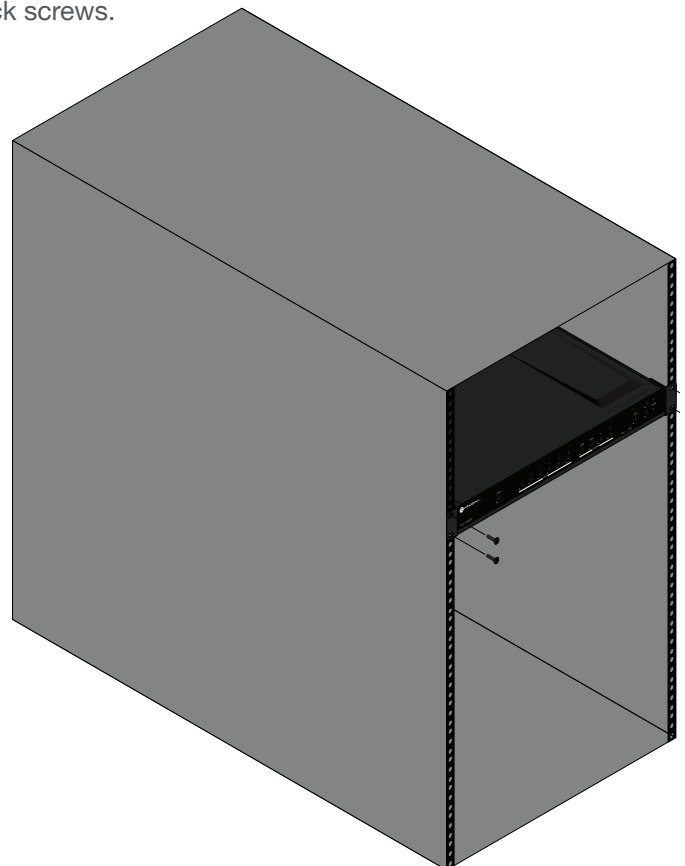

Analog Multi-Function Inputs

The CLSO-601 multi-function analog inputs (Input 5 and 6) can be used with most analog video signal formats including VGA (with DDC), RGBHV (without DDC), component (YUV), S-Video, or composite video. Balanced analog audio can be input and embedded using the provided captive screw connectors.

Each format can be directly accessed from RS-232, IR, or IP control. Front panel buttons sequentially progress through each input format. The last format used is the first source selected when returning to these inputs. Unused formats can be removed from the sequence using WebGUI, RS-232, or IP.

VGA (m) to BNC, VGA (m) to RCA, and S-Video to 2 BNC adaptors can be used to connect sources to these inputs.

VGA

Use a VGA to VGA cable to ensure that the Preferred Resolution DDC is communicated to your source.

RGBHV

Use a HD-15 (VGA) to 5 BNC breakout cable for this format. An existing RGBHV analog matrix switch can be connected here to maintain full function of the analog matrix.

Component

YUV (YPbPr) signal from DVD (or other sources) can be input to the CLSO-601 using the green (Y), blue (Pb), and red (Pr) connections on a HD-15 (VGA) to 5 BNC breakout cable or with a common VGA (m)-Component (3 RCA m) adaptor.

S-Video

YC signal from a VCR or teleconference system can be input to the CLSO-601 using the blue (Y), and green (C) connections on a HD-15 (VGA) to 5 BNC (m) breakout cable and a common S-Video (m) to 2 BNC (f) adaptor

Composite

NTSC, PAL, or Secam video signals can be input to the CLSO-601 using the blue connection on a HD-15 (VGA) to 5 BNC (m) breakout cable.

A common application for this type of input would be to connect a RGBHV matrix switcher to the CLSO-601. Then each input to the matrix could be connected to a different format analog signal. A 3rd party control system could ensure the correct format is selected to match the input to the switcher.

Control

CEC

CEC is available for trigger through RS-232, TCP/IP, and WebGUI. The trigger commands for RS-232 and TCP/IP can be found within the API at https://atlon.com/pdf/AT-UHD-CLSO-601_API.pdf.

RS-232

RS-232 control for connected devices and the unit are available through the RS-232 captive screw connection. The commands can be found within the API at https://atlon.com/pdf/AT-UHD-CLSO-601_API.pdf.

TCP/IP

TCP/IP control for connected devices and the unit are available through the LAN connection. The commands can be found within the API at https://atlon.com/pdf/AT-UHD-CLSO-601_API.pdf.

WebGUI

The unit has a built in web UI that will allow for unit configuration and device control. See the webGUI section for more information.

IR Remote

Power
 On - turns CLSO-601 on
 Off - sets CLSO-601 into standby

Controls
 Menu - Pulls up on screen display menu - also serves as back button
 Exit - Closes on screen display menu
 Arrows - Use to navigate the on screen display menu and adjust volume
 OK - Enter button, use to select choices within the on screen display menu
 Mute - Silences all audio outputs
 Auto - Auto VGA setup

Source Selection
 HDMI1 - Input 1
 HDMI2 - Input 2
 HDMI3 - Input 3
 HDMI4 - Input 4
 VGA1 - Input 5
 VGA2 - Input 6
 SV1 - Input 5 (S-Video 1)
 SV2 - Input 6 (S-Video 2)
 CV1 - Input 5 (Composite 1)
 CV2 - Input 5 (Composite 2)
 COMP1 - Input 5 (Component 1)
 COMP2 - Input 6 (Component 2)

Output Resolution Selection
 SVGA - 800x600
 XGA - 1024x768
 WXGA1 - 1280x800
 WXGA2 - 1360x768
 SXGA - 1280x1024
 SXGA+ - 1440x900
 UXGA - 1600x1200
 WUXGA - 1920x1200
 720p
 1080p
 4Kx2K - 3840x2160
 Native - Upscales/downscales the output signal to match the HDBaseT display's preferred resolution

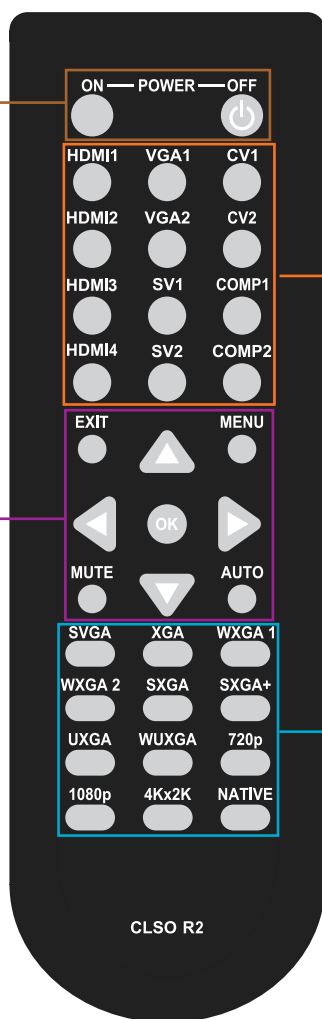

System IR is typically used to connect to control system processors. This input is used to control the CLSO-601.

Note: The IR receiver is optional for the UHD-CLSO-601. The compatible IR receiver (AT-IR-CS-RX) can be purchased through atlona.com.

The wires of the emitter and receiver have been marked to differentiate the pin outs.

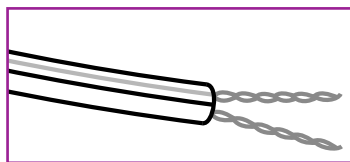
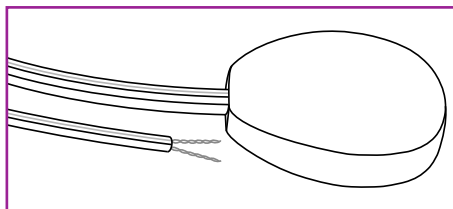

— Signal (S)
 — Ground (G)

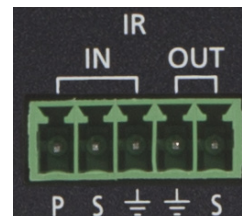

The included IR emitter has two wires: signal and ground. Signal will have a solid line and ground will be blank. The IR emitter will plug into the IR OUT ports.

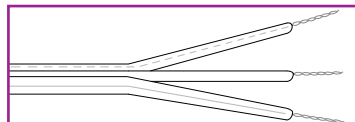

— Signal (S)
 — Ground (G)
 — Power (P)

There are three wires on the IR receiver (sold separately): signal, ground, and power. Signal has a dotted line, ground will be blank, and power will have a solid line. The IR receiver will plug into the IR IN ports.

On-Screen Display (OSD)

On Screen Display				
Input	Input 1	HDMI 1		
	Input 2	HDMI 2		
	Input 3	HDMI 3		
	Input 4	HDMI 4		
	Input 5	VGA 1 Component 1 Composite 1 S-Video 1		
	Input 6	VGA 2 Component 2 Composite 2 S-Video 2		
Audio	Volume	Master	-80 to +10db	
		Sub	HDMI 1	-80 to +10db
			HDMI 2	-80 to +10db
			HDMI 3	-80 to +10db
			HDMI 4	-80 to +10db
			Analog 1	-80 to +10db
			Analog 2	-80 to +10db
			Analog 3	-80 to +10db
	Line In	-80 to 0db		
	Bass	-10 to 12 dB		
Treble	-10 to 12 dB			
Video	Contrast	0 to 100		
	Brightness	0 to 100		
	Sharpness	0 to 30		
	Color	0 to 100		
	Tint	0 to 100		
	H Position	0 to 40		
	Phase	0 to 63		
	NR	BNR	Disabled Low Medium High	
		MNR	Disabled Low Medium High	
		RNR	Disabled Low Medium High	
	Scale	Full Overscan Underscan Letterbox Panscan Follow Input		

On Screen Display (OSD)

On Screen Display Setup					
	Language	English Spanish French German			
	OSD Settings	Transparency			
		Position	Horizontal	Vertical	
		Menu Timer	10 sec 30 sec 60 sec		
		Info Banner	On Off		
	Output Format	HD	Pass Through 480i@60 (NTSC) 480p@60 720p@60 1080i@60 1080p@60 576i@50 (PAL) 576p@50 720p@50 1080i@50 1080p@50 1080p@24		
			Native		
		UHD	3840x2160p@24 3840x2160p@25 3840x2160p@30 4096x2160p@24 4096x2160p@30		
			PC-1 640x480@60 640x480@72 640x480@75 800x600@60 800x600@72 800x600@75 1024x768@60 1024x768@72 1024x768@75		
		PC-2		1280x768@60 1280x800@60 1280x960@60 1280x1024@60 1360x768@60 1366x768@60 1400x1050@60 1440x900@60 1600x900@60 1600x1200@60 1920x1200@60	
		Network	Network Status	MAC Address xx-xx-xx-xx-xx-xx IP Address xxx.xxx.x.xxx Subnet xxx.xxx.xxx.x Gateway xxx.xxx.x.x	
	DHCP		ON OFF		

Note: After selecting a new language, close the menu and reopen it for the change to take effect.

On Screen Display (OSD)

On Screen Display			
Status	System Info	Software Revision	x.x.xx (e.g. 1.0.01)
		OSD Revision	x.x.x (e.g. 1.0.0)
		FPGA Revision	x.x.x (e.g. 1.0.0)
		On-Time (h-m)	x:xx (e.g. 1:15)
	Video Info	Input	xxxx (e.g. HDMI 1)
		Signal Type	xxxx (e.g. HDMI)
		Video Format	xxxx (e.g. 1080i@60)
		Aspect	xxxx (e.g. 16x9)
		Color Space	xxxx (e.g. YUV)
	Audio Info	Color Depth	xxxx (e.g. 24)
		Input	xxxx (e.g. HDMI 1)
		Audio Format	xxxx (e.g. PCM)
		Sampling Rate	xxxx (e.g. 48 KHz)
	Channels	xxxx (e.g. 2-Ch)	

WebGUI

The AT-UHD-CLSO-601 includes a built-in webGUI, which allows easy remote management and control of all features. Follow the instructions below to access the webGUI.

1. Make sure that an Ethernet cable is connected between the **LAN** port on the AT-UHD-CLSO-601 and the network.
2. Use an IP scanner to determine the IP address of the unit.
3. Launch a web browser and enter the IP address in the address bar.
4. The AT-OME-PS62 **Login** page will be displayed.
5. Enter the following information on the **Login** page.

Login: root
 Password: Atlona

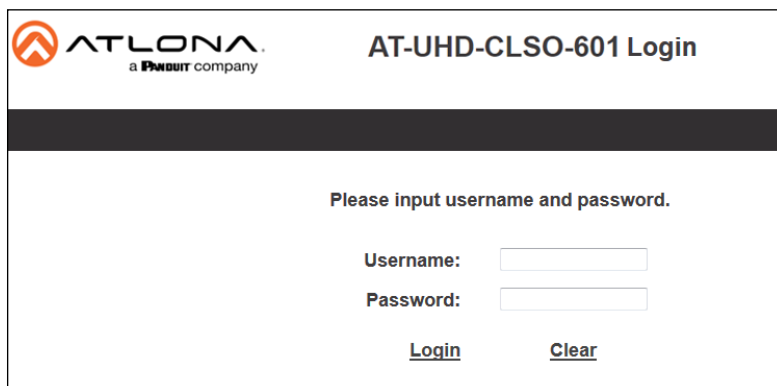

NOTE: If the login and password are entered wrong six times, the unit will lock the login screen for two minutes.

6. Click the Login button. The info page will display, giving all the general information of the AT-UHD-CLSO-601.

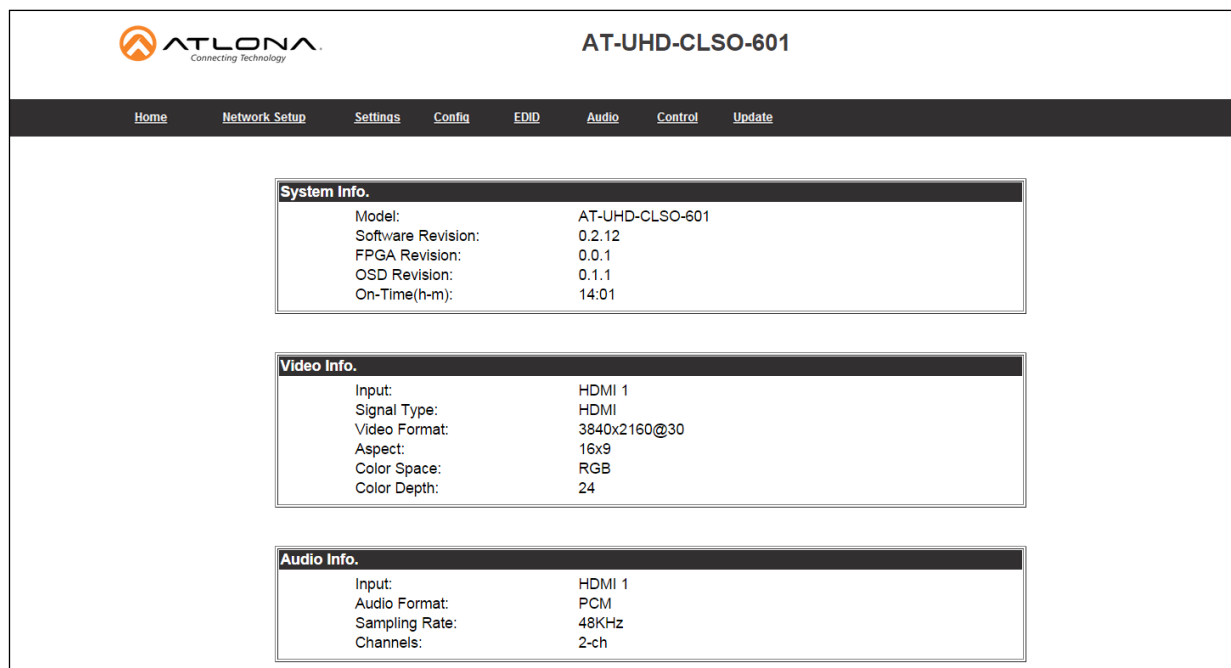

System Info.	
Model:	AT-UHD-CLSO-601
Software Revision:	0.2.12
FPGA Revision:	0.0.1
OSD Revision:	0.1.1
On-Time(h-m):	14:01

Video Info.	
Input:	HDMI 1
Signal Type:	HDMI
Video Format:	3840x2160@30
Aspect:	16x9
Color Space:	RGB
Color Depth:	24

Audio Info.	
Input:	HDMI 1
Audio Format:	PCM
Sampling Rate:	48KHz
Channels:	2-ch

Network Setup

Select Network Setup from the top navigation to adjust IP information.



AT-UHD-CLSO-601 Setup

Home
Network Setup
Settings
Config
EDID
Audio
Control
Update

DHCP	<input checked="" type="checkbox"/> ON <input type="checkbox"/> OFF	
IP Address	<input type="text" value="010.020.040.068"/>	<input type="text" value="192.168.000.117"/>
Subnet	<input type="text" value="255.255.255.000"/>	<input type="text" value="255.255.255.000"/>
Gateway	<input type="text" value="010.020.040.001"/>	<input type="text" value="192.168.000.001"/>
Telnet Port	<input type="text" value="23"/>	<input type="text" value="23"/>
Hostname	<input type="text" value="CLSO601-0052C8"/>	<input type="text" value="CLSO601-0052C8"/>
Login Mode	<input type="checkbox"/> ON <input checked="" type="checkbox"/> OFF	<input checked="" type="checkbox"/> ON <input type="checkbox"/> OFF
MAC Address	<input type="text" value="B8-98-B0-00-52-C8"/>	<input type="text" value="B8-98-B0-00-00-01"/>

Network

DHCP - Switch between static (OFF) and DHCP (ON) IP modes.

IP, Netmask, Gateway - This will display the unit's current DHCP IP settings. When set to static, fill in the IP address, netmask, and gateway.

Telnet Port - Set the telnet port if needed for control. Default port is 23.

Hostname - Set the name for the matrix, this will show up in network discovery.

Login Mode - Toggle telnet login mode on and off. If on, a username and password will be required to control the unit via telnet.

MAC Address - Displays the MAC address of the unit.

Settings

Select Settings from the top navigation to adjust routing and video settings.

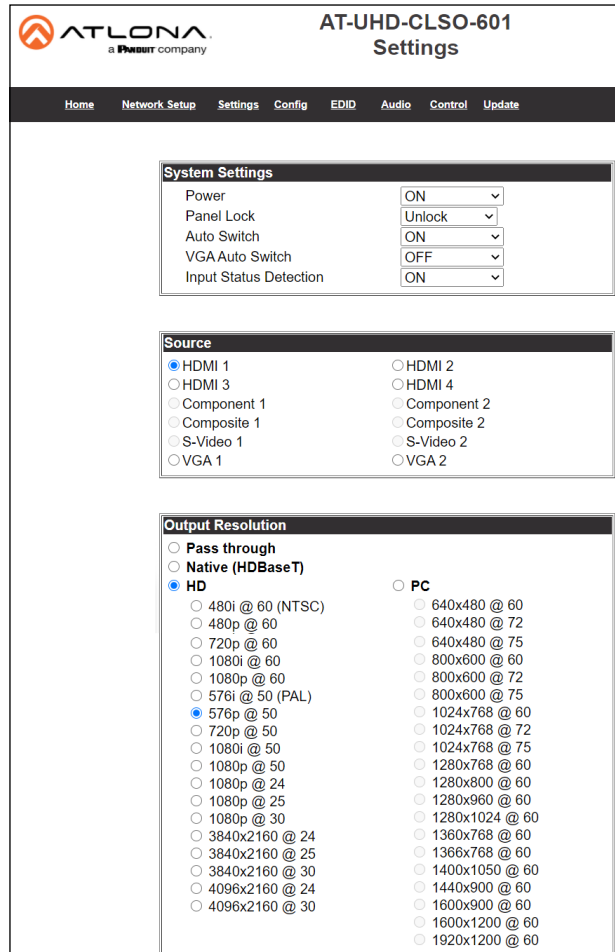

System Settings

Power	ON
Panel Lock	Unlock
Auto Switch	ON
VGA Auto Switch	OFF
Input Status Detection	ON

Source

<input checked="" type="radio"/> HDMI 1	<input type="radio"/> HDMI 2
<input type="radio"/> HDMI 3	<input type="radio"/> HDMI 4
<input type="radio"/> Component 1	<input type="radio"/> Component 2
<input type="radio"/> Composite 1	<input type="radio"/> Composite 2
<input type="radio"/> S-Video 1	<input type="radio"/> S-Video 2
<input type="radio"/> VGA 1	<input type="radio"/> VGA 2

Output Resolution

<input type="radio"/> Pass through	
<input type="radio"/> Native (HDBaseT)	
<input checked="" type="radio"/> HD	<input type="radio"/> PC
<input type="radio"/> 480i @ 60 (NTSC)	<input type="radio"/> 640x480 @ 60
<input type="radio"/> 480p @ 60	<input type="radio"/> 640x480 @ 72
<input type="radio"/> 720p @ 60	<input type="radio"/> 640x480 @ 75
<input type="radio"/> 1080i @ 60	<input type="radio"/> 800x600 @ 60
<input type="radio"/> 1080p @ 60	<input type="radio"/> 800x600 @ 72
<input type="radio"/> 576i @ 50 (PAL)	<input type="radio"/> 800x600 @ 75
<input checked="" type="radio"/> 576p @ 50	<input type="radio"/> 1024x768 @ 60
<input type="radio"/> 720p @ 50	<input type="radio"/> 1024x768 @ 72
<input type="radio"/> 1080i @ 50	<input type="radio"/> 1024x768 @ 75
<input type="radio"/> 1080p @ 50	<input type="radio"/> 1280x768 @ 60
<input type="radio"/> 1080p @ 24	<input type="radio"/> 1280x800 @ 60
<input type="radio"/> 1080p @ 25	<input type="radio"/> 1280x960 @ 60
<input type="radio"/> 1080p @ 30	<input type="radio"/> 1280x1024 @ 60
<input type="radio"/> 3840x2160 @ 24	<input type="radio"/> 1360x768 @ 60
<input type="radio"/> 3840x2160 @ 25	<input type="radio"/> 1366x768 @ 60
<input type="radio"/> 3840x2160 @ 30	<input type="radio"/> 1400x1050 @ 60
<input type="radio"/> 4096x2160 @ 24	<input type="radio"/> 1440x900 @ 60
<input type="radio"/> 4096x2160 @ 30	<input type="radio"/> 1600x900 @ 60
	<input type="radio"/> 1600x1200 @ 60
	<input type="radio"/> 1920x1200 @ 60

System Settings

Power - Turn the switcher on and off

Panel Lock - Locks/unlocks the front panel buttons, or just the menu when Lock Menu is selected

Auto Switch - Turns auto switching between HDMI inputs on/off

VGA auto switch - Turns VGA auto switching on/off

Note: VGA auto switching is only available on VGA and will not work with component, composite, and S-Video

Component, composite, and S-Video poll settings will grey out when VGA auto switching is on

Input Status Detection - When enabled (ON), the poll settings will display the type of input signal being received on the VGA port.

Source

Select the input to be routed to the output.

Output Resolution

Switch between multiple video output resolutions:

Pass through - Input video will pass to the display without being scaled

Native - Upscales/downscales the output signal to match the HDBaseT display's preferred resolution

HD - Will upscale/downscale the output signal to match the selected HD resolution

PC - Will upscale/downscale the output signal to match the selected PC resolution

Note: When the output is set to UHD resolutions, UHD sources are passed through without scaling. Frame rates are not changed. (e.g. if 3840x2160@30Hz input is received, output will remain 30Hz even if output is set to 24Hz)

Video Settings	
Scale	Full ▾
BNR	Medium ▾
MNR	Medium ▾
RNR	Medium ▾

Poll Settings	
<input checked="" type="checkbox"/> VGA 1	<input checked="" type="checkbox"/> VGA 2
<input type="checkbox"/> Component 1	<input type="checkbox"/> Component 2
<input type="checkbox"/> Composite 1	<input type="checkbox"/> Composite 2
<input type="checkbox"/> S-Video 1	<input type="checkbox"/> S-Video 2

Live Button (Front Panel)						
Input	1	2	3	4	5	6
	<input checked="" type="checkbox"/>	<input checked="" type="checkbox"/>	<input checked="" type="checkbox"/>	<input checked="" type="checkbox"/>	<input checked="" type="checkbox"/>	<input checked="" type="checkbox"/>

OSD Display Setting	
OSD func.	ON ▾
OSD info.	ON ▾

Video Settings

Set the output video settings:

- Scale - Sets video output aspect ratio - Full, overscan, letter box, pan and scan, or follow input
 - Full - Sources always fill the screen, regardless of source aspect ratio
 - Overscan - Image is slightly zoomed in so that broadcast data at edges is masked
 - LetterBox - Used to create 16:9 aspect ratio on 4:3 aspect ratio TVs
 - Pan and Scan - Used to create 4:3 aspect ratio on 16:9 aspect ratio TVs
 - Follow Input - Aspect ratio on TV matches source aspect ratio

- BNR - Block noise reduction - Disabled, low, medium, or high
- MNR - Mosquito noise reduction - Disabled, low, medium, or high
- RNR - Random noise reduction - Disabled, low, medium, or high

- Contrast* - Sets output white levels - 0 up to 100
- Brightness* - Sets output black levels - 0 up to 100
- Sharpness* - Sets output sharpness - 0 up to 30
- Color* - Sets output color saturation - 0 up to 100
- Tint* - Sets output hues - 0 up to 100

*Only available when outputs 5 and 6 (VGA 1 & VGA 2) are selected

Poll Settings

A check mark will appear in the box next to the signal type that is being received on the VGA port.

Note: This will only display signal type when Input Status Detection is set to ON. If set to OFF, all the signal types will be checked.

OSD Display Settings

- OSD func - Turns the CLSO's display OSD menu on/off
- OSD info - Turns the source information on the display on/off when switching

Reset Settings
Factory Default

It will reset parameters.	Confirm	Cancel
---------------------------	---------	--------

- Reset Settings - Will reset the parameters to default settings on the current page only.
- Factory Default - Select to reset CLSO back to factory settings.

Note: This will reset the switcher to factory default, including: resolutions, audio settings, HDCP settings, etc.

Config

Select Config from the top navigation to adjust passwords, add new users, and adjust RS-232 settings.



AT-UHD-CLSO-601
Config

[Home](#)
[Network Setup](#)
[Settings](#)
[Config](#)
[EDID](#)
[Audio](#)
[Control](#)
[Update](#)

Change Password:

Old Password	
Username	<input type="text" value="root"/>
Password	<input type="password"/>
New Password	
Password	<input type="password"/>
PW again	<input type="password"/>

No.	Username	Password	Delete
User 1	mike	1234	Delete
User 2			Delete
User 3			Delete

RS232	Baudrate	Databit	Parity	Stopbit
System	115200 ▾	8 Bits ▾	None ▾	1 Bit ▾
Input1	9600 ▾	8 Bits ▾	None ▾	1 Bit ▾
Input2	9600 ▾	8 Bits ▾	None ▾	1 Bit ▾
Input3	9600 ▾	8 Bits ▾	None ▾	1 Bit ▾
Input4	9600 ▾	8 Bits ▾	None ▾	1 Bit ▾
Input5	9600 ▾	8 Bits ▾	None ▾	1 Bit ▾
Input6	9600 ▾	8 Bits ▾	None ▾	1 Bit ▾
Output1	9600 ▾	8 Bits ▾	None ▾	1 Bit ▾
Output2	9600 ▾	8 Bits ▾	None ▾	1 Bit ▾

i NOTE: User information and updating can only be seen using the admin log in.

Change user name and password

Update the admin password for the switcher. Only the admin password may be changed, the username will remain root.

User and password

Add new users and passwords here. These users will not have admin priveleges and will not be able to add or change current users.

RS-232

System - This will change the settings of the Master RS-232 ports

Inputs - These will change the settings of RS-232 ports 1 through 6

Output 1 - This corresponds with the RS-232 port 7

Output 2 - This will adjust the RS-232 settings of the HDBaseT receiver.

EDID

Select EDID from the top navigation to set the preferred timings of the input ports and to adjust HDCP compliance reporting.

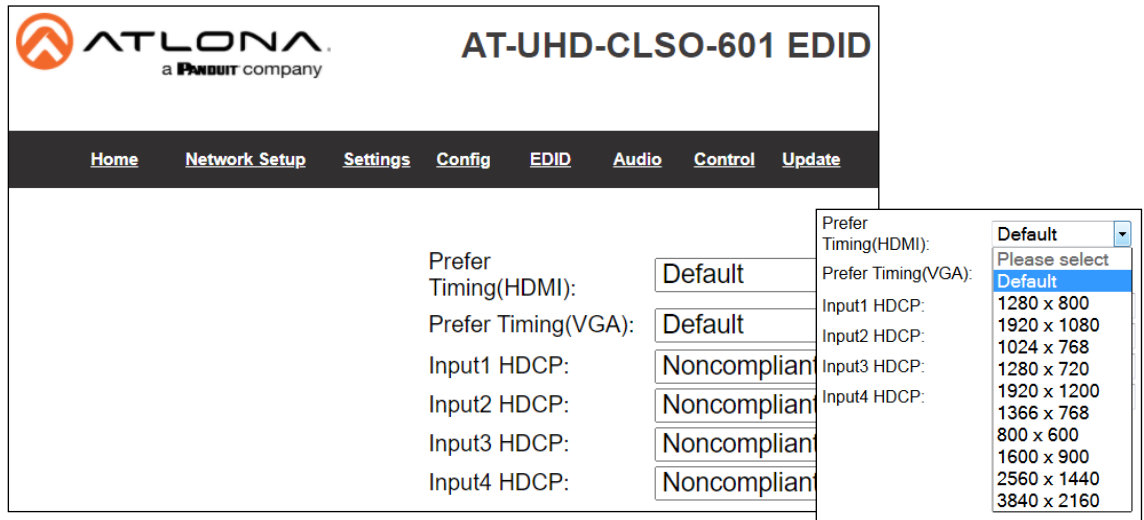

Prefer Timing (HDMI)

Set the resolution of the HDMI ports.

Prefer Timing (VGA)

Set the resolution of the VGA ports..

RS-232

System - This will change the settings of the Master RS-232 ports

Inputs - These will change the settings of RS-232 ports 1 through 6

Output 1 - This corresponds with the RS-232 port 7

Output 2 - This will adjust the RS-232 settings of the HDBaseT receiver.

Note: CLSO-601 protects HDCP encoded content and will not pass HDCP content to a non-HDCP compliant device.

Note: Some devices flag all content as protected when connected to an HDCP compliant display. This prevents what should be non-protected content from reaching devices (i.e. teleconference system) through the CLSO-601.

Note: When HDCP reporting is non-compliant, only user created content is transmitted. Protected content from all sources (e.g. BluRay, AppleTV, etc) is blocked.

Audio

Select Audio from the top navigation to set it.

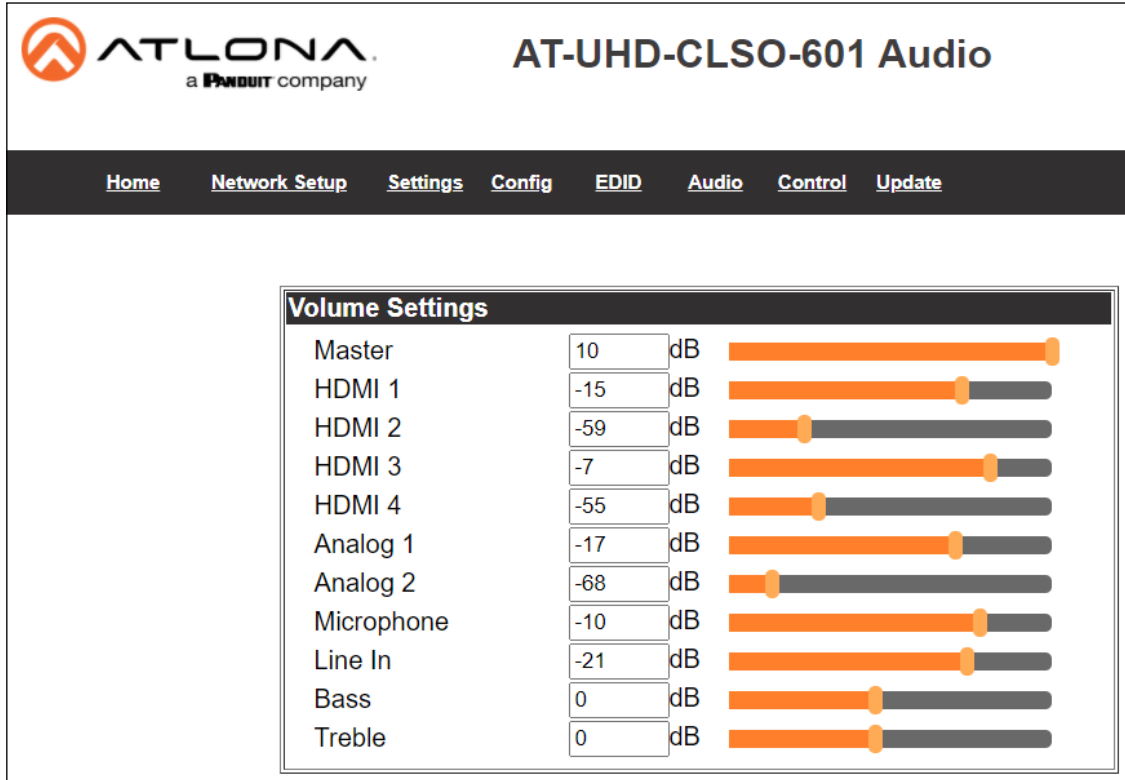

Volume Settings		
Master	10	dB
HDMI 1	-15	dB
HDMI 2	-59	dB
HDMI 3	-7	dB
HDMI 4	-55	dB
Analog 1	-17	dB
Analog 2	-68	dB
Microphone	-10	dB
Line In	-21	dB
Bass	0	dB
Treble	0	dB

Audio settings adjust output volume for all sources including the microphone.

Master - Affects all sources at the same time

Inputs - Used to balance levels from each source.

Note: For best results, gains should be balanced between master and source levels.

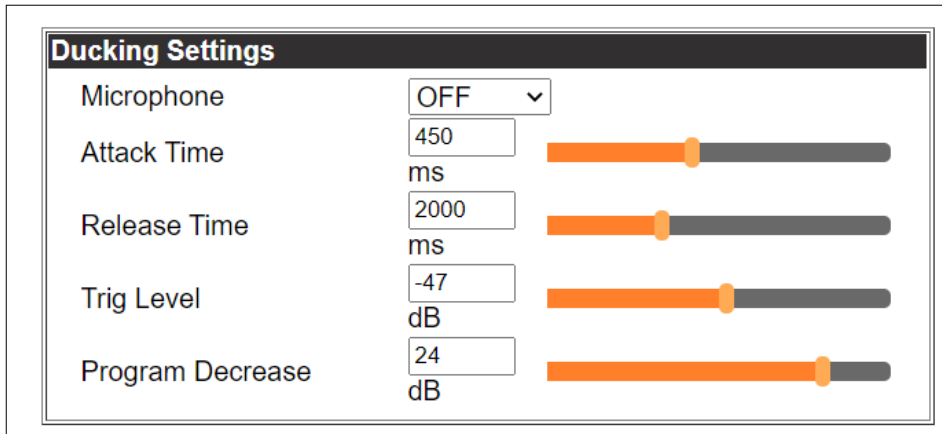

Microphone ducking uses the audio level from the microphone to decrease the program level so the speaker may be heard.

Note: Proper set up is critical for satisfactory operation. If program levels are too high they can trigger the ducking process.

Note: Setting the microphone volume too high may result in feedback.

It is recommended that a handheld or headset microphone be used with ducking to reduce feedback and maximize the difference between voice and program levels.

Best results are received with the following sequence:

1. Set master volume to 0. (This is 10 db below maximum)
2. Raise appropriate microphone (or line in) volume until just below feedback or adequate volume is reached (whichever setting is lower). - Master level and amplifier gains may be increased to get appropriate levels

Note: If feedback occurs and volume is not adequate, move the speakers and/or microphone to eliminate feedback.

3. Raise source “sub” volumes to appropriate levels without talking
4. Set attack time to minimize popping, but still fast enough that initial talking sounds are heard.
5. Set release time so that program levels do not increase between sentences.

Note: Shorten time so that the microphone doesn’t interfere with the program.

6. Set the trigger level so that words spoken at a normal level trigger the ducking process

Note: Set the trigger level too sensitive and the program will trigger the ducking. Set too low and the speaker will have to talk very loudly to trigger ducking. The further right the slider is, the more sensitive the setting.

7. Set program decrease to ensure when ducking is triggered the program level is low enough the speaker can be heard.

Fine tuning these settings will help achieve the best results.

Control

Select Control from the top navigation to enable and configure switcher and display control. The Control page provides a way to program button functions, turn auto switching on/off, and determine the type of control commands (TCP/IP or RS-232) sent out.

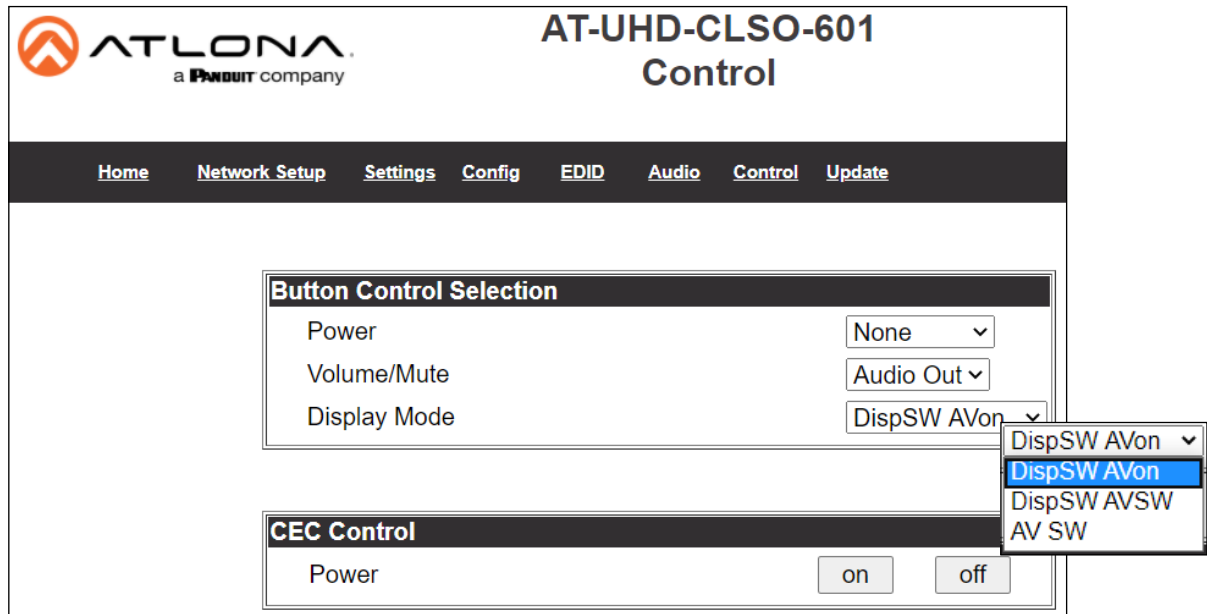

Button Control Selection

Power - Set which device the power button controls

None: Power button will turn the UHD-CLSO-601 on and off

RS-232: Power button will send power on/off command over HDBaseT using RS-232 to compatible receivers and displays

IP: Power button will send power on/off command over Ethernet using either the LAN connection or the HDBaseT connection

Volume/Mute

Audio Out: Volume and mute buttons will control volume output of the switcher

RS-232: Volume/Mute buttons will send the commands over HDBaseT using RS-232 to compatible receivers and displays

IP: Volume/Mute buttons will send the commands over Ethernet using either the LAN connection or the HDBaseT connection

Display Mode -

DispSW AVon: Display switches on/off, source audio/video signal always on

DispSW AVSW: Display switches on/off, source audio/video signal switches on/off

AV SW: Display is always on, source audio/video signal switches on/off

CEC Control

Power

On - Sends a command over HDBaseT to the HDMI output of the connected receiver to turn the connected display on

Off - Sends a command over HDBaseT to the HDMI output of the connected receiver to turn the connected display off

Note: CEC may not work with every display type

System Settings		
Display Auto Power On	Enabled Disabled	
Display Auto Power Off	Enabled Disabled	
Power Button Lock	Enabled Disabled	
Lamp Cool Down Timer (0~300)	<input type="text" value="0"/> Sec	Save
Auto Power Off Timer (1~240)	<input type="text" value="10"/> Sec	Save
Display Warm Up Timer (0~300)	<input type="text" value="0"/> Sec	Save
Control Type	<input type="text" value="CEC"/>	
Display Mode	<input type="text" value="DispSW AVon"/>	

DispSW AVon ▾
DispSW AVon
 DispSW AVSW
 AV SW

System Settings

Display Auto Power - Enable to send the programmed command to the display to turn on or off when detecting or losing A/V signals.

Auto power off timer - Sets the period of time between the loss of A/V signal and when the display off command is sent. Default is 15 seconds and can be adjusted from 5 seconds to 1 hour.

Lamp cool down timer (Sec.) - Sets the time between when projector lamp has been turned off to when it can receive new commands. Default is 10 seconds and can be adjusted from 10 seconds to 300 seconds.

Display Warm-Up Timer (Sec.) - Sets the time between when the projector lamp has been turned on to when it can receive new commands. Default is 10 seconds and can be adjusted from 10 seconds to 300 seconds.

Control Type - By default, CEC is selected for control of the display. IP and RS-232 can also be selected. When IP or RS-232 are selected, more fields are available.

Display warm up timer (0~300)	<input type="text" value="0"/> Sec	Save
Control Type	<input type="text" value="CEC"/>	
Display Mode	<input type="text" value="DispSW AVon"/>	

TCP/IP Settings of Controlled Device (only available when IP is selected)

IP Mode - Toggle telnet login mode between Non-Login and Login. If set to Login, a username and password will be required to control the controlled device via TCP/IP.

IP Address - Sets to the IP of the controlled device/display.

Telnet Port - Set the telnet port of the controlled device for control. Default is 23.

Username & Password - Sets the username and password that is required when login mode is enabled.

RS232/IP commands

Manufacturer: Generic ▾
 Products: Generic ▾
 Model: Generic ▾
 Display Commands
 [Please use \x as a delimiter for HEX values]

Repeat Command
 Status: DISABLED
 Times: 2 ▾

ON: PW 1
 OFF: PW 0
 Volume+: VOL+
 Volume-: VOL-
 Mute: MUTE
 Mute On: MUTE ON
 Mute Off: MUTE OFF

RS232/IP commands

Manufacturer: Generic ▾
 Products: Generic ▾
 Model: Acer
 Barco
 Benq
 Canon
 Casio
 Eiki
 Epson
 Hitachi
 Infocus
 Lg
 Nec
 Optoma
 Panasonic
 Pjlink
 Planar
 Qomo
 Samsung
 Sharp
 Sony
 Mute Off: MUTE OFF

RS232/IP commands

Manufacturer: Panasonic ▾
 Products: Panasonic Projector ▾
 Model: Panasonic Projector
 Panasonic TV
 Panasonic TV (Copy)
 [Please use \x as a delimiter for HEX values]

RS-232 / IP Commands

Manufacturer, Products, Models - Select the make and model of the display for control. Commands have been programmed into the PS62 for a wide range of products. If the current display is not found within the database, use generic and manually adjust the command fields.

Repeat Command - Enable Status to repeat the commands. Default repeat number is 2 and can be adjusted from 2 to 4 times.

Commands: On/Off/Volume/Mute - These fields will automatically be filled with the correct command when selecting a manufacturer and product from the drop down menus. If manually entering the commands, type them into the fields next to the command name.

Send - Use this button to send the command to the display, this can be used while manually typing the commands to ensure the commands are correct.

Save - Save the commands to the webGUI. Manufacturer, products, and Model will revert to Generic but the commands will be saved from the previously selected and saved Manufacturer, products, and model selection.

Revert - Sets the commands back to the previously saved settings.

Update

Select Update from the top navigation to update the switcher, valens, audio, FPGA, and OSD firmware.

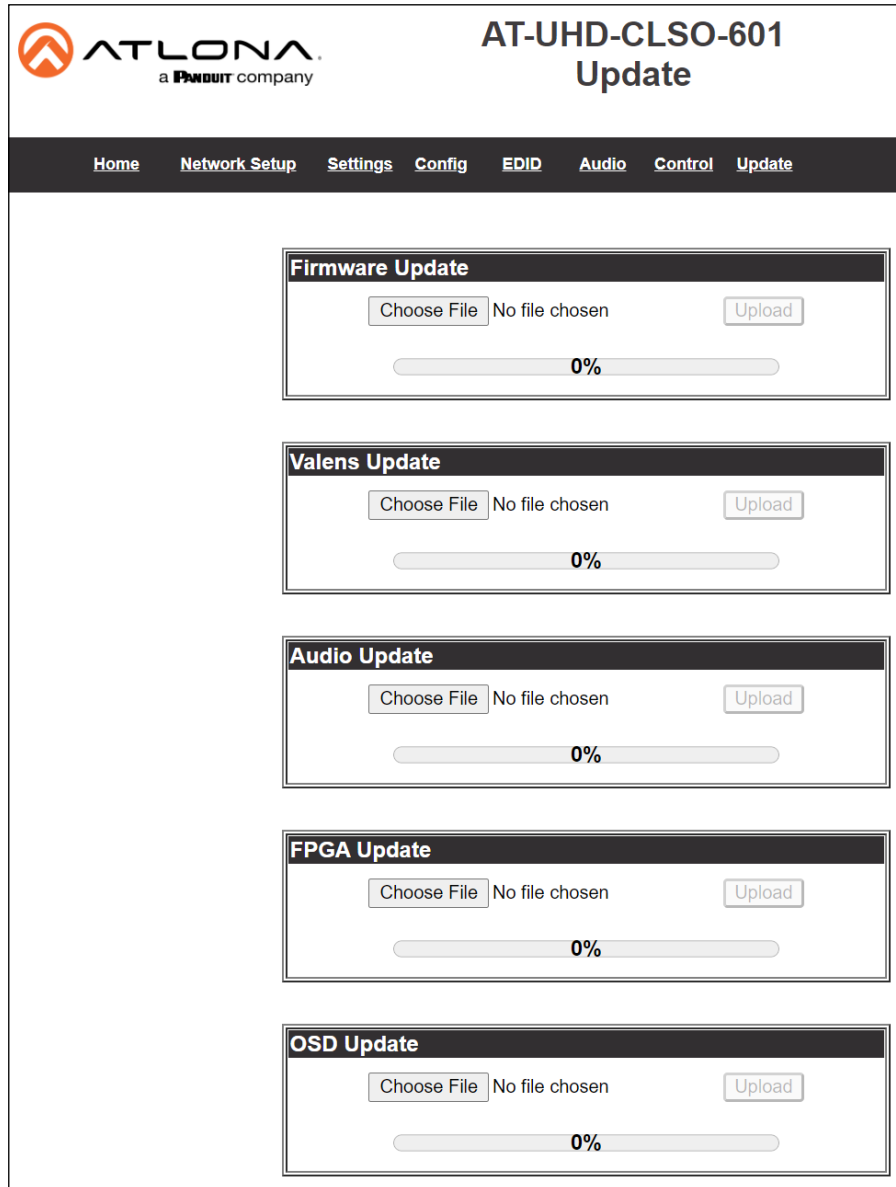

- Select the browse button for the type of firmware to be updated
 - Firmware Update - MCU/Main firmware
 - Valens Update - Valens firmware
 - Audio Update - DSP firmware
 - FPGA Update - FPGA firmware
 - OSD Update - OSD firmware
- Select the new firmware file that was downloaded either from atlona.com or box.com
- Press the update button

A progress bar will display as the update is completed. After the update is complete, if a restart is required, the webGUI will display a prompt. The firmware update is now complete and the switcher is ready to be used.

Appendix

Updating the Firmware

Putting the unit into update mode:

1. Unplug the power from the CLSO-601
2. Connect CLSO-601 to a computer using the mini USB to USB A cable
3. Press and hold the input key of the specific type of firmware update
 - Input 1 - USB/main firmware
 - Input 2 - OSD firmware
 - Input 3 - DSP/Audio firmware
 - Input 4 - FPGA firmware
 - Input 5 - Valens firmware
4. Plug the power back into the CLSO-601 (while still holding the input key)
5. Continue holding the input key for 5 seconds then release it
6. Click the option, “open folder to view files” (if AutoPlay runs)

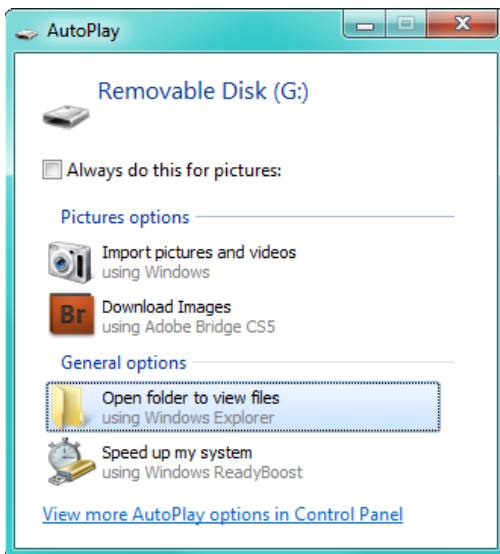

If the computer does not auto detect the connection, open “My Computer” and select the USB drive.

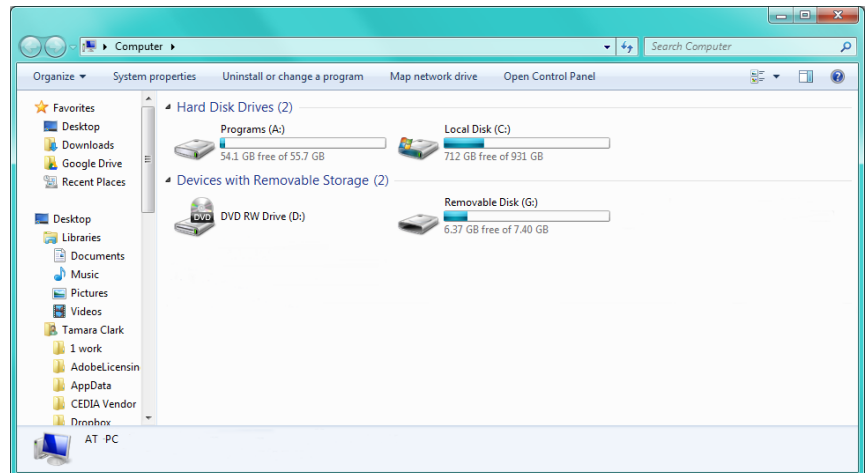

7. Place the latest firmware in the folder (if there is already a file in the folder, delete it)
8. Remove the USB cable from the CLSO-601 and computer
9. Unplug the power cable from the CLSO-601
10. Plug the power cable back in
11. Repeat the process until all firmwares are updated

The update process is complete and the switcher is ready to be used Unplug the power from the CLSO-601

Specifications

Video		
HDMI	2.0	
Copy Protection	1.4	
Pixel Clock	300 MHz	
UHD/HD	4096x2160@24/30Hz 3840x2160@24/25/30Hz 1920x1080p@23.98/24/25 /29.97/30/50/59.94/60 1920x1080i@50/59.94/60Hz	1280x720p@25/29.97/30/50/59.94/60Hz 720x576p 720x576i 640x480p 640x480i
VESA All resolutions are 60 Hz	2560x1440 2048x1152 2048x1080 1920x1200 1680x1050 1600x1200 1600x900 1440x1050 1440x900	1366x768 1360x768 1280x1024 1280x960 1280x800 1280x768 1024x768 800x600 640x480
Color Space	YUV, RGB	
Chroma Subsampling	4:4:4, 4:2:2, 4:2:0	
Color Depth	8-bit, 10-bit, 12-bit	

Audio		
Analog Out	LPCM 2.0	
HDMI/HDBaseT Out (pass through)	Dolby® Digital Dolby Digital Plus™ Dolby TrueHD Dolby Atmos®	DTS® Digital Surround™ DTS-HD Master Audio™ DTS:X®
Bit Rate	24 Mbits/s max	
Analog Audio		
Format	2-channel stereo	
Balanced Output	+4 dBu, nominal gain; +20 dBu headroom	
Frequency Response	20 Hz to 20 kHz, ±0.5 dB	
THD + N	< 0.009% @ 20 Hz to 20 kHz	
SNR	> 94 dB @ 1 kHz, zero clipping @ 0 dBFS, unweighted	
Sample Rate	32 kHz, 44.1 kHz, 48 kHz, 88.2 kHz, 96 kHz, 176.4 kHz, 192 kHz	

Protocols	
Addressing	DHCP, static

Control	
RS-232	Device control and configuration Bidirectional pass-through from control system over HDBaseT Supported baud rates: 2400, 4800, 9600, 19200, 38400, 57600, 115200
IP	Protocols: HTTPS, Telnet, mDNS Modes: DHCP, Static – selectable through front panel and built-in web server
CEC	Yes

Resolution / Distance	4K/UHD - Feet / Meters		1080p - Feet / Meters	
HDMI IN/OUT	15	5	30	10
CAT5e/6	230	70	330	100
CAT6a/7	330	100	330	100

Connectors	
HDMI IN	4 - Type A, 19-pin female
HDMI OUT	1 - Type A, 19-pin female
VGA IN	2 - DE-15, 15-pin female
HDBaseT OUT	1 - RJ45
RS-232	2 - 6-pin captive screw, 4 - 3-pin captive screw (bidirectional)
IR	1 - 5-pin captive screw
MIC/LINE IN	1 - 3-pin captive screw
AUDIO IN	2 - 6-pin captive screw
AUDIO OUT	1 - 6-pin captive screw
LAN	1 - RJ45, 10/100/1000 Mbps
FW	1 - Micro USB
DC 48V	1 - 2-pin captive screw

Indicators and controls	
INPUT 1 - INPUT 6	6 - LED, blue
POWER INPUT 1 - INPUT 6 MENU, ENTER, >, < MUTE, VOL UP, VOL DN	16 - momentary, tact-type

Environmental	Fahrenheit	Celsius
Operating Temperature	+32 to +122 °F	0 to 50 °C
Storage Temperature	-4 to +140 °F	-20 to 60 °C
Operating Humidity (RH)	20% to 90%, non-condensing	

Power	
Consumption	33 W
Idle Consumption	3.1 W
External Power Supply	100 - 240 V AC, 50/60 Hz Output: 48 V / 3.125 A DC

Dimensions	Inches	Millimeters
Device (H x W x D)	1.73 x 17.08 x 10.04	44 x 433.8 x 255
Device (w/ feet)	2.17 x 17.08 x 10.04	55.15 x 433.8 x 255

Weight	Pounds	Kilograms
Device	6.9	3.12

Certification	
Device	CE, FCC
Power	CE, FCC, cULus, RoHS, CCC, RCM

