

8300 Electric Strike

Works with cylindrical locksets and accommodates latchbolts up to 5/8" throw

Also available in a Complete One Box Solution

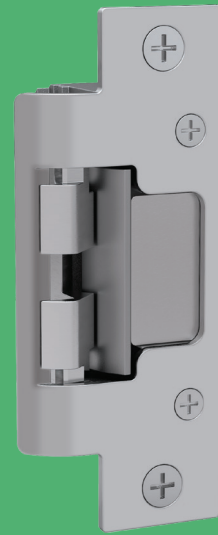

The fire rated, concealed solution for cylindrical locksets.

The 8300 Series Electric Strike is a fire rated, compact, high performance electric strike featuring a unique concealed design for use with cylindrical locksets. No cutting on the frame is required. Simply remove the existing ANSI strike plate, adjust the vertical alignment feature to the latchbolt centerline and install. Its strength is derived from a unique keeper pin locking design, enabling the 8300 to exceed the ratings of the frame, door and locking hardware. This unique electric strike is easy to install and complies with NFPA 80-07 guidelines for retrofit into fire rated frames. The 8300 accommodates latchbolts up to 5/8" throw.

Features

Standard Features

- Complies with the guidelines for retrofit into fire rated frames
- No cutting on frame required for 4-7/8" ANSI prep
- Vertical adjustability to accommodate door sag and misalignment
- Tamper resistant
- Static strength 1,500 lbs
- Dynamic strength 70 ft-lbs
- Endurance 1 million cycles
- Field selectable fail safe/fail secure
- Non-handed
- Accommodates 1/2" – 5/8" [12.7mm – 15.9mm] cylindrical latchbolt (5/8" [15.9mm] with 1/8" [3.175] door gap)
- Strike body depth 1-1/16" [27.3mm]
- Plug-in connector
- SecuriCare five-year, no-fault, no questions asked warranty (Addition of SMART Pac® III extends the warranty to 10 years)

Optional Features

- **LBM** Latchbolt monitor

Accessories

- **2001M** Plug-in bridge rectifier
- **2004M** ElectroLynx® adapter
- **2005M3** SMART Pac® III
- **2006M** Plug-in buzzer



Grade 1



SecuriCare
Warranty



Cylindrical
Locksets



Field Selectable
(Fail secure
/Fail safe)



Dual Voltage
12/24



PoE
Friendly



Fire Rated



Outdoor
Rated



Burglary
Rated

hes.

ASSA ABLOY

Specifications

Certifications

- ANSI/BHMA A156.31, Grade 1
- UL 1034 burglary-resistant listed and suitable for outdoor use
- UL 294 listed
- RoHS compliant
- UL 10C fire rated, 3-hour single door (fail secure only)
- CAN/ULC-S104 fire door conformant
- NFPA-252 fire door compliant
- ASTM-E152 fire door compliant
- NFPA 80-07 compliant

Frame Application

- Metal
- Wood
- Aluminum

Electrical (DC Continuous Duty)

- Dual voltage 12/24 VDC/VAC
- 240 mA at 12 VDC/120 mA at 24 VDC
- PoE friendly

Dimensions

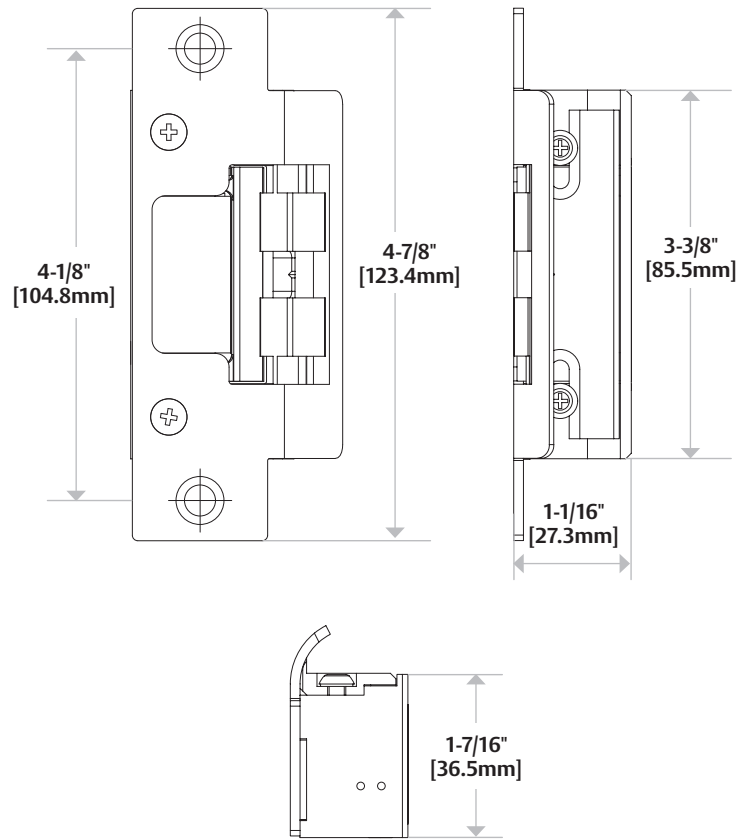

Diagram shown with 801 Option













How to Order

SERIES	MODEL	FINISH	OPTION (S)
8300	—	— 630	— LBM
8300 Universal Electric Strike; faceplates ordered separately	C* Complete Electric Strike; includes the 801 and 801A faceplates	605 Bright Brass 606 Satin Brass 612 Satin Bronze 613 Bronze Toned 629 Bright Stainless Steel 630 Satin Stainless Steel BLK Black	(blank) No Monitor LBM Latchbolt Monitor

*Complete Pacs are only available in the 630 finish

NOTE: Electric strike compatibility is determined at time of electric strike product release. ASSA ABLOY is not responsible for incompatibility of products that have changed in design or craftsmanship by their respective manufacturers. When compatibility is a concern, contact Customer Support for application assistance.

8000/8300 Series Faceplate Options

OPERATION	 After releasing the latchbolt, the keeper returns to the locked position.	
 <p>4-7/8" × 1-1/4" [123.8mm x 31.75mm] Square corners</p>	<p>801 Option</p> <p>For use with: Cylindrical locksets in ANSI metal jambs, with latchbolts up to 5/8" [15.9mm] throw.</p> <p>ANSI/BHMA Numbers: E05031, E09321, E09322, E09323</p>	
 <p>4-7/8" × 1-1/4" [123.8mm x 31.75mm] Radius corners and flat faceplate</p>	<p>801A Option</p> <p>For use with: Cylindrical locksets with latchbolts up to 5/8" [15.9mm] throw. Includes universal mounting tabs. Aluminum frames.</p> <p>ANSI/BHMA Numbers: E05031, E09321, E09322, E09323</p>	
 <p>4-7/8" × 1-1/4" [123.8mm x 31.75mm] 1/4" extended lip</p>	<p>801E Option</p> <p>For use with: Extended lip for 'knock-down' style frame installations. For use with cylindrical latchbolts up to 5/8" [15.9mm] throw.</p> <p>ANSI/BHMA Numbers: E05031, E09321, E09322, E09323</p>	
 <p>7-15/16" × 1-7/16" [201.6mm x 36.5mm]</p>	<p>802 Option</p> <p>For use with: Cylindrical locksets with latchbolts up to 5/8" [15.9mm] throw. Includes universal mounting tabs. Aluminum frames.</p> <p>ANSI/BHMA Numbers: E05031, #E09321, E09322, E09323</p>	
 <p>6-7/8" × 1-1/4" Radius corners and flat faceplate</p>	<p>803 Option</p> <p>For use with: Cylindrical locksets with latchbolts up to 5/8" [15.9mm] throw. Includes universal mounting tabs. Aluminum frames.</p> <p>ANSI/BHMA Numbers: E05031, E09321, E09322, E09323</p>	
 <p>9" × 1-3/8" [123.8mm x 34.9mm] Radius corners and flat faceplate</p>	<p>805 Option</p> <p>For use with: Cylindrical locksets. Latchbolts up to 5/8" [15.9mm] throw. Four point mounting for wood installations.</p> <p>ANSI/BHMA Numbers: #E05031, #E09321, #E09322, #E09323</p>	

"For use with" information is offered as a recommendation only. Reference should be made to the lockset manufacturer for proper installation instructions necessary to meet compatibility requirements.