

NTB No Touch Series

Hands-Free Activation Switch



Installation & Operating Instructions

Product Contents

- No Touch Hands-Free Activation Switch
- DC Line Powered Cable Adapter Harness
- Crimp Style Connectors (2)
- Screws (2) #6-32 x 1/2 machine screws

Recommended Tools

- Phillips #2 Screwdriver

Specifications

- **Detection Sensor Type** Infrared
- **Detection Mode** Motion (Bidirectional)
- **Detection Sensors** 1
- **Detection Range** Up to 4" [10 cm]
- **LED Status Indicator** Bi-Color Halo (Red/Green)
- **Input Power** 3 V Battery Powered (1.5 V AA LR6 Alkaline) or 12/24 V DC \pm 10%
- **Estimated Battery Life** 1 Year
- **Estimated Current Draw on Hard Power:**
 - » 66 mA at 12 VDC
 - » 66 mA at 24 VDC
- **Operating Mode** Selectable Time Relay (0.6, 2, 6, or 13 seconds)
- **Output(s)** 1x DPDT Relay 2 A at 30 VDC (1 A per Contact)
- **Environmental** -13°F to 131°F (-25°C to 55°C)

IMPORTANT: UL 294 compliance requires that the locking device be powered by a UL 294 (ALVY) or UL 609 (APHV) listed power supply.

UL294 Access Control Performance Levels

- Access Control Line Security Level I
- Destructive Attack Level I
- Standby Power Level I
- Endurance Level IV

Operation

To activate the No Touch Hands-Free Switch, make a slow waving motion with your hand within 4 inches (10 cm) of the front of the activation sensor.

Upon activation the hands-free switch will sound (1X) AUDIBLE TONE indicating that the relay has detected an object within range of the sensor and illuminate the LED circle on the front of the plate flashing (2X) SIGNALING ACTIVATION and triggering the relay for the predetermined amount of time as set by user with the provided jumpers.

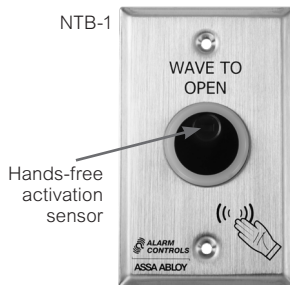

NTB-1



NTB-2



NTB-3

Low Battery Warning

(2x) flashing LED activations prior to standard operation behavior indicates the device has 20% or less of battery life remaining. Color will be inverted from standard operation as configured by jumper settings.

Obstruction Detection Warning

If an object remains in front of the activation sensor for greater than (5) seconds the hands-free switch will deactivate the relay and will sound (3x) audible tones followed by (3x) LED activations until activity is no longer detected.

NOTE: The LED color for the Obstruction Detection Warning is defined by the user when configuring jumper settings.

- If set to GREEN the warning flashes RED.
 - If set to RED the warning flashes GREEN.
-

INSTALLATION

Mounting

No Touch Hands-Free Switches can be surface mounted or recess mounted in single, double-gang or narrow stile junction boxes with 1-3/4" depth.

NOTE: If using with Automatic doors install in accordance with ANSI A156.10 & A156.19 based on the following ANSI/NEMA WD 6-2016 North American junction box installation types.

NOTE: Does NOT support the use of center mounted conduit knockouts.

- NTB-1 (2-3/4" x 4-1/2") Single-Gang
 - NTB-2 (4-1/2" x 4-1/2") Double-Gang
 - NTB-3 (1-3/4" x 4-1/2") Narrow-Stile
1. Bring wire through the top or bottom of the enclosure and provide a minimum of 6 inches for wiring connections.
 2. Make necessary electrical connections in accordance with Connections and Programming section.
 3. Use the Jumper Setting Options located on the back of the unit to configure the operating parameters.
 4. Attach the unit to the enclosure using the (2x) #6-32 machine screws provided.



CAUTION: Do NOT overtighten.

In-Wall

If using an in-wall junction box ensure that the enclosure is straight and flush with the wall surface.

Surface Mounted Box (Sold Separately)

If using a surface mount box, ensure that the enclosure has been secured properly and is level.

- **SMB-01** Single-gang surface mount box with (2) N/O tamper switches
- **SMB-01A** Single-gang surface mount box with (2) N/C tamper switches
- **SMB-3** Narrow-stile (1-3/4" wide) jamb surface mount box in a US28 clear-anodized aluminum finish
- **SMB-3D** Narrow-stile (1-3/4" wide) jamb surface mount box in a US40 Duranodic aluminum finish

CONNECTIONS & PROGRAMMING

Wiring

NOTE: Installation wiring for the product and wiring methods shall be in accordance with the National Electrical Code, ANSI/NFPA 70.

CAUTION: Do NOT apply power to the unit until all secondary wiring is complete, and jumpers have been set.

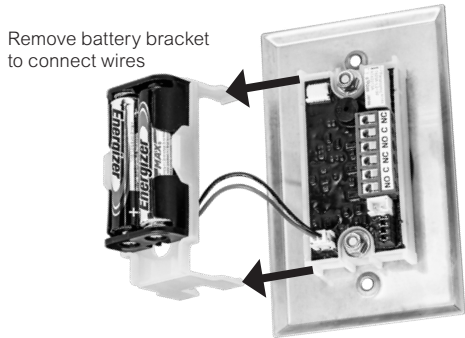

Sensor Activation

Battery Powered operation of the device activates the energy conservation mode. Below are the dynamic time sensing timings:

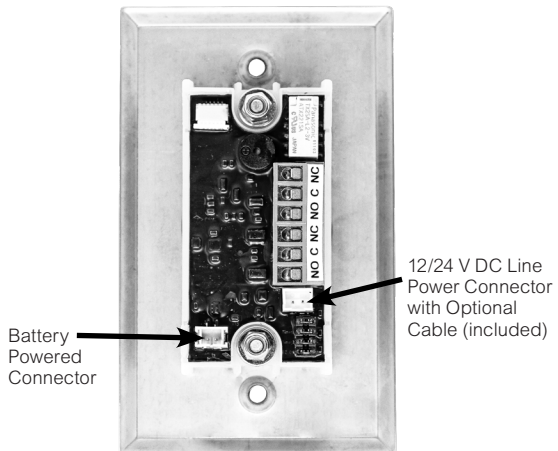

0 – 6:30 min	~0.3 sec
6:30 – 12:30 min	~0.6 sec
12:30 – 18:30 min	~0.8 sec
> 18:30 min	~1.1 sec

Line Powered DC operation is automatically detected when the DC Line Power Cable Adapter harness is installed and power is applied. The sensor defaults to detect activity in > ~0.2 second intervals.

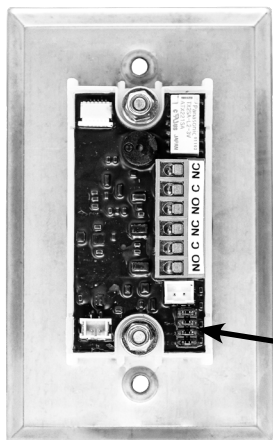

Jumper Setting Configuration



-  LED Color
-  Activation Time Relay
-  Audible Tone

LED Color

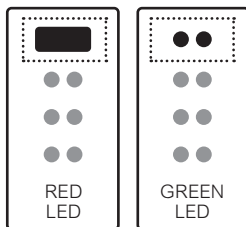

RED flashes **GREEN** in 0.5 second intervals when relay is active.

GREEN flashes **RED** in 0.5 second intervals when relay is active.

Activation Time Relay

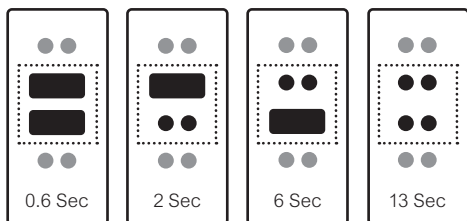

The latching relay **ONLY** consumes power when changing state and can be configured to a 0.6, 2, 6, or 13 second activation time relay based on the jumper positions.

Audible Tone

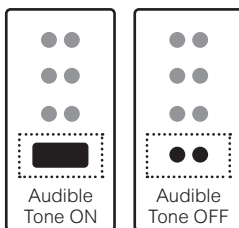

Audible Tone (ON) sounds followed by flashing LED when sensor activated.

Audible Tone (OFF) no sound followed by flashing LED when sensor is activated.

Warranty

For information on warranty coverage and replacement options, please visit alarmcontrols.com/en/about/warranty.



800 645 5538 | alarmcontrols.com
 10027 S. 51st Street, Ste. 102
 Phoenix, AZ 85044 USA

Printed in the U.S.A.

Patent pending and/or patent www.assaabloydss.com/patents

Copyright © 2021, Hanchett Entry Systems, Inc., an ASSA ABLOY Group company. All rights reserved. Reproduction in whole or in part without the express written permission of Hanchett Entry Systems, Inc. is prohibited. DOC0047_3