

Innovative Aluminum Raceway Profile Provides Increased Wiring Capacity

Available Factory Prewired

Introducing the next generation in innovative surface raceway systems. ALDS4000 Series™ Aluminum Raceway provides an aesthetically and functionally superior alternative to existing raceway profiles. ALDS4000 Series Raceway includes a variety of innovative features and fittings that save installation time, cost less to specify, and provide 1/3 more wiring capacity than conventional box-style raceway profiles.

ALDS4000 Series Raceway is a dual service aluminum raceway, with twin covers and a built-in divider that provides full isolation of services. With its increased capacity and unique downward-facing activation capabilities, ALDS4000 Series Raceway is ideal for any commercial, institutional, or industrial application requiring a high capacity metal raceway.

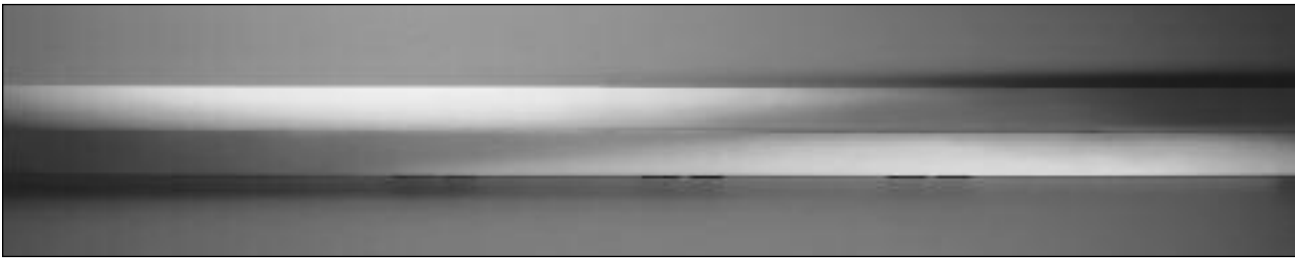

ALDS4000 Series Raceway prewired with streamlined downward facing power and data.

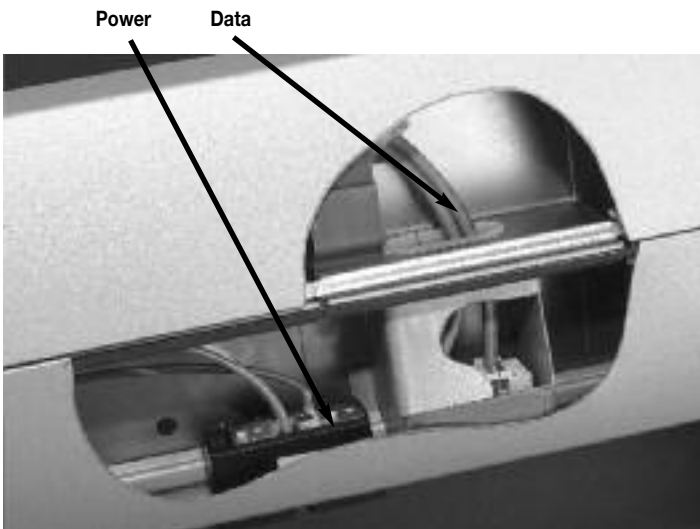

Sectioned view illustrating internal crossover capability, allowing adjacent downward facing power and data activations. Raceway profile meets or exceeds EIA/TIA bend radius requirements.



ALDS4000 Series Raceway installed with front data and power activations.

FEATURES & BENEFITS

ALDS4000™ Series Aluminum Raceway represents a significant advancement in both the design and functionality of surface-mounted raceway systems. Design improvements not only make the raceway easier to install and wire, they result in a more functional, higher capacity system with a more appealing, streamlined appearance. Unique adaptable fittings, multiple activation options, upgraded color options and a host of design improvements all contribute to the overall benefits and advantages of this innovative product. Listed below are the full range of improvements that have been incorporated into this industry-leading raceway system.

- **Innovative profile.** Accommodates greater wiring capacity and has a more aesthetic appearance than conventional box-shaped profiles. Design allows for more efficient use of raceway capacity and provides 1/3 more wiring capacity than conventional raceways including Wiremold 4000 Series™ Raceway.
- **Broad range of standard fittings.** Reduces the number of SKUs required for inventory, making ALDS4000 Series Raceway easy to specify, order and inventory.
- **Dual cover raceway.** True separation of services allows data and power installers to access their respective channels individually.
- **Full capacity channels.** Power and data can be fed through either raceway channel, with special cross-over fittings available to maximize raceway capacity and maintain separation of services.
- **Room to grow.** Generous bend radius and increased raceway capacity support newer and larger Cat 6a capacity cables. Raceway capacity accommodates increased power and data requirements in installations.
- **Meets or exceeds industry standards.** Conforms to UL, NEC, and NEMA standards and EIA/TIA recommendations.
- **Durable satin anodized finish.** Has aesthetically pleasing appearance that resists corrosion and fading. Available in custom colors.
- **Patented design.** 4000 Designer Series Aluminum Raceway profile and components are patent protected.
- **One-piece base and divider.** One-piece design reduces installation time.
- **Hardware included.** Each ten-foot [3.05m] section of base includes wire clips (8 clips, 4 pre-installed) and a pair of adjust-to-fit couplings. Adjust-to-fit™ couplings are also included with all raceway fittings.
- **Easy to install.** Adjust-to-Fit™ couplings (included with all fittings and base sections) provide up to four inches [102mm] of lateral adjustment, eliminating the need for precision cuts and reducing waste caused by measuring errors.
- **Cable bend radius control.** No need to order special fittings to meet bend radius compliance standards. All fittings include cable bend radius control and meet the specifications for Fiber Optic and UTP/STP cabling and exceed the TIA 569 requirements for communications pathways.
- **Activations accept industry-standard devices and device plates.** Compatible with a full-range of wiring, data, and communication products.
- **Available prewired.** ALDS4000 Series Raceway can be ordered factory prewired, saving installation time and money. Jobs are packed to individual job requirements and delivered on schedule to the job site.
- **Streamlined design.** Downward-facing activations provide a clean, streamlined appearance. (Prewired)
- **Visual circuit identification system included.** No need to order additional labels or marking systems. (Prewired)
- **Unique downward-facing activations.** Large bend radius for data cables and activations, streamlines the raceway appearance, and provides increased protection for both activations and cabling. Only raceway system that offers this feature. (Prewired)

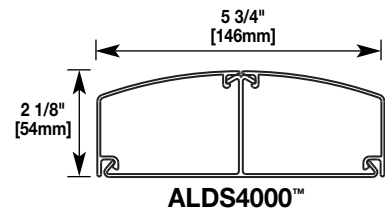

ALDS4000 Series Raceway System Layout

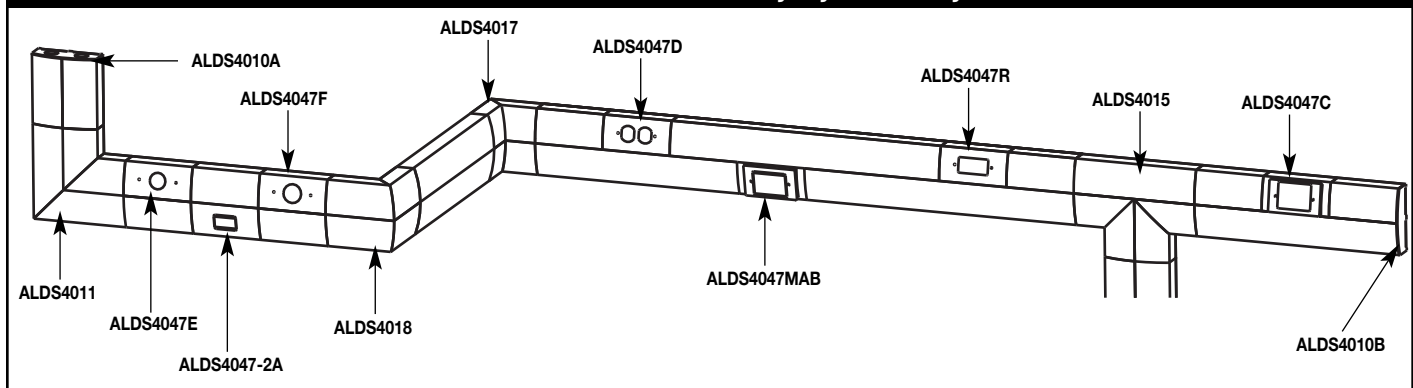

- ALDS4010A - Entrance End Fitting
- ALDS4011 - Flat Elbow
- ALDS4047E - Single Channel 1.41" [36mm] Device Plate
- ALDS4047-2A - Single Channel 2A Mini Adapter Bezel Device Plate
- ALDS4047F - Single Channel 1.59" [40mm] Device Plate
- ALDS4018 - External Elbow

- ALDS4047D - Single Channel Duplex Device Plate
- ALDS4047MAB - Single Channel MAB Device Plate
- ALDS4047R - Single Channel Decorator Device Plate
- ALDS4015 - Divided Tee
- ALDS4047C - Single Channel One-Gang Device Plate
- ALDS4010B - Blank End Fitting

ALDS4000 Series Raceway Wire Fill Capacity Charts

ALDS4000 Raceway Wire Fill Capacities for Power

WIRE SIZE THHN/THWN	O.D. Inches [mm]		NUMBER OF CONDUCTORS (40% FILL)			
			WITHOUT DEVICES	WITH DUPLEX/ RECT. DEVICE 1.59in. ² [1025mm ²]	WITH SURGE/ GFCI DEVICE 2.30in. ² [1485mm ²]	LARGE SINGLE RECEPTACLE 3.00in. ² [1935mm ²]
14 AWG	0.111	[2.8]	200	134	105	76
12 AWG	0.130	[3.3]	146	98	77	56
10 AWG	0.164	[4.2]	92	62	48	35
8 AWG	0.216	[5.5]	53	36	28	20
6 AWG	0.254	[6.5]	38	26	20	15

NOTE: For additional information, refer to the Technical Section of the current version of the Wiremold Catalog.

ALDS4000 Raceway Wire Fill Capacities for Communication

CABLE TYPE	CATEGORY/ DESIGNATION	O.D.		40% FILL 1/2 COMPARTMENT
		Inches	[mm]	
UNSHIELDED TWISTED PAIR	4-pair, 24 AWG Cat 3	0.190	[4.8]	68
	4-pair, 24 AWG Cat 5e	0.210	[5.3]	56
	4-pair, 24 AWG Cat 6	0.250	[6.3]	40
	4-pair, 24 AWG Cat 6a*	0.354	[8.5]	22
	25-pair, 24 AWG	0.360	[9.1]	19
COAXIAL	RG6/U	0.270	[6.9]	34
FIBER	ZipCord	0.118 x 0.236	[3 x 6]	70
	Round 4-Strand Fiber	0.187	[4.8]	71
	Round 6-Strand Fiber	0.256	[6.5]	38

* Category 6 Augmented cable for 10 gigabit ethernet – max allowed cable diameter per Addendum 11 to ANSI/TIA-568-B.2.

Prewired ALDS4000 Cover Wire Fill Capacities with Downward Facing Power & Data Devices

WIRE SIZE THHN/THWN	O.D. Inches [mm]	NO OF CONDUCTORS 40% FILL
14 AWG	0.111 [2.8]	30
12 AWG	0.130 [3.3]	22
10 AWG	0.164 [4.2]	14
8 AWG	0.216 [5.5]	8
6 AWG	0.254 [6.5]	6

NOTE: Prewired downward facing covers are punched in line for a sleek flush look. Power conductors are provided in the lower channel. Additional wires can be field installed and should not exceed totals above. Communications are to be installed in the top channel – refer to standard cable fill chart for capacities.

ALDS4000 Raceway Fittings Wire Fill Capacity Chart

WIRE SIZE THHN		O.D.		ALDS4011		ALDS4015		ALDS4017		ALDS4018	
		Inches	[mm]	40%	60%	40%**	60%**	40%**	60%**	40%**	60%**
THHN	14	0.111	[2.8]	122	182	49	73	75	112	133	199
	12	0.130	[3.3]	89	133	35	53	54	82	97	145
	10	0.164	[4.2]	56	84	22	34	34	51	61	92
	8	0.216	[5.5]	32	48	13	19	20	30	35	53
	6	0.254	[6.5]	23	35	9	14	14	21	25	38
UTP	2-pair, 24 AWG	0.150	[4.8]	67	100	27	40	41	61	73	109
	4-pair, 24 AWG Cat 3	0.190	[4.8]	42	62	17	25	25	38	45	68
	4-pair, 24 AWG Cat 5e	0.210	[5.3]	34	51	14	20	21	31	37	56
	4-pair, 24 AWG Cat 6	0.250	[6.3]	24	36	10	14	15	22	26	39
	4-pair, 24 AWG Cat 6a*	0.354	[9.0]	13	20	5	8	8	12	15	22
	25-pair, 24 AWG	0.410	[10.4]	12	17	5	7	7	11	13	19
Coaxial	RG6/U	0.270	[6.9]	21	31	8	12	13	19	22	34
Fiber	ZipCord	0.118 x 0.236	[3 x 6]	42	64	17	25	26	39	46	69
	Round 4-Strand Fiber	0.187	[4.8]	43	64	17	26	26	40	47	70
	Round 6-Strand Fiber	0.256	[6.5]	23	34	9	14	14	21	25	38

* Entrance end fitting fill rate is calculated using backfeed capability and radius inserts. Inserts are removable and fitting can obtain maximum raceway fill from utilizing end fitting knockouts and removing radius control inserts.

** Calculated using radius control inserts. Inserts are factory installed and may be removed if not required to obtain full raceway capacity.

ALDS4000 Series Raceway Fittings Ordering Information

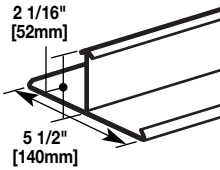
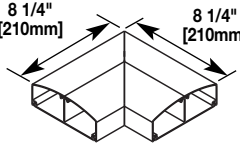
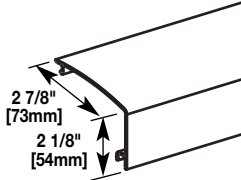
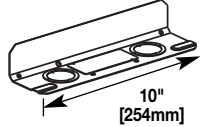
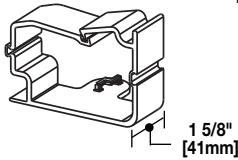
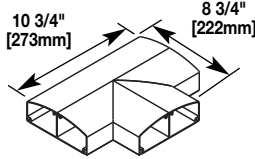
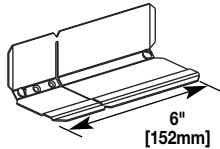
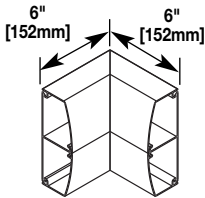
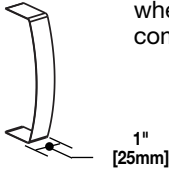
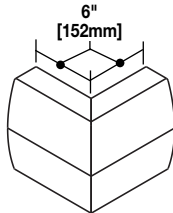
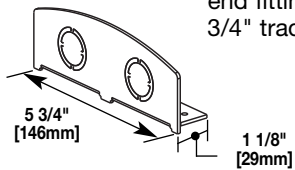
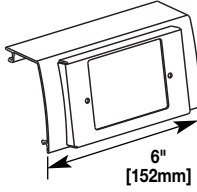
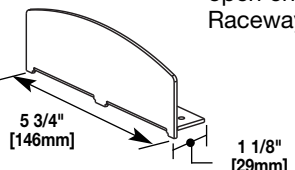
Catalog No./Item	Description/Specifications	Catalog No./Item	Description/Specifications
ALDS4000B	<p>Raceway Base – .060" [1.52mm] thickness aluminum. Packed four 10' [3.05m] lengths per carton.</p> 	ALDS4011	<p>Flat Elbow – 90° flat corner for new lay-in or pull-through installations.</p> 
ALDS4000C	<p>Raceway Cover – .050" [1.27mm] satin anodized finish. Packed eight 5' [1.5m] lengths per carton.</p> 	DS4014A	<p>Backfeed Coupling – Extra long coupling allows attachment to wall box or back fed 1" or 1 1/4" trade size conduit.</p> 
DS4000WC	<p>Wire Clip – For holding conductors in place.</p> 	ALDS4015	<p>Divided Tee Fitting – For new lay-in or pull-through installations.</p> 
DS4001	<p>Adjust-to-Fit™ Coupling – For joining lengths of ALDS4000B together. Sold in pairs.</p> 	ALDS4017	<p>90° Internal Elbow – Internal corner for new lay-in or pull-through installations.</p> 
ALDS4006	<p>Seam Clip – For covering seams where two sections of ALDS4000C come together.</p> 	ALDS4018	<p>90° External Elbow – External corner for new lay-in or pull-through installations.</p> 
ALDS4010A	<p>Entrance End Fitting – Full-capacity end fitting. Includes two 1/2" and 3/4" trade size KOs.</p> 	ALDS4047C	<p>Single Channel One-Gang Duplex Device Plate – Use with commercially-available single-gang flush plate.</p> 
ALDS4010B	<p>Blank End Fitting – For closing open end of ALDS4000B Raceway Base.</p> 		

ALDS4000 Series Raceway Fittings Ordering Information (continued)

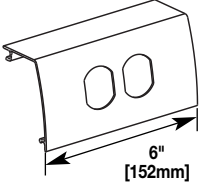
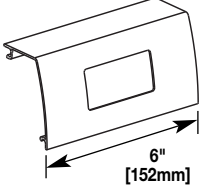
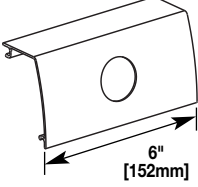
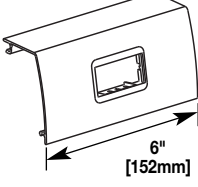
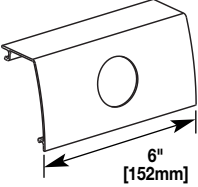
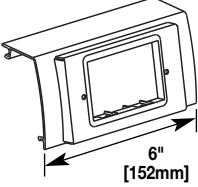
Catalog No./Item	Description/Specifications	Catalog No./Item	Description/Specifications
ALDS4047D	<p>Single Channel Duplex Device Plate – For 15A & 20A duplex receptacle or 106 style data frames. Includes mounting bracket.</p> 	ALDS4047R	<p>Single Channel Decorator Device Plate – For 15A and 20A decorator receptacles. Can also be used with decorator style communication outlets. Includes mounting bracket.</p> 
ALDS4047E	<p>Single Channel 1.41" [36mm] Device Plate – For straight blade and locking receptacles. Includes mounting bracket.</p> 	ALDS4047-2A	<p>Single Channel 2A Mini Adapter Device Plate – 2A opening. Includes adapters for Ortronics® TracJack™, Series II, Pass & Seymour® Activate™ inserts and Wiremold CM2 Series Open System communication modules.</p> 
ALDS4047F	<p>Single Channel 1.59" [40mm] Device Plate – For straight blade and locking receptacles. Includes mounting bracket.</p> 	ALDS4047MAB	<p>Single Channel MAB Device Plate – For installing Activate connectivity inserts. Provides flush installation. Includes adapters for Ortronics® TracJack™, Series II, Pass & Seymour® Activate™ inserts and Wiremold CM2 Series Open System communication modules.</p> 

ALDS4000 Series Prewired Aluminum Raceway Features

Features	Standard	Options
Communication Devices	Ortronics or Pass & Seymour Activate Connectivity System Devices	Other manufacturers
Electrical Devices	Pass & Seymour	Other manufacturers and some International devices
Base Length	Longest = 10' [2.54m], shortest = 1' [305mm]	—
Installation	Surface mounted	Downward Facing Activations; Front Facing Activations
Finish	Clear anodized	Clear anodized or Custom colors
Wire Type	THHN stranded	Options per specification
Wiring Splices	Insulation displacement connectors	Continuous wiring or twist-on wire connector
Grounding Conductors	Wire gauge per National Electrical Code (NEC) and shared grounding wires	Oversized and/or separate grounding wires
Device Identification	Gray self-adhesive polyester label with black letters	Self-adhesive engraved nameplate
Neutrals	Shared neutral	Oversized and/or separate neutral wires
Pigtails	12" [305mm] feeds and receptacle leads	Per specification
Conduit Feeds	Raceway drilled at job site	Entrance end cap
Record Drawings	3 sets and 2 copies of marked-up blueprints	Per job requirements
Submittal Services	Detailed submittal	Submittal free

Device and Raceway Labeling Detail for Prewired Applications

- Device labeling is available in the following materials:
 - Gray self-adhesive polyester label with black lettering (standard).
 - Other color self-adhesive polyester labels.
 - Engraved phenolic nameplates with adhesive backing.
- The back of the raceway is labeled with the raceway number and the room or area number(s).

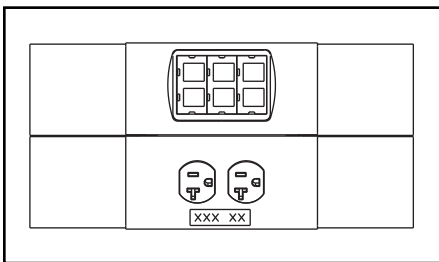

Labeling detail using the front activation plates.

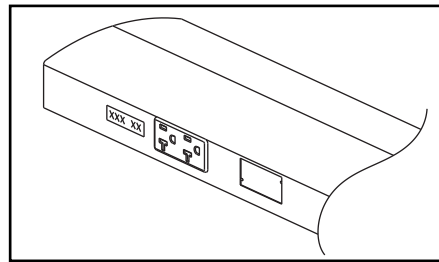

Labeling detail using the downward facing activation plates.

ALDS4000 Series Ordering Specifications for Prewired Applications

Two options available when ordering a prewired job:

- 1. Detailed Submittal** The detailed submittal will show exactly how each raceway run will be built including lengths, number and type of receptacles, wiring schematics, circuiting information, etc. The contractor and/or distributor must review, clarify any information not clearly indicated on the drawings or specs, approve, and return to the factory before production can begin.
- 2. Submittal Free** The Prewired Express Building Plan Checklist is filled out by the contractor or distributor and sent along with plans, casework, and specs to the factory. No submittal is required and the project is scheduled for production upon receipt of all necessary information.



Electrical Wiring Systems

60 Woodlawn Street
West Hartford, CT 06110
Phone: 1.877.BY.LEGRAND (295-3472)
www.legrand.us

570 Applewood Crescent
Vaughan, Ontario L4K 4B4
Phone: 905.738.9195
www.legrand.ca

