

# JascoPro™ Series Wi-Fi LED Landscape Lights, 22ft., 12 Pucks

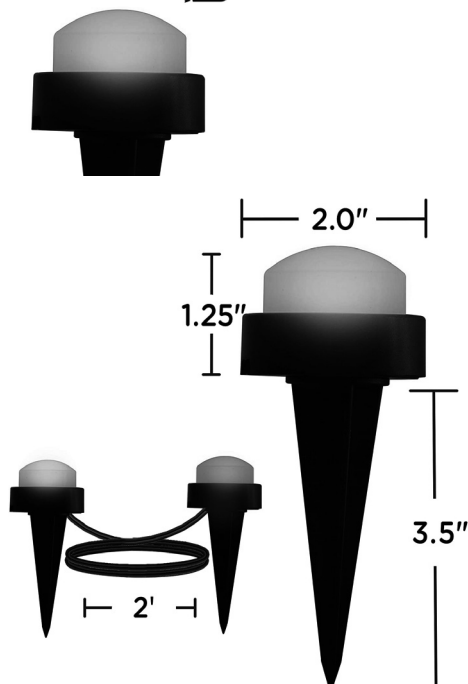

**MULTIPLE MOUNTING OPTIONS**  
Mount lights facing up, down or stake into the ground

**WEATHER PROOF**  
Commercial grade and UL-rated for permanent outdoor installation



## Specifications

**Length of fixture:** 22' **Lumens:** 40 per puck  
**Voltage:** 120 **Hertz:** 60 **CRI:** 81 **Nominal wattage:** 10  
**CCT:** 2200K - 6000K **Signal Frequency:** 2.4GHz  
**Operating Temperature Range:** -4 - 122° F (-20 - 50° C)  
**Lifetime:** 50,000 hours **Warranty:** 3-year limited warranty

## Design Features

- 12 commercial grade, mini metal puck light fixtures illuminate up to a 70-foot area
- Flexible spacing – includes 22ft. lead wire and 2ft. spacing between lights. Burial grade cable allows hiding excess cable under mulch or soil
- All-weather rated– Commercial grade and UL-rated for permanent outdoor installations
- Free JascoPro Series App – no hub required
- Wi-Fi or Bluetooth setup and control
- Manual control button for manual operation
- Mobile or voice control – works with Alexa and Hey Google
- Selectable color modes – Choose from 56 single colors; holidays & events presets, 2- and 3-color combinations to create your own
- Dimmable – Full-range dimming
- Selectable white – 2200K - 6000K
- Schedules and timers
- Flexible mounting options – Mount lights facing up, down or stake into the ground. Stakes included
- UL listed, FCC certified

## Additional Installation Information

- Landscape lights feature 22 AWG UV stabilized direct burial-grade cable. This allows you to conceal excess cable by directly burying it in the soil or covering it with garden bedding.
- When mounting lights up, use the keyholes on the back or ear-tabs on the side — screws not included.
- Use #6 pan head screws (not included) to mount each puck to a solid support structure such as joists, beams, studs and more.

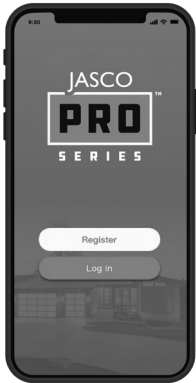

### EASY APP CONTROL

Download the free JascoPro Series app to control your devices from anywhere.

### MULTIPLE MOUNTING OPTIONS FOR UP OR DOWN LIGHTING

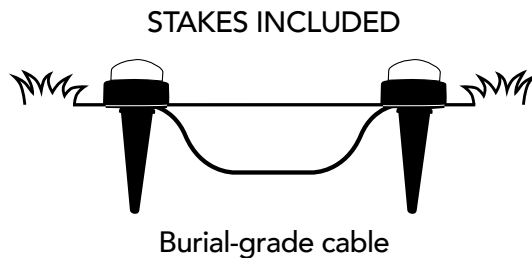
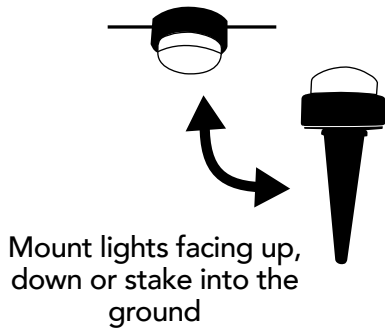

### FLEXIBLE SPACING UP TO 2 FEET

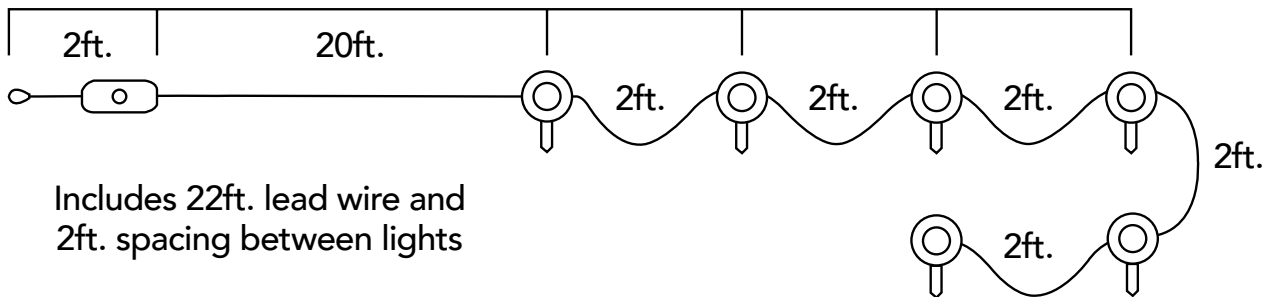

Includes 22ft. lead wire and 2ft. spacing between lights

### Certifications & Compliances



Compliances, specifications and availability are subject to change without notice

Distributed by Jasco Products Company LLC  
10 E. Memorial Rd., Oklahoma City, OK

Questions? Contact our U.S.-based Consumer Care at 1-800-654-8483 between 7AM-8PM, M-F, Central Time.

©Jasco 2022



# SMART MINI COLOR-CHANGING LANDSCAPE LIGHTS™

Model - 66870, 66871

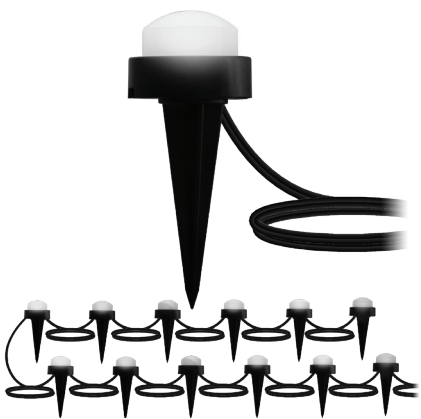

BY  
JASCO®

**NOTE:** Before installation, please read all the warning statements included at the bottom of these instructions.

## SETUP

Your landscape lights feature burial-grade cable. This allows you to conceal excess cable by directly burying it in the soil or covering it with garden bedding.

1. Unpack your lights and dispose of wire ties and plastic bag (see warning on bottom).
2. Plug lights into GFCI receptacle and pair the lights to ensure proper operation (see "Remotely operate" section for details).
3. From the GFCI, organize the lights in the manner you would like them to be installed.

**NOTE:** The first light can be 20ft. from the power supply, following lights can be spaced up to 2ft. from each other.

## INSTALLATION

### MOUNT POWER SUPPLY

Use the keyholes on the back or ear-tabs on the side — screws not included.

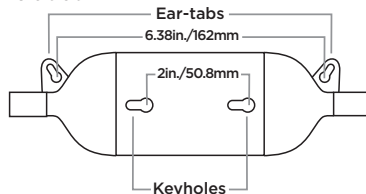

**IMPORTANT:** Do not lay power supply on the ground or where water may accumulate.

### GROUND MOUNTING

Place light directly onto ground or garden bedding.

### STAKE MOUNTING

Insert the stake into the keyhole slot on the bottom of the puck. Firmly plant it into soil or garden bedding.

**NOTE:** If it requires more than a firm push, loosen the soil or remove debris.

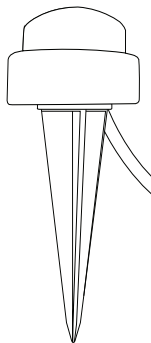

## CORD MANAGEMENT

Gently pack soil or garden bedding to conceal each length of burial-grade cable.

### FLAT-SURFACE MOUNTING

Use #6 pan head screws (not included) to mount each puck to a solid support structure, such as joists, beams, studs and more.

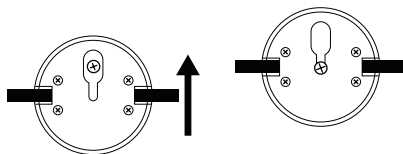

### CONNECT TO POWER

With everything installed, plug in the lights to the outdoor GFCI receptacle.

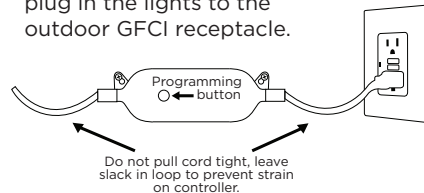

Remotely operate your smart landscape lights with the easy-to-use JascoPro Series app. Follow the available instructions and resources to set up your smart device.



**1** **DOWNLOAD THE APP**



Scan the QR code above or search JascoPro Series on the Apple App Store or on Google Play



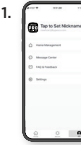

**2** **SET UP ACCOUNT**

1. 
2. 

Create an account in the JascoPro Series app

Add devices, control the smart landscape lights from anywhere and create schedules

**3** **INSTALL THE SMART DEVICE**

1.  Install the smart landscape lights
2.  Plug the landscape lights into the GFCI outlet

**4** **VOICE CONTROL**

Compatible with Amazon Alexa and Google Assistant



Follow the steps in the Amazon Alexa or Google Assistant app to connect the JascoPro Series app or select "Support" in the JascoPro Series app

## MANUAL OPERATION

Press the button on the power supply to cycle through each of the following color settings:

1. OFF
2. White, 100% brightness
3. White, 50% brightness
4. White, 25% brightness
5. Color fade
6. Red
7. Green
8. Blue
9. Yellow
10. Purple
11. Pink
12. Orange
13. Teal
14. Holiday
15. 4th of July
16. Rainbow
17. Twinkle

## IMPORTANT – PLEASE READ

Refer to the manual or visit [www.byjasco.com](http://www.byjasco.com) for limitations and restrictions on warranties and the product registration information.

**WARNING:** When using outdoors use portable luminaires, basic safety precautions should always be followed to reduce the risk of fire, electrical shock, and personal injury, including the following:

Ground fault circuit interrupter (GFCI) protection is to be provided on the circuit(s) or outlet(s) to be used for the wet location portable luminaire. Receptacles are available having built-in GFCI protection and are able to be used for this measure of safety.

**WARNING:** Keep these bags away from babies and children. Do not use in cribs, beds, carriages, or playpens. The thin film may cling to nose and mouth and prevent breathing.

**WARRANTY INFORMATION:** This Jasco product is warranted for three years with a limited-lifetime replacement warranty on JascoPro Series LED light source only. This product is intended (and/or designed) for horizontal hanging. Vertical hanging of the product can void the product warranty.

Suppliers Declaration of Conformity | Model #: 66870, 66871 | Jasco Products Co., 10 E. Memorial Rd., Oklahoma City, OK 73114, [www.byjasco.com](http://www.byjasco.com)

This device complies with Part 15 of the FCC and Industry Canada license-exempt RSS standards. Operation is subject to the following two conditions: (1) this device may not cause harmful interference, and (2) this device must accept any interference received, including interference that may cause undesired operation.

**FCC NOTE:** The manufacturer is not responsible for any radio or TV interference caused by unauthorized modifications to this equipment. Such modifications could void the user's authority to operate the equipment.

**NOTE:** This equipment has been tested and found to comply with the limits for a Class B digital device, pursuant to Part 15 of the FCC Rules. These limits are designed to provide reasonable protection against harmful interference in a residential installation. This equipment generates, uses and can radiate radio frequency energy, and if not installed and used in accordance with the instructions, may cause harmful interference to radio communications. However, there is no guarantee interference will not occur in a particular installation. If this equipment does cause harmful interference to radio or television reception, which can be determined by turning the equipment off and on, the user is encouraged to try to correct the interference by one or more of the following measures:

- Reorient or relocate the receiving antenna.
- Increase the separation between the equipment and receiver.
- Connect the equipment into an outlet on a circuit different from which the receiver is connected.
- Consult the dealer or an experienced radio/TV technician for help.

Electrical Ratings  
Input: 120V, 50/60Hz

Model No.	Input watt, Max.	Location Use
66870	10W	Wet
66871	32W	

# Thank you for your purchase!



## Instructions made easy

Read instructions or watch easy-to-follow video.

Scan code or visit [byjasco.com/66870i](http://byjasco.com/66870i)



## Product registration

For exclusive deals, to register your purchase and to tell us how we're doing, simply scan the code or visit [byjasco.com/register-your-product](http://byjasco.com/register-your-product)

## ⚠ WARNING

### RISK OF ELECTRIC SHOCK

- OUTLETS USED FOR POWERING LANDSCAPE LIGHTS SHALL COMPLY WITH ALL NATIONAL AND LOCAL ELECTRICAL CODES. CONSULT LOCAL ELECTRICIAN IF UNSURE OF COMPLIANCE REQUIREMENTS.
- FOR USE ONLY ON GFCI PROTECTED CIRCUITS.
- DO NOT SUBMERSE.
- DO NOT USE AROUND AQUARIUMS.
- LANDSCAPE LIGHTS ARE A WET LOCATION PRODUCT AND HAVE NO SERVICEABLE PARTS.
- DO NOT USE WITH EXTENSION CORD NEAR WATER OR WHERE WATER MAY ACCUMULATE.
- KEEP LAMPS AT LEAST 16FT. FROM POOLS AND SPAS.
- KEEP PLUGS AND RECEPTACLES DRY.
- AVOID DAMAGE TO THE CORDS AND LAMP ASSEMBLIES DURING INSTALLATION. PERIODICALLY INSPECT THE LANDSCAPE LIGHTS FOR PHYSICAL DAMAGE OR OTHER DAMAGE CAUSED BY OUTDOOR EXPOSURE TO THE ELEMENTS.
- REPLACE ANY DAMAGED LANDSCAPE LIGHTS.
- DO NOT INSTALL IN LOCATIONS WHERE LANDSCAPE LIGHTS CAN BE STEPPED ON.
- ENSURE LANDSCAPE LIGHTS ARE UNPLUGGED FROM POWER DURING INSTALLATION.
- CHILDREN SHOULD NOT BE ALLOWED TO PLAY WITH LANDSCAPE LIGHTS.

- UL RECOMMENDS TESTING GFCI CIRCUITS AND RECEPTACLES EVERY MONTH TO ENSURE PROPER OPERATION.

### RISK OF FIRE

- LANDSCAPE LIGHTS ARE DESIGNED TO BE MOUNTED WITH THEIR INDIVIDUAL KEYHOLE MOUNTING FEATURE, DO NOT MOUNT LANDSCAPE LIGHTS BY USING THE MAIN ELECTRICAL CORD.
- NOT INTENDED FOR INSTALLATION IN CEILING, SOFFITS, CABINETS, ATTICS, OR OTHER ENCLOSED SPACES.

10/01/2021 v1

App Store is a service mark of Apple Inc. Google and Google Play are trademarks of Google LLC. Amazon, Alexa and all related logos are trademarks of Amazon.com, Inc. or its affiliates.

MADE IN CHINA

Distributed by Jasco Products Company LLC,  
10 E. Memorial Rd., Oklahoma City, OK 73114.

This Jasco product comes with a 3-year limited warranty. Visit [www.byjasco.com](http://www.byjasco.com) for warranty details.

Questions? Contact our U.S.-based Consumer Care at 1-800-654-8483 between 7AM-8PM, M-F, Central Time.



# INTELIGENTE LUCES CON CAMBIO DE COLORES EN MINIATURA LANDSCAPE LIGHTS™

Modelo - 66870, 66871

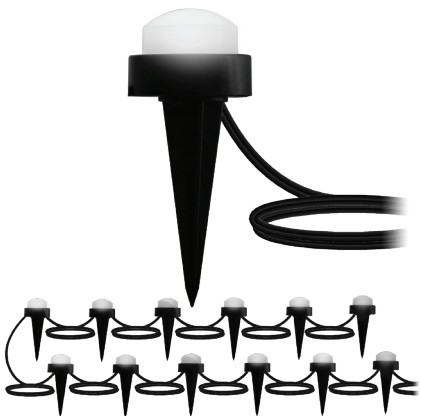

**NOTA:** Antes de la instalación, lea todas las advertencias que se incluyen al final de estas instrucciones.

## PREPARACIÓN

Su cuenta con cable para entierro. Esto le permite ocultar el exceso de cable enterrándolo directamente en el suelo o cubriéndolo con ropa de cama de jardín.

1. Saque las luces del empaque y deseche los alambres de sujeción y la bolsa de plástico (consulte la advertencia en la parte inferior).
2. Enchufe las luces en un tomacorriente GFCI y empareje las luces para asegurarse de que funcionan correctamente (consulte la sección "Opere de forma remota" para más detalles).
3. Desde el tomacorriente GFCI, organize las luces de la manera en que desea que se instalen.

**NOTA:** La primera bombilla puede colocarse a una distancia de hasta 6m (20ft.) del controlador, cada una de las siguientes bombillas puede colocarse a una distancia de hasta 0.6m (2ft.) de la anterior.

## INSTALACIÓN

### MONTE LA FUENTE DE ALIMENTACIÓN

utilizando los ojos de cerradura en la parte posterior o las orejeras en el lateral – tornillos no incluidos.

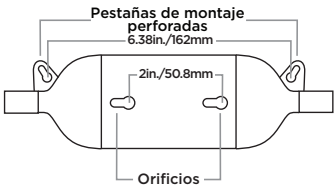

**IMPORTANTE:** No coloque la fuente de alimentación directamente en el suelo o donde se pueda acumular agua estancada.

### MONTAJE EN TIERRA

Coloque la bombilla directamente sobre el suelo o el mantillo del jardín.

### ESTACA DE MONTAJE

Inserte la estaca en la ranura del ojo de la cerradura en la parte inferior del disco. plantéelo firmemente en el suelo o el mantillo del jardín.

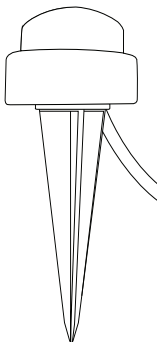

**NOTA:** Si la estaca requiere más que un empujón firme, afloje la tierra o elimine los escombros.

## GESTIÓN DE CABLES

Con cuidado, apisona tierra o lecho del jardín para ocultar cada tramo de cable apto para enterrar.

### MONTAJE SOBRE UNA SUPERFICIE PLANA

Use tornillos de cabeza plana n.º 6 (no provistos) para montar cada disco en una estructura de soporte sólida, como vigas, viguetas, travesaños, etc.

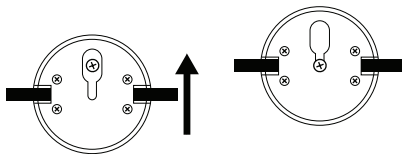

### CONECTE A LA ENERGÍA

Con todo instalado, enchufe las luces en el tomacorriente GFCI para exteriores.

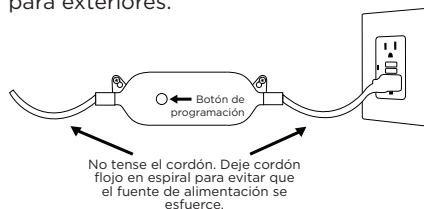

Opere de forma remota sus luces de inteligente jardín con la app JascoPro Series fácil de usar. Siga las instrucciones y los recursos disponibles para configurar su dispositivo inteligente.

**1**

### DESCARGUE LA APP

Escanee el código QR anterior o busque JascoPro Series en App Store de Apple o en Google Play

Download on the App Store

DISPONIBLE EN Google Play

**2**

### CREE LA CUENTA

1. Cree una cuenta en la app JascoPro Series
2. Agregue dispositivos, controle las luces inteligentes de la jardín desde cualquier lugar y cree horarios

**3**

### INSTALE EL DISPOSITIVO INTELIGENTE

1. Instale las luces de paisaje inteligentes
2. Enchufe las luces del paisaje en el tomacorriente GFCI

**4**

### CONTROL POR VOZ

Compatible con Amazon Alexa y Google Assistant

compatible con alexa

funciona con Hey Google

Siga los pasos en la app de Amazon Alexa o Google Assistant para conectar la app JascoPro Series o seleccione "Apoyo" en la app JascoPro Series

## OPERACIÓN MANUAL

Presione el botón pulsador en la fuente de alimentación para activar una de las siguientes configuraciones de colores:

1. APAGADO
2. Blanco, 100% brillo
3. Blanco, 50% brillo
4. Blanco, 25% brillo
5. Desvanecimiento del color
6. Rojo
7. Verde
8. Azul
9. Amarillo
10. Morado
11. Rosa
12. Naranja
13. Verde azulado
14. Fiesta
15. 4 de Julio
16. Arcoíris
17. Centelleo

## IMPORTANTE, LEER

Consulte el manual o visite [www.byjasco.com](http://www.byjasco.com) para obtener información sobre las limitaciones y restricciones de la garantía y la información para registrar el producto.

**ADVERTENCIA:** Cuando utilice luminarias portátiles para exterior, siempre respete las precauciones básicas para reducir el riesgo de incendio, descargas eléctricas y lesiones a personas, incluidas las siguientes:

Proteja los circuitos o los tomacorrientes que utilizará para alimentar las luminarias portátiles en lugares húmedos mediante un interruptor de circuito de falla de puesta a tierra (GFCI). Es posible conseguir tomacorrientes con protección GFCI incorporada para cumplir con esta medida de seguridad.

**ADVERTENCIA:** Mantenga las bolsas lejos del alcance de bebés y niños. No use en cunas, camas, cochecitos ni corralitos para bebés. Su capa fina puede pegarse a la nariz y la boca, lo que impide la respiración.

**INFORMACIÓN SOBRE LA GARANTÍA:** Este producto de Jasco tiene una garantía de tres años y una garantía limitada de por vida únicamente para los repuestos de la fuente de luz LED JascoPro Series. Este producto está diseñado para colgarse horizontalmente. Colgar el producto verticalmente puede anular la garantía del producto.

Declaración de conformidad del proveedor | Modelo #: 66870, 66871 | Jasco Products Co., 10 E. Memorial Rd., Oklahoma City, OK 73114, [www.byjasco.com](http://www.byjasco.com)

Este dispositivo cumple con las normas RSS de exención de licencia de la Parte 15 de la FCC y de Industry Canada. Su funcionamiento está sujeto a las siguientes dos condiciones: (1) este dispositivo no podrá causar interferencias perjudiciales, y (2) este dispositivo debe aceptar cualquier interferencia recibida, incluidas las interferencias que puedan causar un funcionamiento no deseado.

**NOTA DE LA FCC:** El fabricante no se responsabiliza por ninguna interferencia de radio o TV causada por modificaciones no autorizadas a este equipo. Tales modificaciones podrían anular el derecho del usuario a hacer uso del equipo.

**NOTA:** Este equipo se sometió a pruebas y cumple con los límites establecidos para un dispositivo digital Clase B de acuerdo con la Parte 15 de las Normas de la FCC. Dichos límites están diseñados para proporcionar una protección razonable contra la interferencia perjudicial en una instalación residencial. Este equipo genera, usa y puede irradiar energía de radiofrecuencia. Si no se instala y usa de acuerdo con estas instrucciones, podrá causar interferencia perjudicial a las radiocomunicaciones. Por otro lado, tampoco es posible garantizar que no ocurrirán interferencias en una instalación en particular. Si este equipo causa interferencias perjudiciales en la recepción de radio o televisión, las cuales pueden comprobarse encendiendo y apagando el equipo, se recomienda al usuario que intente corregir la interferencia adoptando una o más de las siguientes medidas:

- Cambiar la orientación o ubicación de la antena receptora.
- Aumentar la distancia entre el equipo y el receptor.
- Conectar el equipo a la salida de un circuito diferente al cual está conectado el receptor.
- Consultar al distribuidor o a un técnico de radio o TV experimentado para obtener ayuda.

Especificaciones eléctricas

Entrada: 120V, 50/60Hz

Modelo n.º	Potencia de entrada máx	Lugar de uso
66870	10W	Húmedo
66871	32W	Húmedo

# ¡Gracias por su compra!



## Instrucciones fáciles

Lea las instrucciones o mire el video con el paso a paso.

**Escanee el código o visite [byjasco.com/66870i](http://byjasco.com/66870i)**



## Registración del producto

Para acceder a ofertas exclusiva, registrar su compra y darnos su opinión sobre nosotros, tan solo escanee el código o **[byjasco.com/register-your-product](http://byjasco.com/register-your-product)**

## ⚠️ ADVERTENCIA

### RIESGO DE DESCARGA ELÉCTRICA

• LOS TOMACORRIENTES QUE SE UTILICEN PARA ALIMENTAR LAS LUCES DEBEN CUMPLIR CON LOS CODIGOS ELÉCTRICOS LOCALES Y NACIONALES. CONSULTE CON UN ELECTRICISTA LOCAL SI NO ESTÁ SEGURO SOBRE LOS REQUISITOS NORMATIVOS.

• SOLO SE DEBE UTILIZAR CON CIRCUITOS PROTEGIDOS MEDIANTE GFCI.

• NO SUMERGIR.

• NO USAR CERCA DE ACUARIOS.

• LAS LUCES ES UN PRODUCTO APTO PARA LUGARES HÚMEDOS Y NO CONTIENE PIEZAS QUE PUEDAN SER REPARADAS POR EL USUARIO.

• NO USAR CON CABLES DE EXTENSIÓN, CERCA DEL AGUA O EN ÁREAS EN LAS QUE PUEDE ACUMULARSE AGUA.

• MANTENER LAS BOMBILLAS A UNA DISTANCIA MÍNIMA DE 48M (16 PIES) DE PISCINAS Y SPAS.

• MANTENGA SECCOS LOS ENCHUFES Y LOS TOMACORRIENTES.

• EVITE DAÑAR LOS CABLES Y LAS BOMBILLAS DURANTE LA INSTALACIÓN. REVISE PERIÓDICAMENTE LAS LUCES A FIN DE DETECTAR DAÑOS FÍSICOS U OTROS DAÑOS PROVOCADOS POR LA EXPOSICIÓN A LA INTemperie.

• REEMPLACE LAS LUCES QUE ESTÉN DAÑADAS.

• NO INSTALE LAS LUCES EN LUGARES EN QUE SEA PROBABLE PISARLA.

• ASEGURESE DE QUE LAS LUCES ESTE DESENCHUFADA DURANTE LA INSTALACIÓN.

• DE ACUERDO CON LA NORMA UL, SE RECOMIENDA PROBAR LOS TOMACORRIENTES Y LOS CIRCUITOS GFCI TODOS LOS MESES PARA GARANTIZAR SU CORRECTO FUNCIONAMIENTO.

### RIESGO DE INCENDIO

• LAS LUCES ESTÁ DISEÑADA PARA COLOCARSE CON LAS OREJETAS DE MONTAJE INDIVIDUALES. NO LA SUJETE CON UN CABLE ELÉCTRICO PRINCIPAL NI CON CABLES DE BAJA TENSION INDIVIDUALES.

• NO INSTALAR EN TECHOS, SÓFITOS, ARMARIOS, DESVANE Y OTROS LUGARES CERRADOS.

App Store es una marca de servicio de Apple Inc. Google y Google Play son marcas de Google LLC. Amazon, Alexa y todos los logotipos relacionados son marcas registradas de Amazon.com, Inc. o sus filiales.

HECHO EN CHINA

Distribuido por Jasco Products Company LLC, 10 E Memorial Rd., Oklahoma City, Oklahoma 73114.

Este producto de Jasco tiene una garantía limitada de 3 años. Visite [www.byjasco.com](http://www.byjasco.com) para conocer los detalles de la garantía.

¿Preguntas? Comuníquese al 1-800-654-8483 entre las 7AM y las 8PM hora estándar del centro.

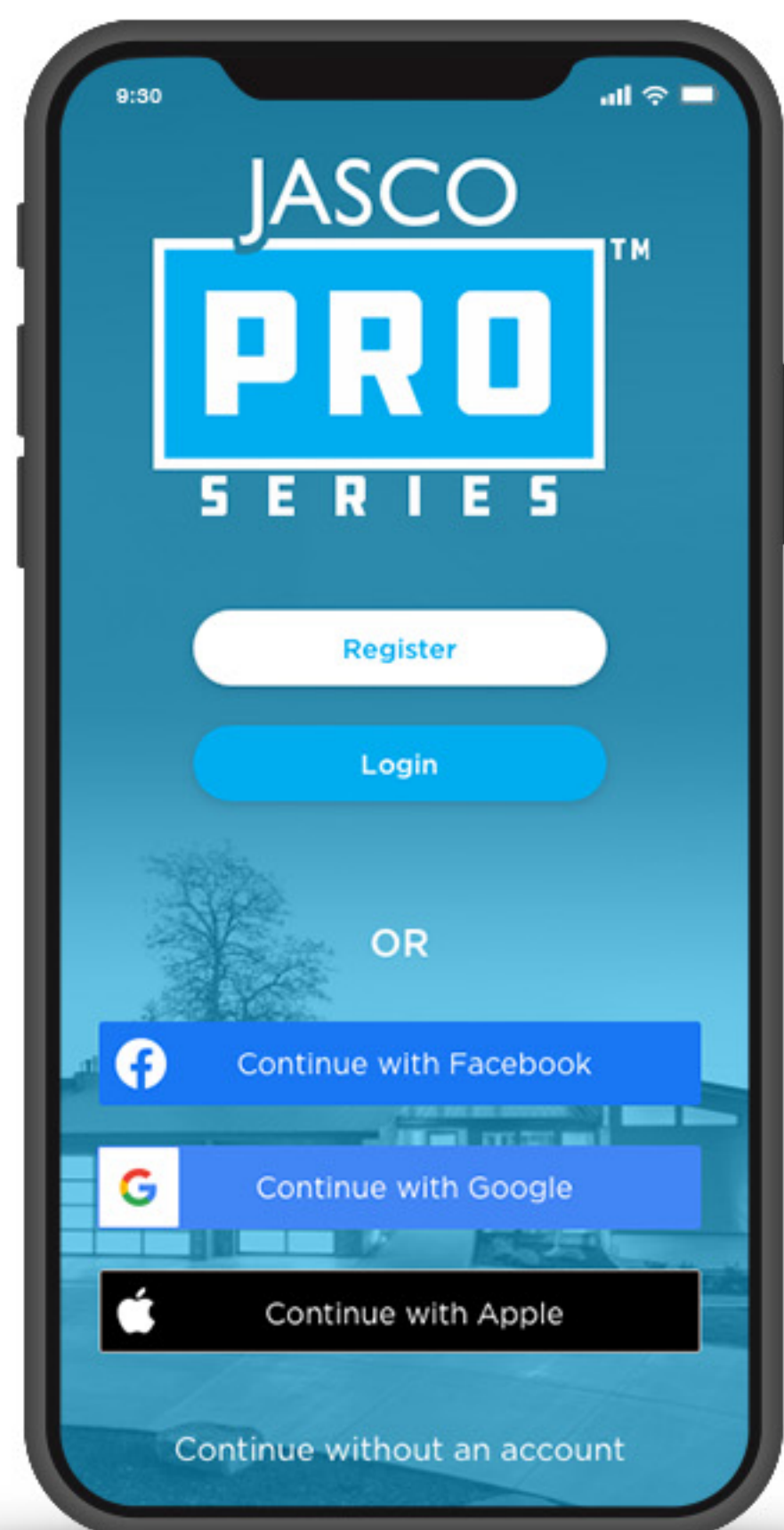
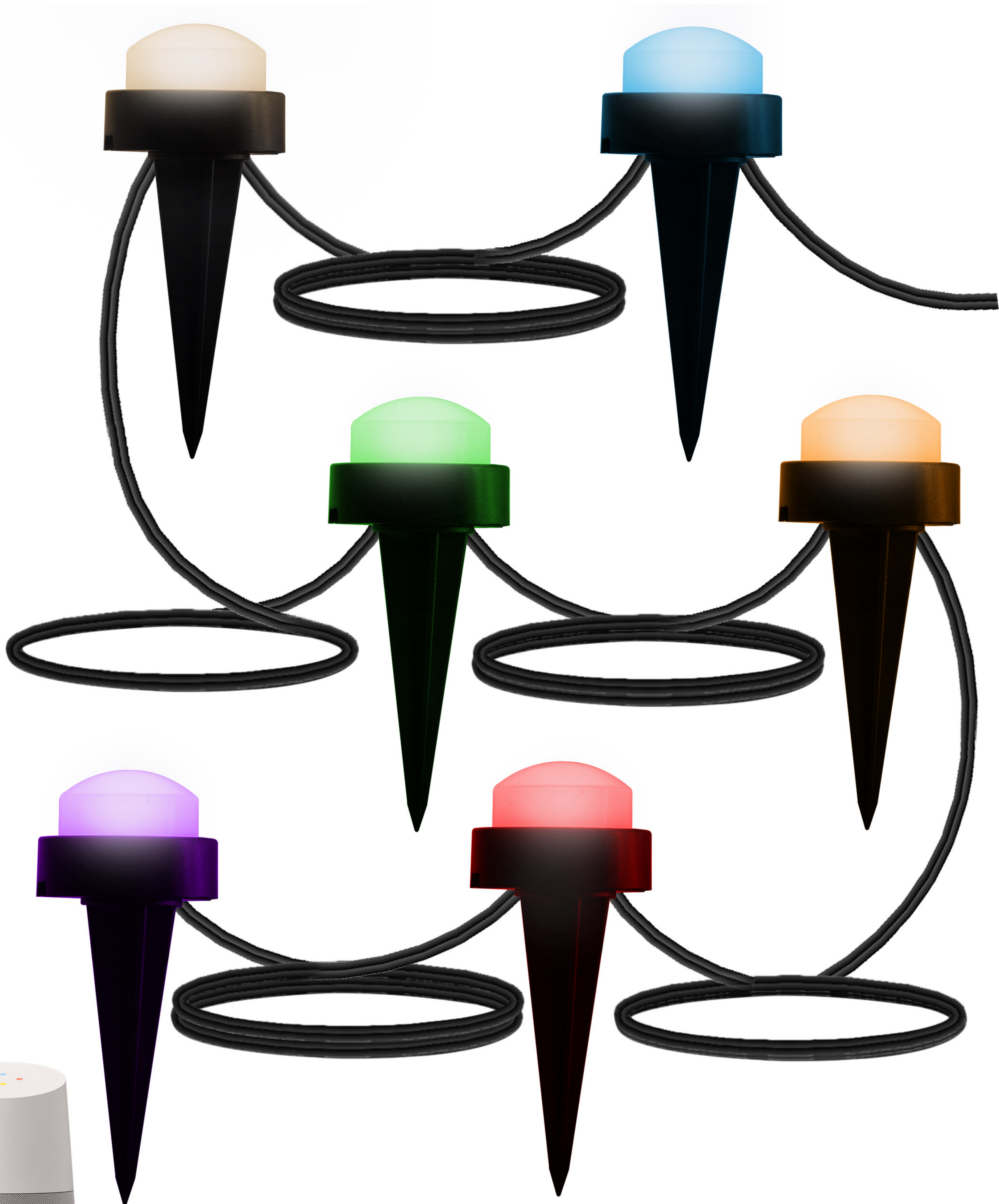

# VOICE CONTROL

No hub required

Works with **Amazon Alexa**  
or **Hey Google** when  
connected through your  
**JascoPro Series™** app

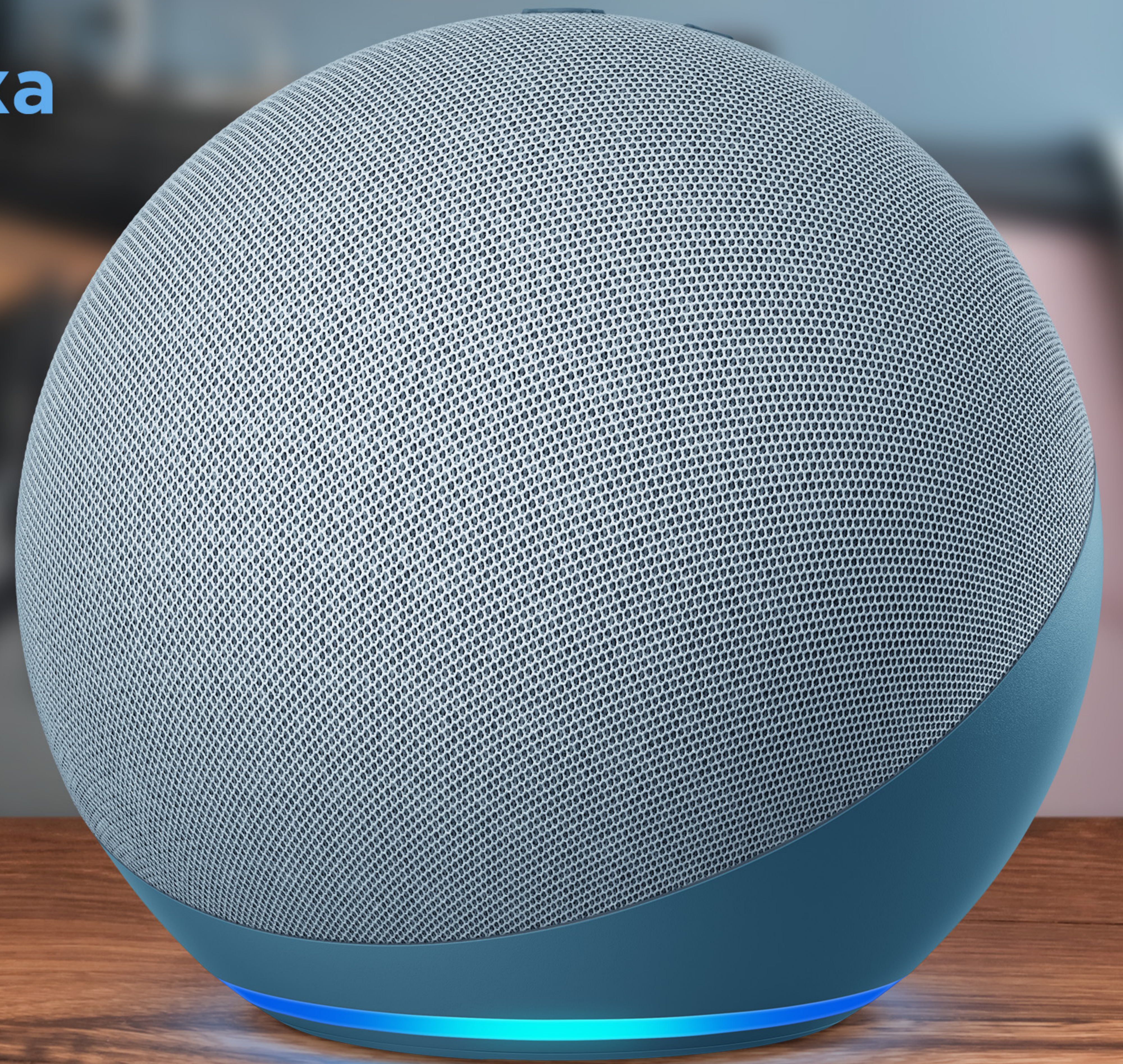



▶ 12 lights, 22ft.

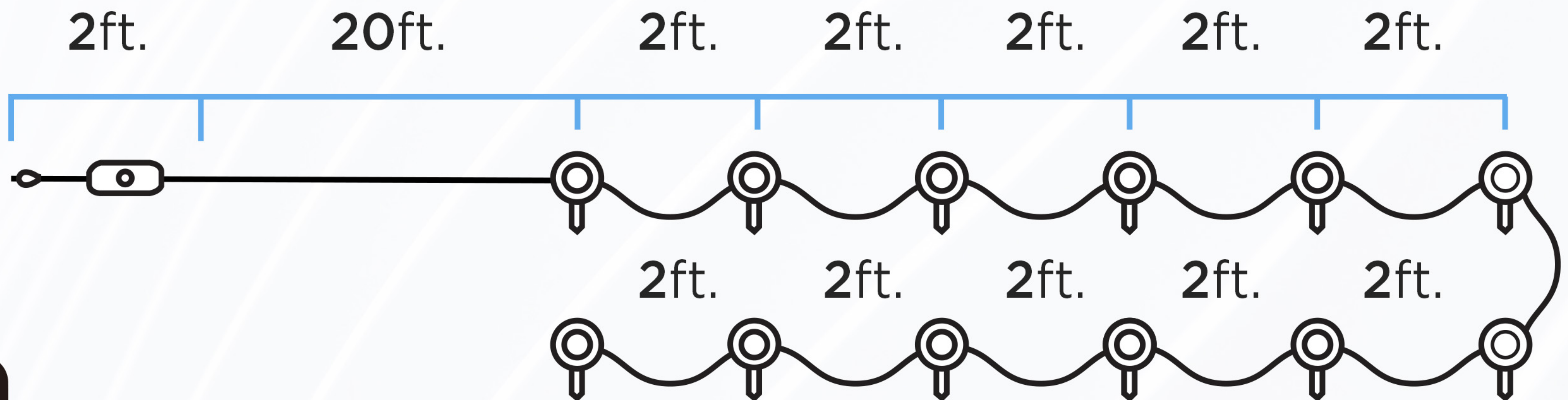
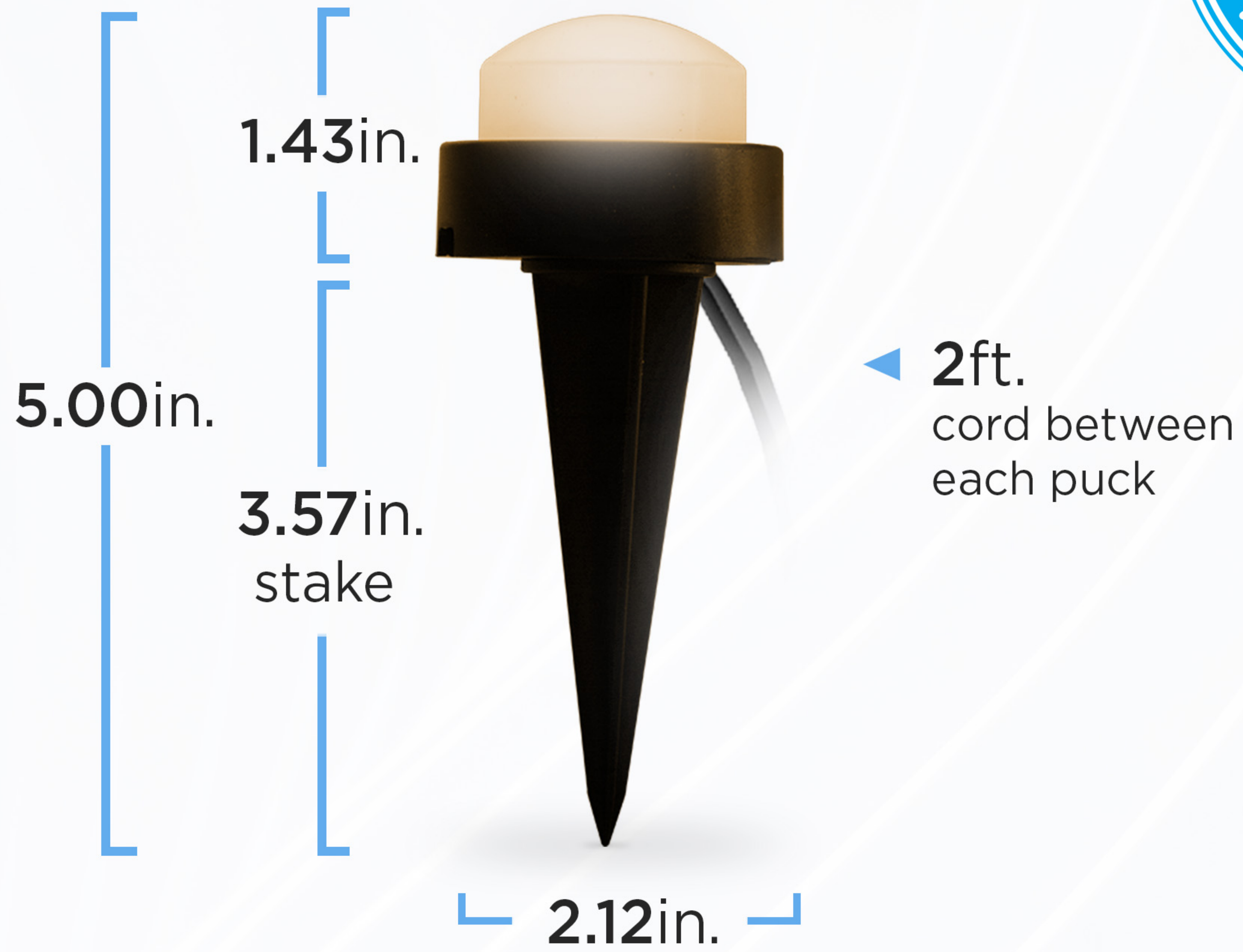

# Wi-Fi Control

- Customizable color modes
  - Full-range dimming
  - Speed adjustments
- ...and much more!

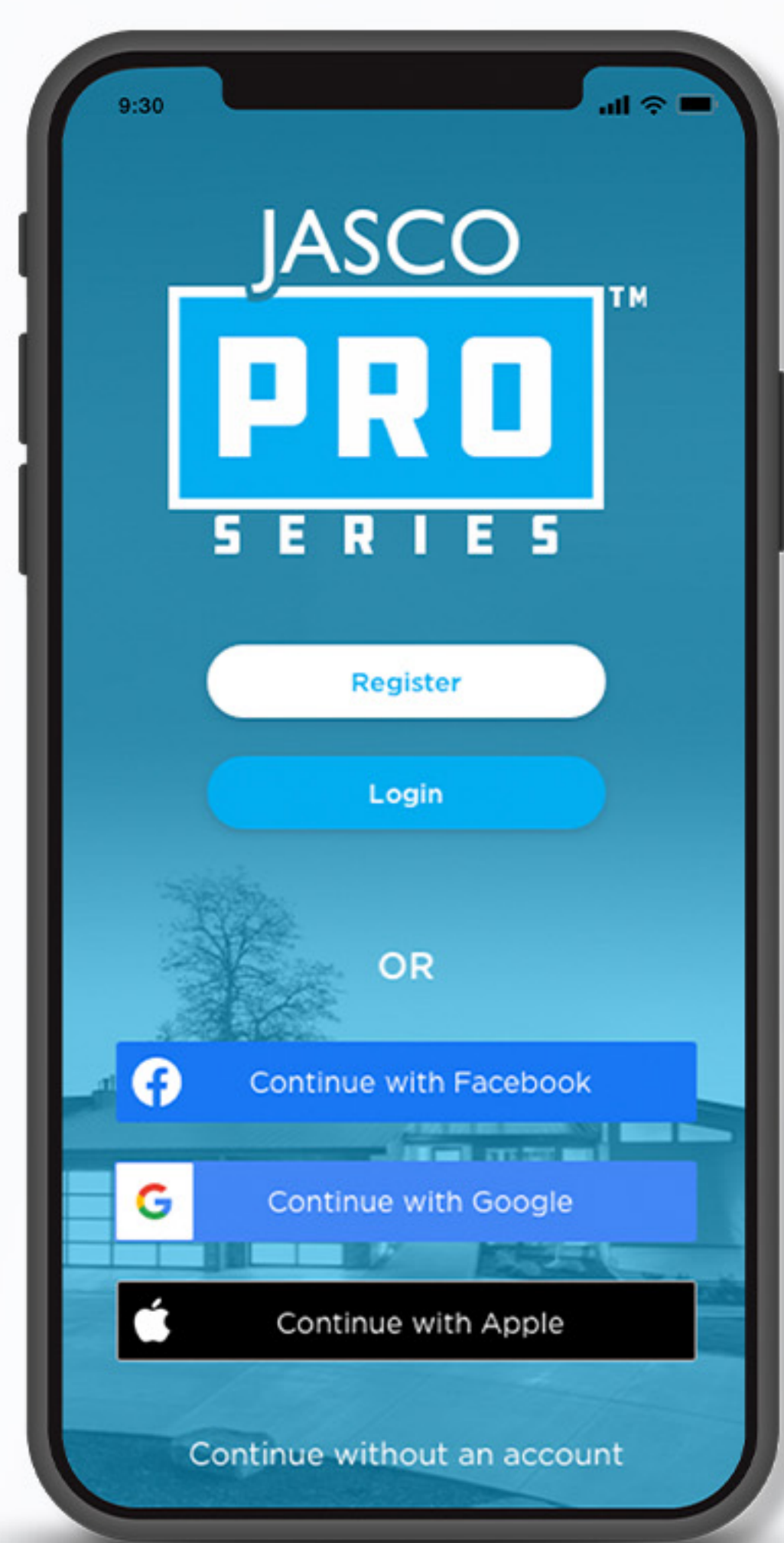

Download the free JascoPro Series app to control your devices from anywhere!\*

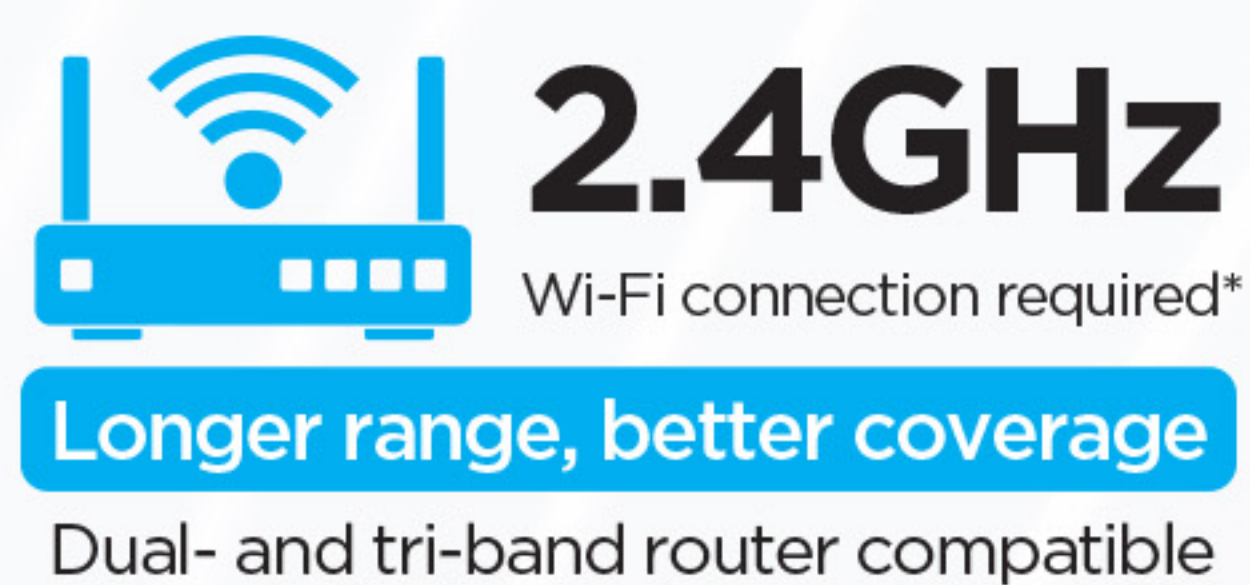

# Selectable Color Modes

Experience 56 colors, two- and three-color combinations, six shades of white light and an impressive variety of preset modes and effects.

Single &  
multi-color

A string of lights with a lattice pattern, illuminated with a single color, purple. The lights are arranged in a slightly curved line, and the lattice pattern is clearly visible against the dark background.

Holidays  
and events

A string of lights with a lattice pattern, illuminated with multiple colors, red, green, and yellow. The lights are arranged in a slightly curved line, and the lattice pattern is clearly visible against the dark background.

Create  
your own

A string of lights with a lattice pattern, illuminated with multiple colors, blue and yellow. The lights are arranged in a slightly curved line, and the lattice pattern is clearly visible against the dark background.



Paths/walkways



Flower beds/gardens

# Multiple Mounting Options

Mount lights facing up, down or stake into the ground. Burial-grade cables with 2-foot spacing allow flexible placement and can be hidden under mulch or soil.



Accent lighting



Pergolas/decks

# EASY APP CONTROL



Download the free **JascoPro Series app** to control your devices from anywhere

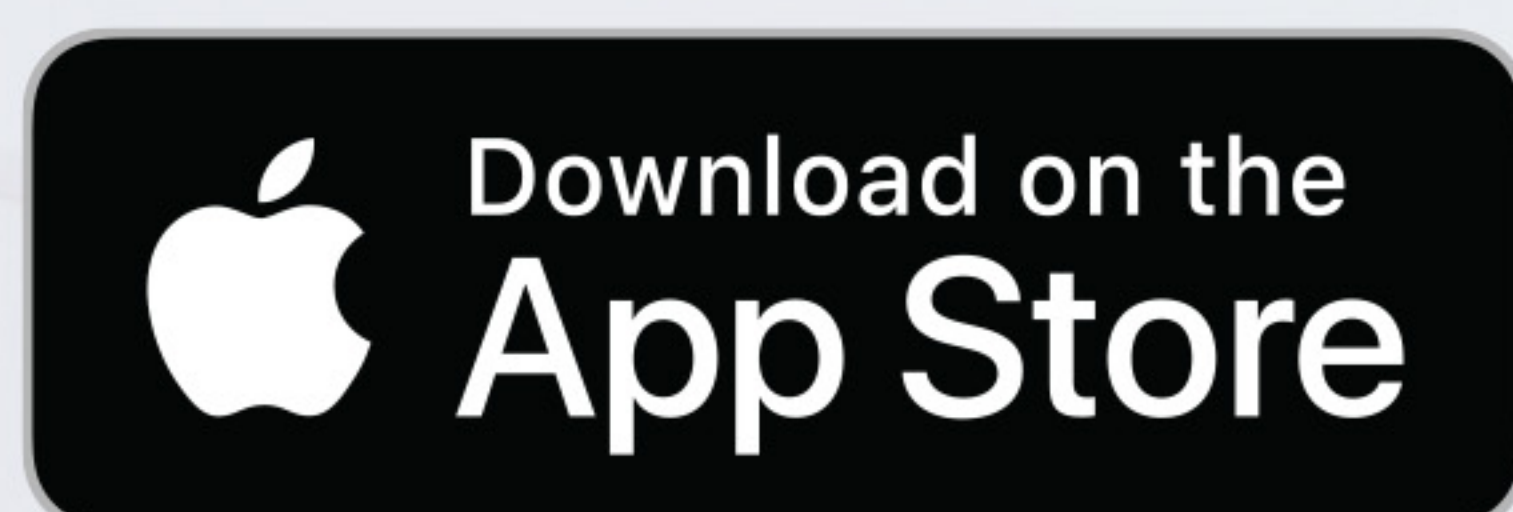

Hassle-free setup through Bluetooth

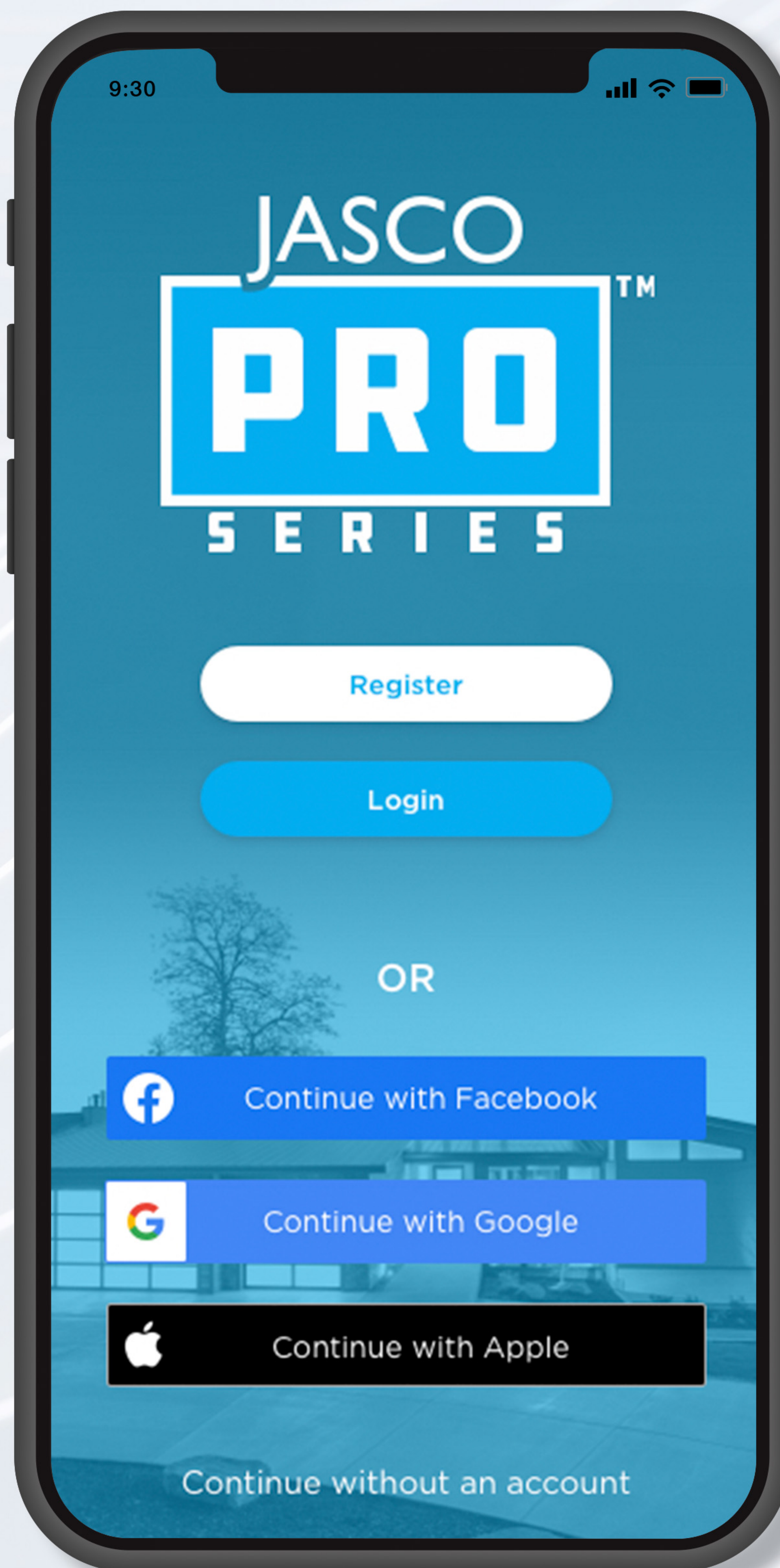

# PROGRAMMING

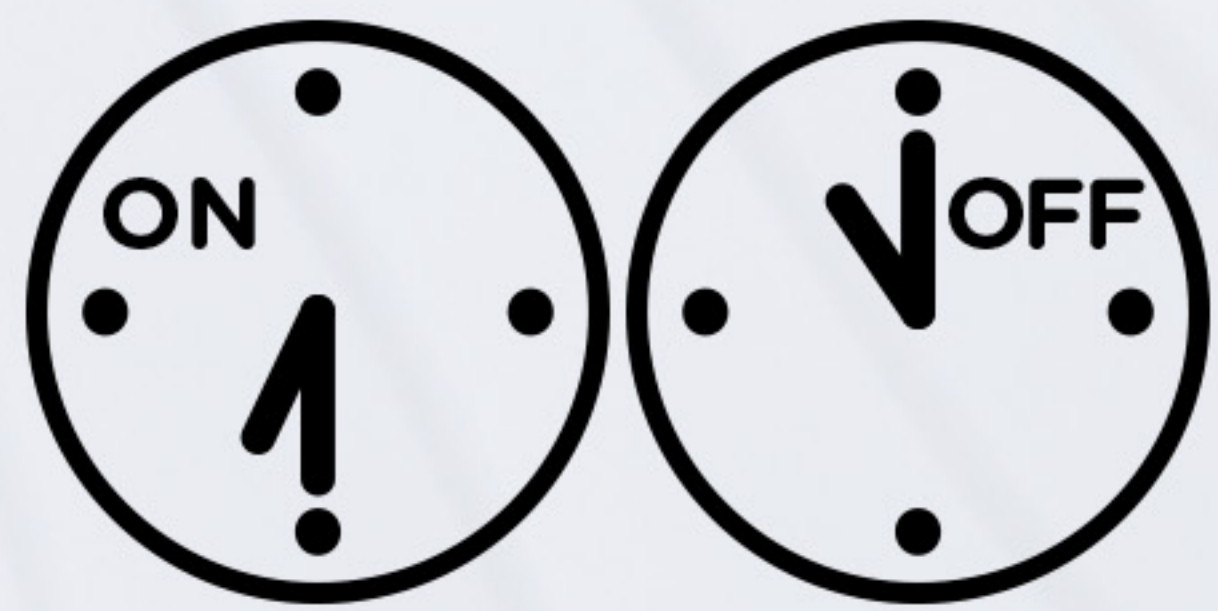

ONE-STEP  
ON/OFF  
SETTINGS



DAILY OR  
WEEKLY  
SCHEDULES



CUSTOM  
COUNTDOWN  
TIMER



SELF-ADJUSTS  
TO YOUR AREA

