



RM Series Wireless Microphone System

Reference Manual

Microphone Access Point

RM-WAP-8

Wireless Microphone

RM-WOM RM-WDR RM-WGL RM-WGS

Microphone Charger

RM-WCH-8

CONTENTS

INTRODUCTION	1
Information.....	1
SETUP	2
CONTROLS AND CONNECTORS	12
RM-WAP-8.....	12
RM-WOM RM-WDR	14
RM-WGL RM-WGS	16
RM-WCH-8	17
WEB GUI	19
Structure of RM-WAP Device Manager	19
Functions of RM-WAP Device Manager	21
MAIN SPECIFICATIONS	39
RM-WAP-8.....	39
RM-WOM RM-WDR RM-WGL RM-WGS	40
RM-WCH-8	42

INTRODUCTION

Thank you for purchasing products of the Yamaha RM series wireless microphone system. This document provides detailed information on the product functions and specifications as well as the Web GUI. For correct and safe use of the products, be sure to first read this manual carefully together with the Owner's Manual (included with each product).

Information

- The illustrations and images shown in this manual are for instructional purposes only.
- The company names and product names in this manual are trademarks or registered trademarks of their respective companies.
- We are continuously improving the software for our products. The latest version can be downloaded from the Yamaha website.
- This document is based on the latest specifications at the time of publication. The latest version can be downloaded from the Yamaha website.
- Reproduction of this manual in whole or in part without permission is prohibited.
- In this manual, the microphone access point is referred to as “access point”, the wireless microphone is referred to as “microphone”, and the microphone charger is referred to as “charger”.

SETUP

In order to use the products, setup is required. Set up the products using the Web GUI “RM-WAP Device Manager”.

Prepare the following.

- Computer
- LAN cable
- PoE powered network switch
- RM-WAP
- RM-WCH (required for using the AUTO SETUP function)
- Microphones (RM-WOM, RM-WDR, RM-WGL or RM-WGS)

Starting RM-WAP Device Manager

- 1. Download the application “RM Device Finder” from the Yamaha website (U.S.A. and Canada: <https://uc.yamaha.com/support/>, Other countries: <https://download.yamaha.com/>), and then start it.**
- 2. Using a LAN cable, connect the computer to the network switch where the access point is connected.**
- 3. Select a network in the [Select Network Interface Card] window, and then click [OK].**

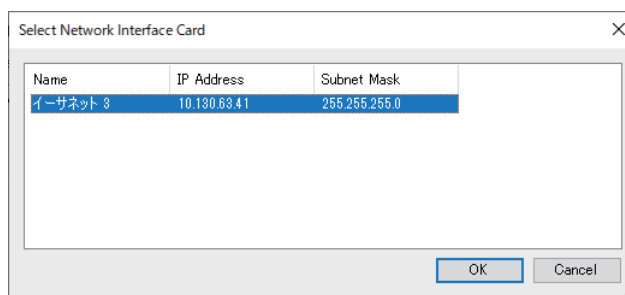

- 4. Double-click this unit in the [Detected Devices] window. Alternatively, select this unit, and then click the [Browse] button.**

The password settings window of RM-WAP Device Manager appears.

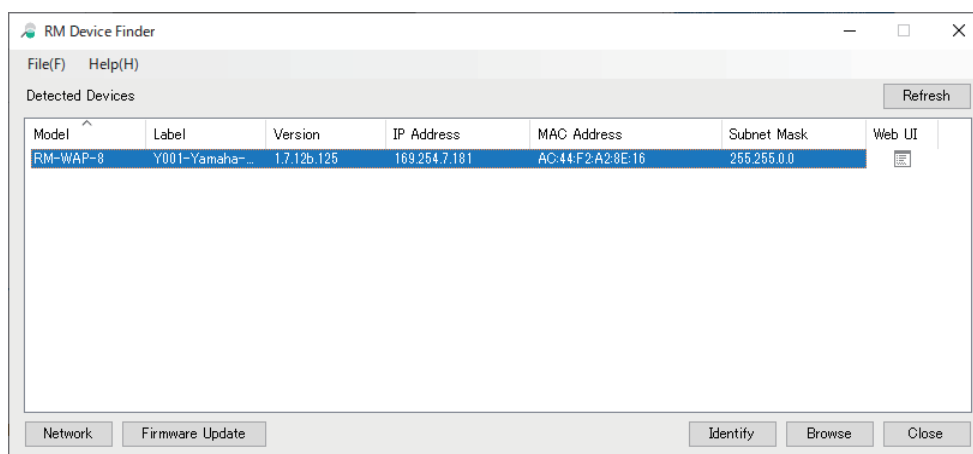

5. Specify a password in the password settings window, and then click the [SET PASSWORD] button.



The image shows a web interface for 'RM-WAP Device Manager'. At the top, there is a blue banner with the text 'Please set a password'. Below this, there is a field for 'Device Management Account' with an information icon. The next two fields are 'Device Management User Account Password' and 'Repeat Password', both with eye icons to toggle visibility. At the bottom right, there is a grey button labeled 'SET PASSWORD'.

6. Type the password into the login window, and then click the [LOGIN] button.

The [HOME] window appears.

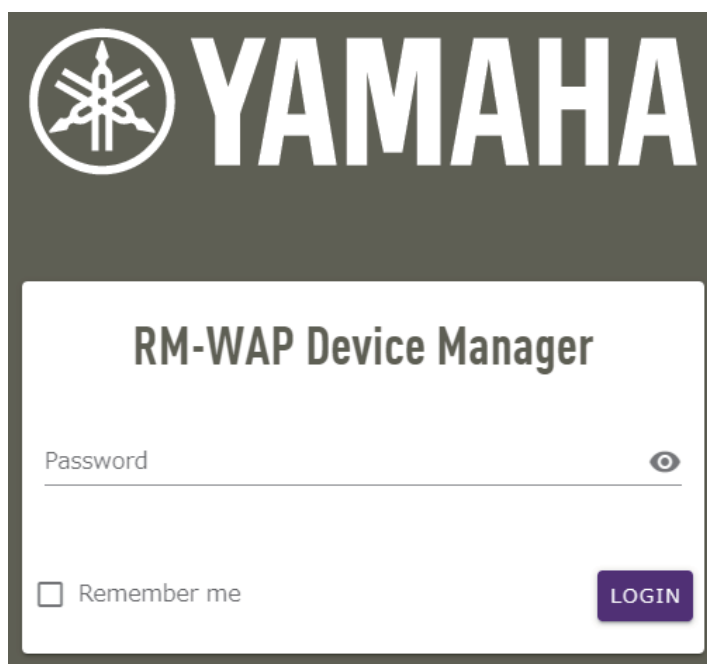

The image shows the Yamaha logo and the text 'YAMAHA' in a large, bold font. Below this, there is a white box with the title 'RM-WAP Device Manager'. Inside the box, there is a 'Password' field with an eye icon. At the bottom left, there is a checkbox labeled 'Remember me'. At the bottom right, there is a purple button labeled 'LOGIN'.

SITE SURVEY

Before installing the products, use the SITE SURVEY function in RM-WAP Device Manager to measure the signal in the area. With the SITE SURVEY function, you can check the number of microphones that can be used in the measured area. The SITE SURVEY function is available via [TOOLS]→[SITE SURVEY] (Page 33).

IMPORTANT: If radio frequency interference occurs, there may be no sound from the microphones or the microphone connection may be unexpectedly cut. We recommend thoroughly examining the environment before installation.

AUTO SETUP

After products have been installed, their settings can be specified. With the AUTO SETUP function, product settings can be specified using the wizard.

- IMPORTANT:**
- For details on mounting the access point to the wall or ceiling, read the RM-WAP Owner's Manual.
 - RM-WCH is required in order to use the AUTO SETUP function. Even in an environment where the AUTO SETUP function cannot be used, RM-WAP Device Manager can be used to manually specify settings. (Page 19)

1. Click the [AUTO SETUP] button.

The wizard starts up.

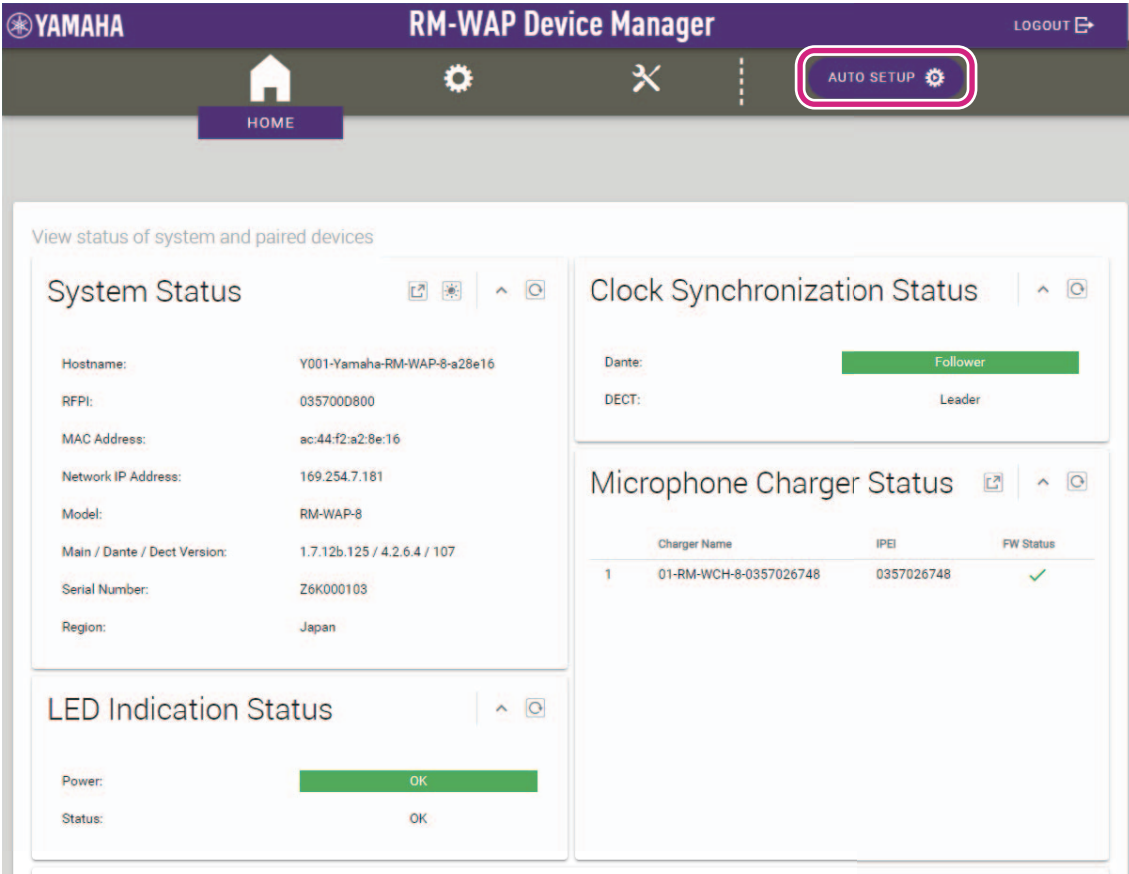

The screenshot displays the RM-WAP Device Manager web interface. The top navigation bar is purple and contains the Yamaha logo, the title "RM-WAP Device Manager", and a "LOGOUT" link. Below the navigation bar is a dark grey bar with icons for Home, Settings, and a highlighted "AUTO SETUP" button with a gear icon. The main content area is white and titled "View status of system and paired devices". It contains four panels: "System Status" (listing Hostname, RFPI, MAC Address, Network IP Address, Model, Main / Dante / Deect Version, Serial Number, and Region), "Clock Synchronization Status" (showing Dante as Follower and DECT as Leader), "LED Indication Status" (showing Power and Status as OK), and "Microphone Charger Status" (a table with columns for Charger Name, IPEI, and FW Status, showing one entry with a green checkmark).

Charger Name	IPEI	FW Status
01-RM-WCH-8-0357026748	0357026748	✓

2. Follow the wizard's instructions to continue the setup.

[1 Site Survey]

Check the contents of the window, and then click the [CONTINUE] button.

The window shows the number of microphones that can be used in the installation environment. It also shows the signal strength in the installation environment and the channel usage status.

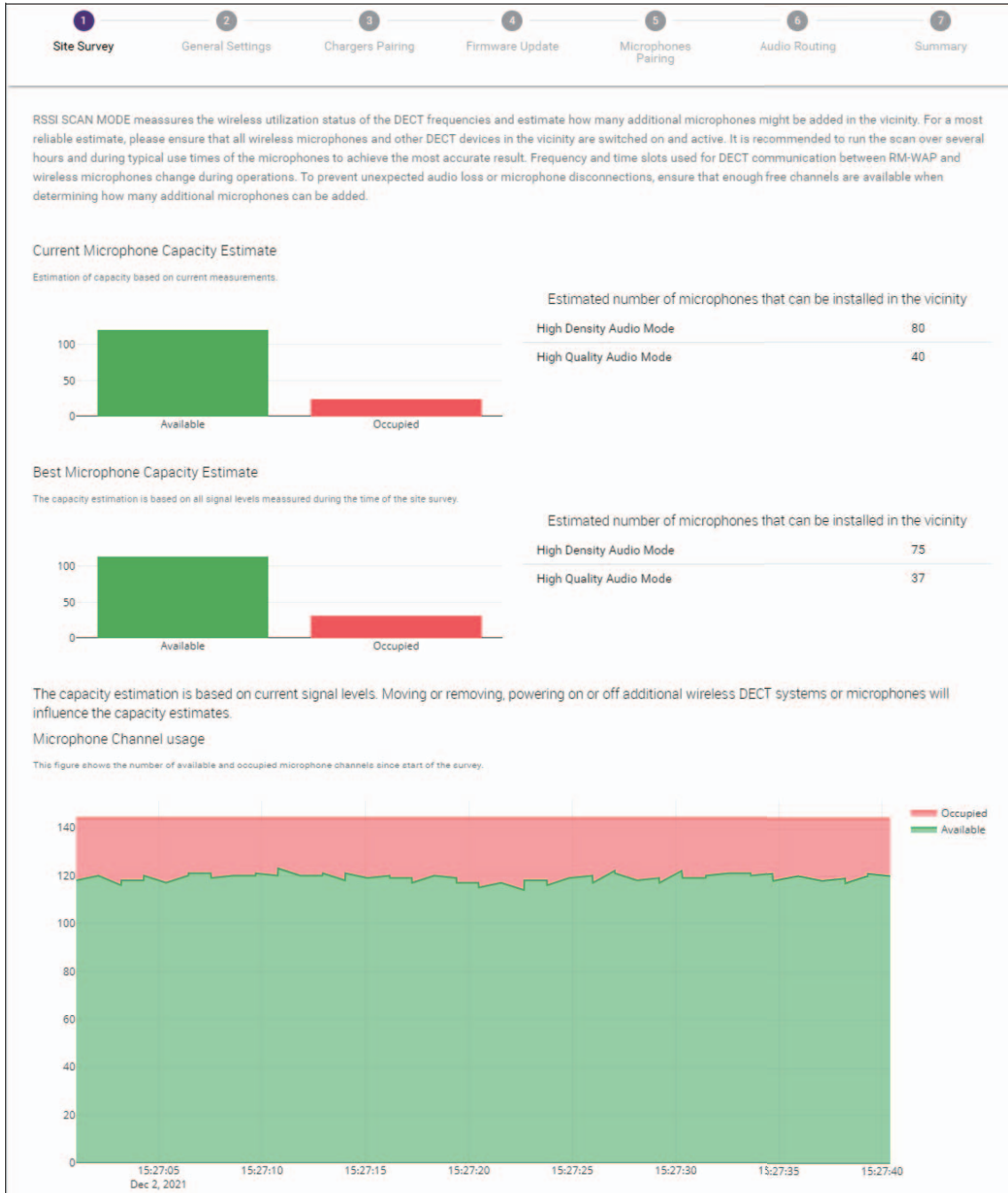

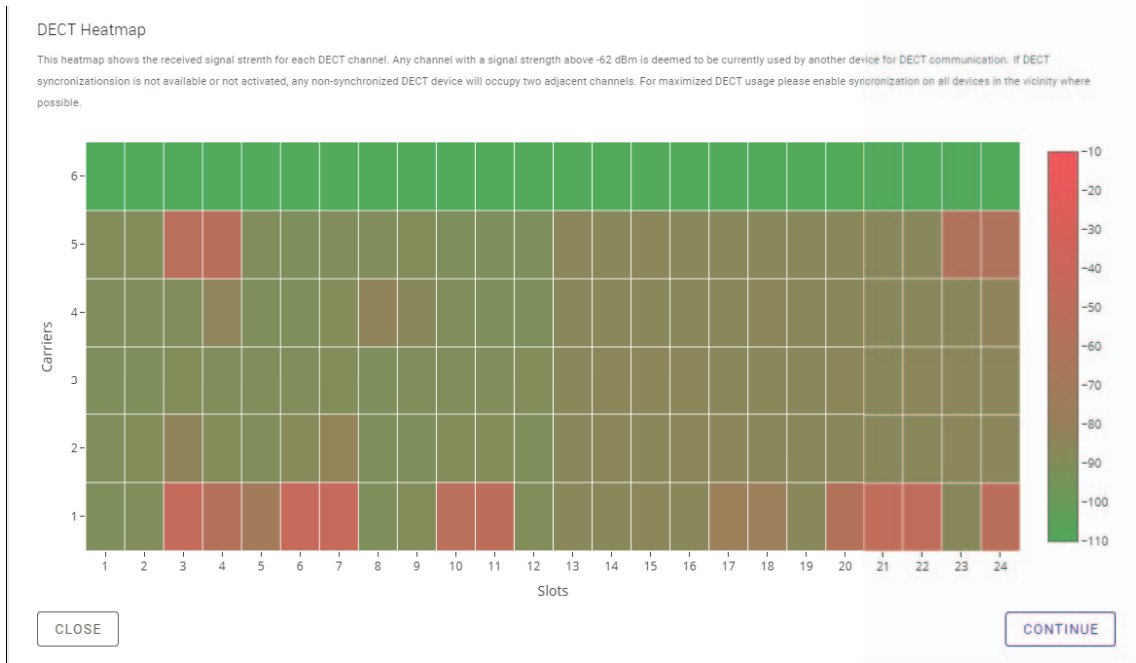

NOTE:

- You can also click the title of the next window (in this case, [2 General Settings]) to display the next window.
- Once the window has been displayed, the circled number in the window title is replaced with a pencil icon. Clicking a window title where the circled number has been replaced with a pencil icon displays that window again.

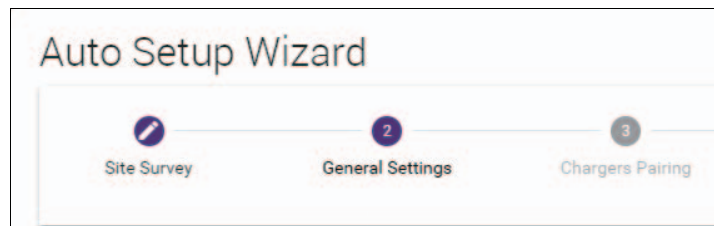

[2] General Settings

Check the access point settings, and then click the [CONTINUE] button.

Auto Setup Wizard

1 Site Survey 2 General Settings 3 Chargers Pairing 4 Firmware Update 5 Microphones Pairing 6 Audio Routing 7 Summary

1 AP Name

Mode: NAME USING UNIT ID MANUAL

Unit ID: 1

AP Name: Yamaha-RM-WAP-8

2 Locale

System Language: English (US)

Time Zone: -05:00 Eastern Time (UTC-05:00)

3 Time Settings

Current Date & Time

Date: 01/13/2022 Time: 11:10:24 AM

Date Format: MM/dd/yyyy

Enable 24 hour time format

NTP Support

Network Time Server 1

Network Time Server 2

Network Time Server 3

Network Time Server 4

BACK CONTINUE

NOTE: The access point settings can be changed if necessary.

① [AP Name]

Allows you to select whether to specify the name of the access point automatically or manually.

② [Locale]

Allows you to specify the time zone.

③ [Time Settings]

- Allows you to specify the date and time.
- Allows you to select whether to use NTP.

[3] Chargers Pairing

- 1 Insert the charger power plug into an electrical outlet.

The charger starts up.

- 2 Long-press the PAIR button (on the bottom panel of the charger) for at least two seconds.

The access point and charger are paired. When pairing is finished, the charger name appears in the window.

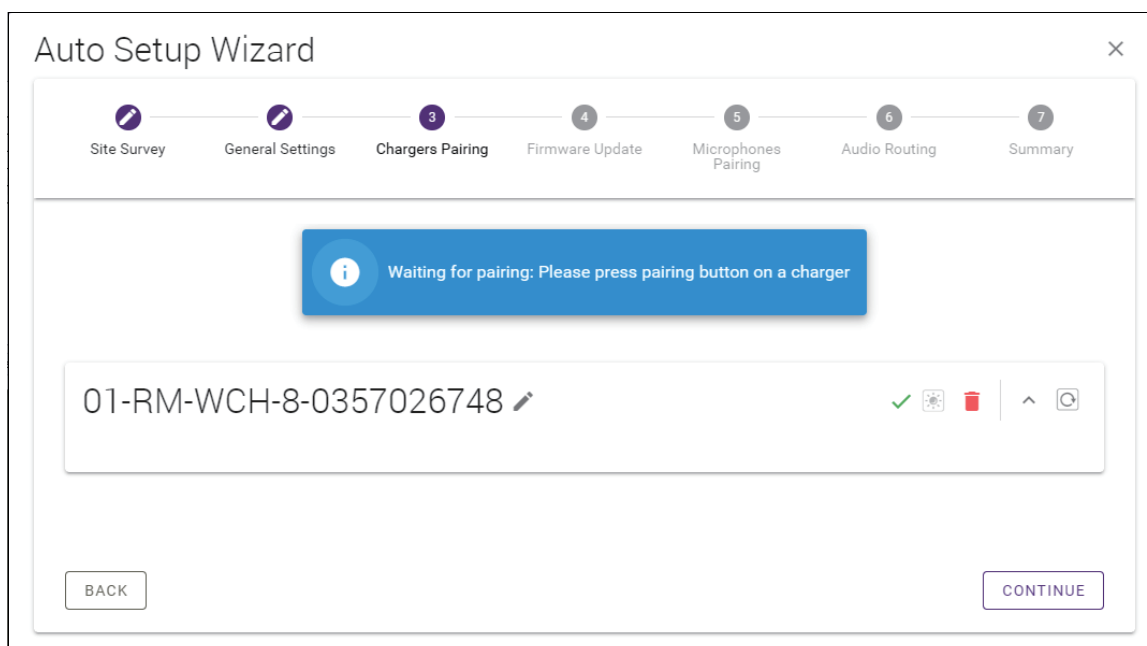
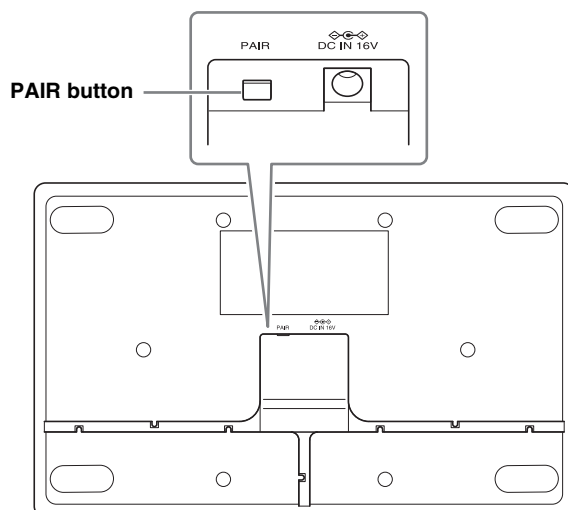

NOTE: Pairing means that the products register each other with the information required for a DECT connection. The access point and charger are paired, and a DECT connection is established at the same time.



- 3 Click the [CONTINUE] button.

[4 Firmware Update]

- ① If  appears to the left of the charger name, click the [UPDATE ALL] button.

The charger firmware is updated. When the update is finished,  changes to .

NOTE: If  appeared from the beginning, step **1** does not need to be performed.

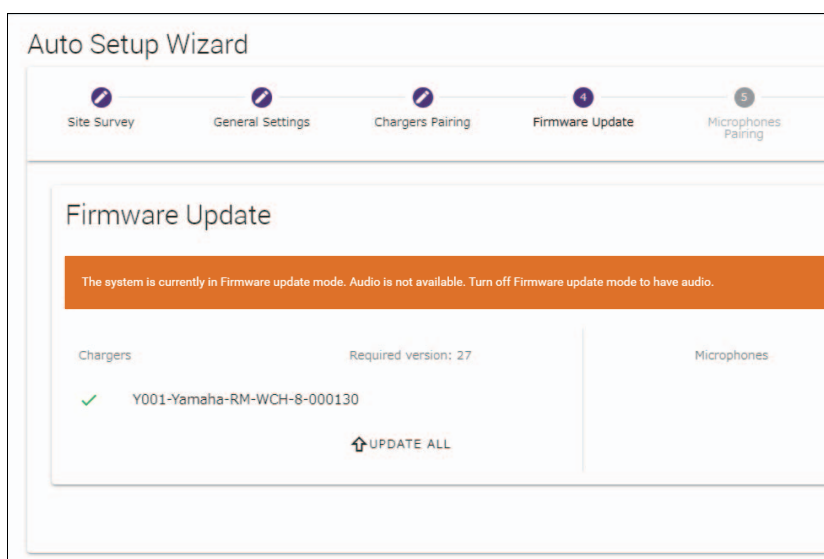
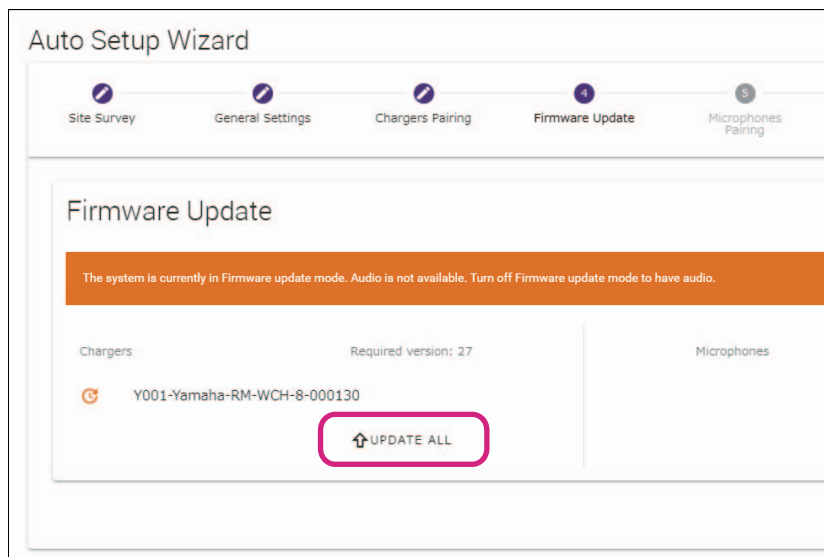

- ② Place the microphone(s) on the charger.

The microphone firmware is updated. During the update, the Mic indicators (on the top panel of the microphone) flashes white quickly. When the update is finished, the indicators go off.

IMPORTANT: Do not remove the microphone(s) from the charger until setup is finished.

NOTE: The microphones are updated one at a time.

- ③ Click the [CONTINUE] button.

[5] Microphones Pairing

The name(s) of the microphone(s) appear faintly in the window.

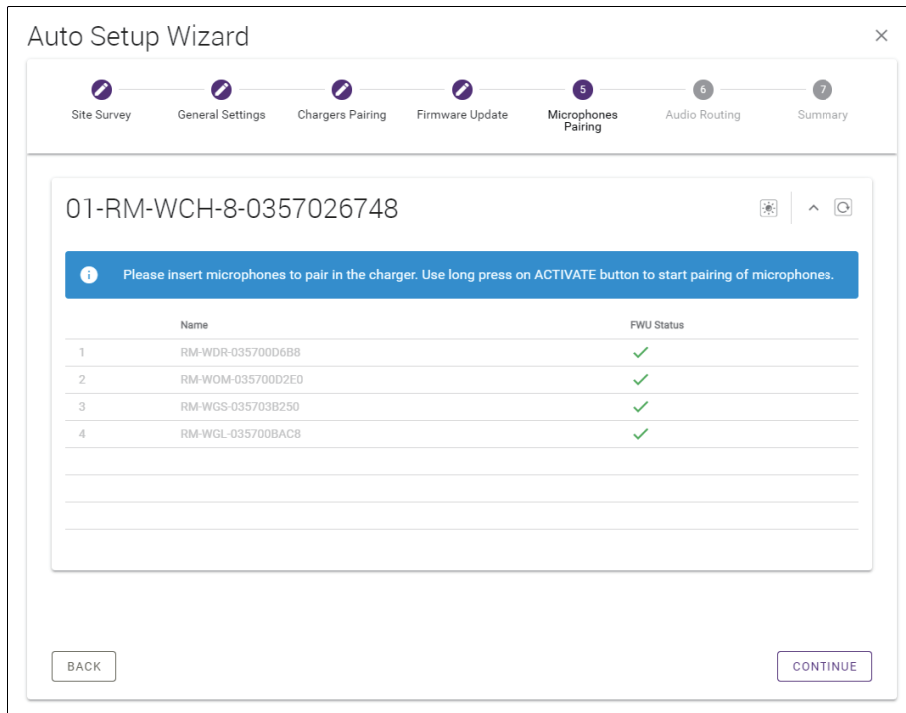

① **Long-press the ACTIVATE button (on the top panel of the charger) for at least two seconds.**

The access point and microphone(s) are paired. When pairing is finished, the name(s) of the microphone(s) change from appearing faintly to appearing in black.

NOTE: All microphones placed on the charger can be paired with a single long press.

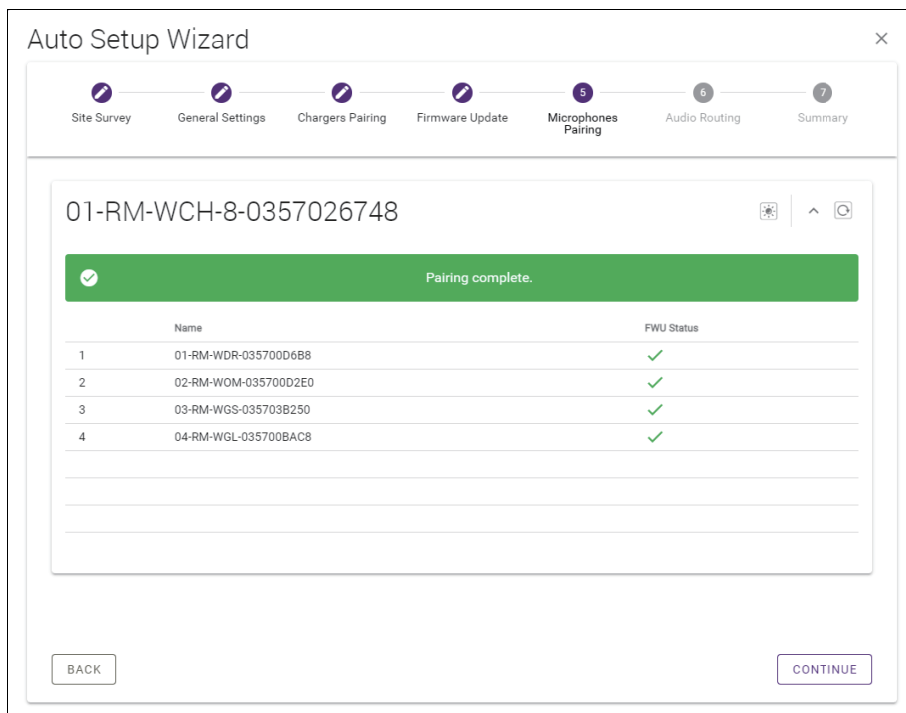

② **Click the [CONTINUE] button.**

[6] Audio Routing

Check the Dante channel to which each microphone is assigned, and then click the [CONTINUE] button.

NOTE: You can change the channel assignment by dragging the microphone name to the row of the desired Dante channel.

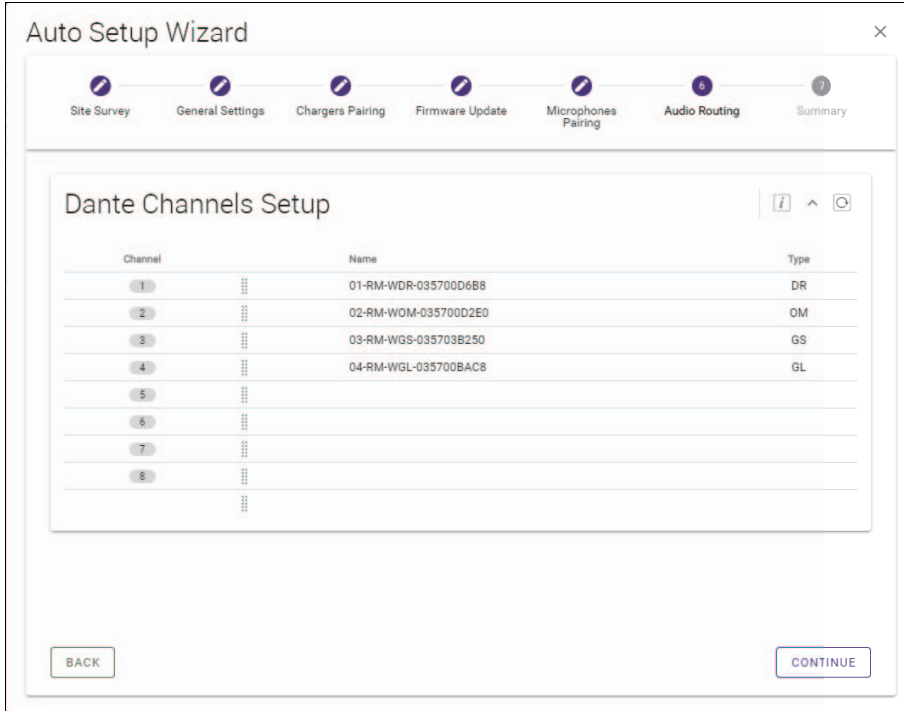

[7] Summary

Check the microphone settings, and then click the [FINISH] button.

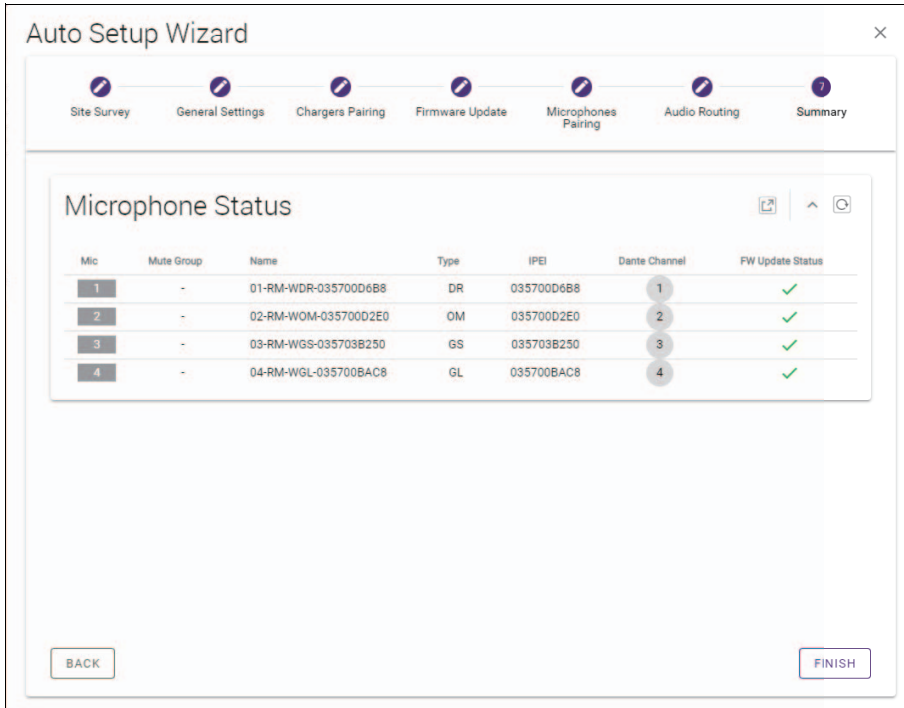

This completes the setup. When a microphone is removed from the charger, a DECT connection between the access point and microphone will be established.

CONTROLS AND CONNECTORS

RM-WAP-8

[Front panel]

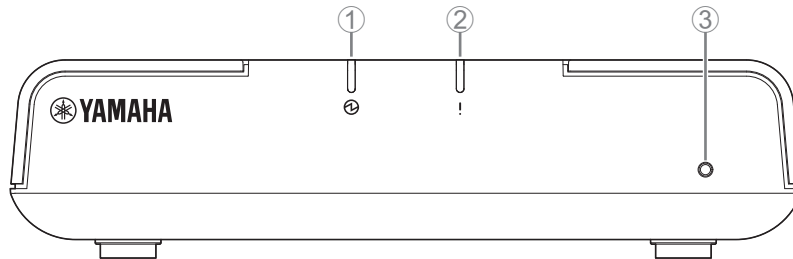

① Power indicator

Condition	Power indicator	Unit status
LAN cable plugged into Dante/PoE port	Lit green	Operating
–	Flashes red quickly	System error occurring

② Status indicator

Condition	Status indicator	Unit status
Making DECT connection	Lit blue	DECT connection has been established
Pairing using Web GUI	Flashes blue quickly	Waiting for pairing/Pairing
Pairing using Web GUI	(After flashing blue quickly) Flashes blue twice	Paired successfully
Pairing using Web GUI	(After flashing blue quickly) Flashes red twice	Pairing failed
Identify icon in Web GUI clicked	Flashes white	Responding (to Identify function)
Updating firmware	Flashes white quickly	Firmware being updated
Updating firmware	(After flashing white quickly) Flashes white twice	Firmware updated successfully
Updating firmware	(After flashing white quickly) Flashes red twice	Firmware update failed
–	Flashes red	Transmission error occurring
–	Flashes red quickly	System error occurring

③ Reset button

Condition	Status indicator	Unit status
Reset button long-pressed for 4 seconds to less than 8 seconds, then released	Flashes blue twice per second (during long-pressing/resetting)	Network-related settings Waiting for resetting/Resetting (Automatically restarts after reset)
Reset button long-pressed for 8 seconds to less than 12 seconds, then released	Flashes blue three times per second (during long-pressing/resetting)	All settings Waiting for resetting/Resetting (Automatically restarts after reset)

NOTE: Use a fine-tipped object to press the Reset button.

[Bottom panel]

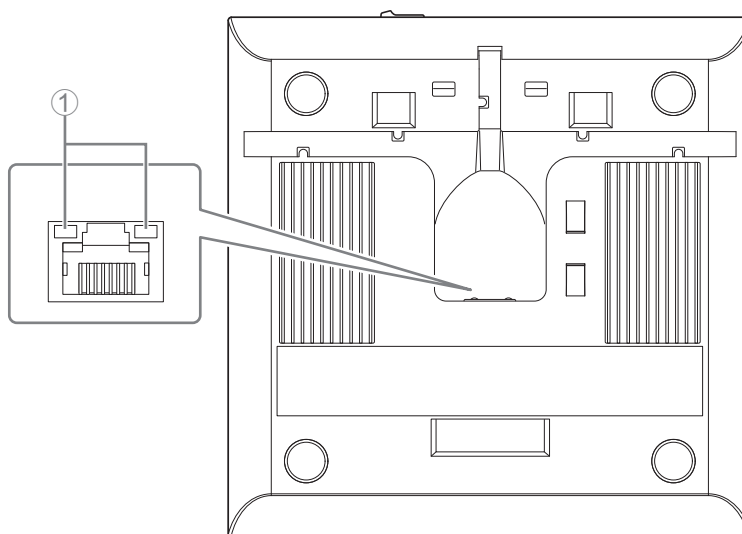

① Network port indicators (Dante/PoE port)

Network port indicator	Unit status
Left indicator lit green	Link up
Left indicator flashes green	Transferring data
Left indicator unlit	Link down
Right indicator lit green	Operating on word clock of peripheral device (leader)
Right indicator flashes green	Acting as word-clock leader
Right indicator flashes orange	Word clock unlocked

NOTICE:

- When disconnecting the LAN cable from the Dante/PoE port, wait at least five seconds before reconnecting the cable. Otherwise, damage or malfunctions may result.
 - With a Dante network, do not use the EEE function* of the network switch. Although mutual power consumption settings are automatically adjusted between switches that support the EEE function, some switches do not perform that properly. As a result, the switch's EEE function may be enabled inappropriately in the Dante network, possibly degrading clock synchronization performance and interrupting audio. Therefore, please note the following.
 - When using managed switches, turn off the EEE function on all ports used for Dante. Do not use a switch that does not allow the EEE function to be turned off.
 - When using unmanaged switches, do not use switches that support the EEE function. In such switches, the EEE function cannot be turned off.
- * EEE (Energy-Efficient Ethernet) function: Technology that reduces the power consumption of Ethernet devices during periods of low network traffic; also known as Green Ethernet or IEEE802.3az.

RM-WOM RM-WDR

[Top panel/side panel]

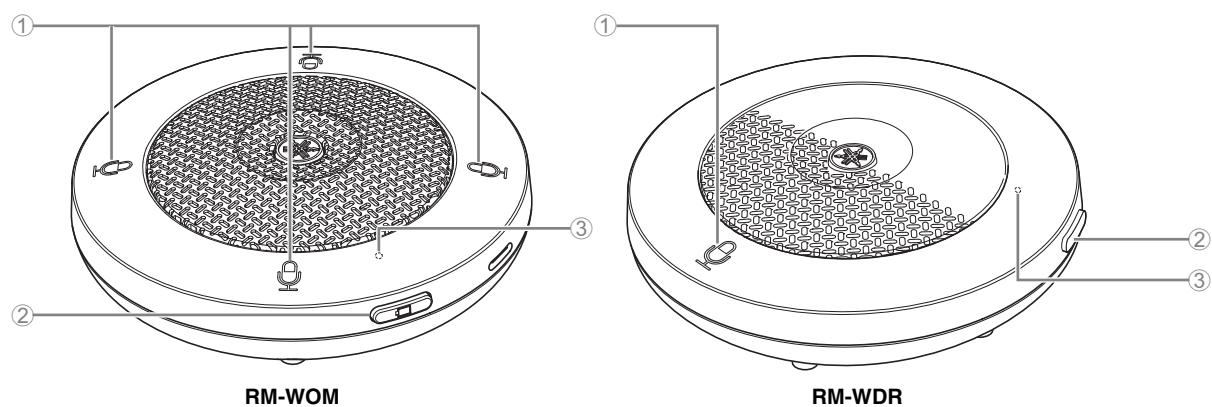

① Mic buttons/indicators

Condition	Mic indicator	Unit status
Mic button touched	Lit green	Microphone on
Mic button touched	Lit red (Flashes every 2 seconds)	Microphone off
Identify icon in Web GUI clicked	Flashes white	Responding (to Identify function)
Updating firmware	Flashes white quickly	Firmware being updated
Updating firmware	(After flashing white quickly) Flashes white twice	Firmware updated successfully
Updating firmware	(After flashing white quickly) Flashes red twice	Firmware update failed
–	Flashes red	Transmission error occurring
–	Flashes red quickly	System error occurring
–	Flashes red slowly	Out of range for DECT connection

②  **Battery button**

③ **Battery indicator**

Condition	Battery indicator	Unit status
Charging the unit	Lit green	Charging (available operating time of 15 hours or more)
Charging the unit	Lit orange	Charging (available operating time of 3 hours to less than 15 hours)
Charging the unit	Lit red	Charging (available operating time of less than 3 hours)
Charging the unit	Unlit	Charging finished
Battery button pressed	Lit green for two seconds	Remaining operating time of 15 hours or more
Battery button pressed	Lit orange for two seconds	Remaining operating time of 3 hours to less than 15 hours
Battery button pressed	Lit red for two seconds	Remaining operating time of less than 3 hours
(Continuing to use the unit without charging)	Flashes red	Remaining operating time of less than 1 hour
Battery button long-pressed for 2 to 3 seconds	Flashes orange slowly	Enters standby mode

IMPORTANT: The microphone is pre-installed with an RM-WBT battery. In order to maintain battery capacity, charge the microphone (battery) once every six months.

NOTE:

- Power consumption can be reduced by putting the microphone in standby mode.
- Putting the microphone in standby mode cuts the DECT connection with the access point. When the standby mode is exited (by long-pressing the Battery button again for 2 to 3 seconds), the connection is re-established.

[Bottom panel]

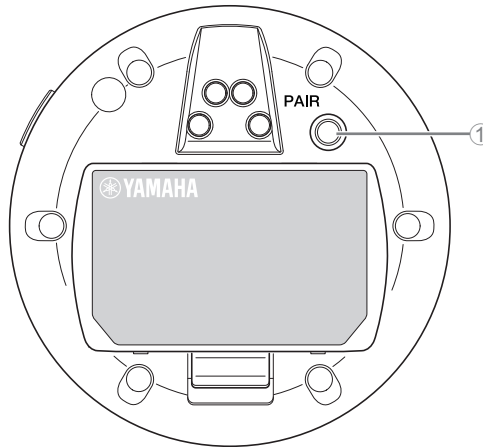

① **PAIR button**

Condition	Mic indicator	Unit status
PAIR button long-pressed for at least 2 seconds	Flashes blue quickly	Waiting for pairing/Pairing
PAIR button long-pressed for at least 2 seconds	(After flashing blue quickly) Flashes blue twice	Paired successfully
PAIR button long-pressed for at least 2 seconds	(After flashing blue quickly) Flashes red twice	Pairing failed

[Top panel/side panel]

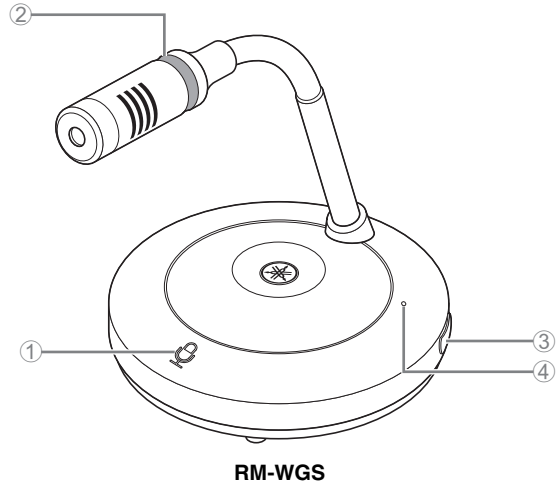
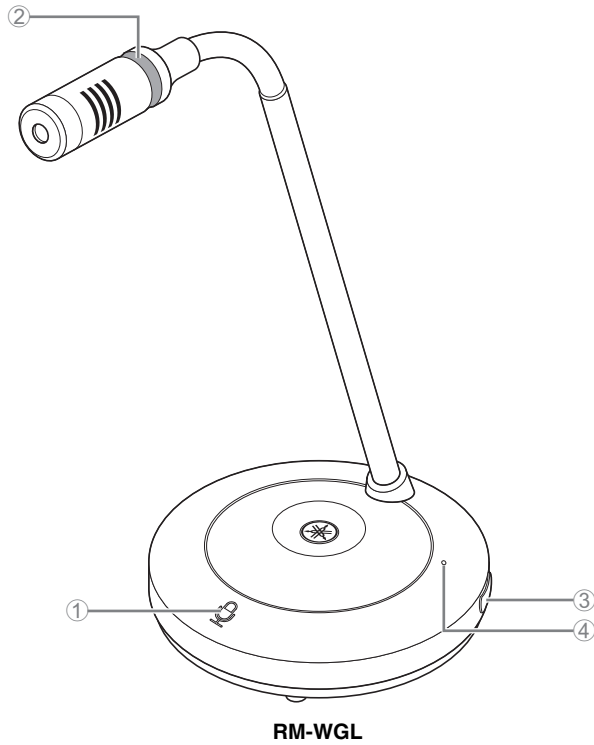

①  **Mic buttons/indicators**

Condition	Mic indicator	Unit status
In Toggle mode: Mic button touched continuously	Lit green	Microphone on
In Toggle mode: Mic button released	Lit red	Microphone off
In Push to talk mode: Mic button touched continuously	Lit green	Microphone on while the button is touched
In Push to talk mode: Mic button released	Lit red (Flashes every 2 seconds)	Microphone off

NOTE: Push to talk is a communication method that allows you to talk only while a button is pressed. Multiple devices cannot be used to talk at the same time. For details on switching to Toggle mode or Push to talk mode, refer to page 26. All other Mic button/indicator functions are the same as described for RM-WOM and RM-WDR.

② **Ring indicator**

Flashes together with the Mic indicators.

③  **Battery button**

④ **Battery indicator**

Functions in the same way as the Battery button/indicator of the RM-WOM and RM-WDR.

[Bottom panel]

⑤ PAIR button

Functions in the same way as the PAIR button of the RM-WOM and RM-WDR.

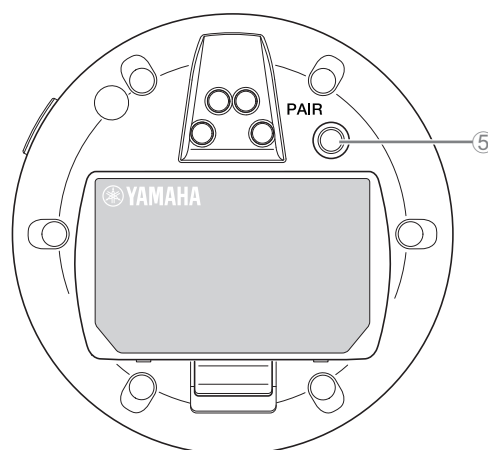

RM-WCH-8

[Top panel]

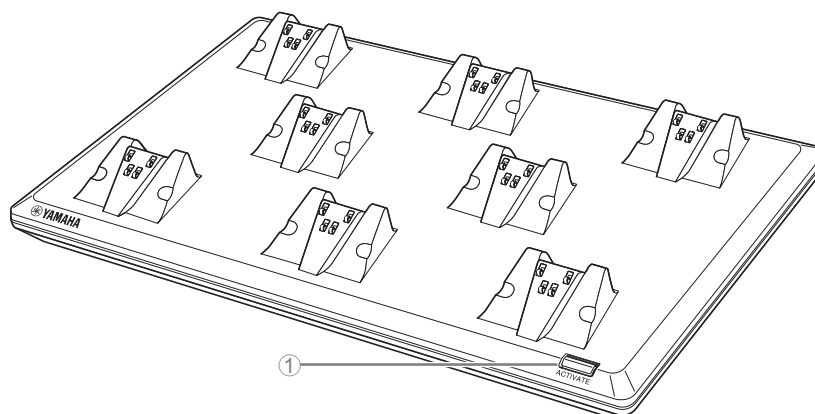

① ACTIVATE button/indicator

Condition	ACTIVATE indicator	Unit status
Power plug inserted into electrical outlet	Lit green	Operating
ACTIVATE button long-pressed for at least 2 seconds	Flashes blue quickly	Waiting for pairing/Pairing of access point and microphone(s)
ACTIVATE button long-pressed for at least 2 seconds	(After flashing blue quickly) Flashes blue twice	Access point and microphone(s) paired successfully
ACTIVATE button long-pressed for at least 2 seconds	(After flashing blue quickly) Flashes red twice	Pairing of access point and microphone(s) failed
Identify icon in Web GUI clicked	Flashes white	Responding (to Identify function)
Updating firmware	Flashes white quickly	Firmware being updated
Updating firmware	(After flashing white quickly) Flashes white twice	Firmware updated successfully
Updating firmware	(After flashing white quickly) Flashes red twice	Firmware update failed
–	Flashes red	Transmission error occurring
–	Flashes red quickly	System error occurring

[Bottom panel]

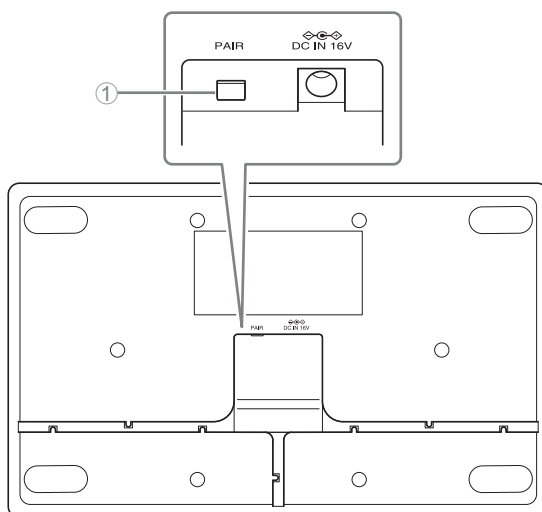

① PAIR button

Condition	ACTIVATE indicator	Unit status
PAIR button long-pressed for at least 2 seconds	Flashes blue quickly	Waiting for pairing/Pairing
PAIR button long-pressed for at least 2 seconds	(After flashing blue quickly) Flashes blue twice	Paired successfully
PAIR button long-pressed for at least 2 seconds	(After flashing blue quickly) Flashes red twice	Pairing failed

WEB GUI



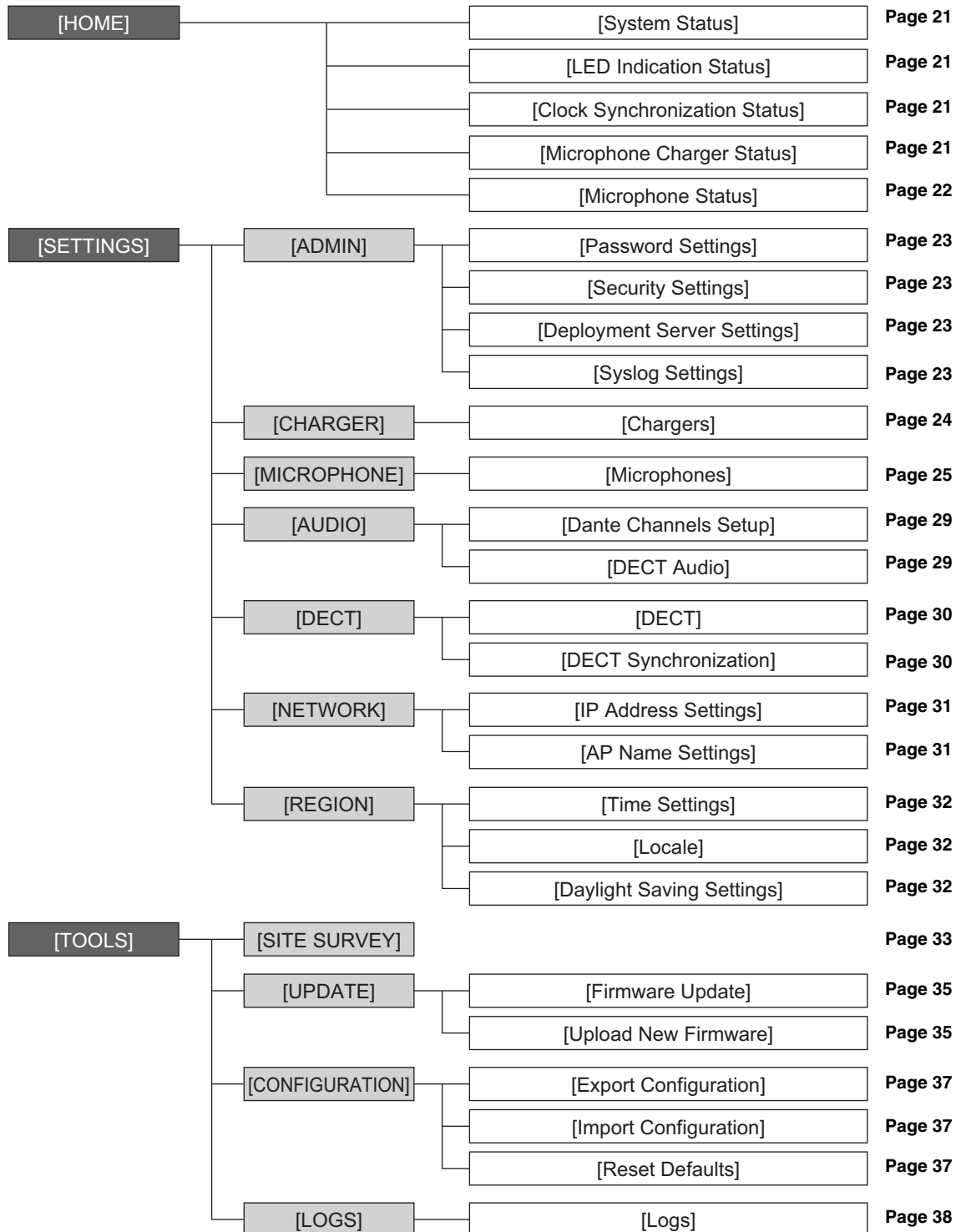

Use the Web GUI “RM-WAP Device Manager” to check/change the settings of the units.

Structure of RM-WAP Device Manager

Refer to the page listed to the right for details on each item available in the various windows.



The following icons/buttons are used in RM-WAP Device Manager.

-  (Information icon): Move the pointer over this icon to see more information about the item.
-  (Reload button): Click to update the window contents.
-  (Identify button): Click to cause the indicator of the corresponding device to flash.
-  (Link button): Click to go to another window for the item.

IMPORTANT: Be sure to click the [SUBMIT] button after changing settings in RM-WAP Device Manager. The [SUBMIT] button always appears in the upper-right corner of the window.

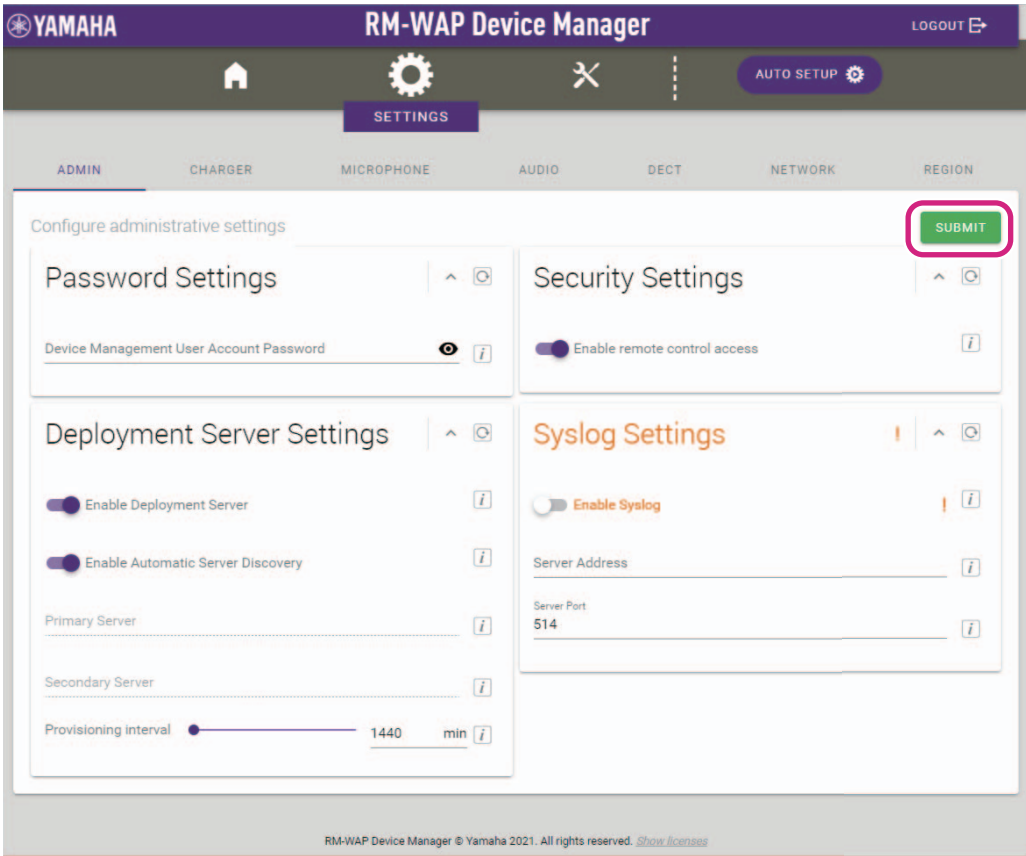

Functions of RM-WAP Device Manager

[HOME]

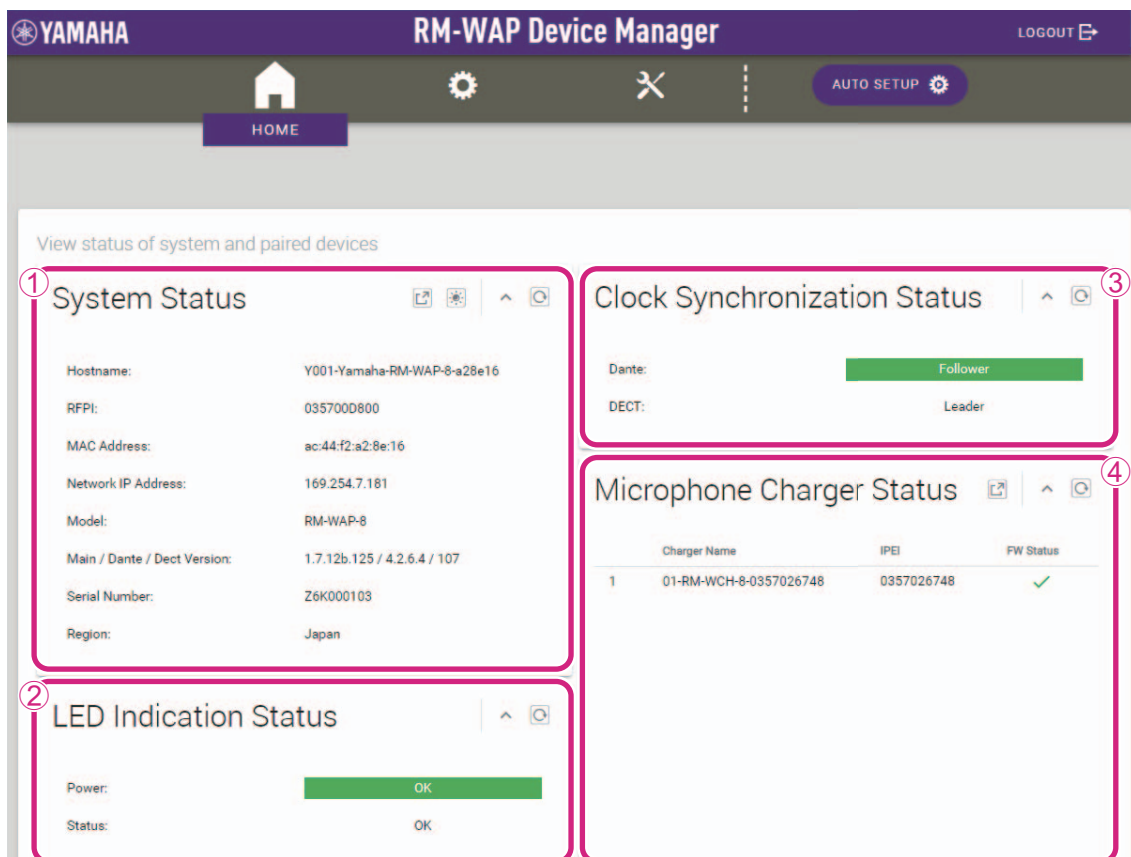

① [System Status]

Allows you to check basic information about the access point.

② [LED Indication Status]

Allows you to check the status of the Indicator of the access point.

③ [Clock Synchronization Status]

- Allows you to check the status of the Dante word clock.
“Leader” or “Follower” appears. If there is an abnormality in the word clock, this appears in orange.
- Allows you to check the status of the DECT frame synchronization.
“Leader” or “Follower” appears. When multiple access points are set up in the same group, one will be the “Leader” and the others will be “Follower”. The access point group settings can be specified via [SETTINGS]→[DECT]→[DECT Synchronization].

④ [Microphone Charger Status]

Allows you to check the name of the charger.

5 Microphone Status

Mic	Mute Group	Name	Identify	Type	IPEI	Link Quality	Audio	Dante Channel	Battery Status	Disconnect Time	Connect Time	FW Update Status
1	-	01-RM-WGS-035703B250		GS	035703B250			1		-	02:24:56 pm 01/14/2022	
2	-	02-RM-WGL-035700BAC8		GL	035700BAC8			2		-	02:24:59 pm 01/14/2022	
3	-	03-RM-WOM-035700D2E0		OM	035700D2E0			3	99%	-	02:27:57 pm 01/14/2022	
4	-	04-RM-WDR-035700D6B8		DR	035700D6B8			4	100%	-	02:27:52 pm 01/14/2022	

5 [Microphone Status]

Allows you to check the statuses of the microphones.

- [IPEI]:

Identification number of the DECT module

- [Link Quality]:

Shows the strength of the radio wave as one of four levels indicated by the number of bars.

- [Audio]:

Click the icon to turn on/off the microphone.

- [Battery Status]:

Shows the battery charge as a percentage.

Indicates the remaining charge of the battery by a color.

Red: 3% to 10%, 1 to 3 hours

Yellow: 10% to 50%, 3 to 15 hours

Green: 50% or more, 15 hours or more

- [Disconnect Time]:

Shows the time at which the microphone and access point were disconnected.

- [Connect Time]:

Shows the time at which the microphone and access point were connected.

- [FW Update Status]:

Shows the firmware update status.

If the firmware must be updated, appears.

Update the firmware via [TOOLS]→[UPDATE]→[Firmware Update].

[SETTINGS]

[ADMIN]

YAMAHA RM-WAP Device Manager

LOGOUT

HOME GEAR WAX AUTO SETUP

SETTINGS

ADMIN CHARGER MICROPHONE AUDIO DECT NETWORK REGION

Configure administrative settings SUBMIT

1 Password Settings Device Management User Account Password

2 Security Settings Enable remote control access

3 Deployment Server Settings Enable Deployment Server Enable Automatic Server Discovery Primary Server Secondary Server Provisioning interval 1440 min

4 Syslog Settings Enable Syslog Server Address Server Port 514

RM-WAP Device Manager © Yamaha 2021. All rights reserved. [Show licenses](#)

① [Password Settings]

Allows you to check/change the password for logging in to RM-WAP Device Manager.

② [Security Settings]

Allows you to select whether to enable remote control. For details on remote control, refer to the RM Series Remote Control Protocol Specifications.

IMPORTANT: Remote control must be enabled for the access point to link to the RM-CR signal processor.

③ [Deployment Server Settings]

By using a deployment server, the device configuration file can be automatically acquired and applied to the device.

- **[Enable Deployment Server]:**
Allows you to select whether to use a deployment server.
- **[Enable Automatic Server Discovery]:**
Allows you to select whether to use the automatic discovery feature of the deployment server.
- **[Primary Server], [Secondary Server]:**
Specify the IP address of the deployment server when [Enable Automatic Server Discovery] is off.
- **[Provisioning Interval]:**
Allows you specify the deployment server provisioning interval.

④ [Syslog Settings]

Allows you to select whether to use a syslog server.

[CHARGER]

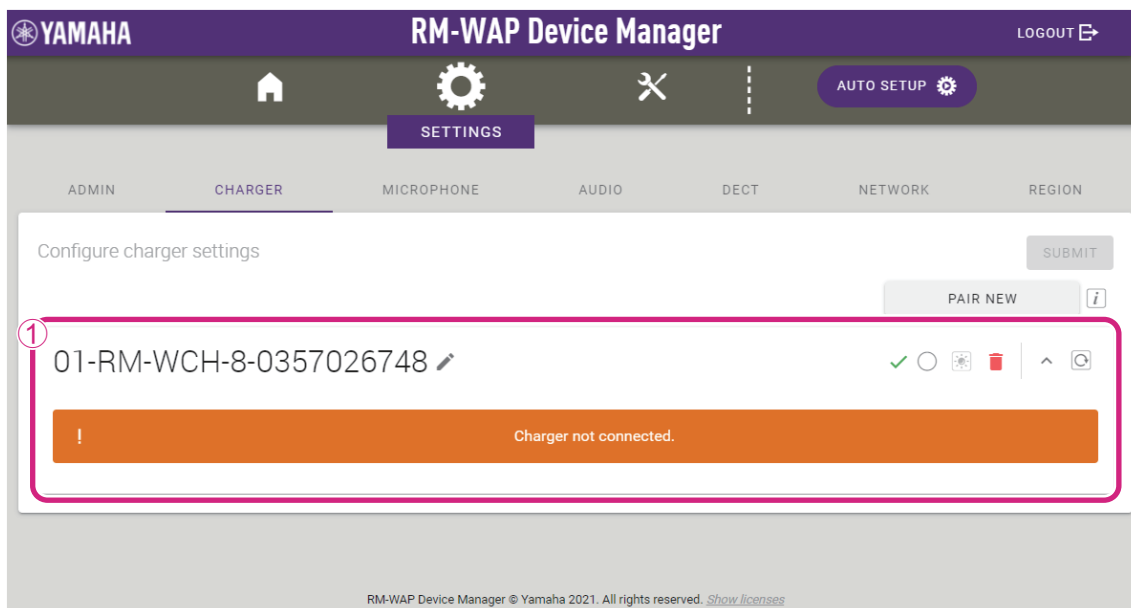

① [Chargers]

- Allows you to pair the access point and charger. Click the [PAIR NEW] button to put the access point in pairing standby mode, and then long-press the PAIR button (on the bottom panel of the charger) for at least two seconds. When pairing is finished, the charger name appears in the window.
- Allows you to check/change the name of the charger.
- Allows you to cancel pairing by clicking  (trash can).

[MICROPHONE]

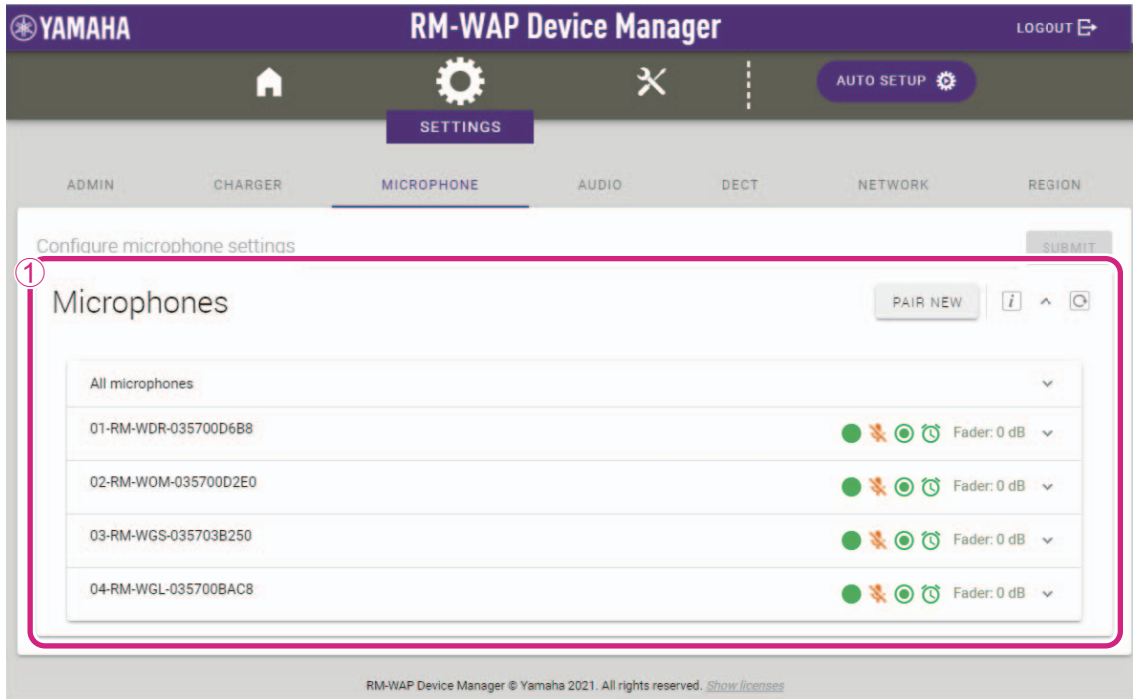

① [Microphones]

- Allows you to pair the access point and microphones. Click the [PAIR NEW] button in the window to put the access point in pairing standby mode, and then long-press the PAIR button (on the bottom panel of the microphone) for at least two seconds. When pairing is finished, the microphone name appears in the window.
- Shows the microphone settings as icons.
 - [Start Mode]:
 - : Starts up in Start Up mode.
 - : Starts up in Standby mode.
 - [Start Mute Mode]:
 - 🔇 : Starts up with the microphone turned off.
 - 🟢 : Starts up with the microphone turned on.
 - [Mic Button Behavior]:
 - 🟢 : The Mic button operates in Toggle mode.
 - ⦿ : The Mic button operates in Push to talk mode.
 - : The Mic button is deactivated.
 - [Alarm when out of area]:
 - 🕒 : The alarm when out of range for DECT connection is on.
 - 🕒 : The alarm when out of range for DECT connection is off.
 - [Fader Level]:
 - Shows the microphone fader level. The setting range is between -128 dB and +12 dB.
- Allows you to expand the settings window by clicking a row containing the name of a microphone.

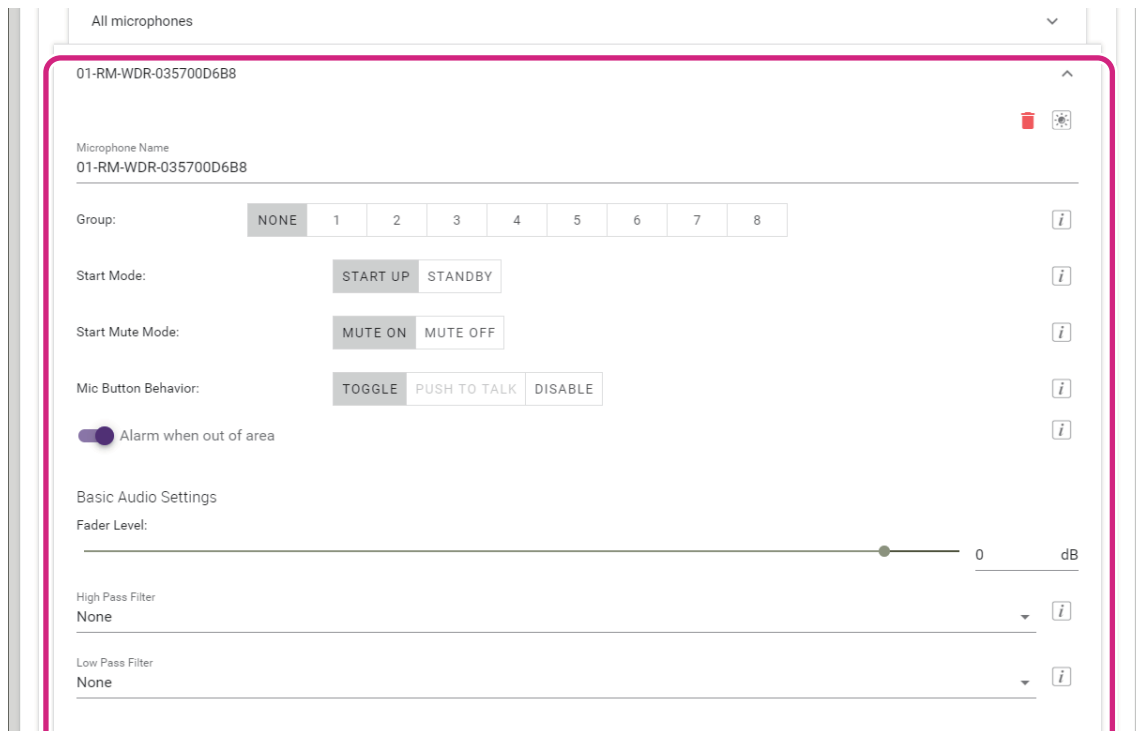

- Allows you to check/change microphone settings.
 - **[Microphone Name]:**
Allows you to check/change the name of the microphone.
 - **[Group]:**
Allows you to group the microphones. Grouping microphones synchronizes them when turning one on/off.
 - **[Start Mode]:**
Allows you to select whether the microphone enters Standby mode when it is started up.
 - **[Start Mute Mode]:**
Allows you to select whether the mic is on or off when the microphone is started up.
 - **[Mic Button Behavior]:**
Allows you to set the operation of the Mic button to one of the following.
 - **[TOGGLE]:**
Turn on/off the microphone by touching the Mic button.
 - **[PUSH TO TALK]:**
The microphone is on while the Mic button is touched. Multiple devices cannot be used to talk at the same time.
 - **[DISABLE]:**
The Mic button is deactivated.
 - **[Alarm when out of area]:**
Allows you to select whether the Mic indicator flashes to indicate that the microphone is out of range for a DECT connection.
 - **[Fader Level]:**
Allows you specify the microphone fader level. The setting range is between -128 dB and $+12$ dB.
 - **[High Pass Filter]:**
Allows you to select the High Pass filter setting. Select one of the following: NONE, 110 Hz, 140 Hz, 175 Hz, 225 Hz.
 - **[Low Pass Filter]:**
Allows you to select the Low Pass filter setting. Select one of the following: NONE, 4 kHz, 8 kHz, 12 kHz.

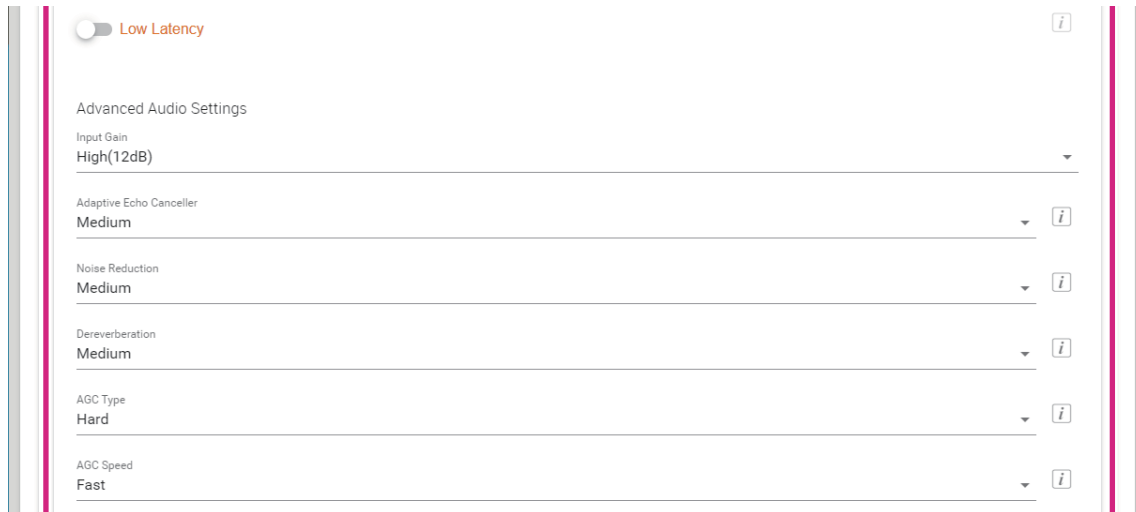

- **[Low Latency]**

When Low Latency is on, processing of the following Advanced Audio Settings can be bypassed to reduce audio delay.

Input Gain, Adaptive Echo Canceller, Noise Reduction, Dereverberation, AGC and PEQ

When used in combination with RM-CR, turn off Low Latency.

- **[Input Gain]**

Allows you to select the microphone input gain.

With RM-WOM, select one of the following: OFF (0 dB), LOW (3 dB), MEDIUM (6 dB), HIGH (9 dB).

With RM-WDR, select one of the following: OFF (0 dB), LOW (4 dB), MEDIUM (8 dB), HIGH (12 dB).

With RM-WGS, select one of the following: OFF (0 dB), LOW (6 dB), MEDIUM (12 dB), HIGH (18 dB).

With RM-WGL, select one of the following: OFF (0 dB), LOW (6 dB), MEDIUM (12 dB), HIGH (18 dB).

- **[Adaptive Echo Canceller]**

Allows you to suppress echo generation. Select one of the following: OFF, GENTLE, MEDIUM, STRONG.

- **[Noise Reduction]**

Allows you to suppress ambient noise from the mix. Select one of the following: OFF, GENTLE, MEDIUM, STRONG.

- **[Dereverberation]**

Allows you to suppress reverberation. Select one of the following: OFF, GENTLE, MEDIUM, STRONG.

- **[AGC Type]**

AGC (Auto Gain Control) automatically adjusts the volume of the microphone. For the AGC type, select one of the following: OFF, SOFT, HARD.

- **[AGC Speed]**

For the AGC speed, select one of the following: OFF, SLOW, FAST.



- **[Enable PEQ]**

Allows you to select whether to enable PEQ (Parametric EQ). This is effective when used in combination with a processor other than RM-CR.

- **[Band], [Type], [Q], [Freq.], [Gain], [Bypass]**

Allows you to specify PEQ settings for each of the six bands.

For [Type] under “Band A” or “Band F”, select one of the following: PEQ, L.SHELF-6dB/Oct, L.SHELF-12dB/Oct, H.SHELF-6dB/Oct, H.SHELF-12dB/Oct, HPF, LPF.

- Allows you to cancel pairing by clicking  (trash can).

[AUDIO]

YAMAHA RM-WAP Device Manager

LOGOUT

HOME SETTINGS AUTO SETUP

ADMIN CHARGER MICROPHONE **AUDIO** DECT NETWORK REGION

Configure audio network settings SUBMIT

1 Dante Channels Setup

Channel	Name	Type
1	01-RM-WDR-035700D6B8	DR
2	02-RM-WOM-035700D2E0	OM
3	03-RM-WGS-035703B250	GS
4	04-RM-WGL-035700BAC8	GL
5		
6		
7		
8		

2 DECT Audio Mode: HIGH DENSITY HIGH QUALITY

RM-WAP Device Manager © Yamaha 2021. All rights reserved. [Show licenses](#)

① [Dante Channels Setup]

- Allows you to check the Dante channel assigned to each microphone.
- Allows you to change the channel assignment by dragging the microphone name to the row of the desired Dante channel.

② [DECT Audio]

Allows you to set the access point to High Density mode or High Quality mode. High Quality mode has better audio quality than High Density mode, but the maximum number of microphones that can be used may be limited.

[DECT]

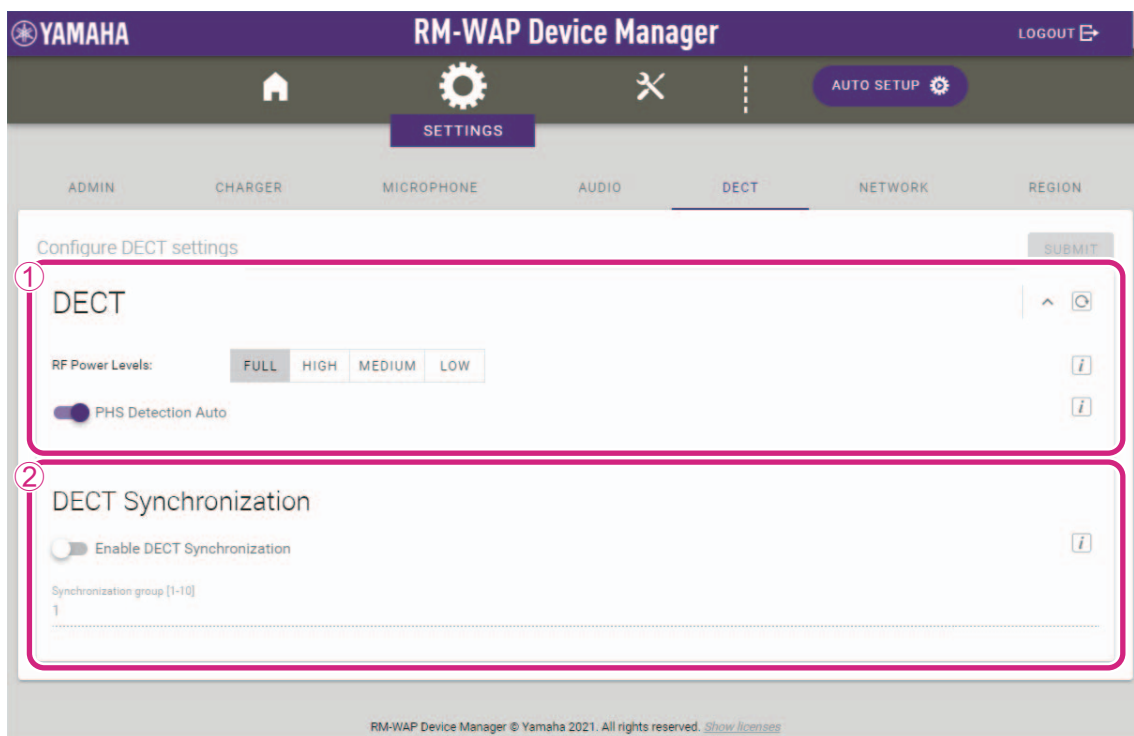

① [DECT]

- Allows you to select the signal strength.

② [DECT Synchronization]

Allows you to select whether to synchronize the DECT frame across multiple access points. When multiple access points are used, turn on [Enable DECT Synchronization], and then put all devices to be synchronized into the same group under [Synchronization group].

[NETWORK]

YAMAHA RM-WAP Device Manager

LOGOUT

HOME SETTINGS AUTO SETUP

ADMIN CHARGER MICROPHONE AUDIO DECT NETWORK REGION

Configure network settings SUBMIT

1 Network

IP Address Settings

Enable DHCP

IP Address

Subnet Mask

Default Gateway

Primary DNS

Secondary DNS

2 AP Name Settings

Mode: NAME USING UNIT ID MANUAL

Unit ID: 1

AP Name: Yamaha-RM-WAP-8

RM-WAP Device Manager © Yamaha 2021. All rights reserved. [Show licenses](#)

① [IP Address Settings]

Allows you to select whether to use DHCP. When set to use DHCP, the IP address is specified in Auto IP mode if there is no DHCP server.

If settings have been incorrectly specified, press the Reset button on the front of the RM-WAP to reset the network-related settings.

② [AP Name Settings]

Allows you to select whether to specify the name of the access point automatically or manually. For [UNIT ID], enter single-byte hexadecimal characters.

[REGION]

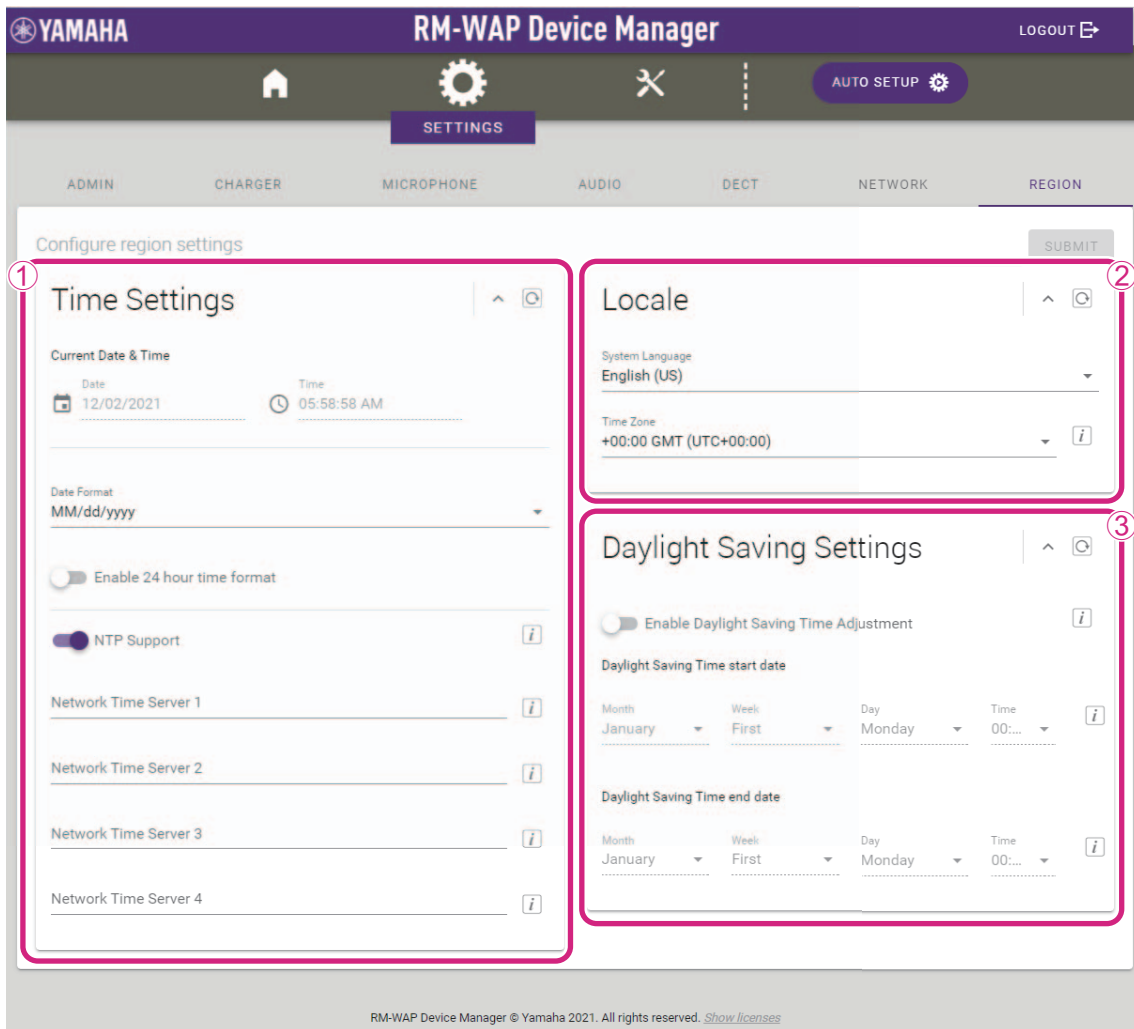

① [Time Settings]

- Allows you to specify the date and time.
- Allows you to select whether to use NTP.

② [Locale]

Allows you to specify the time zone.

③ [Daylight Saving Settings]

Allows you to select whether to use daylight saving time with the access point.

[TOOLS]

[SITE SURVEY]

- Allows the access point to measure the signal strength in the installation environment and the channel usage status by clicking the [START SURVEY] button.

IMPORTANT: If radio frequency interference occurs, there may be no sound from the microphones or the microphone connection may be unexpectedly cut. We recommend thoroughly examining the environment before installation.

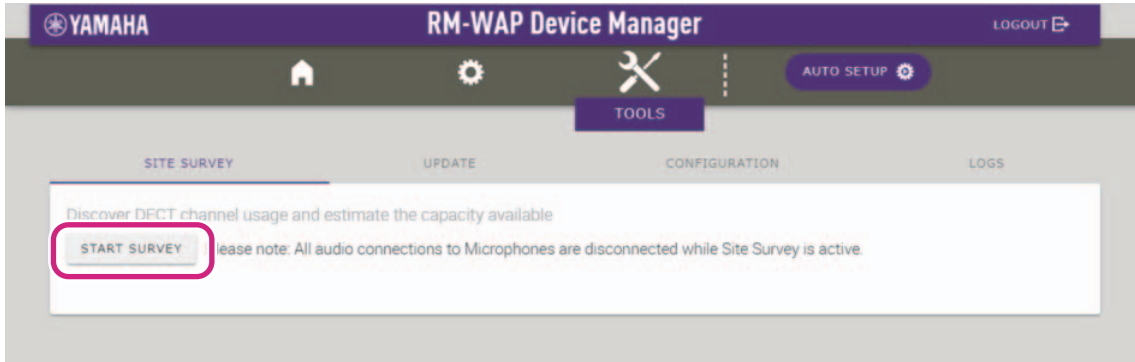

- Allows you to check the measurement results and the number of microphones that can be used in the installation environment, by clicking the [RSSI SCAN MODE] button. For highly accurate measurements, make sure that all nearby wireless microphones and other DECT devices are operational. In addition, it is recommended to measure for several hours under typical usage conditions in order to obtain accurate results. The values beside “High Density Audio Mode” and “High Quality Audio Mode” refer to the maximum number of microphones that can be used in each mode.

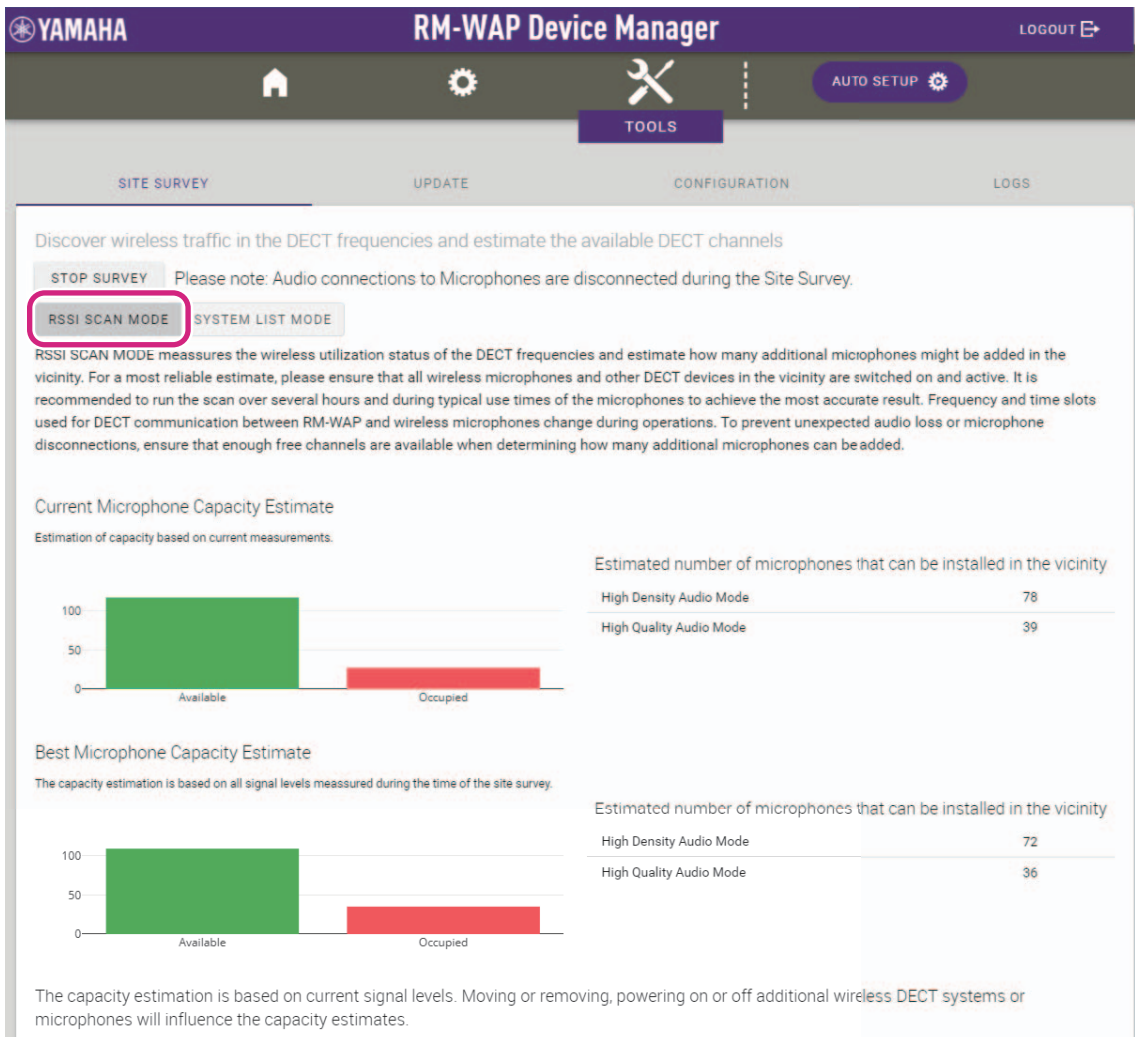

Microphone Channel usage

This figure shows the number of available and occupied microphone channels since start of the survey.

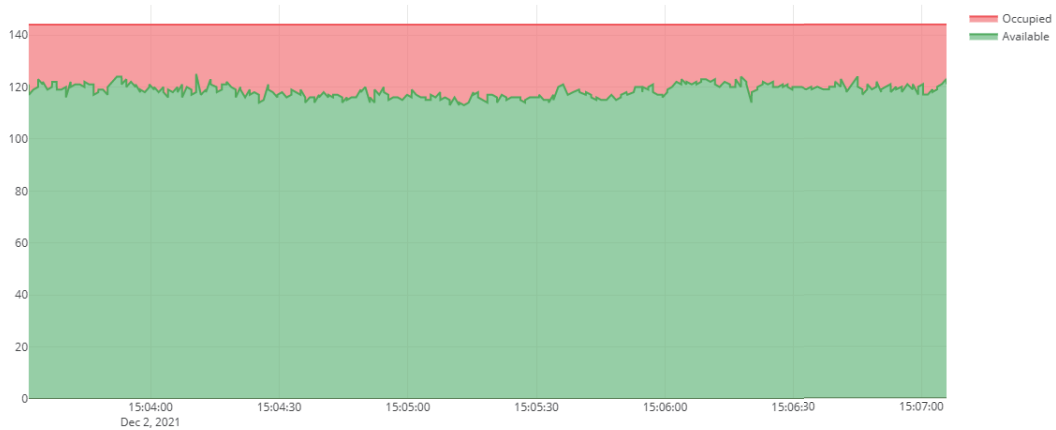

DECT Heatmap

This heatmap shows the received signal strength for each DECT channel. Any channel with a signal strength above -62 dBm is deemed to be currently used by another device for DECT communication. If DECT synchronization is not available or not activated, any non-synchronized DECT device will occupy two adjacent channels. For maximized DECT usage please enable synchronization on all devices in the vicinity where possible.

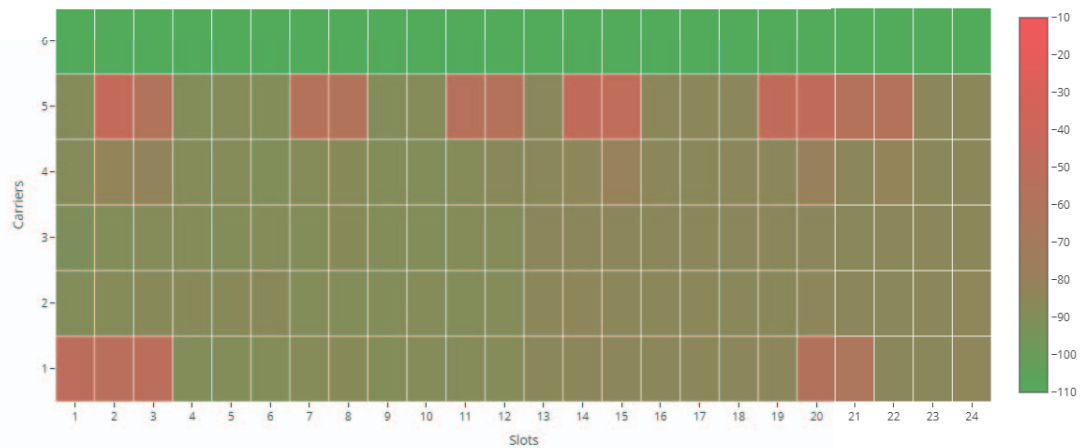

RM-WAP Device Manager © Yamaha 2021. All rights reserved. [Show licenses](#)

- Allows you to check for DECT masters in the installation environment as well as their signal strength by clicking the [SYSTEM LIST MODE] button.

YAMAHA RM-WAP Device Manager LOGOUT

HOME SETTINGS TOOLS AUTO SETUP

SITE SURVEY UPDATE CONFIGURATION LOGS

Discover wireless traffic in the DECT frequencies and estimate the available DECT channels

STOP SURVEY Please note: Audio connections to Microphones are disconnected during the Site Survey.

RSSI SCAN MODE **SYSTEM LIST MODE**

SYSTEM LIST MODE allows to search and find other RM-WAPs and neighboring DECT base stations. Devices will be listed with their RFPI (Radio Fixed Part Identity) and the RSSI (Radio Signal Strength Indicator). Devices with a signal strength of -62 dBm or higher might interfere with the DECT communication of the RM-WAP that is running the scan. Interference might lead to unexpected audio loss or microphone disconnections. It is recommended to enable DECT synchronization to synchronize the DECT clock between different WAPs and adjust RF power levels to prevent signal interferences. Please note that RM wireless microphone and other DECT mobile devices, know as Portable Parts, cannot be found in this mode.

RFPI	RSSI
035700CECO	-50
035703F600	-54
035700D808	-58
0357049EF8	-52

[UPDATE]

Allows you to update the firmware of access points, wireless microphones and chargers from the [UPDATE] window.

- IMPORTANT:**
- Be sure to click the [TURN ON FWU MODE] button before updating the firmware.
 - Be sure to click the [TURN OFF FWU MODE] button after updating the firmware.

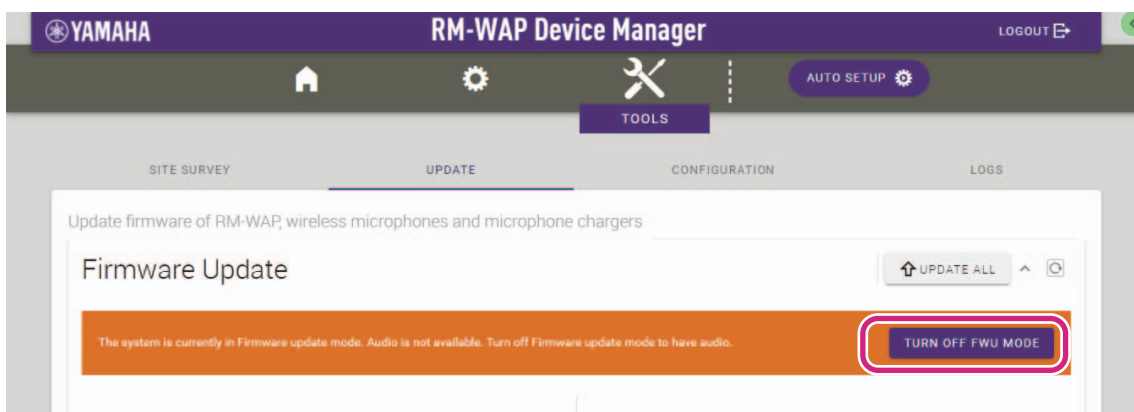
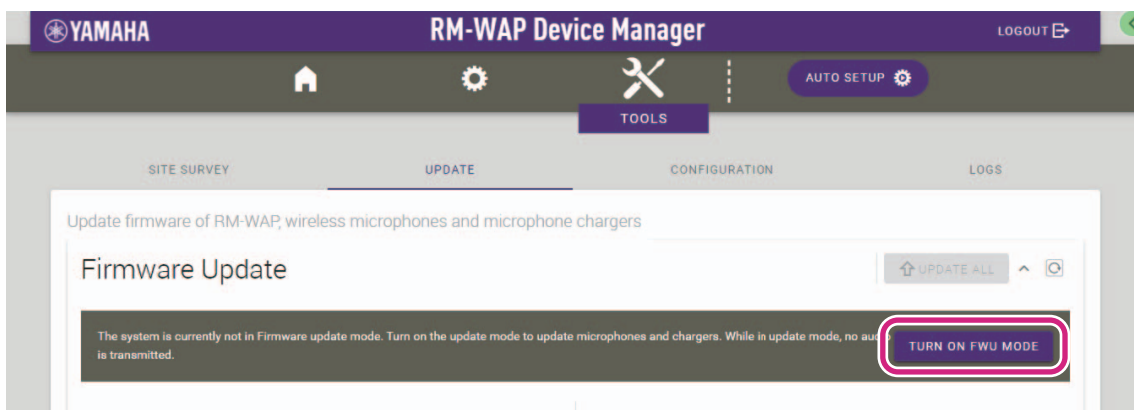

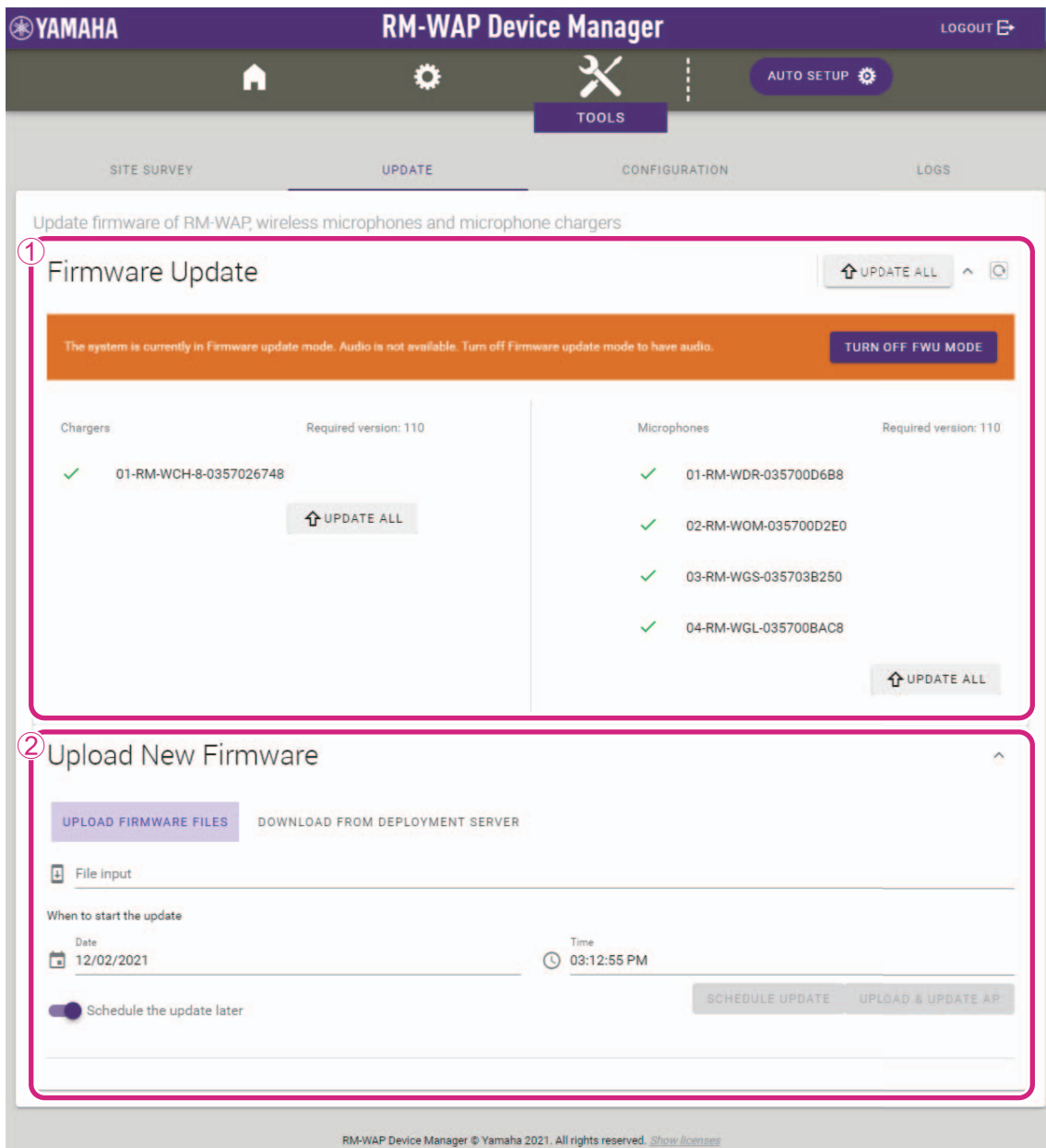

① [Firmware Update]

Allows you to update the firmware of the charger and microphones by clicking the [UPDATE ALL] button.

② [Upload New Firmware]

- Allows you to update the firmware of the access point. Click , select the firmware, and then click the [UPLOAD & UPDATE AP] button.

NOTE: Alternatively, you can drag the firmware directly to the underlined area. The firmware can also be updated from the deployment server.

- Allows you to specify that the update will be performed automatically at the specified time.

[CONFIGURATION]

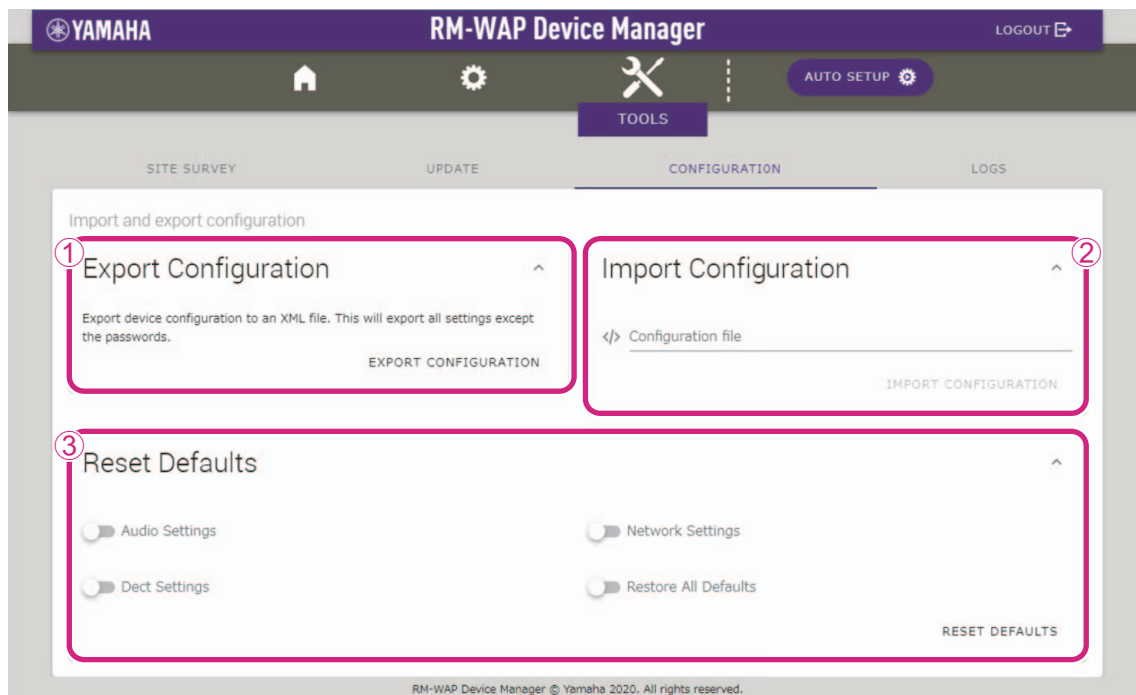

① [Export Configuration]

Allows you to export the settings by clicking the [EXPORT CONFIGURATION] button.

② [Import Configuration]

Allows you to import settings. Click `</>`, select a settings file, and then click the [IMPORT CONFIGURATION] button.

NOTE:

- Create the settings file to be imported by editing the one exported in ①.
- Alternatively, you can drag the settings file directly to the underlined area.

③ [Reset Defaults]

Allows you to reset the settings by clicking the [RESET DEFAULTS] button.

IMPORTANT: Be sure to check what is to be reset before doing it.

[LOGS]

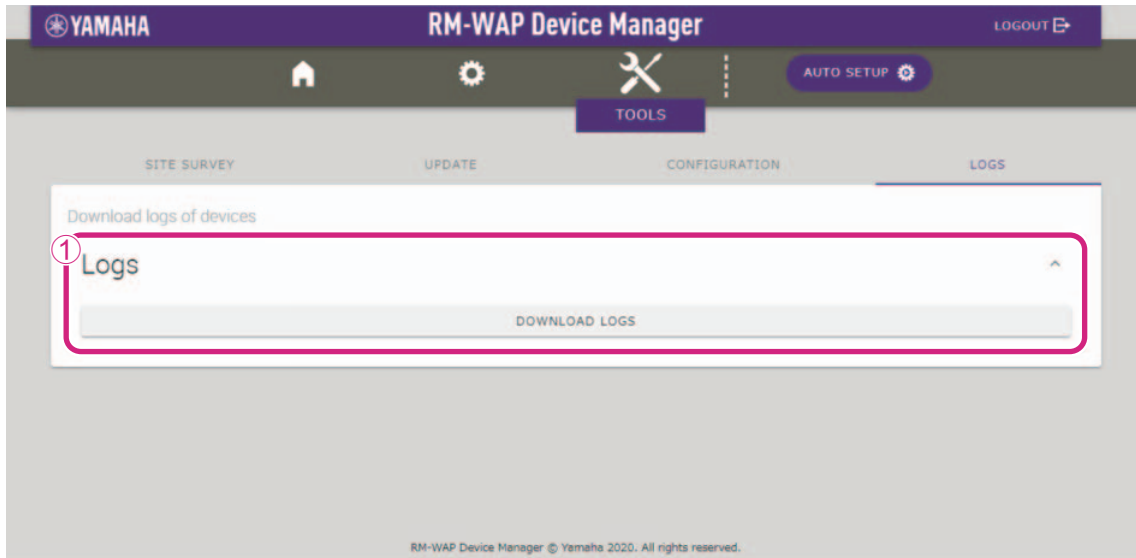

① [Logs]

Allows you to download logs by clicking the [DOWNLOAD LOGS] button.

MAIN SPECIFICATIONS

RM-WAP-8

General specifications

Dimensions	W 171.2 mm × D 172.5 mm × H 42.8 mm
Weight	650 g (including mounting bracket)
Power requirements	PoE (IEEE802.3af), 48 V DC
Maximum power consumption	48 V, 0.2 A
In operation	Temperature 0 °C – 40 °C
	Humidity 20% – 85% (no condensation)
Storage	Temperature –20 °C – 60 °C
	Humidity 10% – 90% (no condensation)
Indicators	<ul style="list-style-type: none">• Power• Status• Network port
Maximum number of connections to RM-CR	2
Accessories	<ul style="list-style-type: none">• Mounting bracket : 1• Owner's Manual (this document) : 1

Network specifications

Dante/PoE port	<ul style="list-style-type: none">• Dante audio/Dante control• External control• PoE• Cable requirements: CAT5e or higher, STP
-----------------------	---

Audio specifications

Sampling rate	48 kHz
Bit depth	24-bit
Audio input/output (Dante)	8 out out1–out8: Mic input signals (maximum 8)

Wireless specifications

Supported standard	1.9 GHz DECT standard
Radio frequency	<ul style="list-style-type: none">• USA/Canada: 1920.0 MHz – 1930.0 MHz• Europe/Northern Europe/UK/Australia/New Zealand: 1880.0 MHz – 1900.0 MHz• Japan: 1893.5 MHz – 1906.1 MHz
Maximum output power (EIRP)	<ul style="list-style-type: none">• USA/Canada: 23.5 dBm• Europe/Northern Europe/UK/Australia/New Zealand/Japan: 26.5 dBm
Antenna (built-in)	Supports space diversity
Use	<ul style="list-style-type: none">• Audio communication and control between access point and microphone• Control between access point and charger
Maximum coverage distance	50 m (depends on the usage environment)
Encryption method	AES (256-bit)

RM-WOM RM-WDR RM-WGL RM-WGS

General specifications

Dimensions	RM-WOM RM-WDR	W 89.0 mm × D 89.0 mm × H 26.0 mm
	RM-WGL	W 89.0 mm × D 89.0 mm × H 308.4 mm
	RM-WGS	W 89.0 mm × D 89.0 mm × H 171.2 mm
Weight	RM-WOM	126 g
	RM-WDR	130 g
	RM-WGL	152 g
	RM-WGS	140 g
Power requirement		RM-WBT (lithium-ion battery) Output: 3.60 V, 2350 mAh
Maximum power consumption		5 V, 0.7 A
In operation	Temperature	0 °C – 40 °C
	Humidity	20% – 85% (no condensation)
In charging	Temperature	5 °C – 40 °C
	Humidity	20% – 85% (no condensation)
Storage	Temperature	–20 °C – 60 °C
	Humidity	10% – 90% (no condensation)
Indicators	RM-WOM RM-WDR	<ul style="list-style-type: none"> • Mic • Battery
	RM-WGL RM-WGS	<ul style="list-style-type: none"> • Mic • Ring • Battery
Accessories	RM-WOM RM-WDR	<ul style="list-style-type: none"> • RM-WBT (battery) :1 • Owner's Manual (this document) :1
	RM-WGL RM-WGS	<ul style="list-style-type: none"> • Windscreen :1 • RM-WBT (battery) :1 • Owner's Manual (this document) :1

Audio specifications

Frequency response		160 Hz – 16 kHz (–10 dB)
Sampling rate		48 kHz
Bit depth		24-bit
Latency	RM-WGL RM-WGS	30 – 35 ms nominal (no sound processing, High Quality mode) / 110 ms nominal (with sound processing, High Quality mode)
	RM-WDR RM-WOM	110 ms nominal (with sound processing, High Quality mode)
Maximum input level of SPL (0 dBFS)	RM-WOM	99.4 dB SPL
	RM-WDR	100.2 dB SPL
	RM-WGL RM-WGS	106.2 dB SPL
Self noise	RM-WOM	–23.0 dBA SPL
	RM-WDR	–24.7 dBA SPL
	RM-WGL RM-WGS	–19.3 dBA SPL
SNR (Ref. 94 dB SPL at 1 kHz)	RM-WOM	117.0 dBA
	RM-WDR	118.7 dBA
	RM-WGL RM-WGS	113.3 dBA
Sensitivity	RM-WOM	–5.4 dBFS/Pa
	RM-WDR	–6.2 dBFS/Pa
	RM-WGL RM-WGS	–12.2 dBFS/Pa
Dynamic range	RM-WOM	122.4 dBA
	RM-WDR	124.9 dBA
	RM-WGL RM-WGS	125.5 dBA

Wireless specifications

Supported standard	1.9 GHz DECT standard
Radio frequency	<ul style="list-style-type: none"> USA/Canada: 1920.0 MHz – 1930.0 MHz Europe/Northern Europe/UK/Australia/New Zealand: 1880.0 MHz – 1900.0 MHz Japan: 1893.5 MHz – 1906.1 MHz
Maximum output power (EIRP)	<ul style="list-style-type: none"> USA/Canada: 23.5 dBm Europe/Northern Europe/UK/Australia/New Zealand/Japan: 26.5 dBm
Antenna (built-in)	Supports space diversity
Use	Audio communication and control between access point and microphone
Maximum coverage distance	50 m (depends on the usage environment)
Encryption method	AES (256-bit)

RM-WCH-8

General specifications

Dimensions	W 304.0 mm × D 188.0 mm × H 41.5 mm
Weight	800 g
Power requirement	P16V2.4A-R (AC adaptor) Output: 16.0 V DC, 2.4 A 
Maximum power consumption	16 V, 2.0 A
In operation	Temperature 0 °C – 40 °C
	Humidity 20% – 85% (no condensation)
Storage	Temperature –20 °C – 60 °C
	Humidity 10% – 90% (no condensation)
Indicator	Activate
Accessories	<ul style="list-style-type: none">• P16V2.4A-R (AC adaptor) :1• Power cord :1 or 3• Owner's Manual (this document) :1

Wireless specifications

Supported standard	1.9 GHz DECT standard
Radio frequency	<ul style="list-style-type: none">• USA/Canada: 1920.0 MHz – 1930.0 MHz• Europe/Northern Europe/UK/Australia/New Zealand: 1880.0 MHz – 1900.0 MHz• Japan: 1893.5 MHz – 1906.1 MHz
Maximum output power (EIRP)	<ul style="list-style-type: none">• USA/Canada: 23.5 dBm• Europe/Northern Europe/UK/Australia/New Zealand/Japan: 26.5 dBm
Antenna (built-in)	Supports space diversity
Use	Control between access point and charger
Maximum coverage distance	50 m (depends on the usage environment)
Encryption method	AES (256-bit)