



2N[®] Indoor View



User guide

Firmware: 2.32

Version: 2.32

www.2n.cz

The 2N TELEKOMUNIKACE a.s. is a Czech manufacturer and supplier of telecommunications equipment.



The product family developed by 2N TELEKOMUNIKACE a.s. includes GSM gateways, private branch exchanges (PBX), and door and lift communicators. 2N TELEKOMUNIKACE a.s. has been ranked among the Czech top companies for years and represented a symbol of stability and prosperity on the telecommunications market for almost two decades. At present, we export our products into over 120 countries worldwide and have exclusive distributors on all continents.



2N[®] is a registered trademark of 2N TELEKOMUNIKACE a.s. Any product and/or other names mentioned herein are registered trademarks and/or trademarks or brands protected by law.



2N TELEKOMUNIKACE a.s. administers the FAQ database to help you quickly find information and to answer your questions about 2N products and services. On www.faq.2n.cz you can find information regarding products adjustment and instructions for optimum use and procedures „What to do if...“.



2N TELEKOMUNIKACE a.s. hereby declares that the 2N product complies with all basic requirements and other relevant provisions of the 1999/5/EC directive. For the full wording of the Declaration of Conformity see the CD-ROM (if enclosed) or our website at www.2n.cz.



The 2N TELEKOMUNIKACE a.s. is the holder of the ISO 9001:2009 certificate. All development, production and distribution processes of the company are managed by this standard and guarantee a high quality, technical level and professional aspect of all our products.

Content:

- 1. Product Description
 - 1.1 Product Description
 - 1.2 Differences between Models and Associated Products
 - 1.3 Terms and Symbols Used
 - 1.4 Safety Precautions
- 2. Description and Installation
 - 2.1 Before You Start
 - 2.2 Quick installation guide
 - 2.3 Installation Conditions
 - 2.4 2N® Indoor View LAN Location via 2N® Network Scanner
 - 2.5 IP Address Lookup
- 3. Configuration
 - 3.1 Factory Reset
 - 3.2 Software Configuration
- 4. Device Control via Display
 - 4.1 Call Log
 - 4.2 Directory
 - 4.3 Settings
- 5. Operational Statuses
- 6. Technical Parameters
- 7. Supplementary Information
 - 7.1 Troubleshooting
 - 7.2 Directives, Laws and Regulations – General Instructions and Cautions

1. Product Description

In this section, we introduce the **2N[®] Indoor View** product, outline its application options and highlight the advantages following from its use. The section also includes safety precautions.

- 1.1 Product Description
- 1.2 Differences between Models and Associated Products
- 1.3 Terms and Symbols Used
- 1.4 Safety Precautions

1.1 Product Description

2N[®] Indoor View is a stylish, compact-design indoor IP/SIP unit providing audio and video communication with the **2N IP intercoms**. The device includes a 4 mm enhanced glass touchscreen panel, Speakerphone, high-quality microphone with excellent audibility and intelligibility properties, Ethernet LAN interface and induction loop and doorbell external supply connectors. **2N[®] Indoor View** is a top-quality, cost efficient and easy to install and configure answering unit. One installation can combine variable answering units manufactured by 2N Telekomunikace a.s.

2N[®] Indoor View is equipped with a specific user interface for an increased user comfort and safety.

2N[®] Indoor View basic features

- 7" color LCD video display
- full duplex handsfree HD audio communication
- LAN interface with PoE supply option
- easy flush mounting
- the device can be combined in installations with **2N[®] Indoor Touch**, **2N[®] Indoor Compact** or **2N[®] Indoor Talk** answering units,
- remote administration and configuration via **2N[®] Remote Configuration**
- call setup option via **2N[®] Mobile Video** on a smartphone
- DND mode and parental lock
- remote door lock control
- time display at relax
- display of the current weather,
- integrated administrator web interface,
- external doorbell button input
- external power supply input
- induction loop output

1.2 Differences between Models and Associated Products

2N® Indoor View indoor units

2N Part No. 91378601
Axis Part No. 02087-001

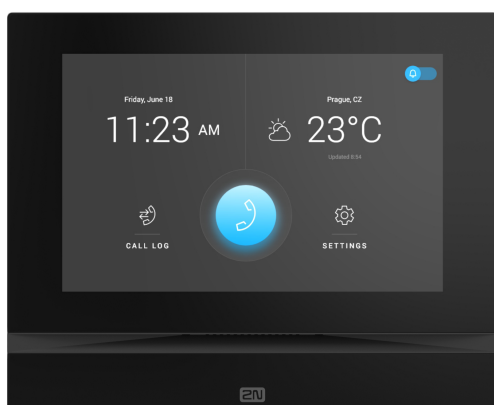

- 2N® Indoor View - black
- Indoor answering audio/video unit with touchscreen designed for all 2N IP intercoms

2N Part No. 91378601WH
Axis Part No. 02088-001



- 2N® Indoor View - white
- Indoor answering audio/video unit with touchscreen designed for all 2N IP intercoms

Other Indoor Units and Accessories

Part Numbers:

2N Part No. 91378375

Axis Part No. 01668-001

2N Part No. 91378376

Axis Part No. 01670-001



- 2N[®] Indoor Touch 2.0 - black
- WiFi version (third and fourth Part Nos.)
- 2N[®] Indoor Touch 2.0, an elegant indoor touch panel, is designed for all of the 2N IP intercoms. The display panel shows you the person standing at your door and helps you make conversation with the visitor, open the door lock or switch on the entrance hall lights.

2N Part No. 91378382

Axis Part No. 01425-001



- 2N[®] Indoor Touch - desk stand black

Part Numbers:

2N Part No. 91378375WH

Axis Part No. 01669-001

2N Part No. 91378376WH

Axis Part No. 01671-001



- 2N[®] Indoor Touch 2.0 - white
- WiFi version (third and fourth Part Nos.)
- 2N[®] Indoor Touch 2.0, an elegant indoor touch panel, is designed for all of the **2N IP intercoms**. The display panel shows you the person standing at your door and helps you make conversation with the visitor, open the door lock or switch on the entrance hall lights.

2N Part No. 91378382W

Axis Part No. 01426-001

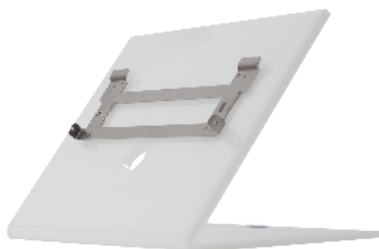

- 2N[®] Indoor Touch - desk stand white

2N Part No. 91378501

Axis Part No. 01935-001

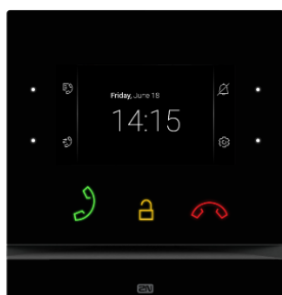

- 2N[®] Indoor Compact - black
- Indoor answering audio/video unit with touchscreen designed for all **2N IP intercoms**

2N Part No. 91378501WH

Axis Part No. 01936-001



- 2N[®] Indoor Compact – white
- Indoor answering audio/video unit with touchscreen designed for all 2N IP intercoms

2N Part No. 91378401

Axis Part No. 01698-001



- 2N[®] Indoor Talk – black
- Indoor answering audio unit with touchscreen designed for all 2N IP intercoms

2N Part No. 91378401WH

Axis Part No. 01699-001



- 2N[®] Indoor Talk – white
- Indoor answering audio unit with touchscreen designed for all 2N IP intercoms

Mounting Accessories

<p>2N Part No. 91378800 Axis Part No. 01700-001</p> 	<ul style="list-style-type: none">• Installation box for 2N indoor answering units for installation in a wall or plasterboard.• Not included in the 2N[®] Indoor View package.
<p>2N Part No. 91378803 Axis Part No. 02320-001</p> 	<ul style="list-style-type: none">• Wall mounting box for 2N answering units• Not included in the 2N[®] Indoor View package.
<p>2N Part No. 91378802 Axis Part No. 02039-001</p> 	<ul style="list-style-type: none">• Stand for the 2N indoor answering unit.• Not included in the 2N[®] Indoor View package.

VoIP Phones

2N Part No. 91378358

Axis Part No. 01421-001



- Grandstream GXV3240 VoIP video telephone
- GXV3240 is the successor to the popular GXV3140 model, which provides comfortable video calls in the IP network. Touchscreen and keypad control.

2N Part No. 91378357

Axis Part No. 01422-001



- Grandstream GXV3275 VoIP video telephone
- GXV3275 is the successor to the popular GXV3175 model, which provides comfortable video calls in the IP network. Touchscreen control.

1.3 Terms and Symbols Used

The following symbols and pictograms are used in the manual:

Safety

- Always abide by this information to prevent persons from injury.

Warning

- Always abide by this information to prevent damage to the device.

Caution

- Important information for system functionality.

Tip

- Useful information for quick and efficient functionality.

Note

- Routines or advice for efficient use of the device.

1.4 Safety Precautions

The manufacturer reserves the right to modify the product in order to improve its qualities. The manufacturer continuously responds to the clients' requirements by improving the software. Refer to the www.2n.cz company websites for the latest **2N[®] Indoor View** firmware and User Manual.

- Where necessary, the device can be installed at a safe distance from the prohibited area and an Ethernet cable can only be carried to the required site.
- Install **2N[®] Indoor View** out of reach of sensitive devices and human bodies as it emits electromagnetic interference.
- The permitted scope of operating temperatures is specified in chapter **6. Technical Parameters**.
- The device may not be operated at places exposed to direct sunlight or near heat sources.
- **2N[®] Indoor View** is designed for indoor use. It may not be exposed to rain, flowing water, condensing moisture, fog, and so on.
- It may not be exposed to aggressive gases, acid and solvent vapors, etc.

It is designed for LAN connection.

Caution

- This product and its installation and configuration techniques are not intended for persons with diminished physical, sensory or mental capacities or persons with limited experience and knowledge unless expertly supervised or duly advised as to the use of this product by a person responsible for their safety.

2. Description and Installation

This section describes how to install and connect **2N[®] Indoor View** properly.

Here is what you can find in this section:

- **2.1 Before You Start**
- **2.2 Quick installation guide**
- **2.3 Installation Conditions**
- **2.4 2N[®] Indoor View LAN Location via 2N[®] Network Scanner**
- **2.5 IP Address Lookup**

2.1 Before You Start

Package Completeness Check

Please check the product delivery before starting installation: Contents:

1x	2N [®] Indoor View
2x	External power and doorbell button terminals
1x	Certificate of ownership
1x	2.5 mm hexagon key wrench
1x	Quick Start manual
1x	display cleaning cloth

Front Layout

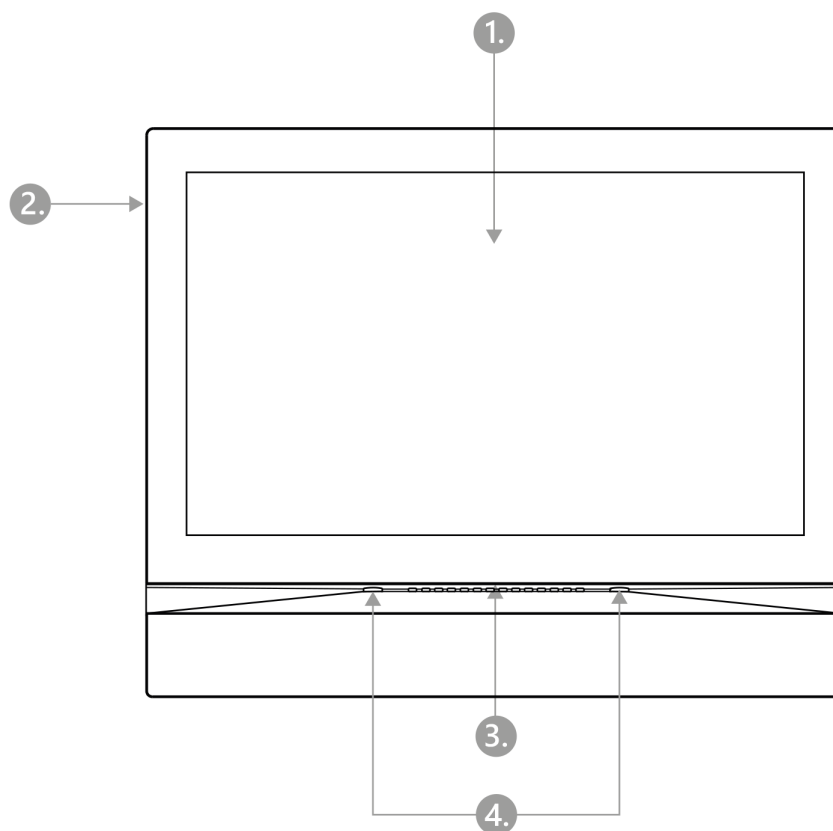

1. Display
2. Microphone
3. Speaker
4. Anchoring holes

Backside Connectors

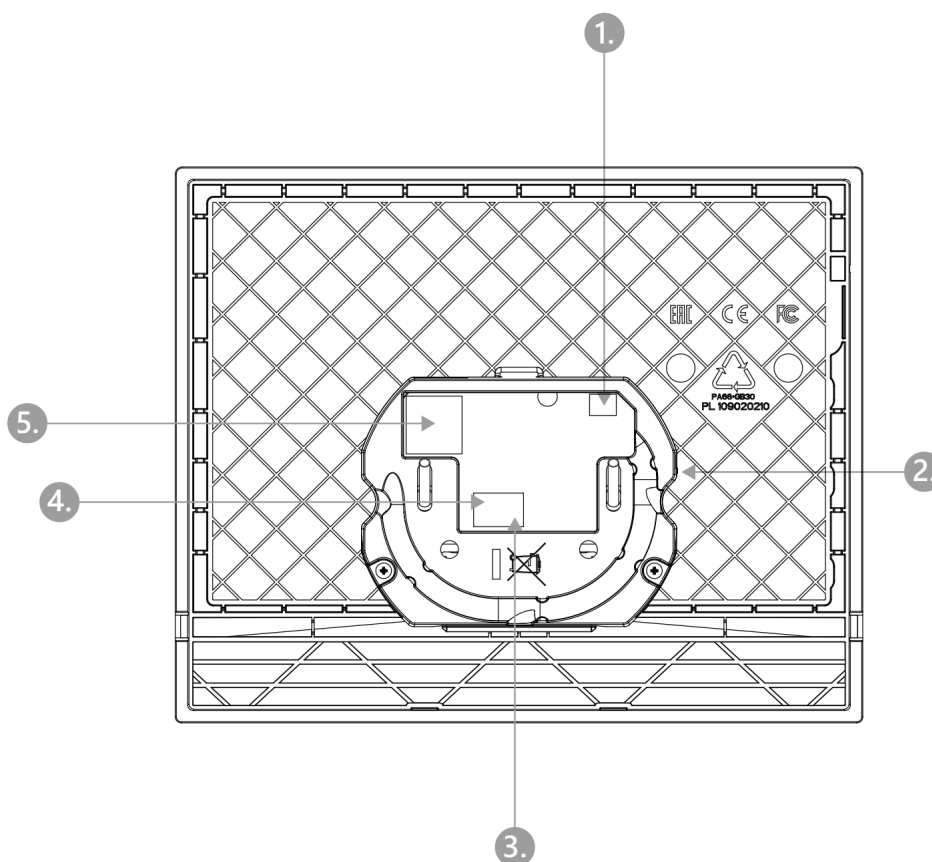

1. Output for connection of an external induction loop
2. Reset button
3. Doorbell button input
4. 12 V / 1 A DC power supply input
5. Ethernet

2N[®] Indoor View is designed for flush mounting (brick, plasterboard, wood). Use the flush mounting box (Part No. 91378800), which is not included in the package. Alternatively, the product can be mounted into a desk stand (Part No. 91378802), which is not included in the package.

 **Caution**

- Before starting the mechanical installation on a selected place, make sure carefully that the preparations connected with it (drilling, wall cutting) cannot damage the electrical, gas, water and other existing wires and pipes.

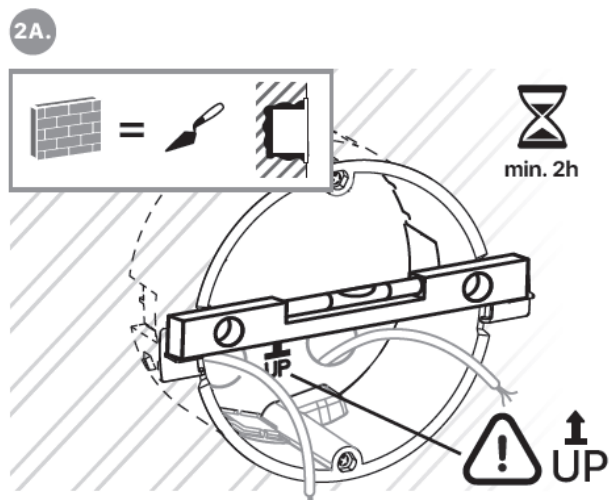
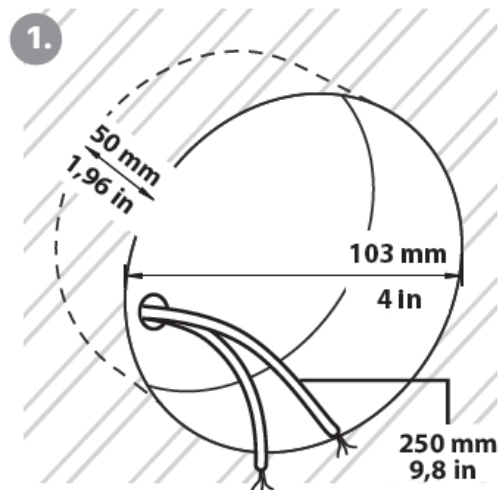

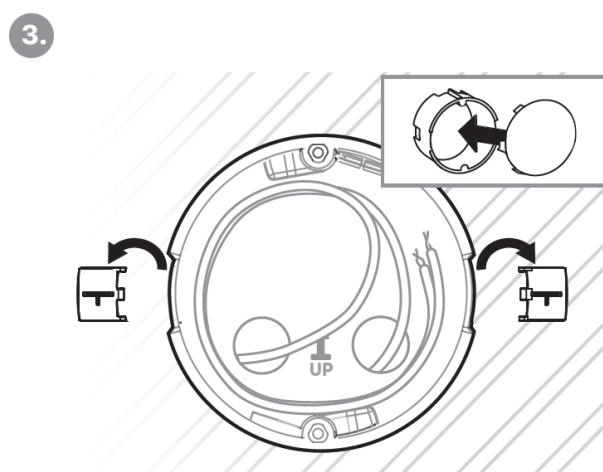
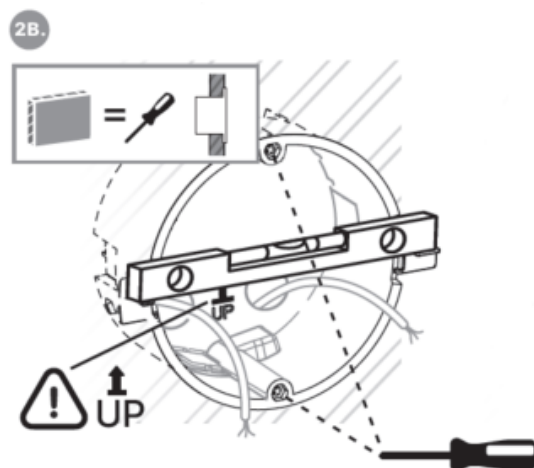

Cut a circular hole in the wall of the diameter of 103 mm and depth of 50 mm before installation. It is assumed that all necessary cables of the maximum length of 25 cm will lead to the hole. Put the flush mounting box in the hole to make sure that the hole is deep enough. If the hole complies with the box size, wall in the box and level the box using a water level on the holding clips. When the mortar hardens, break off the clips and cap the box with the cover provided. Use anchoring elements to fix the device into plasterboard.

✓ **Tip**

[Drill template.pdf](#)

For actual fixing of the **2N[®] Indoor View** to the flush-mount box, have the 2.5 mm Allen key which is included in the box of the **2N[®] Indoor View** at the ready.

i Note

- When installing the **2N[®] Indoor View** into the wall, the local standards relating to installation of electrical devices in flammable material must be taken into consideration.

2.2 Quick installation guide

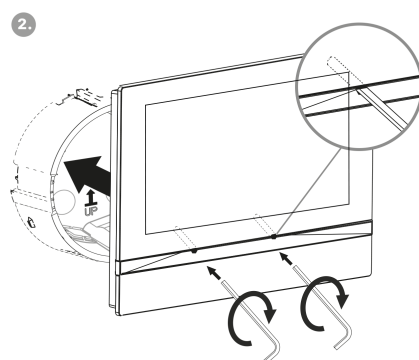
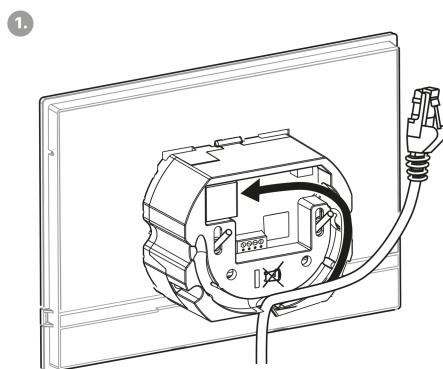

Remove the cover from the walled-in **2N[®] Indoor View** flush mounting box. Remove the pre-prepared cabling, UTP cable, doorbell twin cable and power supply cable. Shorten the cables to 150 mm or less as required. Connect the doorbell twin cable or power supply cable to the connector provided. Crimp the RJ-45 connector onto the UTP cable. Take **2N[®] Indoor View** and lean its bottom edge against the wall below the flush mounting box. First plug the green power/doorbell connector. Connect the LAN connector. Put the cables carefully in the pre-drilled **2N[®] Indoor View** back slot to prevent them from blocking any horizontal levelling movement during the final installation stage. Insert **2N[®] Indoor View** in the flush mounting box making sure that

it clicks onto the levelling pins, The pins allow for a 5-6 ° inclination on either side for accurate horizontal levelling. Apply the box screw nuts with the hexagon key wrench provided. Level **2N[®] Indoor View** with a water level and tighten the screws gently.

Now **2N[®] Indoor View** is ready for basic operation.

2N[®] Indoor View consumption with variable power supplies:

Supply type	Consumption
PoE, IEEE 802.3af	12 W
12 V / 1 A	12 W

 **Warning**

- Do not connect any external power supply if PoE is used and vice versa.
- If you use a power adapter other than the recommended one, do not exceed the 12 V rated supply voltage. Also check the supply voltage polarity. Higher voltage values or misconnections may result in an irreplaceable device damage.

2.3 Installation Conditions

Make sure that the following 2N[®] Indoor View installation conditions are met:

- There must be enough space for the device installation.
- The device is designed for vertical wall mounting (perpendicular to the floor) in the height of up to 120 cm above the floor. If necessary, operate the device in a position other than as aforementioned for a short time only, for quick testing purposes in a servicing center, for example.
- Exceeding the allowed operating temperature may not affect the device immediately but leads to premature ageing and lower reliability. For the acceptable range of operating temperatures and relative humidity values refer to S. 6. **Technical Parameters**.
- The device is not designed for environments with increased vibrations such as means of transport, machine rooms and so on.
- The device is not intended for dusty environments and places with unstable humidity and abrupt temperature changes.
- The device may not be exposed to aggressive gas, acid vapors, solvents, etc.
- The device is not intended for direct connection into the Internet/WAN.
- The device must be connected to the Internet/WAN via a separating active network element (switch/router).
- The device is designed for indoor use. It may not be exposed to rain, flowing water, condensing moisture, fog, etc.
- The device cannot be operated on places exposed to direct sunshine and near heat sources.
- Keep some free space above and below the device to allow air to flow and conduct heat away.
- No strong electromagnetic radiance is allowed on the installation site.
- Make sure that the VoIP connection is configured properly according to the SIP and other VoIP recommendations.
- It is recommended that the power adapter be connected to the mains via a UPS and reliable overvoltage protection.

Power Supply Connection

You can feed 2N[®] Indoor View as follows:

1. Use a 12 V / 1 A DC power adapter connected to the backside terminal board.
2. Use an Ethernet cable connected to a PoE supply or PoE supporting Ethernet switch/router.

PoE Supply Connection

Use a standard straight RJ-45 terminated cable to connect 2N[®] Indoor View to the Ethernet. The device supports the 10BaseT and 100BaseT protocols.

⚠ Caution

- Factory reset results in a change of the Ethernet interface configuration!
- A defective Ethernet cable may lead to a high packet loss in the Ethernet and subsequent instability and poor call quality!

⚠ Warning

- Do not connect any external power supply if PoE is used and vice versa.
- Connection of a defective or improper power supply may lead to a temporary or permanent device failure.

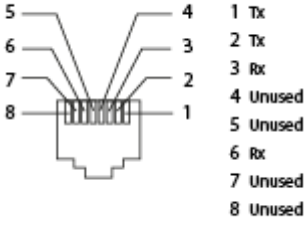
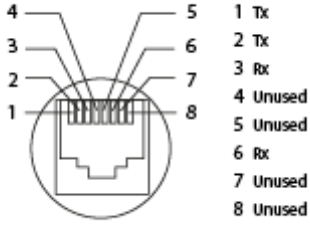
Ethernet cable connector	Ethernet socket
 <p>5 4 1 Tx 6 3 2 Tx 7 2 3 Rx 8 1 4 Unused 5 Unused 6 Rx 7 Unused 8 Unused</p>	 <p>4 5 1 Tx 3 6 2 Tx 2 7 3 Rx 1 8 4 Unused 5 Unused 6 Rx 7 Unused 8 Unused</p>

Firmware Upload

We recommend you to upgrade the 2N[®] Indoor View firmware during installation. Refer to www.2n.cz for the latest FW version. Refer to **3.2.5 System** for the firmware upgrade procedure.

2.4 2N® Indoor View LAN Location via 2N® Network Scanner

2N® Indoor View is configured via the administration web server. Connect the device to the LAN IP and make sure it is properly powered.

2N® Network Scanner Description

The application helps find the IP addresses of all the 2N® Indoor View devices in the LAN. Download the app from the 2N web sites (www.2n.cz). Make sure that Microsoft .NET Framework 2.0 is installed for successful app installation.

1. Run the 2N® Network Scanner.
2. Use the Setup Wizard for successful installation.

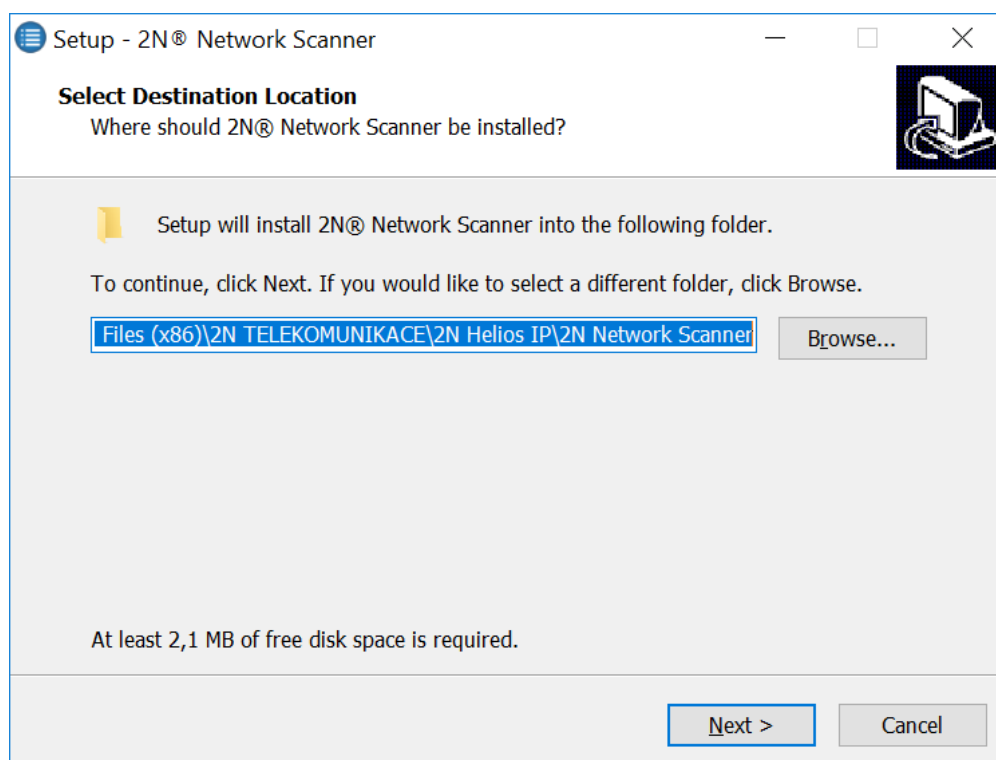

Setup Wizard application 2N® IP Network Scanner

3. Having installed the 2N® IP Network Scanner, start the application using the Microsoft Windows Start menu.

Once started, the application begins to automatically search for all the 2N IP intercoms in the LAN including their smart extensions (2N[®] Indoor View, 2N[®] Indoor Compact, 2N[®] Indoor Talk, 2N[®] Indoor Touch), which are DHCP/statically assigned IP addresses. All the devices are displayed in a table

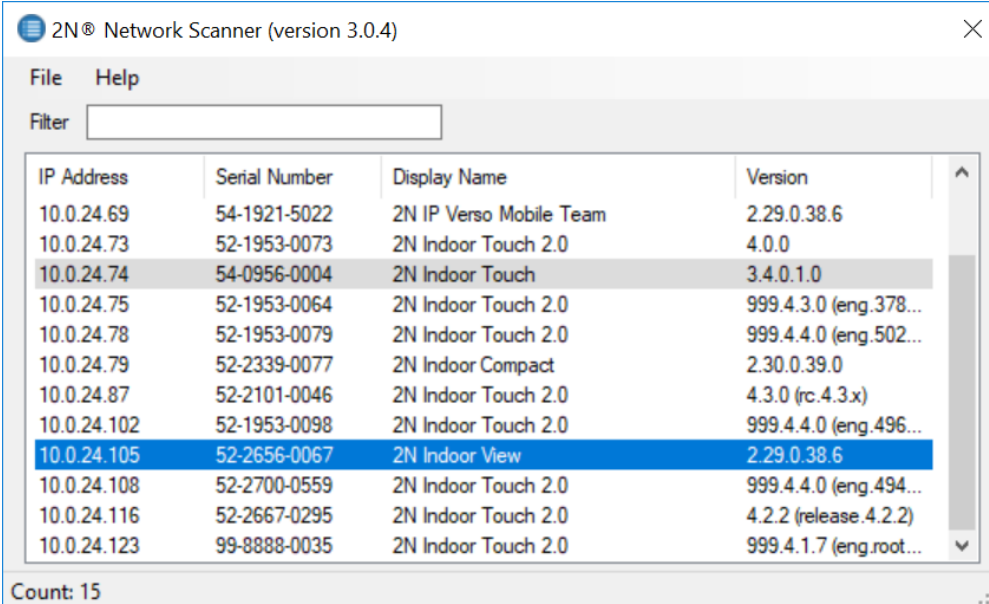

The screenshot shows the '2N[®] Network Scanner (version 3.0.4)' application window. It features a menu bar with 'File' and 'Help', a 'Filter' input field, and a table of discovered devices. The table has four columns: IP Address, Serial Number, Display Name, and Version. The device with IP 10.0.24.105 is highlighted in blue, indicating it is selected. The status bar at the bottom shows 'Count: 15'.

IP Address	Serial Number	Display Name	Version
10.0.24.69	54-1921-5022	2N IP Verso Mobile Team	2.29.0.38.6
10.0.24.73	52-1953-0073	2N Indoor Touch 2.0	4.0.0
10.0.24.74	54-0956-0004	2N Indoor Touch	3.4.0.1.0
10.0.24.75	52-1953-0064	2N Indoor Touch 2.0	999.4.3.0 (eng.378...
10.0.24.78	52-1953-0079	2N Indoor Touch 2.0	999.4.4.0 (eng.502...
10.0.24.79	52-2339-0077	2N Indoor Compact	2.30.0.39.0
10.0.24.87	52-2101-0046	2N Indoor Touch 2.0	4.3.0 (rc.4.3.x)
10.0.24.102	52-1953-0098	2N Indoor Touch 2.0	999.4.4.0 (eng.496...
10.0.24.105	52-2656-0067	2N Indoor View	2.29.0.38.6
10.0.24.108	52-2700-0559	2N Indoor Touch 2.0	999.4.4.0 (eng.494...
10.0.24.116	52-2667-0295	2N Indoor Touch 2.0	4.2.2 (release.4.2.2)
10.0.24.123	99-8888-0035	2N Indoor Touch 2.0	999.4.1.7 (eng.root...

2N[®] IP Network Scanner

Select the 2N[®] Indoor View device to be configured and right-click it. Select *Browse...* to open the 2N[®] Indoor View administration web interface login window for configuration. To change the device IP address, select *Config* and enter the required static IP address or activate DHCP. The default configuration password is 2n. If the found device is grey highlighted, its IP address cannot be configured using this application. In that case, click Refresh to find the device again and check whether multicast is enabled in your network.

Tip

- Double click the selected row in the 2N[®] IP Network Scanner list to access the device web interface easily.

Configuration

DHCP

IP address 10.0.24.65

Net mask 255.255.255.0

Gateway 10.0.24.1

Password 

Cancel Set

2N[®] IP Network Scanner IP Address Change

2.5 IP Address Lookup

To look up the device IP address, take the following steps: Use the free **2N[®] Network Scanner** application or view the information on the device display.

To find the **2N[®] Indoor View** IP address via the **2N[®] Network Scanner**, follow the steps mentioned in the previous subsection, **2.4 2N[®] Indoor View LAN Location via 2N[®] Network Scanner**. Once started, the application begins to automatically search for all the **2N IP intercoms** in the LAN including their smart extensions (**2N[®] Indoor View**, **2N[®] Indoor Compact**, **2N[®] Indoor Talk**, **2N[®] Indoor Touch**), which are DHCP/statically assigned IP addresses. All the devices are displayed in a table including the IP addresses assigned to them.

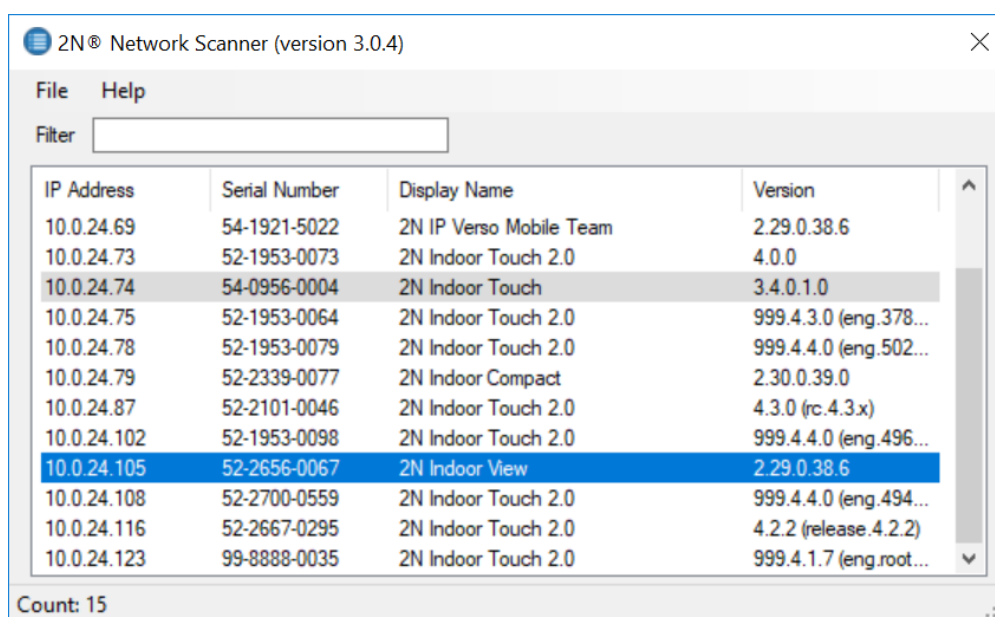

2N[®] Network Scanner (version 3.0.4)

File Help

Filter

IP Address	Serial Number	Display Name	Version
10.0.24.69	54-1921-5022	2N IP Verso Mobile Team	2.29.0.38.6
10.0.24.73	52-1953-0073	2N Indoor Touch 2.0	4.0.0
10.0.24.74	54-0956-0004	2N Indoor Touch	3.4.0.1.0
10.0.24.75	52-1953-0064	2N Indoor Touch 2.0	999.4.3.0 (eng.378...
10.0.24.78	52-1953-0079	2N Indoor Touch 2.0	999.4.4.0 (eng.502...
10.0.24.79	52-2339-0077	2N Indoor Compact	2.30.0.39.0
10.0.24.87	52-2101-0046	2N Indoor Touch 2.0	4.3.0 (rc.4.3.x)
10.0.24.102	52-1953-0098	2N Indoor Touch 2.0	999.4.4.0 (eng.496...
10.0.24.105	52-2656-0067	2N Indoor View	2.29.0.38.6
10.0.24.108	52-2700-0559	2N Indoor Touch 2.0	999.4.4.0 (eng.494...
10.0.24.116	52-2667-0295	2N Indoor Touch 2.0	4.2.2 (release.4.2.2)
10.0.24.123	99-8888-0035	2N Indoor Touch 2.0	999.4.1.7 (eng.root...

Count: 15

To find the **2N[®] Indoor View** IP address using the display, press any key on the display to quit the sleep mode. The Settings menu is displayed on the home screen after pressing the settings icon  in the bottom right corner. Find the IP address information in the Settings / About device menu.

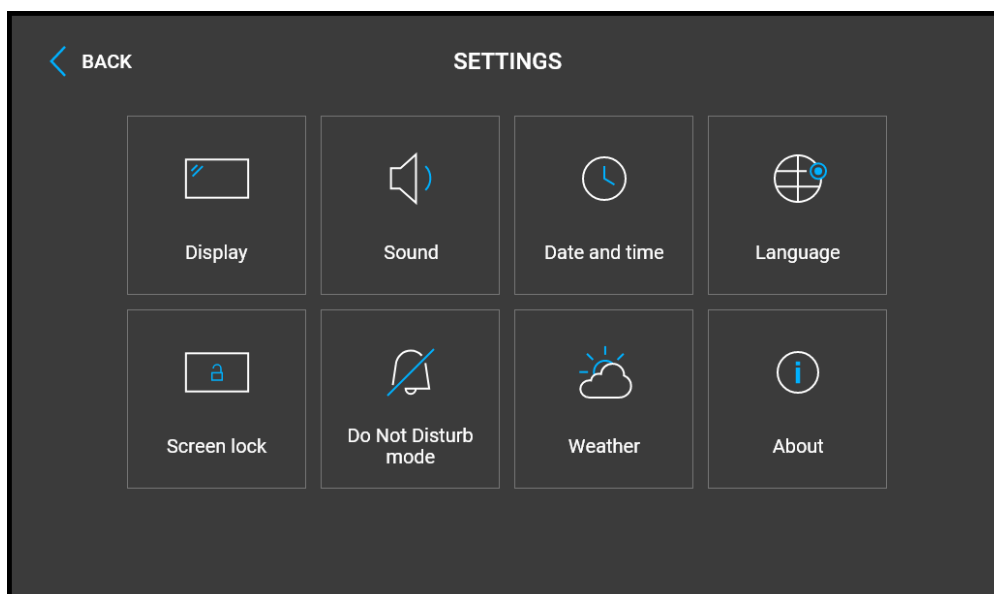

Dynamic/Static IP Address Switching

2N[®] Indoor View is connected to the LAN and has to be assigned a valid IP address or obtain the IP address from the LAN DHCP server. Configure the IP address and DHCP in the System / Network menu.

Use DHCP Server

- **Use DHCP server** – enable automatic obtaining of the IP address from the LAN DHCP server. If there is no DHCP server or the DHCP cannot be used in your network, use the manual network setting.

Manual Settings ▾

Static IP Address	<input type="text" value="192.168.1.100"/>
Network Mask	<input type="text" value="255.255.255.0"/>
Default Gateway	<input type="text" value="192.168.1.1"/>
Primary DNS	<input type="text"/>
Secondary DNS	<input type="text"/>

- **Static IP Address** – static IP address of the device. The address is used together with the parameters below unless Use DHCP server is enabled.
- **Network mask** – set the network mask.

- **Default gateway** - address of the default gateway, which provides communication with off-LAN equipment.
- **Primary DNS** - primary DNS address for domain name-to-IP address translation.
- **Secondary DNS** - secondary DNS address where the primary DNS is unavailable.

3. Configuration

Login

Fill in the **2N[®] Indoor View** address or domain name into the internet browser. to display the login screen. The default login user name and password are as follows:

- Username: **Admin**
- Password: **2n**

Should the login screen fail to appear, you must have typed a wrong IP address/port or the **2N[®] Indoor View** administration web server has been switched off. To find the correct IP address, use the **2N[®] Network Scanner** as described in **2.4 2N[®] Indoor View**

LAN Location via **2N[®] Network Scanner**

Language Selection

Use the menu in the right-hand upper corner of the web interface to select language.

2N Indoor View

CZ | EN | DE | FR | IT | ES | RU

Log out

Language Selection

- **3.1 Factory Reset**
- **3.2 Software Configuration**

3.1 Factory Reset

Reset Button

Located among the main unit connectors, the Reset button helps you reset the factory default values, restart the device, find the device IP address and switch the static /dynamic mode.

IP Address Finding

Follow the instructions below to **identify the current IP address**:

- Press and hold the RESET button.
- Wait until the red and green LEDs go on simultaneously on the device and the acoustic signal can be heard (approx. 15–35 s).
- Release the RESET button.
- The device announces the current IP address via the speaker automatically.

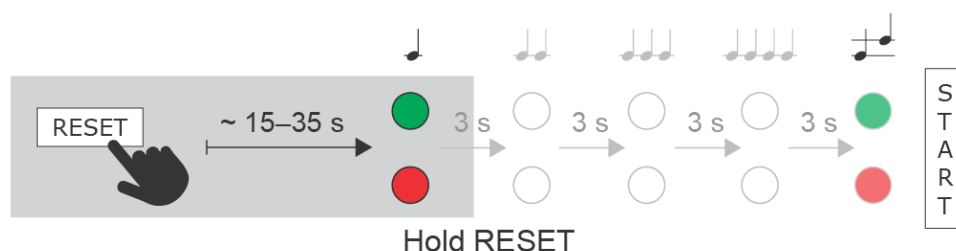



Note

- The delay after pressing RESET till the first light and sound signalling is set to 15–35 s depending on the 2N IP intercom/answering unit model used.
- The time interval 18 s applies to the 2N[®] Indoor View.

Static IP Address Setting

Follow the instructions below to switch on the **Static IP address mode** (DHCP OFF):

- Press and hold the RESET button.

- Wait until the red and green LEDs go on simultaneously on the device and the acoustic signal can be heard  (approx. 15–35 s).
- Wait until the red LED goes off and the acoustic signal can be heard  (approx. for another 3 s).
- Release the RESET button.

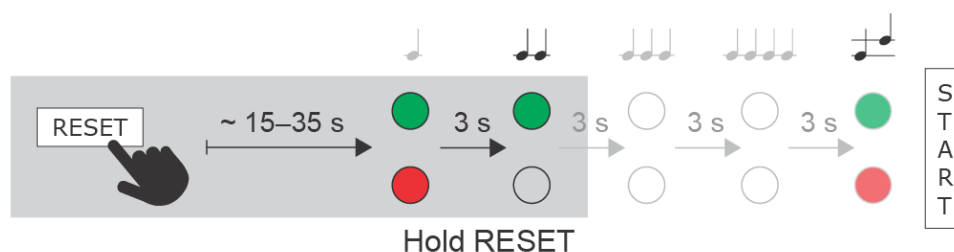

The following network parameters will be set after restart:

- IP address: 192.168.1.100
- Network mask: 255.255.255.0
- Default gateway: 192.168.1.1



Dynamic IP Address Setting



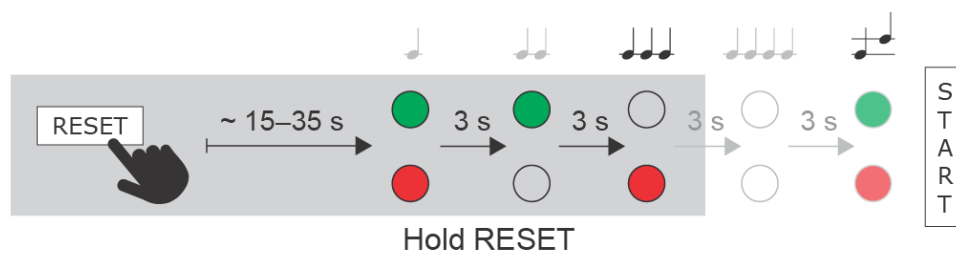

Follow the instructions below to switch on the **Static IP address mode** (DCHP ON):

- Press and hold the RESET button.
- Wait until the red and green LEDs go on simultaneously on the device and the acoustic signal can be heard  (approx. 15–35 s).
- Wait until the red LED goes off and the acoustic signal can be heard  (approx. for another 3 s).
- Wait until the green LED goes off and the red LED goes on again and the acoustic signal can be heard  (approx. for another 3 s).
- Release the RESET button.



Factory Reset

Follow the instructions below to **reset the factory default values**:

- Press and hold the RESET button.
- Wait until the red and green LEDs go on simultaneously and the acoustic signal  can be heard (approx. 15-35 s).
- Wait until the red LED goes off and the acoustic signal  can be heard (approx. for another 3 s).
- Wait until the green LED goes off and the red LED goes on again and acoustic signal  can be heard (approx. for another 3 s).
- Wait until the red LED goes off and the acoustic signal  can be heard (approx. for another 3 s).
- Release the RESET button.

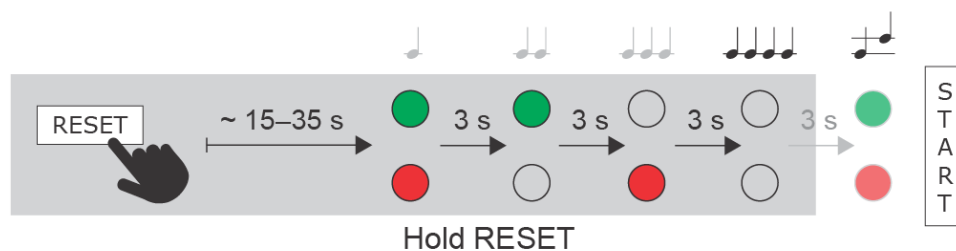

Device Restart

Press the button shortly (< 1 s) to restart the system without changing configuration.

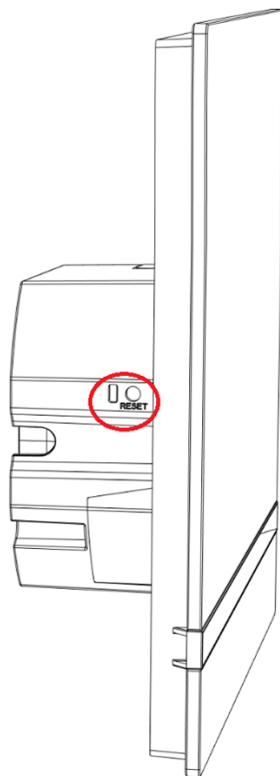

Note

- For the 2N[®] Indoor View, the time interval between a quick press of the RESET button and reconnection of the device to the network is 20 s.

3.2 Software Configuration

2N Indoor View CZ | EN | DE | FR | IT | ES | RU

2N[®] Indoor View



Start Screen

The start screen is displayed when you log in to the 2N[®] Indoor View web interface.

Use the button  in the left-hand upper corner on each of the following web interface pages to return to this screen anytime. The screen header includes the device name (refer to the Display Name parameter in the Services / Phone / SIP menu). Use the buttons to select the web interface languages. Click the Log out button in the right-hand upper corner to log out.

The start screen also provides the first menu level and quick tile navigation to selected 2N[®] Indoor View configuration sections. Some tiles also display the state of selected services.

-
- 3.2.1 Status
 - 3.2.2 Directory
 - 3.2.3 Services
 - 3.2.4 Hardware
 - 3.2.5 System

3.2.1 Status

2N Indoor View CZ | EN | DE | FR | IT | ES | RU

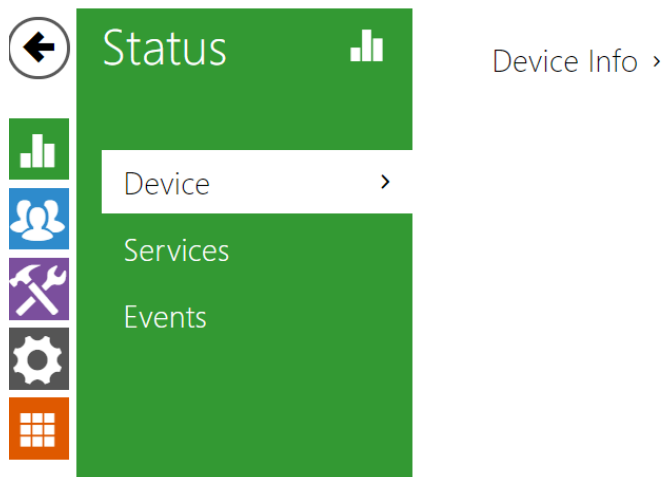

The **Status** menu provides clear status and other current information on the device. The menu consists of three tabs: **Device**, **Services**, **Events**.

- 3.2.1.1 Device
- 3.2.1.2 Services
- 3.2.1.3 Events

3.2.1.1 Device

2N Indoor View CZ | EN | DE | FR | IT | ES | RU

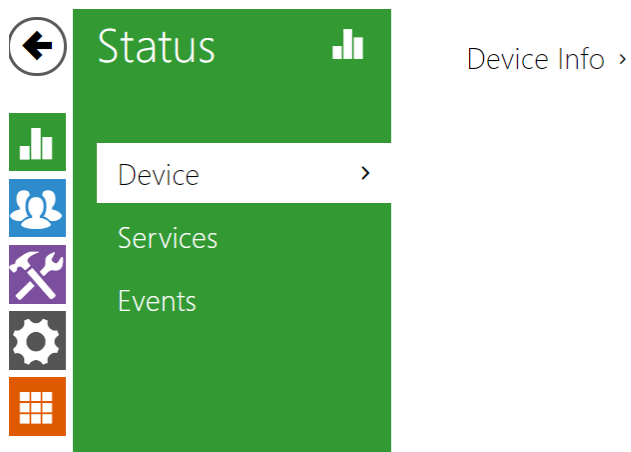

Device

The tab displays information on the model, its features, firmware and bootloader versions, etc.

Device Info ▾

Product Name **2N Indoor View**

Hardware Version **2701v3**

Serial Number **52-2656-0067**

Firmware Version **2.29.2.38.17**

Minimum Firmware Version **2.29.0.38.0**

Bootloader Version **1.0.0.0.7**

Up Time **10d 2h 26m 14s**

Factory Certificate Installed **No**

[Locate Device](#)

- **Factory Certificate Installed** – specify the user certificate and private key to validate the intercom right to communicate with the ACS.
- **Locate device** – optical and acoustic signalling of a device. Optical signalling is possible only if the device is equipped with control backlight (2N[®] IP Verso, 2N[®] IP Solo, 2N[®] IP Base, 2N[®] IP Vario, 2N[®] IP Force, 2N[®] IP Safety a 2N[®] IP Uni , 2N[®] Indoor View, 2N[®] Indoor Compact, 2N[®] Indoor Talk, 2N[®] Indoor Touch 2.0, 2N[®] IP Indoor Touch). If a speaker is not integrated in the device, make sure than an external speaker is connected (2N[®] IP Audio Kit a 2N[®] IP Video Kit). to use sound signalling.

3.2.1.2 Services

Network Interface Status >

Phone Status(SIP1) >

Phone Status(SIP2) >

Services

The Services tab displays the status of the network interface and selected services.

Network Interface Status ▾

MAC Address **7C-1E-B3-04-50-AB**
DHCP Status **USED**
IP Address **10.0.24.45**
Network Mask **255.255.255.0**
Default Gateway **10.0.24.1**
Primary DNS **10.0.100.101**
Secondary DNS **10.0.100.102**

Phone Status (SIP1) ▾

Phone Number (ID) **111**
Registration State **NOT REGISTERED**
Failure Reason -
Registrar Address
Last Registration Time **N/A**

Phone Status (SIP2) ▾

Phone Number (ID) **5742015218**
Registration State **REGISTERED**
Failure Reason -
Registrar Address **proxy-19.my2n.com**
Last Registration Time **2020-08-13 11:07:23**

3.2.1.3 Events

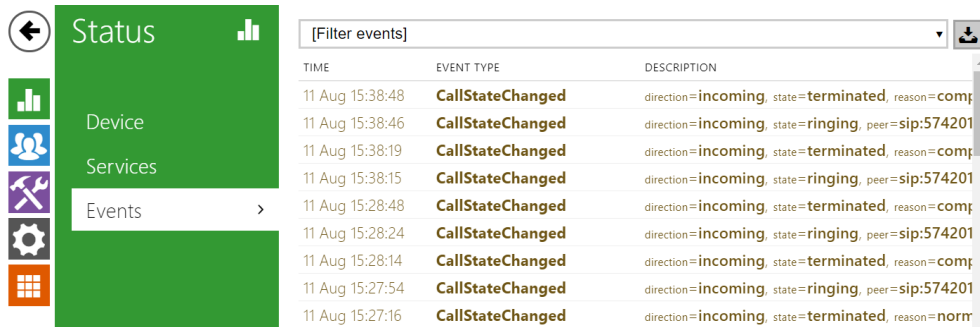

TIME	EVENT TYPE	DESCRIPTION
11 Aug 15:38:48	CallStateChanged	direction=incoming, state=terminated, reason=comp
11 Aug 15:38:46	CallStateChanged	direction=incoming, state=ringing, peer=sip:574201
11 Aug 15:38:19	CallStateChanged	direction=incoming, state=terminated, reason=comp
11 Aug 15:38:15	CallStateChanged	direction=incoming, state=ringing, peer=sip:574201
11 Aug 15:28:48	CallStateChanged	direction=incoming, state=terminated, reason=comp
11 Aug 15:28:24	CallStateChanged	direction=incoming, state=ringing, peer=sip:574201
11 Aug 15:28:14	CallStateChanged	direction=incoming, state=terminated, reason=comp
11 Aug 15:27:54	CallStateChanged	direction=incoming, state=ringing, peer=sip:574201
11 Aug 15:27:16	CallStateChanged	direction=incoming, state=terminated, reason=norm

Events

The tab displays the last 500 events captured by the device. Every event includes the capturing time and date, event type and detailed description. The events can be filtered by type in a dropdown menu above the event log.

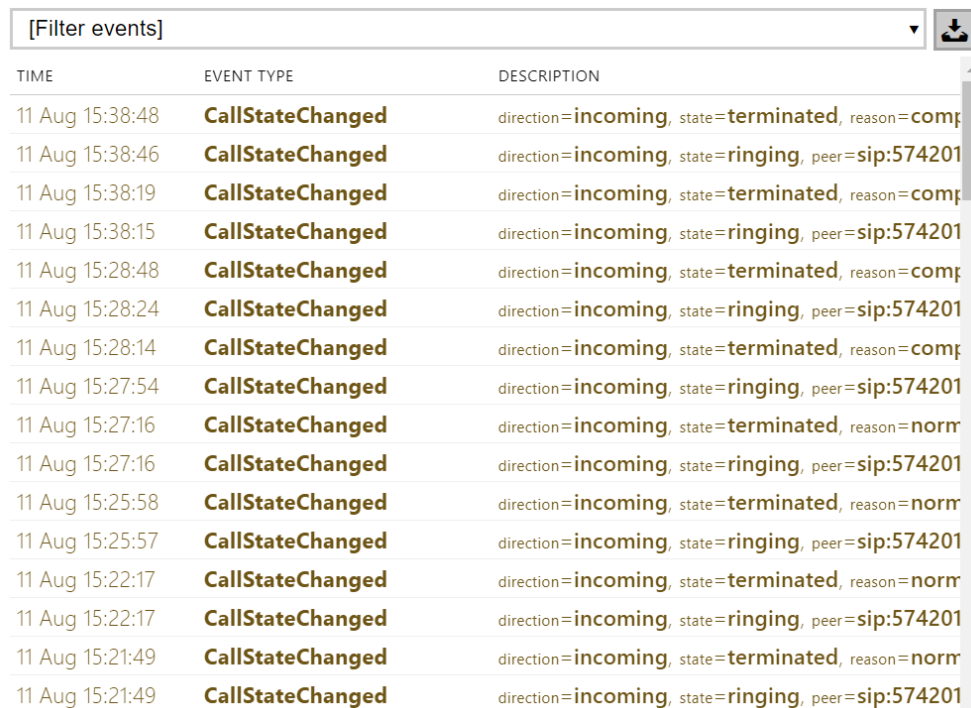

TIME	EVENT TYPE	DESCRIPTION
11 Aug 15:38:48	CallStateChanged	direction=incoming, state=terminated, reason=comp
11 Aug 15:38:46	CallStateChanged	direction=incoming, state=ringing, peer=sip:574201
11 Aug 15:38:19	CallStateChanged	direction=incoming, state=terminated, reason=comp
11 Aug 15:38:15	CallStateChanged	direction=incoming, state=ringing, peer=sip:574201
11 Aug 15:28:48	CallStateChanged	direction=incoming, state=terminated, reason=comp
11 Aug 15:28:24	CallStateChanged	direction=incoming, state=ringing, peer=sip:574201
11 Aug 15:28:14	CallStateChanged	direction=incoming, state=terminated, reason=comp
11 Aug 15:27:54	CallStateChanged	direction=incoming, state=ringing, peer=sip:574201
11 Aug 15:27:16	CallStateChanged	direction=incoming, state=terminated, reason=norm
11 Aug 15:27:16	CallStateChanged	direction=incoming, state=ringing, peer=sip:574201
11 Aug 15:25:58	CallStateChanged	direction=incoming, state=terminated, reason=norm
11 Aug 15:25:57	CallStateChanged	direction=incoming, state=ringing, peer=sip:574201
11 Aug 15:22:17	CallStateChanged	direction=incoming, state=terminated, reason=norm
11 Aug 15:22:17	CallStateChanged	direction=incoming, state=ringing, peer=sip:574201
11 Aug 15:21:49	CallStateChanged	direction=incoming, state=terminated, reason=norm
11 Aug 15:21:49	CallStateChanged	direction=incoming, state=ringing, peer=sip:574201

3.2.2 Directory

Directory

Search

<input type="checkbox"/>	Type	Name	Phone Number	Features
<input type="checkbox"/>		2N Indoor Compact	device:2NIndoorCompact-...	
<input type="checkbox"/>		2N Indoor Touch 2.0	device:2NIndoorTouch-522...	
<input type="checkbox"/>		2N® IP Verso	sip:10.0.24.45	

15 1 - 3 of 3

Directory is one of the crucial parts of the device configuration. It helps add new devices (2N IP intercoms and other answering units) and provides essential information on them. Up to 200 devices can be added to the directory.

The Search function works as a fulltext search in names and phone numbers. It searches for all matches in the whole directory. The icon helps find registered devices and add them to the Directory list if necessary. The icon helps create a new device and the icon displays the user settings details. The icon helps remove a device from the list deleting all its data. You can arrange the list according to the name or feature (indicates that the device may be displayed, indicates that incoming calls are allowed to the device, indicates the feature of the device to which the call started with a short call button press is created and indicates the feature of the device to which the alarm call started with a the doorbell button press is created). One list page can include 15, 25 or 50 devices.

Directory

Search

<input type="checkbox"/>	Type	Name	Phone Number	Features
<input type="checkbox"/>		2N Indoor Compact	device:2NIndoorCompact-...	
<input type="checkbox"/>		2N Indoor Touch 2.0	device:2NIndoorTouch-522...	
<input type="checkbox"/>		2N® IP Verso	sip:10.0.24.45	

15 1 - 3 of 3 1

Each device list item includes the following data:

Basic Settings ▾

Device Name

Displayed Icon ▾

Device Type ▾

Phone Number

Enable Camera Switching

Face Tracking Button

- **Device Name** – enter the device name for the selected Phone Book position. This parameter is optional and helps you find items in the Phone Book more easily.
- **Displayed Icon** – display the reception desk symbol or a standard symbol.
- **Device Type** – set this parameter manually or automatically using the search for registered devices in the directory.
- **Phone number** – enter the phone number of the station to which the call shall be routed. Enter sip:[user_id@]domain[:port] for Direct SIP calling, e.g.: sip:200@192.168.22.15 or sip:name@yourcompany. Enter device:device_name for calls to the 2N[®] IP Mobile application. Set the device name in the mobile application. Enter /1 or /2 behind the phone number to specify which SIP account shall be used for outgoing calls (account 1 or 2). Enter /S or /N to force an encrypted or unencrypted call respectively. The account and encryption selections can be combined into the suffix /1S, for example.
- **Enable Camera Switching** – set whether or not an external camera is available at the contact terminal equipment (accordingly, the internal/external camera button is/is not displayed during calls and call previews). With some 2N[®] terminal equipment in the LAN, the information sent by the 2N[®] terminal equipment is preferred to this setting (i.e. this setting is not needed for contacts using 2N[®] terminals or camera-less devices).
- **Face Tracking Button** – set whether or not the contact's terminal device is able to monitor faces during video calls (accordingly, the face monitoring button is/is not displayed during calls and call previews). With some 2N[®] terminal equipment in the LAN, the information sent by the 2N[®] terminal equipment is preferred to this setting (i.e. this setting is not needed for contacts using 2N[®] terminals or camera-less devices).

Display ▾

Display Device

Display on top

Alternative name

- **Display Device** - display this device. The user can select and call for any device displayed.
- **Display on Top** - display the device on the top.
- **Alternative Name** - display an alternative name instead of the device name. If no alternative name has been entered, this is shown on the display.

 **Caution**

- The <, > and / characters are not permitted for the parameters Device name and Alternative name.

Alarm call ▾

Start call with a doorbell button press

- **Start call with a doorbell button press** - a phone call to this device will be set up after the alarm call button is pressed. Set the doorbell alarm call function in HW / Digital inputs / Doorbell button.

Unlock Button Function ▾

BUTTON	NAME	UNLOCK CODE
1	<input type="text"/>	<input type="text"/>
2	<input type="text"/>	<input type="text"/>
3	<input type="text"/>	<input type="text"/>
4	<input type="text"/>	<input type="text"/>

- **Code 1, 2, 3, 4** - enter the code assigned to unlock button #1, #2, #3, #4. It is used for remote unlocking of the entrance door, for example. Make sure that the code includes at least two door unlocking characters via the intercom keypad and at least one door unlocking DTMF character via a phone. Four characters at least are recommended.

3.2.3 Services

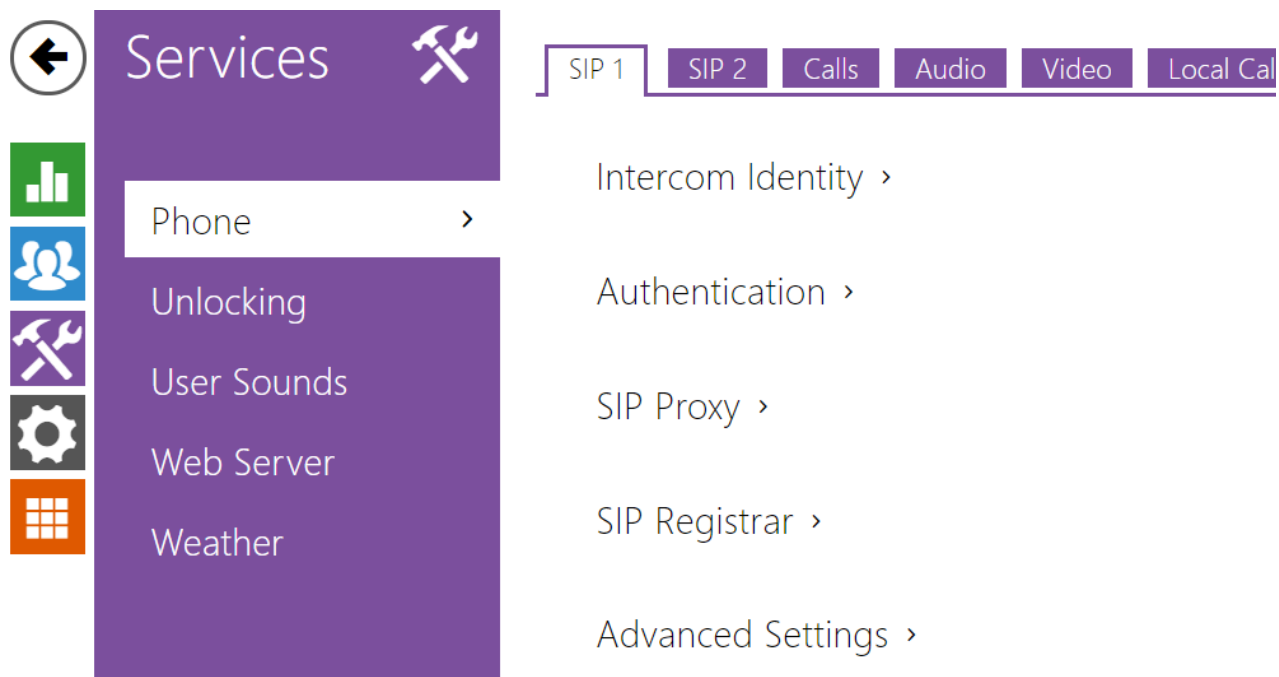

Here is what you can find in this section:

- 3.2.3.1. Phone
- 3.2.3.2 Unlocking
- 3.2.3.3 User Sounds
- 3.2.3.4 Web Server
- 3.2.3.5 Weather

3.2.3.1. Phone

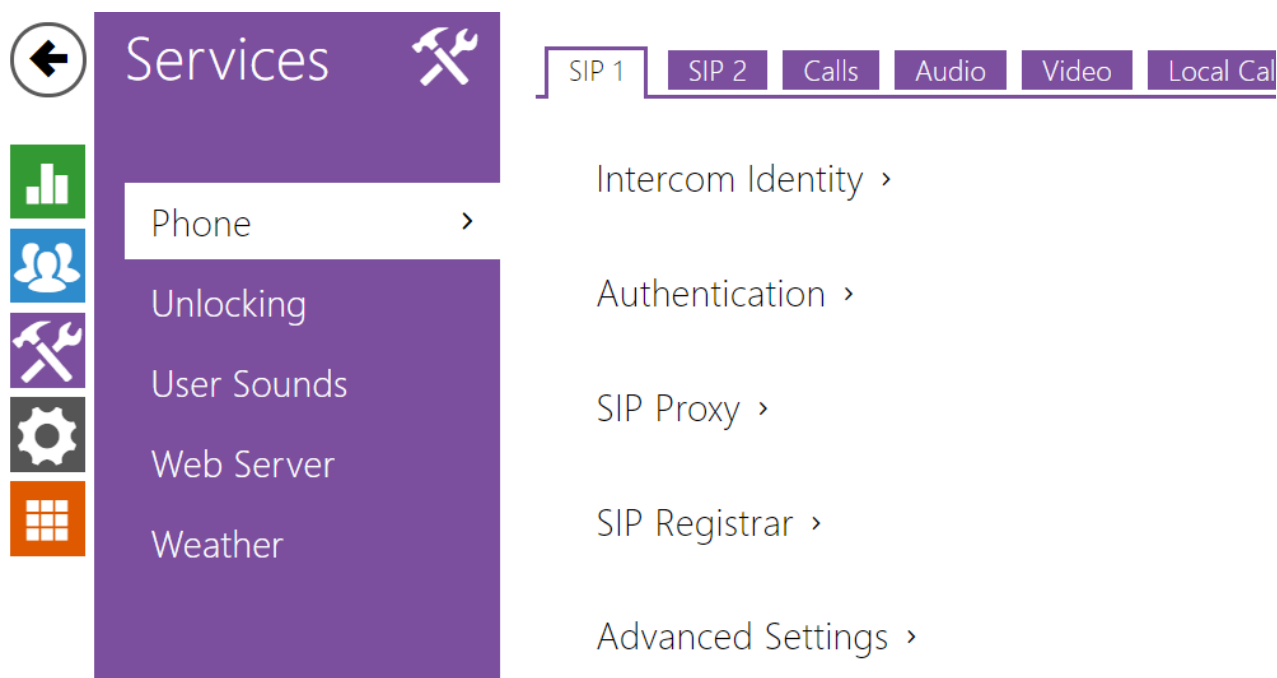

Phone is an essential function of 2N[®] **Indoor View** allowing you to establish connections to other IP network terminals. 2N[®] **Indoor View** supports the extended SIP.

List of Parameters

2N[®] **Indoor View** Phone includes the following four tabs:

- **SIP 1**- complete SIP account settings.
- **SIP 2**- complete SIP account settings.
- **Calls** - incoming and outgoing call settings.
- **Audio** - audio codec, DTMF and other audio stream parameter transmission settings.
- **Video** - video codec and SDP codec settings.
- **2N Indoor Units** - general parameters and count of identified LAN devices.

SIP 1 and SIP 2

2N[®] **Indoor View** helps you configure one SIP account.

Intercom Identity ▾

Display Name

Phone Number (ID)

Domain

- **Display Name** - set the name to be displayed as CLIP on the called party's phone.
- **Phone Number (ID)** - set your device phone number (or another unique ID composed of characters and digits). Together with the domain, this number uniquely identifies the device in calls and registration.
- **Domain** - set the domain name of the service with which the device is registered. Typically, it is equivalent to the SIP Proxy or Registrar address.
- **Test Call** - display a dialogue window enabling you to make a test call to a selected phone number, see below.

Authentication ▾

Use Authentication ID

Authentication ID

Password

- **Use Authentication ID** - select the use of an alternative ID for device authentication. Otherwise, the Phone number value from the previous section is used for authentication.
- **Authentication ID** - set the alternative user ID for device authentication.
- **Password** - set the device authentication password. If your PBX requires no authentication, the parameter will not be applied.

SIP Proxy ▾

Proxy Address

Proxy Port

Backup Proxy Address

Backup Proxy Port

- **Proxy Address** - set the SIP Proxy IP address or domain name.
- **Proxy Port** - set the SIP Proxy port (typically 5060).

- **Backup Proxy Address** – set the backup SIP Proxy IP address or domain name. The address is used where the main proxy fails to respond to requests.
- **Backup Proxy Port** – set the backup SIP Proxy port (typically 5060).

SIP Registrar ▾

Registration Enabled

Registrar Address

Registrar Port

Backup Registrar Address

Backup Registrar Port

Registration Expiry [s]

Registration State **NOT REGISTERED**

Failure Reason -

- **Registration Enabled** – enable device registration with the set SIP Registrar.
- **Registrar address** – set the SIP Registrar IP address or domain name.
- **Registrar Port** – set the SIP Registrar port (typically 5060).
- **Backup Registrar Address** – set the backup SIP Registrar IP address or domain name. The address is used where the main registrar fails to respond to requests.
- **Backup Registrar Port** – set the backup SIP registrar port (typically 5060).
- **Registration Expires** – set the registration expiry, which affects the network and SIP Registrar load by periodically sent registration requests. The SIP Registrar can alter the value without letting you know.
- **Registration State** – display the current registration state (Unregistered, Registering..., Registered, Unregistering...).
- **Failure Reason** – display the reason for the last registration attempt failure: the registrar's last error reply, e.g. 404 Not Found.

Advanced Settings ▾

SIP Transport Protocol	UDP ▾
Local SIP Port	5060
PRACK Enabled	<input type="checkbox"/>
REFER Enabled	<input type="checkbox"/>
Send KeepAlive Packets	<input type="checkbox"/>
IP Address Filter Enabled	<input type="checkbox"/>
Receive encrypted calls only (SRTP)	<input type="checkbox"/>
Encrypted outgoing calls (SRTP)	<input type="checkbox"/>
Do Not Play Incoming Early Media	<input type="checkbox"/>
QoS DSCP Value	0
External IP Address	
Starting RTP Port	4900
RTP Timeout	60
Compatibility with Broadsoft devices	<input type="checkbox"/>
Rotate SRV records	<input type="checkbox"/>

- **SIP Transport Protocol** – set the SIP communication protocol: UDP (default), TCP or TLS.
- **Local SIP Port** – set the local port for the device for SIP signaling. A change of this parameter will not be applied until the device is restarted. The default value is 5060.
- **PRACK Enabled** – enable the PRACK method for reliable confirmation of SIP messages with codes 101-199.
- **REFER Enabled** – enable call forwarding via the REFER method.
- **Send Keep Alive Packets** – set that the device shall inquire periodically about the state of the called station via SIP OPTIONS requests during the call (used for station failure detection during the call).
- **IP Address Filter Enabled** – enable the blocking of SIP packet receiving from addresses other than SIP Proxy and SIP Registrar. The primary purpose of the function is to enhance communication security and eliminate unauthorized phone calls.
- **Receive Encrypted Calls Only (SRTP)** – set that SRTP encrypted calls shall only be received on this account. Unencrypted calls will be rejected. At the same time, TLS is recommended as the SIP transport protocol for higher security.
- **Encrypted Outgoing Calls (SRTP)** – set that outgoing calls shall be SRTP encrypted on this account. At the same time, TLS is recommended as the SIP transport protocol for higher security.

- **Do Not Play Incoming Early Media** – disable playing of the incoming audio stream before the call sent by some PBXs or other devices is picked up (early media). A standard local ringtone is played instead.
- **QoS DSCP Value** – set the SIP packet priority in the network. The set value is sent in the TOS (Type of Service) field in the IP packet header. Enter the value as a decimal number. A change of this parameter will not be applied until the device is restarted.
- **External IP Address** – set the public IP address or router name to which the device is connected. If the device IP address is public, leave this parameter empty.
- **Starting RTP Port** – set the initial local RTP port in the range of 64 ports used for audio and video transmission. The default value is 4900 (i.e. the range is 4900–4963). The parameter is only set for account 1 but applies to both the SIP accounts.
- **RTP Timeout** – set the audio stream RTP packet receiving timeout during a call. If this limit is exceeded (RTP packets are not delivered), the call will be terminated by the device. Enter 0 to disable this parameter. The parameter is only set for account 1 but applies to both the SIP accounts.
- **Broadsoft Compatibility Mode** – set the Broadsoft PBX compatibility mode. Having received re-invite from a PBX in this mode, the intercom replies by repeating the last sent SDP with currently used codecs instead of sending a complete offer.
- **Rotate SRV records** – allow SRV record rotation for SIP Proxy and Registrar. This is an alternative method of transition to backup servers in the event of main server failure or unavailability.

Calls

General Settings ▾

Call Time Limit [s]

- **General Settings** – set the call time limit after which the call is automatically terminated. The intercom signals termination with a beep 10 s before the call end. Enter any DTMF character into the call (# on your IP phone, e.g.) to extend the call time.

Incoming Calls ▾

Call Answering Mode (SIP1) ▾

Call Answering Mode (SIP2) ▾

Local Call Receiving Mode ▾

Pick up in [s]

- **Call Receiving Mode (SIP 1, SIP 2)** – set the way of receiving incoming calls. The following three options are available:
 - **Always busy** – the device rejects incoming calls.
 - **Manual answering** – the device rings to signal incoming calls and the user can press a keypad button to pick up.
 - **Automatic** – the device picks up incoming calls automatically. You can set the call receiving mode for each SIP account separately.
- **Local Call Receiving Mode** – set the way of receiving incoming local calls.
 - **Always busy** – the device rejects incoming calls.
 - **Manual answering** – the device rings to signal incoming calls and the user can press a keypad button to pick up.
 - **Automatic** – the device picks up incoming calls automatically. You can set the call receiving mode for each SIP account separately.
- **Pick up in** – this parameter is only active when the Automatic pickup mode is enabled. The call is picked up automatically after the preset timeout.

Outgoing Calls ▾

Ring Time Limit [s]

- **Ring time limit** – set the maximum call setup and ringing time in which all outgoing calls are automatically terminated. If the calls are routed to the GSM network via GSM gateways, you are advised to set a value longer than 20 s. Minimum value: 1 s, maximum value: 600 s. Set 0 to disable the time parameter.

Call List ▾

Save image from call

- **Save image from call** – select this to save an image from every video call into the call list.

Audio

Audio Codecs ▾

CODEC	ENABLED	PRIORITY
PCMU	<input checked="" type="checkbox"/>	2 ▾
PCMA	<input checked="" type="checkbox"/>	1 (highest) ▾
L16 / 16 kHz	<input type="checkbox"/>	4 ▾
G.729	<input checked="" type="checkbox"/>	3 ▾
G.722	<input checked="" type="checkbox"/>	1 (highest) ▾

- Enable/disable the use of audio codecs for call setups and set their priorities.

DTMF Sending ▾

In-Band (Audio)

RTP (RFC-2833)

SIP INFO (RFC-2976)

The tab below helps you define how DTMF characters shall be sent from the intercom. Check the opponent's DTMF receiving options and settings to make the function work properly.

- **In-Band (Audio)** - enable the classic method of sending DTMF in the audio band using standardized dual tones.
- **RTP (RFC-2833)** - enable DTMF sending via the RTP according to RFC-2833.
- **SIP INFO (RFC-2976)** - enable DTMF sending via SIP INFO messages according to RFC-2976.

DTMF Receiving ▾

In-Band (Audio)

RTP (RFC-2833)

SIP INFO (RFC-2976)

The tab below helps you define how DTMF characters shall be received from the intercom. Check the opponent's DTMF receiving options and settings to make the function work properly.

- **In-Band (Audio)** – enable classic DTMF dual tone receiving in the audio band.
- **RTP (RFC-2833)** – enable DTMF receiving via RTP according to RFC-2833.
- **SIP INFO (RFC-2976)** – enable DTMF receiving via SIP INFO messages according to RFC-2976.

Transmission Quality Settings ▾

QoS DSCP Value

Jitter Compensation

- **QoS DSCP Value** – set the audio RTP packet priority in the network. The set value is sent in the TOS (Type of Service) field in the IP packet header.
- **Jitter Compensation** – set the buffer length for compensation of interval unevenness in audio packet arrivals. A higher capacity improves the transmission resistance at the cost of a greater sound delay.

Video

Video Codecs ▾

CODEC	ENABLED	PRIORITY
H.264	<input checked="" type="checkbox"/>	1 (highest) ▾

- Enable/disable the use of video codecs for call setups and set their priorities.

Advanced SDP Settings ▾

H.264 Payload Type (1)

H.264 Payload Type (2)

- **H.264 Payload Type (1), (2)** – set the video codec H.264 payload type (packetization mode 1). Set a value from the range of 96 through 127, or 0 to disable this codec type.

Local Calls

Enable Local Calls

- **Enable Local Calls** - enable calls between 2N devices in the LAN. With this function off, the other LAN devices cannot locate this device, i.e. cannot call the device in the device:device_ID format.

Network Identification ▾

Device ID

- **Device ID** - set the device ID to be displayed in the LAN device list in all the 2N devices in one and the same LAN. You can direct a call to this device by setting the user phone number as device:device_ID in these devices.

Connection to Intercoms ▾

Access Key 1

Access Key 2

- **Access Key 1, 2** - set the access key shared by the 2N answering units and intercoms. If the keys in the 2N answering units and the intercoms fail to match, the devices cannot communicate, i.e. the intercom cannot call the 2N answering unit and vice versa.

Connection to answering units ▾

Access Key

Multicast Address

- **Access Key** - set the access key shared by the 2N answering units and intercoms. If the keys in the 2N answering units and the intercoms fail to match, the devices cannot communicate, i.e. the intercom cannot call the 2N answering unit and vice versa.
- **Multicast Address** - set the network multicast address to which the answering unit message shall be sent.

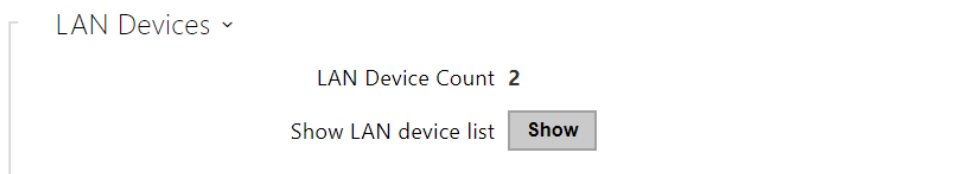

- **LAN Device count** – display the number of local devices in the network.
- **Show LAN devices list** – display a detailed list of local devices in the network.

3.2.3.2 Unlocking

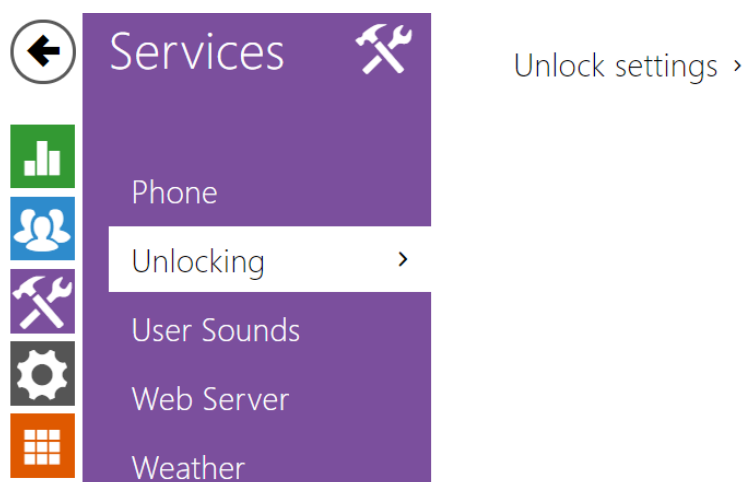

Unlocking is another function of **2N[®] Indoor View**, which sets the remote door unlocking parameters.

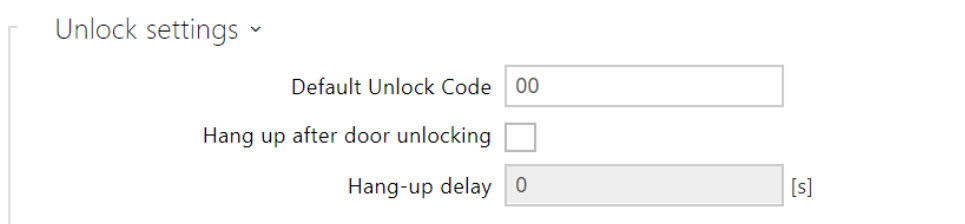

- **Default Unlock Code** – use this code when a call has been set up with a device /phone number that is not added to the unit phone book.
- **Hang Up After Door Unlocking** – end the call when the door unlocking request has been sent successfully.
- **Hang-Up Timeout** – end the call when the door unlocking request sending timeout has elapsed.

3.2.3.3 User Sounds

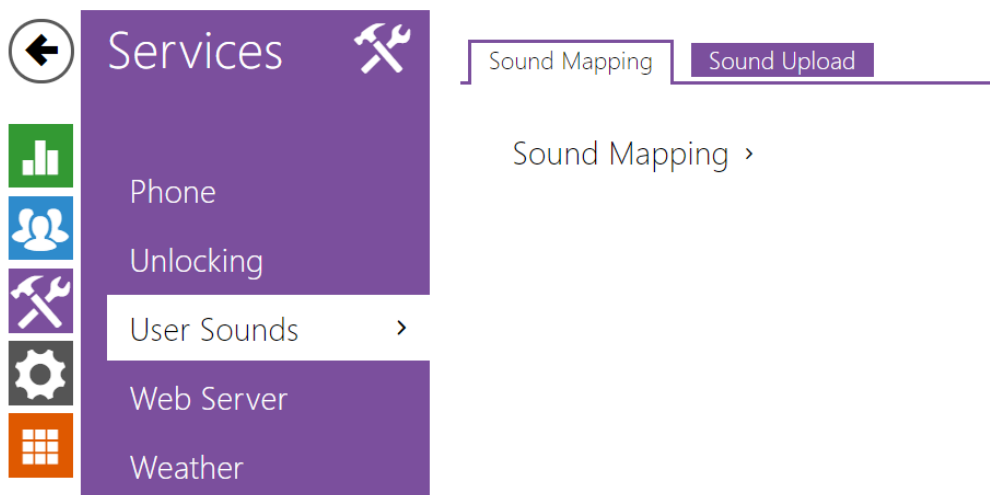

2N[®] Indoor View signals variable operational statuses with a sequence of tones. If the standard signaling tones do not meet your requirements, you can modify them.

The device allows you to modify sound signaling for the following states:

1.
 - a. Ringtone before call pickup
 - b. Ringing tone
 - c. Busy tone
 - d. Call end signaling
 - e. Doorbell

Sound Mapping

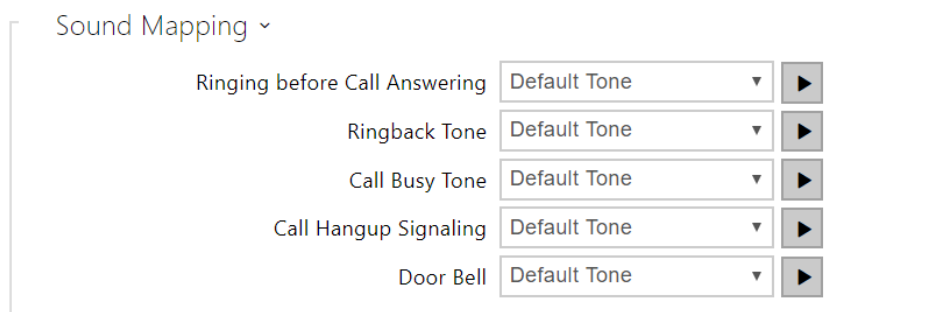

- **Ringing before Call Pickup** – set the ringtone to be played before an incoming call is picked up (device ringtone).

- **Ringback Tone** - set the sound to be played when the called user is ringing. The PBX ringtone is preferred to the user ringtone in the device.
- **Call Busy Tone** - set the tone to be played when the called user is busy.
- **Call Hang-Up Signaling** - set the tone to signal the call end.
- **Doorbell** - set the tone to be played when the doorbell is used.

Sound Upload

Sound Upload ▾

	NAME	SIZE				
1	<input type="text" value="User sound 1"/>	N/A				
2	<input type="text" value="User sound 2"/>	N/A				
3	<input type="text" value="User sound 3"/>	N/A				
4	<input type="text" value="User sound 4"/>	N/A				
5	<input type="text" value="User sound 5"/>	N/A				
6	<input type="text" value="User sound 6"/>	N/A				
7	<input type="text" value="User sound 7"/>	N/A				
8	<input type="text" value="User sound 8"/>	N/A				
9	<input type="text" value="User sound 9"/>	N/A				
10	<input type="text" value="User sound 10"/>	N/A				

You can upload up to 10 user sound files to the device and name each of them for better orientation.

Press to upload a sound file to the device. Select a file from your PC and click **Upload**. Press to remove a file. Click to play a successfully uploaded sound file (locally on your PC). Press to record a sound file via your PC microphone.

3.2.3.4 Web Server

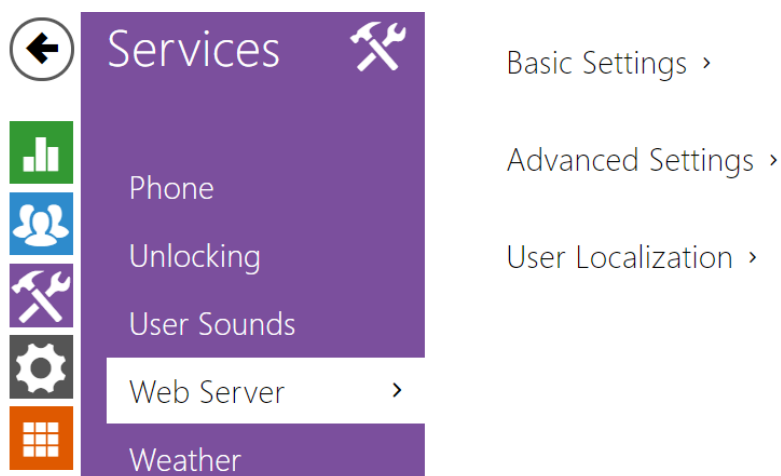

2N[®] Indoor View can be configured using a common browser that approaches the web server integrated in the device. The HTTPS protocol is used for the browser - device communication. Enter the login user name and password first. The default values are **admin** and **2n** respectively. We recommend to you change the default password as soon as possible.

List of Parameters

Basic Settings ▾

Device Name	<input type="text" value="2N Indoor View"/>
Web Interface Language	<input type="text" value="English"/> ▾
Password	<input type="password" value="....."/> 

- **Device Name** - set the device name to be displayed in the right-hand upper corner of the web interface, in the login window and in other applications if necessary (Network Scanner, etc.)
- **Web Interface Language** - set the default language after the administration web server login. Use the upper toolbar buttons to change the web interface language temporarily any time.
- **Password** - set the device login password. Click  to edit the password. Make sure that the password contains 8 characters at least, including one small alphabet letter, one capital alphabet letter and one digit.

Advanced Settings ▾

HTTP Port	<input type="text" value="80"/>
HTTPS Port	<input type="text" value="443"/>
Lowest Allowed TLS Version	<input type="text" value="TLS 1.0"/> ▾
HTTPS User Certificate	<input type="text" value="Self Signed"/> ▾
Remote Access Enabled	<input checked="" type="checkbox"/>

- **HTTP Port** – set the web server port for HTTP communication. The port change will not be applied until the device is restarted.
- **HTTPS Port** – set the web server port for HTTPS communication. The port change will not be applied until the device is restarted.
- **Minimum Allowed TLS Version** – set the lowest TLS version to be accepted for device connection.
- **HTTPS User Certificate** – set the user certificate and private key for communication encryption between the device HTTP server and the user web browser. Choose one of the three sets of user certificates and private keys (refer to the Certificates subs.) or keep the **Self Signed** setting, in which the certificate automatically generated upon the first intercom power up is used.
- **Remote Access Enabled** – enable remote access to the device web server from off-LAN IP addresses.

User Localization ▾

FILE	SIZE	
Original Language	218 kB	
Custom Language	N/A	  

- **Original Language** – download an original file from the device including all user interface texts in English. The file format is XML; see below.
- **User Language** – upload, download and/or remove user files including translations of the user interface texts.

3.2.3.5 Weather

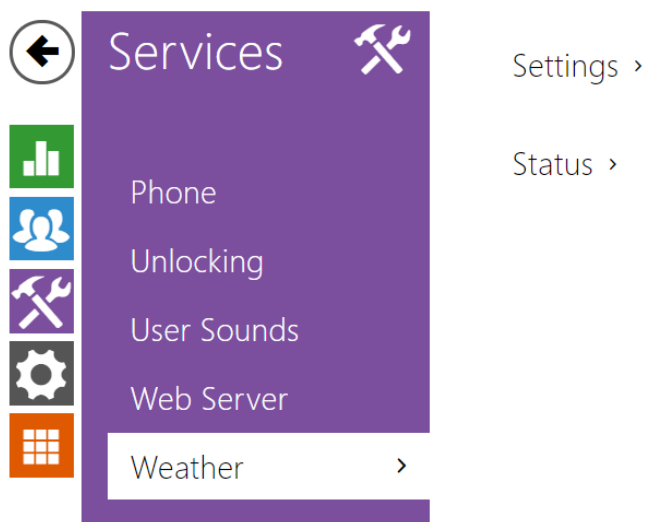

The **Weather** service offers display of information about the current weather for the selected location on the **2N[®] Indoor View** home screen.

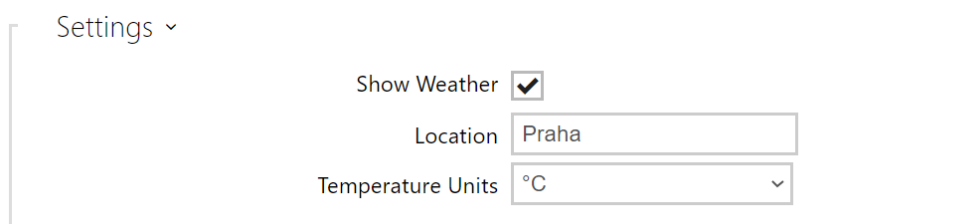

- **Show Weather** – display information about the current weather on the device.
- **Location** – set the device location for weather forecast. If Show Weather is enabled and the Location parameter is empty, Prague will be displayed by default. Otherwise, the weather and Location values will be hidden.
- **Temperature Units** – select the temperature units to be displayed.

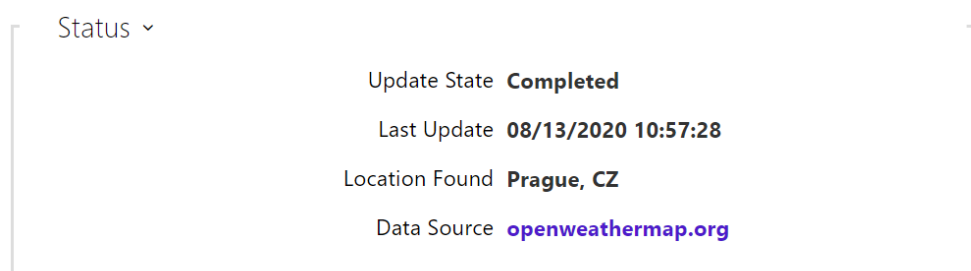

- **Update Status** - display the update status of the Open Weather server data.
- **Last Update** - precise date of the last OpenWeather server data update.
- **Location Found** - weather forecast location found by the OpenWeather server.
- **Data Source** - display the source of the data giving information about the weather.

3.2.4 Hardware

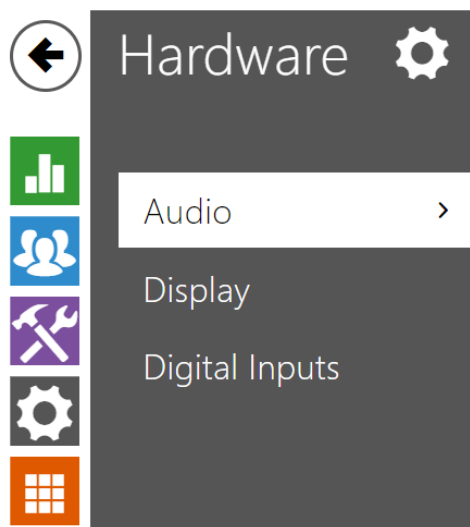

Phone Call Volume >

Signaling Volume >

Do Not Disturb Mode >

Here is what you can find in this section:

- 3.2.4.1 Audio
- 3.2.4.2 Display
- 3.2.4.3 Digital Inputs

3.2.4.1 Audio

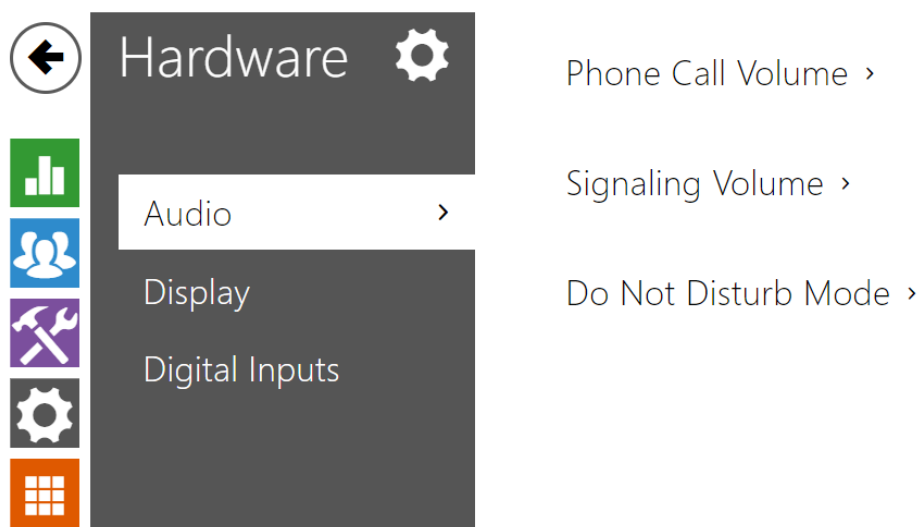

2N[®] Indoor View is equipped with a speaker. Set the phone call and state signaling volume control in this configuration section. **Master Volume** controls the general device volume including call volume, signaling tone volume, and so on. Consider the noise level of the ambient environment while setting this parameter.

List of Parameters

Phone Call Volume ▾

Call Volume	0 dB ▾
Ringtone Volume	-4 dB ▾
Call-Progress Tone Volume	-8 dB ▾

- **Call Volume** - set the phone call volume.
- **Ringtone Volume** - set the incoming call ringtone volume.
- **Call Progress Tone Volume** - set the dialtone, ringtone and busy tone volume levels. In case the call progress tones are automatically generated by the PBX, this setting will not be applied.

Signaling Volume ▾

Warning Tone Volume ▾

Suppress Warning Tones

User Sounds Volume ▾

- **Warning Tone Volume** - set the volume of warning and signaling tones. The volume values are relative against the set master volume.
- **Suppress Warning Tones** - suppress signaling of the following operational states: Internal application started, IP address received and IP address lost.
- **User Sound Volume** - set the volume of the user sounds. The volume values are relative against the set master volume.

Do Not Disturb Mode ▾

DND mode for doorbell button

- **Do not disturb mode for doorbell too** - if this function is activated, the device will not ring when the doorbell is pressed.

3.2.4.2 Display

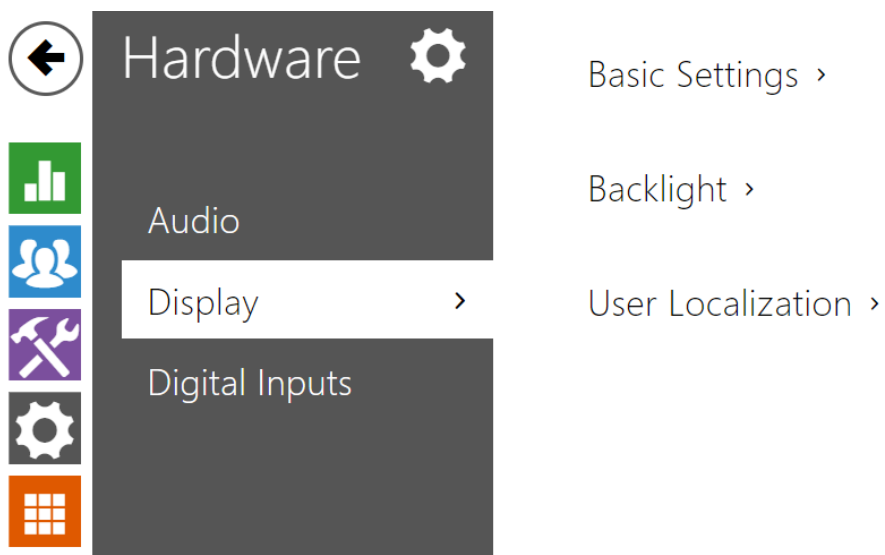

Set the basic display parameters on this tab.

Basic Settings ▾

Language English ▾

Date Format 31/12/2018 ▾

Time Format 22:30 ▾

Enable Screen Lock

Screen Lock PIN

Display Setting Menu

Display Time in Idle Mode

- **Language** – set the language for the texts to be displayed. Choose one of the seven pre-defined languages (CZ, EN, DE, FR, ES, IT, RU).
- **Date Format** – set the date format to be displayed.
- **Time Format** – set the time format to be displayed.
- **Screen Lock Enabled** – activate the screen lock function.
- **Screen Lock PIN** – set the screen lock activation/deactivation code.
- **Display Setting Menu** – display the Setting menu.
- **Display Time in Idle Mode** – switch off the device display and all backlight in the idle mode.

Backlight ▾

Intensity in Active Mode 100 % ▾

Decrease Intensity in Idle Mode to 1/3 ▾

Go to Idle Mode in 10 min ▾

- **Display Backlight Intensity** – set the backlight brightness level. Set the value as a percentage of the maximum possible LED brightness.
- **Reduction of intensity in idle mode to** – sets the level of reduction of the intensity of backlighting if the device goes into Idle Mode.
- **Go to Idle Mode in** – set the inactivity timeout after which the device switches to the idle mode.

User Localization ▾

FILE

Original Language 

- **Original language** - download a preset XML file with all the texts to be displayed. It is an XML file with all the texts to be displayed.

i Note

If none of the pre-defined languages is convenient for you, proceed as follows:

- Download the original language file (English).
- Modify the file using a text editor (replace the English texts with your own ones).
- Upload the modified localization file back to the intercom.
- Set **Language Settings | Language** to **Custom**.
- Check and correct if necessary the texts on the intercom display.

3.2.4.3 Digital Inputs

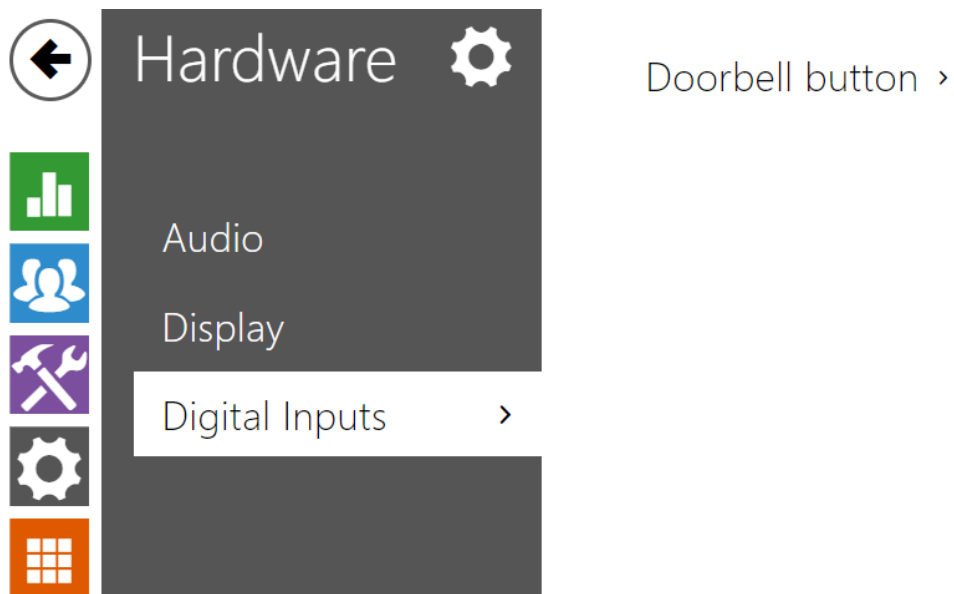

This subsection describes the digital input options of the device.

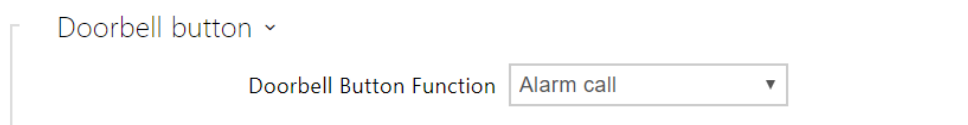

- **Doorbell Button Function** – select doorbell function (doorbell, alarm call). The button is used either as a classical doorbell or for alarm call activation.

3.2.5 System

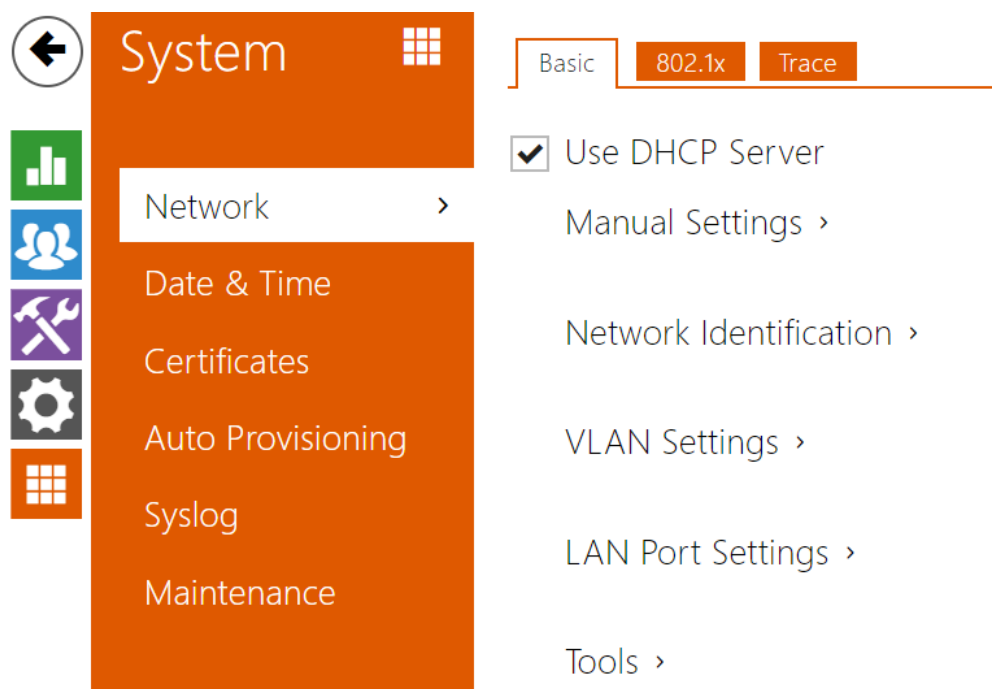

Here is what you can find in this section:

- 3.2.5.1 Network
- 3.2.5.2 Date and Time
- 3.2.5.3 Certificates
- 3.2.5.4 Auto Provisioning
- 3.2.5.5 Syslog
- 3.2.5.6 Maintenance

3.2.5.1 Network

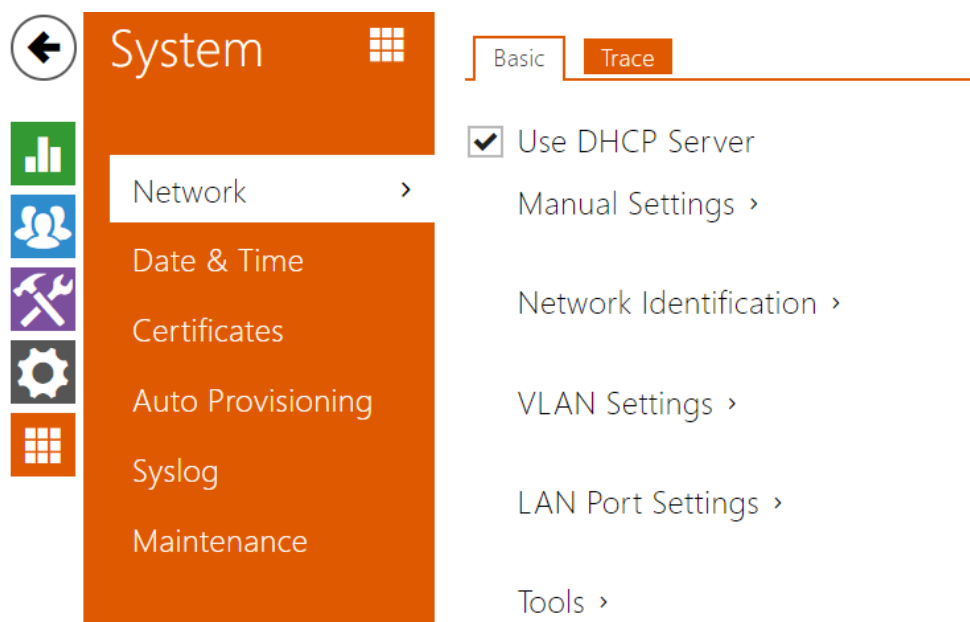

2N[®] Indoor View is connected to the LAN and has to be assigned a valid IP address or obtain the IP address from the LAN DHCP server. The Network section helps you configure the IP address and DHCP.

Tip

- *If you want to ascertain the current IP address of your 2N[®] Indoor View, you can use the 2N[®] Network Scanner application which can be freely downloaded from www.2n.cz and use the mechanism described in chapter 2.4 Searching for the 2N[®] Indoor View device in the network with the aid of 2N[®] Network Scanner.*

List of Parameters

Basic

Use DHCP Server Use DHCP Server

- **Use DHCP server** – enable automatic obtaining of the IP address from the LAN DHCP server. If the DHCP server is unavailable or otherwise inaccessible in your LAN, use the manual network settings.

Manual Settings ▾

Static IP Address	<input type="text" value="192.168.1.100"/>
Network Mask	<input type="text" value="255.255.255.0"/>
Default Gateway	<input type="text" value="192.168.1.1"/>
Primary DNS	<input type="text"/>
Secondary DNS	<input type="text"/>

- **Static IP Address** – static IP address of the device. The address is used together with the parameters below unless Use DHCP server is enabled.
- **Network Mask** – network mask setting.
- **Default Gateway** – default gateway address for off-LAN communication.
- **Primary DNS** – primary DNS address for domain name-to-IP address translation.
- **Secondary DNS** – secondary DNS address where the primary DNS is unavailable.

Network Identification ▾

Hostname	<input type="text" value="2NIndoorView-5226560067"/>
Vendor Class Identifier	<input type="text"/>

- **Hostname** – set the device LAN identification.
- **Vendor Class Identifier** – set the manufacturer identifier as a character string for DHCP Option 60.

VLAN Settings ▾

VLAN Enabled	<input type="checkbox"/>
VLAN ID	<input type="text" value="1"/>

- **VLAN Enabled** - enable the virtual network support (VLAN according to 802.1q). Remember to set the VLAN ID too.
- **VLAN ID** - choose a VLAN ID from the range of 1-4094. The device shall only receive packets with the set ID. An incorrect setting may result in a connection loss and subsequent factory reset.

LAN Port Settings ▾

Required Port Mode ▾

Current Port State **Full Duplex - 100mbps**

- **Required Port Mode** - set the LAN port mode to be preferred: Automatic or Half Duplex - 10 Mbps. The bit rate is reduced to 10 Mbps in case the available LAN cabling is unreliable for a 100 Mbps traffic.
- **Current Port State** - current LAN port state: Half or Full Duplex - 10 Mbps or 100 Mbps.

Tools ▾

Verify network address accessibility

- **Verify the network address accessibility** - verify the network address accessibility via the Ping command in standard operating systems. Press Ping to display a dialogue for you to enter the IP address/domain name and press Ping to send the test data to the set address. If the IP address/domain name is invalid, a warning is displayed and the Ping button remains inactive until the IP address becomes valid. The dialogue also displays the procedure state and result. Failed means that either the IP address was unavailable within 10 s or it was impossible to translate the domain name into an address. If a valid response is received, the response sending IP address and response waiting time in milliseconds are displayed. Press Ping again to send another query to the same address.

801.1x

Device Identity ▾

Device Identity

- **Device Identity** - username (identity) for authentication via EAP-MD5 and EAP-TLS.

MD5 Authentication ▾

MD5 Authentication Enabled

Password

- **MD5 Authentication Enabled** - enable authentication of network devices via the 802.1x EAP-MD5 protocol. Do not enable this function if your LAN does not support 802.1x. If you do so, the intercom will become inaccessible.
- **Password** - enter the access password for EAP-MD5 authentication.

TLS Authentication ▾

TLS Authentication Enabled

Trusted Certificate

User Certificate

- **TLS Authentication Enabled** - enable authentication of network devices via the 802.1x EAP-TLS protocol. Do not enable this function if your LAN does not support 802.1x. If you do so, the intercom will become inaccessible.
- **Trusted Certificate** - specify the set of trusted certificates for verification of the RADIUS server public certificate validity. Choose one of three sets of certificates; refer to the Certificates subsection. If no trusted certificate is included, the RADIUS public certificate is not verified.
- **User Certificate** - specify the user certificate and private key for verification of the intercom authorisation to communicate via the 802.1x-secured network element port in the LAN. Choose one of three sets of user certificates and private keys; refer to the Certificates subsection.

Note

- *This function is available with the Gold or Enhanced Security license only.*

PEAP MSCHAPv2 authentication ▾



Authentication Allowed

Trusted Certificate

Password

- **Authentication Allowed** – enable authentication of network devices via the 802.1x PEAP MSCHAPv2 protocol. Do not enable this function if your LAN does not support 802.1x. If you do so, the device will become inaccessible.
- **Trusted Certificate** – specify the set of trusted certificates for verification of the RADIUS server public certificate validity. Choose one of three certificate sets, see the Certificates subsection. If no trusted certificate is included, the RADIUS public certificate is not verified.
- **Password** – enter the access password for PEAP-MSCHAPv2 authentication.

Trace

The Trace tab helps you trigger capturing of incoming and outgoing packets via the **2N**® **Indoor View** LAN interface. The captured packets are stored in a 4 MB buffer. When the buffer storage capacity is full, the oldest packets are rewritten automatically. You are recommended to keep the video stream bit rate below 512 kbps while capturing packets. Press  to start capturing,  to stop capturing and  to download the captured packet file.



Packet Capture Status ▾

Current State **RUNNING**

Buffer Size **4 MB**

Buffer Utilization **797 kB**

Number of Captured Packets **2240**

Packet Capture Control   

3.2.5.2 Date and Time

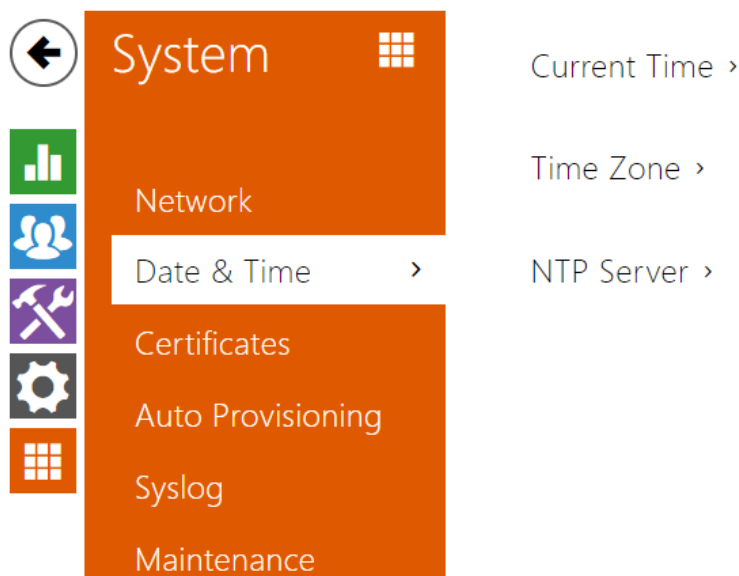

2N[®] **Indoor View** is equipped with a real time clock to back up the device for even a few days in case of power outage. Click **Synchronise** to synchronise your 2N[®] **Indoor View** time with your PC time value any time.

Time in 2N[®] **Indoor View** can be synchronised with any available SNTP server.

Note

- *A correct date/time value is unnecessary for the basic function of 2N[®] **Indoor View** but crucial for a proper function of time profiles and correct event times in variable lists (Syslog, Entered cards, Logs downloaded via HTTP API, etc.).*

In standard operational conditions, the 2N[®] **Indoor View** real time circuit accuracy is $\pm 0.005\%$, which may represent an error of up to ± 2 minutes per month.

List of Parameters

Current Time ▾

Current Device Time **03/21/2019 10:23:59**

Synchronize with browser

Synchronize with browser - click the button to synchronize the device time with your current PC time value.

Time Zone ▾

Time Zone

Time Zone Rule

- **Time Zone** - set the time zone for your installation site. to define time shifts and summer/winter time transitions.
- **Time Zone Rule** - set the time zone rule manually if your device is installed on a site that is not included in the Time Zone list. The Time Zone Rule is applied only if the Time Zone is set to manually define time shifts and summer/winter transitions. The time zone rule is only applied if the Time zone parameter is set to **Manual settings**.

NTP Server ▾

Use NTP Server

NTP Server Address

NTP Time Status **Synchronized**

- **Use NTP Server** - enable the use of the NTP server for internal time Synchronization.
- **NTP Server Address** - set the IP address/domain name of the NTP server used for the device internal time synchronization.
- **NTP Time Status** - display the state of the last local time synchronization attempt via NTP: Unsynchronized, Synchronized, Error.

3.2.5.3 Certificates

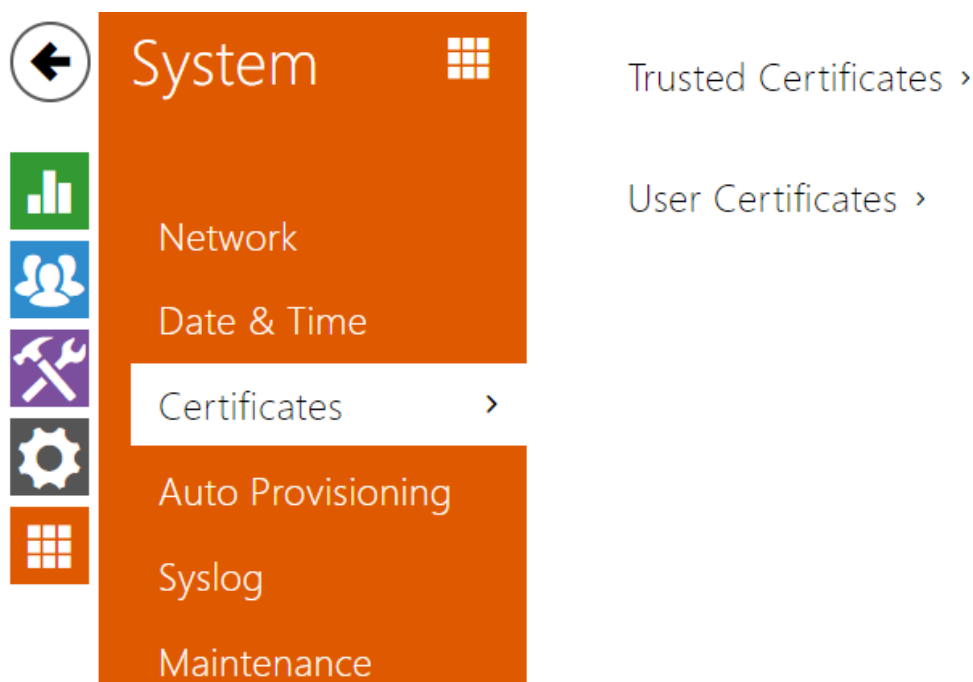

Some 2N[®] Indoor View LAN services use the secure TLS protocol for communication with the other LAN devices. This protocol prevents third parties from eavesdropping on or modifying call contents. TLS is based on one/two-sided authentication, which requires certificates and private keys.

2N[®] Indoor View services that use TLS:

1.
 - a. Web server (HTTPS)
 - b. E-mail (SMTP)
 - c. 802.1x (EAP-TLS)
 - d. SIPs

2N[®] Indoor View allows you to download up to 3 sets of certificates from certification authorities, which help you authenticate the communicating device, and also 3 user certificates and private keys for encryption purposes.

Each certificate requiring service can be assigned one certificate set, refer to the **Web Server**, **E-mail** and **Streaming** subsections. The certificates can be shared by the services.

2N[®] Indoor View accepts the DER (ASN1) and PEM certificates.

Once powered, **2N[®] Indoor View** generates automatically the so-called **Self Signed certificate** and a **private key**, which can be used for the **Web server** and **E-mail** services without the need to load a unique certificate and private key.

Note

- *If you use the Self Signed certificate for encryption, the **2N[®] Indoor View** web server - browser communication is secure, but the browser notifies you that it cannot authenticate the **2N[®] Indoor View** certificate.*



Refer to the tables below for the current list of trusted and user certificates:

Trusted Certificates ▾

	CA IDENTITY	ISSUER	VALID TO		
(1)				x	↕
(2)				x	↕
(3)				x	↕

User Certificates ▾

	CA IDENTITY	ISSUER	EXPIRY TIME		
(1)				x	↕
(2)				x	↕
(3)				x	↕

Click  to upload a certificate saved on your PC. Select the certificate (or private key) file in a dialogue window and click **Upload**. Press  to remove a certificate from 2N[®] Indoor View.

 **Caution**

- Note that a certificate with a private RSA key longer than 2048 bits may be rejected :
The private key file or password has not been accepted by the device!
- For certificates based on elliptic curves use the secp256r1 (aka prime256v1 aka NIST P-256) and secp384r1 (aka NIST P-384) curves only.

3.2.5.4 Auto Provisioning

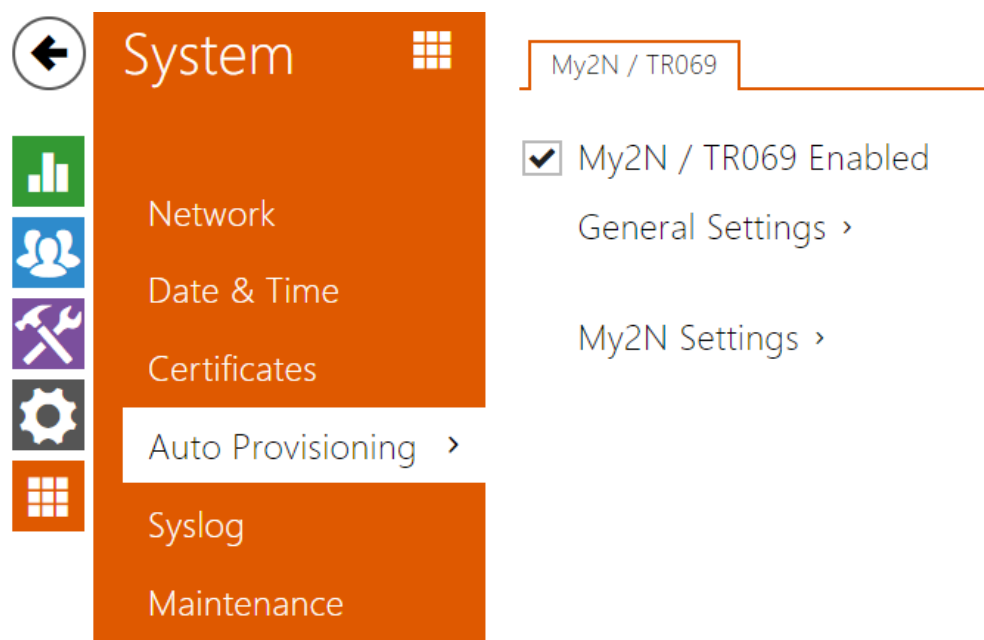

The **2N[®] Indoor View** help you update firmware and configuration manually, or automatically from a storage on a TFTP/HTTP server selected by you according to predefined rules.

The TFTP and HTTP server addresses can be configured manually. The **2N[®] Indoor View** support automatic identification of the local DHCP server address (Option 66).

My2N / TR069

Use this tab to enable and configure remote device management via the TR-069 protocol. TR-069 helps you reliably configure the device parameters, update and back up configuration and/or upgrade device firmware.

The TR-069 protocol is utilized by the My2N cloud service. Make sure that TR-069 is enabled and Active profile set to My2N to make the device work with My2N properly. Only then the device will be able to log in to My2N periodically for configuration.

This function helps you connect the device to your ACS (Auto Configuration Server). In this case, the connection to My2N will be disabled in the device.

My2N / TR069 Enabled

- **My2N / TR069 Enabled** - enable connection to My2N or another ACS server.

General Settings ▾

Active Profile

Next synchronization in **9h 47m 48s**

Connection State **Synchronized**

Communication Status Detail **HTTP status: 204, No Content.**

- **Active Profile** – select one of the pre-defined profiles (ACS), or choose a setting of your own and configure the ACS connection manually.
- **Next Synchronization in** – display the time period in which the device shall contact a remote ACS.
- **Connection Status** – display the current ACS connection state or error state description if necessary.
- **Communication Status Detail** – server communication error code or HTTP status code.
- **Connection test** – test the TR069 connection according to the set profile, see the Active profile. The test result is displayed in the Connection status.

My2N Settings ▾

My2N ID

My2N Security Code **HXGW-6EQT-M6JM-ANL5**

- **My2N ID** – unique identifier of the company created via the My2N portal.
- **My2N Security Code** – device code for adding to My2N.

3.2.5.5 Syslog

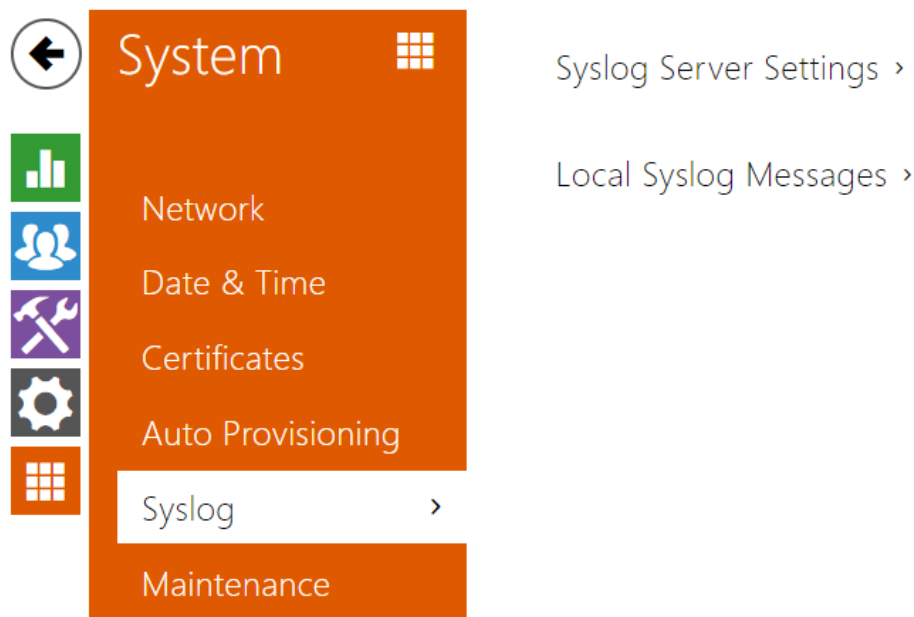

2N[®] **Indoor View** allows you to send syslog messages including relevant device state and process information to a syslog server for recording and further analysis or auditing of the device observed. It is unnecessary to configure this service for common operations.

List of Parameters

Syslog Server Settings ▾

Send Syslog Messages

Server Address

Severity Level ▾

- **Send Syslog Messages** - enable sending of syslog messages to the Syslog server. Make sure that the server address is valid.
- **Server Address** - set the IP/MAC address of the server on which the Syslog application is running.
- **Severity Level** - set the severity level of the messages to be sent (Error, Warning, Notice, Info, Debug 1-3). Debug 1-3 level setting is only recommended to facilitate troubleshooting for the Technical Support department.

Local Syslog Messages ▾

Saving Syslog Messages **RUNNING**Syslog Messages Saving Passed Time **0h 4m 26s**Syslog Messages Saving Remaining Time **0h 55m 34s**Saved Syslog Messages Size **78,335 B**Available Syslog Messages Saving Time **0h 4m 26s**Available Syslog Messages Size **78,335 B**Required Saving Time Syslog Messages Saving Control    

General overview of local syslog messages.

3.2.5.6 Maintenance

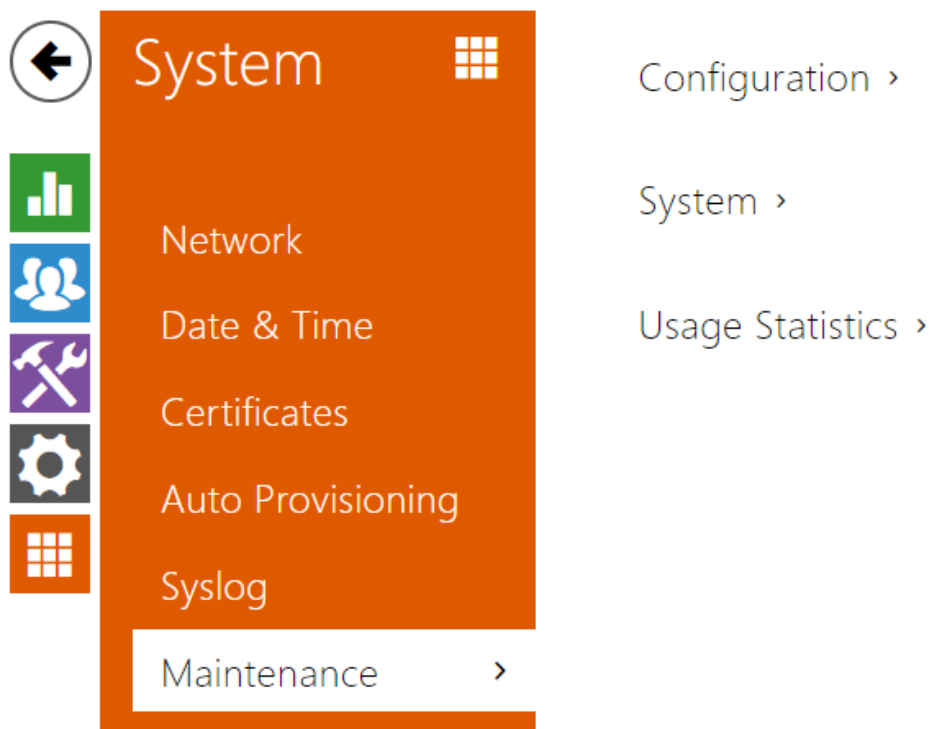

This menu helps you maintain the device configuration and firmware. You can back up and restore all the parameters, upgrade firmware and/or factory reset the device.

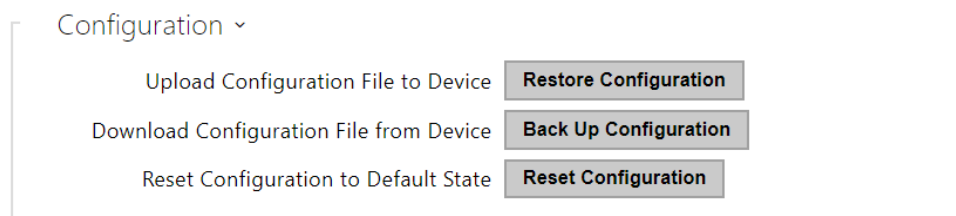

- **Restore Configuration** - restore configuration from a previous backup. Press the button to display a dialogue window to select a configuration file and upload it to the device. Before uploading choose whether or not the LAN settings and SIP PBX connection settings are to be applied.
- **Backup Configuration** - back up the complete current device configuration. Press the button to download the configuration file to your PC.

Caution

- *As the configuration may include delicate information, such as user phone numbers and access passwords, handle the file cautiously.*

- **Reset Configuration** - reset all the device parameters except for the LAN parameters. To reset the device completely, use the jumper or press Reset.

System ▾

Firmware Version **2.29.2.38.17**

Minimum Firmware Version **2.29.0.38.0**

Bootloader Version **1.0.0.0.7**

Software Build Type **Release**

Software Build Date and Time **7/29/2020 18:52:04 PM**

Upgrade Device Firmware

Firmware Status **Server error**

Notify of Beta Versions

Restart Device

Licenses

- **Upgrade firmware** - upload a new firmware version to the device. Press the button to display a dialogue window to select the proper firmware file. Once the firmware is uploaded, the device is restarted automatically and becomes fully operational with a new firmware version. The whole upgrading process takes less than one minute. Download the current firmware version for your device from www.2n.cz FW upgrade does not affect configuration The device checks the firmware file and prevents you from uploading an incorrect or corrupt file.
- **Check** - check online if a later firmware version is available. If so, the downloading option is offered followed by automatic upgrade.
- **Notify of Beta Versions** - enable monitoring and downloading of the latest firmware beta version.
- **Restart** - restart the device. The process takes about 30 s. Once restart is completed and the device is assigned its IP address, the login window will be displayed automatically.
- **Licenses** - click Show to open a dialogue window including a list of used licenses and third-party libraries. It also includes a EULA link.

Usage Statistics ▾

Send anonymous statistics data

-
- **Send anonymous statistics data** - enable sending of anonymous statistic data on device usage to the manufacturer. No such delicate information as passwords, access codes or phone numbers are included. This information helps 2N TELEKOMUNIKACE a.s. improve the software quality, reliability and performance. You can participate in this voluntarily and cancel your statistic data deliveries any time.

4. Device Control via Display

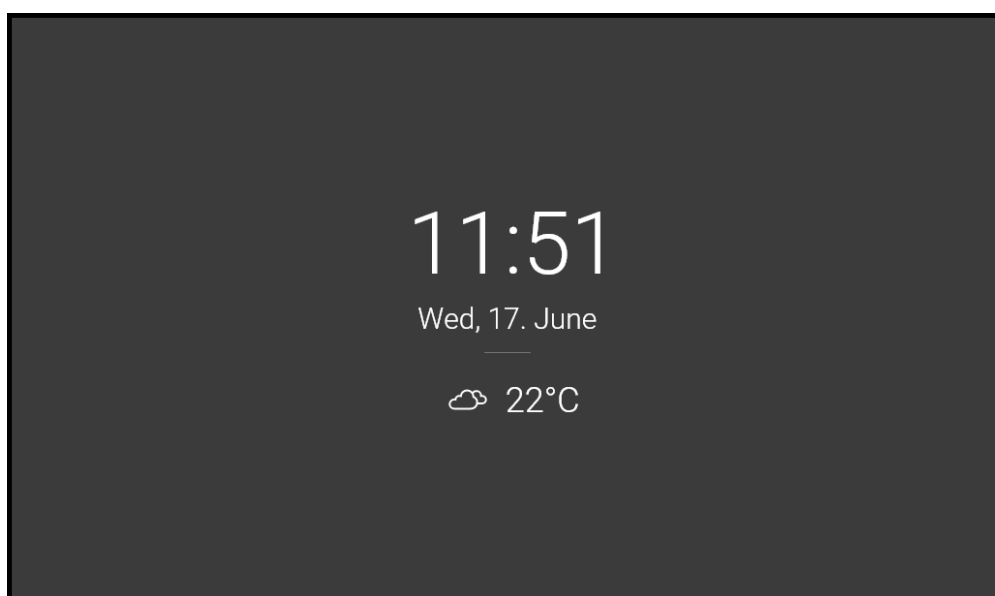

Sleep Mode

The device will automatically go into sleep mode if there is no activity (after selection of the timeout from 15 s to 10 min).

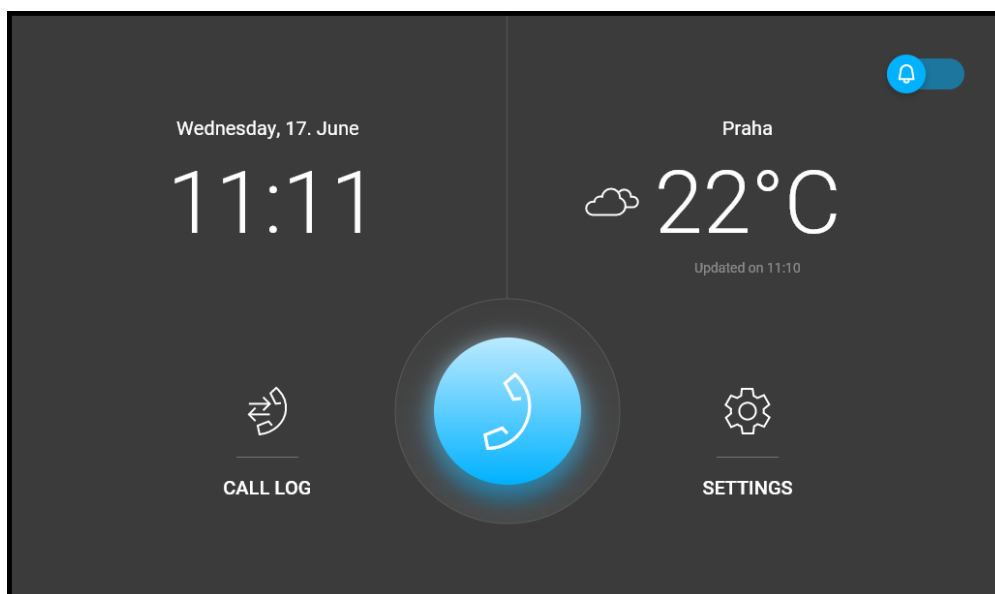

Home Page

The Home page is set as the introductory screen, which is displayed when the device is switched from the Idle mode by the touch of a finger. It shows the current date, time and temperature, gives you access to the Access Logs, Directory and Settings menus and allows you to activate the Do Not Disturb mode directly.















The dominant of the Home page is a phone earpiece icon on a blue background, which allows you to make calls to the destinations listed in the Directory.

Detailed device settings are described in the following sub-chapters.

- **4.1 Call Log**
- **4.2 Directory**
- **4.3 Settings**

Icons used on the display

Icon	Description
	DND mode
	Device configuration
	Call list

Icon	Description
	Incoming call ringtone volume up
	Incoming call ringtone volume down
	Incoming call ringtone volume mute
	Value up
	Value down
	Microphone mute in call
	Locked, screen lock
	Unlocked, screen lock activated/deactivated
	Camera Preview
	Camera 1
	Camera 2
	Back
	Move up
	Move down

The device will automatically go into sleep mode if there is no activity (after selection of the timeout from 15 s to 10 min). In this mode, the device only shows the date, time and current weather.

4.1 Call Log

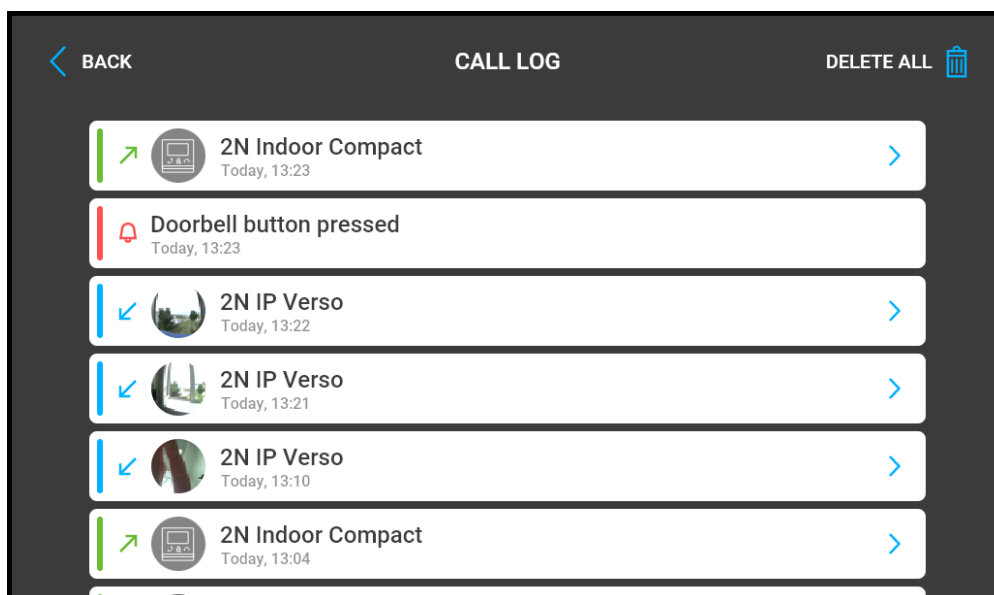

Press the button



to display the Call list. The menu provides a list of all accomplished calls including date, time, status (ougoing/incoming/missed) and information on from/to which destination the call was made. The maximum call count is 20.

You can choose any of the following actions from the 2N[®] Indoor View call list:

- **Return to Home page** using the left-hand upper button. <
- **Display detail** of call which was made using the > button. Displays a shot from the camera, if available, and identification of the caller and call time.
- **Move up and down** through the list by swiping your finger.
- **Delete all records** by pressing the  button.

Caution

- The device restart results in a deletion of the call list.



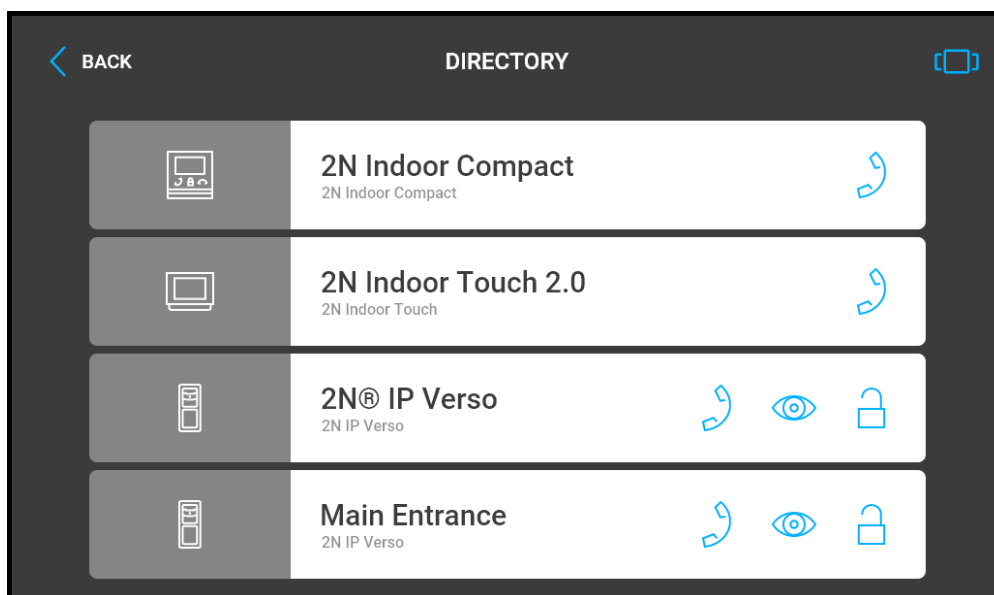

4.2 Directory

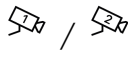

Find the Directory menu under the phone earpiece icon. The menu provides a list of destinations that can be called. The destinations include their names and the device type they are equipped with. The Directory provides either a list view where you can scroll up/down, or a tile view where you can browse from right to left to choose a destination.

Press the call receiving button to start a call to the selected device or user. Press the eye button to show the camera preview (the button is only available if the device is equipped with a camera). The camera preview option is based on the **2N® Enhanced Video** license of the selected device. Click the lock button to open the door during an incoming/outgoing call for the selected device.



When the intercom camera view is displayed on **2N® Indoor View** during the call, you can choose any of the following actions:

- **Switch camera** using the left-hand button at the  icon.
- **Switch off microphone in call** using the  button.
- **Increase and decrease volume** using the  button.
- **Switch off ringtone** using the  button.
- **Open door** using the door lock button .

- **End call** using the  call end button.

 **Caution**

- The camera switching function is only displayed if it has been activated and properly configured in the intercom.

Set the Directory via the web interface in the Directory / Device section. You can add a device manually, by clicking on the device adding icon  or automatically by clicking the registered device searching icon . Select the device in the list to add it automatically to the Directory list. The values are completed in the basic settings. With manual addition of a device/user to the Directory, the basic parameters are not completed automatically but have to be added manually. Make sure to complete the proper parameter in the Display section to display the CLIP. This helps the user choose and call any device displayed; refer to **3.2.2 Directory** for more details.

4.3 Settings

Press the  button on the home screen to display the Device Settings section. Use the Settings menu for local device settings.

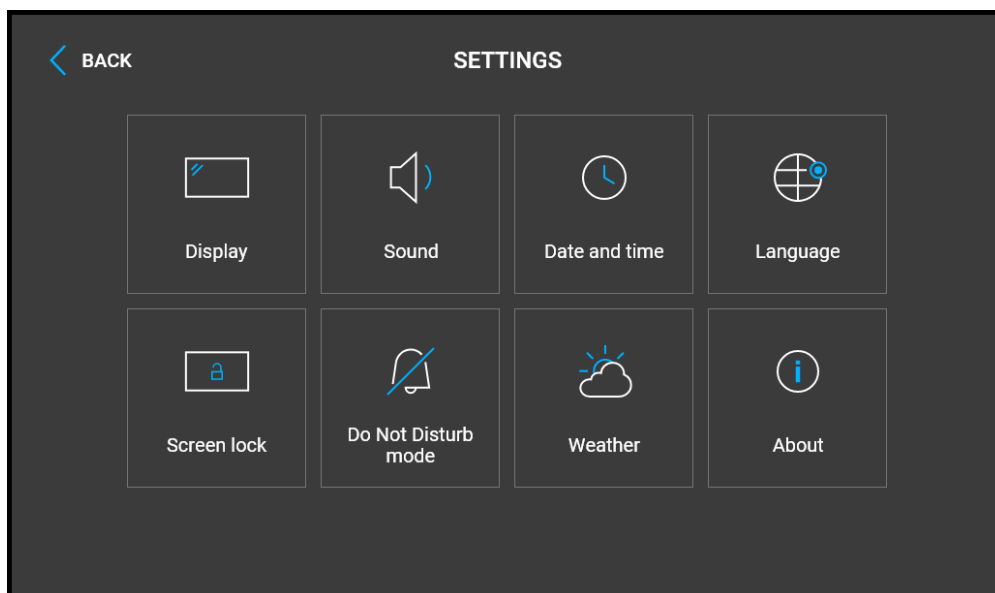

The menu contains 8 sections:

Display

- **Brightness** - sets the value of display backlighting.
- **Screen timeout** - timeout after which the device automatically goes into the Sleep Mode if there is no activity.

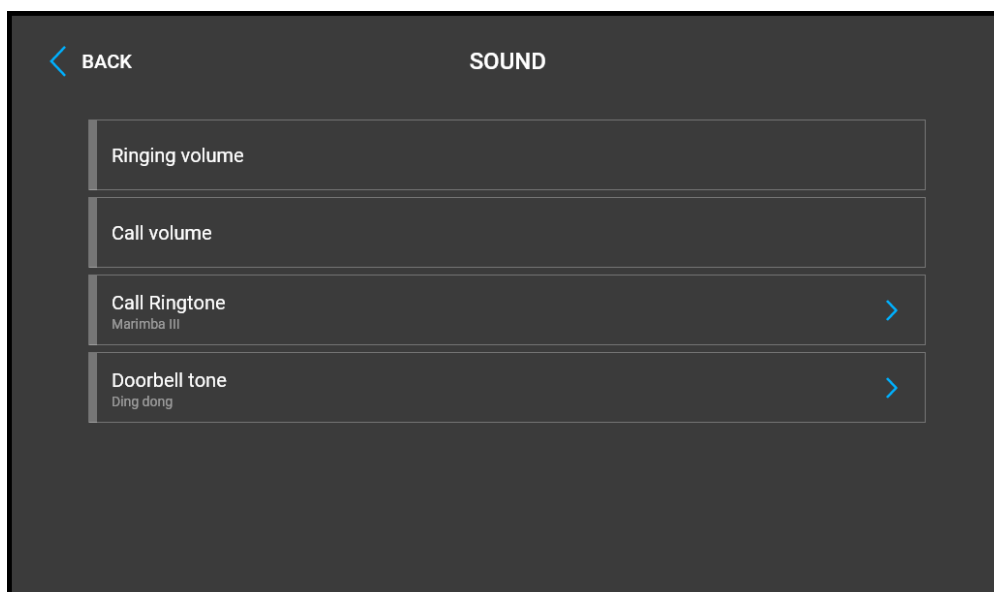

- **Ringtone volume** - set the incoming call ringtone volume.
- **Call volume** - set the phone call volume.
- **Call Ringtone** - sets the ringtone for incoming calls on the device.
- **Doorbell tone** - set the tone to be played when the doorbell is used.

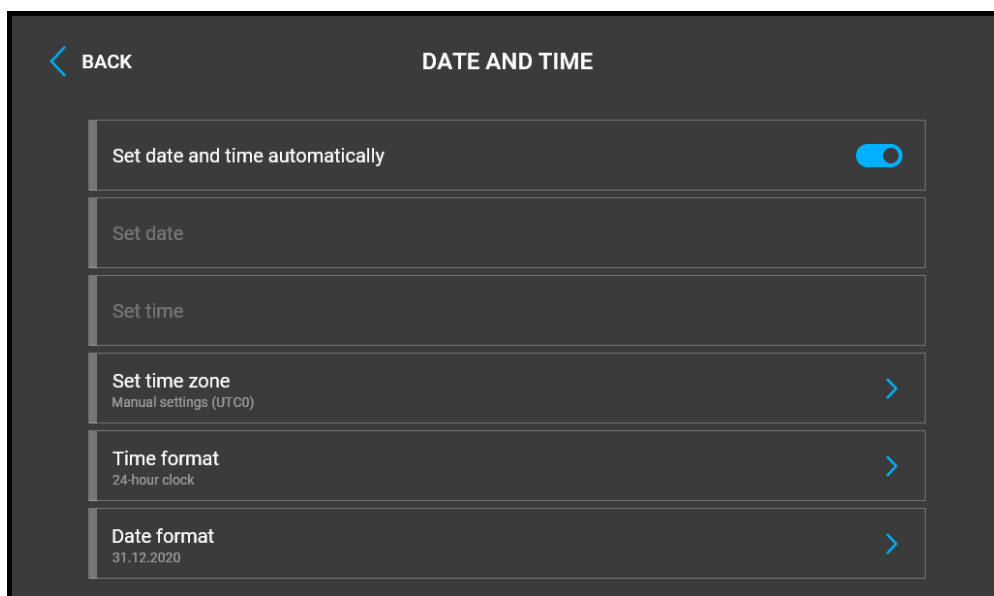

- **Set date and time automatically** - activate a mode in which the date and time will be taken from the network.
- **Set date** - set the date manually.
- **Set time** - set the time manually.

- **Set time zone** – set the time zone for your installation site to define time shifts and summer/winter time transitions.
- **Time format** – set the time format to be displayed.
- **Date format** – set the date format to be displayed.

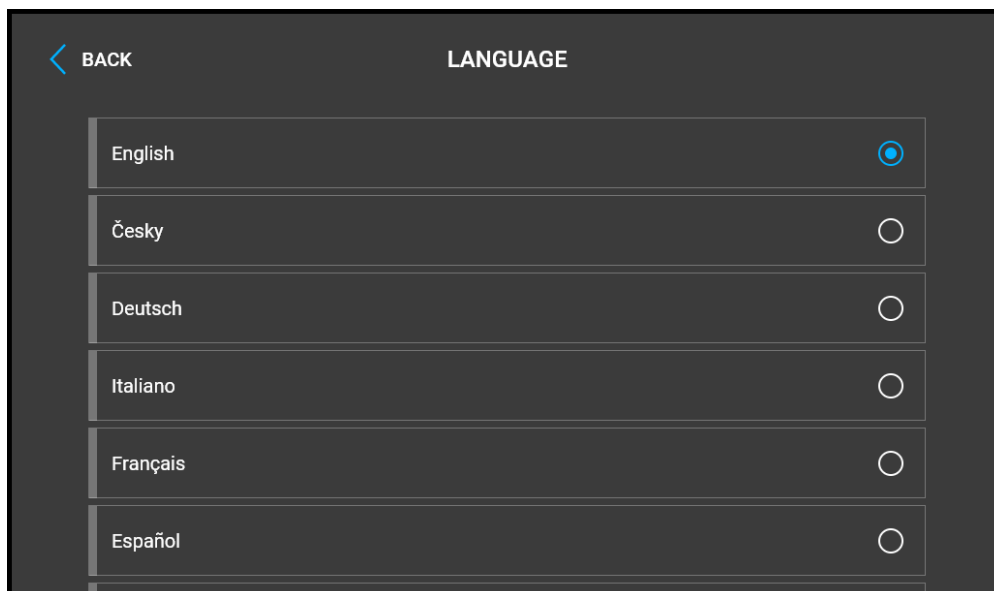

- **Language** – set the language for the texts to be displayed. Choose one of the seven pre-defined languages (CZ, EN, DE, FR, ES, IT, RU).

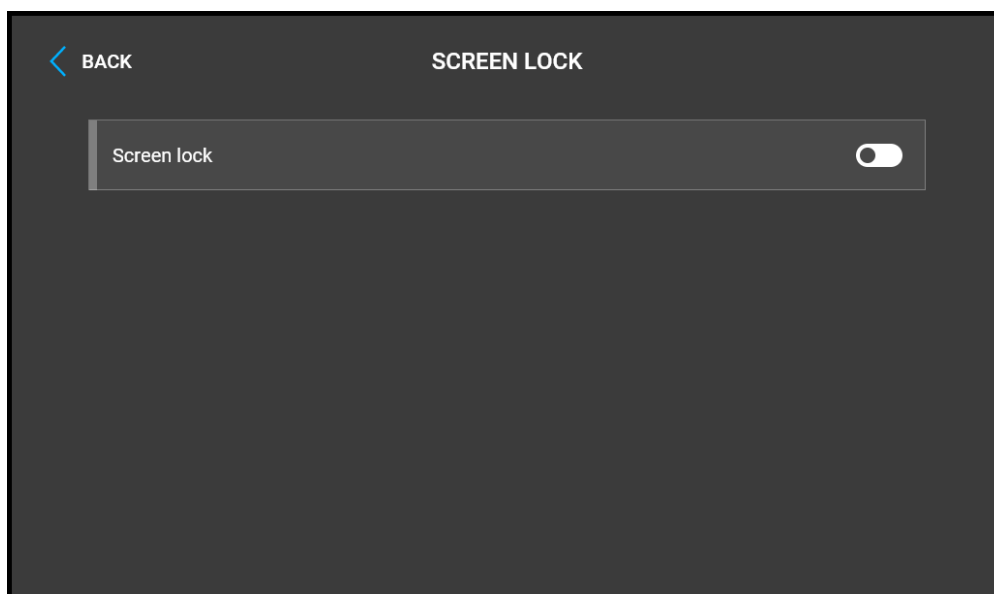

- **Screen lock** – switches the screen lock or also the so-called parental lock on/off. Enter the PIN code to enable the screen lock. Enter the same PIN code to disable the screen lock.

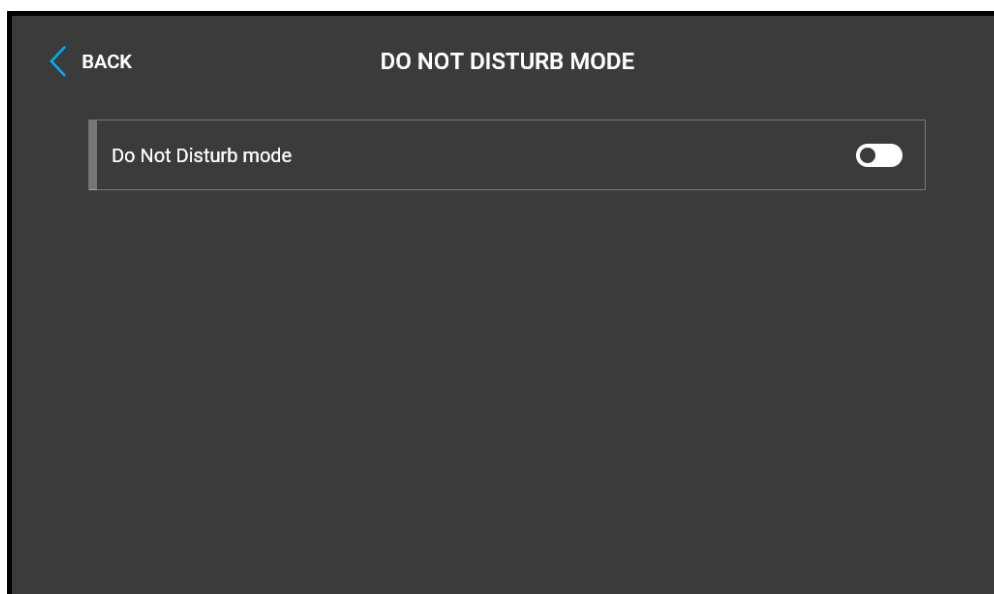

- **Do Not Disturb mode** - switches the Do Not Disturb mode on/off. This allows you to switch off the ringtone for the incoming call while this mode is active. By default, the DND mode does not apply to doorbell notification, i.e. the incoming ringtone is off and the doorbell ringtone is on. Change this setting via the web interface in the Hardware / Audio menu.

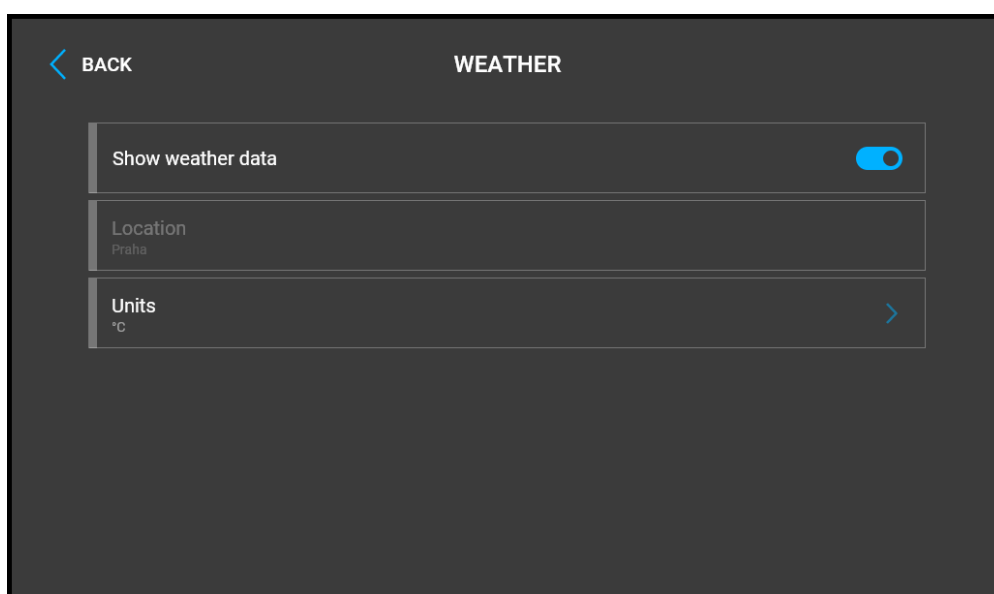

- **Show weather** - display or hide information about the current weather on the home screen.
- **Location** - device location for weather forecast. Location setting is only possible using the device web interface. Prague is the default location value.
- **Units** - set the metric (°C) or imperial (°F) units to be displayed.

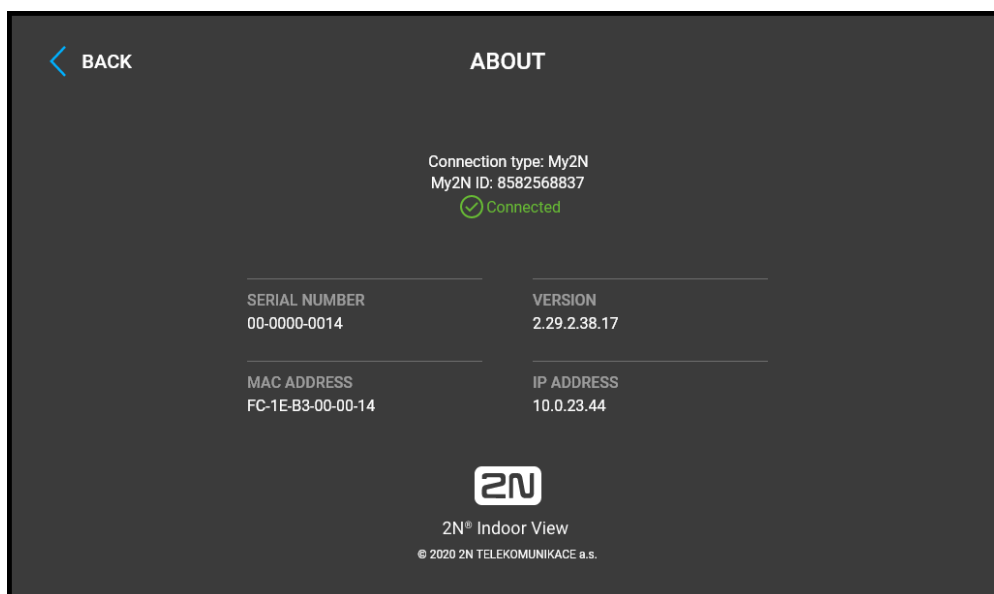







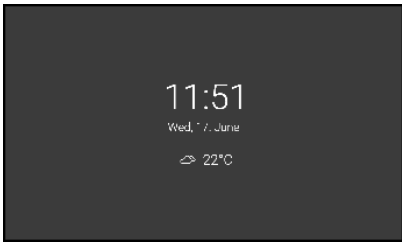
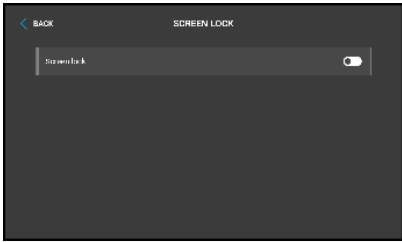
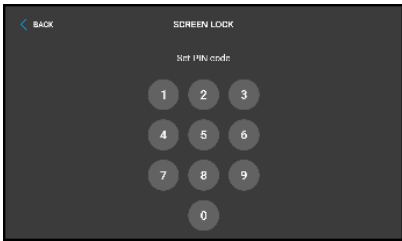

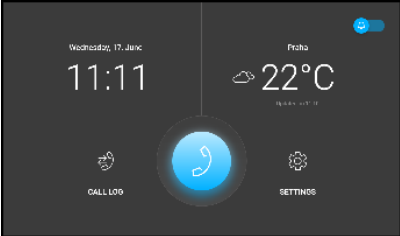



This section provides basic information on the device (serial number, MAC address, FW version, IP address, My2N ID).

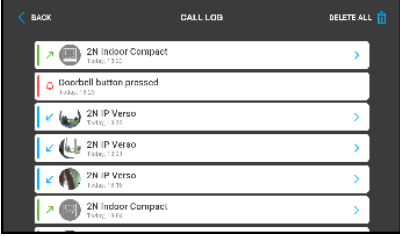





5. Operational Statuses



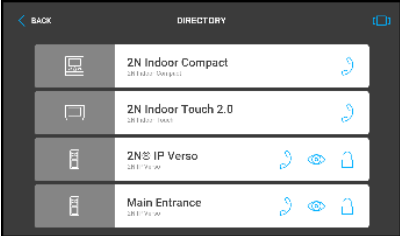

This section describes the user scenarios and states that may occur during operation, including the user options and expected results of actions.





Status and Description	User Actions	Navigation	Actions and Result
Sleep Mode 	Only the current date, time and weather are shown on the display.		
	End relax mode	Touch of the display.	Home page/parental lock is displayed.
Parental Lock  	Device shows the instruction "Enter PIN code " and codelist.		
	Parental lock settings	Activation of the function and setting of the 4-digit PIN code with subsequent confirmation	Parental lock is activated.
	Deactivate parental lock	Correct PIN entering	Device is unlocked.
	Enter invalid PIN	PIN mistyping	The PIN code reentering command is displayed.





Status and Description	User Actions	Navigation	Actions and Result
Home Page 			
Device is in relax mode.			
Display Directory	Press the blue backlit phone earpiece button 	Press the blue backlit phone earpiece button	The list of all available devices is displayed.
Display Call list	Button pressed 	Button pressed	The list of all accomplished calls is displayed.
Activate DND mode	Press the  button in the top right corner	Press the  button in the top right corner	DND is activated and the activation message is displayed.
Display Settings	Button pressed 	Button pressed	The Settings section is displayed.
Access Logs 			
The device displays a list of all accomplished calls including date, time, status (outgoing/incoming/missed) and information on from/to which destination the call was made.			
Show call detail	Press row of selected call	Press row of selected call	The call detail is displayed.
Outgoing Call	Press button for taking call  in call detail	Press button for taking call  in call detail	Creation of an outgoing call on the device in the list.
Unlock door	Press lock button  in call detail	Press lock button  in call detail	A call is set up or not depending on the connection type and the door is unlocked. If automatic call end after unlocking is enabled, the call is ended after door unlocking.







Status and Description	User Actions	Navigation	Actions and Result
	Move up and down in list	Press display with finger and slide up or down	The list scrolls up or down in the list. Once the end of the list has been reached, scrolling stops.
	Return to Home page	Press back button	Home page is displayed.
Detail in list 	<p>The display shows a snapshot from the camera set in the 2N IP intercom if a camera-equipped device initiated the call. A device symbol is displayed if the call initiating device is not equipped with a camera. Furthermore, the call day, date and time, description of the calling/called device and call status (outgoing/incoming/missed) are displayed.</p>		
	Return to Home page	Press back button 2x	The device returns to Home page.
	Return to call list	Press back button 1x	The device returns to the call list.
	Outgoing Call	Press the call receiving button	The device gets in the In call state.
	Door unlocking	Press the lock button	A call is set up or not depending on the connection type and the door is unlocked. If automatic call end after unlocking is enabled, the call is ended after door unlocking.

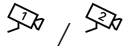

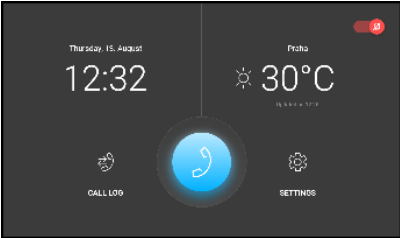

Status and Description	User Actions	Navigation	Actions and Result
Directory 	<p>The device displays a list of destinations that can be called. The destinations include their names and the device type they are equipped with.</p>		
	Return to Home page	Press back button 	Home page is displayed.
	Scroll up and down in directory	Press display with finger and slide up or down	The list scrolls up or down in the list. Once the end of the list has been reached, scrolling stops.
	Outgoing Call	Press call receipt button  in the row of the selected device	The device gets in the In call mode.
	Door unlocking	Press the lock button 	A call is set up or not depending on the connection type and the door is unlocked. If automatic call end after unlocking is enabled, the call is ended after door unlocking.
	Directory format - list	Press  icon in top right corner	The list of devices in the directory is displayed one under the other.
	Directory format - tiles	Press the  icon in the top right corner	The list of devices in the directory is displayed one after the other.

Status and Description	User Actions	Navigation	Actions and Result
<p>Incoming Call</p> 	<p>The device is playing the selected ringtone. The display shows the camera view if available, CLIP and Incoming call message.</p>		
	Pick up call	Touch of the display	The connection is established and the In call mode is switched on.
	Reject call	Press the call end button 	The incoming call is discontinued and Home page is returned to.
	Door unlocking	Press the lock button 	A call is set up or not depending on the connection type and the door is unlocked. If automatic call end after unlocking is enabled, the call is ended after door unlocking.
	The camera is switched (if installed and configured in the 2N IP intercom).	Press the button for switching the camera 	The display shows a preview from the other camera, identification of the device being called to and the message Incoming Call.
	Increase and decrease ringtone volume	Press the  button and select the required volume with the + or - button, or by moving the volume marker on the volume bar.	The volume of the ringtone is increased or decreased by one level at each individual press of + or - . If the volume marker is moved, the ringtone is increased or decreased according to the position on the volume bar.

Status and Description	User Actions	Navigation	Actions and Result
<p>Outgoing Call</p> 	<p>The device is playing the ringtone. The display shows the camera view if available, called device ID and Outgoing call message.</p>		
	End call	Press the call end button 	The outgoing call is discontinued and Home page is returned to.
	Door unlocking	Press the lock button 	A call is set up or not depending on the connection type and the door is unlocked. If automatic call end after unlocking is enabled, the call is ended after door unlocking.
	Switch camera	Press the button for switching the camera 	The display shows a preview from the other camera, identification of the device being called to and the message Incoming Call.
	Reject call	The call is rejected by the called device, not the 2N[®] Indoor View user.	The display shows Call rejected, the call is terminated and Home page is returned to.
	Mute call	Press the Mute button 	The call is muted.

Status and Description	User Actions	Navigation	Actions and Result
<p>In Call</p> 	<p>The display shows the camera view if available, or the called device ID if no camera is available. A timer is running at the view.</p>		
	Mute call	Press the Mute button 	The device is in the In call mode but sound is not transferred to the calling device. The Mute icon turns red. "No one hears you" message is displayed.
	End call	Press the call end button 	The outgoing call is discontinued and Home page is returned to.
	Door unlocking	Press the lock button 	A call is set up or not depending on the connection type and the door is unlocked. If automatic call end after unlocking is enabled, the call is ended after door unlocking.
	Switch camera	Press button to switch camera 	The display shows the camera 2 view, called device ID and timer.

Status and Description	User Actions	Navigation	Actions and Result
	Increase and decrease call volume	Button pressed  and required volume selected by pressing the + or - button, or by moving the volume marker on the volume bar.	The volume of the call is increased or decreased by one level at each individual press of + or -. If the volume marker is moved, the ringtone is increased or decreased according to the position on the volume bar.
	Cancel call muting	Press the Mute button 	The device is in the In call mode and sound is transmitted again to the calling device.
Do Not Disturb Mode	Device is in basic relax status. The doorbell icon is red.		
	Display Directory	Press the blue backlit phone earpiece button 	The list of all available devices is displayed.
	Display Call list	Button pressed 	The list of all accomplished calls is displayed.
	Switch off Do Not Disturb mode	Press the  in the right-hand upper corner	DND is deactivated, the doorbell icon turns white.
	Display Settings	Button pressed 	The Settings section is displayed.

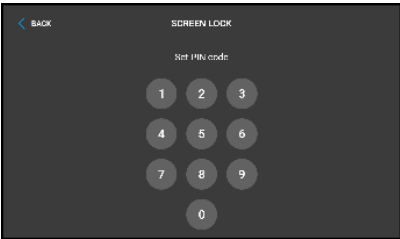
Status and Description	User Actions	Navigation	Actions and Result
<p>Incoming call in Do Not Disturb mode</p> 	<p>The device does not play the selected ringtone. The display shows the camera view if available, CLIP and Incoming call message.</p>		
	<p>Pick up call</p>	<p>Press the call receiving button </p>	<p>The call is connected. The device is in the In call mode.</p>
	<p>Reject call</p>	<p>Press the call end button </p>	<p>The incoming call is discontinued and Home page is returned to.</p>
	<p>Switch camera</p>	<p>Press the button for switching the camera </p>	<p>The display shows a preview from the other camera, identification of the device being called to and the message Incoming Call.</p>
<p>Incoming Call with Parental Lock On</p> 			<p>The device is playing the selected ringtone. The display shows a preview from the camera, if available, identification of the caller and the message Incoming Call. After pressing the display, an instruction is displayed prompting the user to deactivate the parental lock. A preview of the call is shown in the background.</p>

6. Technical Parameters

Power Supply

- **Type:** 12 V DC +/-10 % adapter or PoE 802.3af
- **Recommended power supply:** 12 V / 1 A
- **Polarity reversal protection:** yes

Power Input

- **In idle:**
 - **12 V:** 2,28 W - 0,19 A
 - **PoE:** 2,9 W
- **Max. in active state:** 12 W / 1A

User Interface

- **Controls:** capacitive touch panel
- **Display:** 7" with 1024 x 600 pixel resolution
- **Service:** RESET button with long press option for factory reset

Signalling protocol

- SIP (UDP, TCP, TLS)

Audio

- **Microphone:** integrated
- **Speaker:** 2 W integrated
- **Induction loop output:** 600 mV RMS

Audio stream

- **Protocols:** RTP / RTSP
- **Codecs:** G.711, G.729, G.722, L16/16kHz

Video stream

- **Protocols:** RTP / RTSP / HTTP, MJPEG
- **Codecs:** H.264, M-JPEG

Interface

- **LAN:** 10/100BaseT, RJ-45; Cat5e or higher

Doorbell Input

- **Input type:** switching contact (button/relay)
- **Contact type:** normally open (NO)
- **Contact parameters:** up to 50 V / 5 mA, DC

Mechanical Parameters

- **Dimensions (w x h x d):** 193 x 157 x 50 mm
- **Weight:** 555 g
- **Operating temperature:** 0 to 50 °C
- **Relative humidity:** 10 to 90 % non-condensing
- **Storing temperature:** -20 to 70 °C
- **Recommended altitude:** 0 - 2000 m

7. Supplementary Information

This section provides supplementary information on the 2N[®] Indoor View product.

Here is what you can find in this section:

- **7.1 Troubleshooting**
- **7.2 Directives, Laws and Regulations - General Instructions and Cautions**

7.1 Troubleshooting



For the most frequently asked questions refer to faq.2n.cz.

7.2 Directives, Laws and Regulations - General Instructions and Cautions

2N[®] Indoor View conforms to the following directives and regulations:

- 2014/35/EU for electrical equipment designed for use within certain voltage limits
- 2014/30/EU for electromagnetic compatibility
- 2011/65/EU on the restriction of the use of certain hazardous substances in electrical and electronic equipment
- 2012/19/EU on waste electrical and electronic equipment

Industry Canada

This Class B digital apparatus complies with Canadian ICES-003/NMB-003.

FCC

This equipment has been tested and found to comply with the limits for a Class B digital device, pursuant to part 15 of the FCC Rules.

NOTE: These limits are designed to provide reasonable protection against harmful interference in a residential installation. This equipment generates, uses and can radiate radio frequency energy and, if not installed and used in accordance with the instructions, may cause harmful interference to radio communications.

However, there is no guarantee that interference will not occur in a particular installation. If this equipment does cause harmful interference to radio or television reception, which can be determined by turning the equipment off and on, the user is encouraged to try to correct the interference by one or more of the following measures:

- Reorient or relocate the receiving antenna
- Increase the separation between the equipment and receiver
- Connect the equipment into an outlet on a circuit different from that to which the receiver is connected
- Consult the dealer or an experienced radio/TV technician for help

Changes or modifications to this unit not expressly approved by the party responsible for compliance could void the user's authority to operate this equipment.

 **Caution****Varování**

Za účelem dosažení plné funkčnosti a zaručených výkonů důrazně doporučujeme vždy již při instalaci ověřit aktuálnost používané verze produktu či zařízení. Zákazník tímto bere na vědomí, že produkt či zařízení může dosahovat zaručených výkonů a být plně funkční dle propozic výrobce pouze v případě, je-li používána nejnovější verze produktu či zařízení, která byla otestována na plnou interoperabilitu a která nebyla výrobcem označena jako nekompatibilní s určitými verzemi jiných produktů, a to pouze v souladu s pokyny, návodem či doporučením výrobce a pouze ve spojení s vyhovujícími produkty a zařízeními jiných výrobců. Nejnovější verze jsou dostupné na internetových stránkách https://www.2n.cz/cs_CZ/, popř. jednotlivá zařízení podle svých technických možností umožňují aktualizaci v konfiguračním rozhraní. Používá-li zákazník jinou než nejnovější verzi produktu či zařízení, popř. používá-li verzi, kterou výrobce označil za nekompatibilní s určitými verzemi jiných produktů, nebo používá-li zákazník produkt či zařízení v rozporu s pokyny, návodem či doporučením výrobce, nebo ve spojení s nevyhovujícími produkty či zařízeními jiných výrobců, je srozuměn s veškerými případnými omezeními funkčnosti takového produktu či zařízení a s důsledky s tím spojenými. Použitím jiné než nejnovější verze produktu či zařízení, popř. verze, kterou výrobce označil za nekompatibilní s určitými verzemi jiných produktů, nebo použitím produktu či zařízení v rozporu s pokyny, návodem či doporučením výrobce, popř. použitím s nevyhovujícími produkty či zařízeními jiných výrobců, zákazník souhlasí s tím, že společnost 2N TELEKOMUNIKACE a. s. není odpovědná za jakékoli omezení funkčnosti takového produktu ani za újmu související s takovým případným omezením funkčnosti.

Please read this User Manual carefully before using the product. Follow all instructions and recommendations included herein.

Any use of the product that is in contradiction with the instructions provided herein may result in malfunction, damage or destruction of the product.

The manufacturer shall not be liable and responsible for any damage incurred as a result of a use of the product other than that included herein, namely undue application and disobedience of the recommendations and warnings in contradiction herewith.

Any use or connection of the product other than those included herein shall be considered undue and the manufacturer shall not be liable for any consequences arisen as a result of such misconduct.

Moreover, the manufacturer shall not be liable for any damage or destruction of the product incurred as a result of misplacement, incompetent installation and/or undue operation and use of the product in contradiction herewith.

The manufacturer assumes no responsibility for any malfunction, damage or destruction of the product caused by incompetent replacement of parts or due to the use of reproduction parts or components.

The manufacturer shall not be liable and responsible for any loss or damage incurred as a result of a natural disaster or any other unfavourable natural condition.

The manufacturer shall not be held liable for any damage of the product arising during the shipping thereof.

The manufacturer shall not make any warrant with regard to data loss or damage.

The manufacturer shall not be liable and responsible for any direct or indirect damage incurred as a result of a use of the product in contradiction herewith or a failure of the product due to a use in contradiction herewith.

All applicable legal regulations concerning the product installation and use as well as provisions of technical standards on electric installations have to be obeyed. The manufacturer shall not be liable and responsible for damage or destruction of the product or damage incurred by the consumer in case the product is used and handled contrary to the said regulations and provisions.

The consumer shall, at its own expense, obtain software protection of the product. The manufacturer shall not be held liable and responsible for any damage incurred as a result of the use of deficient or substandard security software.

The consumer shall, without delay, change the access password for the product after installation. The manufacturer shall not be held liable or responsible for any damage incurred by the consumer in connection with the use of the original password.

The manufacturer also assumes no responsibility for additional costs incurred by the consumer as a result of making calls using a line with an increased tariff.

Electric Waste and Used Battery Pack Handling



Do not place used electric devices and battery packs into municipal waste containers. An undue disposal thereof might impair the environment!

Deliver your expired electric appliances and battery packs removed from them to dedicated dumpsites or containers or give them back to the dealer or manufacturer for environmental-friendly disposal. The dealer or manufacturer shall take the product back free of charge and without requiring another purchase. Make sure that the devices to be disposed of are complete.

Do not throw battery packs into fire. Battery packs may not be taken into parts or short-circuited either.



2N TELEKOMUNIKACE a.s.

Modřanská 621, 143 01 Prague 4, Czech Republic

Phone: +420 261 301 500, Fax: +420 261 301 599

E-mail: sales@2n.cz

Web: www.2n.cz

v2.32