

FLUSH-MOUNT BOUNDARY MICROPHONE

EM-600

Thank you for purchasing TOA's Flush-mount Boundary Microphone.
Please carefully follow the instructions in this manual to ensure long, trouble-free use of your equipment.

1. SAFETY PRECAUTIONS

- Before installation or use, be sure to carefully read all the instructions in this section for correct and safe operation.
- Be sure to follow all the precautionary instructions in this section, which contain important warnings and/or cautions regarding safety.
- After reading, keep this manual handy for future reference.

CAUTION

Indicates a potentially hazardous situation which, if mishandled, could result in moderate or minor personal injury, and/or property damage.

- Install the unit only in a location that can structurally support the weight of the unit and the mounting components. Doing otherwise may result in the unit falling down and causing personal injury and/or property damage.
- Do not expose the unit to rain or an environment where it may be splashed by water or other liquids, as doing so may result in electric shock.
- Do not lay the connection cable where it can be walked on or tripped over, causing personal injury.

2. GENERAL DESCRIPTION

The EM-600 is an omnidirectional condenser microphone of only 28 mm (1.1") in diameter. It can be flush-mounted into a ceiling, wall, or desk, making it unobtrusive.

3. FEATURES

- Realizes optimum acoustic characteristics suitable for sound pick-up when flush-mounted into a ceiling or wall.
- Provides clear, easy-to-listen-to, high-quality sound.

4. HANDLING PRECAUTIONS

- Be sure to turn off the phantom power switch on the equipment that the unit is connected to before connecting or disconnecting the unit. As doing otherwise may cause loud noise or damage to the unit or connected equipment.
- Avoid installing the unit in humid or dusty locations, in locations exposed to the direct sunlight, near the heaters, or in locations generating sooty smoke or steam as doing otherwise may result in unit failure.
- Take care not to drop the unit onto the floor nor bump it against a hard object as the unit could fail.
- Avoid using a mobile telephone near the microphone in use. Noise could be picked up.
- To clean, be sure to first disconnect the connection cable, then wipe with a dry cloth. When the unit gets very dirty, use a cloth damped in a neutral cleanser. Never use benzene, thinner, alcohol, or chemically-treated cleaning cloth because such volatile liquids could deform or discolor the unit.

5. SPECIFICATIONS

Element	Electret condenser
Polar Pattern	Omnidirectional
Rated Impedance	120 Ω, balanced
Rated Sensitivity	-36 dB (0 dB = 1 V/Pa, 1 kHz)
Frequency Response	30 Hz – 20 kHz
Phantom Power	9 – 52 V DC
Output Connector	XLR-3-12 or equivalent
Finish	Main body: Steel, white, semi-gloss, paint Head: Galvanized steel wire, white, semi-gloss, paint
Dimensions	ø28 x 68 mm (ø1.1" x 2.68")
Weight	85 g (0.19 lb)
Accessories	Rubber isolation ring 2 Nut (for M20) 1

Note: The design and specifications are subject to change without notice for improvement.



6. COMPONENTS

Microphone body 1 Rubber isolation ring 2

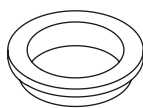
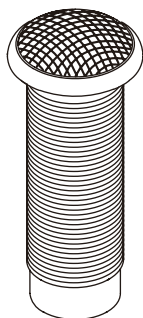

Nut (for M20) 1

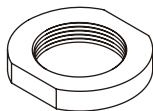

7. INSTALLATION

The figure below shows an example when flush-mounting the unit into a ceiling. Similarly, it can be flush-mounted into a wall or desk.

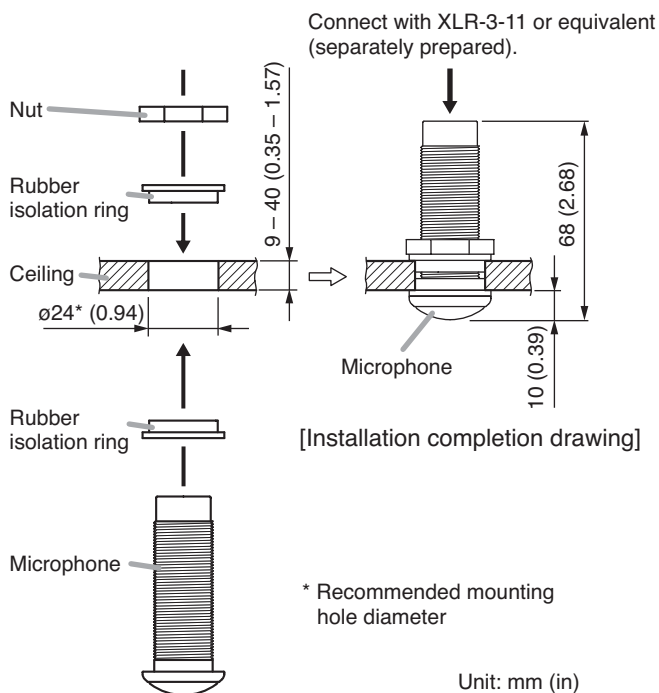

8. CIRCUIT DIAGRAM

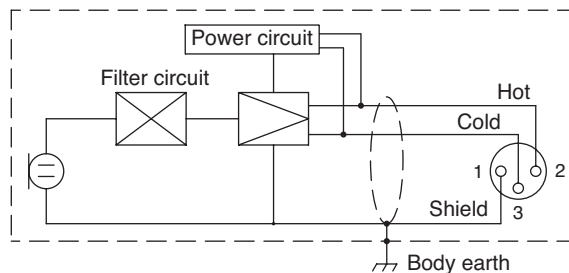

9. DIRECTIVITY CHARACTERISTICS

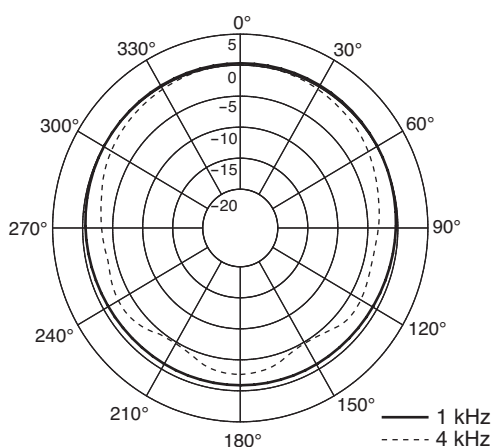

10. FREQUENCY RESPONSE

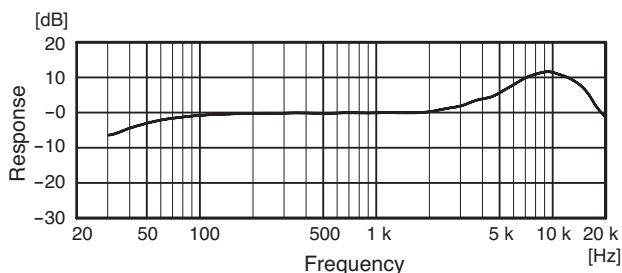

Traceability Information for Europe (EMC directive 2004/108/EC)

Manufacturer:
TOA Corporation
7-2-1, Minatojima Nakamachi, Chuo-ku, Kobe, Hyogo, Japan

Authorized representative:
TOA Electronics Europe GmbH
Suederstrasse 282, 20537 Hamburg, Germany