

Installation/Owner's Manual

Model 1834 80 Series Telephone Entry System

1834-065-U-9-22

Use this manual for:

Surface/Flush mount circuit board 1834-010 Revision Y or higher.

Wall mount circuit board 1834-009 Revision Y or higher (Discontinued).

Control a main entry point plus an additional entry point.

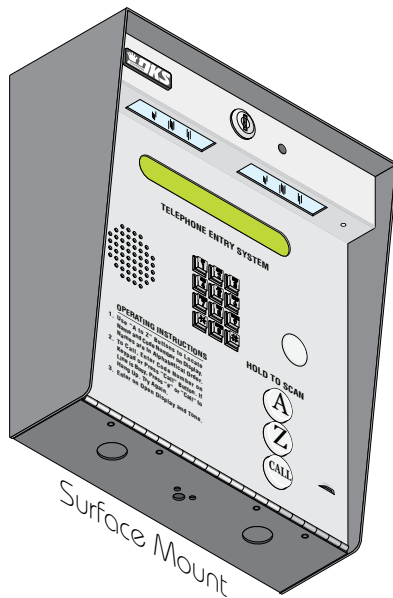

Surface Mount

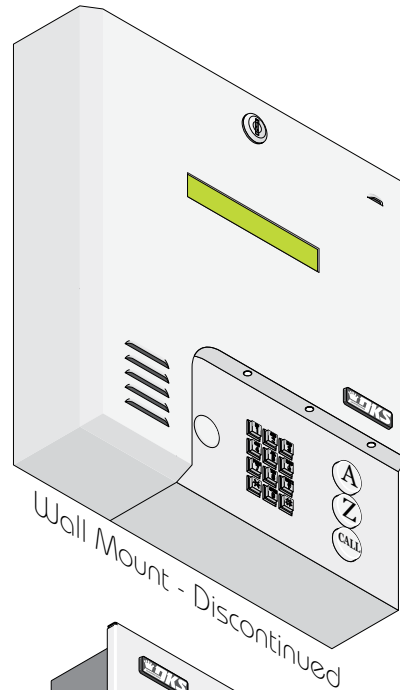

Wall Mount - Discontinued

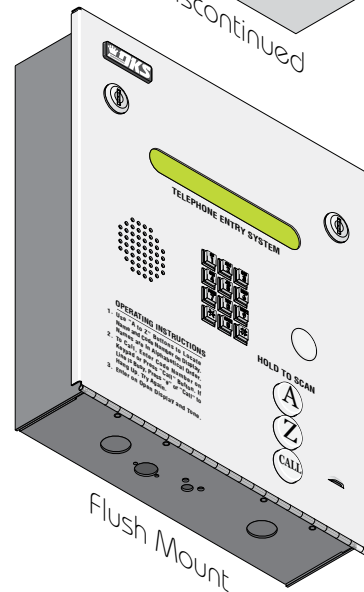

Flush Mount

Date Installed: _____

Installer/Company Name: _____

Phone Number: _____

Circuit Board
Serial Number
and Revision Letter: _____

Leave Manual with Owner

Download **REMOTE ACCOUNT MANAGER** Software **FREE** at:
<http://www.doorking.com/telephone/software>

Copyright 2022 DoorKing®, Inc. All rights reserved.



Conforms To UL STD 294
Certified To CAN/ULC-S319-05



QUICK GUIDE: Terminal Descriptions

See page 20 for terminal wiring.

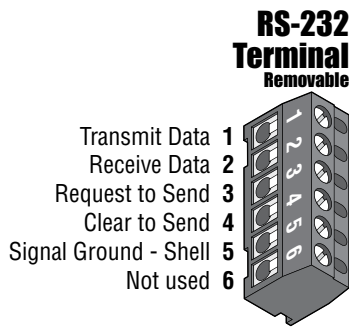

Note: The 6-pin terminal can be removed for easy wiring. Connects a PC (See Section 2.5.1).

Aux Terminal
Non-Removable

- 2 16.5 VAC Input Power – 20 VA.
- 1 16.5 VAC Input Power – 20 VA. (Powers RS-232)

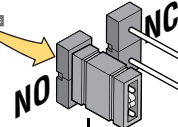

Relay 2 Note: Normally Open and Normally Closed relay jumper is used to set **Relay 2** input on the circuit board (See section 4.6).

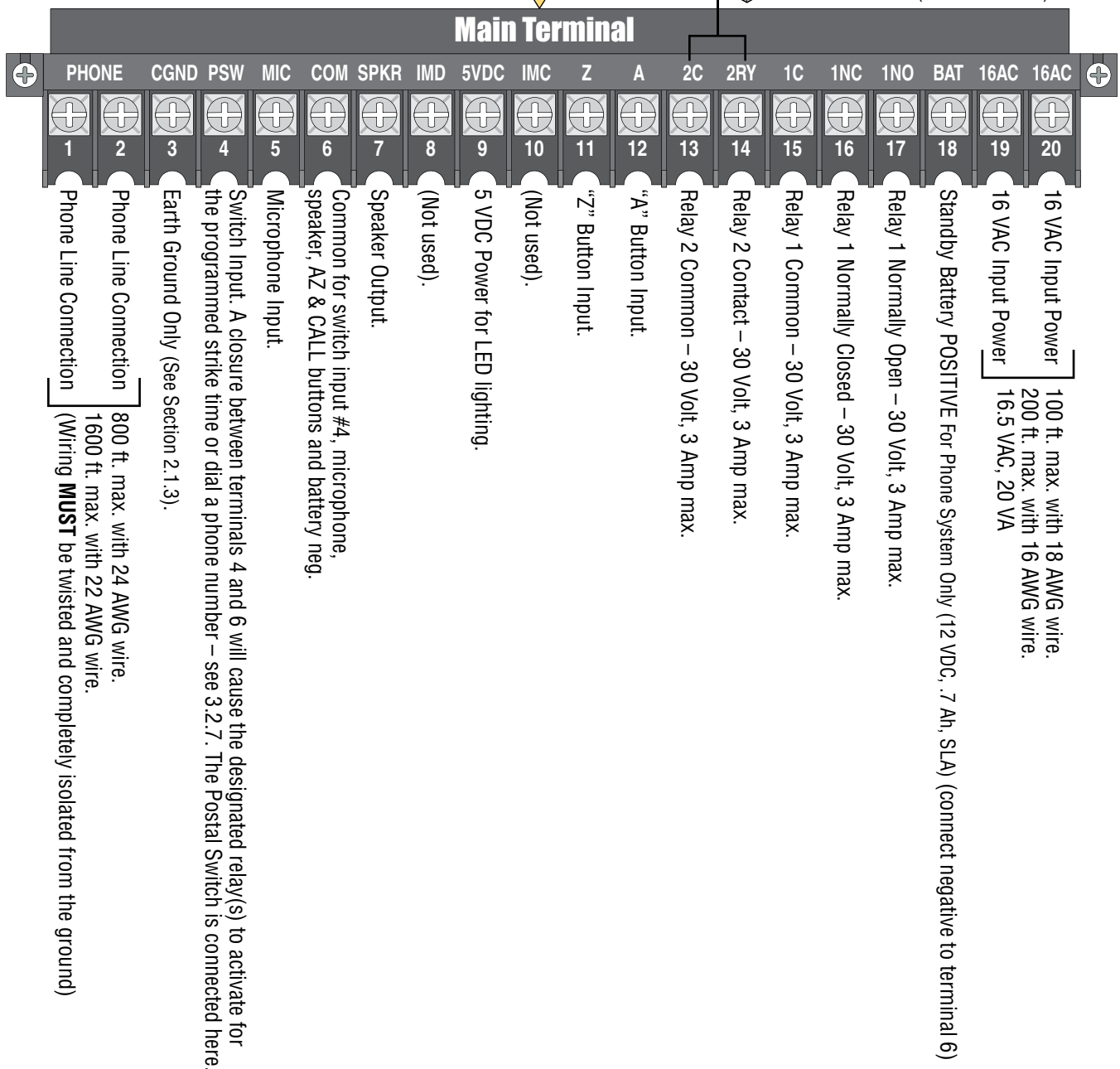

Overview for System Keypad Programming

	Page #	Section	Command	Factory Setting	
NOT Programmable from Software. Program from System Keypad ONLY.	Section 3.2 Setup Entry System for PC Programming				
		26	3.2.1	Master Switch ON	No factory setting
		27	3.2.2	* 60	1 (255 area codes)
		27	3.2.3	* 78	0 (OFF)
		27	3.2.5	* 15	1 (tone ON)
		28	3.2.6	* 85	1 (19200 Baud)
		28	3.2.7	* 18	0 (activates relay)
		28	3.2.9	* 04	Single system
		28	3.2.10	* 59	Issued by DoorKing
		29	3.2.11	* 95	8-3000 Memory 2-Card WITH Anti-Pass Back
	30	3.2.12	* 19	OFF	
Testing DKS Data over IP		53	6.1.7	* 55	Testing Option
		53	6.1.8	* 29	Testing Option
		53	6.1.9	* 56	Testing Option OFF
Section 3.3 General Programming using System Keypad				Relay 0: 01 (1 sec) Relay 1: 01 (1 sec) Relay 2: 01 (1 sec)	
	31	3.3.1	* 03		
	31	3.3.2	* 08	060 (60 sec)	
	32	3.3.3	* 05	Relay 0: # # # # Relay 1: 9 8 7 6 Relay 2: 5 4 3 2	
	32	3.3.4	* 50	010 (relay 1 activates)	
	33	3.3.5	* 07	Touch-tone	
	33	3.3.6	* 51	010 (relay 1 activates)	
Section 3.4 Programming Letters, Numbers and Messages					
	34	3.4.1	None	No factory setting	
	35	3.4.2	* 80	Factory message	
	36	3.4.3	* 81	Factory message	
Section 3.5 Programming Phone Numbers and Names					
	38	3.5.1	* 20	Three (3) digits	
	38	3.5.2	* 01	No factory setting	
	39	3.5.3	* 24	No factory setting	
	39	3.5.4	* 41	No factory setting	
	40	3.5.5	* 66	No factory setting	
	40	3.5.6	* 01	No factory setting	
	40	3.5.7	* 65	No factory setting	
	41	3.5.8	* 24	No factory setting	
	41	3.5.9	* 06	No Factory setting	
	41	3.5.10	* 09	No factory setting	
	41	3.5.11	* 27	1 (Pause ON)	
Section 3.6 Not Applicable to 1834					
Section 3.7 Programming Four-Digit Entry Codes					
	42	3.7.1	* 02	No factory setting	
	42	3.7.2	* 02	No factory setting	
	42	3.7.3	* 12	No factory setting	
Section 3.8 Not Applicable to 1834					

Note: Program section numbers have been intentionally skipped that **DO NOT** apply to the specific access controller in this manual. This allows **ALL** of the 1830 series manuals (1835-065 and 1838-065) to remain in sync with each other when referencing programming numbers.

SPECIFICATIONS

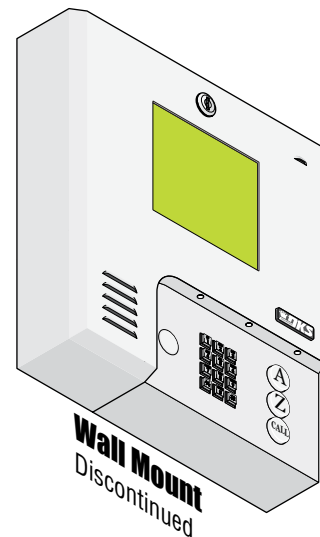
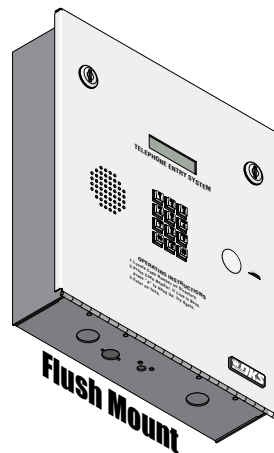
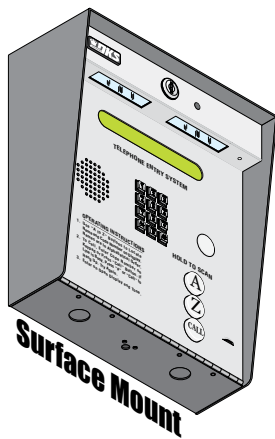

Features

- Can provide service for up to 3000 residents.
- System can be connected via a Cellular connection using DKS Cellular Services; via the Internet using DKS Data over the Internet Services for VoIP and/or programming; POTS (Plain Old Telephone Service) using DKS IM Server or your own modem - Note: DKS does not guarantee modem connections via the PSTN (Public Switched telephone Network).
- ONE TOUCH CALLING provides the easiest to use system on the market.
- System keypad will emit DTMF tones after a call is answered allowing the system to be used with auto-attendants, answering machines, etc.
- Directory codes can be set from 1 to 4 digits in length and can be randomly assigned.
- Transaction buffer stores the last 8000 events and has its own backup power source to retain memory during power outages.
- View the LIVE transactions “real-time” on a PC.
- Control the phone entry system relays directly from a PC (Rev Y and higher boards only).
- True Anti-Pass Back feature.
- Up to 255 programmable area codes (Rev E and higher boards only) allow the system to be used in areas requiring 10 and 11-digit dialing.
- Two internal relays allow the system to control a main entry point plus one additional entry point.
- Available in surface and flush mount styles.

Included with the system is an extra random keyed cabinet lock. If desired, for added security against unauthorized entry into the system, the standard lock may be replaced with the random lock. Note: DoorKing cannot replace this specific lock or keys if lost.

DoorKing, Inc. reserves the right to make changes in the products described in this manual without notice and without obligation of DoorKing, Inc. to notify any persons of any such revisions or changes. Additionally, DoorKing, Inc. makes no representations or warranties with respect to this manual. This manual is copyrighted, all rights reserved. No portion of this manual may be copied, reproduced, translated, or reduced to any electronic medium without prior written consent from DoorKing, Inc.

TABLE OF CONTENTS

Quick Guide Terminal Descriptions	Quick Guide - 1
Overview for System Keypad Programming	Quick Guide - 2
Important Notices FCC - United States, DOC - Canada Glossary	3
General Information Installation Guidelines and Safety Information	4
SECTION 1 - INSTALLATION	5
1.1 General Installation	5
1.1.1 Remove Components from Enclosure	6
1.2.1 Install Enclosure	7
1.2 Surface Mount Dimensions	8
1.2.1 Surface Mount Recess Kit Dimensions and Installation	9
1.3 Flush Mount Dimensions	10
1.3.1 Flush Mount Kit Dimensions and Installation	11
1.3.2 Flush Mount Surface Mounting Kit Dimensions and Installation	12
1.3.3 Self-Standing Lighted Kiosk Dimensions and Installation	13
1.4 Wall Mount (Discontinued) Dimensions	14
1.5 Memory Chip Replacement	15
1.6 Postal Lock Installation	16
SECTION 2 - WIRING	17
2.1 Wiring Guidelines	17
2.1.1 Power	17
2.1.2 Wire Runs	17
2.1.3 Grounding	18
2.1.4 Surge Suppression	18
2.1.5 Ferrite Filter	18
2.2 Terminal Descriptions	19
2.3 Telephone Entry System Wiring	20
2.3.1 Telephone Entry System	20
2.4 PC (Data) and Phone (Voice) Connection Options	21
2.4.1 DoorKing Cellular Network Connection - Voice/Data Transfer	21
2.4.2a DoorKing VoIP/RS-232 Control Box - Voice/Data Transfer	22
2.4.2b DoorKing VoIP Internet Connection - Voice/Data Transfer	22
2.4.2c Third Party VoIP Internet Connection - Voice/Data Transfer	22
2.4.3a DoorKing IM Server Modem Connection - Voice/Data Transfer	23
2.4.3b Dial-Up Phone Modem Connection - Voice/Data Transfer	23
2.5 PC Direct Connection to a PC Options - Data Transfer ONLY	24
2.5.1 RS-232 Direct Connection - Data Transfer ONLY	24
2.5.2 RS-422/USB Direct Connection to PC - Data Transfer ONLY	24
2.5.3 TCP/IP Converter Direct Connection to PC - Data Transfer ONLY	24
SECTION 3 - PROGRAMMING	25
3.1 General Programming Information	25
3.1.1 Programming from a PC	25
3.1.2 Programming from the Telephone Entry System Keypad	25
3.2 Setup Telephone Entry System for PC Programming	26
3.2.1 Master Code	26
3.2.2 Number of Area Codes Allowed	27
3.2.3 Call-Up Operation when Interfacing with DoorKing 1816 or 1820 Systems	27
3.2.5 "Tone Open" Sound ON or OFF	27
3.2.6 RS-232 Speed Setting	28
3.2.7 Switch Input Feature	28
3.2.9 Single or Multiple Systems	28
3.2.10 DKS Data over IP Phone Number or System ID Number	28
3.2.11 Re-Program Memory Size, WITHOUT Cards and Anti-Pass Back	29
3.2.12 Re-Program Memory Size, WITHOUT Cards and Anti-Pass Back	29
Overview for System Keypad Programming	30
3.3 General Programming using the System Keypad	31
3.3.1 Relay Strike Time	31
3.3.2 Talk Time	31
3.3.3 Tone Open Numbers	32
3.3.4 Switch Input Relay(s) Activation	32
3.3.5 Touch-Tone / Rotary-Dial	33
3.3.6 Rotary-Dial 9 Relay(s) Activation	33

NOT programmable from Software. System Keypad Programming ONLY

System Keypad Programming when NOT using a PC

TABLE OF CONTENTS

System Keypad Programming when NOT using a PC

3.4 Programming Letters, Numbers and Messages	34
3.4.1 Programming Letters, Numbers from Keypad	35
3.4.2 Programming the User Message	36
3.4.3 Programming the Instruction Message	36
3.5 Programming Phone Numbers and Names	37
3.5.1 Programming the Directory Code Length	38
3.5.2 Programming Directory Codes with 7-Digit Phone Number - NO Area Code	38
3.5.3 Programming Area Codes	39
3.5.4 Programming Directory Codes with Phone Numbers that use Area Codes	39
3.5.5 Programming Names	40
3.5.6 Deleting Individual Phone Numbers	40
3.5.7 Delete Names	40
3.5.8 Delete Area Codes	41
3.5.9 Delete phone Numbers	41
3.5.10 PBX Line Access Code Programming	41
3.5.11 Touch-Tone Dial Pause	41
3.7 Programming Four-Digit Entry Codes	42
3.7.1 Programming Four-Digit Entry Codes	42
3.7.2 Delete Entry Codes	42
3.7.3 Entry Code Ranges	42

SECTION 4 - ADJUSTMENTS 43

4.1 Speaker Volume, Microphone and Feedback	44
4.2 LCD Display Contrast	44
4.3 Back-Lite Cutoff	44
4.4 Master Code Switch	45
4.5 Ring Pin Jumper	45
4.6 Relay 2 Jumper	45
4.7 Auto - 1816 Interface Jumper	45
4.8 HF - HS Jumper	45

SECTION 5 - SYSTEM OPERATING INSTRUCTIONS 46

5.1 Guest Instructions	46
5.2 Resident Instructions	47
5.2.1 Responding to a Guest Call	47
5.2.2 Using an Entry Code	47
5.3 System Administrator	48
5.3.1 Connecting to the Telephone Entry System from a Remote Location	48
5.3.2 Expansion Board Override HOLD OPEN Command	48
5.3.3 Relay Check	48
5.3.4 Time and Date Check	48
5.4 Miscellaneous Operating Instructions	49
5.4.1 Talk Time	49
5.4.2 Telephone Line Sharing	49
5.4.3 Connection to a PBX System	49
5.4.4 Areas with 10-Digit Dialing	49
5.4.5 Control Relays Directly from a PC	49

SECTION 6 - MAINTENANCE 49

6.1 Troubleshooting	50-51
6.1.1 RS-232 Test	52
6.1.2 Automatic Hang-up Options	52
6.1.6 Modem Output Level Adjustment	52
6.1.7 Display DKS Data over IP Phone Number or System ID Number	53
6.1.8 Test Connection to DKS Data over IP	53
6.1.9 Turn DKS Data over IP ON or OFF	53

6.2 Accessories	54
------------------------	-----------

Wiring Schematics 1834	55
-------------------------------	-----------

SECTION 7 - LOG TABLES 56

7.1 Programming Information Tables	56
7.1.1 10 Area Codes	56
7.1.2 255 Area Codes	57-58
7.2 Resident Information Table	59-60

RESIDENT INSTRUCTION SHEET 61

Testing DKS Data over IP

Note: 6.1.3 - 6.1.5 NOT applicable to 1834

Important Notices

FCC – United States

This equipment has been tested and found to comply with the limits for a class A digital device, pursuant to Part 15 of the FCC Rules and Regulations. These limits are designed to provide reasonable protection against harmful interference when the equipment is operated in a commercial environment. This equipment generates, uses, and can radiate radio frequency energy and, if not installed and used in accordance with the instruction manual, may cause harmful interference to radio communications. Operation of this equipment in a residential area is likely to cause harmful interference in which case the user will be required to correct the interference at his own expense.

FCC Registration Number: **DUF6VT-12874-0T-T**

DOC - Canada

The Canadian Department of Communications label identifies certified equipment. This certification means that the equipment meets certain telecommunications network protective, operational, and safety requirements. The Department does not guarantee the equipment will operate to the users satisfaction.

Before installing this equipment, users should ensure that it is permissible to be connected to the facilities of the local telecommunications company. The equipment must also be installed using an acceptable means of connection. The customer should be aware that compliance with the above conditions may not prevent degradation of service in some situations.

Repairs to certified equipment should be made by an authorized Canadian maintenance facility designated by the supplier. Any repairs or alterations made by the user to this equipment, or equipment malfunctions, may give the telecommunications company cause to request the user to disconnect the equipment.

Users should ensure, for their own protection, that the electrical ground connections of the power utility, telephone lines, and internal metallic water pipe system, if present, are connected together. This precaution may be particularly important in rural areas.

CAUTION: Users should not attempt to make such connections themselves, but should contact the appropriate electric inspection authority, or electrician, as appropriate.

DOC Registration Number: **1736 4528 A**

Notice:

The Load Number (LN) assigned to each terminal device denotes the percentage of the total load to be connected to a telephone loop which is used by the device, to prevent overloading. The termination on a loop may consist of any combination of devices subject only to the requirement that the sum of the load numbers of all the devices does not exceed 100.

Notice:

DoorKing does not provide a power transformer on units sold outside of the United States. Use only transformers that are listed by a recognized testing laboratory to power the telephone entry system. **An Inherently Protected Transformer must be used to power this device.** 1833, 1834 and 1835 systems require a 16.5-volt, 20 VA transformer. The model 1837 requires a 16.5-volt, 40 VA transformer.

Listing:

This product has been tested to and found to be in compliance with the UL 294 Safety Standard and Certified to CAN/ULC-S319-05 by Intertek Testing Services NA Inc. (a Nationally Recognized Testing Laboratory) and is ETL listed.

Performance Levels

Destructive Attack:	Level I (Level II with Optional Hood Installed)
Line Security:	Level I
Endurance:	Level IV
Standby Power:	Level I (Level II with 12 VDC, .7 Ah, SLA battery, required for Canadian certification)
Single Point Locking Device with Key Locks:	Level I

Glossary

ACCESS CONTROL SYSTEM: A collection of means, measures and specific practices that when combined, form or compose a systematic approach, which enables an authority to control access to areas and resources in a given physical facility. An access control system, within the field of physical security, is generally seen as the second layer in the security of a physical structure.

ALARM: A condition indicating a state of alert or tamper detection.

ALARM SIGNAL: A transmission of an alarm condition or alarm report.

CONTROLLED AREA: A room, office, building, facility, premises, or grounds to which access is monitored, limited, or controlled.

EQUIPMENT: Any part of an electronic access control system, such as access control units, reader interface modules, access point actuators, access point sensors, keypads, and the like.

PROTECTED AREA: A room, office, building, facility, premise or grounds to which access is monitored, and limited and/or controlled, whereby the authorized person of the Access Control System may grant access to non-authorized persons.

RESTRICTED AREA: A room, office, building, facility, premise or grounds to which access is monitored, and limited and strictly controlled, whereby only the administrator of the Access Control System shall issue credentials that will lead to access.

General Information

- Prior to beginning the installation of the telephone entry system, we suggest that you become familiar with the instructions, illustrations, and wiring guidelines in this manual. This will help insure that you installation is performed in an efficient and professional manner.
- The proper installation of the telephone entry panel is an extremely important and integral part of the overall access control system. Check all local building ordinances and building codes prior to installing this system. Be sure your installation is in compliance with local codes.
- When used to control a door or pedestrian gate, try to locate the telephone entry system as near as possible to the entry point. The unit should be mounted on a rigid wall to prevent excessive shock and vibration from closing doors or gates. Continuous vibration and shock from slamming doors or spring-loaded pedestrian gates will damage the circuit board. **Under no circumstances should the unit be mounted directly to a moving door or gate.**
- **ADA mounting requirements for door control (Ref: ICC/ANSI A117.1-2009).** The requirements below apply **ONLY** when the telephone entry system is being used to control entry through **A PUBLIC DOOR ONLY**. If this system is used to control entry through a **vehicular gate** or **private entrance**, the dimensions noted below **do not apply**.

1. Unobstructed Forward Reach. Where a clear floor or ground space allows only a forward approach to an object and is **unobstructed**, mounting height shall be a minimum of **15 inches** (381 mm), and a maximum of **48 inches** (1.22 m), above the floor or ground to the operable controls.

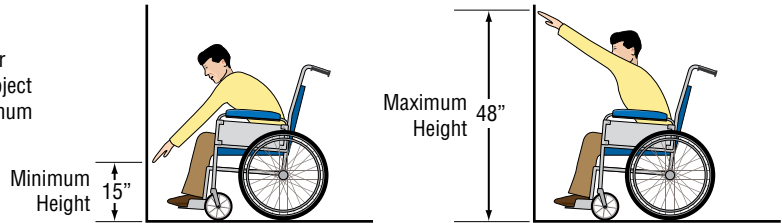

2. OBSTRUCTED HIGH Forward Reach. If the high forward reach is over an obstruction, reach and clearances shall be as shown. **NOTE: If the height of a control is 48" maximum, then the length of the obstruction must be 20" or less. If the height of a control is 44" maximum, then the length of the obstruction may be increased to 25" or less.**

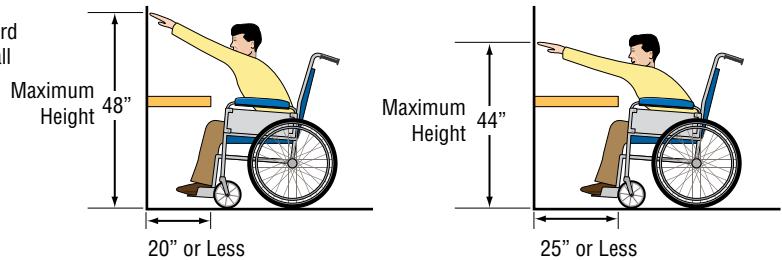

3. Unobstructed Side Reach. Where a clear floor or ground space allows a parallel approach to an object and the side reach is **unobstructed**, and the edge of the clear floor space is **10 inches** (255 mm) maximum from the object, mounting height shall be a minimum of **15 inches** (380 mm), and a maximum of **48 inches** (1.22 m), above the floor or ground to the operable controls.

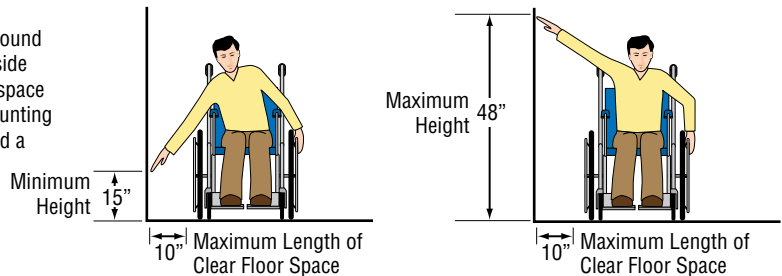

4. OBSTRUCTED HIGH Side Reach. If the side reach is over an obstruction **10 inches or less**, mounting height shall be a maximum of **48 inches** (1.21 m) above the floor or ground to the operable controls. If the side reach is over an obstruction **greater than 10 inches, but less than 24 inches**, mounting height shall be a maximum of **46 inches** (1.17 m) above the floor or ground to the operable controls.

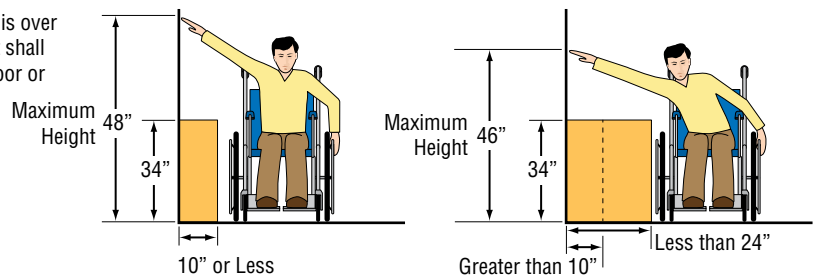

- **When used to control a vehicular gate with an automatic gate operator, the telephone entry system must be mounted a minimum of six (6) feet away from the gate and gate operator, or in such a way that a person cannot operate the entry system and/or touch the gate or gate operator at the same time.**
- Be sure that the system is installed so that it is not directly in the traffic lane. Goose neck mounting post and kiosks work well for these type systems. When planning where to locate the system, take into consideration traffic lane layouts, turn around lanes for rejected access, conduit runs, power availability, etc.
- Environmental factors must also be taken into account. Surface mount units are designed for direct outdoor installations, however it is preferable to protect them from direct exposure to driven rain or snow whenever possible. Flush mount units must be protected from direct exposure to the elements.
- This telephone entry system contains a number of static sensitive components that can be damaged or destroyed by static discharges during installation or use. Discharge any static prior to removing the circuit board from the lobby panel by touching a proper ground device.
- **Instruct the end user to read and follow these instructions. Instruct the end user to never let children play with or operate any access control device. This Owner's Manual is the property of the end user and must be left with them when installation is complete.**

SECTION 1 - INSTALLATION

Prior to installing the telephone entry system, we suggest that you become familiar with the instructions, illustrations, and wiring guidelines in this manual. This will help insure that your installation is performed in an efficient and professional manner.

First you must determine how you would like to connect your telephone entry system for voice and data communication. The method **you choose** is dependent on the type of connection available at the entry system location. There are **THREE types** of connections: (see **Section 2.4 PC (Data) and Voice (Phone) Connection Options** for more information)

- 1 No wired connection** – uses DKS cellular service.
- 2 Network cable connection** – uses **DKS Data over the Internet** or **third party providers** of your own choosing.
- 3 Telephone line connection** – uses **DKS IM Server Modem** or **your own modem**.

Note: After **choosing** your connection type, you may need to **purchase additional equipment** or devices **before** your installation can be completed.

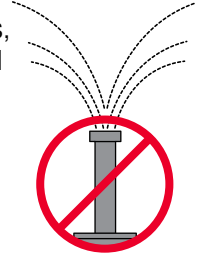

DO NOT install the telephone entry system next to landscape sprinklers or in any area that may expose the system to direct driven water.

1.1 General Installation

There are 2 different styles of the 1834 telephone entry system (Surface and flush mounts), and many different ways to mount them (On a wall, in a wall, attached to a architectural style post, kiosk, etc). Specific models will vary a little from the general installation described in this manual and minor modifications will need to be made depending on which one of the entry system models has been chosen and where it will be mounted. They will **ALL** need power and communication wires run to them in conduit or inside a architectural style post. Feed all of the wires through the back or bottom of the entry system using the existing knock-outs provided in the enclosures. **DO NOT** make any new holes in the enclosure to feed wires through. Keep **ALL** the entry system's wires away from any existing high voltage power wires a minimum of 6" to help prevent any noise and hum pickup in the system's phone line. The system **MUST** also be **properly grounded** to function correctly.

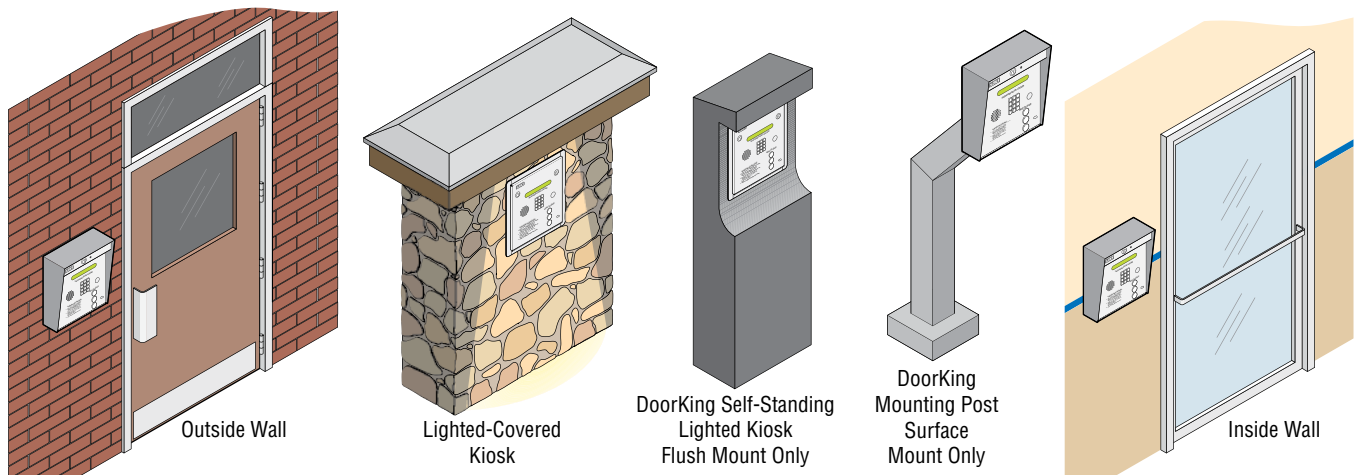

WARNING If this telephone entry system is used to control a vehicular gate with an automatic gate operator, the telephone entry system must be mounted a minimum of six (6) feet away from the gate and gate operator, or in such a way that the user cannot come into contact with the gate or gate operator when using this entry system.

The telephone entry system contains a number of static sensitive components that can be damaged or destroyed by static discharges during installation. **Discharge any static prior to removing the circuit board by touching a proper ground device.** GREAT care must be taken after removing the components from the enclosure to protect them throughout the installation. Carelessness on your part is **NOT** covered under warranty.

Make sure **ALL** dirt, metal or wood debris is removed from inside the enclosure after mounting it. A thorough cleaning of the enclosure is needed before re-installing the components back into the system and wiring it. Any debris left inside could damage the control board and cause the telephone entry system to malfunction during operation.

Included with the system is an extra random keyed cabinet lock. If desired, for added security against unauthorized entry into the system, the standard lock may be replaced with the random lock. Note: DoorKing cannot replace this specific lock or keys if lost.

1.1.1 Remove Components from Enclosure

There are 3 different styles of the 1834 telephone entry system - surface and flush mount. Components in the flush mount will vary a little from this.

1. Disconnect the ribbon cable from the circuit board
2. Remove the two screws from the upper corners of the circuit board.
3. **GENTLY** remove the circuit board by pulling it out of the main terminal.
4. Remove the two screws from the main terminal and remove the ground wire locknut.
5. Remove four locknuts from the faceplate hinge.
6. Remove the faceplate, main terminal (still wired), ribbon cables and the circuit board, store them in a **Safe Place** until they need to be re-installed.

Discharge any static **BEFORE** removing the circuit board by touching a proper ground device.

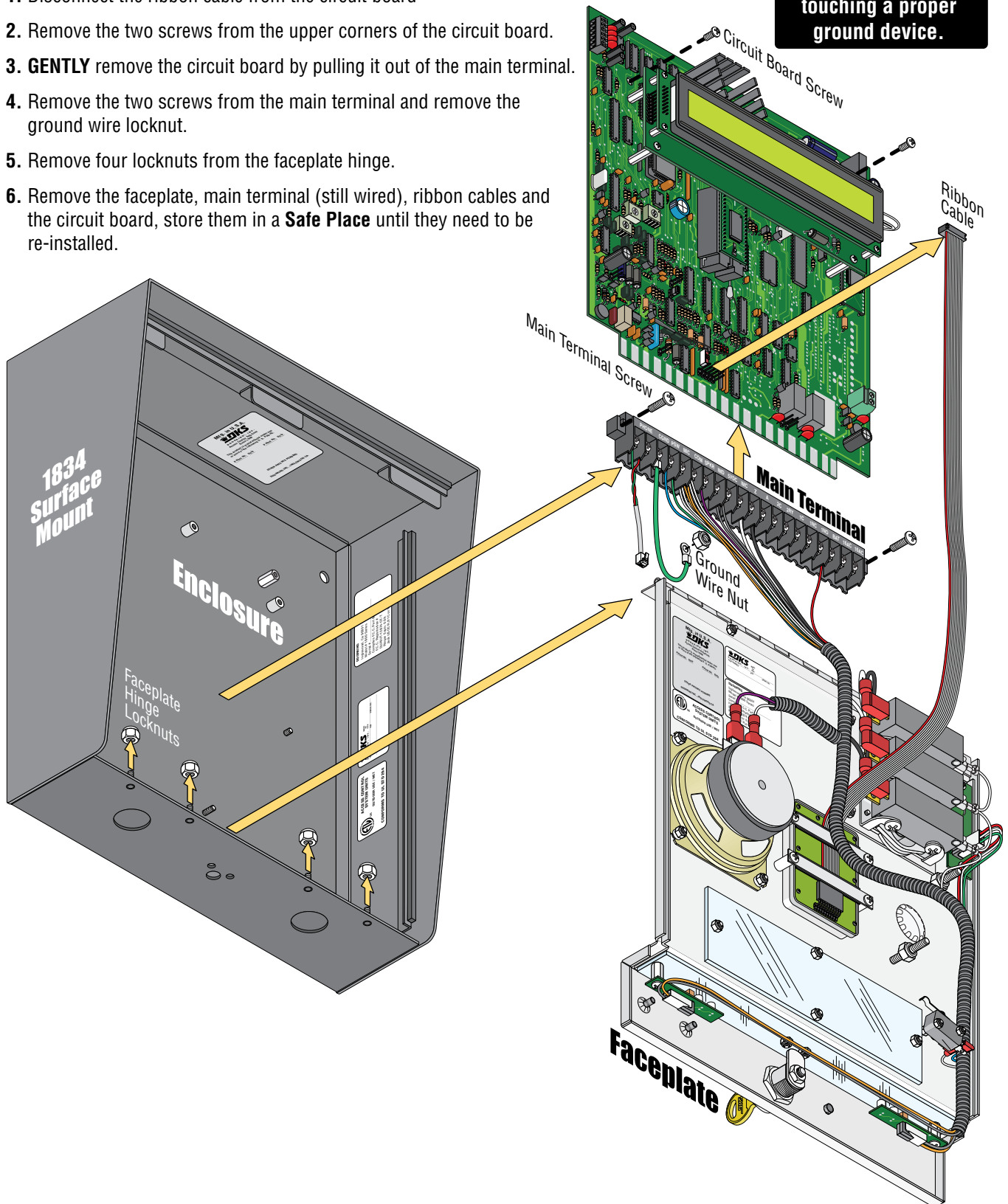

1.1.2 Install Enclosure

There are 2 different styles of the 1834 telephone entry system - surface and flush mount. The illustrations below show typical installations but specific installations can vary from this.

1. Mount the enclosure using the mounting holes provided in the corners (see sections 1.2, 1.3 and 1.4 for your chosen model dimensions including kit installations). Be sure that mounting screws (Not supplied) do not protrude into the enclosure where they could cause a short on the back of the circuit board. Make any necessary conduit connections through the back or bottom of the enclosure using the existing conduit knock-outs. **DO NOT** make any new conduit holes in the enclosure.
2. Route all wiring through conduit or architectural post (not supplied) into enclosure.
3. Clean out the enclosure. Make sure that all dirt, metal and/or wood debris is removed.
4. Re-install components back into the enclosure (Reverse section 1.1.1 steps on previous page). Use the wiring schematics in the back of this manual to help re-install the components if necessary. **DO NOT** apply any power at this time.

Mount to an Architectural Post

There are different styles of DoorKing mounting posts. Surface mount model ONLY.

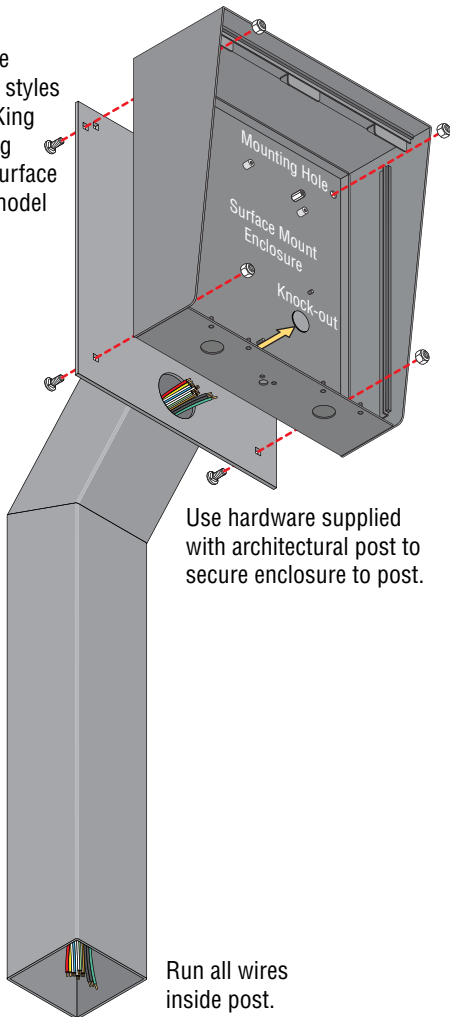

Mount ON a Surface

(See sections 1.2, 1.3.2 and 1.4).

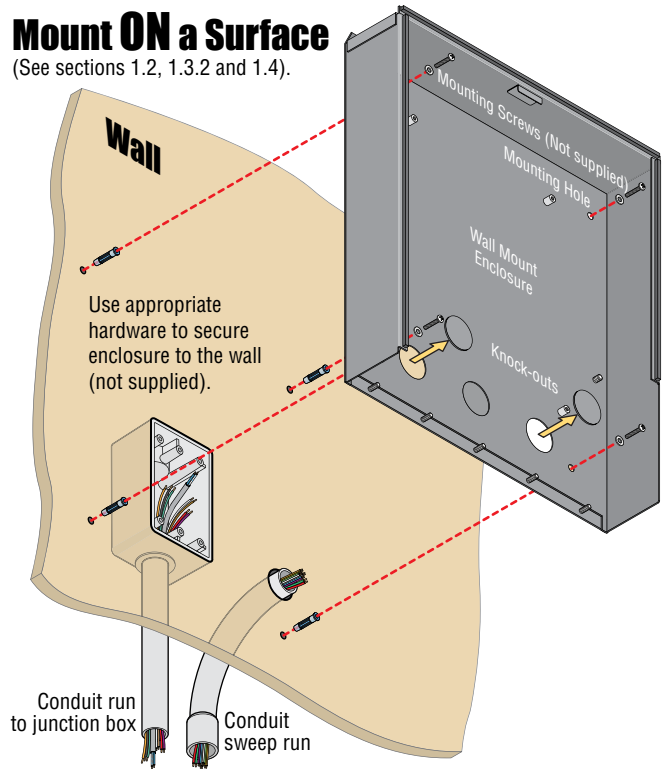

Examples of conduit runs that may be used, depending on how you choose to run the wiring. Some installations will allow the conduit to be run outside the wall and connect to the bottom of the enclosure but this is generally NOT recommended.

Mount IN a Surface

(See sections 1.2.1 and 1.3.1).

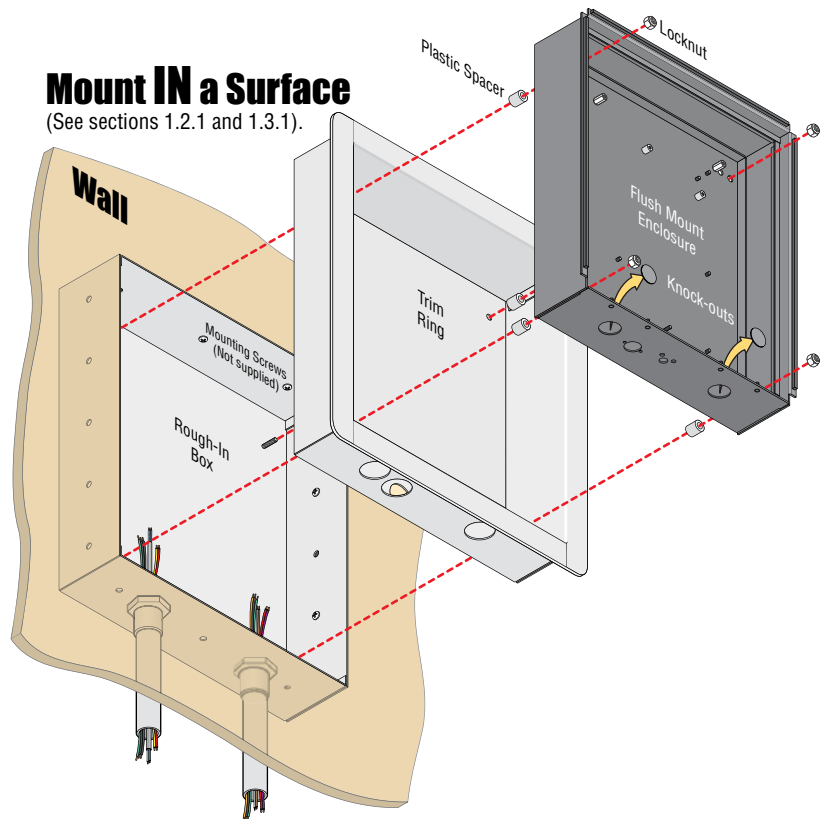

1.2 Surface Mount Dimensions

The Surface mount unit can be mounted directly to a wall, pilaster, post mounted using a DoorKing architectural style mounting post (P/N 1200-037 and 1200-038) or recessed in a wall (see next page) with the surface mount recess kit (P/N 1803-150). Be sure the unit is mounted securely and is not subject to vibration from closing doors or gates.

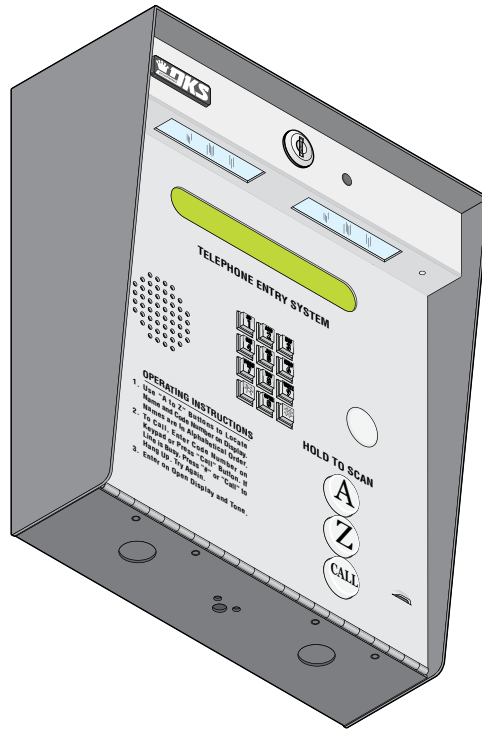

Back View

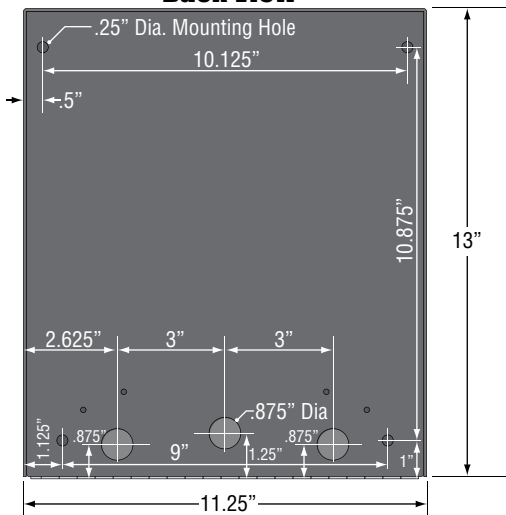

Side View

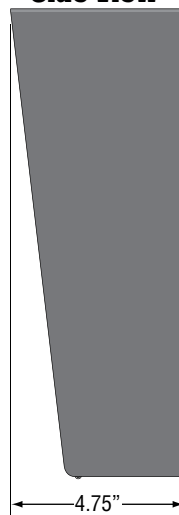

Front View

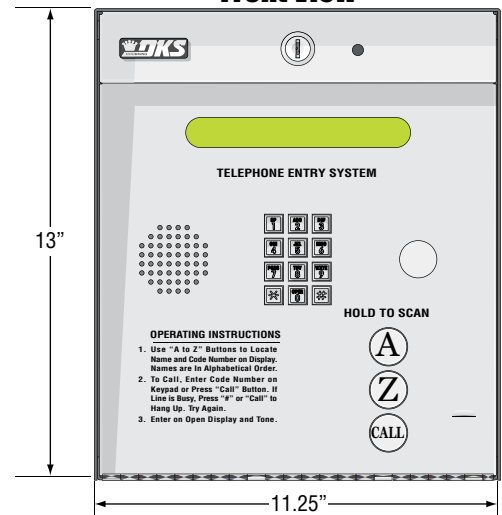

WARNING! If this entry system is used to control a vehicular gate with an automatic gate operator, the entry system must be mounted a minimum of six (6) feet away from the gate and gate operator, or in such a way that a person cannot operate the entry system and touch the gate or gate operator at the same time.

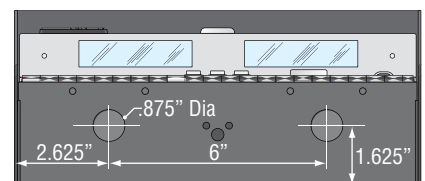

Bottom View

1.2.1 Surface Mount Recess Kit Dimensions and Installation

Surface mount unit can be recessed into a wall or pilaster by using the optional surface mount recess kit (P/N 1803-150). This allows for a recessed telephone entry system to have a lighted keypad which the flush mount units **DO NOT** have. The recess box gets installed in the wall. Use appropriate hardware (not included) to secure the box in the wall. Run all necessary conduit (not included) to the recess box. Slide the enclosure in the recess box and secure it with the hardware included in the kit. Be sure the unit is mounted securely and is not subject to vibration from closing doors or gates.

WARNING! If this entry system is used to control a vehicular gate with an automatic gate operator, the entry system must be mounted a minimum of six (6) feet away from the gate and gate operator, or in such a way that a person cannot operate the entry system and touch the gate or gate operator at the same time.

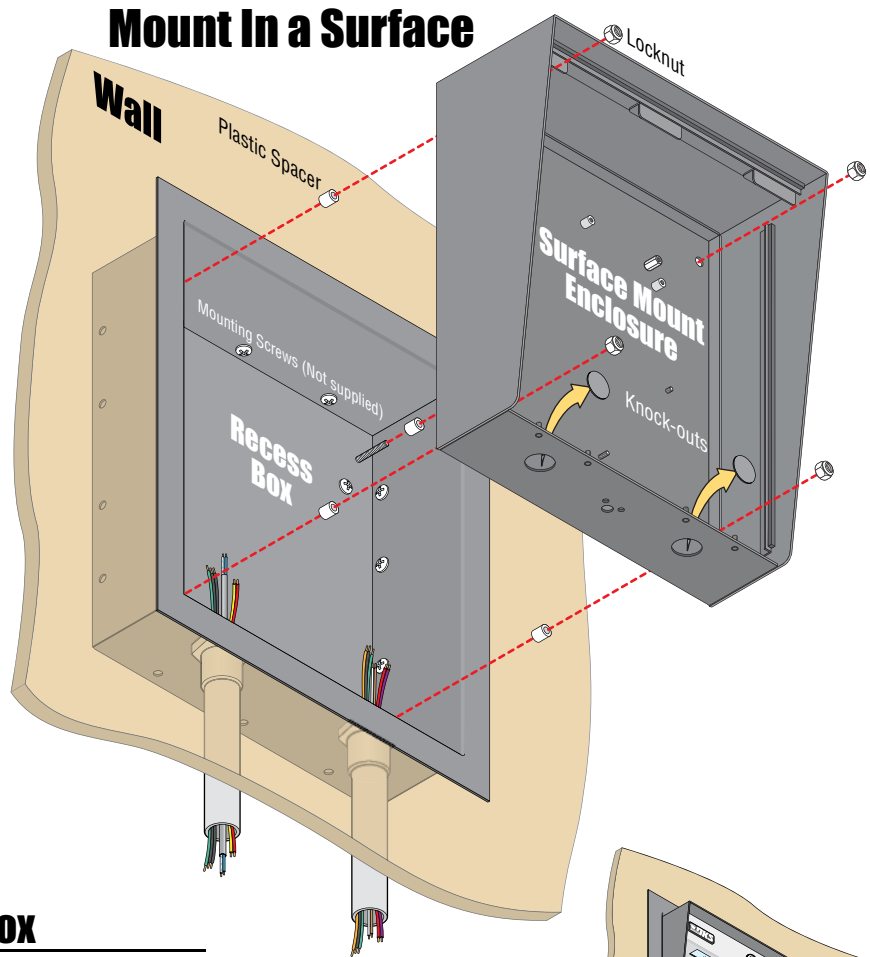

Recess Box

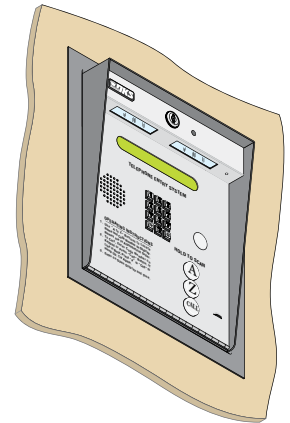
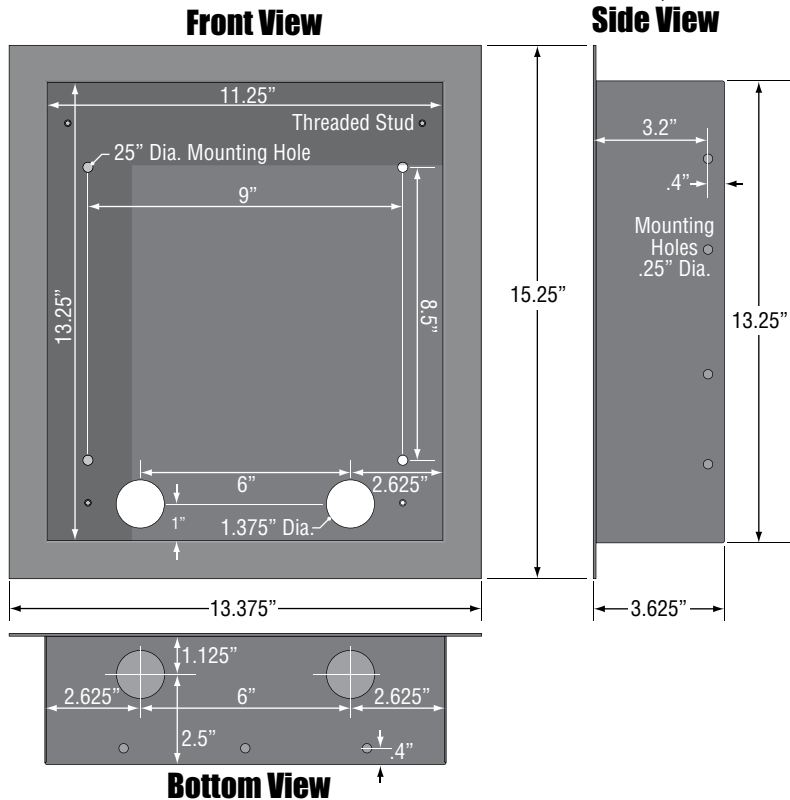

1.3 Flush Mount Dimensions

Flush mount units are installed into a wall with a flush mount kit P/N 1814-165 (stainless) or 1814-166 (gold). Flush mount kits are **NOT INCLUDED** with the flush mount entry system (See next page for flush mount kit dimensions).

DoorKing offers a self-standing lighted kiosk for the flush mount unit ideal for walk-up pedestrian applications P/N 1200-170 (See section 1.3.3 for self-standing kiosk dimensions and installation).

The flush mount units may also be installed on the surface of a wall with a surface mounting kit if desired P/N 1814-152 (silver only). Flush mount surface mounting kits are **NOT INCLUDED** with the flush mount entry system (See section 1.3.2 for flush mount surface mounting kit dimensions).

Flush mount units are installed into a wall/kiosk and can be mounted outside, exposed to the weather. It is preferred that they have limited direct exposure to the weather. We suggest that when they are mounted outdoors, it is in a covered protected area. Be sure the unit is mounted securely and is not subject to vibration from closing doors or gates.

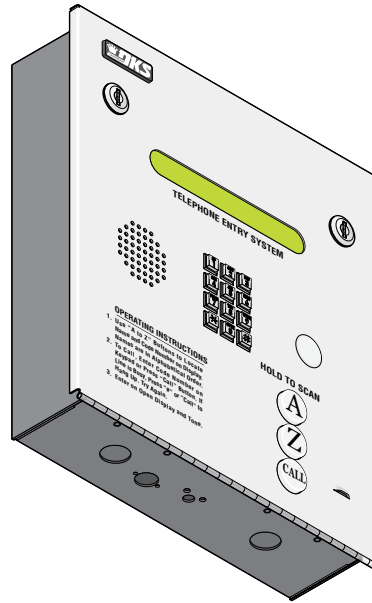

Back View

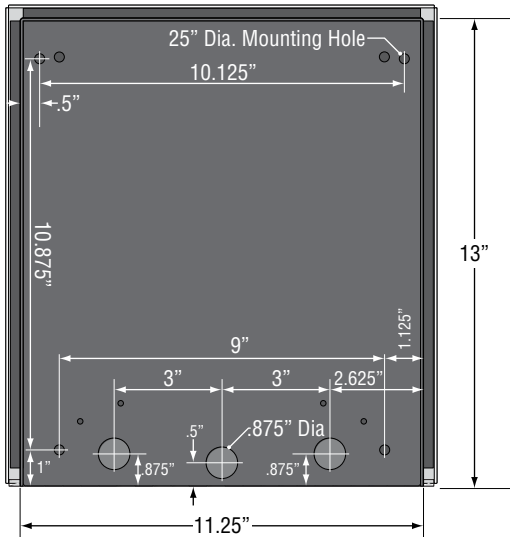

Side View

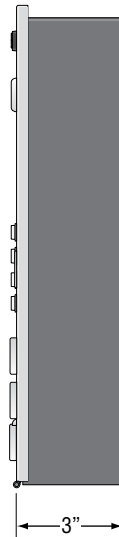

Front View

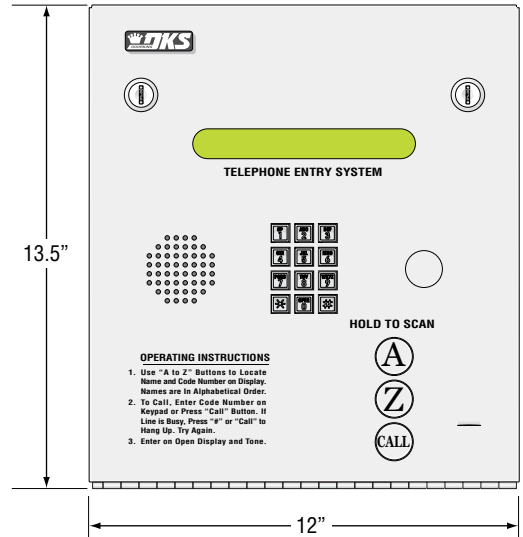

Bottom View

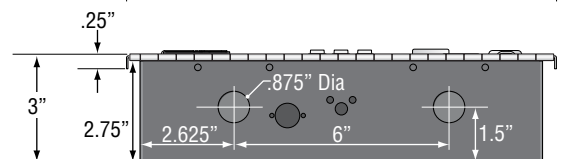

WARNING! If this entry system is used to control a vehicular gate with an automatic gate operator, the entry system must be mounted a minimum of six (6) feet away from the gate and gate operator, or in such a way that a person cannot operate the entry system and touch the gate or gate operator at the same time.

1.3.1 Flush Mount Kit Dimensions and Installation

The Flush mount installation kit has two parts; the rough-in box and the trim ring. The rough-in box is installed in the wall first. Use appropriate hardware (not included) to secure the box in the wall. Run all necessary conduit (not included) to rough-in box. Slide the trim ring into the rough-in box. Slide the enclosure in the trim ring and secure them all together with the hardware included in the kit. Be sure the unit is mounted securely and is not subject to vibration from closing doors or gates. See previous page for flush mount enclosure dimensions.

WARNING! If this entry system is used to control a vehicular gate with an automatic gate operator, the entry system must be mounted a minimum of six (6) feet away from the gate and gate operator, or in such a way that a person cannot operate the entry system and touch the gate or gate operator at the same time.

Mount In a Surface

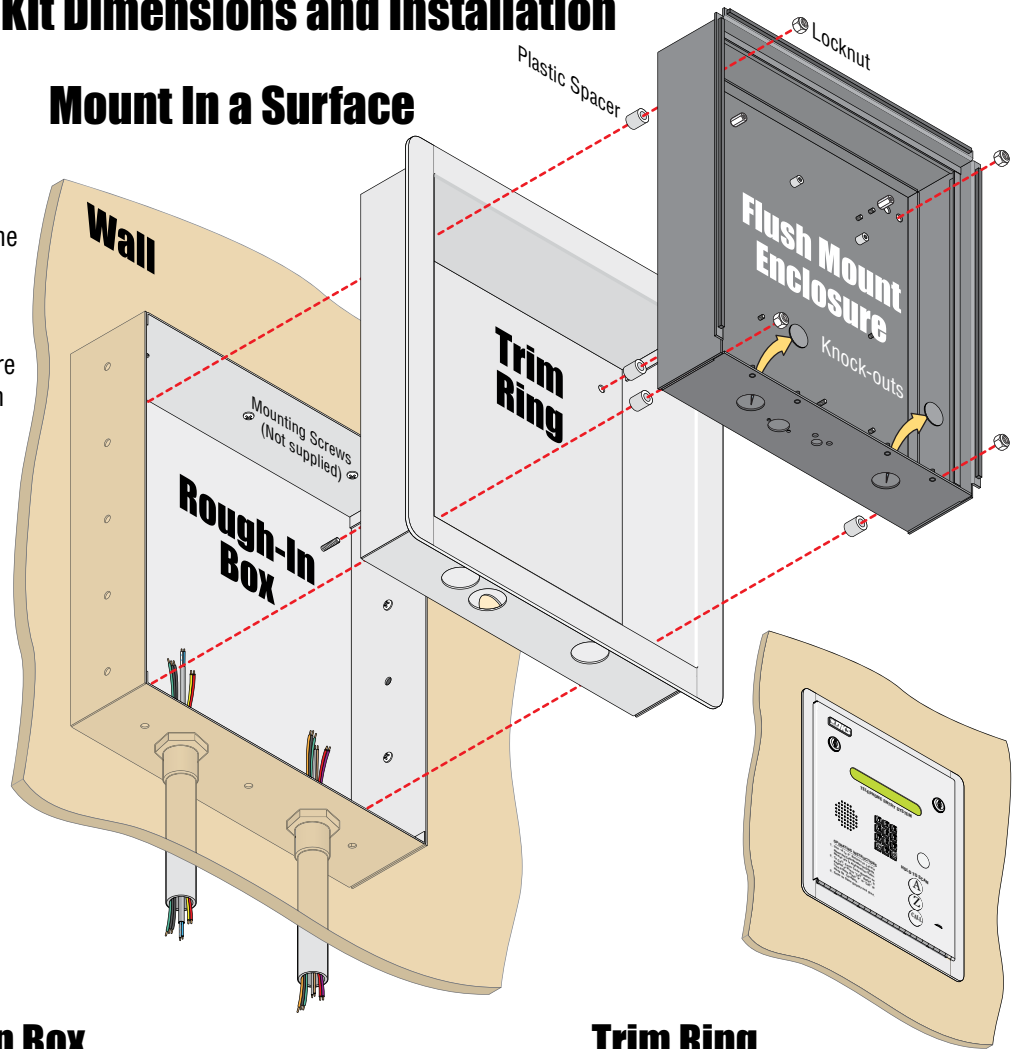

Rough-In Box

Trim Ring

Side View

Front View

Front View

Side View

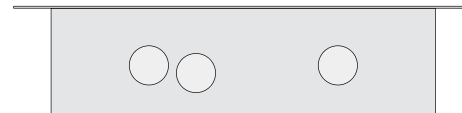
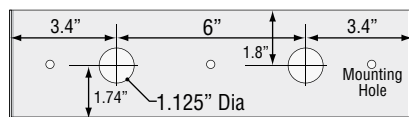
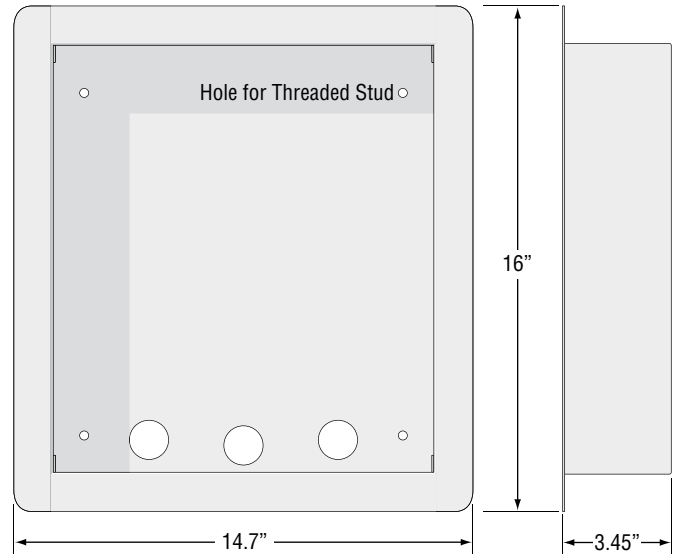
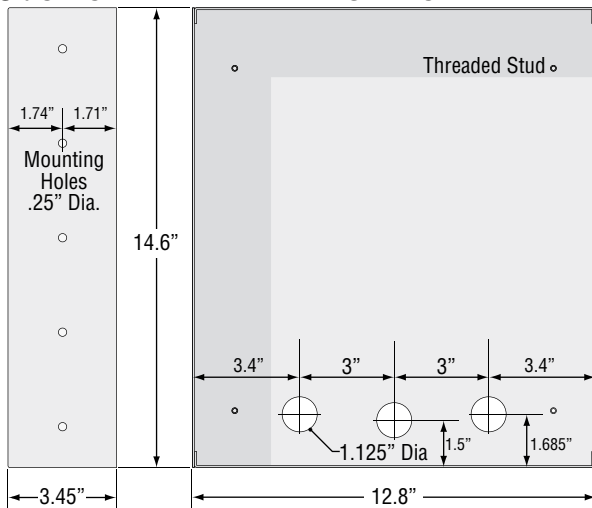

Bottom View

Bottom View

1.3.2 Flush Mount Surface Mounting Kit Dimensions and Installation

The Flush mount unit (See page 10 for flush mount enclosure dimensions) can be mounted **ON** a wall or pilaster and **NOT IN** the wall by using the optional flush mount surface mounting kit (P/N 1814-152). This is useful when cutting a large hole into a wall or pilaster would be very difficult (marble or granite for example). The flush mount surface mounting kit is a trim ring that fits around the flush mount enclosure. The enclosure and trim ring get installed directly on the wall using appropriate hardware (not included) after running all necessary conduit to the enclosure. Be sure the unit is mounted securely and is not subject to vibration from closing doors or gates

Mount On a Surface

Examples of some small holes in the wall that may be needed, depending on how you choose to run the wiring.

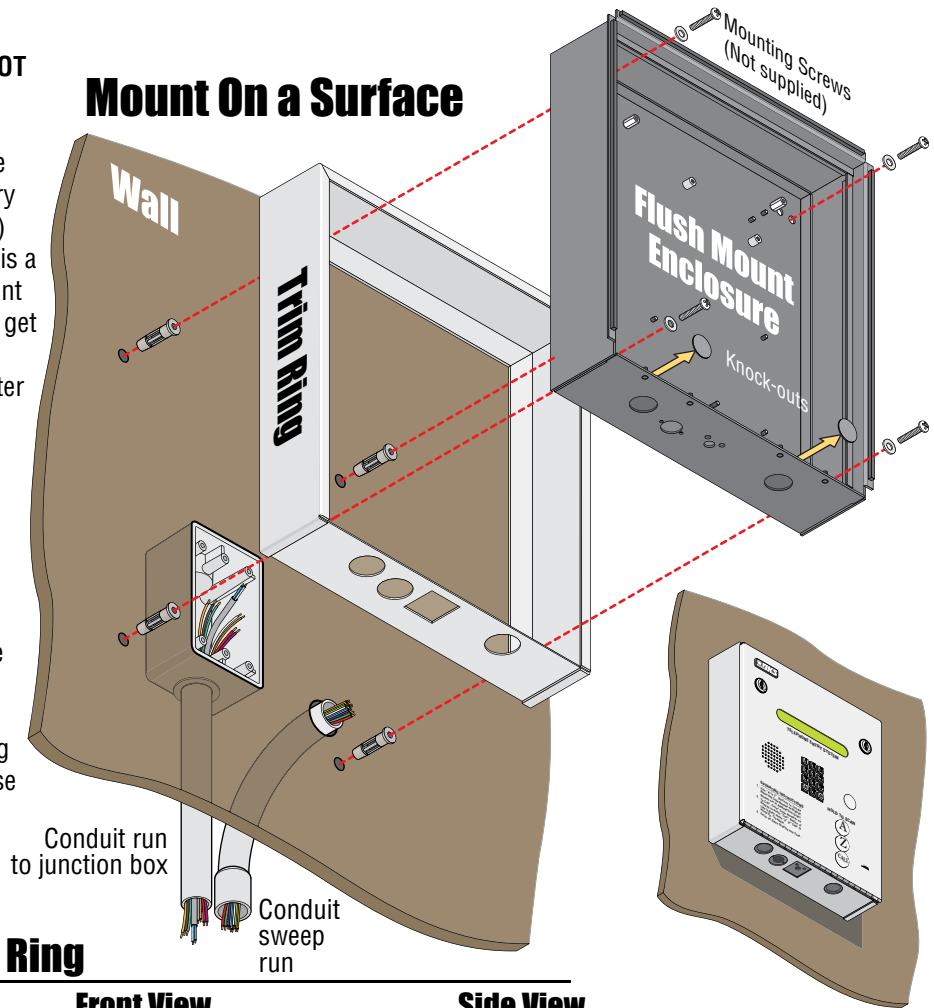

Trim Ring

Front View

Side View

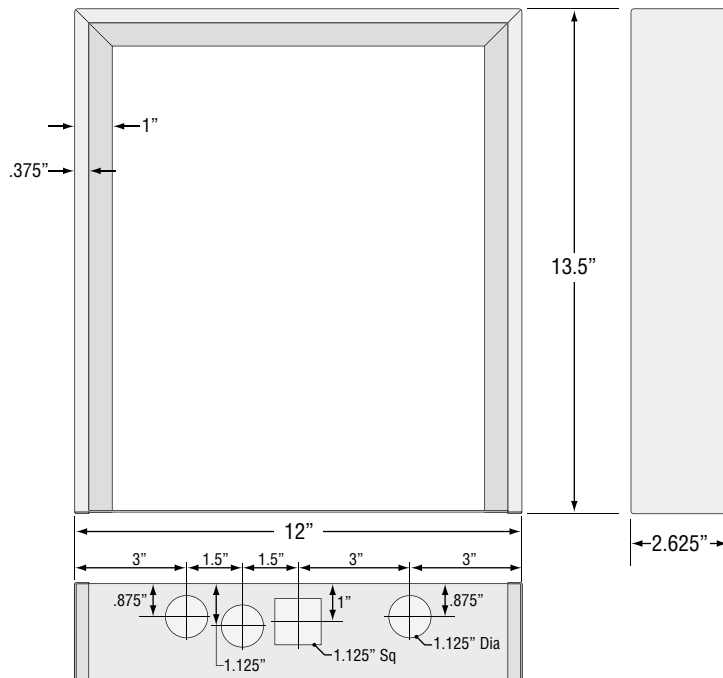

Bottom View

WARNING! If this entry system is used to control a vehicular gate with an automatic gate operator, the entry system must be mounted a minimum of six (6) feet away from the gate and gate operator, or in such a way that a person cannot operate the entry system and touch the gate or gate operator at the same time.

1.3.3 Self-Standing Lighted Kiosk Dimensions and Installation

The flush mount kit (Sold separately) is installed into the self-standing kiosk (P/N 1200-170) to secure the flush mounts units **ONLY** in place. Secure the rough-in box in the kiosk. Run all necessary wires to rough-in box. Slide the trim ring into the rough-in box. Slide the enclosure in the trim ring and secure them all together with hardware included in the kit.

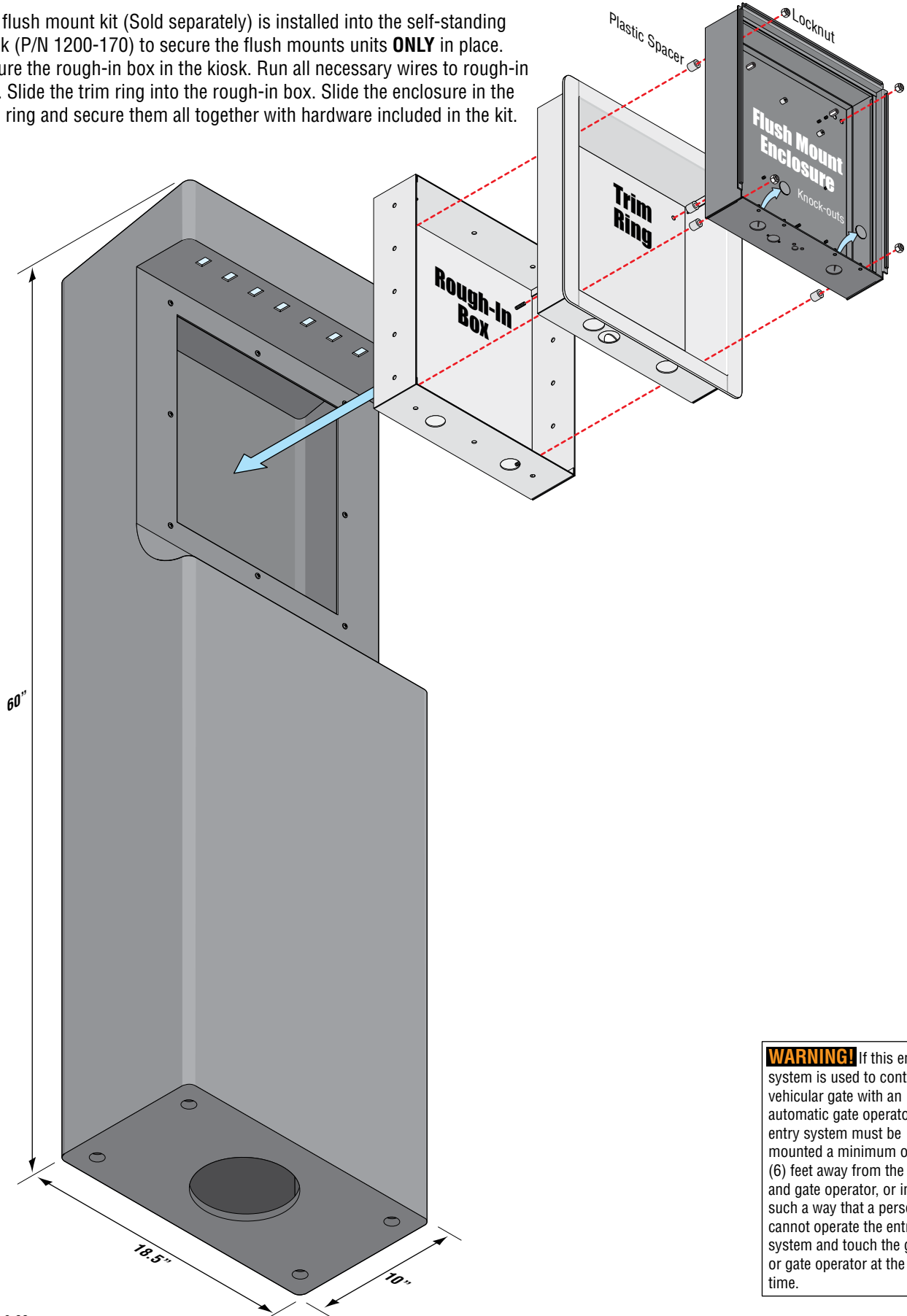

WARNING! If this entry system is used to control a vehicular gate with an automatic gate operator, the entry system must be mounted a minimum of six (6) feet away from the gate and gate operator, or in such a way that a person cannot operate the entry system and touch the gate or gate operator at the same time.

1.4 Wall Mount (Discontinued) Dimensions

The Wall mount unit (Discontinued) is designed to be mounted directly onto a wall without the need of cutting a large hole as is necessary with flush mount units. It can be mounted outdoors using a DoorKing architectural style mounting post (P/N 1200-037 and 1200-038) or in a lighted-covered kiosk for example. Be sure the unit is mounted securely and is not subject to vibration from closing doors or gates.

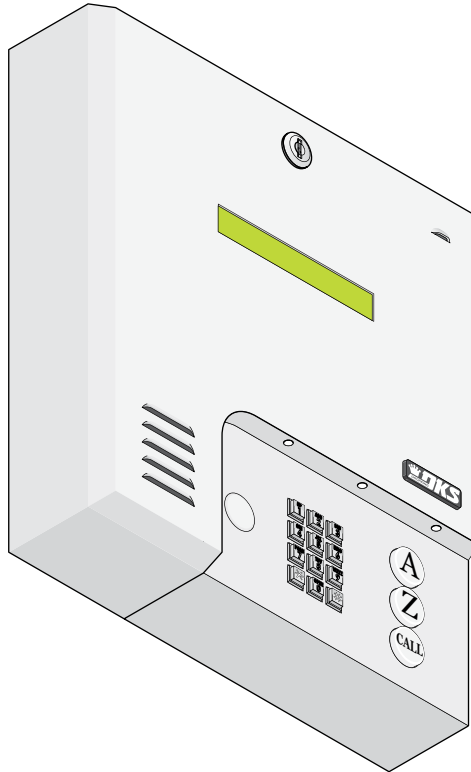

Back View

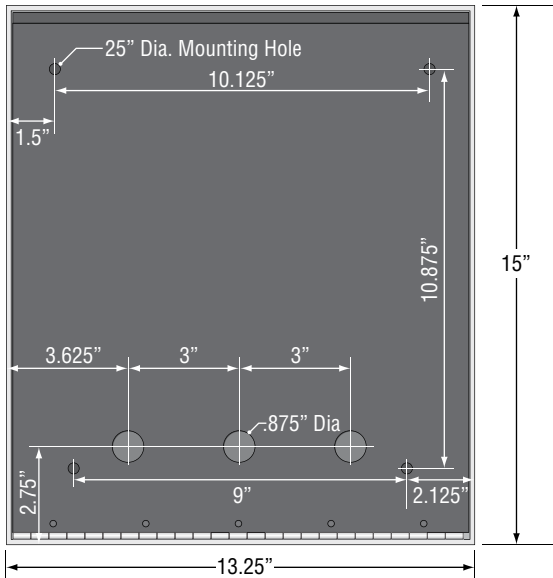

Side View



Front View

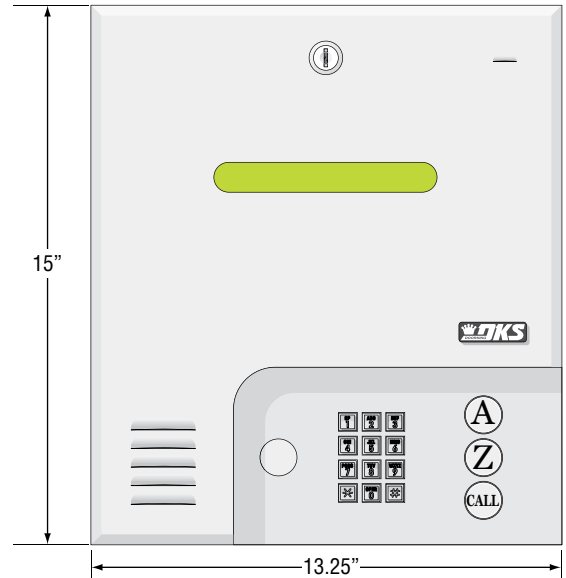

Bottom View

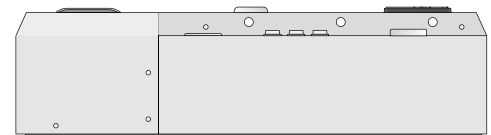

1.5 Memory Chip Replacement

The 1834 entry system is shipped with the memory chip already installed in the unit. However, if you need to replace the memory chip in the NEW 1834 entry system or replace the memory chip in an OLDER 1834, follow the instructions below.

⚠ CAUTION

DO NOT install the memory chip with power to the telephone entry system turned ON. Attempting to install the memory chip with power on will **irrevocably damage** the chip. The memory chip is a static sensitive component. **Discharge any static electricity from your hands by touching a proper ground device before touching the control board.** Handle the memory chip with care, the pins can bend easily.

DO NOT install the memory chip UPSIDE-DOWN (Arrow MUST point UP). Installing chip upside-down will cause **permanent damage** to the chip.

1834 Circuit Board

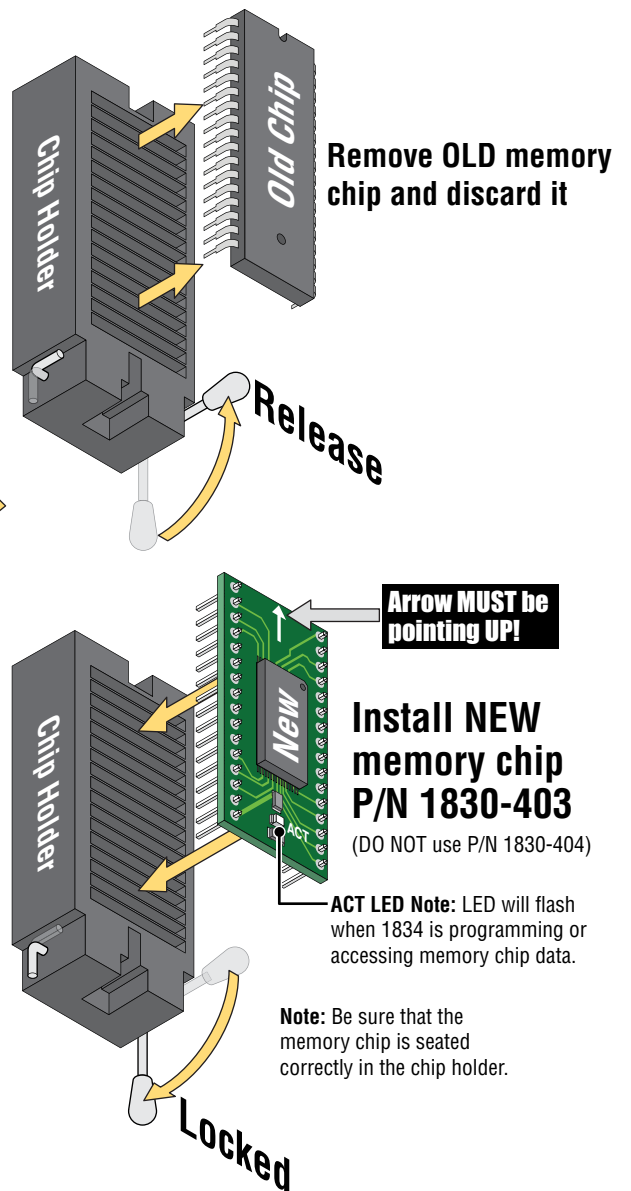
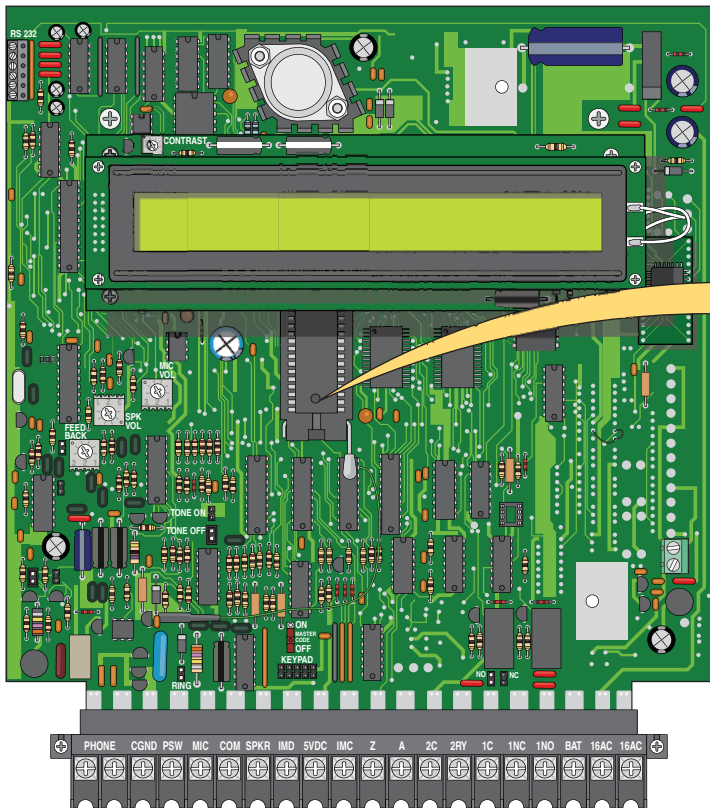

1.6 Postal Lock Installation

At some locations, such as gated communities, it will be necessary to **provide access to the mail carrier** so that they can deliver the mail. Mail carrier access will be provided by the installation of an **Arrow Postal Lock**. This is the same lock that the Post Office uses for gang mailboxes. **These locks are not available to the public.** The installer or the building owner/manager will have to call the Post Office and arrange for the installation of this lock into the telephone entry system. All DoorKing commercial telephone entry systems are designed to accept installation of the postal lock.

Prior to installation of the postal lock, be sure power to the telephone entry system is **turned OFF**.

1. Remove the hole plug on the faceplate of the telephone entry system.
2. Cut the wire tie wrapped around the switch **ONLY** when installing postal lock.
3. Remove the two hex nuts from the postal lock-mounting studs. Mount postal lock on the studs and secure with the hex nuts.

When the lock is installed, the pawl of the lock, in the **extended position** is **depressing the switch**. When the mail carrier inserts his key and turns the postal lock, the pawl is **withdrawn into the lock** and the switch will activate the relay for the programmed strike time, that has been programmed for this feature.

Factory default settings for the Postal Lock Switch: After the key has been turned, **Relay 1** will activate (section 3.3.4) for **One (1) second** of strike time (section 3.3.1). The switch input feature (section 3.2.7) is factory set to “activate a relay” and not “dial a phone number”.

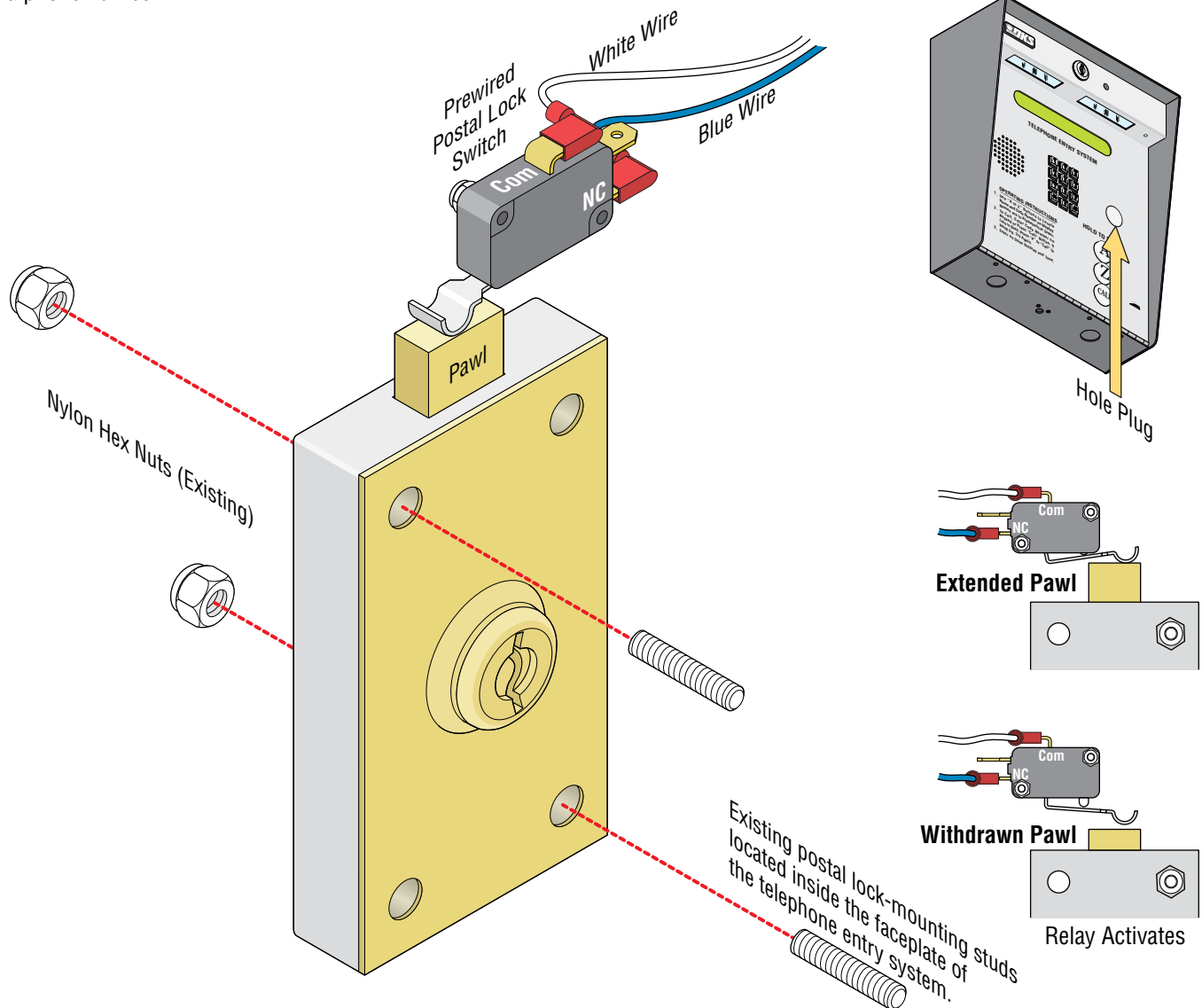

SECTION 2 - WIRING

Prior to installing wiring to the telephone entry system, we suggest that you become familiar with the instructions, illustrations, and wiring guidelines in this manual. This will help insure that you installation is performed in an efficient and professional manner.

The wiring of the telephone entry panel is an extremely important and integral part of the overall access control system. Use proper wire for the communication line, power wires, and be sure that the system is properly grounded. Check all local building ordinances and building codes prior to installing this system. Be sure your installation is in compliance with local codes.

Telcom Access Standards. It is not permissible for customers to use the telcom network lead-in cable to provide the intercom function between the gate and the house. New Zealand Customers: All door and gate entry systems wiring must comply with PTC106: March 2008, Section 9.

WARNING If this telephone entry system is used to control a vehicular gate with an automatic gate operator, the telephone entry system must be mounted a minimum of six (6) feet away from the gate and gate operator, or in such a way that the user cannot come into contact with the gate or gate operator when using this entry system. If this unit has been installed closer to the automated vehicular gate, do not proceed with any wiring until the unit has been moved and re-installed so that it is in compliance with these instructions.

This telephone entry system contains a number of static sensitive components that can be damaged or destroyed by static discharges during installation or use. **Discharge any static prior to removing the circuit board from the enclosure by touching a proper ground device.**

2.1 Wiring Guidelines

PERMANENT WIRING MUST BE EMPLOYED AS REQUIRED BY LOCAL ELECTRICAL CODES. ALWAYS ADHERE TO THE LOCAL AND NATIONAL ELECTRICAL CODE SPECIFICATIONS WHEN WIRING THE TELEPHONE ENTRY SYSTEM/ACCESS CONTROLLER AND OTHER ACCESS CONTROL DEVICES.

2.1.1 Power

Use only the two (2) supplied transformers (or UL listed equivalent) to power the telephone entry system (16.5 VAC, 20 VA).

DO NOT power any other devices (electric strikes, magnetic locks etc.) from these power transformers.

Note: Transformers are not supplied on units sold outside the United States. An Inherently Protected Transformer must be used to power this device. Use only transformers that are listed by a recognized testing laboratory to power the telephone entry system.

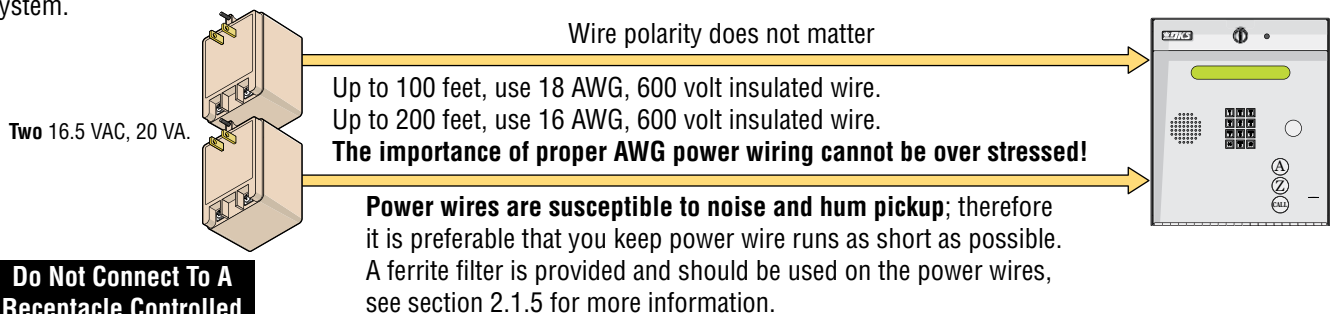

Do Not Connect To A Receptacle Controlled By A Switch.

“Optional” 12 volt .8 amp hour gel-cell batteries (DoorKing P/N 1801-008) can be installed to **provide stand-by power in the event of a power outage.** Two batteries are required, one for the system power and one for the auxiliary terminal power.

2.1.2 Wire Runs

Be sure that you use proper wire that has an insulation rated for an underground environment. **All wires should be placed in conduits.** Proper pre-planning can greatly ease the installation and wiring of this system. Always check with the local building code to determine the type of wire required in your municipality.

DO NOT run high voltage (115 V) power lines and low voltage/communication lines in the same conduit. These should be in separate conduits at least six (6) inches apart. Be sure that all phone line wiring is twisted and completely isolated from ground.

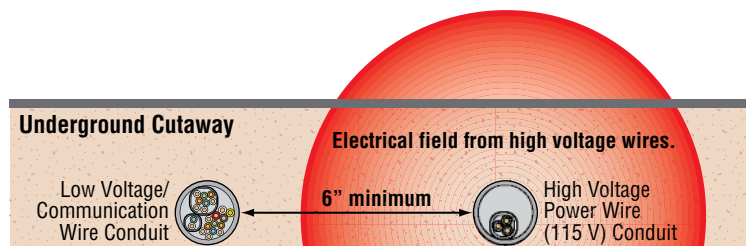

2.1.3 Grounding

Proper grounding of this system is a requirement. To be effective, ground connections should be made with a minimum 12 AWG, 600 volt insulated wire to a ground point within 10 feet of the telephone entry system. The ground point must be at an electrical panel, a metallic cold water pipe that runs in the earth, or a stainless steel grounding rod driven at least ten (10) feet into the soil. **A architectural style mounting post anchored to concrete does NOT make a good ground.**

Some Acceptable Ground Sources

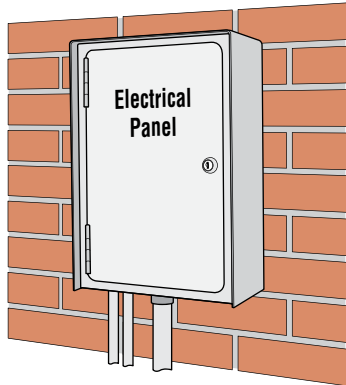

Ground to an existing electrical system.

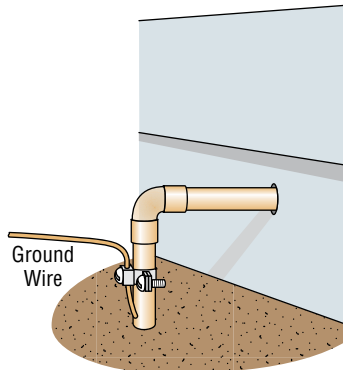

Ground to a metallic cold water pipe.

IMPORTANT: Ground wire shown without safety protection for clarity. Make sure ground wire is protected from being touched or electrical shock could occur!

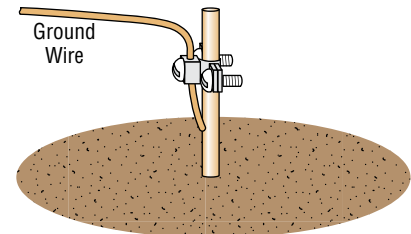

Grounding rod 10 feet in soil.

2.1.4 Surge Suppression

The use of surge suppressors can significantly reduce the chance of component failure because of static charges or surges. DoorKing recommends installing a **Phone Line** surge suppressor (DoorKing P/N 1877-010 or equivalent) and two **Low Voltage** surge suppressors (DoorKing P/N 1878-010 or equivalent) to help protect the entry system from power surges.

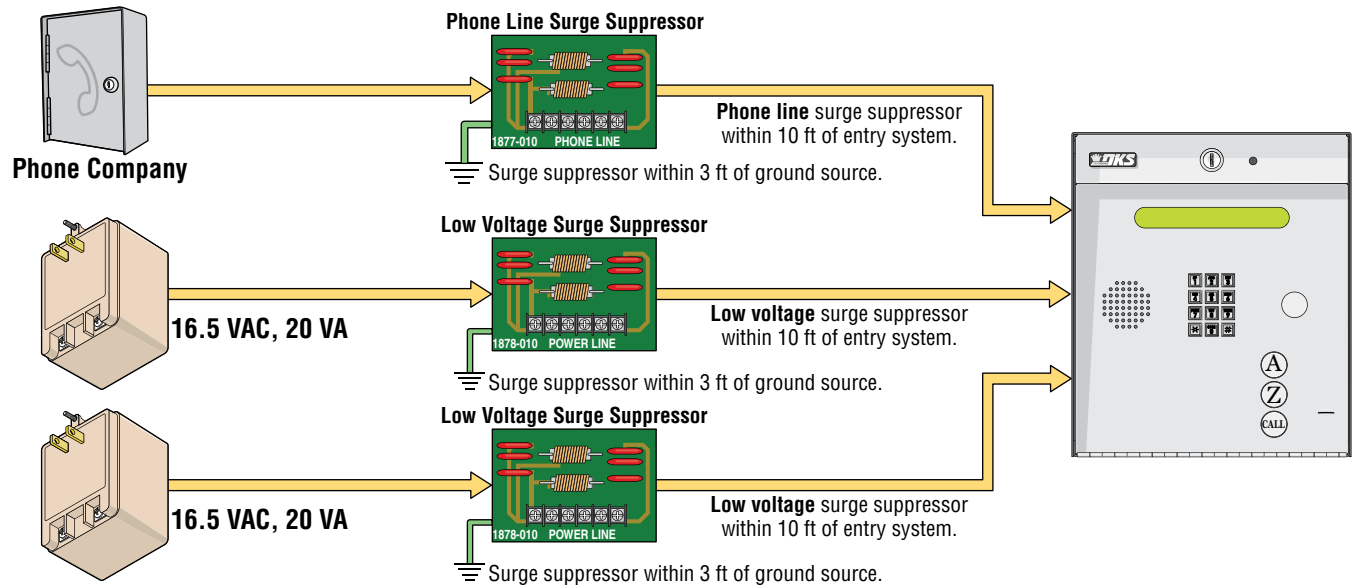

2.1.5 Ferrite Filter

The Telephone Entry System comes with a **Ferrite Filter**. This will help prevent noise and hum pickup in the phone lines. Install around the 16 VAC power wires on the main terminal #19 and #20 and the Aux. terminal.

To install the ferrite filter, release the clip on the side to open the filter, place the wires in the circular core and snap the filter closed.

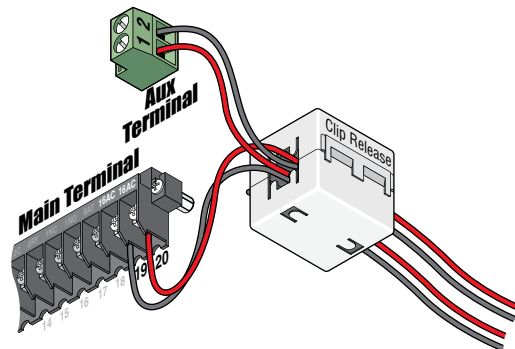

2.2 Terminal Descriptions

RS-232 Terminal Removable

- 1 Transmit Data
- 2 Receive Data
- 3 Request to Send
- 4 Clear to Send
- 5 Signal Ground - Shell
- 6 Not used

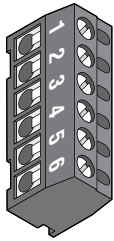

Note: The 6-pin terminal can be removed for easy wiring. Connects a PC (See Section 2.5.1).

Aux Terminal Non-Removable

- 2 16.5 VAC Input Power – 20 VA.
- 1 16.5 VAC Input Power – 20 VA. (Powers RS-232)

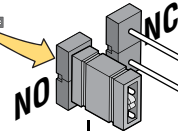
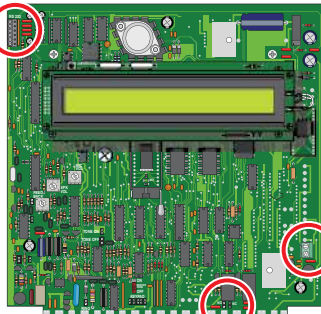
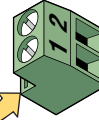

Relay 2 Note: Normally Open and Normally Closed relay jumper is used to set **Relay 2** input on the circuit board (See section 4.6).

Main Terminal

Terminal	Description
1	Phone Line Connection
2	Phone Line Connection
3	Earth Ground Only (See Section 2.1.3).
4	Switch Input. A closure between terminals 4 and 6 will cause the designated relay(s) to activate for the programmed strike time or dial a phone number – see 3.2.7. The Postal Switch is connected here.
5	Microphone Input.
6	Common for switch input #4, microphone, speaker, AZ & CALL buttons and battery neg.
7	Speaker Output.
8	(Not used).
9	5 VDC Power for LED lighting.
10	(Not used).
11	“Z” Button Input.
12	“A” Button Input.
13	Relay 2 Common – 30 Volt, 3 Amp max.
14	Relay 2 Contact – 30 Volt, 3 Amp max.
15	Relay 1 Common – 30 Volt, 3 Amp max.
16	Relay 1 Normally Closed – 30 Volt, 3 Amp max.
17	Relay 1 Normally Open – 30 Volt, 3 Amp max.
18	Standby Battery POSITIVE For Phone System Only (12 VDC, .7 Ah, SLA) (connect negative to terminal 6)
19	16 VAC Input Power
20	16 VAC Input Power

100 ft. max. with 18 AWG wire.
200 ft. max. with 16 AWG wire.
16.5 VAC, 20 VA

2.3 Telephone Entry System Wiring

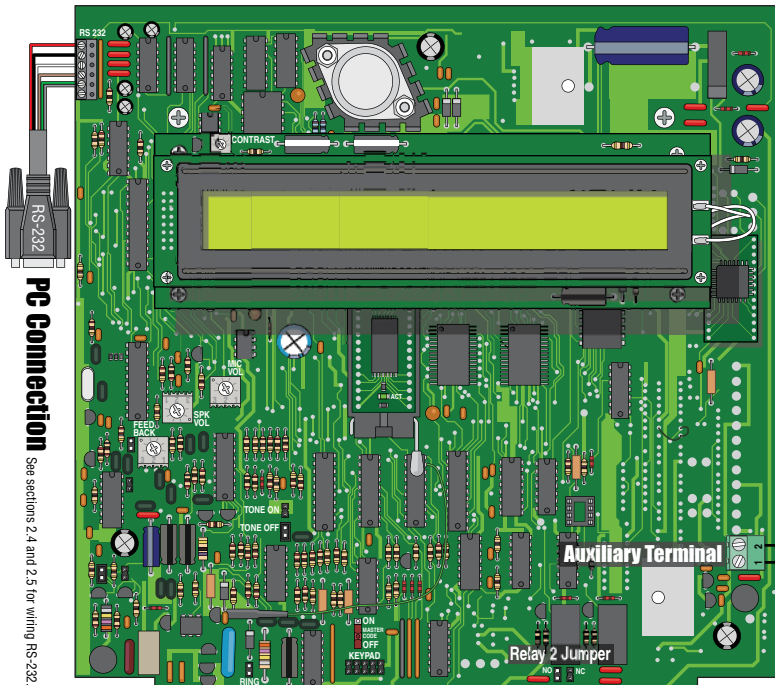

PC Connection
See sections 2.4 and 2.5 for wiring RS-232.

Type of wiring to be used on ALL external devices:
A) Type CL2, CL2P, CL2R, or CL2X.
B) Other cable with equivalent or better electrical, mechanical, and flammability ratings.

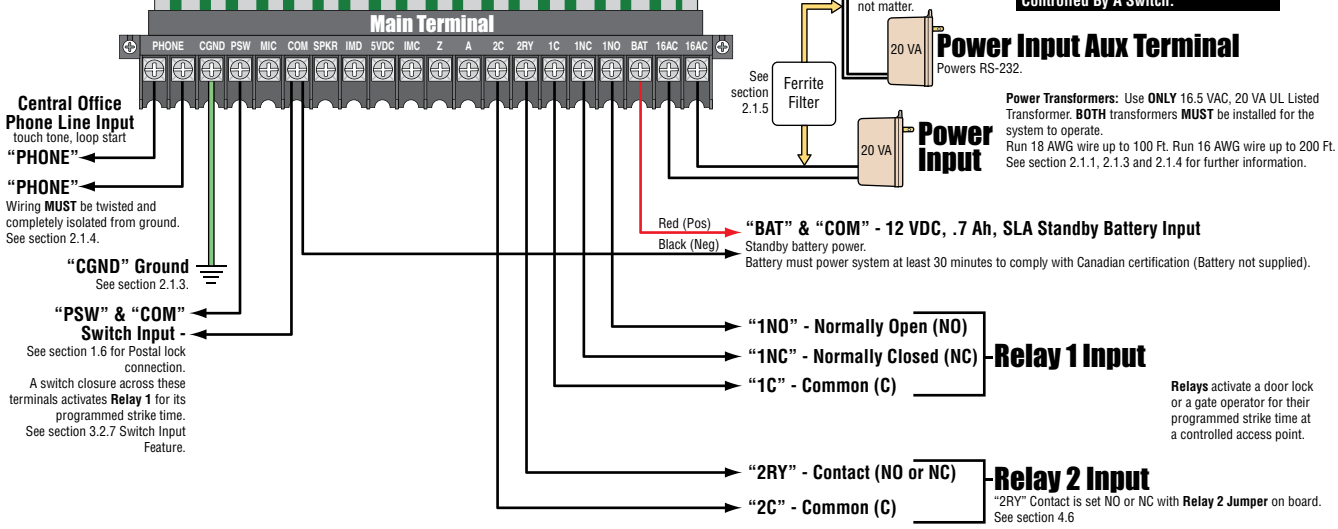

Do Not Connect Power To A Receptacle Controlled By A Switch.

Power Input Aux Terminal



Power Transformers: Use ONLY 16.5 VAC, 20 VA UL Listed Transformer. BOTH transformers MUST be installed for the system to operate. Run 18 AWG wire up to 100 Ft. Run 16 AWG wire up to 200 Ft. See section 2.1.1, 2.1.3 and 2.1.4 for further information.

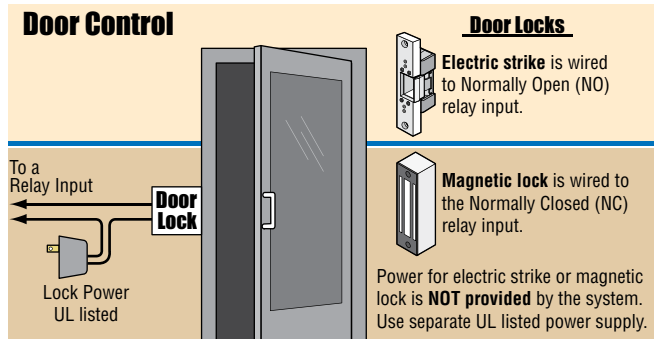
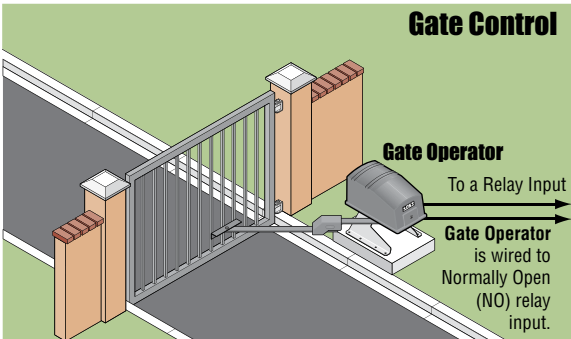

2.4 PC (Data) and Phone (Voice) Connection Options

There are **THREE ways** to connect to the telephone entry system for voice and data transfer (programming). The method that you choose is dependent on the type of connection available at the entry system.

1 No wired connection available – use DKS cellular service.

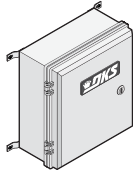

DoorKing Cellular Service (see 2.4.1):
Use P/N 1800-080 for Data and Voice Connection.

DKS Software setting: DKS Cellular

2 Network cable available – use DKS Data over the Internet or use third party providers of your own choosing.



DoorKing VoIP/RS-232 Control Box (see 2.4.2a):
Use P/N 2334-080. DKS VoIP Connection (Voice)
AND RS-232 for Data Connection.

DKS Software setting: DKS VoIP Voice + Data



DoorKing Data over IP Service (see 2.4.2b):
Use P/N 1815-568 for DKS VoIP Connection (Voice).
Use P/N 1830-186 for Data Connection.

DKS Software setting: DKS VoIP Voice + Data

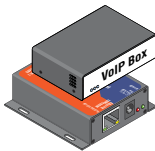

Third Party Service (see 2.4.2c):
Use **Third Party VoIP** Connection (Voice).
Use P/N 1830-185 for Data Connection.

DKS Software setting: Network

3 Telephone line available – use DKS IM Server Modem or use your own modem.

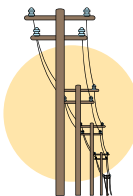

DKS IM Server Modem Service (see 2.4.3a):
Use **IM Server Modem** for Data Connection.
Use Telephone line for Voice Connection.

DKS Software setting: IM Server Modem

Third Party Service (see 2.4.3b):
User supplied modem for Data Connection.
Use Telephone line for Voice Connection.

DKS Software setting: Modem to Modem

2.4.1 DoorKing Cellular Network Connection - Voice/Data Transfer

Requires VOICE/DATA Cellular System kit (P/N 1800-080). Manage 2 (two) entry systems through DoorKing's cellular network server where cellular service is available.

DoorKing Cellular service is available for one low monthly fee without any long term contracts. Cellular service is provided by AT&T 4G LTE where available.

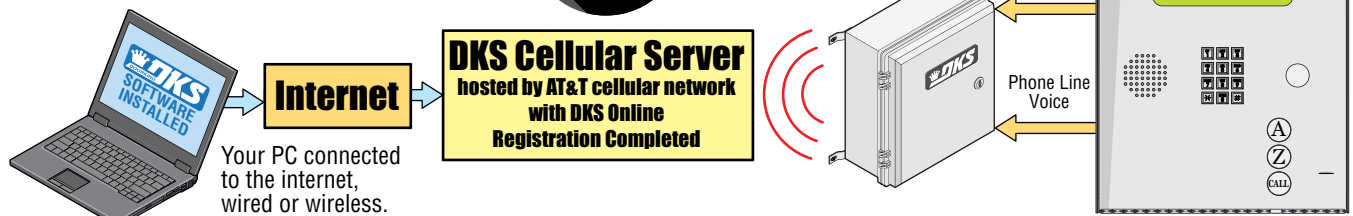

See instruction sheet that comes with VOICE/DATA cellular system kit for further information on wiring and online registration.

2.4.2a DoorKing VoIP/RS-232 Control Box - Voice/Data Transfer

Requires DKS VoIP/RS-232 Control Box P/N 2334-080. Works with DoorKing's Data over IP through the internet.

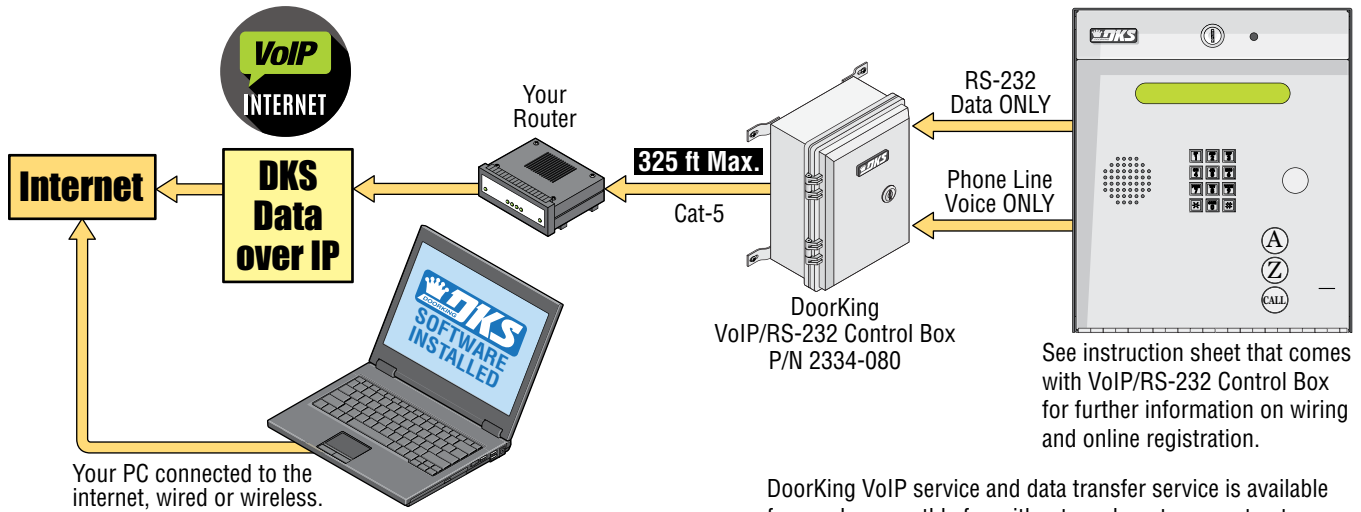

DoorKing VoIP service and data transfer service is available for one low monthly fee without any long term contracts.

2.4.2b DoorKing VoIP Internet Connection - Voice/Data Transfer

Requires a DKS TCP/IP Converter Kit P/N 1830-186 and VoIP Adapter Kit P/N 1815-568. Works with DoorKing's Data over IP through the internet.

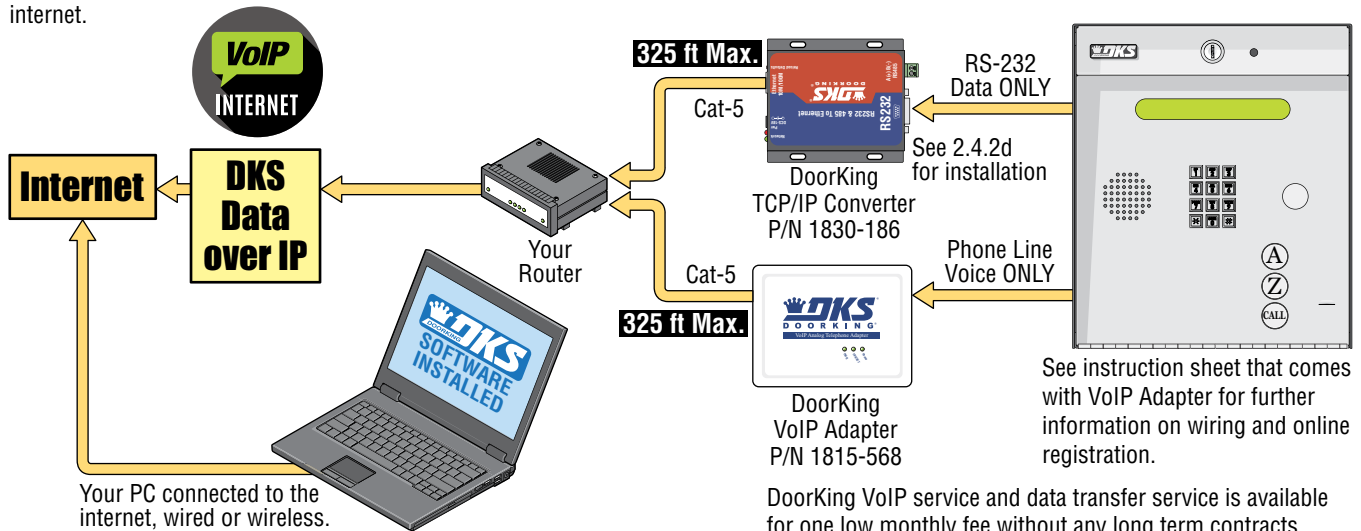

DoorKing VoIP service and data transfer service is available for one low monthly fee without any long term contracts.

2.4.2c Third Party VoIP Internet Connection - Voice/Data Transfer

Requires a DKS TCP/IP Converter Kit (Third Party) P/N 1830-185 and Your VoIP Adapter (most VoIP adapters will work).

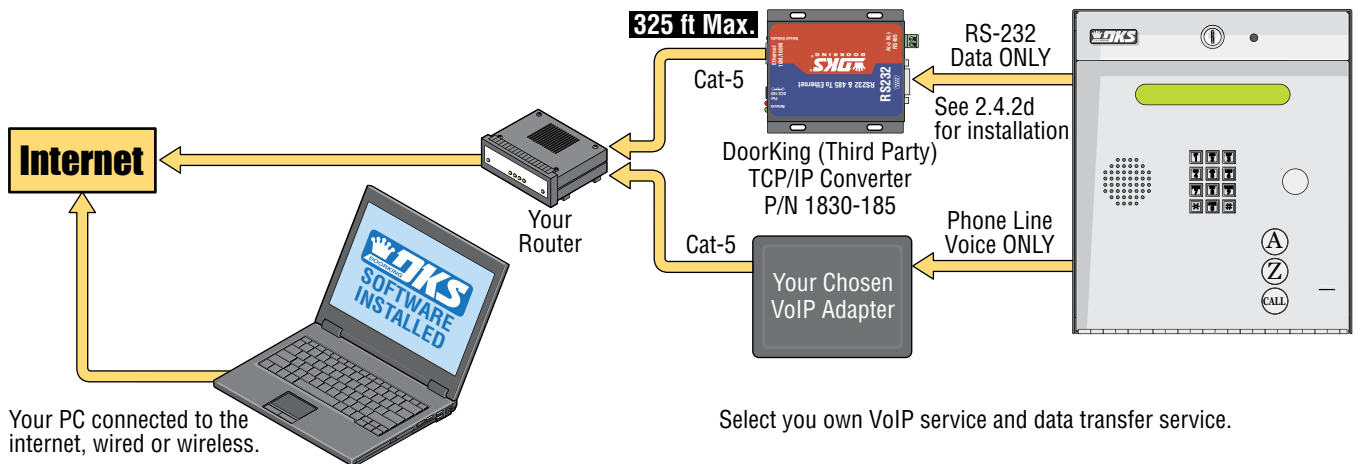

Telephone Line Preparation and Useful Information

Order your telephone line to be installed at least two weeks prior to the planned telephone entry system installation date. This will assure that a phone line is available when the unit is installed. The telephone company will require the following information from you:

DoorKing does not recommend using a POTS line for programming. DoorKing can no longer guarantee modem connections as some phone company services and switches no longer support modem communications since these devices are considered to be obsolete technology. The telephone line must support G.711 level service for the modem to work. Modem communications will not work over cellular or VoIP connections.

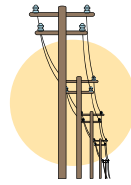

Type: Touch Tone, Loop Start
Ringer Equivalence: 0.0 A
Jack Type: RJ11C
FCC Registration (US): DUF6VT-12874-OT-T
DOC (Canada): 1736 4528 A

2.4.3a DoorKing IM Server Modem Connection - Voice/Data Transfer

NO additional hardware required. Works with DoorKing's IM Server modem over the internet. See section above for useful information.

DoorKing Voice and data transfer service is available for one low monthly fee without any long term contracts.

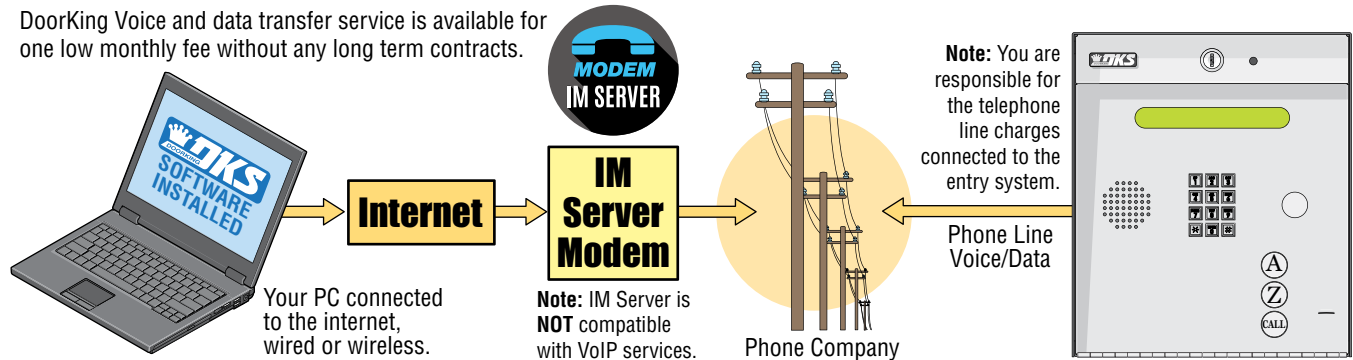

- Utilizes the POTS (Plain Old Telephone Service) copper line connected to the telephone entry system to provide data transfer to the DKS telephone entry system via the internet connection at programming computer.
- Voice communication is provided over the POTS line. This service is useful if your programming PC does not have a modem, or if your modem cannot communicate with the entry system modem. **Note:** DoorKing does not recommend using a POTS line for programming. DoorKing can no longer guarantee modem connections as some phone company services and switches no longer support modem communications since these devices are considered to be obsolete technology. The telephone line must support G.711 level service for the modem to work. Modem communications will not work over cellular or VoIP connections.
- Monthly fees depend on the number of residents in the system database.
- DoorKing maintains the right to determine excessive usage (data transfers) at any time and may require you to reduce your usage (data transfers). Failure to comply may result in service termination.
- User is responsible for all phone company charges including local and long distance charges, taxes and other fees for this line.

Note: Not applicable if Cable or Fiber is a cloud based telephone service.

Caller ID: You may want to order **caller ID blocking** from the telephone company for the entry system phone line. Without caller ID blocking, residents with the proper phone equipment **WILL BE ABLE** to identify the telephone number that the telephone entry system is installed on. This may or **MAY NOT** be desirable.

Call Waiting: Residents may order call waiting from their local telephone company **AFTER** the system has been installed. They can avoid missing calls coming from the telephone entry system while they are using their phone (No busy signal).

2.4.3b Dial-Up Phone Modem Connection - Voice/Data Transfer

Use your EXISTING phone modem to connect your PC to the entry system.

Note: Telephone companies will **NOT** support this phone line connection to a telephone entry system **after 2020**.

DoorKing does NOT guarantee modem connections.

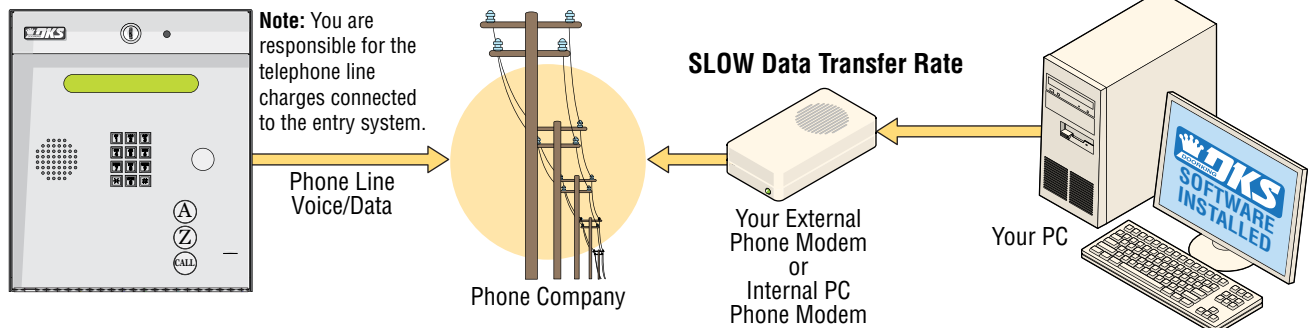

Note: In some cases, digital phone service (VoIP for example) may negatively affect modem service.

2.5 Direct Connection to PC Options - Data Transfer ONLY

2.5.1 RS-232 Direct Connection to PC - Data Transfer ONLY

Requires DoorKing RS-232 9-pin cable P/N 1818-040 and RS-232 to USB Adapter P/N 1815-037 to connect to a PC.

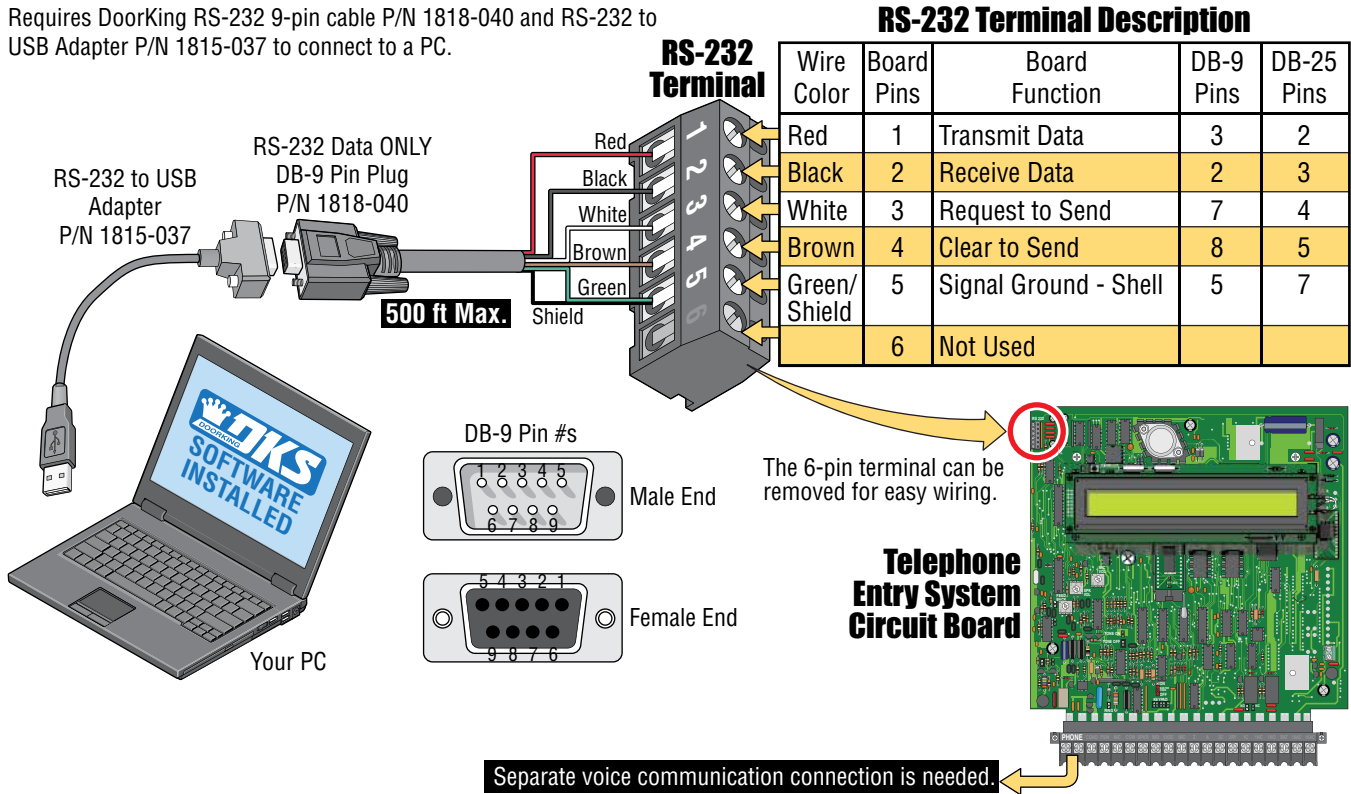

2.5.2 RS-422/USB Direct Connection to PC - Data Transfer ONLY

Requires RS-422 adapter kit (P/N 1508-055).

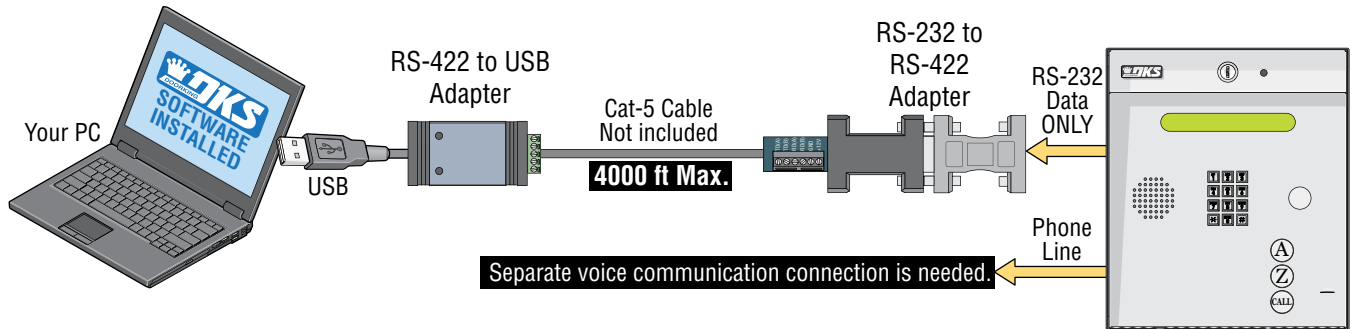

2.5.3 TCP/IP Converter Direct Connection to PC - Data Transfer ONLY

Requires TCP/IP Converter Kit (P/N 1830-185).

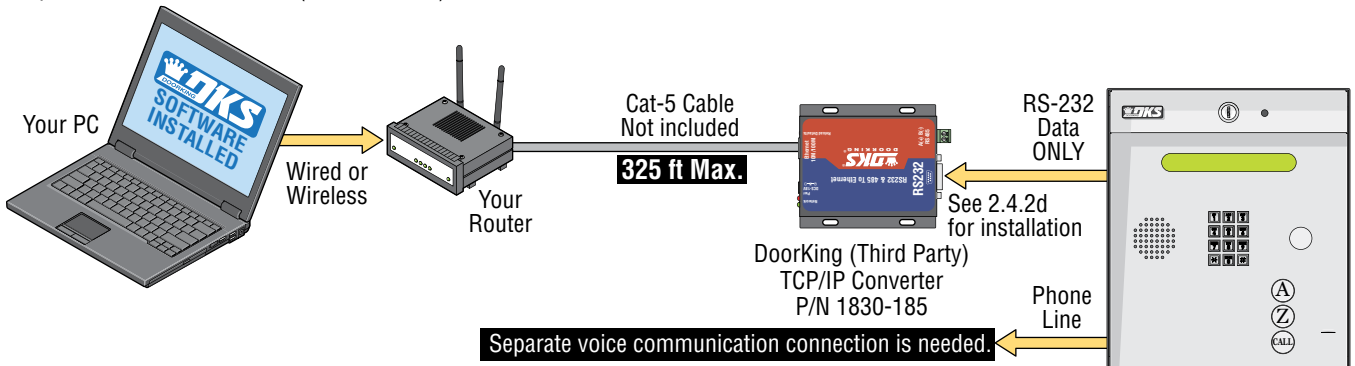

SECTION 3 - PROGRAMMING

We strongly suggest that you read these programming instructions in their entirety before beginning any programming of this telephone entry system.

IMPORTANT! Many of the advanced features available with this telephone entry system **CANNOT** be programmed from the system keypad. These advanced features include relay hold open time zones, security levels, elevator control options and programming via the internet using DKS servers. If any of these advanced features are used, the system **MUST** be programmed with a PC using the **DoorKing Remote Account Manager for Windows** software, VERSION 6.4.b or higher. Refer to the software help screen for more information on these advanced features.

3.1 General Programming Information

The DoorKing PC Programmable Telephone Entry System is primarily programmed by using the DoorKing Remote Account Manager for Windows software. However, the system can also be partially programmed from the keypad on the front of the entry system.

Programming the entry system can also be performed off-site using a user supplied PC with the DKS software loaded on it. Make sure the **RING** pin jumper is in place on the circuit board, which was factory installed. See section 4.5 for more information.

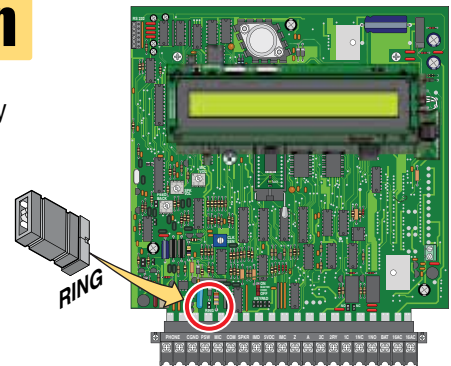

The PC programmable telephone entry system has two relays on the circuit board, all of which are programmable for any function required. These relays are designated as Relay 1 (R 1), and Relay 2 (R 2).

3.1.1 Programming from a PC

Prior to programming the system with a PC and the DoorKing Remote Account Manager for Windows Software, there is certain information that you must know and must program into the system before the computer can communicate with the system. See section 3.2 to set-up the telephone entry system for PC programming. See sections 2.4 and 2.5 PC Connection Options for all layouts and **additional hardware** that is needed for each. **All options require the DoorKing Remote Account Manager for Windows Software VERSION 6.4.b or higher.**

3.1.2 Programming from the Telephone Entry System Keypad

Follow the programming instructions as described in each section of this manual. The system will prompt you with short tones (**beep**) when programming steps have been followed correctly, and with a long tone (**beeeeeep**) when the programming step is ended. The LCD display will also assist you in viewing the information that you are programming. It is highly recommended that you complete the resident information in section 7 in back of this manual prior to programming from the system keypad. This will provide you with the information needed to complete the manual programming sequence (section 3.2). When programming from the system keypad, after each programming step is performed correctly, a short tone (**beep**) will be heard. When the programming session is ended, a long tone (**beeeeeep**) will be heard.

Important Note: Relay hold open time zones and holiday schedules features **CANNOT** be programmed from the system keypad. **These advanced features can only be programmed from a PC using the DoorKing Remote Account Manager Software.**



3.2 Set-up Telephone Entry System for PC Programming

Prior to using a PC to program this PC Programmable Telephone Entry System with the DoorKing Remote Account Manager for Windows software, the programming steps in section 3.2 factory settings **MUST** be reviewed or re-programmed if necessary (most factory settings are typically desired). There is no need to re-program these settings unless you want to change them. For easy reference, refer to the chart on page 30 that list the various programming functions and their factory default settings.

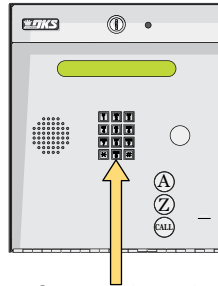
Section 3.2 can ONLY be programmed from the System Keypad. There is NO programming sequence in the Remote Account Manager Software to program these features.



System Keypad





Important Note: If you make a mistake while programming, press   keys at the same time to escape from programming no matter how much has been completed, then begin again at step 1.

3.2.1 Master Code

This programming step sets the system **MASTER CODE**. The master code is the four-digit number **REQUIRED** to gain access to the system memory. **You need to know the master code prior to programming the system with the PC, or to perform ANY of the programming functions on the following pages. It MUST be programmed from the system keypad.**

NO Factory setting - Each entry system's master code **MUST** be unique.

See section 4.4 for more information about the master code switch.

1. Open the cabinet of the telephone entry system and turn the master code switch **ON**.
2. Enter a four-digit master code     then press  (**beep**).
3. Turn the master code switch **OFF** and close the cabinet.

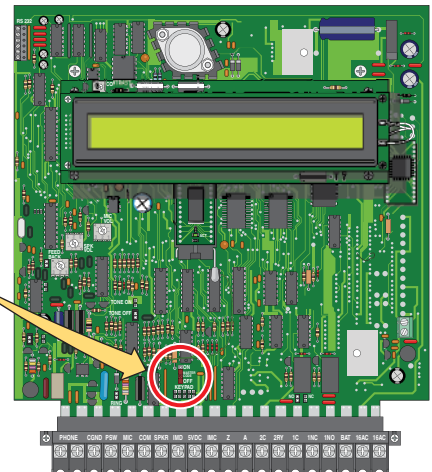
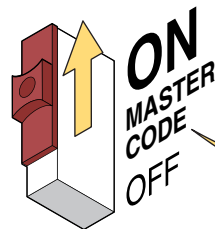

Important Note: There is no way of retrieving the master code after it has been programmed in. If you forget it, you will have to program in a new one but all other previously programmed information will remain intact.

3.2.2 Number of Area Codes Allowed

This programming step sets the system to allow either “up to 10” or “up to 255” alternate area codes (AAC) to be programmed into the system.

Factory setting = 1 (255 area codes)

1. Press and enter your four-digit MASTER CODE (beep).

The LCD display will read: 10 AAC=0 255 AAC=1

2. Enter (beep) for **10 area codes** OR enter (beep) for **255 area codes**.

The display will read: ERASE MEM? 1=Y 0=N. (Choosing 1 **WILL ERASE** the memory and **WILL** evoke the area code choice. Choosing 0 **WILL NOT ERASE** memory and **WILL NOT** evoke the choice).

3. Enter either (beeeeeep) to **set the change** OR (beeeeeep) to **cancel the change**.

CAUTION: When changing an **existing** 1834 “Area codes allowed” from 255 to 10, **ALL existing programmed memory will be erased** but the programmed screen display messages, Section 3.4.

3.2.3 Call-up Operation when Interfacing with DoorKing 1816 or 1820 Systems

This feature is **ONLY** used when the telephone entry system is interfaced with a DoorKing 1816 or 1820 Telephone Intercom system under certain **special applications**. This **CALL-UP feature** provides special programming that will allow the system to call the phone number of a CO (Central Office) line connected to these systems. Once the 1816 or 1820 answers the call, the system will automatically send out DTMF tones that will activate the **CALL-UP feature** in the 1816 or 1820 system, and then send the four digit directory code to the resident selected by the visitor. This allows visitors to contact tenants in the building that do not have CO phone service through the telephone entry system. Refer to the 1816 / 1820 Installation Manual, and check with your DoorKing representative on the special applications that this feature is used for.

Factory setting = OFF (DO NOT turn ON unless interfacing with a 1816 or 1820)

1. Press and enter your four-digit MASTER CODE (beep).

2. Enter (beep) to turn the call-up feature **OFF**.

Enter (beep) to turn the call-up feature **ON. Special applications ONLY.**

3. Press together to end this programming sequence (beeeeeep).

3.2.5 “Tone Open” Sound ON or OFF

The following programming sequence turns the “Tone Open” sound either On or Off (when the relays activate). This feature is available on Rev K boards or higher. See 3.3.3 for information about “Tone Open” numbers feature.

Factory setting = 1 (tone ON)

1. Press and enter your four-digit MASTER CODE (beep).

The LCD display will read: BEEP RLY OP? 0=N 1=Y

2. Enter for **YES - tone will sound** or for **NO - tone will not sound**, then press (beep).

3. Press together to end this programming sequence (beeeeeep).

3.2.6 RS-232 Speed Setting

The following programming sequence sets an optional slower RS-232 speed. This feature is available on Rev M boards or higher and the Remote Account Manager Software, Version 6.4.b, must be used.

Factory setting = 1 (19200 baud rate)

1. Press and enter your four-digit MASTER CODE (beep).
2. Enter for **9600 baud rate** or for **19200 baud rate**, then press (beep).
3. Press together to end this programming sequence (beeeeeep).

3.2.7 Switch Input Feature

The following programming sequence sets the switch input (main terminals #4 and #6) to either activate a relay(s) or call the phone number programmed in directory code 0, 00, 000 or 0000. Refer to section 3.3.4 to determine which relay(s) will activate when the switch input is activated. This feature is available on Rev K boards or higher.

Factory setting = 0 (switch input activates relay)

1. Press and enter your four-digit MASTER CODE (beep).
The LCD display will read: KEY IN DIAL? 0=N 1=Y
2. Enter for **YES** (the switch input will dial a phone number) or for **NO** (the switch input will activate the relay), then press (beep).
3. Press together to end this programming sequence (beeeeeep).

3.2.9 Single or Multiple Systems

This program sequence sets the telephone entry system to operate as a single unit on the phone line, or to share the phone line with other units. If multiple systems are sharing the same phone line, then each one must be set as a "multiple system" and each must have a unique master code.

Factory setting = Single System.

1. Press and enter your four-digit MASTER CODE (beep).
2. Press (beep) for a **single system**, OR (beep) for **multiple systems**.
3. Press together to end this programming sequence (beeeeeep).

3.2.10 DKS Data over IP System Phone Number or System ID Number

The following programming sequence is necessary **ONLY** when using DoorKing DKS Data over IP. After installing the Remote Account Manager Software, Version 6.4.b, there is an option to use the DoorKing **DKS Data over IP** on the System Information screen. **When registering an entry system online with DKS Data over IP requires either the 10-digit phone number of the entry system or 10 digit ID number which DKS Data over IP will assign during registration.** This phone number or ID number **MUST** be programmed into the entry system to use the **DKS Data over IP**.

Visit <http://www.doorking.com> for more information.

Factory setting = No number in system

1. Press and enter your four-digit MASTER CODE (beep).
2. Enter the **10-digit phone number** or **system ID number - assigned during registration**, then press (beep).
3. Press TOGETHER to end this programming sequence (beeeeeep).

Notes: This programming sequence automatically turns **DKS Data over IP ON** (section 6.1.9).
To view programmed number in system see section 6.1.7. To check for problems see section 6.1.8.

3.2.11 Re-Program Memory Size, WITHOUT Cards and Anti-Pass Back

These features **ONLY** need to be **re-programmed** when a NEW 1834 entry system is to be used with EXISTING **OLDER** 1834 entry systems that have a **smaller memory size (less than 3000)** and all units are being managed by DKS Remote Account Manager Software with the “Share Info” feature. **The new 1834 chip specification MUST MATCH** the older 1834 chip specification or EXISTING programming conflicts will occur.

Factory setting = Step 2 - 8 (3000), Step 4 - 2 (Using Cards WITH Anti-Pass Back)

1. Press and enter your four-digit MASTER CODE (beep).
The LCD display will read: MEM SIZE? 1 THRU 8

CAUTION: This programming sequence will **erase ALL** information stored on the existing memory chip.

2. Enter a **single-digit** for memory size (1-8), then press (beep).
1=25 2=75 3=125 4=250 5=500 6=1000 7=2000 8=3000

The LCD display will read: xxxx MEM OK? 0=N 1=Y (xxxx is the memory you have chosen).

3. Press **YES** (beep), OR **NO** (beep).

Note: Selecting NO (0*) will go back to the previous step.

After **YES** (1*) is entered, The LCD display will read: CARDS 0=N 1=Y 2=ANTI

4. Press (beep) **NO Cards, DO NOT PROGRAM “Use Cards (1*)” OR “Use Cards with Anti-Pass Back (2*)”**

The LCD display will read: ERASE MEM? 1=Y 0=N

5. Press **YES** (beep), OR **NO** (beep).

Note: Selecting NO (0*) will go back to the first step.

After **YES** (1* BEEP) is entered, A long beep will be heard after memory has been erased (**beeeeeep**).

3.2.12 Turn LIVE Transaction Viewing On or Off

The following programming sequence turns the “**LIVE**” Transaction viewing on your PC **On** or **Off**.

When turned **ON**, all transactions can be viewed “Real-Time” from your PC.

When turned **OFF**, the transaction buffer must be downloaded before viewing the transaction history log. The transaction buffer stores the last **8000 events** when downloaded.

Factory setting = 0 (OFF)

1. Press and enter your four-digit MASTER CODE (beep).
The LCD display will read: view live? 0=NO 1=YES

2. Enter for **YES - view live transactions** or for **NO - don't view live transactions**, then press (beep).

3. Press together to end this programming sequence (**beeeeeep**).

STOP!!

If the telephone entry system is to be programmed from a PC, **NO** other programming is required at the system itself. Refer to the Remote Account Manager for Windows Software help screens for additional programming information. Continue with the remaining sections in this chapter if the telephone entry system will be programmed by any other method. If the factory setting matches your need, there is no reason to reprogram that section.

Remember that advanced features like relay hold open time zones, security levels, and elevator control functions can **ONLY** be programmed from the Remote Account Manager Software. If any of these advanced features are being used, **DO NOT** proceed with any other programming steps in this manual.

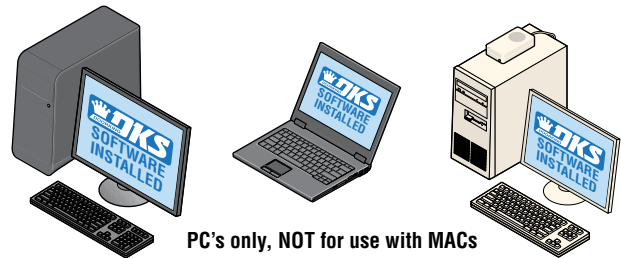

Download **REMOTE ACCOUNT MANAGER** Software **FREE** at:
<http://www.doorking.com/telephone/software>

Overview for System Keypad Programming

	Page #	Section	Command	Factory Setting
Section 3.2 Setup Entry System for PC Programming				
NOT Programmable from Software. Program from System Keypad ONLY.	26	3.2.1	Master Switch ON	No factory setting
	27	3.2.2	* 60	1 (255 area codes)
	27	3.2.3	* 78	0 (OFF)
	27	3.2.5	* 15	1 (tone ON)
	28	3.2.6	* 85	1 (19200 Baud)
	28	3.2.7	* 18	0 (activates relay)
	28	3.2.9	* 04	Single system
	28	3.2.10	* 59	Issued by DoorKing
	29	3.2.11	* 95	8-3000 Memory 2-Card WITH Anti-Pass Back (Only needed when New 1834 system is used with OLDER 1834 systems)
	30	3.2.12	* 19	OFF
Testing DKS Data over IP	53	6.1.7	* 55	Testing Option
	53	6.1.8	* 29	Testing Option
	53	6.1.9	* 56	Testing Option OFF
Section 3.3 General Programming using System Keypad				
	31	3.3.1	* 03	Relay 0: 01 (1 sec) Relay 1: 01 (1 sec) Relay 2: 01 (1 sec)
	31	3.3.2	* 08	060 (60 sec)
	32	3.3.3	* 05	Relay 0: # # # # Relay 1: 9 8 7 6 Relay 2: 5 4 3 2
	32	3.3.4	* 50	010 (relay 1 activates)
	33	3.3.5	* 07	Touch-tone
	33	3.3.6	* 51	010 (relay 1 activates)
Section 3.4 Programming Letters, Numbers and Messages				
	34	3.4.1	None	No factory setting
	35	3.4.2	* 80	Factory message
	36	3.4.3	* 81	Factory message
Section 3.5 Programming Phone Numbers and Names				
	38	3.5.1	* 20	Three (3) digits
	38	3.5.2	* 01	No factory setting
	39	3.5.3	* 24	No factory setting
	39	3.5.4	* 41	No factory setting
	40	3.5.5	* 66	No factory setting
	40	3.5.6	* 01	No factory setting
	40	3.5.7	* 65	No factory setting
	41	3.5.8	* 24	No factory setting
	41	3.5.9	* 06	No Factory setting
	41	3.5.10	* 09	No factory setting
	41	3.5.11	* 27	1 (Pause ON)
Section 3.6 Not Applicable to 1834				
Section 3.7 Programming Four-Digit Entry Codes				
	42	3.7.1	* 02	No factory setting
	42	3.7.2	* 02	No factory setting
	42	3.7.3	* 12	No factory setting
Section 3.8 Not Applicable to 1834				

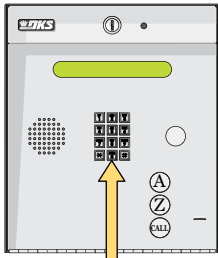

Note: Program section numbers have been intentionally skipped that **DO NOT** apply to the specific access controller in this manual. This allows **ALL** of the 1830 series manuals (1835-065 and 1838-065) to remain in sync with each other when referencing programming numbers.

3.3 General Programming Using the System Keypad



System Keypad















Proceed with the programming steps on the following pages **ONLY IF** PC programming **WILL NOT** be used. The system keypad may be used to program some features on the telephone entry system but can be a little tedious to use. We strongly suggest that you become familiar with the programming steps in each feature you want to use **BEFORE** actually programming the system.

Important Note: If you make a mistake while programming, press   keys at the same time to escape from programming no matter how much has been completed, then begin again at step 1.

3.3.1 Relay Strike Time

These steps will program Relay 1 and Relay 2 strike times. Strike times can be programmed from 1/4 second up to 99 seconds by entering the desired time in seconds as a two-digit number in step 3.











Factory setting for relay strike times are: Relay 1 = 01 (1 sec), Relay 2 = 01 (1 sec).

1. Press    and enter your four-digit MASTER CODE     (beep).
2. Press   (beep) to set **Relay 1**, OR   (beep) to set **Relay 2** strike time.
3. Enter the **two-digit strike time** in seconds (00-99), then press  (beep).
(Example: 1/4 second - enter 00, 1 second - enter 01 etc.)
4. Repeat steps 2 and 3 to set other relay strike time.
5. Press   together to end this programming sequence (**beeeeeep**).

3.3.2 Talk Time

This programming sequence sets the maximum time allowed for conversation when the entry system places a call to the resident. The talk time can be set from 1 second up to 255 seconds (4 minutes, 15 seconds) and is entered as a three-digit number in step 3. The talk time set here **DOES NOT** affect the telephone numbers that are programmed under directory codes 0, 00, 000, 0000 and 1, 01, 001, 0001. The talk time for these two directory code sets are **factory set to the maximum**. Phone numbers programmed under these directory codes should be reserved for management or emergency phone numbers that generally require longer conversations.

Factory setting for talk time = 060 (60 seconds).

1. Press    and enter your four-digit MASTER CODE     (beep).
2. Enter the **three-digit talk time** in seconds (001-255), then press  (beep).
(Example: 1 second - enter 001, 20 seconds - enter 020 etc.)
3. Press   together to end this programming sequence (**beeeeeep**).

3.3.3 Tone Open Numbers

These steps will program the tone open numbers for Relays 1 and 2. You will need to enter a four-digit number (see chart below) to set the relay functions. **If a function is not desired, enter # in place of a number.**
Factory setting is: Relay 0 = ####, Relay 1 = 9876, Relay 2 = 5432.

1. Press and enter your four-digit MASTER CODE (beep).
2. Press (beep) to set **Relay 1**, OR (beep) to set **Relay 2** tone numbers.
3. Enter the **four-digit tone open number code**, then press (beep).

(Example: If you want a relay to have a momentary activation function only, and you want that relay to momentary activate when the number 9 is pressed, enter 9 # # #. If a function is not desired, enter # in place of a number. Do not duplicate tone open numbers, Example: don't set relay 1 and 2 tone-open numbers both to 9.)

4-Digit Tone Open Number Code	Function
1st Digit	Momentary activation. Relay will activate for the programmed strike time (3.3.1).
2nd Digit	Relay hold. Relay will activate and remain activated until commanded to release.
3rd Digit	Relay release. Deactivates the relay hold command.
4th Digit	Relay hold 1-hour. Relay will activate for 1-hour and then will automatically deactivate itself.

4. Repeat steps 2 and 3 to set other relay tone open numbers.
5. Press together to end this programming sequence (beeeeeep).

Note: Residents will only be able to activate the **Momentary activation** when using the entry system.

3.3.4 Switch Input Relay(s) Activation

This programming sequence sets which relay(s) will activate when the switch input (main terminals #4 and #6) is activated on the telephone entry system. The system can be programmed so that only one relay will activate, or both relays will activate. TIP: The relay that you designate as the primary relay should be programmed to activate from the postal switch input.

Factory setting = 010 (only relay 1 activates)

1. Press and enter your four-digit MASTER CODE (beep).
2. Enter the **three-digit** (1's or 0's only) **postal relay code**, then press (beep).

Three-digit positions: 1st digit position - **Always Set to "0"**, 2nd digit position - **Relay 1**, 3rd digit position - **Relay 2**.

To activate a relay - enter a 1 in the second or third digit position.

To **NOT** activate a relay - enter a 0 in the second or third digit position.













Example: entering 010 will cause only relay 1 to activate. Entering 011 will cause both relays to activate.

3. Press together to end this programming sequence (beeeeeep).

3.3.5 Touch-Tone / Rotary-Dial

This programming sequence will set the telephone entry system to dial out in either a touch-tone or rotary format. Generally, this will be set for touch-tone.

Factory setting = touch-tone.

1. Press    and enter your four-digit MASTER CODE     (**beep**).
2. Press   (**beep**) for **touch-tone**, OR   (**beep**) for **Rotary**
3. Press   together to end this programming sequence (**beeeeeep**).

3.3.6 Rotary-Dial 9 Relay(s) Activation

This programming sequence sets which relay(s) will activate when the system receives a **rotary-dial 9 open command** from a residents rotary telephone. The system can be programmed so that only one relay will activate, or both relays will activate. TIP: The relay that you designate as the primary relay should be programmed to activate from a rotary 9 command.

Factory setting = 010 (only relay 1 activates)



1. Press    and enter your four-digit MASTER CODE     (**beep**).
2. Enter the **three-digit** (1's or 0's only) **rotary 9 code**, then press  (**beep**).

Three-digit positions: 1st digit position - **Always Set to "0"**, 2nd digit position - **Relay 1**, 3rd digit position - **Relay 2**.

To activate a relay - enter a 1 in the second or third digit position.

To **NOT** activate a relay - enter a 0 in the second or third digit position.

Example: entering 010 will cause only relay 1 to activate. Entering 011 will cause both relays to activate.

3. Press   together to end this programming sequence (**beeeeeep**).

3.4 Programming Letters, Numbers and Messages

Press... ..To Display

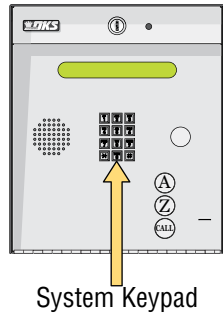
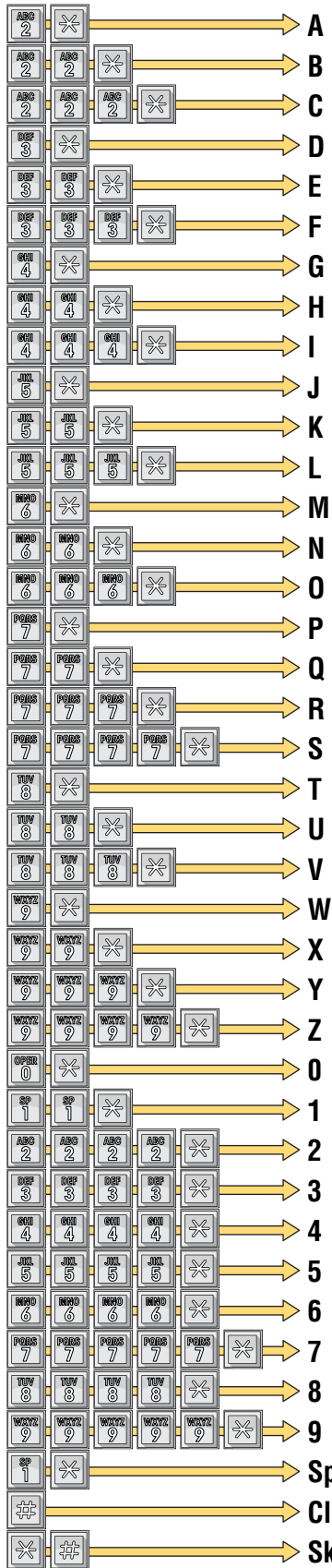

The keypad on this telephone entry system has all the letters of the alphabet, the numbers 0 through 9, and a space key printed on it. This allows the keypad to be used to program all names and numbers into the systems electronic directory.

Note: Names should not be programmed from a remote location using a touch-tone telephone.

Note: Only upper case letters can be programmed using the keypad. Upper and lower case letters may be programmed using the Remote Account Manager Software (PC).

3.4.1 Programming Letters and Numbers from Keypad

When entering names into the electronic directory using the system keypad or a touch-tone telephone, pressing the key once will display the first letter listed on the button, pressing twice will display the second letter, pressing it a third time will display the third letter, and pressing it a fourth time will display the number (or fourth letter).



Example using the number 6 key:

Press **one time** to display the letter M, then press to enter it in the system.

Press **two times** to display the letter N, then press to enter it in the system.

Press **three times** to display the letter O, then press to enter it in the system.

Press **four times** to display the number 6, then press to enter it in the system.

This chart provides the sequence required to enter each letter and number from the keypad into the system memory. A sequence is also provided to add a space, clear the display if a mistake is made, and a sequence to skip a name if there is a desire **not** to provide a name with a phone number.

3.4.2 Programming the User Message

The user message, followed by the instruction message, **scrolls across the screen from right to left** when the system is not in use. Both the user and instruction message can be programmed to display your own message. The user message can be a **maximum of 48 characters (spaces count as a character)** and is entered into the system memory in three blocks. The first two blocks contain 20 characters while the third block contains 8 characters. The example below shows how the sample message was divided into three blocks. Use the blank table to organize your own message. Only upper case letters, numbers and spaces can be programmed from the system keypad.

















Factory Default User Message = This Space is For YOUR Scrolling User Programmable Message.

Example: THANK YOU FOR VISITING OAKWOOD CONDOMINIUMS																				
	1	2	3	4	5	6	7	8	9	10	11	12	13	14	15	16	17	18	19	20
Block 1	T	H	A	N	K		Y	O	U		F	O	R		V	I	S	I	T	I
Block 2	N	G		O	A	K	W	O	O	D		C	O	N	D	O	M	I	N	I
Block 3	U	M	S																	

Note: The factory default message was programmed from a PC, therefore upper and lower case letters are displayed.

	1	2	3	4	5	6	7	8	9	10	11	12	13	14	15	16	17	18	19	20
Block 1																				
Block 2																				
Block 3																				

After organizing the user message in the table above, follow the instructions below to enter the message into the system. After each desired letter, number or space is displayed on the directory, remember to press * to enter that character. Spaces count as a character and must be entered into memory as a character. After a complete block of characters (including spaces) has been entered, press * to enter the block, then start the next block.

- Press    and enter your four-digit MASTER CODE     (beep).
The LCD display will read: BLOCK 1.
- Enter the characters into block 1 (refer to 3.4.1 for reference). Remember to press  (beep) after each character.
- After the last character in block 1 has been entered, press  (beep) to enter the entire block.
The LCD display will read: BLOCK 2.
- Enter the characters into block 2. Remember to press  (beep) after each character.
- After the last character in block 2 has been entered, press  (beep) to enter the entire block.
The LCD display will read: BLOCK 3.
- Enter the characters into block 3. Remember to press  (beep) after each character.
- After the last character in block 3 has been entered, press  (beep) to enter the entire block.
- Press  (beep) to enter all three blocks into the system memory.
- Press   together to end this programming sequence (beeeeeep).
- The new user message will begin to scroll across the screen.

3.4.3 Programming the Instruction Message

The instruction message **scrolls across the screen from right to left** when the system is not in use and follows the user message programmed in 3.4.2. The instruction message can be a **maximum of 52 characters (spaces count as a character)** and is entered into the system memory in three blocks. The first two blocks contain 20 characters while the third block contains 12 characters. The example below shows how the sample instruction message was divided into three blocks and programmed into the system. Use the blank table to organize your own message. Only upper case letters, numbers and spaces can be programmed from the system keypad.

Factory Default Instruction Message: Push A-Z To Find Name Enter Code Or Push Call

Example: PUSH A OR Z BUTTON TO FIND NAME ENTER CODE OR PUSH CALL																				
	1	2	3	4	5	6	7	8	9	10	11	12	13	14	15	16	17	18	19	20
Block 1	P	U	S	H		A		O	R		Z		T	O		F	I	N	D	
Block 2	N	A	M	E		E	N	T	E	R		C	O	D	E		O	R		P
Block 3	U	S	H		C	A	L	L												

Note: The factory default message was programmed from a PC, therefore upper and lower case letters are displayed.

	1	2	3	4	5	6	7	8	9	10	11	12	13	14	15	16	17	18	19	20
Block 1																				
Block 2																				
Block 3																				

After organizing the instruction message in the table above, follow the instructions below to enter the message into the system. After each desired letter, number or space is displayed on the directory, remember to press * to enter that character. Spaces count as a character and must be entered into memory as a character. After a complete block of characters (including spaces) has been entered, press * to enter the block, then start the next block.

- Press and enter your four-digit MASTER CODE (beep).
The LCD display will read: BLOCK 1.
- Enter the characters into block 1 (refer to 3.4.1 for reference). Remember to press (beep) after each character.
- After the last character in block 1 has been entered, press (beep) to enter the entire block.
The LCD display will read: BLOCK 2.
- Enter the characters into block 2. Remember to press (beep) after each character.
- After the last character in block 2 has been entered, press (beep) to enter the entire block.
The LCD display will read: BLOCK 3.
- Enter the characters into block 3. Remember to press (beep) after each character.
- After the last character in block 3 has been entered, press (beep) to enter the entire block.
- Press (beep) to enter all three blocks into the system memory.
- Press together to end this programming sequence (beeeeeep).
- The new instruction message will begin to scroll across the screen.

3.5 Programming Phone Numbers and Names

Before beginning manual programming of phone numbers and names from the system keypad, it is strongly recommended that the resident log sheets in the back of this manual be completed in their entirety. This will make programming easier and can be used as a reference when entering phone numbers, names, entry codes and device numbers.































This section of the manual will instruct you on how to enter phone numbers and names into the system memory from the keypad on the telephone entry system. Prior to entering any information, you will set the directory code digits to the desired length. **Changing the directory code length AFTER programming is complete will delete all programmed phone numbers, area codes, and names and will require you to re-enter this information.**

If you are in an area that requires 10 digit dialing, you will need to program the area code(s) required as described in 3.5.3, and then program the resident phone numbers as described in 3.5.4. If 10-digit dialing is not required, simply enter the 7-digit phone number as described in 3.5.2.

When you are entering names into the electronic directory, remember to press ***** after each desired letter, number, or space is displayed on the LCD screen. When the entire name is displayed on the directory, press ***** again to enter the entire name into the directory. If you make a mistake, simply press **#** to clear the display and start over. **Names cannot be more than 15 characters in length - spaces count as a character.**

Only upper case letters, numbers, spaces and a clear function (in case you make a mistake) can be programmed from the system keypad.

Example of programming 12 characters: JONES APT 1

	Digit	Keypad Sequence	Programming Description
1	J	 	Press the 5 key one time to display J, then press the * key to enter the letter.
2	O	   	Press the 6 key three times to display O, then press the * key to enter the letter.
3	N	  	Press the 6 key twice to display N, then press the * key to enter the letter.
4	E	  	Press the 3 key two times to display E, then press the * key to enter the letter.
5	S	    	Press the 7 key four times to display S, then press the * key to enter the letter.
6		 	Press the 1 key one time for a space, then press the * key to enter the space.
7	A	 	Press the 2 key one time to display A, then press the * key to enter the letter.
8	P	 	Press the 7 key one time to display P, then press the * key to enter the letter.
9	T	 	Press the 8 key one time to display T, then press the * key to enter the letter.
10		 	Press the 1 key one time for a space, then press the * key to enter the space.
11	1	  	Press the 1 key twice to display 1, then press the * key to enter the number.
12			Press the * key to enter the entire name in the system.

Note: Refer to 3.4.1 to reference how to program each individual letter, number, space, clear etc.

3.5.1 Programming the Directory Code Length

This programming sequence sets the directory code length to 1 - 2 - 3 or 4 digits.

When **10 to 99** resident names or telephone numbers are going to be programmed, the directory code **must be at least two-digits**, but can be 3 or 4 digits.

When **100 to 999** resident names or telephone numbers are going to be programmed, the directory code **must be at least three-digits**, but can be 4 digits.

When **1000 or more** resident names or telephone numbers are going to be programmed, the directory code **must be set to four-digits**.

Factory setting is three (3) digits.

CAUTION: After programming this sequence, it is **NOT** recommended changing the directory code length. Reprogramming this sequence in the future will delete **ALL** phone numbers and directory codes that have been **previously** programmed into the system.

1. Press and enter your four-digit MASTER CODE (beep).

The LCD display will read: # OF DIRECTORY CODE DIGITS

2. Enter 1, 2, 3 or 4 digits, then press (beep).

The LCD display will read: ERASE MEM? 1=Y 0=N

- If there are **10 to 99** resident names or telephone numbers, directory code **must be at least two-digits**.
- If there are **100 to 999** resident names or telephone numbers, directory code **must be at least three-digits**.
- If there are **1000 or more** resident names or telephone numbers, the directory code **must be set to four-digits**.

3. Entering will cancel out of this program if desired (beeeeeep).

Entering will change the directory code length (and erase ALL existing memory).

The LCD display will read: ERASING

A long beep will sound when complete (beeeeeep).

Directory code digit length has now been programmed.

3.5.2 Programming Directory Codes with 7-Digit Phone Numbers - NO Area Code

In this programming sequence, the directory codes **AND** 7-digit phone numbers will be programmed into the system. Be sure you have programmed the directory code length that you desire as described in 3.5.1 above. **Changing the directory code length after programming the telephone numbers will erase all the numbers and directory codes that have been programmed.** To program phone numbers that will need to use an area code (long distance calls and 10-digit calling), program them in 3.5.4. If you use directory codes 0, 00, 000, 0000 and/or 1, 01, 001, 0001 remember that the talk time for these directory codes are factory set to the maximum and cannot be changed. Use these directory codes to program management or emergency phone numbers, which generally require longer conversation periods.

Note: If this telephone entry system is being used in **an area that requires 10-digit phone number dialing**, proceed to 3.5.3 and 3.5.4 to program the area code, phone number and directory code.

1. Press and enter your four-digit MASTER CODE (beep).

2. Choose and enter a **directory code** (1, 2, 3 or 4 digits depending on what was programmed in 3.5.1 above), then press (beep). (You cannot duplicate directory codes)

The LCD display will read: PHONE#

3. Enter the **seven-digit phone number**, then press (beep).

Note: If the number that you are entering in this step is less than seven-digits, enter # in the empty spaces after the digits have been entered.

For example, if the system is connected to a PBX that requires four-digit extension numbers and you want to enter extension 2217, you would enter this number as 2217###, then press * (beep).

4. Press together to end this programming sequence (beeeeeep).

3.5.3 Programming Area Codes

Program area codes when 10-digit or long distance calling is required. “Up to 10” OR “up to 255” area codes can be programmed depending on how the system was programmed in section 3.2.2.

- Area code pointers set for “up to 10” area codes are referenced 0 – 9 in step 2 (for a total of 10).
- Area code pointers set for “up to 255” area codes are referenced 000 – 254 in step 2A (for a total of 255).

The actual area codes will be entered as a four-digit number (1 + the three digit area code). If area codes are being programmed to facilitate 10-digit calling requirements, precede the three-digit area code with #.

Note: 255 area codes are available on REV E and higher circuit boards. REV D and lower boards only have 10 area codes.

1. Press    and enter your four-digit MASTER CODE     (beep).

“Up to 10” programmed, LCD display will read: 0 – 9 AAC POINTER

“Up to 255” programmed, LCD display will read: 000 – 254 AAC POINTER

2. Enter a **single-digit area code pointer** (0 – 9 when set for up to 10 area codes), then press  (beep).

The LCD display will read: 4 DIGIT AREA CODE

- 2A. Enter a **three-digit area code pointer** (000 – 254 when set for up to 255 area codes), then press  (beep).



The LCD display will read: 4 DIGIT AREA CODE

3. Enter the **four-digit area code**, then press  (beep).

For long distance calling requirements, enter 1 and the three-digit area code (1 + the three digit area code).

For 10-digit calling requirements, enter # and the three-digit area code (# + the three digit area code).

4. Repeat steps 2 and 3 to enter additional area codes. Remember to use a different area code pointer number for every additional area code entered. See the reference tables in back of this manual to assist you further.

5. Press   together to end this programming sequence (beeeeeep).

3.5.4 Programming Directory Codes with Phone Numbers that use Area Codes

In this section, phone numbers that are referenced to an area code pointer (long distance and 10-digit dialing calls) will be programmed with the directory code. Be sure that the area code(s) have been programmed as described in the preceding section 3.5.3.

Note: If long distance or 10-digit dialing is **NOT** required, program the seven-digit telephone numbers in section 3.5.2.

1. Press    and enter your four-digit MASTER CODE     (beep).

The LCD display will read: DIRECTORY CODE

2. Choose and enter a **directory code** (1, 2, 3 or 4 digits depending on what was programmed in 3.5.1), then press  (beep).
(You cannot duplicate directory codes)

The LCD display will read: AAC POINTER

3. Enter a **single-digit area code pointer** (0 – 9 when set for up to 10 area codes), then press  (beep).

The LCD display will read: PHONE #

- 3A. Enter a **three-digit area code pointer** (000 – 254 when set for up to 255 area codes), then press  (beep).



The LCD display will read: PHONE #

4. Enter the **seven-digit phone number**, then press  (beep).

Note: If the number that you are entering in this step is less than seven-digits, enter # in the empty spaces after the digits have been entered.

For example, if the system is connected to a PBX that requires a four-digit extension numbers and you want to enter extension 2217, you would enter this number as 2217###, then press * (beep).

5. Repeat steps 2, 3, and 4 to enter additional long distance phone numbers.

6. Press   together to end this programming sequence (beeeeeep).

3.5.5 Programming Names

In this section, names will be programmed into the system. Names are referenced to a phone number by entering the directory code that the person's phone number has been programmed to.

1. Press and enter your four-digit MASTER CODE (**beep**).
2. Enter the existing **directory code** (section 3.5.2 or 3.5.4) that the name will be assigned to (1, 2, 3 or 4 digits, section 3.5.1), then press (**beep**).
3. Enter the residents name, one character at a time, press (**beep**) after each character to enter it. Continue entering characters, pressing (**beep**) **after each character** until all characters have been entered.
The LCD display will display each character after * is pressed.
Refer to 3.4.1 and 3.5 for reference to letters, spaces etc.
4. Press (**beep**) to enter the complete name.
The LCD display will go blank after * has been pressed.
3. Repeat steps 2, 3, and 4 to enter additional names.
5. Press together to end this programming sequence (**beeeeeep**).

3.5.6 Deleting Individual Phone Numbers

This programming sequence is used to delete a single phone number under a **known directory code**. Proceed to 3.5.7 to delete the resident name after deleting the phone number.

1. Press and enter your four-digit MASTER CODE (**beep**).
2. Enter the existing **directory code** (section 3.5.2 or 3.5.4) that the phone number has been assigned to (1, 2, 3 or 4 digits, section 3.5.1), then press (**beep**).
3. Press then press (**beep**).
4. Repeat steps 2 and 3 to delete additional phone numbers.
5. Press together to end this programming sequence (**beeeeeep**).

3.5.7 Delete Names

This programming sequence is used to delete a resident name from the directory. These steps **WILL NOT** erase the resident telephone number from the system. Go to section 3.5.6 above to delete the resident telephone number.

1. Press and enter your four-digit MASTER CODE (**beep**).
2. Use the A and Z buttons to locate the name that is to be erased on the LCD screen, then press (**beep**).
3. Repeat step 2 to erase additional names.
4. Press together to end this programming sequence (**beeeeeep**).

3.5.8 Delete Area Codes

This program sequence deletes area code numbers that have been programmed into the system. Refer to section 3.2.2. for programming on step 2 or 2A.

1. Press and enter your four-digit MASTER CODE (beep).
“Up to 10” programmed, LCD display will read: 0 – 9 AAC POINTER
“Up to 255” programmed, LCD display will read: 000 – 254 AAC POINTER
2. Enter the **single-digit area code pointer** (0 – 9 when set for up to 10 area codes), then press (beep).
The LCD display will read: 4 DIGIT AREA CODE
- 2A. Enter the **three-digit area code pointer** (000 – 254 when set for up to 255 area codes), then press (beep).
The LCD display will read: 4 DIGIT AREA CODE
3. Enter , then press (beep).
4. Repeat steps 2 or 2A and 3 to delete additional area codes.
5. Press together to end this programming sequence (beeeeeep).

3.5.9 Display Phone Numbers

Use this programming sequence to display phone numbers programmed **under known directory codes**, i.e. if you wanted to see what phone number was programmed under directory code 271. This programming sequence **WILL NOT** allow you to delete the phone numbers that are displayed.

1. Press and enter your four-digit MASTER CODE (beep).
2. Enter the existing **directory code** (section 3.5.2 or 3.5.4) that the phone number has been assigned to (1, 2, 3 or 4 digits, section 3.5.1), then press (beep).
The phone number programmed under the directory code that was just entered will be displayed on the LCD screen.
 - **If C C C C C C C is displayed** - this indicates that **NO** phone number has been programmed under the entered directory code.
 - **If the first digit is flashing** - this is the area code reference code and indicates that the number displayed is a long distance or 10-digit number.
3. To display additional phone numbers, press and repeat step 2 or proceed to step 4 to end programming.
4. Press together to end this programming sequence (beeeeeep).

3.5.10 PBX Line Access Code Programming

If the telephone entry system is connected to a **PBX telephone system** rather than a dedicated C.O. line, you may need to set the unit to dial a line access code prior to dialing the resident phone number. Typically, the line access code is “9”, but check with the PBX system administrator to be sure.

1. Press and enter your four-digit MASTER CODE (beep).
2. Enter the single-digit **line access code number**, then press (beep).
3. Press together to end this programming sequence (beeeeeep).

Note: To change a line access number, enter the correct number in step 2. To delete a line access number, enter # in step 2.

3.5.11 Touch-Tone Dialing Pause

During touch-tone dialing, the system (by default) places a 2 second pause after dialing a line access code (9 in a PBX system for example) and after the area code. For example: 9 (2 second pause) 1310 (2 second pause) 6450023

The 2 second pause can be removed by programming 0 into the steps below. In this example, the system would simply dial out the line access code (9), area code (1310) and phone number (6450023) without any pauses. 913106450023

Factory setting is 1 (pause ON).

1. Press and enter your four-digit MASTER CODE (beep).
2. Enter (beep) to turn the pause **OFF**, or enter (beep) to turn the pause **ON**.
5. Press together to end this programming sequence (beeeeeep).

3.7 Programming Four-Digit Entry Codes

Four-digit entry codes are entered **ONLY** on the **Telephone Entry System Keypad** preceded by “#” to allow the resident access. Each entry code that you enter must be assigned to a directory code that you select (that was programmed in section 3.5.2). Only **ONE** entry code can be programmed for each directory code. **You cannot duplicate entry codes.**

3.7.1 Programming Four-Digit Entry Codes

1. Press and enter your four-digit MASTER CODE (**beep**).
2. Enter the existing **directory code** (section 3.5.2 or 3.5.4) that the entry code will be assigned to (1, 2, 3 or 4 digits, section 3.5.1), then press (**beep**).
3. Choose and enter a **four-digit entry code**, press (**beep**).
4. Repeat steps 2 and 3 to enter additional entry codes. (You cannot duplicate entry codes)
5. Press together to end this programming sequence (**beeeeeep**).

3.7.2 Delete Entry Codes

1. Press and enter your four-digit MASTER CODE (**beep**).
2. Enter the existing **directory code** (section 3.5.2 or 3.5.4) that the desired entry code has been assigned to (1, 2, 3 or 4 digits, section 3.5.1), then press (**beep**).
3. Enter , then press (**beep**).
4. Repeat steps 2 and 3 to delete additional desired entry codes.
5. Press together to end this programming sequence (**beeeeeep**).

3.7.3 Entry Code Ranges

Four-digit entry codes can be made to activate relay 1 or relay 2 or both relays by programming **HI** and **LOW** ranges for each relay. Ranges between relays may overlap, which will cause more than one relay to activate if this is desired. For example, if the low boundary for relay 1 is 2000, and the hi boundary is 3000, and the low boundary for relay 2 is 2000 and the hi boundary is 4000, then entry codes between 2000 and 3000 will activate both relays, and entry codes between 3001 and 4000 will only activate relay 2.

1. Press and enter your four-digit MASTER CODE (**beep**).
2. Press (**beep**) to set **relay 1**, or (**beep**) to set **relay 2** boundary.
3. Enter the **four-digit LOW boundary**, then press (**beep**).
4. Enter the **four-digit HI boundary**, then press (**beep**).
5. Repeat steps 2, 3, and 4 to set the other relay boundaries.
6. Press together to end this programming sequence (**beeeeeep**).

SECTION 4 - ADJUSTMENTS

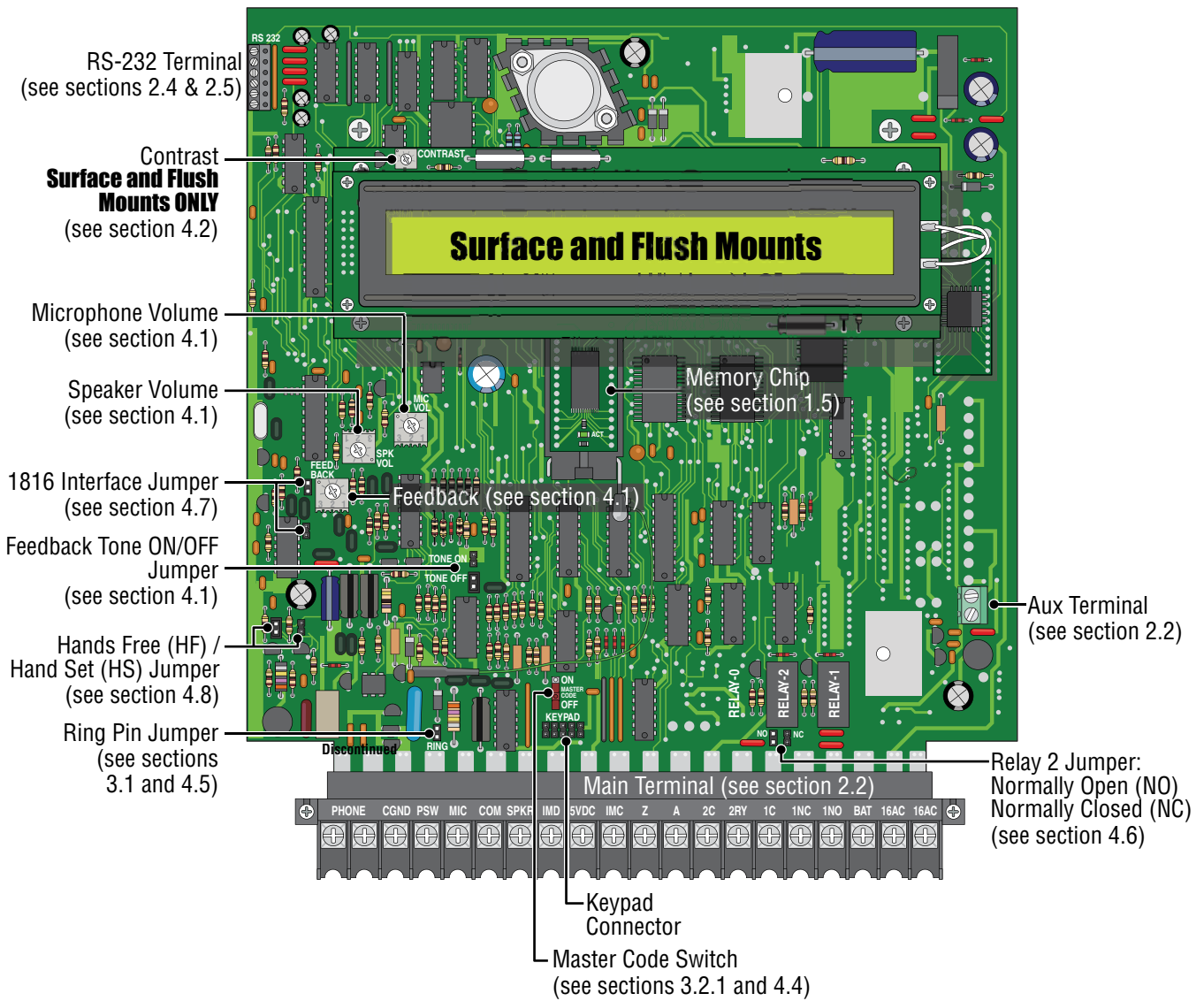

Wall Mount - Discontinued

LCD Display (Back View)

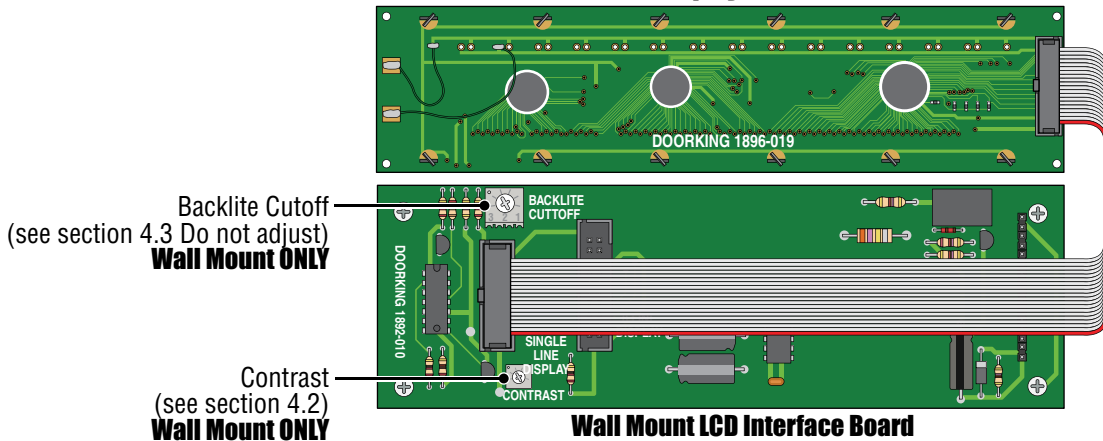

4.1 Speaker Volume, Microphone and Feedback

Speaker volume, microphone volume and feedback all interact with each other to affect the audio performance of the system.

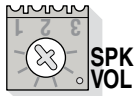

1. Locate the **speaker volume**, **microphone volume** and **feedback** adjustments on circuit board (see previous page).

2. Set the **speaker volume** about 1/3 from full counter-clockwise.



3. Set the **microphone volume** to 1/2.

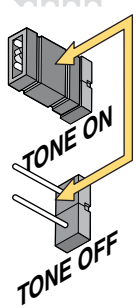

4. Place a phone call from the telephone entry system to a resident. If feedback occurs, turn the **speaker volume** counter-clockwise until it ceases.

5. While the resident is still on the line, ask them to remain silent. Move the **feedback tone ON/OFF jumper** to to the **ON** position. A tone will now be heard in the speaker. Rotate the **feedback** adjustment throughout its range while listening to the sound coming from the speaker. When the sound is minimum, this is the correct setting. Move the **feedback tone ON/OFF jumper** back to to the **OFF** position.



6. **Speaker volume** and **microphone volume** may now be adjusted to desired levels. If both are set too loud, feedback may result. For louder speaker volume, the microphone volume may need to be decreased. For louder microphone volume, the speaker volume may need to be decreased.

7. Normal setting for both **speaker volume** and **microphone volume** is about 1/2.

8. After setting these adjustments, place some test calls. If feedback occurs, microphone and/or speaker volume will need to be reduced.

4.2 LCD Display Contrast



LCD display is adjusted at the factory and should **NOT** need to be re-adjusted. If it does, Let the system run for at least 10-minutes before making any display contrast adjustments.

1. Locate the **contrast** adjustment on your chosen model (see previous page).

2. Turn the contrast potentiometer clockwise to lighten, counter-clockwise to darken until the display is satisfactory.

4.3 Backlite Cutoff



This adjustment is **only** on the wall mount model (Discontinued). This is adjusted at the factory and should **NOT** be adjusted in the field.

4.4 Master Code Switch

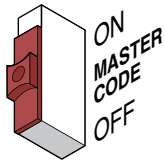

The master code switch **MUST** be kept in the **OFF** position for normal operation. Turn the master code switch **ON** only when programming the system's master code. See section 3.2.1 to program the system's master code. If the master code switch is **turned ON** and a new master code is **NOT** entered, the system will sound a long tone after approximately 30 seconds. This tone will continue every 30 seconds until a new master code is entered, or until the switch is turned off.

4.5 Ring Pin Jumper

Always Answer Calls

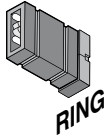

The ring pin jumper is labeled **RING** on the control board. This jumper **MUST** be installed to allow the system to **ALWAYS** answer the calls placed to it. If remote programming or remote relay operation is to be used, the jumper **MUST** be installed on the pins. Removing the jumper will cause the system to **NEVER** answer calls placed to it.

Never Answer Calls

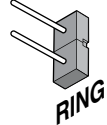

4.6 Relay 2 Jumper

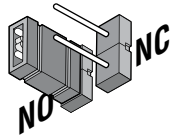

This jumper sets the contacts on relay number two at either Normally Open (NO) or Normally Closed (NC). The jumper is set to **NO from the factory**.

4.7 Auto – 1816 Interface Jumper

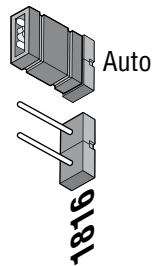

This jumper sets the system to operate as a **stand-alone unit - AUTO** (top position), or to interface with the 1816 Telephone Intercom System (bottom position). The jumper is set to **AUTO from the factory**.

4.8 HF – HS Jumper

SURFACE Mount Handsfree

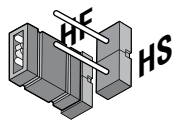

For **Hands Free (HF)** operation, the jumper is set in the left position.

SURFACE Mount Hand Set

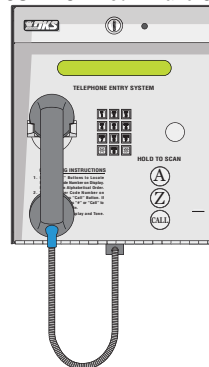

For a system with a **Hand Set (HS)**, the jumper is set in the right position.

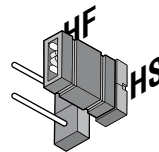

FLUSH Mount Hand Set

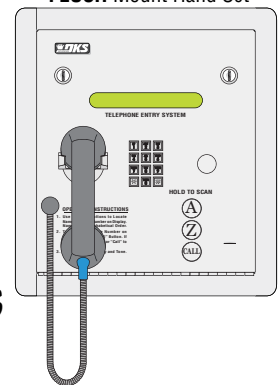

SECTION 5 - SYSTEM OPERATING INSTRUCTIONS

5.1 Guest Instructions

All 1834s have a scrolling LCD display **Instruction Message** and the surface and flush mounts also have a printed **Instruction Message** on front. Both **Instruction Messages** show how to operate the system (locating and calling the resident that they wish to visit). The system utilizes an “A” and “Z” **scroll buttons** that a guest will use to locate the resident that they are wishing to visit. Pushing the “A” button will cause the resident directory to scroll up, pushing the “Z” button causes the resident directory to scroll down. Holding these buttons down will cause the system to scroll or page through the resident directory rapidly. Resident names are listed in the resident directory alphabetically.

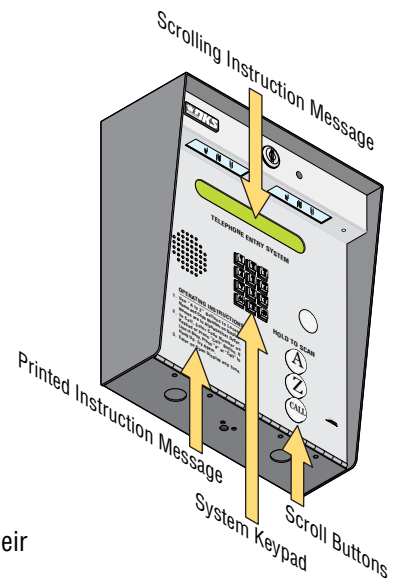

The LCD electronic directory displays resident names (or apartment numbers) and their respective **directory code** on a single line.

1. If the guest knows the residents **directory code**, they can simply enter it on the system keypad to place a call.
2. If the guest does not know the residents directory code, they must check the directory and find the code assigned to the person they wish to visit.

Guest use the “A” and “Z” buttons to locate the name in the directory. Once the residents name is displayed, the guest presses the “CALL” button and the system will connect to the resident’s telephone. The guest may also enter the **directory code** on the keypad to place the call.



DTMF Tones - The telephone entry system can output **DTMF** tones from the keypad **AFTER** a call has been answered.





- If the  key is pressed by itself – the system will hang-up.

Example:  = hang-up.

- If any key is pressed prior to the  key, then **ALL** keys pressed will emit DTMF tones.

Example:       = DTMF tones for all buttons including the  key.

- If there is more than a 2-second delay between numbers and the  key, then the  key will hang-up the system.

Example:     more than a 2-second delay  = hang-up.

5.2 Resident Instructions

Resident control of the door or gate that the telephone entry system controls is limited to opening the door or gate in response to a call from a guest, or they may open the door or gate by using their assigned four-digit entry code. **A resident instruction sheet is included in the back of this manual and may be copied and passed out to your residents.**

5.2.1 Responding to a Guest Call

When communication is established, the resident has the option of **opening the door(s) or gate(s)** by pressing the programmed **tone open number(s)** on their touch tone telephone, or they can **deny access** to their guest by pressing **#** on their telephone. If access is granted, the resident will hear a confirmation tone in their handset indicating that the door or gate has opened, then the system will automatically hang up.



Residents should be instructed by management to always press the # key on their telephone if they wish to deny a guest access. If a resident hangs up to deny access instead of pressing #, the telephone entry system will remain on line until its programmed talk time expires or until it detects dial tone.

Some newer type telephones emit a short tone rather than a continuous tone when their keys are pressed. This may cause the telephone entry system to not respond to the tone open number. If this happens, simply press the tone open number **TWICE** in rapid succession to open the door or gate.

If a resident is using a rotary dial telephone, they will grant access to their guest by dialing **9**. To deny access to their guest, residents with rotary phones **MUST** simply hang up.

5.2.2 Using an Entry Code

Four-digit entry codes provide a means for a resident to gain access by entering their assigned code on the telephone entry system keypad. The four-digit entry code will operate relay 1 or 2 depending on the boundaries that have been programmed into the system (section 3.7.3, Entry Code Ranges).

1. To use entry codes, first press  and then enter the **four-digit entry code** .
2. The system will emit a tone (**beep**) and the LCD display will show **OPEN** when a valid code is entered on the keypad.

If management decides to utilize resident entry codes, **residents should be instructed to keep their unique code secret.** Telling other persons their code or allowing other persons to use their code **compromises security** and defeats the purpose of the system.

5.3 System Administrator

The administrator can perform the following operations from a remote location using a touch tone telephone. You must know the **phone number of the system** and the **system master code**. The system **MUST** be setup to accept incoming calls, see sections 3.1 and 4.5.

5.3.1 Connecting to the Telephone Entry System from a Remote Location

1. Call the telephone number that the entry system is installed on. The system will answer with a short tone (beep) after two rings.
2. Press ***16** and enter the **four-digit MASTER CODE** _ _ _ _ (beep). The beep indicates system has accepted master code.
3. Press the desired **tone open** number _ (beep).
Note: Refer to section 3.3.3 to determine which tone open features have been programmed, i.e. momentary open, hold open, release, hold open one hour and then release.
4. Hang up.

5.3.2 Relay Check

The telephone entry system can be called and a check can be made to determine if any of the relays in the system are in a "hold open" mode. This check can be useful if your gate (or door) is held open and you suspect that the telephone entry system relay may be the cause.

1. Call the telephone number that the entry system is installed on. The system will answer with a short tone (**beep**).
2. Press ***16** and enter the **four-digit MASTER CODE** _ _ _ _ (beep).
3. The system will emit a series of short tones if the relay is in a **continuous activation mode**:
 - Relay 1** activated: **beep** - pause - **beep** - pause . . .
 - Relay 2** activated: **beep beep** - pause - **beep beep** - pause . . .
 - Relay 0** activated: **beep beep beep** - pause - **beep beep beep** - pause . . .**Note:** Relay 0 is **Not** available for the 1834.
4. Press the programmed tone number _ to **deactivate** the relay (**beep**). The system will automatically hang up.

5.3.3 Time and Date Check

This operating functions lets you check the current date, time and day of the week that the system is currently programmed to. If the calendar chip in the system is **NOT** programmed, the system will emit a long **beeeeeep** when this function is entered on the telephone entry system keypad.

Note: The calendar chip can **ONLY** be programmed by the PC when communication is established either by modem or the RS-232 terminal.

1. Press ***30** and enter the **four-digit MASTER CODE** _ _ _ _ (beep).
The LCD display will show: The date - Month / Day / Year
The time - Hours / Minutes / AM or PM (AM=0, PM=1)
The day of the week (1=Sunday, 7=Saturday).

This information will be displayed for approximately four-seconds, then the LCD display will return to normal.

5.4 Miscellaneous Operating Instructions

5.4.1 Talk Time

The talk time for directory codes 0, 00, 000, 0000 and 1, 01, 001, 0001 is **factory set to 4 minutes 15 seconds** and cannot be changed. These directory codes should be reserved for use with management or emergency phone numbers that typically require longer talk times. For example, if directory code 000 was programmed to call a management phone number, the system will allow the **full 4 minutes and 15 seconds of talk time before automatically ending the call.**

5.4.2 Telephone Line Sharing

More than one telephone entry system **can share the same phone line** provided the units have been programmed for **multiple systems** on the same line (see section 3.2.9). When the unit is programmed for multiple systems sharing the phone same line, it checks the phone line for 48 volts (not busy) before attempting to place a call. If the phone line is in use, the system will emit a busy signal. If two or more systems are sharing the same phone line, it is important that each system be programmed with **its own unique master code**. When more than one system is sharing the same phone line, and a call is placed from one of those systems to a resident, **ONLY the system that placed the call** will respond to the **tone open** number that will be sent back to the unit from the resident's phone. Other units sharing the same phone line **WILL NOT** respond to the tone open number sent from the resident's phone.

5.4.3 Connection to a PBX System

If the telephone entry system is going to be connected to a PBX system, you may need to program extension numbers in place of a seven-digit telephone number. To do this, enter the extension number and fill the remaining spaces with the “#” key in the phone number programming step. For example, if the PBX system uses four-digit extensions, and you want to program extension 2217 as a phone number in step 3 of section 3.5.2, press: **2 2 1 7 # # # *** (beep).

If the PBX system requires you to dial 9 to obtain an outside line, and you want to program some, but not all, outside line phone numbers in the system, program the number “9” as **one of the alternate area codes** in step 3 of section 3.5.3: press: **9 # # # *** (beep).

Then program the outside phone number as a long distance number (section 3.5.4) using the area code reference number that was used to program the number “9”.

5.4.4 Areas with 10-Digit Dialing

If the telephone entry system is installed in an area where the telephone company has instituted 10-digit dialing, simply program the required number of alternate area codes into the system without preceding the area code with the number 1. If **310** was one of the area codes required in step 3 of section 3.5.3 press: **3 1 0 # *** (beep).

Then program the outside phone number as a long distance number (section 3.5.4) using the area code reference number used to program **310**. Program additional area codes and phone numbers as described in sections 3.5.3 and 3.5.4.

5.4.5 Control Relays Directly from PC

If **Remote Account Manager** software is being used to program the 1834, then the PC can operate any of the relays directly. Refer to **Remote Account Manager** software to operate the desired relays. This is **ONLY** available on 1834 circuit boards “**Rev Y**” or higher. Older 1834 phone entry systems **cannot** directly operate relays from the PC.

SECTION 6 - MAINTENANCE

The DoorKing telephone entry system is essentially a maintenance free device. When the unit is properly installed, it should provide years of trouble free service. Maintenance is limited to updating the directory and phone number and/or entry codes when residents move in or out.

The faceplate of the unit should be cleaned on a regular basis to keep contaminants in the air from sticking to the surface and possibly causing pitting. When cleaning the faceplate of the system, never use an abrasive cleaner or cloth. Stainless steel cleaner works very well with a soft cloth for systems with a stainless steel faceplate. A clean damp soft cloth should be used to clean gold plated faceplates.

6.1 Troubleshooting

If problems should develop with your telephone entry system, refer to the trouble-shooting guide on the following pages to try and correct any problems. Our experience has shown that a majority of reported problems are actually programming related and can be corrected on site. If problems persist and they cannot be corrected, contact your authorized DoorKing dealer for assistance. Before performing any trouble-shooting, check the following:

1. Have a good VOM meter handy to check voltages and continuity.
2. Have a telephone test set (DoorKing P/N 1800-050 or equivalent) to check the telephone line. Noise on the phone line will cause problems with the entry system.
3. Be sure that the entry system case is properly grounded.
4. Be sure that the telephone wires are twisted.
5. A hum on the system indicates that the phone line or 16.5 VAC power lines may be grounded. Check to be sure that the phone lines or power lines are not shorted to ground.
6. Check the 16.5 VAC system power. Be sure that the transformer is properly rated (20 VA). Keep the wire run from the transformer to the entry system as short as possible. Use 16 or 18 AWG, 600 volt insulated wire only. The importance of proper power wiring cannot be over stressed!
7. Isolate the telephone entry system. Disconnect any external devices which may affect the operation of the system.

Symptom	Possible Solution(s)
Cannot get into programming mode.	<ul style="list-style-type: none"> • Wrong master code entered. Start over. • Waiting too long between pushing buttons. Enter information quicker. • Keypad is not plugged into board correctly. Cable points down. • Memory chips are installed upside down.
System emits a long tone and cancels programming.	<ul style="list-style-type: none"> • Waiting too long between pushing buttons. • Forgetting to press # first when programming.
Keypad is dead.	<ul style="list-style-type: none"> • No power. Check for 16.5 VAC input power. • Check that the keypad is properly connected to the circuit board. The cable on the plug points down when connected to the circuit board.
LCD is unreadable.	<ul style="list-style-type: none"> • Adjust contrast (4.2).

Symptom	Possible Solution(s)
Buzz or noise on the phone line.	<ul style="list-style-type: none"> • Disconnect the phone line from the system and check it with a handset. If line is noisy, problem is with the phone line and not the entry system. • Check for any shorts to ground behind the circuit board. • Check for pinched wires near the door hinge. • Check for 16-volt power shorted to ground. • Check for phone line shorted to ground. • Check that phone wires are twisted. • Check that the proper type of phone wire was used for an outdoor and / or underground application. • Check that all wires, speaker, keypad, etc. are isolated from ground. • Check that the cabinet is properly grounded. Be sure that case ground (terminal 3) is not used as a low voltage common. • Check for excessive voltage drop on 16 VAC power.
Ringing or howling from the speaker.	<ul style="list-style-type: none"> • Feedback improperly adjusted (4.1). • Volume is set too high (4.1).
After dial out, dial tone is heard on the speaker.	<ul style="list-style-type: none"> • Phone line is a rotary-dial line. Have the phone company change it to a touch-tone line.
Door strike locks on.	<ul style="list-style-type: none"> • Excessive voltage-drop on 16 VAC line. • Using a transformer with too low VA rating. • Relay strike time programmed too long (3.3.1).
Door strike or gate operator holds open.	<ul style="list-style-type: none"> • System was given a hold open command. Call the system and press the tone deactivate number (5.3.1).
Entry system will not answer when called.	<ul style="list-style-type: none"> • Ring pin is not installed (4.5). • Bad phone line or insufficient ring voltage.
Touch-tone 9 will not activate relay.	<ul style="list-style-type: none"> • Re-program tone-open number to 9 (3.3.3). • If resident phone emits a short pulse rather than a long tone, press 9 twice in rapid succession “99”. • Try another phone that is known to work. • Lower speaker volume (4.1) and re-adjust feedback (4.1).
Relay activates but gate operator will not open.	<ul style="list-style-type: none"> • Re-program relay strike time for a longer period (3.3.1). • Check wiring to gate operator. • Check gate operator.
Postal switch will not activate relay.	<ul style="list-style-type: none"> • Be sure that the wire-tie has been clipped off the postal switch. • Be sure that the relay has been programmed for postal switch input (3.3.4).
Four-digit entry codes will not work.	<ul style="list-style-type: none"> • Forgetting to press “#” first. • Re-program the entry code ranges (3.7.3).
Entry codes will not activate relay 1.	<ul style="list-style-type: none"> • Re-program relay 1 low and high ranges (3.7.3).
Entry codes will not activate relay 2.	<ul style="list-style-type: none"> • Re-program relay 2 low and high ranges (3.7.3).
System emits a beep every 30 seconds.	<ul style="list-style-type: none"> • Master code switch is in the ON position (4.4).
DTMF tones are heard 15 seconds after call is answered.	<ul style="list-style-type: none"> • The system CALL-UP feature is turned on. Re-program this feature to turn it off (3.2.3).

6.1.1 RS-232 Test

This test procedure will check the RS-232 hardware to determine a **PASS** or **FAIL** mode. You will need two short pieces of wire to perform this test (jumpers). Connect the jumper wires as shown to the RS-232 terminal.

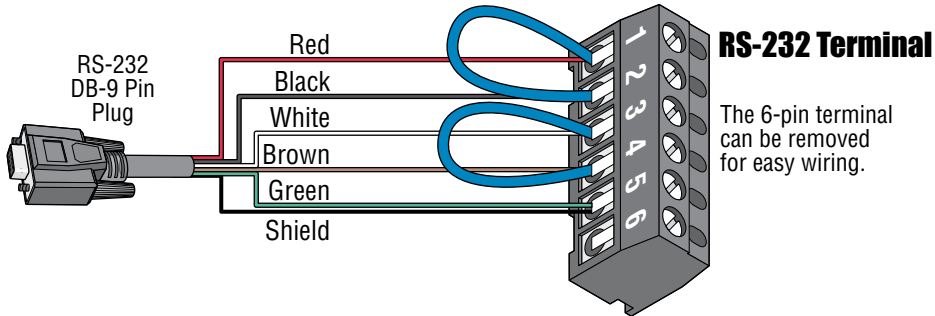

1. Press and enter your four-digit MASTER CODE (**beep**).
2. Press (**beep**).

PASS - The LCD display will indicate: **RS232 HARDWARE PASS**. One long tone will be heard: (**Beeeeeeep**).

FAIL - The LCD display will indicate **RS232 HARDWARE FAIL**. Two short tones and a long tone will be heard: (**Beep - Beep - Beeeeeeep**).

3. Remove the jumper wires from the terminal after performing this test.

6.1.2 Automatic Hang-up Options

This sequence will allow you to program different methods by which the telephone entry system will hang-up if a resident denies a guest access by hanging up their telephone rather than pressing the “#” key to terminate the call.

Factory setting is 1, dial tone detect ON.

1. Press and enter your four-digit MASTER CODE (**beep**).

The LCD display will show: **0=N 1=DT 2=SIL 3=BTH**.

0 – BOTH OFF. Unit hangs up after programmed strike time runs out.

1 – DIAL TONE detect ON. Unit hangs up after detecting 5-seconds of dial tone.

2 – SILENCE detect ON. Unit hands up after detecting 15-seconds of silence.

3 – BOTH ON.

2. Enter the **hang-up option code** _ (0, 1, 2 or 3), then press (**beep**).

3. Press TOGETHER to end this programming sequence (**beeeeeep**).

6.1.3 - 6.1.5 Not Applicable to 1834

6.1.6 Modem Output Level Adjustment

This programming step should only be used if you are experiencing modem trouble. It allows you to adjust the output level of the modem tones. A higher modem level number increases the tone volume while a lower number decreases tone volume.
1-Min, 8-Max.

Factory setting is 4.

1. Press and enter your four-digit MASTER CODE (**beep**).

2. Enter the single-digit modem level number (1-8), then press (**beep**).

3. Press TOGETHER to end this programming sequence (**beeeeeep**).

6.1.7 Display DKS Data over IP Phone Number or System ID Number

This will allow you to see the **DKS Data over IP** issued 10-digit phone number or system ID number that has been programmed into the telephone entry system.

1. Press    and enter your four-digit MASTER CODE     (beep).

The LCD display will show the 10-digit phone number or system ID number.

Note: The display will show C's (C C C C C C C C C C) if a phone number or ID has **NOT** been programmed.

6.1.8 Test Connection to DKS Data over IP

This will allow you to test the connection to **DKS Data over IP** or display problems that may have occurred.

1. Press    and enter your four-digit MASTER CODE     (beep).

The LCD display will show one of the following and the entry system will BEEP accordingly:

System is Registered - (beep) one beep

- System is registered and communication to **DKS Data over IP** is good.

Check Registration - (beep-beep) two beeps

- Make sure your registration is current and this system is set to **DKS Data over IP** on the registration screen. Also, be sure that the system phone number or ID number and the master code are set the same on **DKS Data over IP** and the entry system.

Program 10 Digit ID - (beep-beep-beep) three beeps

- There is not a valid 10-digit ID in the system memory. (see section 3.2.10)

Turn DKS Data over IP On - (beep-beep-beep-beep) four beeps

- There is a valid 10-digit ID, but **DKS Data over IP** is turned OFF. (see section 6.1.9)

No DKS Data over IP Contact - (beep-beep-beep-beep-beep) five beeps

- Communication to **DKS Data over IP** could not be made.

Note: If there is pending data to be transferred when this test is performed, the data transfer will occur.













6.1.9 Turn DKS Data over IP OFF or ON

Use the following sequence to turn **DKS Data over IP OFF** or **ON**.

If you are going to use the RS232 connection for any other RS232 functions other than **DKS Data over IP** (e.g., connecting a PC directly to the phone entry system via the RS232 terminal), the **DKS Data over IP** must be turned **OFF**.

The **DKS Data over IP** must be **ON** to use the entry system with **DKS Data over IP**. **Note:** When section 3.2.10 (DKS Data over IP Phone Number or System ID Number) is programmed, the **DKS Data over IP** is **automatically** turned **ON**.

If there is **NOT** a valid 10 digit system phone number or system ID number in memory, the system will emit three (3) short beeps. **Beep ... Beep ... Beep**

1. Press    and enter your four-digit MASTER CODE     (beep).
2. Press   (beep) to turn **OFF**, OR   (beep) to turn **ON**.
3. Press   together to end this programming sequence (**beeeeeep**).

Note: You can test the telephone entry system connection to **DKS Data over IP** and analyze problems that may occur using section 6.1.8.

6.2 Accessories

Surface Mount Recess Kit

Use to recess a surface mount unit into a wall or column. P/N 1803-150.

Flush Mount Kit

Use to install flush style units into a wall or column. Kit includes rough-in back box and trim-ring. P/N 1814-165 comes with stainless steel trim ring. P/N 1814-166 comes with gold plated trim ring.

Flush Mount Surface Mounting Kit

Use to surface mount a flush style unit. P/N 1814-152.

Stainless Steel Case

Replaces the black steel surface mount case with a stainless steel case. P/N 1810-102.

Surge Suppressors

Phone line suppressor. P/N 1878-010.

Low voltage (28 V) suppressor. P/N 1878-010.

High voltage (115 V) suppressor. P/N 1879-080.

Mounting Posts

Heavy-duty goose-neck mounting post with mounting plate. P/N 1200-038.

Heavy-duty goose-neck mounting post with concrete base plate for pad mounting. P/N 1200-037.

Designer Style mounting posts; offset P/N 1200-086, straight P/N 1200-085.

Self-standing Kiosk, for flush mount units only; P/N 1200-170.

RS-232 Cable

RS-232 cable with DB-9 connector on one end and wires on the other end. Use this cable to program the entry system from a PC using RS-232 communications instead of the modem. P/N 1818-040.

Telephone Test Set

Includes clips, cord and carrying case. P/N 1800-050.

Battery

12 volt .8 amp hour gel cell provides stand by power during power interruptions. P/N 1801-008.

1834 Communication Connection Options

TCP/IP Converter Kit - Third Party Connection

Enables the 1830 series system to send and receive data via the Internet or a LAN. P/N 1830-185.

TCP/IP Converter Kit - DoorKing DKS Data over IP Connection

Enables the 1830 series system to send and receive data via DKS Data over IP. P/N 1830-186.

DKS VoIP Adapter Kit

Enables the 1830 series system to send and receive voice via DKS VoIP over IP. P/N 1815-568

RS-422 Adapter Kit

Enables the 1830 series system to send and receive data to a PC. P/N 1840-055.

DKS Cellular Kit - DKS Cellular Server Connection

Enables the 1830 series system to send and receive data to a PC via DKS Cellular network.

Voice/Data P/N 1800-080

1834 Wiring Schematic: Surface - Flush - Wall

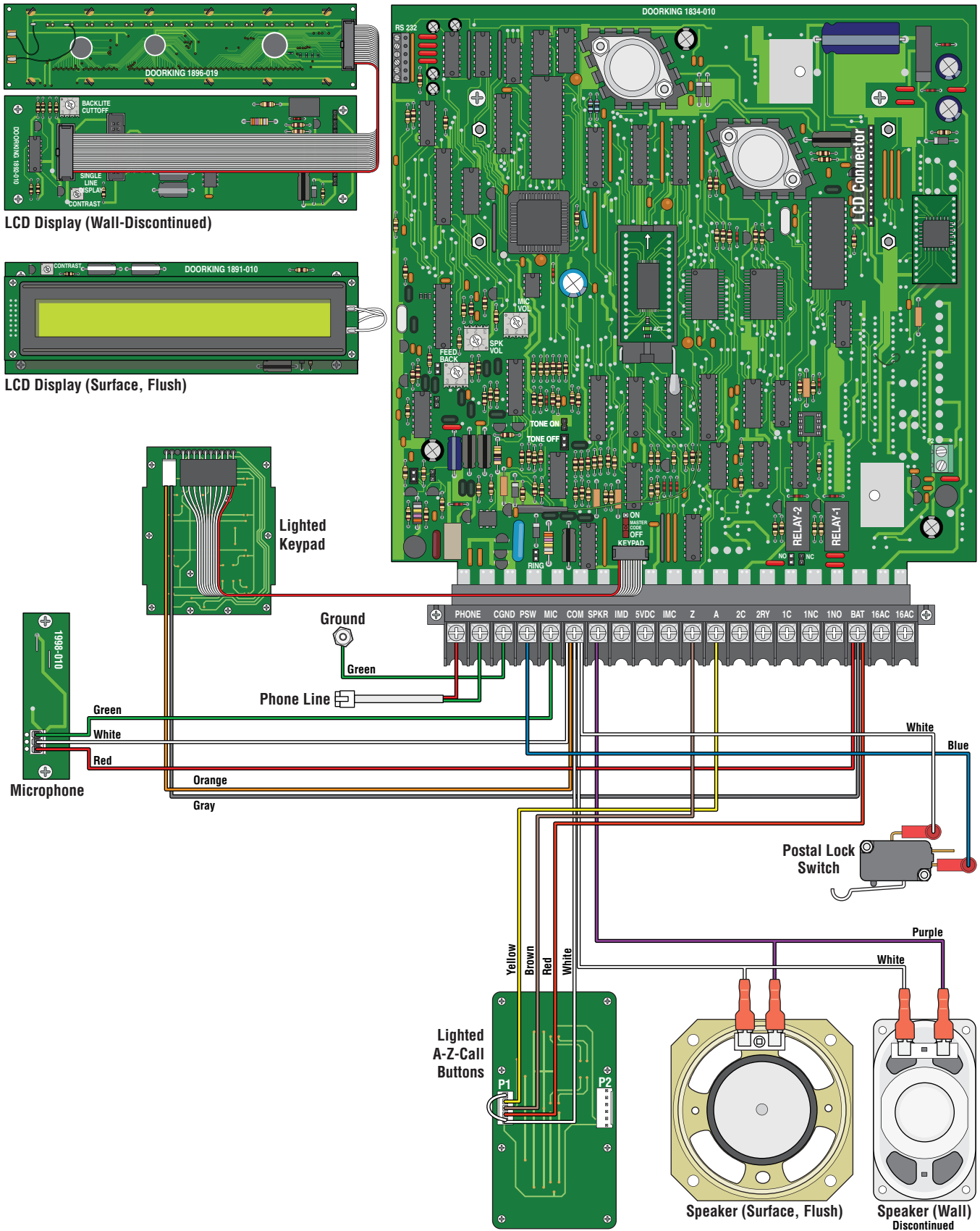

SECTION 7 - LOG TABLES

Complete the information in the tables on the following pages to maintain a record of the information that has been programmed into the telephone entry system if the system **IS NOT being programmed from a PC**. If PC programming is being utilized, there is **no reason** to maintain these log sheets since the PC will maintain a complete record of the information that has been programmed.

Make copies of the resident log sheet (pages 59-60) so that you have enough to complete a listing of all residents and data. Enter the information as shown in the example below.

AAC stands for Alternate Area Code. Enter the alternate area code number if alternate area codes have been programmed and assigned to this resident (section 3.5.3).

DIRECTORY CODE is the resident's unique directory code. It can be 1 to 4 digits (section 3.5.1).

ENTRY CODE is the resident's four-digit entry code (section 3.7.1) if they are used.

DEVICE CODE is not applicable to the 1834.

Resident Log Sheet Example

Name	AAC	PHONE NUMBER	DIRECTORY CODE	ENTRY CODE	DEVICE CODE
Smith, John	3	765-0000	173	3812	N/A

7.1 Programming Information Tables

Master Code (section 3.2.1)			
1st Digit	2nd Digit	3rd Digit	4th Digit

Relay Strike Time (section 3.3.1)	
Relay 1	Relay 2

Tone Open Numbers (section 3.3.3)	Relay 1	Relay 2
Momentary Activation		
Relay Hold OPEN		
Relay RELEASE		
Relay Hold OPEN 1 Hour		

Entry Code Ranges (section 3.7.3)	Relay 1	Relay 2
Low Boundary		
High Boundary		

Postal Lock Activates (section 3.3.4)	
Relay 1	Relay 2

Rotary "9" Activates (section 3.3.6)	
Relay 1	Relay 2

7.1.1 10 Area Codes

Area Code Pointers - System Set to 10 Area Codes (section 3.5.3)									
Pointer	Area Code	Pointer	Area Code	Pointer	Area Code	Pointer	Area Code	Pointer	Area Code
1		3		5		7		9	
2		4		6		8		0	

7.1.2 255 Area Codes - Page 1

Area Code Pointers - System Set to 255 Area Codes (section 3.5.3)									
Pointer	Area Code	Pointer	Area Code	Pointer	Area Code	Pointer	Area Code	Pointer	Area Code
001		027		053		079		105	
002		028		054		080		106	
003		029		055		081		107	
004		030		056		082		108	
005		031		057		083		109	
006		032		058		084		110	
007		033		059		085		111	
008		034		060		086		112	
009		035		061		087		113	
010		036		062		088		114	
011		037		063		089		115	
012		038		064		090		116	
013		039		065		091		117	
014		040		066		092		118	
015		041		067		093		119	
016		042		068		094		120	
017		043		069		095		121	
018		044		070		096		122	
019		045		071		097		123	
020		046		072		098		124	
021		047		073		099		125	
022		048		074		100		126	
023		049		075		101		127	
024		050		076		102		128	
025		051		077		103		129	
026		052		078		104		130	

7.1.2 255 Area Codes - Page 2

Area Code Pointers - System Set to 255 Area Codes (section 3.5.3)									
Pointer	Area Code	Pointer	Area Code	Pointer	Area Code	Pointer	Area Code	Pointer	Area Code
131		157		183		209		235	
132		158		184		210		236	
133		159		185		211		237	
134		160		186		212		238	
135		161		187		213		239	
136		162		188		214		240	
137		163		189		215		241	
138		164		190		216		242	
139		165		191		217		243	
140		166		192		218		244	
141		167		193		219		245	
142		168		194		220		246	
143		169		195		221		247	
144		170		196		222		248	
145		171		197		223		249	
146		172		198		224		250	
147		173		199		225		251	
148		174		200		226		252	
149		175		201		227		253	
150		176		202		228		254	
151		177		203		229		255	
152		178		204		230		000	
153		179		205		231			
154		180		206		232			
155		181		207		233			
156		182		208		234			

RESIDENT INSTRUCTIONS



Your building / community has been equipped with a **DoorKing Telephone Entry System** that will provide communication for your guest from the lobby door / gated entrance to your home. If you have any questions regarding the use or operation of this system, please see your **System Administrator** (building manager / HOA representative) **or Call:**

Phone #

Guest Communication: Your name (or apartment number) and telephone number have been programmed into the DoorKing telephone entry system under a specific **DIRECTORY CODE**. This directory code can be from 1 to 4 digits long. When a guest comes to visit you, they will look up your name in a resident directory (located on the LCD display or on a separate printed directory to provide guests with the resident directory information). Your **DIRECTORY CODE** will be shown next to your name. Your guest will enter this code on the telephone entry system keypad that will place a call to your home (If your guest already knows **YOUR** specific directory code, they can simply enter the code on the keypad without having to look up your name in the resident directory). Some telephone entry systems are equipped with a **“CALL”** button. When your name is displayed on the LCD screen in the resident directory, the guest can press the CALL button to place a call to your home. A guest **CANNOT** enter your telephone number on the keypad, it **MUST** be the **DIRECTORY CODE ONLY!**

Granting or Denying Access to your Guest: Once you have answered the phone call and you have identified your guest, you have the choice to either **grant access** or **deny access** to your guest.

Touch-Tone Phones ONLY.

To **GRANT ACCESS** to your guest, press _____ on your touch-tone telephone. The telephone entry system will respond with a confirmation tone indicating that the door or gate is opening and will automatically disconnect itself. Some newer telephones emit a very short duration tone when the number is pressed. If your telephone does this, you may have to press the **“GRANT ACCESS NUMBER”** twice in rapid succession to open the door or gate.

To **DENY ACCESS** to your guest, press the **“#”** key on your touch-tone telephone.

Rotary-Dial Phones ONLY.

To **GRANT ACCESS** to your guest, dial **“9”**.

To **DENY ACCESS** to your guest, **hang-up** your phone.

Call Waiting: If you are on your telephone when a guest tries to contact you from the telephone entry system, they will hear a busy signal and will have to wait for you to end your call before they can contact you. **To eliminate this problem**, you can order call waiting from your local telephone company.

Privacy: If you **DO NOT** want your name and/or apartment number listed in the electronic resident directory, inform the system administrator of this. Your telephone number can be stored in the system **without your name being displayed on the directory**. If you choose this option, you will need to inform your guest what **YOUR directory code** is, otherwise there will be **NO WAY** for them to identify **YOUR** directory code on the telephone entry system’s electronic resident directory.

4-Digit Entry Code: You may be issued an **“entry code”** that will allow you to open the **MAIN** door / gate by entering this code on a remote call station’s keypad near the main entrance **ONLY**. Your system administrator will advise you of **YOUR** 4-digit entry code if this option is available.

Entry Code

To use your access code, **first** press the  key on the remote keypad near the main entrance, then enter your **4-digit code**.

System Administrator’s Note: Fill in phone number, access granted number and entry code number, copy and distribute this to residents.



Download **REMOTE ACCOUNT MANAGER** Software **FREE** at:
<http://www.doorking.com/telephone/software>

www.doorking.com

DoorKing, Inc.
120 S. Glasgow Avenue
Inglewood, California 90301
U.S.A.

Phone: 310-645-0023
Fax: 310-641-1586